

OPAx377-Q1 低ノイズ、低静止電流、高精度の車載用グレード・オペアンプ

1 特長

- 車載アプリケーションに対応
- 下記内容でAEC-Q100認定済み
 - デバイス温度グレード1: 動作時周囲温度範囲 $-40^{\circ}\text{C} \sim +125^{\circ}\text{C}$
 - デバイスHBM ESD分類レベル3A
 - デバイスCDM ESD分類レベルC6
- 低ノイズ: $7.5\text{nV}/\sqrt{\text{Hz}}$ 、1kHz時
- 0.1Hz~10Hzのノイズ: $0.8\mu\text{V}_{\text{PP}}$
- 静止電流: $760\mu\text{A}$ (標準値)
- 低いオフセット電圧: $250\mu\text{V}$ (標準値)
- ゲイン帯域幅積: 5.5MHz
- レール・ツー・レールの入出力
- 単一電源動作
- 電源電圧: $2.2\text{V} \sim 5.5\text{V}$
- 容積を削減できるパッケージ
 - SOT-23、VSSOP、TSSOP

2 アプリケーション

- アクティブ・クルーズ・コントロール
- パーク・アシスト
- タイヤ圧力の監視
- インフォテインメント
- アクティブ・フィルタリング
- センサ・シグナル・コンディショニング

3 概要

OPAx377-Q1ファミリのオペアンプは広い帯域幅をもつCMOSアンプです。0.76mA (標準値)の低静止電流で動作して、超低ノイズ、低入力バイアス電流、低オフセット電圧を実現します。

OPAx377-Q1オペアンプは低電圧の単一電源アプリケーション用に最適化されています。非常に優れたAC/DC性能のため、小信号のコンディショニング、オーディオ、アクティブ・フィルタなどの広範なアプリケーションにとって理想的なオペアンプとなっています。OPAx377-Q1オペアンプは電源範囲が広く、PSRRが非常に優れているため、バッテリーから直接レギュレーションなしで動作するアプリケーションにとっても魅力的です。

OPA377-Q1はSOT23-5パッケージで提供されます。デュアル・バージョンのOPA2377-Q1はMSOP-8パッケージ、クワッド・バージョンのOPA4377-Q1はTSSOP-14パッケージで提供されます。どのバージョンも、 $-40^{\circ}\text{C} \sim +125^{\circ}\text{C}$ の動作が保証されています。

製品情報⁽¹⁾

型番	パッケージ	本体サイズ(公称)
OPA377-Q1	SOT-23 (5)	2.90mmx1.60mm
OPA2377-Q1	VSSOP (8)	3.00mmx3.00mm
OPA4377-Q1	TSSOP (14)	5.00mmx4.40mm

(1) 提供されているすべてのパッケージについては、データシートの末尾にある注文情報を参照してください。

ローサイドの電流感知アンプ

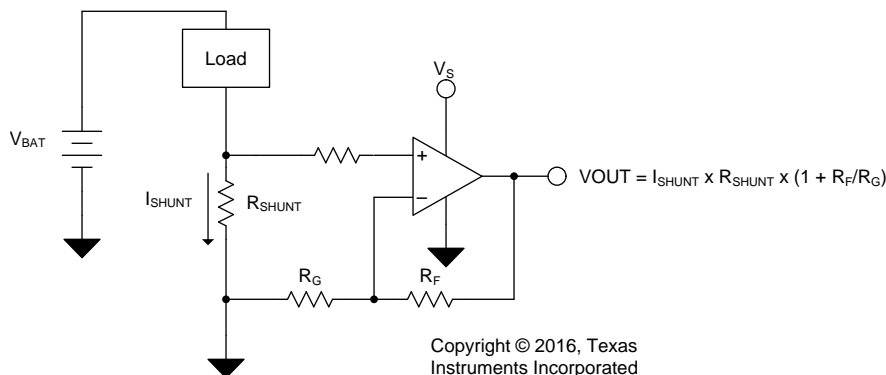

目次

1	特長	1	7.3	Feature Description	14
2	アプリケーション	1	7.4	Device Functional Modes	15
3	概要	1	8	Application and Implementation	16
4	改訂履歴	2	8.1	Application Information	16
5	Pin Configuration and Functions	3	8.2	Typical Application	16
6	Specifications	6	9	Power Supply Recommendations	18
6.1	Absolute Maximum Ratings	6	10	Layout	18
6.2	ESD Ratings	6	10.1	Layout Guidelines	18
6.3	Recommended Operating Conditions	6	10.2	Layout Example	18
6.4	Thermal Information: OPA377-Q1	6	11	デバイスおよびドキュメントのサポート	20
6.5	Thermal Information: OPA2377-Q1	6	11.1	デバイス・サポート	20
6.6	Thermal Information: OPA4377-Q1	6	11.2	ドキュメントのサポート	21
6.7	Electrical Characteristics: $V_S = 2.2\text{ V to }5.5\text{ V}$	7	11.3	コミュニティ・リソース	21
6.8	Typical Characteristics	9	11.4	商標	21
7	Detailed Description	13	11.5	静電気放電に関する注意事項	21
7.1	Overview	13	11.6	用語集	21
7.2	Functional Block Diagram	13	12	メカニカル、パッケージ、および注文情報	21

4 改訂履歴

2016年5月発行のものから更新

Page

•	製品のステータスを製品プレビューから量産データへ変更	1
---	----------------------------------	---

5 Pin Configuration and Functions

**OPA377-Q1: DBV Package
5-Pin SOT23
Top View**

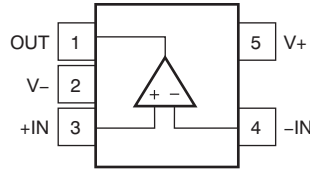

Pin Functions: OPA377-Q1

PIN		I/O	DESCRIPTION
NAME	NO. DBV		
+IN	3	I	Noninverting input
-IN	4	I	Inverting input
NC	—	—	No internal connection (can be left floating)
OUT	1	O	Output
V-	2	—	Negative (lowest) power supply
V+	5	—	Positive (highest) power supply

**OPA2377-Q1: DGK Package
8-Pin VSSOP and SOIC
Top View**

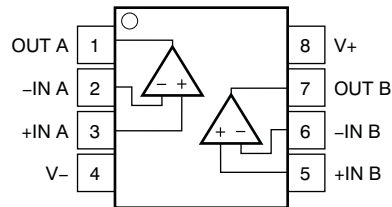

Pin Functions: OPA2377-Q1

PIN		I/O	DESCRIPTION
NAME	NO. DGK		
-IN A	2	I	Inverting input, channel A
-IN B	6	I	Inverting input, channel B
+IN A	3	I	Noninverting input, channel A
+IN B	5	I	Noninverting input, channel B
OUT A	1	O	Output, channel A
OUT B	7	O	Output, channel B
V-	4	—	Negative (lowest) power supply
V+	8	—	Positive (highest) power supply

**OPA4377-Q1: PW Package
14-Pin TSSOP
Top View**

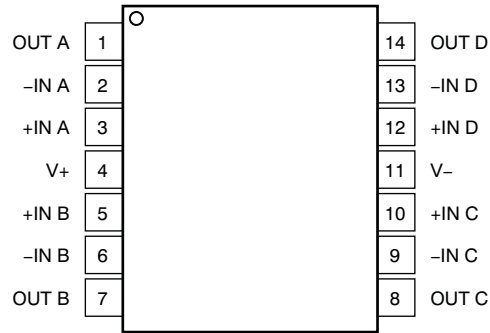

Pin Functions: OPA4377-Q1

PIN		I/O	DESCRIPTION
NAME	NO. PW		
-IN A	2	I	Inverting input, channel A
-IN B	6	I	Inverting input, channel B
-IN C	9	I	Inverting input, channel C
-IN D	13	I	Inverting input, channel D
+IN A	3	I	Noninverting input, channel A
+IN B	5	I	Noninverting input, channel B
+IN C	10	I	Noninverting input, channel C
+IN D	12	I	Noninverting input, channel D
OUT A	1	O	Output, channel A
OUT B	7	O	Output, channel B
OUT C	8	O	Output, channel C
OUT D	14	O	Output, channel D
V-	11	—	Negative (lowest) power supply
V+	4	—	Positive (highest) power supply

6 Specifications

6.1 Absolute Maximum Ratings

 over operating free-air temperature range (unless otherwise noted)⁽¹⁾

		MIN	MAX	UNIT
$V_S = (V+) - (V-)$	Supply voltage		7	V
	Signal input terminal voltage ⁽²⁾	(V-) – 0.5	(V+) + 0.5	V
	Signal input terminal current ⁽²⁾	–10	10	mA
	Output short-circuit current ⁽³⁾	Continuous		
T_A	Operating temperature	–40	150	°C
T_J	Junction temperature		150	°C
T_{stg}	Storage temperature	–65	150	°C

- Stresses beyond those listed under *Absolute Maximum Ratings* may cause permanent damage to the device. These are stress ratings only, which do not imply functional operation of the device at these or any other conditions beyond those indicated under *Recommended Operating Conditions*. Exposure to absolute-maximum-rated conditions for extended periods may affect device reliability.
- Input terminals are diode-clamped to the power-supply rails. Input signals that can swing more than 0.5 V beyond the supply rails should be current limited to 10 mA or less.
- Short-circuit to ground, one amplifier per package.

6.2 ESD Ratings

			VALUE	UNIT
$V_{(ESD)}$	Electrostatic discharge	Human-body model (HBM), per AEC Q100-002 ⁽¹⁾	±4000	V
		Charged-device model (CDM), per AEC Q100-011	±1000	

- AEC Q100-002 indicates that HBM stressing shall be in accordance with the ANSI/ESDA/JEDEC JS-001 specification.

6.3 Recommended Operating Conditions

over operating free-air temperature range (unless otherwise noted)

		MIN	MAX	UNIT
	Supply voltage	2.2	5.5	V
T_A	Operating temperature	–40	150	°C

6.4 Thermal Information: OPA377-Q1

THERMAL METRIC ⁽¹⁾		OPA377-Q1	UNIT
		DBV (SOT23)	
		5 PINS	
$R_{\theta JA}$	Junction-to-ambient thermal resistance	273.8	°C/W
$R_{\theta JC(top)}$	Junction-to-case (top) thermal resistance	126.8	°C/W
$R_{\theta JB}$	Junction-to-board thermal resistance	85.9	°C/W
Ψ_{JT}	Junction-to-top characterization parameter	10.9	°C/W
Ψ_{JB}	Junction-to-board characterization parameter	84.9	°C/W
$R_{\theta JC(bot)}$	Junction-to-case (bottom) thermal resistance	n/a	°C/W

- For more information about traditional and new thermal metrics, see the *Semiconductor and IC Package Thermal Metrics* application report, [SPRA953](#).

6.5 Thermal Information: OPA2377-Q1

THERMAL METRIC ⁽¹⁾		OPA2377-Q1	UNIT
		DGK (VSSOP)	
		8 PINS	
$R_{\theta JA}$	Junction-to-ambient thermal resistance	171.2	°C/W
$R_{\theta JC(top)}$	Junction-to-case (top) thermal resistance	63.9	°C/W

- For more information about traditional and new thermal metrics, see the *Semiconductor and IC Package Thermal Metrics* application report, [SPRA953](#).

Thermal Information: OPA2377-Q1 (continued)

THERMAL METRIC ⁽¹⁾		OPA2377-Q1	UNIT
		DGK (VSSOP)	
		8 PINS	
R _{θJB}	Junction-to-board thermal resistance	92.8	°C/W
ψ _{JT}	Junction-to-top characterization parameter	9.2	°C/W
ψ _{JB}	Junction-to-board characterization parameter	91.2	°C/W
R _{θJC(bot)}	Junction-to-case (bottom) thermal resistance	n/a	°C/W

6.6 Thermal Information: OPA4377-Q1

THERMAL METRIC ⁽¹⁾		OPA4377-Q1	UNIT
		PW (TSSOP)	
		14 PINS	
R _{θJA}	Junction-to-ambient thermal resistance	107.8	°C/W
R _{θJC(top)}	Junction-to-case (top) thermal resistance	29.6	°C/W
R _{θJB}	Junction-to-board thermal resistance	52.6	°C/W
ψ _{JT}	Junction-to-top characterization parameter	1.5	°C/W
ψ _{JB}	Junction-to-board characterization parameter	51.6	°C/W
R _{θJC(bot)}	Junction-to-case (bottom) thermal resistance	n/a	°C/W

(1) For more information about traditional and new thermal metrics, see the *Semiconductor and IC Package Thermal Metrics* application report, [SPRA953](#).

6.7 Electrical Characteristics: V_S = 2.2 V to 5.5 V

At T_A = 25°C, R_L = 10 kΩ connected to V_S/2, V_{CM} = V_S/2, and V_{OUT} = V_S/2, unless otherwise noted.

PARAMETER	TEST CONDITIONS	MIN	TYP	MAX	UNIT
OFFSET VOLTAGE					
V _{OS}	Input offset voltage	V _S = 5 V	0.25	1	mV
	Input offset voltage versus temperature	At T _A = -40°C to +125°C, V _S = 2.2 V to 5.5 V, V _{CM} < (V+) - 1.3 V	5		μV/V
dV _{OS} /dT	Input offset voltage versus drift	At T _A = -40°C to +125°C	0.32	2	μV/°C
PSRR	Input offset voltage versus power supply	At T _A = 25°C, V _S = 2.2 V to 5.5 V, V _{CM} < (V+) - 1.3 V	5	28	μV/V
	Channel separation, dc (dual, quad)		0.5		μV/V
INPUT BIAS CURRENT					
I _{IB}	Input bias current		±0.2	±10	pA
	Input bias current versus temperature		See Typical Characteristics		pA
I _{OS}	Input offset current		±0.2	±10	pA
NOISE					
	Input voltage noise	f = 0.1 Hz to 10 Hz	0.8		μV _{PP}
e _n	Input voltage noise density	f = 1 kHz	7.5		nV/√Hz
i _n	Input current noise density	f = 1 kHz	2		fA/√Hz
INPUT VOLTAGE RANGE					
V _{CM}	Common-mode voltage range		(V-) - 0.1	(V+) + 0.1	V
CMRR	Common-mode rejection ratio	(V-) < V _{CM} < (V+) - 1.3 V	70	90	dB
INPUT CAPACITANCE					
	Differential		6.5		pF
	Common-mode		13		pF
OPEN-LOOP GAIN					
A _{OL}	Open-loop voltage gain	50 mV < V _O < (V+) - 50 mV, R _L = 10 kΩ	112	134	dB
		100 mV < V _O < (V+) - 100 mV, R _L = 2 kΩ		126	dB
FREQUENCY RESPONSE, V_S = 5.5 V					

Electrical Characteristics: $V_S = 2.2\text{ V to }5.5\text{ V}$ (continued)

 At $T_A = 25^\circ\text{C}$, $R_L = 10\text{ k}\Omega$ connected to $V_{S/2}$, $V_{CM} = V_{S/2}$, and $V_{OUT} = V_{S/2}$, unless otherwise noted.

PARAMETER		TEST CONDITIONS	MIN	TYP	MAX	UNIT
GBW	Gain-bandwidth product			5.5		MHz
SR	Slew rate	$G = +1$		2		V/ μs
t_s	Settling time	At 0.1%, 2-V step, $G = +1$		1.6		μs
		At 0.01%, 2-V step, $G = +1$		2		μs
	Overload recovery time	$V_{IN} \times \text{Gain} > V_S$		0.33		μs
THD+N	Total harmonic distortion + noise	$V_O = 1\text{ V}_{RMS}$, $G = +1$, $f = 1\text{ kHz}$, $R_L = 10\text{ k}\Omega$		0.00027%		
OUTPUT						
	Voltage output swing from rail	At $T_A = 25^\circ\text{C}$, $R_L = 10\text{ k}\Omega$		10	20	mV
		At $T_A = -40^\circ\text{C}$ to $+125^\circ\text{C}$, $R_L = 10\text{ k}\Omega$			40	mV
I_{SC}	Short-circuit current			+30/-50		mA
C_{LOAD}	Capacitive load drive			See Typical Characteristics		
R_O	Open-loop output impedance			150		Ω
POWER SUPPLY						
V_S	Specified voltage		2.2		5.5	V
I_Q	Quiescent current (per amplifier)	At $T_A = 25^\circ\text{C}$, $I_O = 0$, $V_S = 5.5\text{ V}$		0.76	1.05	mA
		At $T_A = -40^\circ\text{C}$ to $+125^\circ\text{C}$			1.2	mA
TEMPERATURE						
	Specified temperature		-40		+125	$^\circ\text{C}$

6.8 Typical Characteristics

At $T_A = 25^\circ\text{C}$, $V_S = 5\text{ V}$, $R_L = 10\text{ k}\Omega$ connected to $V_S/2$, $V_{CM} = V_S/2$, and $V_{OUT} = V_S/2$, unless otherwise noted.

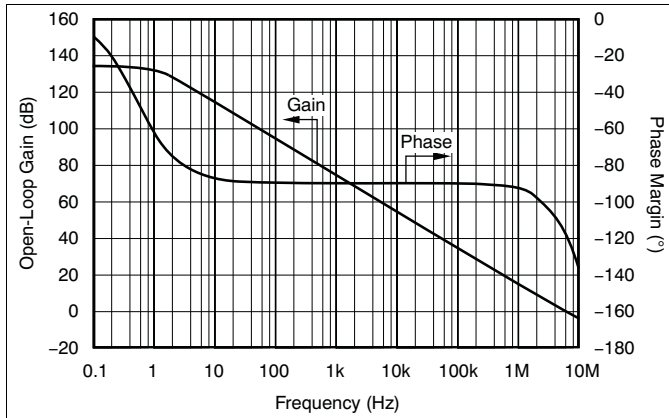

Figure 1. Open-Loop Gain and Phase vs Frequency

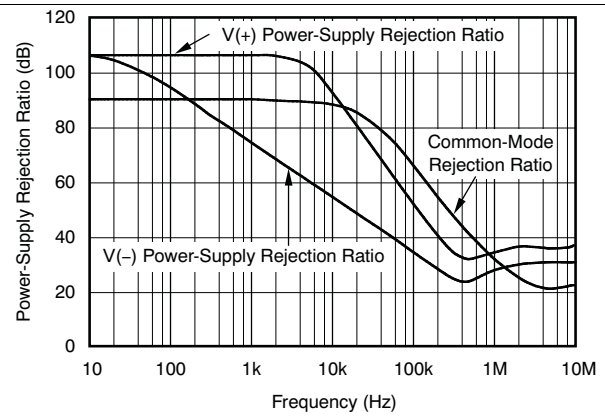

Figure 2. Power-Supply and Common-Mode Rejection Ratio vs Frequency

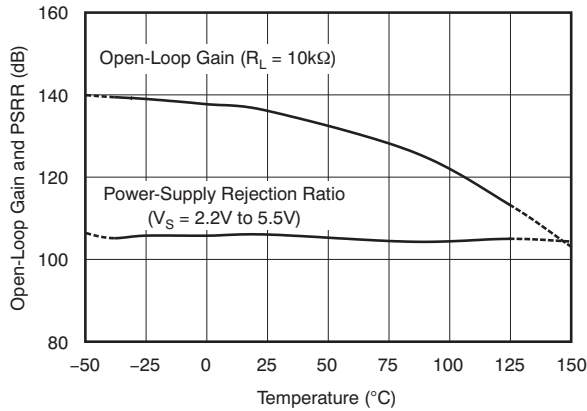

Figure 3. Open-Loop Gain and Power-Supply Rejection Ratio vs Temperature

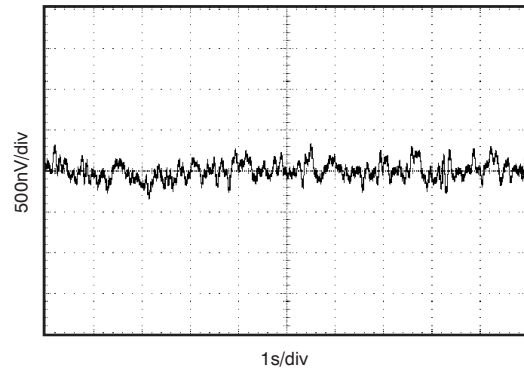

Figure 4. 0.1-Hz to 10-Hz Input Voltage Noise

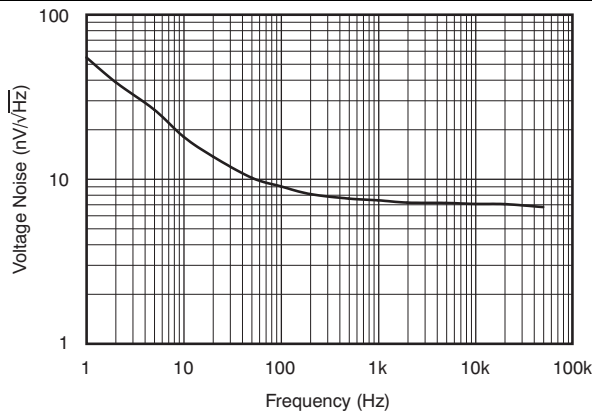

Figure 5. Input Voltage Noise Spectral Density

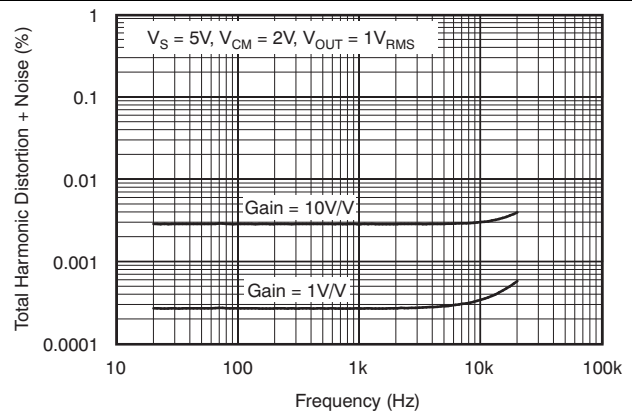

Figure 6. Total Harmonic Distortion and Noise vs Frequency

Typical Characteristics (continued)

At $T_A = 25^\circ\text{C}$, $V_S = 5\text{ V}$, $R_L = 10\text{ k}\Omega$ connected to $V_S/2$, $V_{CM} = V_S/2$, and $V_{OUT} = V_S/2$, unless otherwise noted.

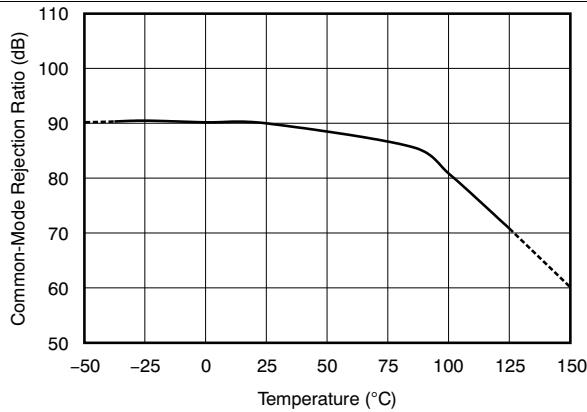

Figure 7. Common-Mode Rejection Ratio vs Temperature

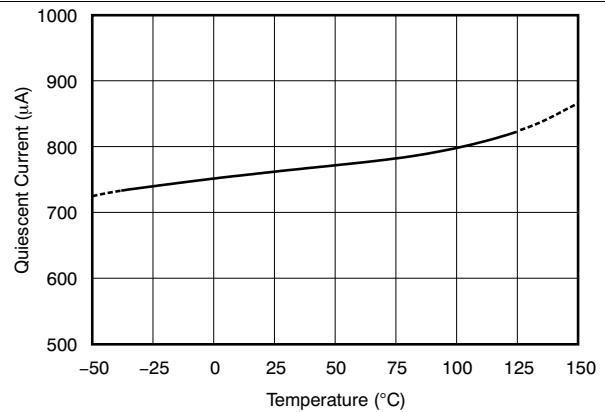

Figure 8. Quiescent Current vs Temperature

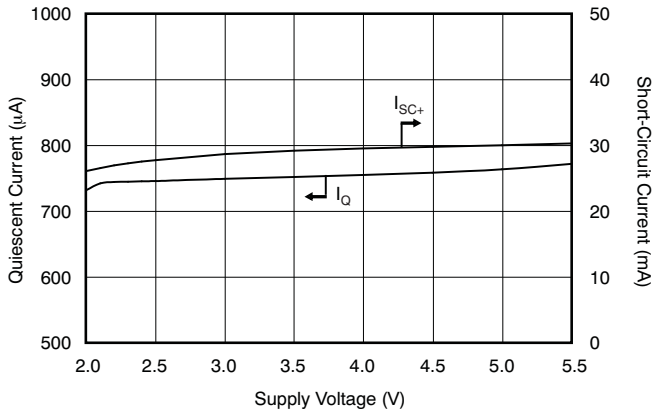

Figure 9. Quiescent and Short-Circuit Current vs Supply Voltage

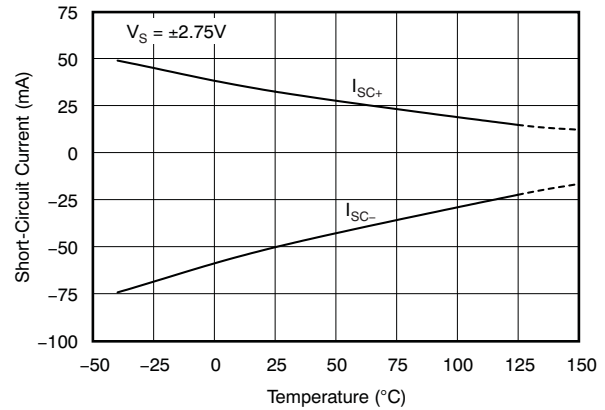

Figure 10. Short-Circuit Current vs Temperature

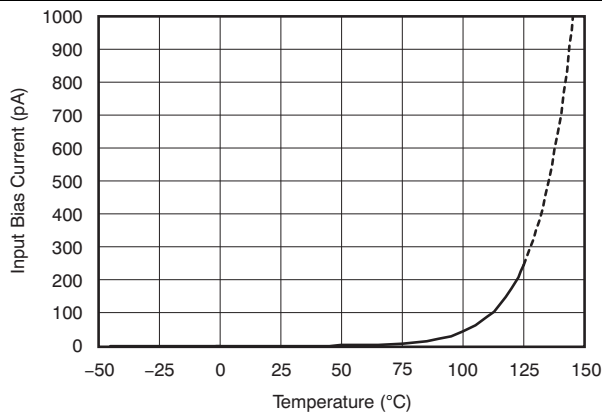

Figure 11. Input Bias Current vs Temperature

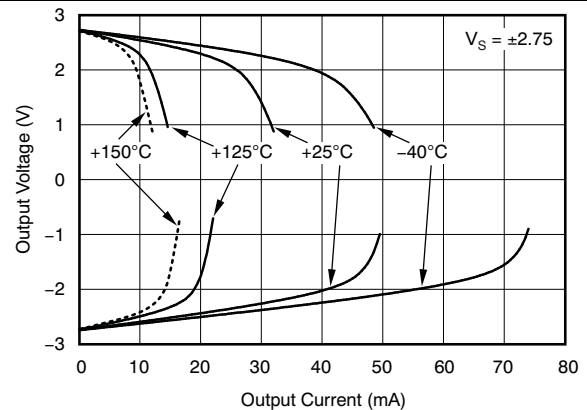

Figure 12. Output Voltage vs Output Current

Typical Characteristics (continued)

At $T_A = 25^\circ\text{C}$, $V_S = 5\text{ V}$, $R_L = 10\text{ k}\Omega$ connected to $V_S/2$, $V_{CM} = V_S/2$, and $V_{OUT} = V_S/2$, unless otherwise noted.

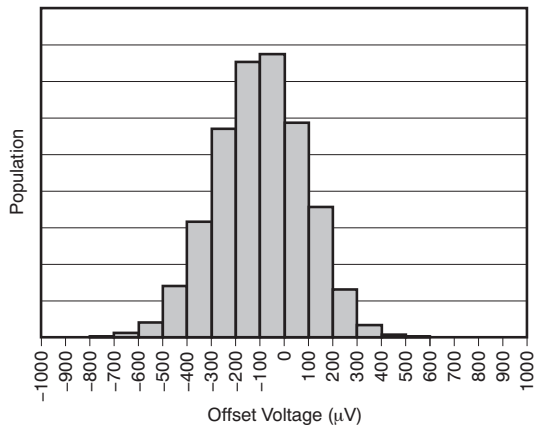

Figure 13. Offset Voltage Production Distribution

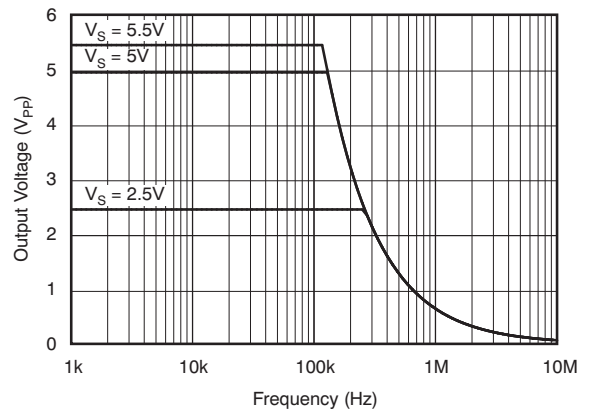

Figure 14. Maximum Output Voltage vs Frequency

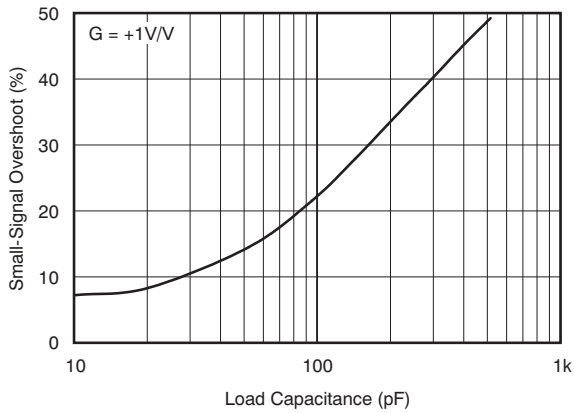

Figure 15. Small-Signal Overshoot vs Load Capacitance

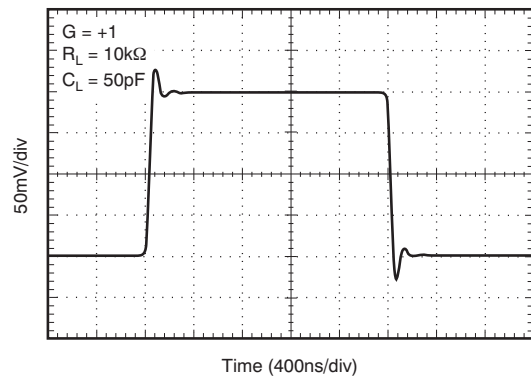

Figure 16. Small-Signal Pulse Response

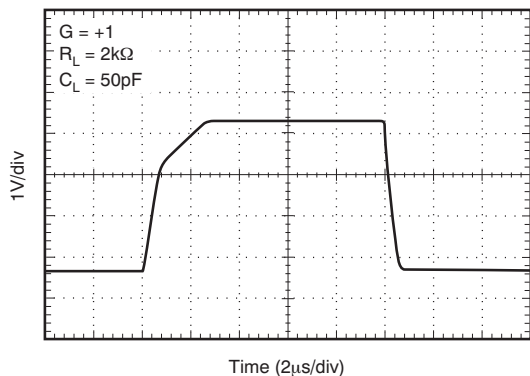

Figure 17. Large-Signal Pulse Response

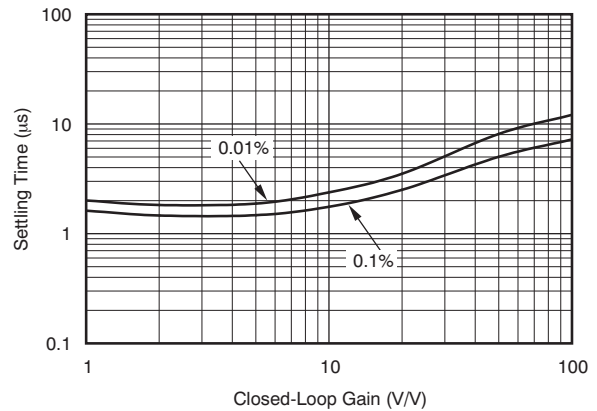

Figure 18. Settling Time vs Closed-Loop Gain

Typical Characteristics (continued)

At $T_A = 25^\circ\text{C}$, $V_S = 5\text{ V}$, $R_L = 10\text{ k}\Omega$ connected to $V_S/2$, $V_{CM} = V_S/2$, and $V_{OUT} = V_S/2$, unless otherwise noted.

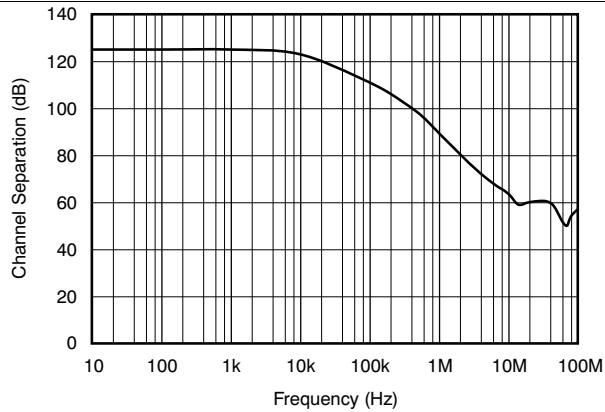

Figure 19. Channel Separation vs Frequency

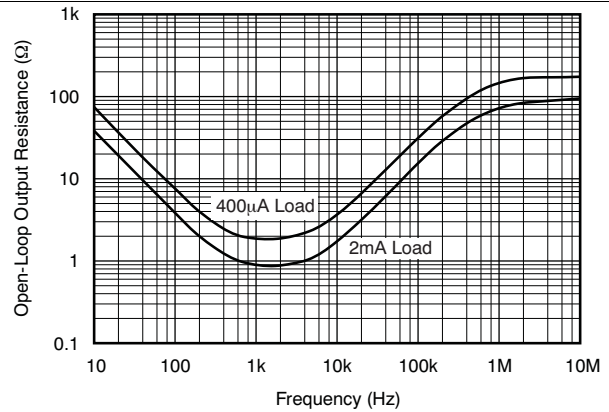

Figure 20. Open-Loop Output Resistance vs Frequency

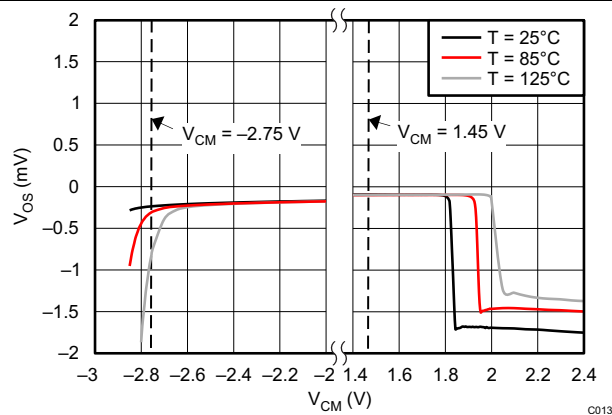

Figure 21. Input Offset Voltage vs Common-Mode Voltage

7 Detailed Description

7.1 Overview

The OPAx377-Q1 family belongs to a new generation of low-noise operational amplifiers, giving customers outstanding dc precision and ac performance. Low noise, rail-to-rail input and output, and low offset, drawing a low quiescent current, make these devices ideal for a variety of precision and portable applications. In addition, this device has a wide supply range with excellent PSRR, making it a suitable option for applications that are battery-powered without regulation.

7.2 Functional Block Diagram

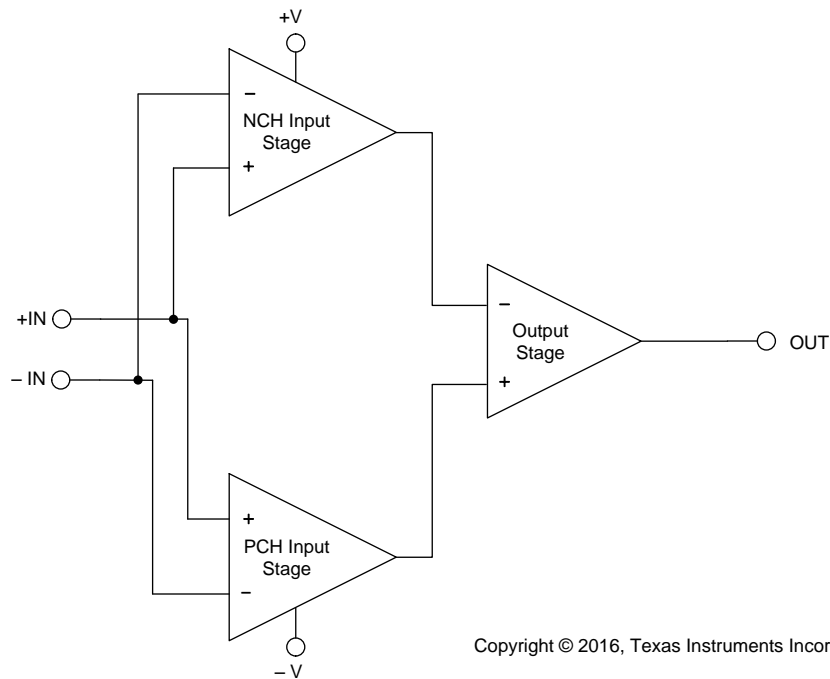

Copyright © 2016, Texas Instruments Incorporated

7.3 Feature Description

7.3.1 Operating Characteristics

The OPAx377-Q1 family of amplifiers has parameters that are fully specified from 2.2 V to 5.5 V (± 1.1 V to ± 2.75 V). Many of the specifications apply from -40°C to $+125^{\circ}\text{C}$. Parameters that can exhibit significant variance with regard to operating voltage or temperature are presented in the *Typical Characteristics* section.

7.3.2 Common-Mode Voltage Range

The input common-mode voltage range of the OPAx377-Q1 series extends 100 mV beyond the supply rails. The offset voltage of the amplifier is low, from approximately $(V-)$ to $(V+) - 1$ V, as shown in Figure 22. The offset voltage increases as common-mode voltage exceeds $(V+) - 1$ V. Common-mode rejection is specified from $(V-) - 1.3$ V.

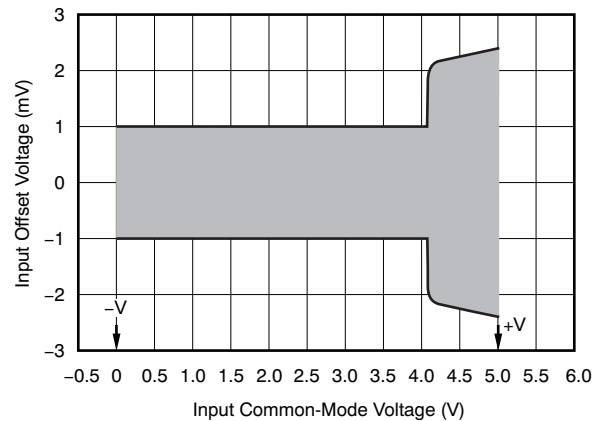
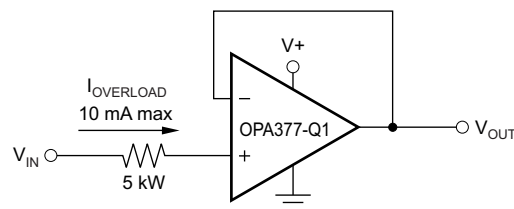

Figure 22. Offset and Common-Mode Voltage

7.3.3 Input and ESD Protection

The OPAx377-Q1 family incorporates internal electrostatic discharge (ESD) protection circuits on all pins. In the case of input and output pins, this protection primarily consists of current steering diodes connected between the input and power-supply pins. These ESD protection diodes also provide in-circuit, input overdrive protection, as long as the current is limited to 10 mA as stated in the *Absolute Maximum Ratings* table.

Figure 23 shows how a series input resistor may be added to the driven input to limit the input current. The added resistor contributes thermal noise at the amplifier input and its value must be kept to a minimum in noise-sensitive applications.



Copyright © 2016, Texas Instruments Incorporated

Figure 23. Input Current Protection

Feature Description (continued)

7.3.4 EMI Susceptibility and Input Filtering

Operational amplifiers vary in susceptibility to electromagnetic interference (EMI). If conducted EMI enters the operational amplifier, the dc offset observed at the amplifier output may shift from the nominal value while the EMI is present. This shift is a result of signal rectification associated with the internal semiconductor junctions. While all amplifier pin functions can be affected by EMI, the input pins are likely to be the most susceptible. The OPAx377-Q1 operational amplifier family incorporates an internal input low-pass filter that reduces the amplifier response to EMI. Both common-mode and differential mode filtering are provided by the input filter. The filter is designed for a cutoff frequency of approximately 75 MHz (–3 dB), with a roll-off of 20 dB per decade.

7.3.5 Capacitive Load and Stability

The OPAx377-Q1 series of amplifiers may be used in applications where driving a capacitive load is required. As with all op amps, there may be specific instances where the OPAx377-Q1 can become unstable, leading to oscillation. The particular op amp circuit configuration, layout, gain, and output loading are some of the factors to consider when establishing whether an amplifier will be stable in operation. An op amp in the unity-gain (1 V/V) buffer configuration and driving a capacitive load exhibits a greater tendency to be unstable than an amplifier operated at a higher noise gain. The capacitive load, in conjunction with the op amp output resistance, creates a pole within the feedback loop that degrades the phase margin. The degradation of the phase margin increases as the capacitive loading increases.

The OPAx377-Q1 in a unity-gain configuration can directly drive up to 250-pF pure capacitive load. Increasing the gain enhances the ability of the amplifier to drive greater capacitive loads; see the typical characteristic plot, [Figure 15](#). In unity-gain configurations, capacitive load drive can be improved by inserting a small (10-Ω to 20-Ω) resistor, R_S , in series with the output, as shown in [Figure 24](#). This resistor significantly reduces ringing while maintaining dc performance for purely capacitive loads. However, if there is a resistive load in parallel with the capacitive load, a voltage divider is created, introducing a gain error at the output and slightly reducing the output swing. The error introduced is proportional to the ratio R_S/R_L , and is generally negligible at low output current levels.

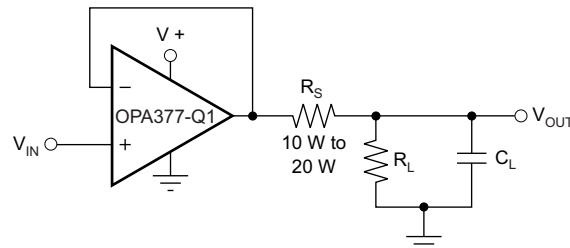

Copyright © 2016, Texas Instruments Incorporated

Figure 24. Improving Capacitive Load Drive

7.4 Device Functional Modes

The OPAx377-Q1 has a single functional mode and is operational when the power-supply voltage is greater than 2.2 V (± 1.1 V). The maximum power supply voltage for the OPAx376-Q1 is 5.5 V (± 2.75 V).

8 Application and Implementation

NOTE

Information in the following applications sections is not part of the TI component specification, and TI does not warrant its accuracy or completeness. TI's customers are responsible for determining suitability of components for their purposes. Customers should validate and test their design implementation to confirm system functionality.

8.1 Application Information

The OPAx377-Q1 family of operational amplifiers is built on a precision analog CMOS technology featuring low noise and low offset voltage. The OPAx377-Q1 family delivers excellent offset voltage (250 μ V, typical). Additionally, the amplifier boasts a fast slew rate, low drift, low noise, and excellent PSRR and A_{OL} . These 5.5-MHz CMOS op amps operate on 760 μ A (typical) quiescent current.

8.2 Typical Application

Low-pass filters are commonly employed in signal processing applications to reduce noise and prevent aliasing. The OPA377-Q1 is ideally suited to construct high-speed, high-precision active filters. [Figure 25](#) shows a second-order, low-pass filter commonly encountered in signal processing applications.

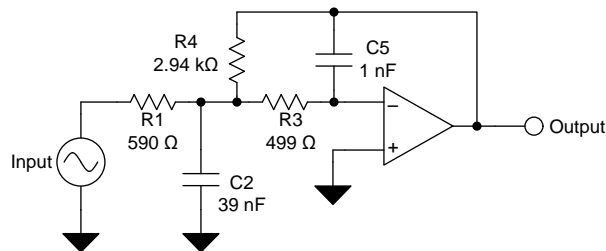

Copyright © 2016, Texas Instruments Incorporated

Figure 25. Typical Application Schematic

8.2.1 Design Requirements

Use the following parameters for this design example:

- Gain = 5 V/V (inverting gain)
- Low-pass cutoff frequency = 25 kHz
- Second-order Chebyshev filter response with 3-dB gain peaking in the passband

8.2.2 Detailed Design Procedure

The infinite-gain multiple-feedback circuit for a low-pass network function is shown in [Figure 25](#). Use [Equation 1](#) to calculate the voltage transfer function.

$$\frac{\text{Output}}{\text{Input}}(s) = \frac{-1/R_1 R_3 C_2 C_5}{s^2 + (s/C_2)(1/R_1 + 1/R_3 + 1/R_4) + 1/R_3 R_4 C_2 C_5} \quad (1)$$

This circuit produces a signal inversion. For this circuit, the gain at dc and the low-pass cutoff frequency are calculated by [Equation 2](#):

$$\text{Gain} = \frac{R_4}{R_1}$$

$$f_c = \frac{1}{2\pi} \sqrt{(1/R_3 R_4 C_2 C_5)} \quad (2)$$

Software tools are readily available to simplify filter design. [WEBENCH® Filter Designer](#) is a simple, powerful, and easy-to-use active filter design program. The WEBENCH Filter Designer lets you create optimized filter designs using a selection of TI operational amplifiers and passive components from TI's vendor partners.

Typical Application (continued)

Available as a web-based tool from the WEBENCH® Design Center, [WEBENCH® Filter Designer](#) allows to design, optimize, and simulate complete multi-stage active filter solutions within minutes.

8.2.3 Application Curve

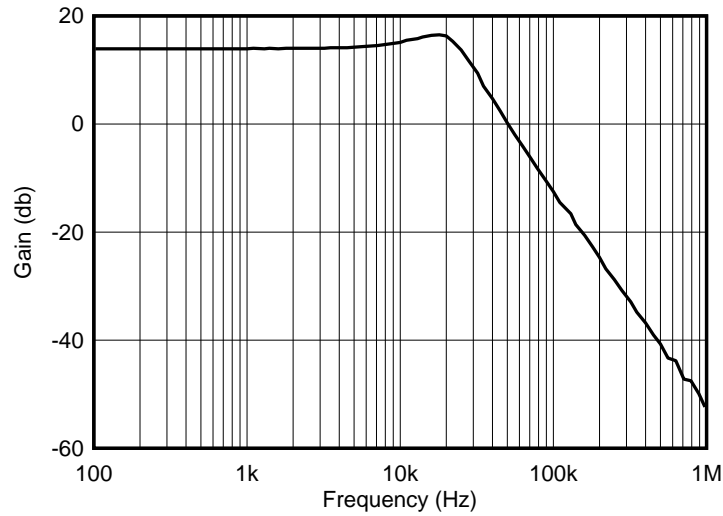

Figure 26. Low-Pass Filter Transfer Function

9 Power Supply Recommendations

The OPAx377-Q1 family of devices is specified for operation from 2.2 V to 5.5 V (± 1.1 V to ± 2.75 V); many specifications apply from -40°C to $+125^{\circ}\text{C}$. Parameters that can exhibit significant variance with regard to operating voltage or temperature are presented in the [Typical Characteristics](#) section.

10 Layout

10.1 Layout Guidelines

For best operational performance of the device, use good printed circuit board (PCB) layout practices, including:

- Noise can propagate into analog circuitry through the power pins of the circuit as a whole and op amp itself. Bypass capacitors are used to reduce the coupled noise by providing low-impedance power sources local to the analog circuitry.
 - Connect low-ESR, 0.1- μF ceramic bypass capacitors between each supply pin and ground, placed as close to the device as possible. A single bypass capacitor from $V+$ to ground is applicable for single-supply applications.
- Separate grounding for analog and digital portions of circuitry is one of the simplest and most-effective methods of noise suppression. One or more layers on multilayer PCBs are usually devoted to ground planes. A ground plane helps distribute heat and reduces EMI noise pickup. Make sure to physically separate digital and analog grounds paying attention to the flow of the ground current. For more detailed information refer to the application report, *Circuit Board Layout Techniques*, [SLOA089](#).
- In order to reduce parasitic coupling, run the input traces as far away from the supply or output traces as possible. If these traces cannot be kept separate, crossing the sensitive trace perpendicular is much better as opposed to in parallel with the noisy trace.
- Place the external components as close to the device as possible. As shown in [Figure 28](#), keeping R_F and R_G close to the inverting input minimizes parasitic capacitance.
- Keep the length of input traces as short as possible. Always remember that the input traces are the most sensitive part of the circuit.
- Consider a driven, low-impedance guard ring around the critical traces. A guard ring can significantly reduce leakage currents from nearby traces that are at different potentials.
- Cleaning the PCB following board assembly is recommended for best performance.
- Any precision integrated circuit may experience performance shifts due to moisture ingress into the plastic package. Following any aqueous PCB cleaning process, baking the PCB assembly is recommended to remove moisture introduced into the device packaging during the cleaning process. A low temperature, post cleaning bake at 85°C for 30 minutes is sufficient for most circumstances.

10.2 Layout Example

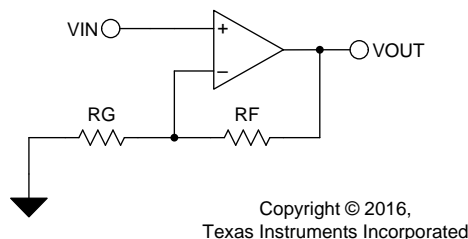
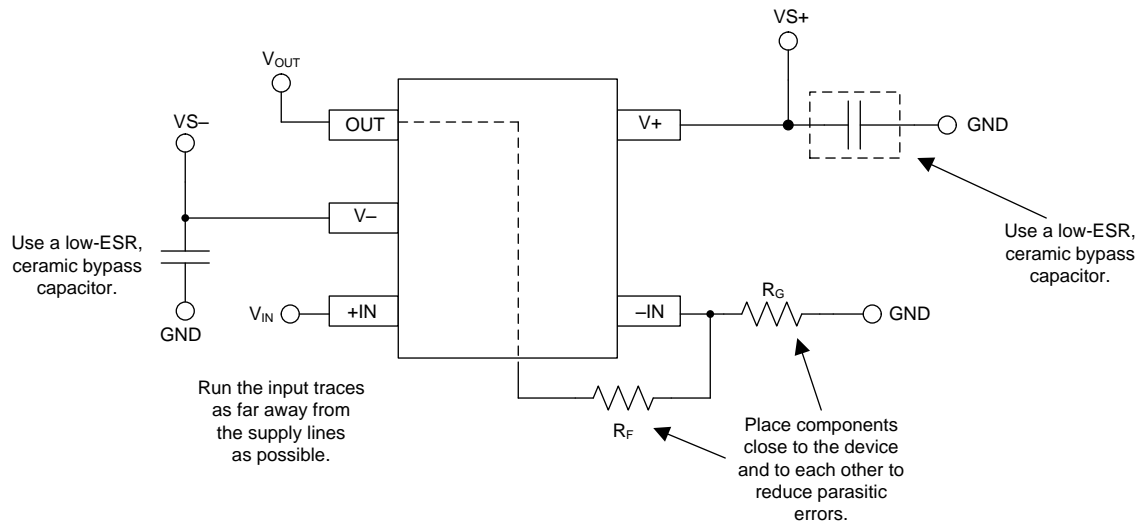

Figure 27. Typical Schematic for PCB Layout Example

Layout Example (continued)



Copyright © 2016, Texas Instruments Incorporated

Figure 28. Typical PCB Layout Example

11 デバイスおよびドキュメントのサポート

11.1 デバイス・サポート

11.1.1 開発サポート

11.1.1.1 TINA-TI™ (無料のダウンロード・ソフトウェア)

TINA™は、SPICEエンジンをベースにした単純かつ強力な、使いやすい回路シミュレーション・プログラムです。TINA-TI™はTINAソフトウェアの無料バージョンで、完全な機能を持ち、パッシブとアクティブ両方のモデルに加えて、マクロ・モデルのライブラリがプリロードされています。TINA-TIには従来型のDC、トランジエント、および周波数ドメインのSPICEによる分析と、追加の設計機能が搭載されています。

TINA-TIはAnalog eLab Design Centerから無料でダウンロードでき、ユーザーが結果をさまざまな方法でフォーマットできる、広範な後処理機能を備えています。仮想計測器により、入力波形を選択し、回路ノード、電圧、および波形をプローブして、動的なクイック・スタート・ツールを作成できます。

注

これらのファイルを使用するには、TINAソフトウェア(DesignSoft™製)またはTINA-TIソフトウェアがインストールされている必要があります。TINA-TIフォルダから、無料のTINA-TIソフトウェアをダウンロードしてください。

11.1.1.2 DIPアダプタ評価モジュール

DIPアダプタ評価モジュールツールを使用すると、小さな表面実装ICのプロトタイプを簡単に、低コストで作成できます。この評価ツールは、DまたはU(SOIC-8)、PW(TSSOP-8)、DGK(MSOP-8)、DBV(SOT23-6、SOT23-5、およびSOT23-3)、DCK(SC70-6およびSC70-5)、およびDRL(SOT563-6)のTIパッケージに対応しています。DIPアダプタ評価モジュールは、ターミナル・ストリップとともに使用することも、既存の回路へ直接接続することもできます。

11.1.1.3 ユニバーサル・オペアンプ評価モジュール

ユニバーサル・オペアンプ評価モジュールは一連の汎用のブランクアウト回路基板で、各種のICパッケージ・タイプ向けの回路のプロトタイプ作成を容易にします。評価モジュール基板の設計により、多くの異なる回路を簡単かつ迅速に構築できます。5つのモデルが提供されており、それぞれのモデルは特定のパッケージ・タイプを対象としています。PDIP、SOIC、MSOP、TSSOP、およびSOT23のパッケージがすべてサポートされています。

注

これらの基板には部品が搭載されていないため、ユーザーが独自のICを供給する必要があります。ユニバーサル・オペアンプ評価モジュールを注文するときに、オペアンプ・デバイスのサンプルをいくつか要求することをお勧めします。

11.1.1.4 TI Precision Designs

TI Precision Designsは、TIの高精度アナログ・アプリケーションの専門家により作成されたアナログ・ソリューションで、多くの有用な回路に関して、動作理論、コンポーネント選択、シミュレーション、完全なPCB回路図とレイアウト、部品表、性能測定結果を提供します。TI Precision Designsは、<http://www.ti.com/ww/en/analog/precision-designs/>からオンラインで入手できます。

11.1.1.5 WEBENCH® Filter Designer

WEBENCH® Filter Designerは単純で強力な、使いやすいアクティブ・フィルタ設計プログラムです。WEBENCH Filter Designerを使用すると、TIのベンダ・パートナーからのTI製オペアンプやパッシブ・コンポーネントを使用して、最適なフィルタ設計を作成できます。

WEBENCH® Filter Designerは、WEBENCH® Design CenterからWebベースのツールとして利用でき、包括的な複数段アクティブ・フィルタ・ソリューションをわずか数分で設計、最適化、シミュレーションできます。

11.2 ドキュメントのサポート

11.2.1 関連資料

関連資料については、以下をを参照してください:

- 『基板のレイアウト技法』、[SLOA089](#)
- 『オペアンプのゲイン安定性、第3部: ACゲイン誤差の解析』、[SLYT383](#)
- 『オペアンプのゲイン安定性、第2部: DCゲイン誤差の解析』、[SLYT374](#)
- 『オペアンプのパフォーマンス解析』、[SBOS054](#)
- 『鉛フリー仕上げ部品の保管寿命評価』、[SZZA046](#)
- 『オペアンプの単一電源動作』、[SBOA059](#)
- 『アンプのチューニング』、[SBOA067](#)
- 『完全差動アクティブ・フィルタにおける無限ゲイン、MFBフィルタ・トポロジの使用』、[SLYT343](#)

11.3 コミュニティ・リソース

以下のリンクから、TIのコミュニティ・リソースにアクセスできます。リンクされているコンテンツは、投稿者のコンテンツがそのまま掲載されたものです。TIがこの内容を保証するものではなく、また必ずしもTIの見解が反映されたものではありません。TIの[使用条件](#)を参照してください。

"TI E2E™オンライン・コミュニティ" — TIの**E2E (Engineer-to-Engineer)** コミュニティ。エンジニア間の情報共有をサポートする目的で作成されたものです。e2e.ti.comで質問し、知識を共有し、アイデアを検討するなど、技術的な問題を解決するためのコミュニティ・サイトです。

"設計サポート" — TIの設計サポート役に立つE2Eフォーラムや、設計サポート・ツールをすばやく見つけることができます。技術サポート用の連絡先情報も参照できます。

11.4 商標

TINA-TI, E2E are trademarks of Texas Instruments.

WEBENCH is a registered trademark of Texas Instruments.

TINA, DesignSoft are trademarks of DesignSoft, Inc.

11.5 静電気放電に関する注意事項



これらのデバイスは、限定的なESD(静電破壊)保護機能を内蔵しています。保存時または取り扱い時は、MOSゲートに対する静電破壊を防止するために、リード線同士をショートさせておくか、デバイスを導電フォームに入れる必要があります。

11.6 用語集

[SLYZ022](#) — TI用語集.

この用語集には、用語や略語の一覧および定義が記載されています。

12 メカニカル、パッケージ、および注文情報

以降のページには、メカニカル、パッケージ、および注文に関する情報が記載されています。これらの情報は、指定のデバイスに対して提供されている最新のデータです。このデータは予告なく変更されることがあり、ドキュメントが改訂される場合もあります。本データシートのブラウザ版を使用されている場合は、画面左側の説明をご覧ください。

PACKAGING INFORMATION

Orderable part number	Status (1)	Material type (2)	Package Pins	Package qty Carrier	RoHS (3)	Lead finish/ Ball material (4)	MSL rating/ Peak reflow (5)	Op temp (°C)	Part marking (6)
OPA2377QDGKRQ1	Active	Production	VSSOP (DGK) 8	2500 LARGE T&R	Yes	NIPDAU NIPDAUAG	Level-2-260C-1 YEAR	-40 to 125	2377
OPA2377QDGKRQ1.A	Active	Production	VSSOP (DGK) 8	2500 LARGE T&R	Yes	NIPDAUAG	Level-2-260C-1 YEAR	-40 to 125	2377
OPA2377QDGKRQ1.B	Active	Production	VSSOP (DGK) 8	2500 LARGE T&R	Yes	NIPDAUAG	Level-2-260C-1 YEAR	-40 to 125	2377
OPA377QDBVRQ1	Active	Production	SOT-23 (DBV) 5	3000 LARGE T&R	Yes	NIPDAU	Level-2-260C-1 YEAR	-40 to 125	377Q
OPA377QDBVRQ1.B	Active	Production	SOT-23 (DBV) 5	3000 LARGE T&R	Yes	NIPDAU	Level-2-260C-1 YEAR	-40 to 125	377Q
OPA4377AQPWRQ1	Active	Production	TSSOP (PW) 14	2000 LARGE T&R	Yes	NIPDAU	Level-2-260C-1 YEAR	-40 to 125	4377Q1
OPA4377AQPWRQ1.B	Active	Production	TSSOP (PW) 14	2000 LARGE T&R	Yes	NIPDAU	Level-2-260C-1 YEAR	-40 to 125	4377Q1

(1) **Status:** For more details on status, see our [product life cycle](#).

(2) **Material type:** When designated, preproduction parts are prototypes/experimental devices, and are not yet approved or released for full production. Testing and final process, including without limitation quality assurance, reliability performance testing, and/or process qualification, may not yet be complete, and this item is subject to further changes or possible discontinuation. If available for ordering, purchases will be subject to an additional waiver at checkout, and are intended for early internal evaluation purposes only. These items are sold without warranties of any kind.

(3) **RoHS values:** Yes, No, RoHS Exempt. See the [TI RoHS Statement](#) for additional information and value definition.

(4) **Lead finish/Ball material:** Parts may have multiple material finish options. Finish options are separated by a vertical ruled line. Lead finish/Ball material values may wrap to two lines if the finish value exceeds the maximum column width.

(5) **MSL rating/Peak reflow:** The moisture sensitivity level ratings and peak solder (reflow) temperatures. In the event that a part has multiple moisture sensitivity ratings, only the lowest level per JEDEC standards is shown. Refer to the shipping label for the actual reflow temperature that will be used to mount the part to the printed circuit board.

(6) **Part marking:** There may be an additional marking, which relates to the logo, the lot trace code information, or the environmental category of the part.

Multiple part markings will be inside parentheses. Only one part marking contained in parentheses and separated by a "-" will appear on a part. If a line is indented then it is a continuation of the previous line and the two combined represent the entire part marking for that device.

Important Information and Disclaimer: The information provided on this page represents TI's knowledge and belief as of the date that it is provided. TI bases its knowledge and belief on information provided by third parties, and makes no representation or warranty as to the accuracy of such information. Efforts are underway to better integrate information from third parties. TI has taken and continues to take reasonable steps to provide representative and accurate information but may not have conducted destructive testing or chemical analysis on incoming materials and chemicals. TI and TI suppliers consider certain information to be proprietary, and thus CAS numbers and other limited information may not be available for release.

In no event shall TI's liability arising out of such information exceed the total purchase price of the TI part(s) at issue in this document sold by TI to Customer on an annual basis.

OTHER QUALIFIED VERSIONS OF OPA2377-Q1, OPA377-Q1, OPA4377-Q1 :

- Catalog : [OPA2377](#), [OPA377](#), [OPA4377](#)

NOTE: Qualified Version Definitions:

- Catalog - TI's standard catalog product

TAPE AND REEL INFORMATION

QUADRANT ASSIGNMENTS FOR PIN 1 ORIENTATION IN TAPE

*All dimensions are nominal

Device	Package Type	Package Drawing	Pins	SPQ	Reel Diameter (mm)	Reel Width W1 (mm)	A0 (mm)	B0 (mm)	K0 (mm)	P1 (mm)	W (mm)	Pin1 Quadrant
OPA2377QDGKRQ1	VSSOP	DGK	8	2500	330.0	12.4	5.3	3.4	1.4	8.0	12.0	Q1
OPA377QDBVRQ1	SOT-23	DBV	5	3000	178.0	9.0	3.3	3.2	1.4	4.0	8.0	Q3
OPA4377AQPWRQ1	TSSOP	PW	14	2000	330.0	12.4	6.9	5.6	1.6	8.0	12.0	Q1

TAPE AND REEL BOX DIMENSIONS

*All dimensions are nominal

Device	Package Type	Package Drawing	Pins	SPQ	Length (mm)	Width (mm)	Height (mm)
OPA2377QDGKRQ1	VSSOP	DGK	8	2500	353.0	353.0	32.0
OPA377QDBVRQ1	SOT-23	DBV	5	3000	180.0	180.0	18.0
OPA4377AQPWRQ1	TSSOP	PW	14	2000	353.0	353.0	32.0

PW0014A



PACKAGE OUTLINE
TSSOP - 1.2 mm max height

SMALL OUTLINE PACKAGE



4220202/B 12/2023

NOTES:

1. All linear dimensions are in millimeters. Any dimensions in parenthesis are for reference only. Dimensioning and tolerancing per ASME Y14.5M.
2. This drawing is subject to change without notice.
3. This dimension does not include mold flash, protrusions, or gate burrs. Mold flash, protrusions, or gate burrs shall not exceed 0.15 mm per side.
4. This dimension does not include interlead flash. Interlead flash shall not exceed 0.25 mm per side.
5. Reference JEDEC registration MO-153.

EXAMPLE BOARD LAYOUT

PW0014A

TSSOP - 1.2 mm max height

SMALL OUTLINE PACKAGE



LAND PATTERN EXAMPLE
EXPOSED METAL SHOWN
SCALE: 10X



4220202/B 12/2023

NOTES: (continued)

- 6. Publication IPC-7351 may have alternate designs.
- 7. Solder mask tolerances between and around signal pads can vary based on board fabrication site.

EXAMPLE STENCIL DESIGN

PW0014A

TSSOP - 1.2 mm max height

SMALL OUTLINE PACKAGE



SOLDER PASTE EXAMPLE
BASED ON 0.125 mm THICK STENCIL
SCALE: 10X

4220202/B 12/2023

NOTES: (continued)

8. Laser cutting apertures with trapezoidal walls and rounded corners may offer better paste release. IPC-7525 may have alternate design recommendations.
9. Board assembly site may have different recommendations for stencil design.

EXAMPLE BOARD LAYOUT

DBV0005A

SOT-23 - 1.45 mm max height

SMALL OUTLINE TRANSISTOR



LAND PATTERN EXAMPLE
EXPOSED METAL SHOWN
SCALE:15X



SOLDER MASK DETAILS

4214839/K 08/2024

NOTES: (continued)

- 6. Publication IPC-7351 may have alternate designs.
- 7. Solder mask tolerances between and around signal pads can vary based on board fabrication site.

EXAMPLE STENCIL DESIGN

DBV0005A

SOT-23 - 1.45 mm max height

SMALL OUTLINE TRANSISTOR



SOLDER PASTE EXAMPLE
BASED ON 0.125 mm THICK STENCIL
SCALE:15X

4214839/K 08/2024

NOTES: (continued)

8. Laser cutting apertures with trapezoidal walls and rounded corners may offer better paste release. IPC-7525 may have alternate design recommendations.
9. Board assembly site may have different recommendations for stencil design.

DGK0008A



PACKAGE OUTLINE

VSSOP - 1.1 mm max height

SMALL OUTLINE PACKAGE



NOTES:

PowerPAD is a trademark of Texas Instruments.

1. All linear dimensions are in millimeters. Any dimensions in parenthesis are for reference only. Dimensioning and tolerancing per ASME Y14.5M.
2. This drawing is subject to change without notice.
3. This dimension does not include mold flash, protrusions, or gate burrs. Mold flash, protrusions, or gate burrs shall not exceed 0.15 mm per side.
4. This dimension does not include interlead flash. Interlead flash shall not exceed 0.25 mm per side.
5. Reference JEDEC registration MO-187.

EXAMPLE BOARD LAYOUT

DGK0008A

™ VSSOP - 1.1 mm max height

SMALL OUTLINE PACKAGE



LAND PATTERN EXAMPLE
EXPOSED METAL SHOWN
SCALE: 15X



4214862/A 04/2023

NOTES: (continued)

6. Publication IPC-7351 may have alternate designs.
7. Solder mask tolerances between and around signal pads can vary based on board fabrication site.
8. Vias are optional depending on application, refer to device data sheet. If any vias are implemented, refer to their locations shown on this view. It is recommended that vias under paste be filled, plugged or tented.
9. Size of metal pad may vary due to creepage requirement.

EXAMPLE STENCIL DESIGN

DGK0008A

TM VSSOP - 1.1 mm max height

SMALL OUTLINE PACKAGE



SOLDER PASTE EXAMPLE
SCALE: 15X

4214862/A 04/2023

NOTES: (continued)

11. Laser cutting apertures with trapezoidal walls and rounded corners may offer better paste release. IPC-7525 may have alternate design recommendations.
12. Board assembly site may have different recommendations for stencil design.

重要なお知らせと免責事項

TI は、技術データと信頼性データ(データシートを含みます)、設計リソース(リファレンス デザインを含みます)、アプリケーションや設計に関する各種アドバイス、Web ツール、安全性情報、その他のリソースを、欠陥が存在する可能性のある「現状のまま」提供しており、商品性および特定目的に対する適合性の黙示保証、第三者の知的財産権の非侵害保証を含むいかなる保証も、明示的または黙示的にかかわらず拒否します。

これらのリソースは、TI 製品を使用する設計の経験を積んだ開発者への提供を意図したものです。(1) お客様のアプリケーションに適した TI 製品の選定、(2) お客様のアプリケーションの設計、検証、試験、(3) お客様のアプリケーションに該当する各種規格や、その他のあらゆる安全性、セキュリティ、規制、または他の要件への確実な適合に関する責任を、お客様のみが単独で負うものとし、

上記の各種リソースは、予告なく変更される可能性があります。これらのリソースは、リソースで説明されている TI 製品を使用するアプリケーションの開発の目的でのみ、TI はその使用をお客様に許諾します。これらのリソースに関して、他の目的で複製することや掲載することは禁止されています。TI や第三者の知的財産権のライセンスが付与されている訳ではありません。お客様は、これらのリソースを自身で使用した結果発生するあらゆる申し立て、損害、費用、損失、責任について、TI およびその代理人を完全に補償するものとし、TI は一切の責任を拒否します。

TI の製品は、[TI の販売条件](#)、[TI の総合的な品質ガイドライン](#)、[ti.com](#) または TI 製品などに関連して提供される他の適用条件に従い提供されます。TI がこれらのリソースを提供することは、適用される TI の保証または他の保証の放棄の拡大や変更を意味するものではありません。TI がカスタム、またはカスタマー仕様として明示的に指定していない限り、TI の製品は標準的なカタログに掲載される汎用機器です。

お客様がいかなる追加条項または代替条項を提案する場合も、TI はそれらに異議を唱え、拒否します。

Copyright © 2025, Texas Instruments Incorporated

最終更新日：2025 年 10 月