

OPA4H199-SP 40V、QML Class-P、放射線耐性強化 (RHA)、レールツーレール入出力、低オフセット電圧、低ノイズ オペアンプ、宇宙向けプラスチック封止

1 特長

- QML Class-P 放射線耐性保証 (QMLP-RHA) グレード
- 小型 SOT-23 パッケージで供給
- 耐放射線性能:
 - シングル イベント ラッチアップ (SEL) 耐性: 最大 65MeV-cm²/mg
 - 最大 100krad(Si) の総吸収線量 (TID) 放射線耐性保証 (RHA)
- 防衛、航空宇宙、および医療アプリケーションをサポート
 - 単一の制御されたベースライン
 - 単一の製造、アセンブリ、テスト施設
 - 金線
 - NiPdAu リード仕上げ
 - 軍用温度範囲 (-55°C~125°C) を供給可能
 - 長期にわたる製品ライフ サイクル
 - 製品のトレーサビリティ
 - モールド コンパウンドの改良による低いガス放出
- 低いオフセット電圧: ±125μV
- 低ノイズ: 1kHz で 10.8nV/√Hz
- 大きい同相除去: 130 dB
- 低いバイアス電流: ±10pA
- レール ツー レール 入出力
- 広い帯域幅: 4.5MHz GBW
- 高いスルーレート: 21V/μs
- 高い容量性負荷駆動能力: 1nF
- 多重化対応 / コンパレータ入力
- 低い静止電流: アンプ 1 個あたり 560μA
- 広い電源範囲: ±1.35V~±20V, 2.7V~40V
- 堅牢な EMIRR 性能: 入力ピンと電源ピンの EMI/RFI フィルタ

2 アプリケーション

- 低軌道衛星用途のサポート
- 宇宙用センサおよび制御 (遠隔測定)
- [衛星用電源システム \(EPS\)](#)
- [飛行制御](#)
- [衛星用コマンドおよびデータ処理](#)
- [衛星観測機器](#)

3 概要

OPA4H199-SP は、宇宙アプリケーション向けの高電圧 (40V) 汎用オペアンプです。このデバイスは、レール ツー レール入出力、低いオフセット (±125μV、標準値)、低いオフセット ドリフト (±0.3μV/°C、標準値)、低ノイズ (10.8nV/√Hz、1.8μV_{pp})、4.5MHz の帯域幅など、非常に優れた DC 精度と AC 性能を備えています。

電源レールまでの差動および同相入力電圧範囲、大出力電流 (±75mA)、高いスルーレート (21V/μs)、高い容量性負荷駆動 (1nF) などの独自の機能を備えた OPA4H199-SP は、高電圧宇宙アプリケーション用の堅牢な高性能オペアンプです。

OPA4H199-SP は、放射線耐性を強化した小型の 14 ピン SOT-23 (DYY) プラスチック パッケージで供給されます。SOT-23 (DYY) パッケージの本体サイズは、従来の 14 ピン セラミック パッケージの 1/5 未満です。OPA4H199-SP は -55°C~125°C で動作が規定されています。

パッケージ情報

部品番号 ⁽¹⁾	パッケージ	パッケージ サイズ ⁽²⁾
OPA4H199-SP	DYY (SOT-23, 14)	4.2mm × 3.26mm

- (1) 利用可能なすべてのパッケージについては、データシートの末尾にある注文情報を参照してください。
- (2) パッケージ サイズ (長さ × 幅) は公称値で、該当する場合はピンも含まれます。

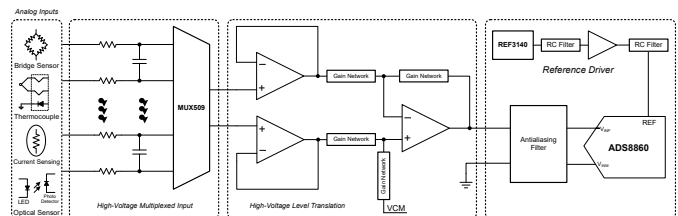

OPA4H199-SP による高電圧信号チェーン



Table of Contents

1 特長	1	7 Application and Implementation	24
2 アプリケーション	1	7.1 Application Information.....	24
3 概要	1	7.2 Typical Applications.....	24
4 Pin Configuration and Functions	3	7.3 Power Supply Recommendations.....	26
5 Specifications	4	7.4 Layout.....	26
5.1 Absolute Maximum Ratings.....	4	8 Device and Documentation Support	28
5.2 ESD Ratings.....	4	8.1 Device Support.....	28
5.3 Recommended Operating Conditions.....	4	8.2 Documentation Support.....	28
5.4 Thermal Information for Quad Channel.....	4	8.3 ドキュメントの更新通知を受け取る方法.....	28
5.5 Electrical Characteristics.....	5	8.4 サポート・リソース.....	28
5.6 Typical Characteristics.....	7	8.5 Trademarks.....	28
6 Detailed Description	14	8.6 静電気放電に関する注意事項.....	29
6.1 Overview.....	14	8.7 用語集.....	29
6.2 Functional Block Diagram.....	14	9 Revision History	29
6.3 Feature Description.....	15	10 Mechanical, Packaging, and Orderable Information	29
6.4 Device Functional Modes.....	23		

4 Pin Configuration and Functions



図 4-1. OPA4H199-SP DYY Package
14-Pin SOT-23
Top View

表 4-1. Pin Functions: OPA4H199-SP

PIN		I/O	DESCRIPTION
NAME	NO.		
IN1+	3	I	Noninverting input, channel 1
IN1–	2	I	Inverting input, channel 1
IN2+	5	I	Noninverting input, channel 2
IN2–	6	I	Inverting input, channel 2
IN3+	10	I	Noninverting input, channel 3
IN3–	9	I	Inverting input, channel 3
IN4+	12	I	Noninverting input, channel 4
IN4–	13	I	Inverting input, channel 4
OUT1	1	O	Output, channel 1
OUT2	7	O	Output, channel 2
OUT3	8	O	Output, channel 3
OUT4	14	O	Output, channel 4
V+	4	—	Positive (highest) power supply
V–	11	—	Negative (lowest) power supply

5 Specifications

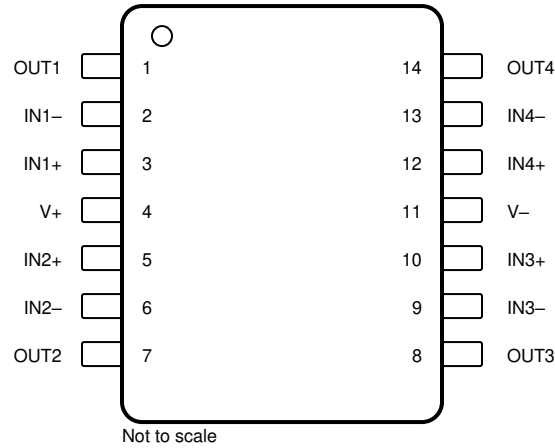
5.1 Absolute Maximum Ratings

over operating ambient temperature range (unless otherwise noted) ⁽¹⁾

		MIN	MAX	UNIT
Supply voltage, $V_S = (V+) - (V-)$		0	42	V
Signal input pins	Common-mode voltage ⁽³⁾	$(V-) - 0.5$	$(V+) + 0.5$	V
	Differential voltage ⁽³⁾		$V_S + 0.2$	V
	Current ⁽³⁾	-10	10	mA
Output short-circuit ⁽²⁾		Continuous		
Operating ambient temperature, T_A		-55	150	°C
Junction temperature, T_J			150	°C
Storage temperature, T_{stg}		-65	150	°C

- (1) Operation outside the *Absolute Maximum Ratings* may cause permanent device damage. *Absolute Maximum Ratings* do not imply functional operation of the device at these or any other conditions beyond those listed under *Recommended Operating Conditions*. If used outside the *Recommended Operating Conditions* but within the *Absolute Maximum Ratings*, the device may not be fully functional, and this may affect device reliability, functionality, performance, and shorten the device lifetime.
- (2) Short-circuit to ground, one amplifier per package. This device has been designed to limit *electrical* damage due to excessive output current, but extended short-circuit current, especially with higher supply voltage, can cause excessive heating and eventual *thermal* destruction. See the [Thermal Protection](#) section for more information.
- (3) Input pins are diode-clamped to the power-supply rails. Input signals that may swing more than 0.5V beyond the supply rails must be current limited to 10mA or less.

5.2 ESD Ratings

			VALUE	UNIT
$V_{(ESD)}$	Electrostatic discharge	Human body model (HBM), per ANSI/ESDA/JEDEC JS-001 ⁽¹⁾	±2000	V
		Charged device model (CDM), per ANSI/ESDA/JEDEC JS-002 ⁽²⁾	±1000	

- (1) JEDEC document JEP155 states that 500V HBM allows safe manufacturing with a standard ESD control process.
- (2) JEDEC document JEP157 states that 250V CDM allows safe manufacturing with a standard ESD control process.

5.3 Recommended Operating Conditions

over operating ambient temperature range (unless otherwise noted)

		MIN	MAX	UNIT
V_S	Supply voltage, $(V+) - (V-)$	2.7	40	V
V_I	Input voltage range	$(V-) - 0.1$	$(V+) + 0.1$	V
T_A	Specified ambient temperature	-55	125	°C

5.4 Thermal Information for Quad Channel

THERMAL METRIC ⁽¹⁾		OPA4H199-SP		UNIT
		DYY (SOT-23)		
		14 PINS		
$R_{\theta JA}$	Junction-to-ambient thermal resistance	121.6		°C/W
$R_{\theta JC(top)}$	Junction-to-case (top) thermal resistance	53.6		°C/W
$R_{\theta JB}$	Junction-to-board thermal resistance	47.8		°C/W
Ψ_{JT}	Junction-to-top characterization parameter	2.1		°C/W
Ψ_{JB}	Junction-to-board characterization parameter	47.6		°C/W
$R_{\theta JC(bot)}$	Junction-to-case (bottom) thermal resistance	N/A		°C/W

- (1) For more information about traditional and new thermal metrics, see the [Semiconductor and IC Package Thermal Metrics](#) application note.

5.5 Electrical Characteristics

For $V_S = (V+) - (V-) = 2.7V$ to $40V$ ($\pm 1.35V$ to $\pm 20V$) at $T_A = 25^\circ C$, $R_L = 10k\Omega$ connected to $V_S / 2$, $V_{CM} = V_S / 2$, $V_{O UT} = V_S / 2$, and the device is connected in a closed-loop feedback configuration unless otherwise noted.

PARAMETER		TEST CONDITIONS		MIN	TYP	MAX	UNIT
OFFSET VOLTAGE							
V_{OS}	Input offset voltage	$V_{CM} = V-$			± 125	± 895	μV
			$T_A = -55^\circ C$ to $125^\circ C$			± 925	
dV_{OS}/dT	Input offset voltage drift		$T_A = -55^\circ C$ to $125^\circ C$		± 0.3		$\mu V/^\circ C$
PSRR	Input offset voltage versus power supply	$V_{CM} = V-, V_S = 4V$ to $40V$	$T_A = -55^\circ C$ to $125^\circ C$		± 0.3	± 1	$\mu V/V$
		$V_{CM} = V-, V_S = 2.7V$ to $40V$			± 1	± 5	
	Channel separation	$f = 0Hz$			5		$\mu V/V$
INPUT BIAS CURRENT							
I_B	Input bias current				± 10		pA
I_{OS}	Input offset current				± 10		pA
NOISE							
E_N	Input voltage noise	$f = 0.1Hz$ to $10Hz$			1.8		μV_{PP}
					0.3		μV_{RMS}
e_N	Input voltage noise density	$f = 1kHz$			10.8		nV/\sqrt{Hz}
		$f = 10kHz$			9.4		
i_N	Input current noise	$f = 1kHz$			82		fA/\sqrt{Hz}
INPUT VOLTAGE RANGE							
V_{CM}	Common-mode voltage range			$(V-) - 0.1$		$(V+) + 0.1$	V
CMRR	Common-mode rejection ratio	$V_S = 40V, (V-) - 0.1V < V_{CM} < (V+) - 2V$ (Main input pair)	$T_A = -55^\circ C$ to $125^\circ C$		107	130	dB
		$V_S = 4V, (V-) - 0.1V < V_{CM} < (V+) - 2V$ (Main input pair)			82	100	
		$V_S = 2.7V, (V-) - 0.1V < V_{CM} < (V+) - 2V$ (Main input pair)			75	95	
		$V_S = 2.7V$ to $40V, (V+) - 1V < V_{CM} < (V+) + 0.1V$ (Aux input pair)				85	
INPUT CAPACITANCE							
Z_{ID}	Differential				$100 \parallel 9$		$M\Omega \parallel pF$
Z_{ICM}	Common-mode				$6 \parallel 1$		$T\Omega \parallel pF$
OPEN-LOOP GAIN							
A_{OL}	Open-loop voltage gain	$V_S = 40V, V_{CM} = V- (V-) + 0.1V < V_O < (V+) - 0.1V$	$T_A = -55^\circ C$ to $125^\circ C$		120	145	dB
						142	
		$V_S = 4V, V_{CM} = V- (V-) + 0.1V < V_O < (V+) - 0.1V$	$T_A = -55^\circ C$ to $125^\circ C$		104	130	
						125	
$V_S = 2.7V, V_{CM} = V- (V-) + 0.1V < V_O < (V+) - 0.1V$	$T_A = -55^\circ C$ to $125^\circ C$		101	120			
				118			

For $V_S = (V+) - (V-) = 2.7V$ to $40V$ ($\pm 1.35V$ to $\pm 20V$) at $T_A = 25^\circ C$, $R_L = 10k\Omega$ connected to $V_S / 2$, $V_{CM} = V_S / 2$, $V_{O\ UT} = V_S / 2$, and the device is connected in a closed-loop feedback configuration unless otherwise noted.

PARAMETER		TEST CONDITIONS	MIN	TYP	MAX	UNIT
FREQUENCY RESPONSE						
GBW	Gain-bandwidth product			4.5		MHz
SR	Slew rate	$V_S = 40V$, $G = +1$, $C_L = 20pF$		21		V/ μs
t_s	Settling time	To 0.01%, $V_S = 40V$, $V_{STEP} = 10V$, $G = +1$, $C_L = 20pF$		2.5		μs
		To 0.01%, $V_S = 40V$, $V_{STEP} = 2V$, $G = +1$, $C_L = 20pF$		1.5		
		To 0.1%, $V_S = 40V$, $V_{STEP} = 10V$, $G = +1$, $C_L = 20pF$		2		
		To 0.1%, $V_S = 40V$, $V_{STEP} = 2V$, $G = +1$, $C_L = 20pF$		1		
	Phase margin	$G = +1$, $R_L = 10k\Omega$, $C_L = 20pF$		60		$^\circ$
	Overload recovery time	$V_{IN} \times \text{gain} > V_S$		400		ns
THD+N	Total harmonic distortion + noise ⁽¹⁾	$V_S = 40V$, $V_O = 3V_{RMS}$, $G = 1$, $f = 1kHz$		0.00021%		
OUTPUT						
	Voltage output swing from rail	Positive and negative rail headroom	$V_S = 40V$, $R_L = \text{no load}$	5	10	mV
			$V_S = 40V$, $R_L = 10k\Omega$	50	70	
			$V_S = 40V$, $R_L = 2k\Omega$	300	350	
			$V_S = 2.7V$, $R_L = \text{no load}$	1	6	
			$V_S = 2.7V$, $R_L = 10k\Omega$	5	12	
			$V_S = 2.7V$, $R_L = 2k\Omega$	25	40	
I_{SC}	Short-circuit current			± 75		mA
C_{LOAD}	Capacitive load drive			1000		pF
Z_O	Open-loop output impedance	$f = 1MHz$, $I_O = 0A$		525		Ω
POWER SUPPLY						
I_Q	Quiescent current per amplifier	$V_{CM} = V_-$, $I_O = 0A$		560	685	μA
			$T_A = -55^\circ C$ to $125^\circ C$		750	

(1) Third-order filter; bandwidth = 80kHz at -3dB.

5.6 Typical Characteristics

at $T_A = 25^\circ\text{C}$, $V_S = \pm 20\text{V}$, $V_{CM} = V_S / 2$, $R_{LOAD} = 10\text{k}\Omega$ connected to $V_S / 2$, and $C_L = 10\text{pF}$ (unless otherwise noted)

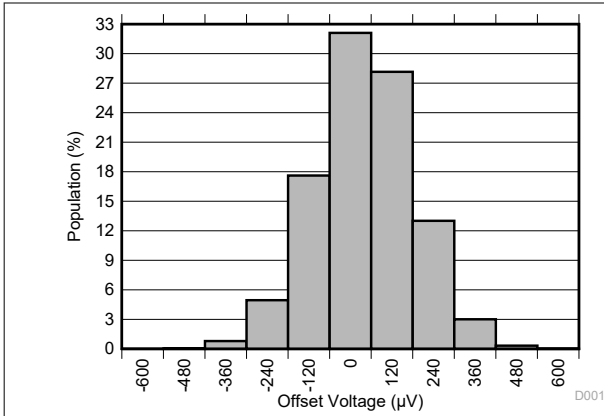

Distribution from 15462 amplifiers, $T_A = 25^\circ\text{C}$

5-1. Offset Voltage Production Distribution

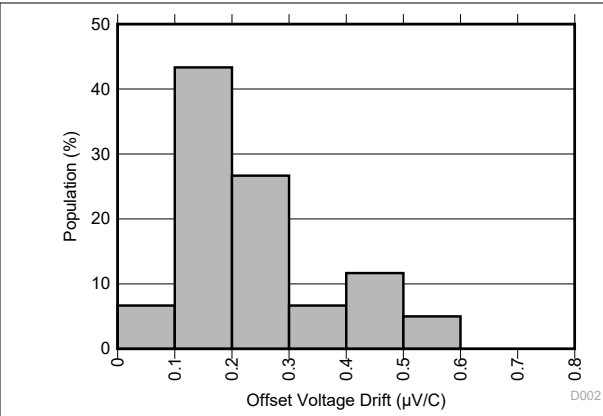

Distribution from 60 amplifiers

5-2. Offset Voltage Drift Distribution

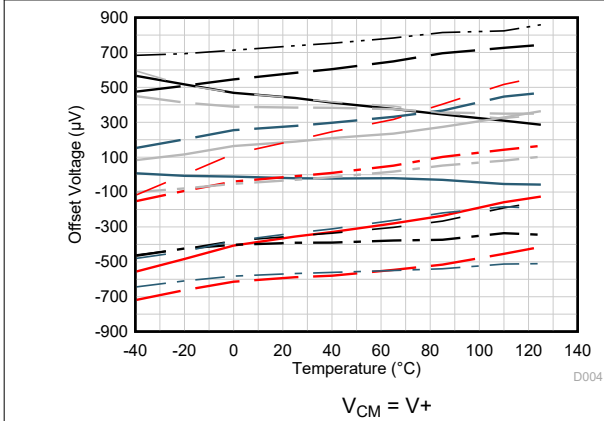

5-3. Offset Voltage vs Temperature

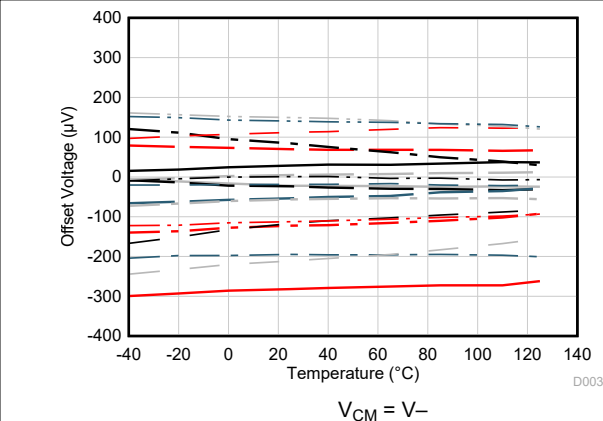

5-4. Offset Voltage vs Temperature

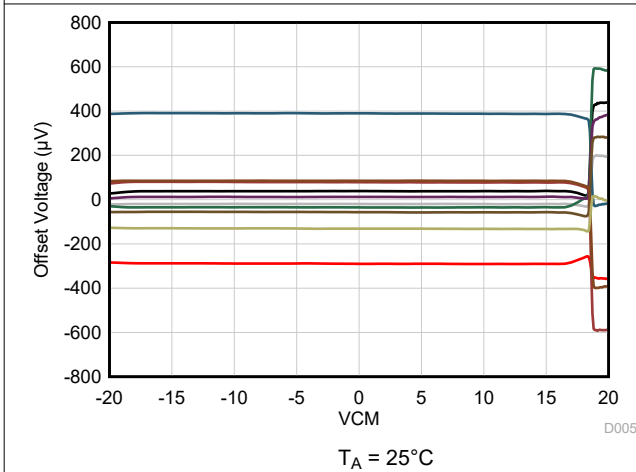

5-5. Offset Voltage vs Common-Mode Voltage

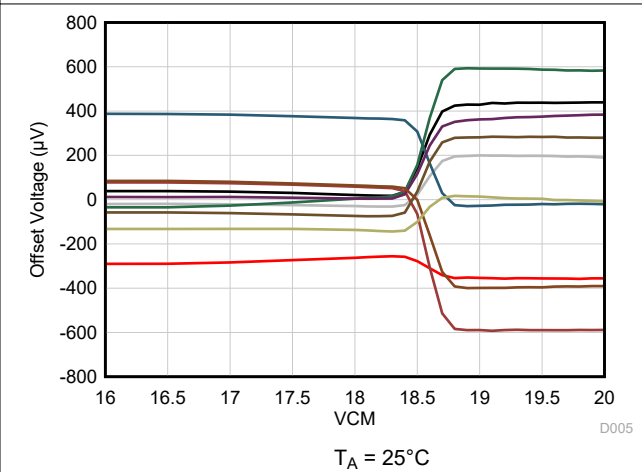

5-6. Offset Voltage vs Common-Mode Voltage (Transition Region)

5.6 Typical Characteristics (continued)

at $T_A = 25^\circ\text{C}$, $V_S = \pm 20\text{V}$, $V_{CM} = V_S / 2$, $R_{LOAD} = 10\text{k}\Omega$ connected to $V_S / 2$, and $C_L = 10\text{pF}$ (unless otherwise noted)

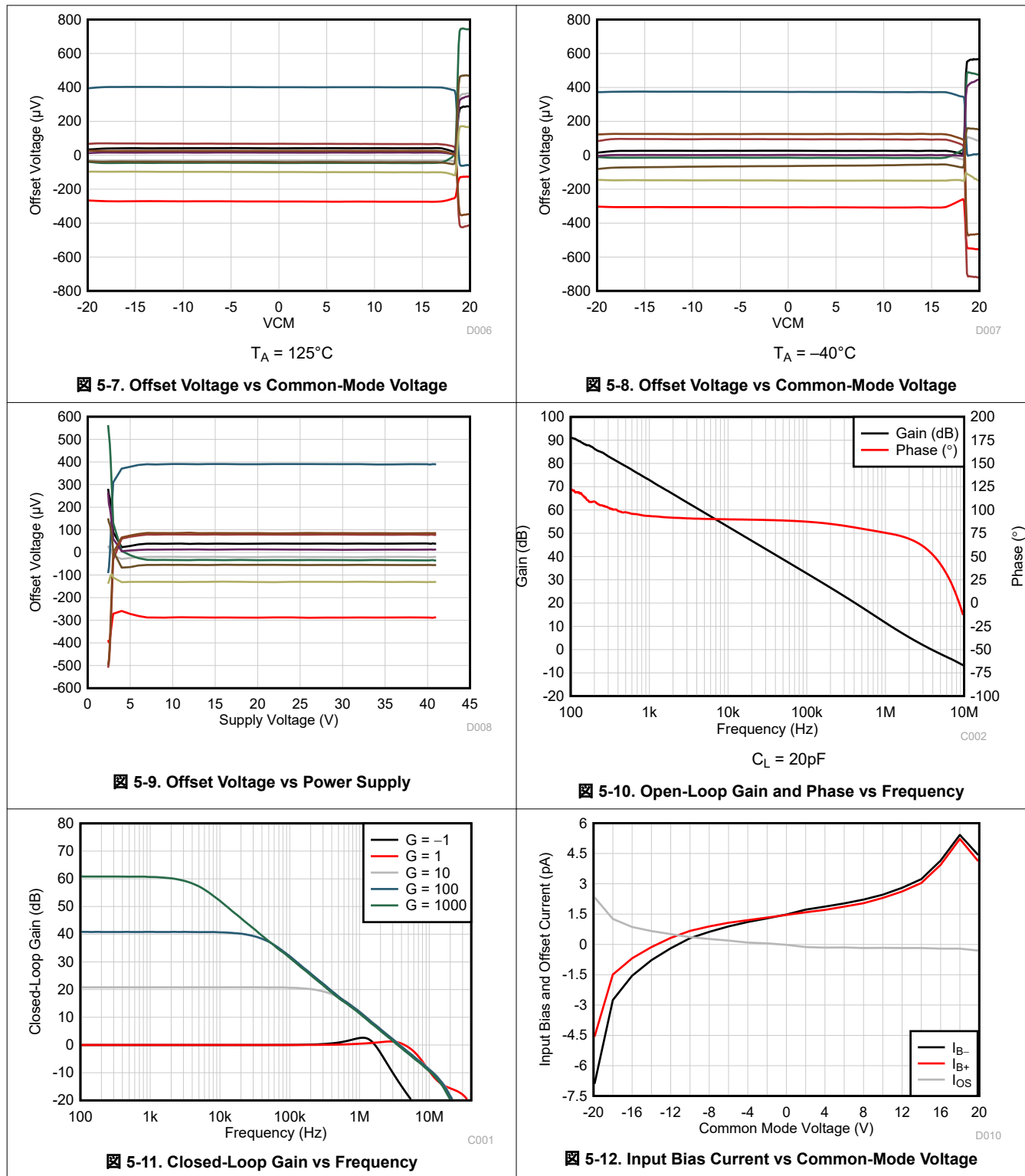

5.6 Typical Characteristics (continued)

at $T_A = 25^\circ\text{C}$, $V_S = \pm 20\text{V}$, $V_{CM} = V_S / 2$, $R_{LOAD} = 10\text{k}\Omega$ connected to $V_S / 2$, and $C_L = 10\text{pF}$ (unless otherwise noted)

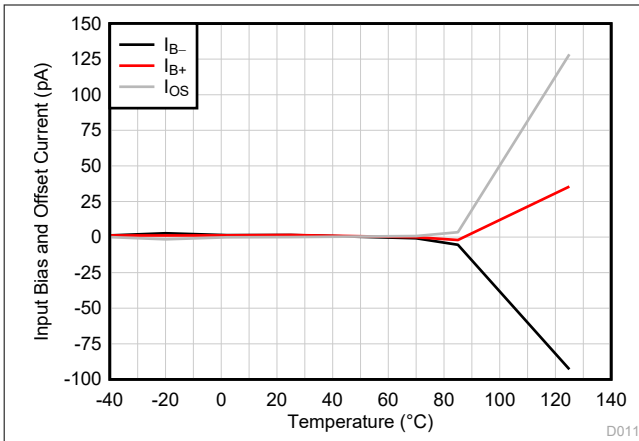

Figure 5-13. Input Bias Current vs Temperature

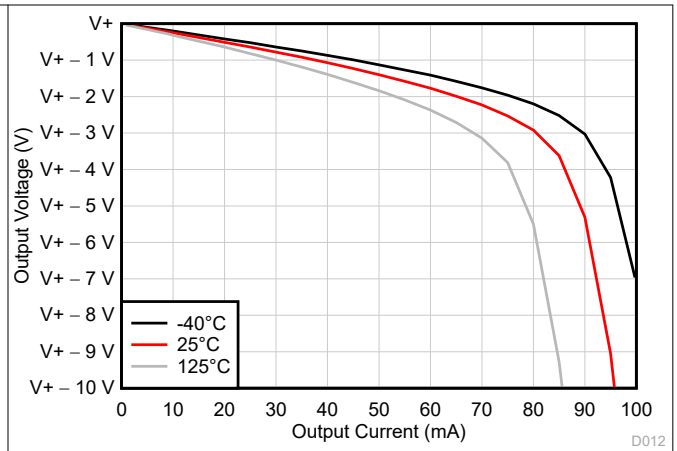

Figure 5-14. Output Voltage Swing vs Output Current (Sourcing)

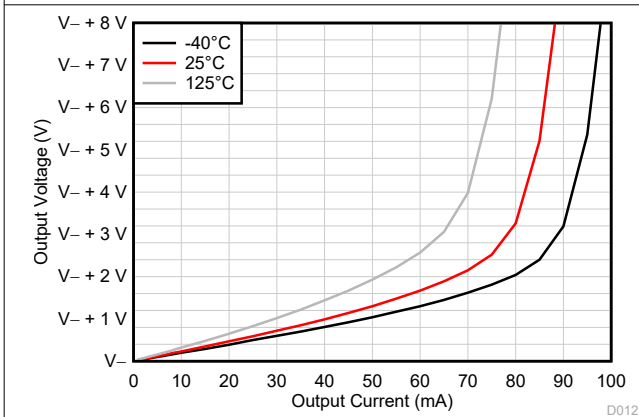

Figure 5-15. Output Voltage Swing vs Output Current (Sinking)

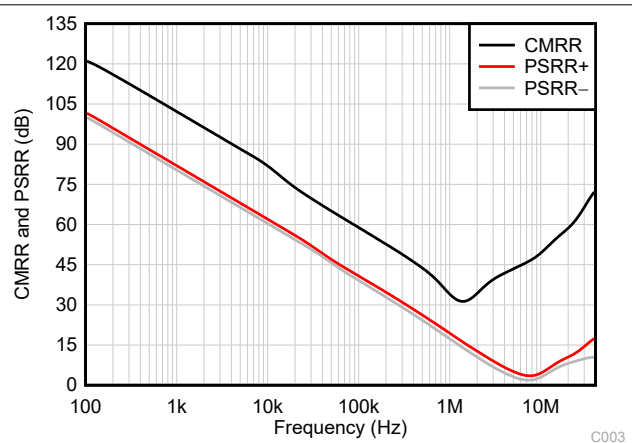

Figure 5-16. CMRR and PSRR vs Frequency

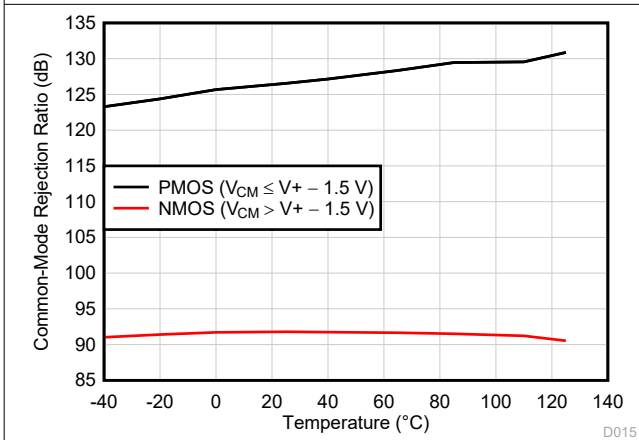

Figure 5-17. CMRR vs Temperature (dB)

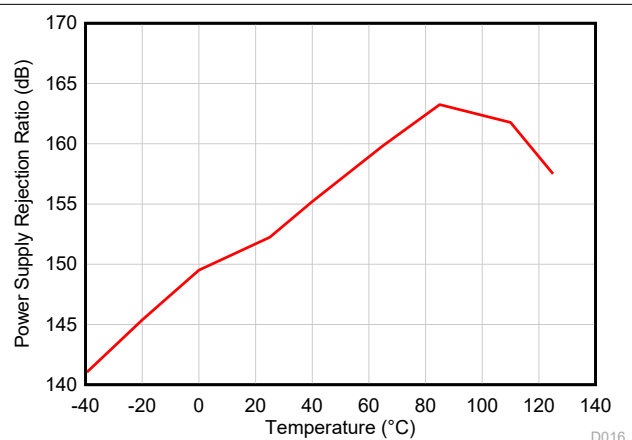
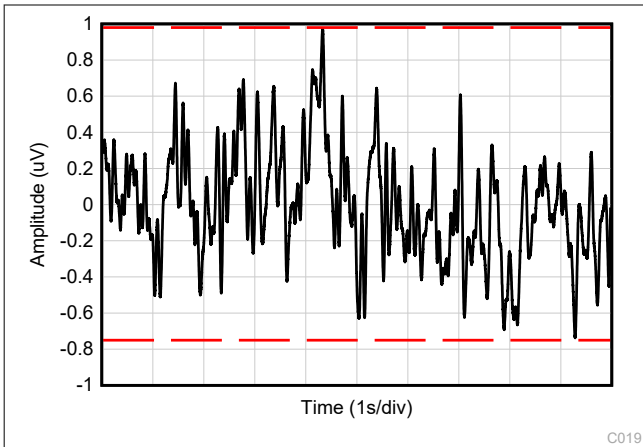

Figure 5-18. PSRR vs Temperature (dB)

5.6 Typical Characteristics (continued)

at $T_A = 25^\circ\text{C}$, $V_S = \pm 20\text{V}$, $V_{CM} = V_S / 2$, $R_{LOAD} = 10\text{k}\Omega$ connected to $V_S / 2$, and $C_L = 10\text{pF}$ (unless otherwise noted)



5-19. 0.1Hz to 10Hz Noise

C019

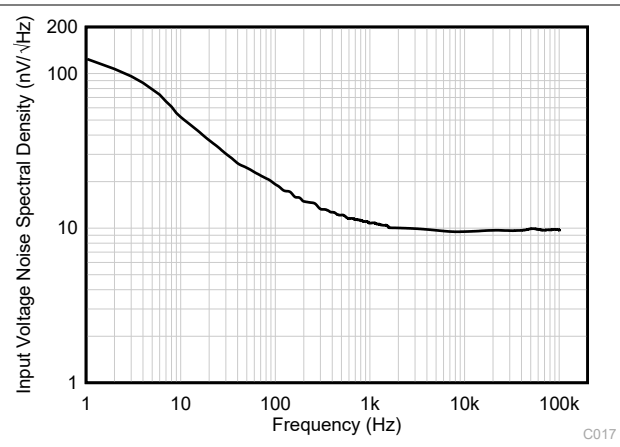

5-20. Input Voltage Noise Spectral Density vs Frequency

C017

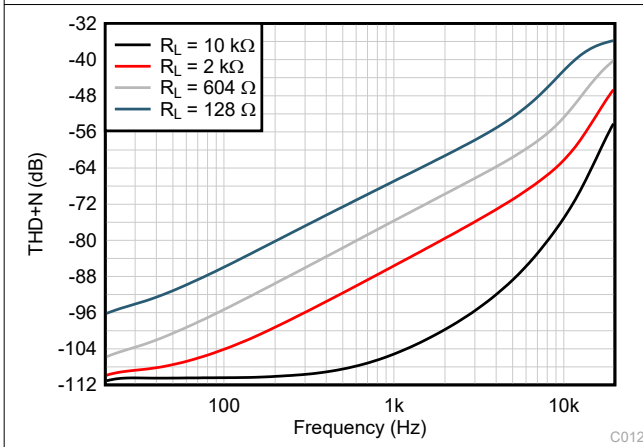

5-21. THD+N Ratio vs Frequency

C012

BW = 80kHz, $V_{OUT} = 1V_{RMS}$

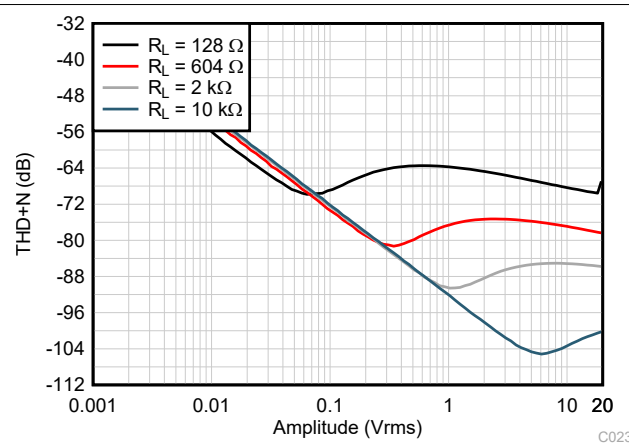

5-22. THD+N vs Output Amplitude

C023

BW = 80kHz, $f = 1\text{kHz}$

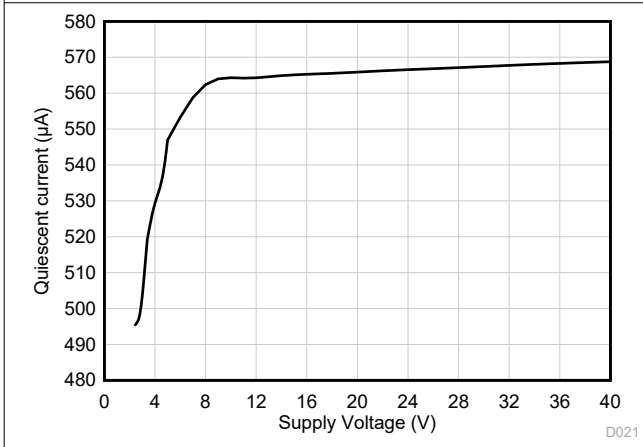

5-23. Quiescent Current vs Supply Voltage

D021

$V_{CM} = V_-$

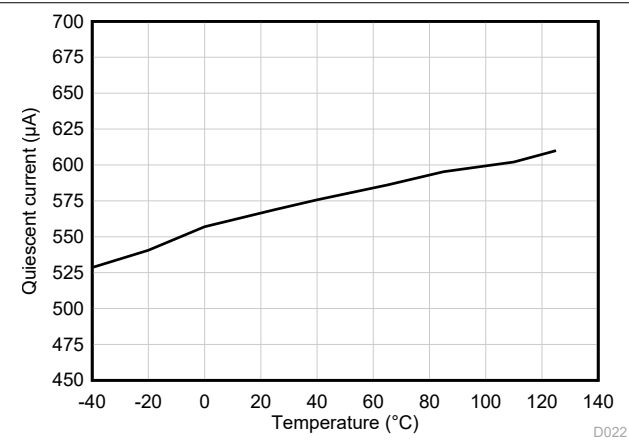

5-24. Quiescent Current vs Temperature

D022

5.6 Typical Characteristics (continued)

at $T_A = 25^\circ\text{C}$, $V_S = \pm 20\text{V}$, $V_{CM} = V_S / 2$, $R_{LOAD} = 10\text{k}\Omega$ connected to $V_S / 2$, and $C_L = 10\text{pF}$ (unless otherwise noted)

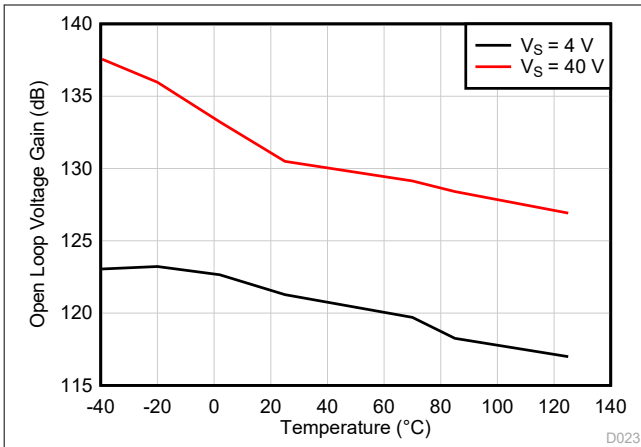

5-25. Open-Loop Voltage Gain vs Temperature (dB)

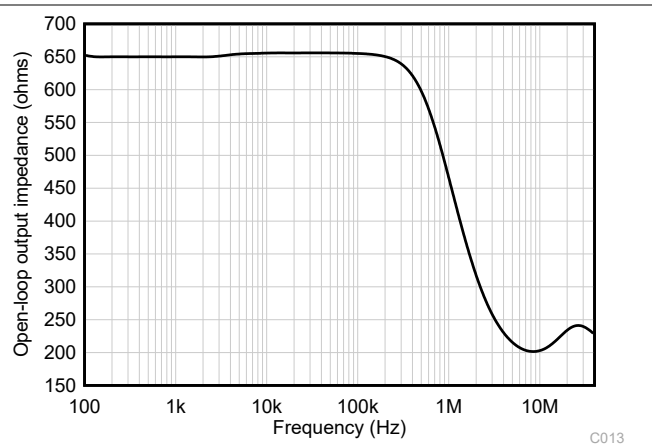

5-26. Open-Loop Output Impedance vs Frequency

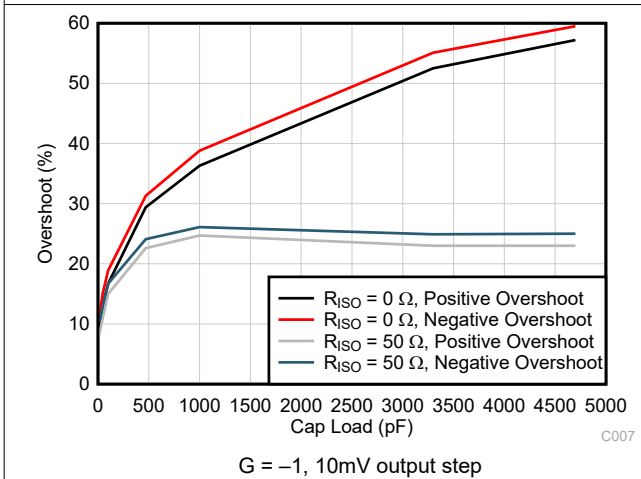

5-27. Small-Signal Overshoot vs Capacitive Load

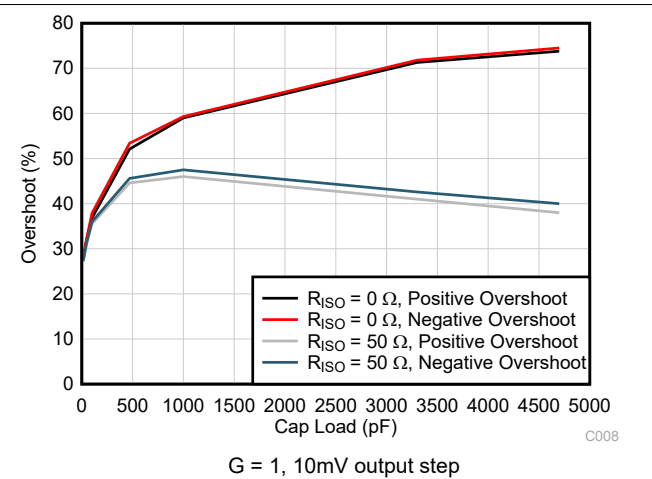

5-28. Small-Signal Overshoot vs Capacitive Load

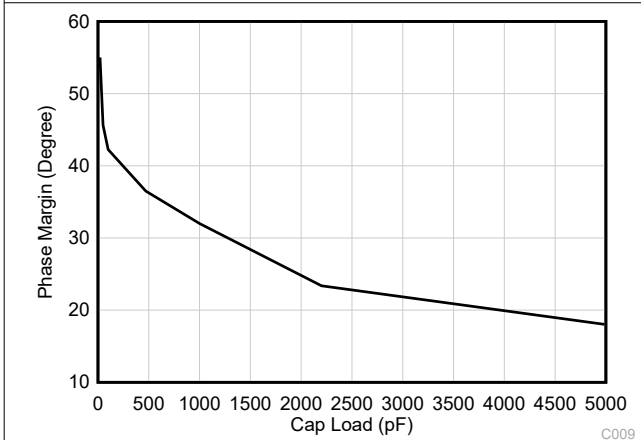

5-29. Phase Margin vs Capacitive Load

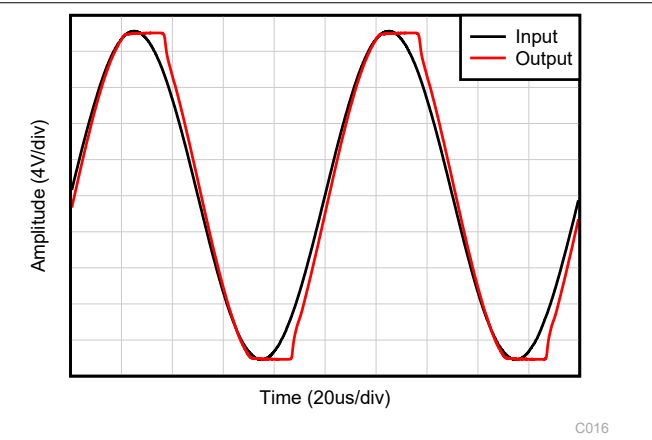

5-30. No Phase Reversal

5.6 Typical Characteristics (continued)

at $T_A = 25^\circ\text{C}$, $V_S = \pm 20\text{V}$, $V_{CM} = V_S / 2$, $R_{LOAD} = 10\text{k}\Omega$ connected to $V_S / 2$, and $C_L = 10\text{pF}$ (unless otherwise noted)

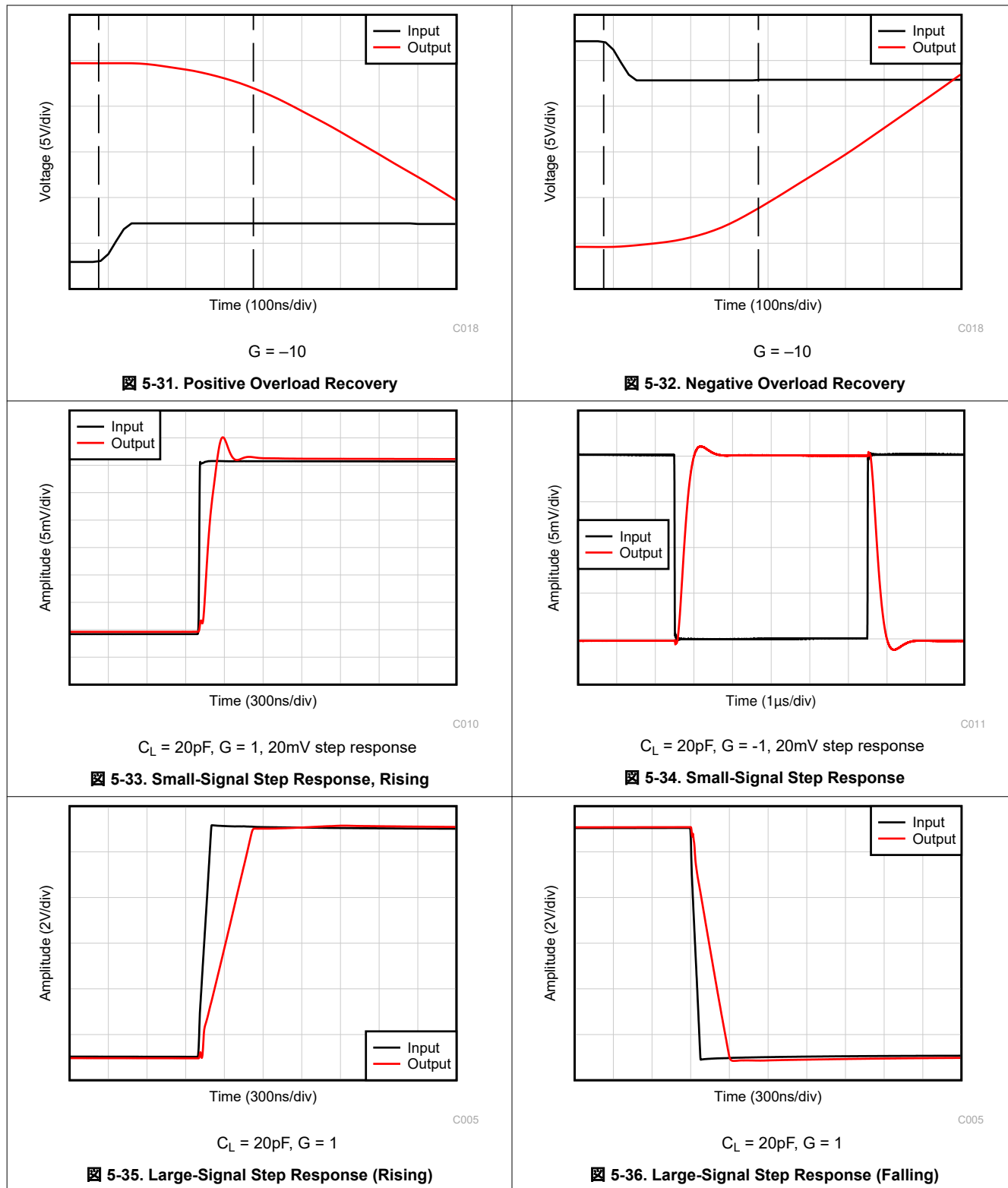

5.6 Typical Characteristics (continued)

at $T_A = 25^\circ\text{C}$, $V_S = \pm 20\text{V}$, $V_{CM} = V_S / 2$, $R_{LOAD} = 10\text{k}\Omega$ connected to $V_S / 2$, and $C_L = 10\text{pF}$ (unless otherwise noted)

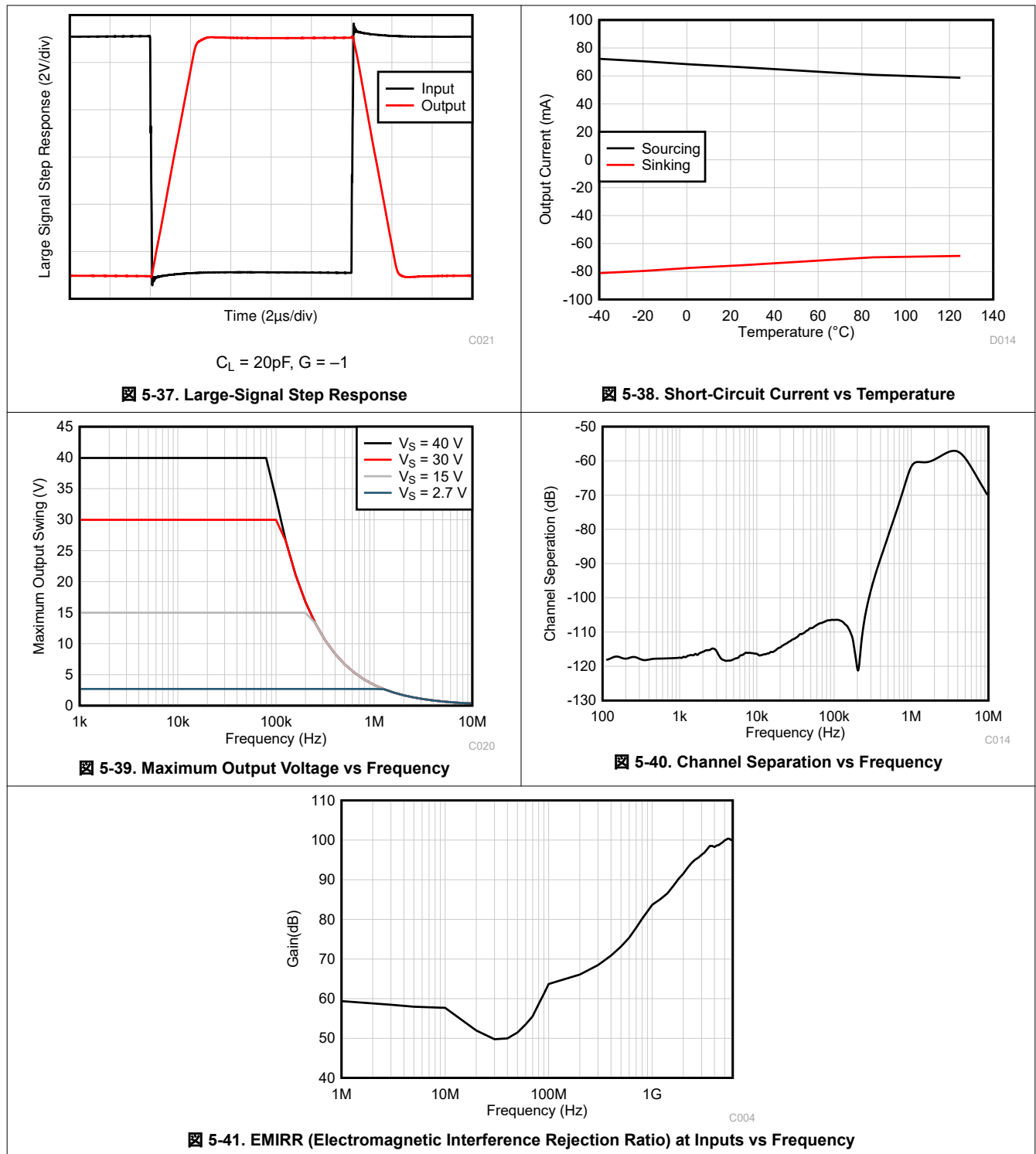

6 Detailed Description

6.1 Overview

The OPA4H199-SP is a 40V general purpose operational amplifier.

This device offers excellent DC precision and AC performance, including rail-to-rail input/output, low offset ($\pm 125\mu\text{V}$, typical), low offset drift ($\pm 0.3\mu\text{V}/^\circ\text{C}$, typical), and 4.5MHz bandwidth.

Unique features, such as differential and common-mode input-voltage range to the supply rail, high output current ($\pm 75\text{mA}$), and high slew rate ($21\text{V}/\mu\text{s}$), make the OPA4H199-SP a robust, high-performance operational amplifier for high-voltage space applications.

6.2 Functional Block Diagram

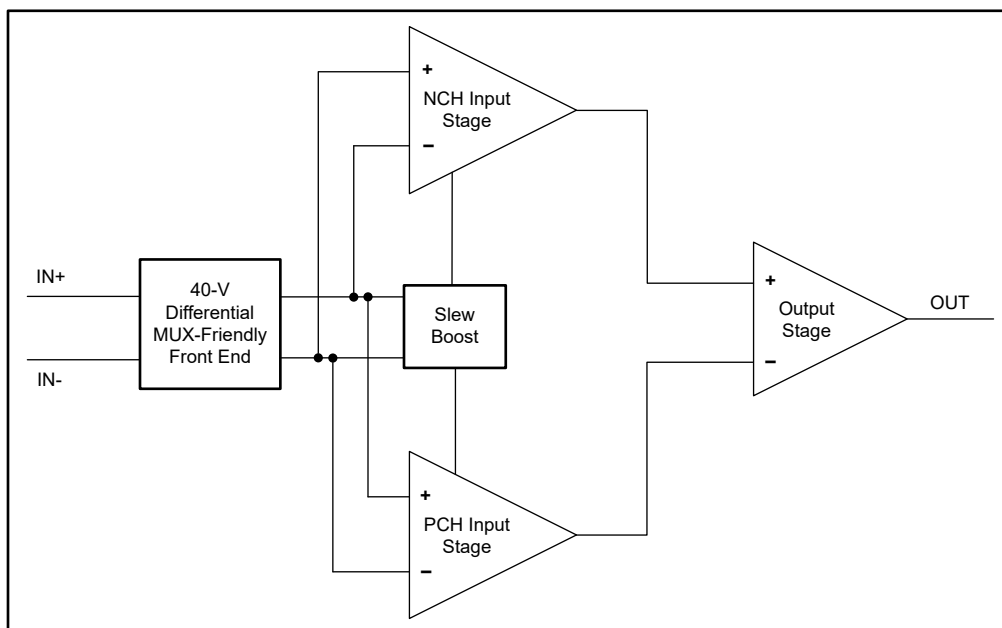

6.3 Feature Description

6.3.1 Input Protection Circuitry

The OPA4H199-SP uses a unique input architecture to eliminate the requirement for input protection diodes, but still provides robust input protection under transient conditions. [Figure 6-1](#) shows conventional input diode protection schemes that are activated by fast transient step responses and introduce signal distortion and settling time delays because of alternate current paths, as shown in [Figure 6-2](#). For low-gain circuits, these fast-ramping input signals forward-bias back-to-back diodes, causing an increase in input current and resulting in extended settling time.

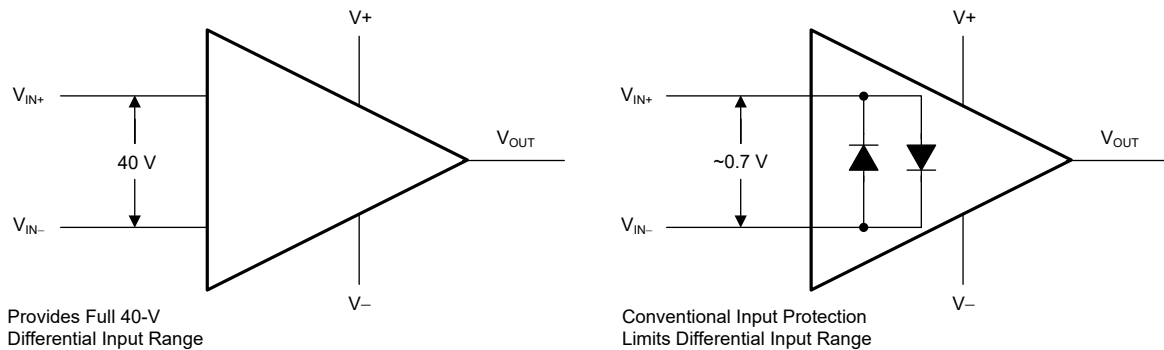

Figure 6-1. OPA4H199-SP Input Protection Does Not Limit Differential Input Capability

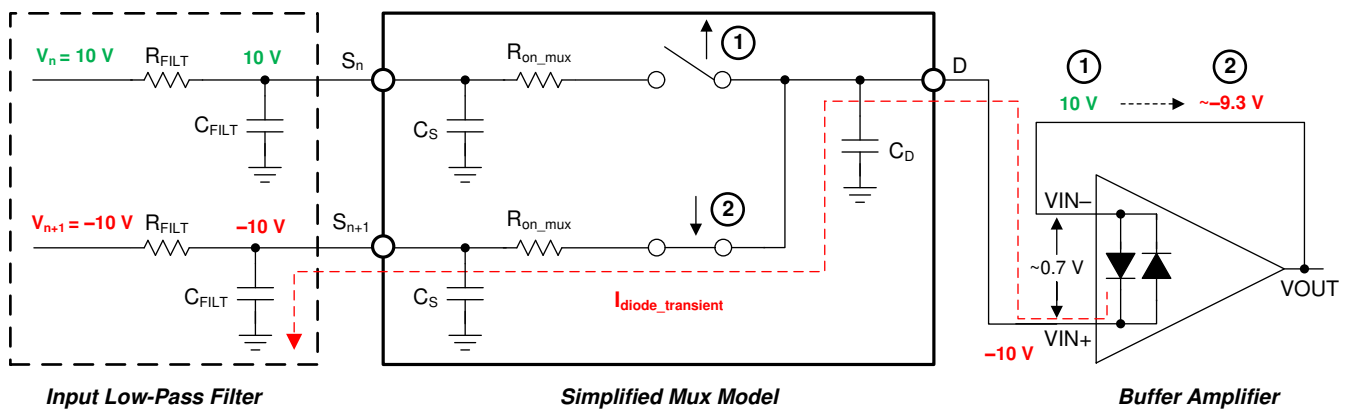

Figure 6-2. Back-to-Back Diodes Create Settling Issues

The OPA4H199-SP provides a true high-impedance differential input capability for high-voltage applications using a patented input protection architecture that does not introduce additional signal distortion or delayed settling time, making the device an excellent choice as op amp for multichannel, high-switched, input applications. The OPA4H199-SP tolerates a maximum differential swing (voltage between inverting and noninverting pins of the op amp) of up to 40V, so the device can be used as a comparator or in applications with fast-ramping input signals such as data-acquisition systems. See the [MUX-Friendly Precision Operational Amplifiers](#) application brief for more information.

6.3.2 EMI Rejection

The OPA4H199-SP uses integrated electromagnetic interference (EMI) filtering to reduce the effects of EMI from sources such as wireless communications and densely-populated boards with a mix of analog signal chain and digital components. EMI immunity can be improved with circuit design techniques; the OPA4H199-SP benefits from these design improvements. Texas Instruments has developed the ability to accurately measure and quantify the immunity of an operational amplifier over a broad frequency spectrum extending from 10MHz to 6GHz. [Figure 6-3](#) shows the results of this testing on the OPA4H199-SP. [Table 6-1](#) shows the EMIRR IN+ values for the

OPA4H199-SP at particular frequencies commonly encountered in real-world applications. The [EMI Rejection Ratio of Operational Amplifiers](#) application report contains detailed information on the topic of EMIRR performance as it relates to op amps and is available for download from www.ti.com.



図 6-3. EMIRR Testing

表 6-1. OPA4H199-SP EMIRR IN+ for Frequencies of Interest

FREQUENCY	APPLICATION OR ALLOCATION	EMIRR IN+
400MHz	Mobile radio, mobile satellite, space operation, weather, radar, ultra-high frequency (UHF) applications	73.2dB
900MHz	Global system for mobile communications (GSM) applications, radio communication, navigation, GPS (to 1.6GHz), GSM, aeronautical mobile, UHF applications	82.5dB
1.8GHz	GSM applications, mobile personal communications, broadband, satellite, L-band (1GHz to 2GHz)	89.7dB
2.4GHz	802.11b, 802.11g, 802.11n, Bluetooth®, mobile personal communications, industrial, scientific and medical (ISM) radio band, amateur radio and satellite, S-band (2GHz to 4GHz)	93.9dB
3.6GHz	Radiolocation, aero communication and navigation, satellite, mobile, S-band	95.7dB
5GHz	802.11a, 802.11n, aero communication and navigation, mobile communication, space and satellite operation, C-band (4GHz to 8GHz)	98.0dB

6.3.3 Thermal Protection

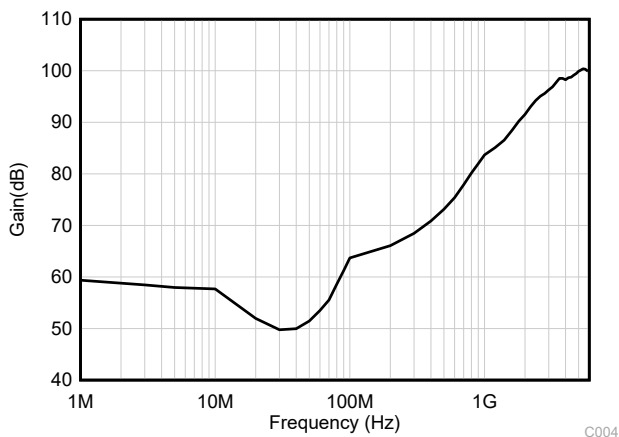
The internal power dissipation of any amplifier causes the internal (junction) temperature to rise. This phenomenon is called *self heating*. The absolute maximum junction temperature of the OPA4H199-SP is 150°C. Exceeding this temperature causes damage to the device. The OPA4H199-SP has a thermal protection feature that reduces damage from self heating. The protection works by monitoring the temperature of the device and turning off the op amp output drive for temperatures above 170°C. Figure 6-4 shows an application example for the OPA4H199-SP that has significant self heating because of the power dissipation (0.81W). Thermal calculations indicate that for an ambient temperature of 65°C, the device junction temperature can reach 177°C. The actual device, however, turns off the output drive to recover towards a safe junction temperature. Figure 6-4 shows how the circuit behaves during thermal protection. During normal operation, the device acts as a buffer so the output is 3V. When self heating causes the device junction temperature to increase above the internal limit, the thermal protection forces the output to a high-impedance state and the output is pulled to ground through resistor R_L . If the condition that caused excessive power dissipation is not removed, then the amplifier can oscillate between a shutdown and enabled state until the output fault is corrected.



图 6-4. Thermal Protection

If the device continues to operate at high junction temperatures with high output power over a long period of time, regardless if the device is or is not entering thermal shutdown, the thermal dissipation of the device can slowly degrade performance of the device and eventually cause catastrophic destruction. Designers must be careful to limit output power of the device at high temperatures, or control ambient and junction temperatures under high output power conditions.

6.3.4 Capacitive Load and Stability

The OPA4H199-SP features a resistive output stage capable of driving moderate capacitive loads, and by leveraging an isolation resistor, the device can easily be configured to drive large capacitive loads. Increasing the gain enhances the ability of the amplifier to drive greater capacitive loads (see Figure 6-5 and Figure 6-6). The particular op amp circuit configuration, layout, gain, and output loading are some of the factors to consider when establishing whether an amplifier can be stable in operation.

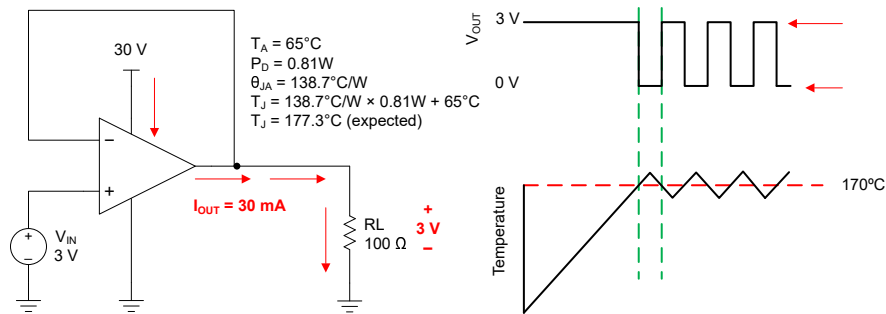
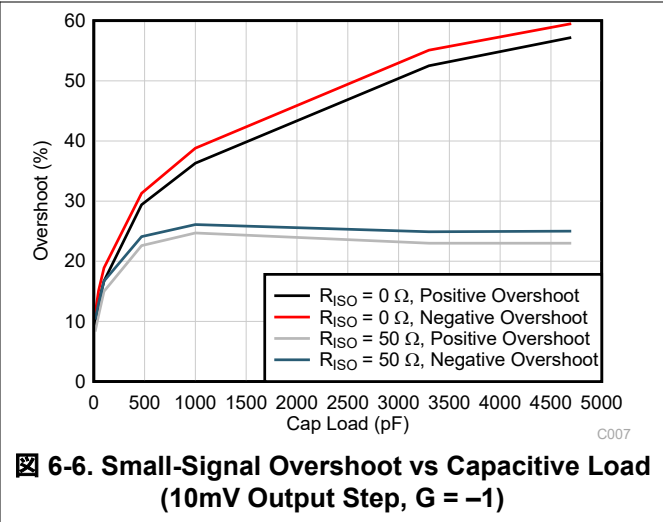
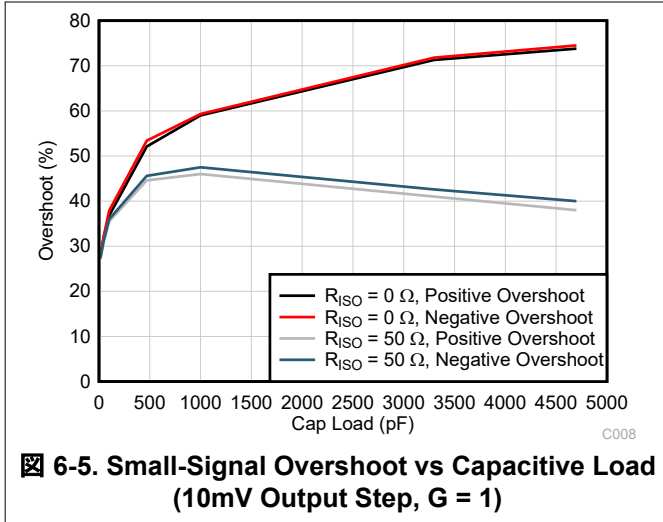

For additional drive capability in unity-gain configurations, improve capacitive load drive by inserting a small resistor, R_{ISO} , in series with the output, as shown in 6-7. This resistor significantly reduces ringing and maintains DC performance for purely capacitive loads. However, if a resistive load is in parallel with the capacitive load, then a voltage divider is created, thus introducing a gain error at the output and slightly reducing the output swing. The error introduced is proportional to the ratio R_{ISO} / R_L , and is generally negligible at low output levels. A high capacitive load drive makes the OPA4H199-SP an excellent choice for applications such as reference buffers, MOSFET gate drives, and cable-shield drives. The circuit shown in 6-7 uses an isolation resistor, R_{ISO} , to stabilize the output of an op amp. R_{ISO} modifies the open-loop gain of the system for increased phase margin.

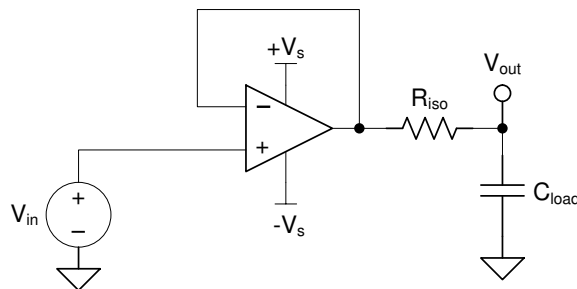

6-7. Extending Capacitive Load Drive With the OPA4H199-SP

6.3.5 Common-Mode Voltage Range

The OPA4H199-SP is a 40V, true rail-to-rail input operational amplifier with an input common-mode range that extends 100mV beyond either supply rail. This wide range is achieved with paralleled complementary N-channel and P-channel differential input pairs, as shown in [Figure 6-8](#). The N-channel pair is active for input voltages close to the positive rail, typically $(V+) - 1V$ to 100mV above the positive supply. The P-channel pair is active for inputs from 100mV below the negative supply to approximately $(V+) - 2V$. There is a small transition region, typically $(V+) - 2V$ to $(V+) - 1V$ in which both input pairs are turned on. This transition region can vary modestly with process variation, and within this region PSRR, CMRR, offset voltage, offset drift, noise, and THD performance can be degraded compared to operation outside this region.

[Figure 5-5](#) shows this transition region for a typical device in terms of input voltage offset in more detail.

For more information on common-mode voltage range and PMOS/NMOS pair interaction, see the [Op amps with complementary-pair input stages: What are the design trade-offs?](#) Analog Design Journal.

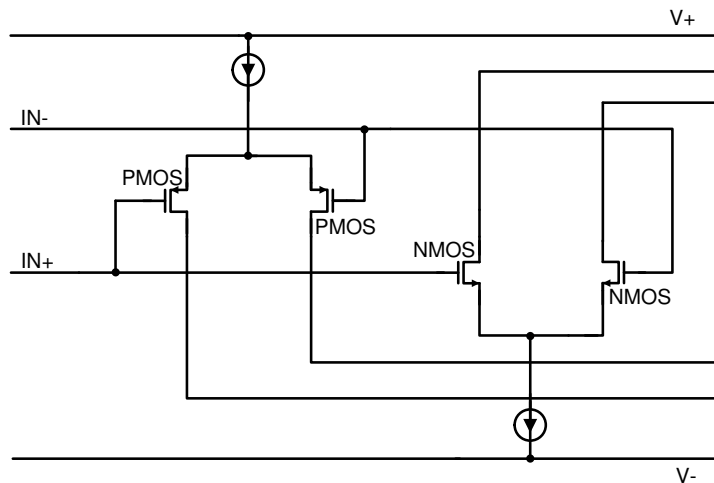

Figure 6-8. Rail-to-Rail Input Stage

6.3.6 Phase Reversal Protection

The OPA4H199-SP family has internal phase-reversal protection. Many op amps exhibit phase reversal when the input is driven beyond the linear common-mode range. This condition is most often encountered in non-inverting circuits when the input is driven beyond the specified common-mode voltage range, causing the output to reverse into the opposite rail. The OPA4H199-SP is a rail-to-rail input op amp; therefore, the common-mode range can extend beyond the rails. Input signals beyond the rails do not cause phase reversal; instead, the output limits into the appropriate rail. This performance is shown in [Figure 6-9](#). For more information on phase reversal, see the [Op amps with complementary-pair input stages: What are the design trade-offs?](#) Analog Design Journal.



图 6-9. No Phase Reversal

6.3.7 Electrical Overstress

Designers often ask questions about the capability of an operational amplifier to withstand electrical overstress (EOS). These questions tend to focus on the device inputs, but can involve the supply voltage pins or even the output pin. Each of these different pin functions have electrical stress limits determined by the voltage breakdown characteristics of the particular semiconductor fabrication process and specific circuits connected to the pin. Additionally, internal electrostatic discharge (ESD) protection is built into these circuits to protect them from accidental ESD events both before and during product assembly.

Having a good understanding of this basic ESD circuitry and the relevance to an electrical overstress event is helpful. 图 6-10 shows an illustration of the ESD circuits contained in the OPA4H199-SP (indicated by the dashed line area). The ESD protection circuitry involves several current-steering diodes connected from the input and output pins and routed back to the internal power-supply lines, where the diodes meet at an absorption device or the power-supply ESD cell, internal to the operational amplifier. This protection circuitry is intended to remain inactive during normal circuit operation.

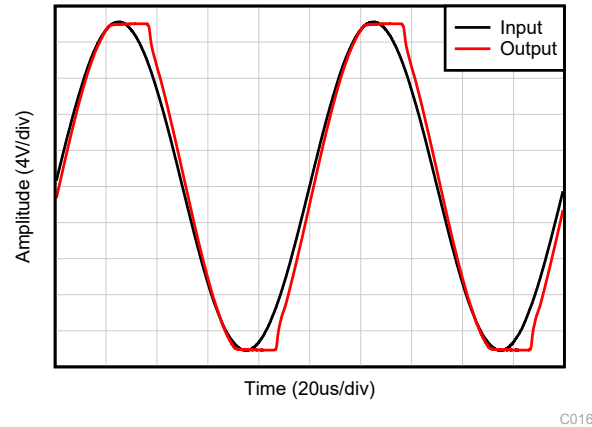
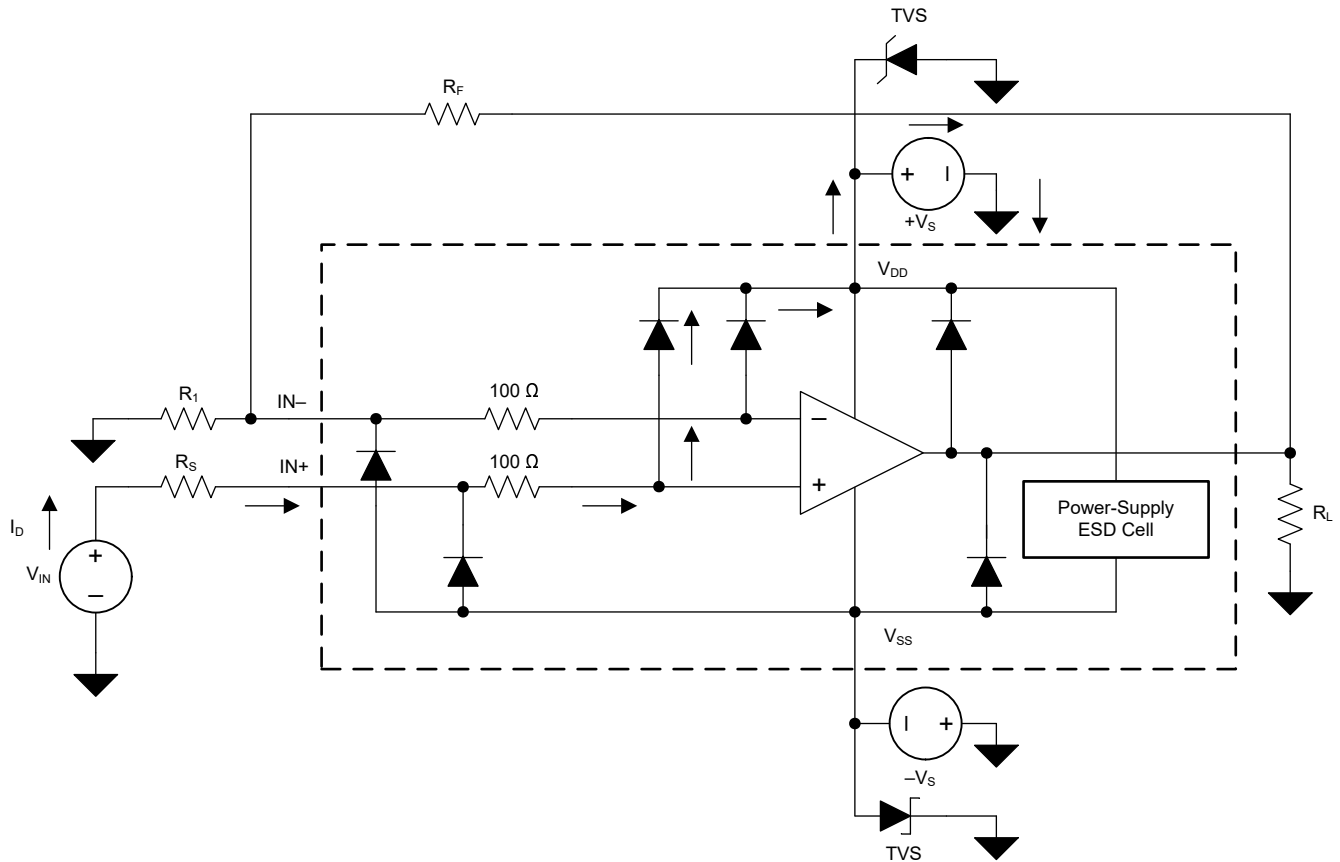

6-10. Equivalent Internal ESD Circuitry Relative to a Typical Circuit Application

An ESD event is very short in duration and very high voltage (for example; 1kV, 100ns), whereas an EOS event is long duration and lower voltage (for example; 50V, 100ms). The ESD diodes are designed for out-of-circuit ESD protection (that is, during assembly, test, and storage of the device before being soldered to the PCB). During an ESD event, the ESD signal is passed through the ESD steering diodes to an absorption circuit (labeled ESD power-supply circuit). The ESD absorption circuit clamps the supplies to a safe level.

Although this behavior is necessary for out-of-circuit protection, excessive current and damage is caused if activated in-circuit. A transient voltage suppressors (TVS) can be used to prevent against damage caused by turning on the ESD absorption circuit during an in-circuit ESD event. Using the appropriate current limiting resistors and TVS diodes allows for the use of device ESD diodes to protect against EOS events.

6.3.8 Overload Recovery

Overload recovery is defined as the time required for the op amp output to recover from a saturated state to a linear state. The output devices of the op amp enter a saturation region when the output voltage exceeds the rated operating voltage, either due to the high input voltage or the high gain. After the device enters the saturation region, the charge carriers in the output devices require time to return back to the linear state. After the charge carriers return back to the linear state, the device begins to slew at the specified slew rate. Thus, the propagation delay in case of an overload condition is the sum of the overload recovery time and the slew time. The overload recovery time for the OPA4H199-SP is approximately 400ns.

6.3.9 Typical Specifications and Distributions

Designers often have questions about a typical specification of an amplifier to design a more robust circuit. Due to natural variation in process technology and manufacturing procedures, every specification of an amplifier exhibits some amount of deviation from the proper value, like an input offset voltage of the amplifier. These deviations often follow *Gaussian* (bell curve), or *normal* distributions, and circuit designers can leverage this information to guardband their system, even when there is not a minimum or maximum specification in [Electrical Characteristics](#).



图 6-11. Ideal Gaussian Distribution

图 6-11 shows an example distribution, where μ , or *mu*, is the mean of the distribution, and where σ , or *sigma*, is the standard deviation of a system. For a specification that exhibits this kind of distribution, approximately two-thirds (68.26%) of all units can be expected to have a value within one standard deviation, or one sigma, of the mean (from $\mu - \sigma$ to $\mu + \sigma$).

Depending on the specification, values listed in the *typical* column of the [Electrical Characteristics](#) are represented in different ways. General guidance suggests that if a specification naturally has a nonzero mean (for example, like gain bandwidth), then the typical value is equal to the mean (μ). However, if a specification naturally has a mean near zero (like input offset voltage), then the typical value is equal to the mean plus one standard deviation ($\mu + \sigma$) to most accurately represent the typical value.

You can use this chart to calculate approximate probability of a specification in a unit; for example, for OPA4H199-SP, the typical input voltage offset is 125 μ V, so 68.2% of all OPA4H199-SP devices are expected to

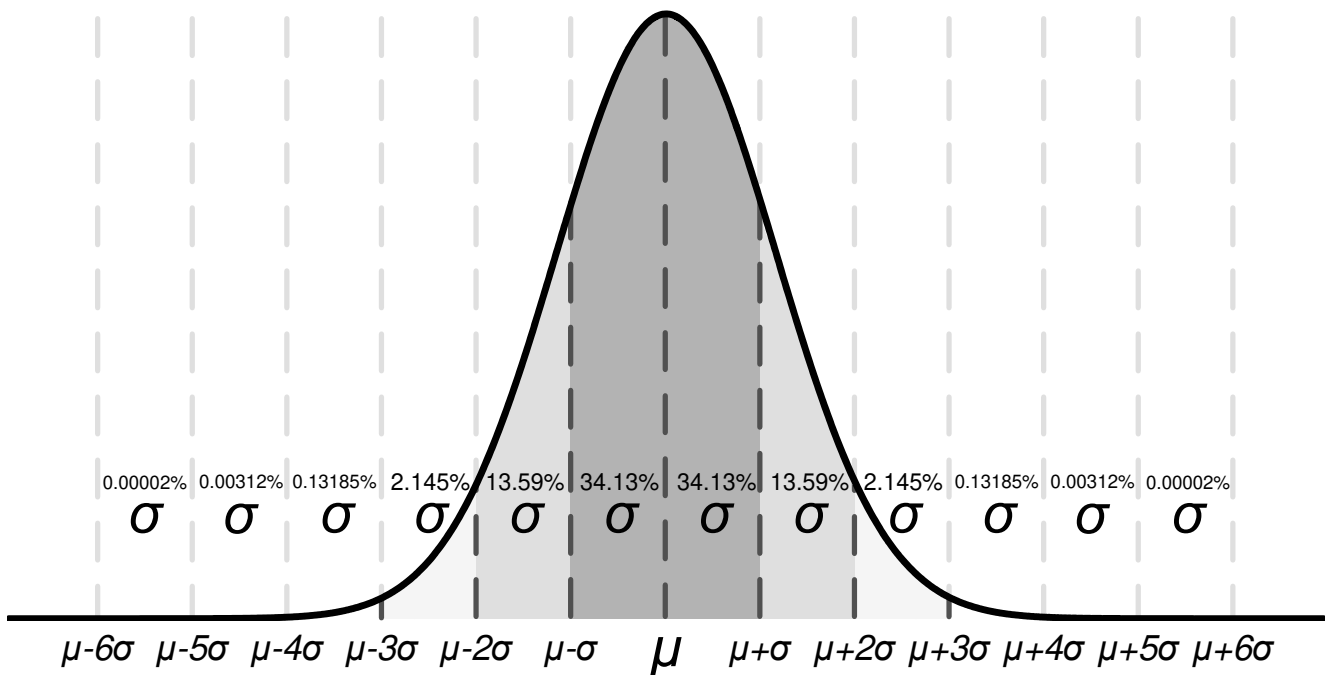
have an offset from $-125\mu\text{V}$ to $125\mu\text{V}$. At 4σ ($\pm 500\mu\text{V}$), 99.9937% of the distribution has an offset voltage less than $\pm 500\mu\text{V}$, which means 0.0063% of the population is outside of these limits, which corresponds to about 1 in 15,873 units.

TI verifies specifications with a value in the minimum or maximum column, and units outside these limits are removed from production material. For example, the OPA4H199-SP family has a maximum offset voltage of $895\mu\text{V}$ at 25°C , and even though this corresponds to more than 5σ (approximately 1 in 1.7 million units), which is extremely unlikely, TI specifies that any unit with larger offset than $895\mu\text{V}$ is removed from production material.

For specifications with no value in the minimum or maximum column, consider selecting a sigma value of sufficient guardband for your application, and design worst-case conditions using this value. For example, the 6σ value corresponds to approximately 1 in 500 million units, which is an extremely unlikely chance, and can be an option as a wide guardband to design a system around. In this case, the OPA4H199-SP family does not have a maximum or minimum for offset voltage drift, but based on [Figure 5-2](#) and the typical value of $0.3\mu\text{V}/^\circ\text{C}$ in the *Electrical Characteristics*, the calculation results in a 6σ value for offset voltage drift is about $1.8\mu\text{V}/^\circ\text{C}$. When designing for worst-case system conditions, this value can be used to estimate the worst possible offset across temperature without having an actual minimum or maximum value.

However, process variation and adjustments over time can shift typical means and standard deviations, and unless there is a value in the minimum or maximum specification column, the performance of a device is not verified. This information must be used only to estimate the performance of a device.

6.4 Device Functional Modes

The OPA4H199-SP has a single functional mode and is operational when the power-supply voltage is greater than 2.7V ($\pm 1.35\text{V}$). The maximum power supply voltage for the OPA4H199-SP is 40V ($\pm 20\text{V}$).

7 Application and Implementation

注

Information in the following applications sections is not part of the TI component specification, and TI does not warrant its accuracy or completeness. TI's customers are responsible for determining suitability of components for their purposes, as well as validating and testing their design implementation to confirm system functionality.

7.1 Application Information

The OPA4H199-SP family offers excellent DC precision and AC performance. These devices operate up to 40V supply rails and offer true rail-to-rail input/output, low offset voltage and offset voltage drift, as well as 4.5MHz bandwidth and high output drive. These features make the OPA4H199-SP a robust, high-performance operational amplifier for high-voltage industrial applications.

7.2 Typical Applications

7.2.1 Low-Side Current Measurement

Figure 7-1 shows the OPA4H199-SP configured in a low-side current sensing application. For a full analysis of the circuit shown in Figure 7-1 including theory, calculations, simulations, and measured data, see TI Precision Design TIPD129, [0A to 1A Single-Supply Low-Side Current-Sensing Solution](#).

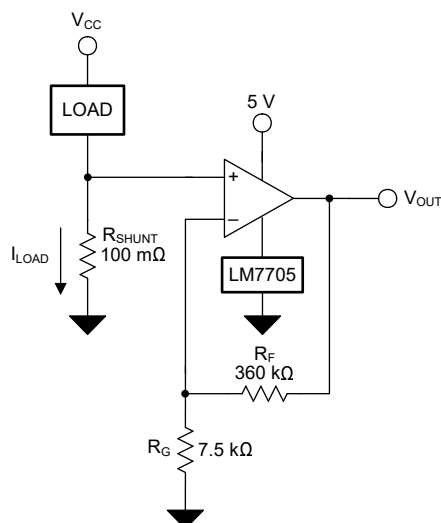

Figure 7-1. OPA4H199-SP in a Low-Side, Current-Sensing Application

7.2.1.1 Design Requirements

The design requirements for this design are:

- Load current: 0A to 1A
- Output voltage: 4.9V
- Maximum shunt voltage: 100mV

7.2.1.2 Detailed Design Procedure

The transfer function of the circuit in [図 7-1](#) is given in [式 1](#).

$$V_{OUT} = I_{LOAD} \times R_{SHUNT} \times \text{Gain} \quad (1)$$

The load current (I_{LOAD}) produces a voltage drop across the shunt resistor (R_{SHUNT}). The load current is set from 0A to 1A. To keep the shunt voltage below 100mV at maximum load current, the largest shunt resistor is defined using [式 2](#).

$$R_{SHUNT} = \frac{V_{SHUNT_MAX}}{I_{LOAD_MAX}} = \frac{100 \text{ mV}}{1 \text{ A}} = 100 \text{ m}\Omega \quad (2)$$

Using [式 2](#), R_{SHUNT} is calculated to be 100m Ω . The voltage drop produced by I_{LOAD} and R_{SHUNT} is amplified by the OPA4H199-SP to produce an output voltage of 0V to 4.9V. The gain needed by the OPA4H199-SP to produce the necessary output voltage is calculated using [式 3](#).

$$\text{Gain} = \frac{(V_{OUT_MAX} - V_{OUT_MIN})}{(V_{IN_MAX} - V_{IN_MIN})} \quad (3)$$

Using [式 3](#), the required gain is calculated to be 49V/V, which is set with resistors R_F and R_G . [式 4](#) is used to size the resistors, R_F and R_G , to set the gain of the OPA4H199-SP to 49V/V.

$$\text{Gain} = 1 + \frac{(R_F)}{(R_G)} \quad (4)$$

Choosing R_F as 360k Ω , R_G is calculated to be 7.5k Ω . R_F and R_G were chosen as 360k Ω and 7.5k Ω because they are standard value resistors that create a 49:1 ratio. Other resistors that create a 49:1 ratio can also be used. [図 7-2](#) shows the measured transfer function of the circuit shown in [図 7-1](#).

7.2.1.3 Application Curve



図 7-2. Low-Side, Current-Sense, Transfer Function

7.3 Power Supply Recommendations

The OPA4H199-SP is specified for operation from 2.7V to 40V ($\pm 1.35V$ to $\pm 40V$); many specifications apply from -55°C to 125°C . Parameters that can exhibit significant variance with regard to operating voltage or temperature are presented in [Typical Characteristics](#).

注意

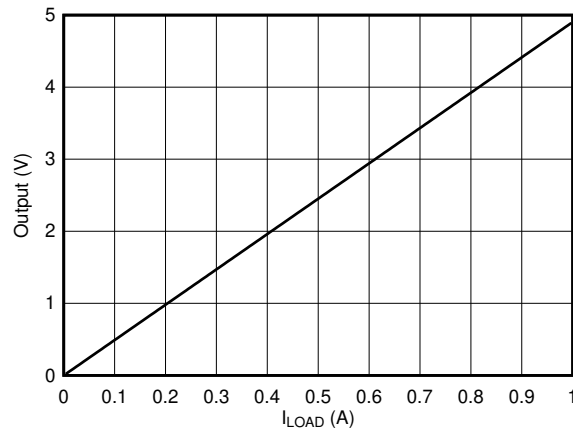
Supply voltages larger than 40V can permanently damage the device; see [Absolute Maximum Ratings](#).

Place 0.1 μF bypass capacitors close to the power-supply pins to reduce errors coupling in from noisy or high-impedance power supplies. For more detailed information on bypass capacitor placement, refer to [Layout](#).

7.4 Layout

7.4.1 Layout Guidelines

For best operational performance of the device, use good PCB layout practices, including:

- Noise can propagate into analog circuitry through the power pins of the circuit as a whole and op amp itself. Bypass capacitors are used to reduce the coupled noise by providing low-impedance power sources local to the analog circuitry.
 - Connect low-ESR, 0.1 μF ceramic bypass capacitors between each supply pin and ground, placed as close to the device as possible. A single bypass capacitor from V+ to ground is applicable for single-supply applications.
- Separate grounding for the analog and digital portions of circuitry is one of the simplest and most-effective methods of noise suppression. One or more layers on multilayer PCBs are usually devoted to ground planes. A ground plane helps distribute heat and reduces EMI noise pickup. Make sure to physically separate digital and analog grounds paying attention to the flow of the ground current.
- To reduce parasitic coupling, run the input traces as far away from the supply or output traces as possible. If these traces cannot be kept separate, crossing the sensitive trace perpendicular is much better as opposed to in parallel with the noisy trace.
- Place the external components as close to the device as possible. As illustrated in [Figure 7-4](#), keeping RF and RG close to the inverting input minimizes parasitic capacitance.
- Keep the length of input traces as short as possible. Always remember that the input traces are the most sensitive part of the circuit.
- Consider a driven, low-impedance guard ring around the critical traces. A guard ring can significantly reduce leakage currents from nearby traces that are at different potentials.
- Cleaning the PCB following board assembly is recommended for best performance.
- Any precision integrated circuit can experience performance shifts due to moisture ingress into the plastic package. Following any aqueous PCB cleaning process, baking the PCB assembly is recommended to remove moisture introduced into the device packaging during the cleaning process. A low-temperature, post-cleaning bake at 85°C for 30 minutes is sufficient for most circumstances.

7.4.2 Layout Example

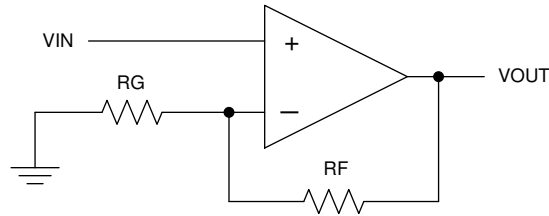

☒ 7-3. Schematic Representation

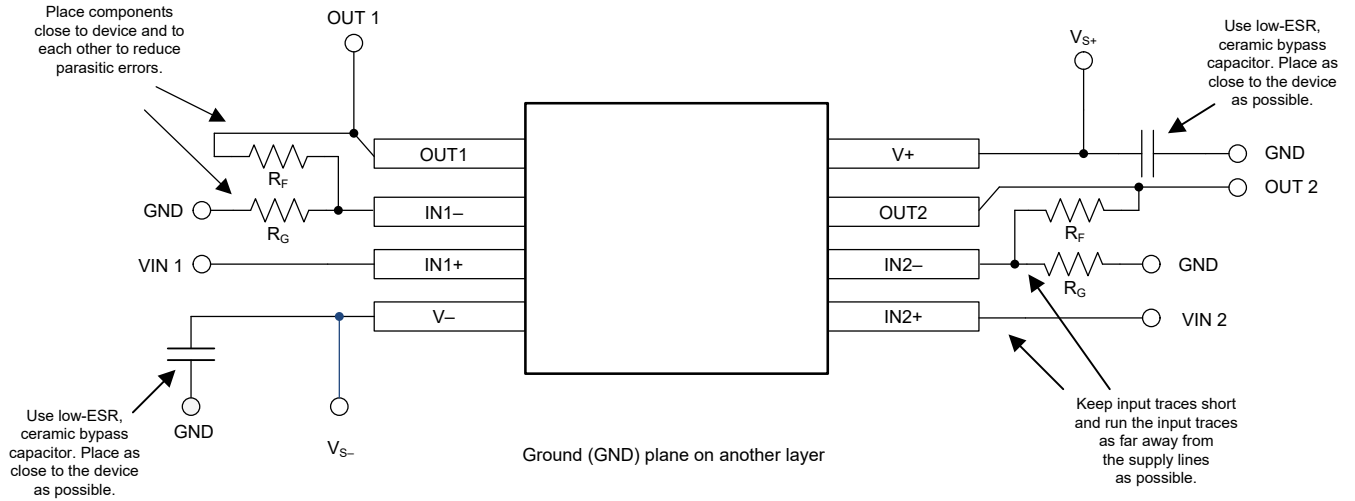

☒ 7-4. Operational Amplifier Board Layout for Noninverting Configuration

8 Device and Documentation Support

8.1 Device Support

8.1.1 Development Support

8.1.1.1 TINA-TI™ (Free Software Download)

TINA™ is a simple, powerful, and easy-to-use circuit simulation program based on a SPICE engine. TINA-TI is a free, fully-functional version of the TINA software, preloaded with a library of macro models in addition to a range of both passive and active models. TINA-TI provides all the conventional dc, transient, and frequency domain analysis of SPICE, as well as additional design capabilities.

Available as a [free download](#) from the Analog eLab Design Center, TINA-TI offers extensive post-processing capability that allows users to format results in a variety of ways. Virtual instruments offer the ability to select input waveforms and probe circuit nodes, voltages, and waveforms, creating a dynamic quick-start tool.

注

These files require that either the TINA software (from DesignSoft™) or TINA-TI software be installed. Download the free TINA-TI software from the [TINA-TI folder](#).

8.2 Documentation Support

8.2.1 Related Documentation

For related documentation, see the following:

- Texas Instruments, [Analog Engineer's Circuit Cookbook: Amplifiers solution guide](#)
- Texas Instruments, [AN31 Amplifier Circuit Collection application note](#)
- Texas Instruments, [MUX-Friendly Precision Operational Amplifiers application brief](#)
- Texas Instruments, [EMI Rejection Ratio of Operational Amplifiers application note](#)
- Texas Instruments, [Op Amps With Complementary-Pair Input Stages application note](#)
- Texas Instruments, [Op amps with complementary-pair input stages: What are the design trade-offs? Analog Design Journal](#)

8.3 ドキュメントの更新通知を受け取る方法

ドキュメントの更新についての通知を受け取るには、www.tij.co.jp のデバイス製品フォルダを開いてください。[通知] をクリックして登録すると、変更されたすべての製品情報に関するダイジェストを毎週受け取ることができます。変更の詳細については、改訂されたドキュメントに含まれている改訂履歴をご覧ください。

8.4 サポート・リソース

テキサス・インスツルメンツ E2E™ サポート・フォーラムは、エンジニアが検証済みの回答と設計に関するヒントをエキスパートから迅速かつ直接得ることができる場所です。既存の回答を検索したり、独自の質問をしたりすることで、設計に必要な支援を迅速に得ることができます。

リンクされているコンテンツは、各寄稿者により「現状のまま」提供されるものです。これらはテキサス・インスツルメンツの仕様を構成するものではなく、必ずしもテキサス・インスツルメンツの見解を反映したものではありません。テキサス・インスツルメンツの[使用条件](#)を参照してください。

8.5 Trademarks

TINA-TI™ and テキサス・インスツルメンツ E2E™ are trademarks of Texas Instruments.

TINA™ and DesignSoft™ are trademarks of DesignSoft, Inc.

Bluetooth® is a registered trademark of Bluetooth SIG, Inc.

すべての商標は、それぞれの所有者に帰属します。

8.6 静電気放電に関する注意事項



この IC は、ESD によって破損する可能性があります。テキサス・インスツルメンツは、IC を取り扱う際には常に適切な注意を払うことを推奨します。正しい取り扱いおよび設置手順に従わない場合、デバイスを破損するおそれがあります。

ESD による破損は、わずかな性能低下からデバイスの完全な故障まで多岐にわたります。精密な IC の場合、パラメータがわずかに変化するだけで公表されている仕様から外れる可能性があるため、破損が発生しやすくなっています。

8.7 用語集

[テキサス・インスツルメンツ用語集](#) この用語集には、用語や略語の一覧および定義が記載されています。

9 Revision History

DATE	REVISION	NOTES
December 2024	*	Initial Release

10 Mechanical, Packaging, and Orderable Information

The following pages include mechanical, packaging, and orderable information. This information is the most current data available for the designated devices. This data is subject to change without notice and revision of this document. For browser-based versions of this data sheet, refer to the left-hand navigation.

PACKAGING INFORMATION

Orderable part number	Status (1)	Material type (2)	Package Pins	Package qty Carrier	RoHS (3)	Lead finish/ Ball material (4)	MSL rating/ Peak reflow (5)	Op temp (°C)	Part marking (6)
5962R2321401PXE	Active	Production	SOT-23-THIN (DYY) 14	250 SMALL T&R	Yes	NIPDAU	Level-2-260C-1 YEAR	-55 to 125	5962R 2321401PXE 4H199DYYSP
5962R2321401PXE.A	Active	Production	SOT-23-THIN (DYY) 14	250 SMALL T&R	Yes	NIPDAU	Level-2-260C-1 YEAR	-55 to 125	5962R 2321401PXE 4H199DYYSP

(1) **Status:** For more details on status, see our [product life cycle](#).

(2) **Material type:** When designated, preproduction parts are prototypes/experimental devices, and are not yet approved or released for full production. Testing and final process, including without limitation quality assurance, reliability performance testing, and/or process qualification, may not yet be complete, and this item is subject to further changes or possible discontinuation. If available for ordering, purchases will be subject to an additional waiver at checkout, and are intended for early internal evaluation purposes only. These items are sold without warranties of any kind.

(3) **RoHS values:** Yes, No, RoHS Exempt. See the [TI RoHS Statement](#) for additional information and value definition.

(4) **Lead finish/Ball material:** Parts may have multiple material finish options. Finish options are separated by a vertical ruled line. Lead finish/Ball material values may wrap to two lines if the finish value exceeds the maximum column width.

(5) **MSL rating/Peak reflow:** The moisture sensitivity level ratings and peak solder (reflow) temperatures. In the event that a part has multiple moisture sensitivity ratings, only the lowest level per JEDEC standards is shown. Refer to the shipping label for the actual reflow temperature that will be used to mount the part to the printed circuit board.

(6) **Part marking:** There may be an additional marking, which relates to the logo, the lot trace code information, or the environmental category of the part.

Multiple part markings will be inside parentheses. Only one part marking contained in parentheses and separated by a "-" will appear on a part. If a line is indented then it is a continuation of the previous line and the two combined represent the entire part marking for that device.

Important Information and Disclaimer: The information provided on this page represents TI's knowledge and belief as of the date that it is provided. TI bases its knowledge and belief on information provided by third parties, and makes no representation or warranty as to the accuracy of such information. Efforts are underway to better integrate information from third parties. TI has taken and continues to take reasonable steps to provide representative and accurate information but may not have conducted destructive testing or chemical analysis on incoming materials and chemicals. TI and TI suppliers consider certain information to be proprietary, and thus CAS numbers and other limited information may not be available for release.

In no event shall TI's liability arising out of such information exceed the total purchase price of the TI part(s) at issue in this document sold by TI to Customer on an annual basis.

OTHER QUALIFIED VERSIONS OF OPA4H199-SP :

- Catalog : [OPA4H199-SEP](#)

NOTE: Qualified Version Definitions:

- Catalog - TI's standard catalog product

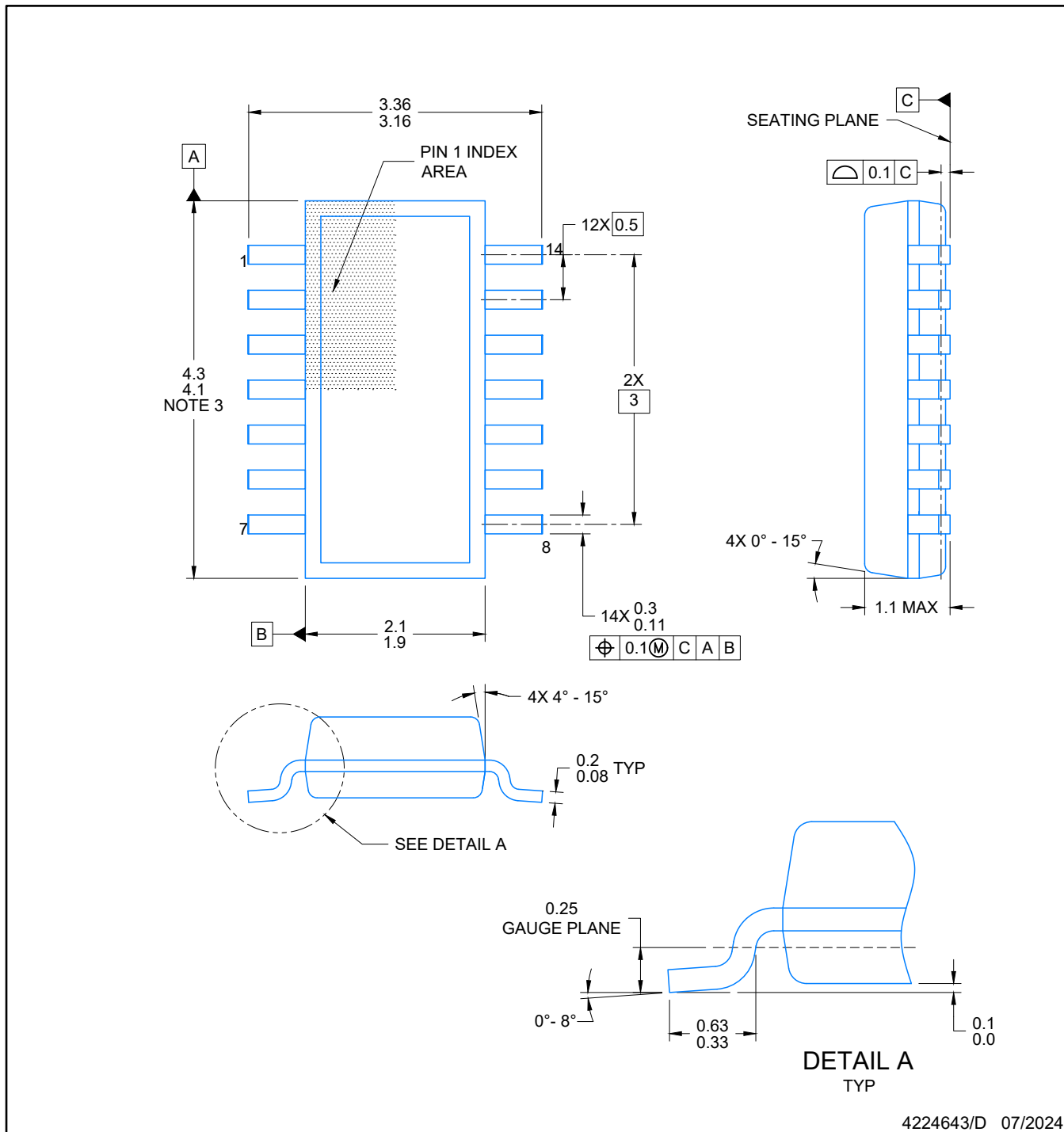

4224643/D 07/2024

NOTES:

1. All linear dimensions are in millimeters. Any dimensions in parenthesis are for reference only. Dimensioning and tolerancing per ASME Y14.5M.
2. This drawing is subject to change without notice.
3. This dimension does not include mold flash, protrusions, or gate burrs. Mold flash, protrusions, or gate burrs shall not exceed 0.15 per side.
4. This dimension does not include interlead flash. Interlead flash shall not exceed 0.50 per side.
5. Reference JEDEC Registration MO-345, Variation AB

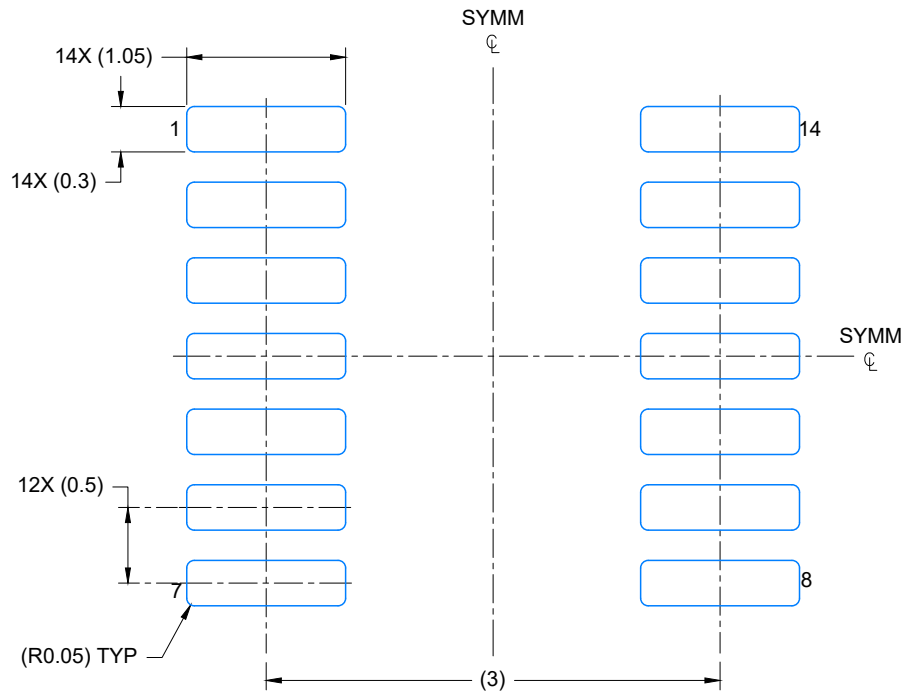

LAND PATTERN EXAMPLE
EXPOSED METAL SHOWN
SCALE: 20X

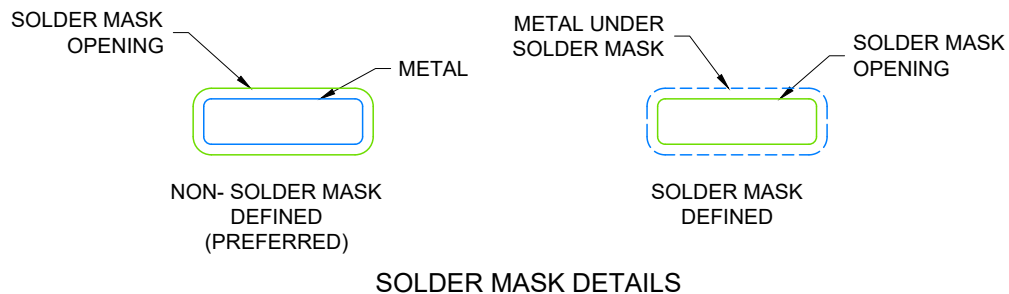

4224643/D 07/2024

NOTES: (continued)

- 6. Publication IPC-7351 may have alternate designs.
- 7. Solder mask tolerances between and around signal pads can vary based on board fabrication site.

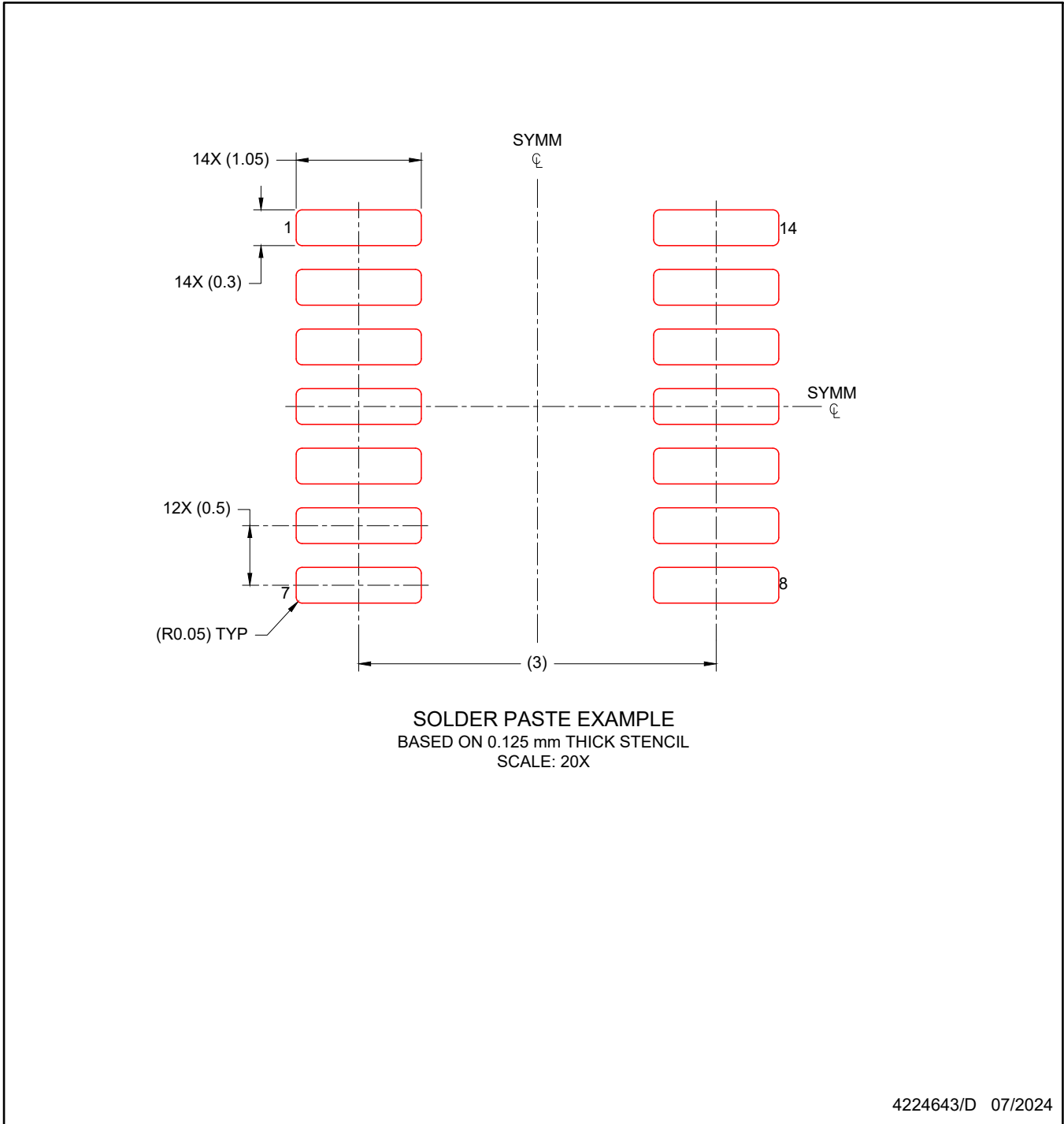

NOTES: (continued)

8. Laser cutting apertures with trapezoidal walls and rounded corners may offer better paste release. IPC-7525 may have alternate design recommendations.
9. Board assembly site may have different recommendations for stencil design.

重要なお知らせと免責事項

TI は、技術データと信頼性データ(データシートを含みます)、設計リソース(リファレンス デザインを含みます)、アプリケーションや設計に関する各種アドバイス、Web ツール、安全性情報、その他のリソースを、欠陥が存在する可能性のある「現状のまま」提供しており、商品性および特定目的に対する適合性の黙示保証、第三者の知的財産権の非侵害保証を含むいかなる保証も、明示的または黙示的にかかわらず拒否します。

これらのリソースは、TI 製品を使用する設計の経験を積んだ開発者への提供を意図したものです。(1) お客様のアプリケーションに適した TI 製品の選定、(2) お客様のアプリケーションの設計、検証、試験、(3) お客様のアプリケーションに該当する各種規格や、その他のあらゆる安全性、セキュリティ、規制、または他の要件への確実な適合に関する責任を、お客様のみが単独で負うものとし、

上記の各種リソースは、予告なく変更される可能性があります。これらのリソースは、リソースで説明されている TI 製品を使用するアプリケーションの開発の目的でのみ、TI はその使用をお客様に許諾します。これらのリソースに関して、他の目的で複製することや掲載することは禁止されています。TI や第三者の知的財産権のライセンスが付与されている訳ではありません。お客様は、これらのリソースを自身で使用した結果発生するあらゆる申し立て、損害、費用、損失、責任について、TI およびその代理人を完全に補償するものとし、TI は一切の責任を拒否します。

TI の製品は、[TI の販売条件](#)、[TI の総合的な品質ガイドライン](#)、[ti.com](#) または TI 製品などに関連して提供される他の適用条件に従い提供されます。TI がこれらのリソースを提供することは、適用される TI の保証または他の保証の放棄の拡大や変更を意味するものではありません。TI がカスタム、またはカスタマー仕様として明示的に指定していない限り、TI の製品は標準的なカタログに掲載される汎用機器です。

お客様がいかなる追加条項または代替条項を提案する場合も、TI はそれらに異議を唱え、拒否します。

Copyright © 2025, Texas Instruments Incorporated

最終更新日：2025 年 10 月