

SN74AC241 3 ステート出力、オクタル・バッファ / ドライバ

1 特長

- 2V~6V の V_{CC} で動作
- 6V までの入力電圧に対応
- 最大 t_{pd} 7.5ns (5V 時)

2 概要

これらのオクタル バッファ / ラインドライバは、3 ステートメモリ アドレス ドライバ、クロック ドライバ、バス用レシーバ / トランスミッタの性能と密度を向上することに特化して設計されています。

パッケージ情報

部品番号	パッケージ (1)	パッケージ サイズ (2)	本体サイズ (3)
SN74AC241	N (PDIP, 20)	24.33mm × 9.4mm	24.33mm × 6.35mm
	DW (SOIC, 20)	12.8mm × 10.3mm	12.8mm × 7.5mm
	NS (SOP, 20)	12.6mm × 7.8mm	12.6mm × 5.3mm
	DB (SSOP, 20)	7.2mm × 7.8mm	7.2mm × 5.3mm
	PW (TSSOP, 20)	6.5mm × 6.4mm	6.5mm × 4.4mm

- (1) 詳細については、[セクション 10](#) を参照してください。
- (2) パッケージ サイズ (長さ × 幅) は公称値であり、該当する場合はピンも含まれます。
- (3) 本体サイズ (長さ × 幅) は公称値であり、ピンは含まれません。

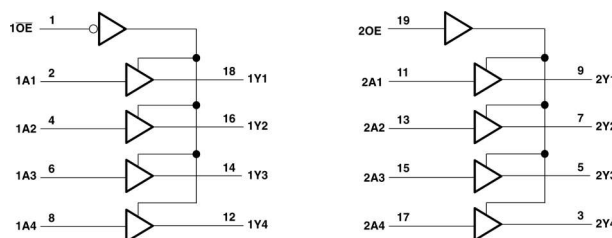

論理図 (正論理)

Table of Contents

1 特長	1	6.3 Device Functional Modes.....	8
2 概要	1	7 Application and Implementation	9
3 Pin Configuration and Functions	3	7.1 Power Supply Recommendations.....	9
4 Specifications	4	7.2 Layout.....	9
4.1 Absolute Maximum Ratings.....	4	8 Device and Documentation Support	10
4.2 Recommended Operating Conditions.....	4	8.1 Documentation Support (Analog).....	10
4.3 Thermal Information.....	4	8.2 ドキュメントの更新通知を受け取る方法.....	10
4.4 Electrical Characteristics.....	5	8.3 サポート・リソース.....	10
4.5 Switching Characteristics, $V_{CC} = 3.3\text{ V} \pm 0.3\text{ V}$	5	8.4 Trademarks.....	10
4.6 Switching Characteristics, $V_{CC} = 5\text{ V} \pm 0.5\text{ V}$	5	8.5 静電気放電に関する注意事項.....	10
4.7 Operating Characteristics.....	6	8.6 用語集.....	10
5 Parameter Measurement Information	7	9 Revision History	10
6 Detailed Description	8	10 Mechanical, Packaging, and Orderable Information	11
6.1 Overview.....	8		
6.2 Functional Block Diagram.....	8		

3 Pin Configuration and Functions



図 3-1. SN54AC241 DB, DW, N, NS, Or PW Package (Top View)

表 3-1. Pin Functions

NAME ¹	PIN	TYPE	DESCRIPTION
1OE	1	I	Output enable 1
1A1	2	I	1A1 input
2Y4	3	O	2Y4 output
1A2	4	I	1A2 input
2Y3	5	O	2Y3 output
1A3	6	I	1A3 input
2Y2	7	O	2Y2 output
1A4	8	I	1A4 input
2Y1	9	O	2Y1 output
GND	10	—	Ground pin
2A1	11	I	2A1 input
1Y4	12	O	1Y4 output
2A2	13	I	2A2 input
1Y3	14	O	1Y3 output
2A3	15	I	2A3 input
1Y2	16	O	1Y2 output
2A4	17	I	2A4 input
1Y1	18	O	1Y1 output
2OE	19	I	Output enable 2
VCC	20	—	Power pin

4 Specifications

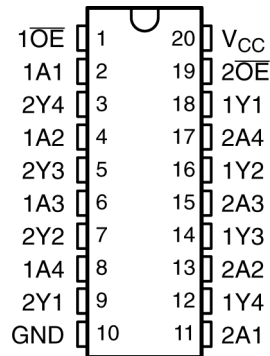
4.1 Absolute Maximum Ratings

over operating free-air temperature range (unless otherwise noted)⁽¹⁾

		MIN	MAX	UNIT
V _{CC}	Supply voltage range	-0.5	7	V
V _I ¹	Input voltage range	-0.5	V _{CC} +0.5	V
V _O ¹	Output voltage range	-0.5	V _{CC} +0.5	V
I _{IK}	Input clamp current	(V _I < 0 or V _I > V _{CC})	±20	mA
I _{OK}	Output clamp current	(V _O < 0 or V _O > V _{CC})	±20	mA
I _O	Continuous output current	(V _O = 0 or V _{CC})	±50	mA
	Continuous current through V _{CC} or GND		±200	mA
T _{stg}	Storage temperature range	-65	150	°C

- (1) Stresses beyond those listed under “absolute maximum ratings” may cause permanent damage to the device. These are stress ratings only, and functional operation of the device at these or any other conditions beyond those indicated under “recommended operating conditions” is not implied. Exposure to absolute-maximum-rated conditions for extended periods may affect device reliability.
- (2) The input and output voltage ratings may be exceeded if the input and output current ratings are observed.

4.2 Recommended Operating Conditions

over operating free-air temperature range (unless otherwise noted)⁽¹⁾

		MIN	MAX	UNIT
V _{CC}	Supply voltage	2	6	V
V _{IH}	High-level input voltage	V _{CC} = 3 V	2.1	V
		V _{CC} = 4.5 V	3.15	
		V _{CC} = 5.5 V	3.85	
V _{IL}	Low-level input voltage	V _{CC} = 3 V	0.9	V
		V _{CC} = 4.5 V	1.35	
		V _{CC} = 5.5 V	1.65	
V _I	Input voltage	0	V _{CC}	V
V _O	Output voltage	0	V _{CC}	V
I _{OH}	High-level output current	V _{CC} = 3 V	-12	mA
		V _{CC} = 4.5 V	-24	
		V _{CC} = 5.5 V	-24	
I _{OL}	Low-level output current	V _{CC} = 3 V	12	mA
		V _{CC} = 4.5 V	24	
		V _{CC} = 5.5 V	24	
Δt/Δv	Input transition rise or fall rate		8	ns/V
T _a	Operating free-air temperature	-40	85	°C

- (1) All unused inputs of the device must be held at V_{CC} or GND to ensure proper device operation. Refer to the TI application report, *Implications of Slow or Floating CMOS Inputs*, literature number SCBA004.

4.3 Thermal Information

THERMAL METRIC ⁽¹⁾	DB (SSOP)	DW (SOIC)	N (PDIP)	NS (SOP)	PW (TSSOP)	UNIT	
	20 PINS						
R _{θJA}	Junction-to-ambient thermal resistance ²	70	58	69	60	126.2	°C/W

- (1) For more information about traditional and new thermal metrics, see the *IC Package Thermal Metrics* application report, [SPRA953](#).

4.4 Electrical Characteristics

over recommended operating free-air temperature range (unless otherwise noted)

PARAMETER	TEST CONDITIONS	V _{CC}	T _A = 25°C			SN74AC241		UNIT
			MIN	TYP	MAX	MIN	MAX	
V _{OH}	I _{oh} = -50 μA	3 V	2.9			2.9	V	
		4.5 V	4.4			4.4		
		5.5 V	5.4			5.4		
	I _{oh} = -12 mA	3 V	2.56			2.46		
		4.5 V	3.86			3.76		
	I _{oh} = -24 mA	5.5 V	4.86			4.76		
		I _{oh} = -50 mA ⁽¹⁾	5.5 V					
I _{oh} = -75 mA ⁽¹⁾	5.5 V				3.85			
V _{OL}	I _{ol} = 50 μA	3 V				0.1	V	
		4.5 V				0.1		
		5.5 V				0.1		
	I _{ol} = 12 mA	3 V				0.36		0.44
		4.5 V				0.36		0.44
	I _{ol} = 24 mA	5.5 V				0.36		0.44
		I _{ol} = 50 mA ⁽¹⁾	5.5 V					
I _{ol} = 75 mA ⁽¹⁾	5.5 V					1.65		
I _I	Data inputs	V _I = V _{CC} or GND	5.5 V			±0.1	±1	μA
	Control inputs	V _I = V _{CC} or GND				±0.1	±1	
I _{OZ}	V _O = V _{CC} or GND, V _{I(OE)} = V _{IL} or V _{IH}		5.5 V			±0.25	±2.5	μA
I _{CC}	V _I = V _{CC} or GND, I _O = 0		5.5 V			4	40	μA
C _i	V _I = V _{CC} or GND		5 V	2.5				pF

(1) Not more than one output should be tested at a time, and the duration of the test should not exceed 10 ms.

4.5 Switching Characteristics, V_{CC} = 3.3 V ± 0.3 V

over recommended operating free-air temperature range, V_{CC} = 3.3 V ± 0.3 V (unless otherwise noted) (see [Load Circuit and Voltage Waveforms](#))

PARAMETER	FROM (INPUT)	TO (OUTPUT)	T _A = 25°C			SN74AC241		UNIT
			MIN	TYP	MAX	MIN	MAX	
t _{PLH}	A	Y	1.5	6	9	1.5	10	ns
t _{PHL}			1.5	6	9	1	10.5	
t _{PZH}	OE or OE	Y	1.5	6.5	12.5	1	13	ns
t _{PZL}			1.5	7	12	1.5	13	
t _{PHZ}	OE or OE	Y	2	8	12	2	12.5	ns
t _{PLZ}			1.5	7	12.5	1	13.5	

4.6 Switching Characteristics, V_{CC} = 5 V ± 0.5 V

over recommended operating free-air temperature range, V_{CC} = 5 V ± 0.5 V (unless otherwise noted) (see [Load Circuit and Voltage Waveforms](#))

PARAMETER	FROM (INPUT)	TO (OUTPUT)	T _A = 25°C			SN74AC241		UNIT
			MIN	TYP	MAX	MIN	MAX	
t _{PLH}	A	Y	1.5	5	7	1	7.5	ns
t _{PHL}			1.5	4.5	7	1	7.5	

SN74AC241

JAJSQB7G – JUNE 1995 – REVISED MARCH 2024

over recommended operating free-air temperature range, $V_{CC} = 5\text{ V} \pm 0.5\text{ V}$ (unless otherwise noted) (see [Load Circuit and Voltage Waveforms](#))

PARAMETER	FROM (INPUT)	TO (OUTPUT)	$T_A = 25^\circ\text{C}$			SN74AC241		UNIT
			MIN	TYP	MAX	MIN	MAX	
t_{PZH}	\overline{OE} or OE	Y	1.5	5.5	9	1	9.5	ns
t_{PZL}			1.5	5.5	9	1	9.5	
t_{PHZ}	\overline{OE} or OE	Y	1.5	6.5	10	1	10.5	ns
t_{PLZ}			1.5	6	10	1	10.5	

4.7 Operating Characteristics

 $V_{CC} = 5\text{ V}$, $T_A = 25^\circ\text{C}$

PARAMETER	TEST CONDITIONS	TYP	UNIT
C_{pd} Power dissipation capacitance per buffer/driver	$C_1 = 50\text{ pF}$, $f = 1\text{ MHz}$	45	pF

5 Parameter Measurement Information

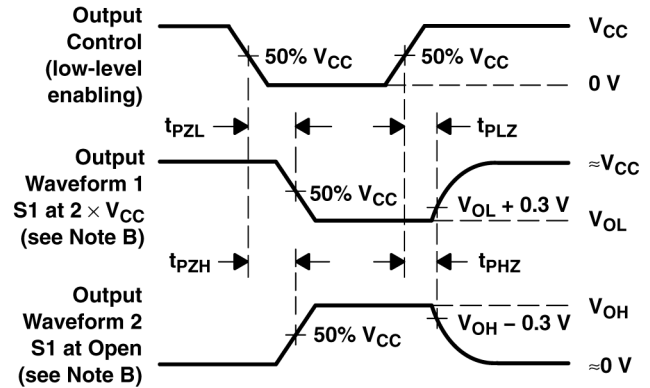
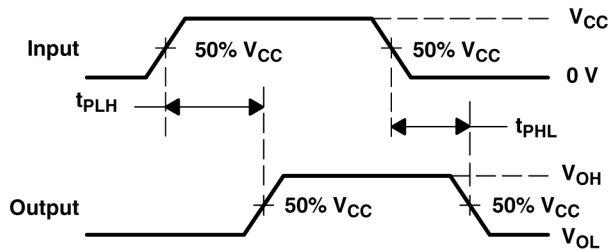
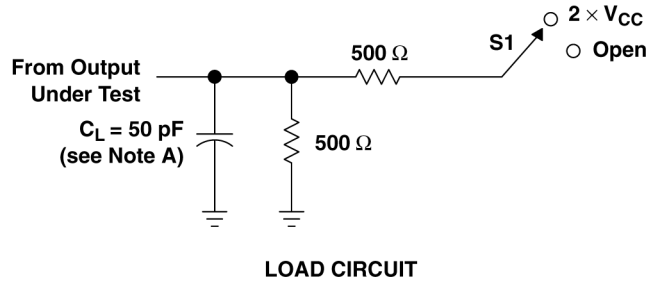

- C_L includes probe and jig capacitance.
- Waveform 1 is for an output with internal conditions such that the output is low except when disabled by the output control. Waveform 2 is for an output with internal conditions such that the output is high except when disabled by the output control.
- All input pulses are supplied by generators having the following characteristics: $PRR \leq 1 \text{ MHz}$, $Z_O = 50 \Omega$, $t_r \leq 2.5 \text{ ns}$, $t_f \leq 2.5 \text{ ns}$.
- The outputs are measured one at a time with one input transition per measurement.

图 5-1. Load Circuit and Voltage Waveforms

TEST	S1
t_{PLH}/t_{PHL}	Open
t_{PLZ}/t_{PZL}	$2 \times V_{CC}$
t_{PHZ}/t_{PZH}	Open

6 Detailed Description

6.1 Overview

The 'AC241 devices are organized as two 4-bit buffers/drivers with separate complementary output-enable ($1\overline{OE}$ and $2OE$) inputs. When $1\overline{OE}$ is low or $2OE$ is high, the device passes noninverted data from the A inputs to the Y outputs. When $1\overline{OE}$ is high or $2OE$ is low, the outputs are in the high-impedance state.

To ensure the high-impedance state during power up or power down, \overline{OE} should be tied to V_{CC} through a pullup resistor and OE should be tied to GND through a pulldown resistor; the minimum value of the resistor is determined by the current-sinking or the current-sourcing capability of the driver.

6.2 Functional Block Diagram



图 6-1. Logic Diagram (Positive Logic)

6.3 Device Functional Modes

表 6-1. Function Tables

INPUTS		OUTPUT 1Y
1OE	1A	
L	H	H
L	L	L
H	X	Z

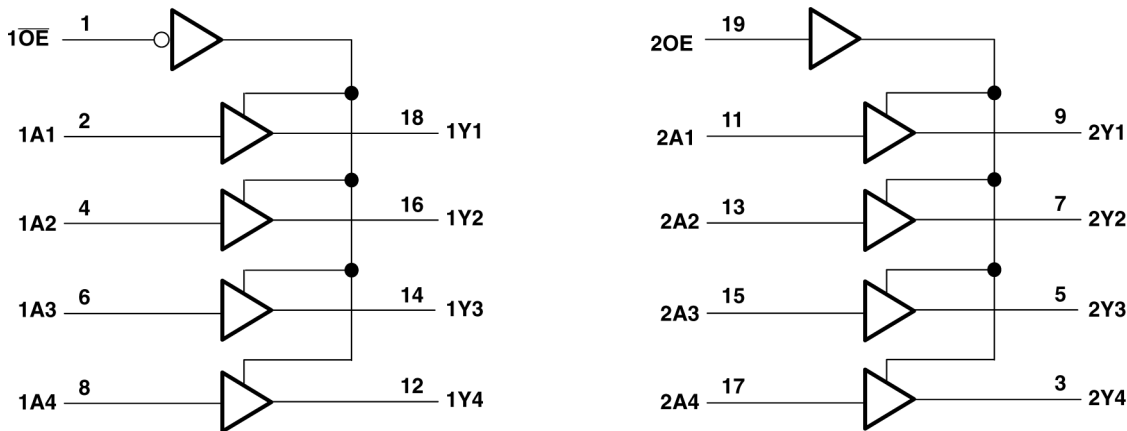
INPUTS		OUTPUT 2Y
2OE	2A	
H	H	H
H	L	L
L	X	Z

7 Application and Implementation

注

以下のアプリケーション情報は、TI の製品仕様に含まれるものではなく、TI ではその正確性または完全性を保証いたしません。個々の目的に対する製品の適合性については、お客様の責任で判断していただくこととなります。お客様は自身の設計実装を検証しテストすることで、システムの機能を確認する必要があります。

7.1 Power Supply Recommendations

The power supply can be any voltage between the min and max supply voltage rating located in [セクション 4.2](#).

Each V_{CC} terminal should have a good bypass capacitor to prevent power disturbance. For devices with a single supply, TI recommends $0.1 \mu\text{F}$ and if there are multiple V_{CC} terminals, then TI recommends $.01 \mu\text{F}$ or $.022 \mu\text{F}$ for each power terminal. It is okay to parallel multiple bypass capacitors to reject different frequencies of noise. A $0.1 \mu\text{F}$ and $1 \mu\text{F}$ are commonly used in parallel. The bypass capacitor should be installed as close to the power terminal as possible for best results.

7.2 Layout

7.2.1 Layout Guidelines

When using multiple bit logic devices inputs should not ever float.

In many cases, functions or parts of functions of digital logic devices are unused, for example, when only two inputs of a triple-input AND gate are used or only 3 of the 4 buffer gates are used. Such input pins should not be left unconnected because the undefined voltages at the outside connections result in undefined operational states. Specified below are the rules that must be observed under all circumstances. All unused inputs of digital logic devices must be connected to a high or low bias to prevent them from floating. The logic level that should be applied to any particular unused input depends on the function of the device. Generally they will be tied to GND or V_{CC} whichever make more sense or is more convenient. It is generally okay to float outputs unless the part is a transceiver. If the transceiver has an output enable pin it will disable the outputs section of the part when asserted. This does not disable the input section of the IOs so they cannot float when disabled.

7.2.1.1 Layout Example



図 7-1. Example Layout for the SN74AC241

8 Device and Documentation Support

8.1 Documentation Support (Analog)

8.1.1 Related Documentation

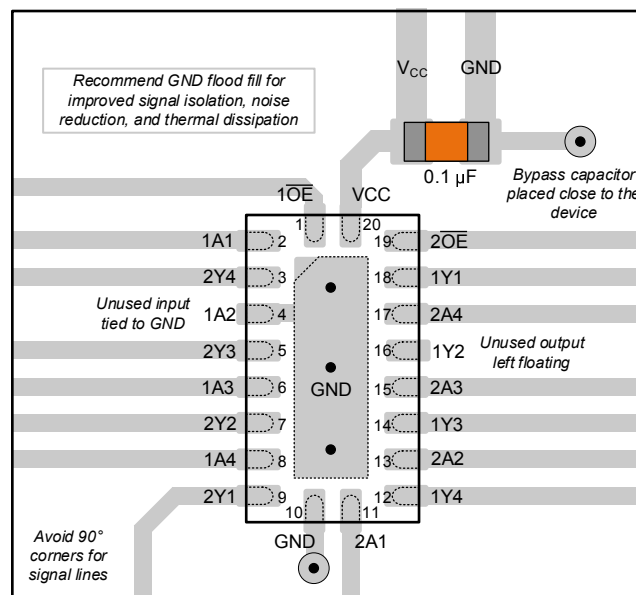
The table below lists quick access links. Categories include technical documents, support and community resources, tools and software, and quick access to sample or buy.

表 8-1. Related Links

PARTS	PRODUCT FOLDER	SAMPLE & BUY	TECHNICAL DOCUMENTS	TOOLS & SOFTWARE	SUPPORT & COMMUNITY
SN74AC241	Click here	Click here	Click here	Click here	Click here

8.2 ドキュメントの更新通知を受け取る方法

ドキュメントの更新についての通知を受け取るには、www.tij.co.jp のデバイス製品フォルダを開いてください。[通知] をクリックして登録すると、変更されたすべての製品情報に関するダイジェストを毎週受け取ることができます。変更の詳細については、改訂されたドキュメントに含まれている改訂履歴をご覧ください。

8.3 サポート・リソース

テキサス・インスツルメンツ E2E™ サポート・フォーラムは、エンジニアが検証済みの回答と設計に関するヒントをエキスパートから迅速かつ直接得ることができる場所です。既存の回答を検索したり、独自の質問をしたりすることで、設計に必要な支援を迅速に得ることができます。

リンクされているコンテンツは、各寄稿者により「現状のまま」提供されるものです。これらはテキサス・インスツルメンツの仕様を構成するものではなく、必ずしもテキサス・インスツルメンツの見解を反映したものではありません。テキサス・インスツルメンツの[使用条件](#)を参照してください。

8.4 Trademarks

テキサス・インスツルメンツ E2E™ is a trademark of Texas Instruments.

すべての商標は、それぞれの所有者に帰属します。

8.5 静電気放電に関する注意事項



この IC は、ESD によって破損する可能性があります。テキサス・インスツルメンツは、IC を取り扱う際には常に適切な注意を払うことを推奨します。正しい取り扱いおよび設置手順に従わない場合、デバイスを破損するおそれがあります。

ESD による破損は、わずかな性能低下からデバイスの完全な故障まで多岐にわたります。精密な IC の場合、パラメータがわずかに変化するだけで公表されている仕様から外れる可能性があるため、破損が発生しやすくなっています。

8.6 用語集

[テキサス・インスツルメンツ用語集](#) この用語集には、用語や略語の一覧および定義が記載されています。

9 Revision History

Changes from Revision F (May 2023) to Revision G (March 2024) Page

- Updated high-level input voltage values in *Recommended Operating Conditions* table..... 4
- Updated R θ JA value: PW = 83 to 126.2, all values in °C/W 4

Changes from Revision E (October 2003) to Revision F (May 2023) Page

- 「パッケージ情報」表、「ピンの機能」表、「熱に関する情報」表を追加 1

10 Mechanical, Packaging, and Orderable Information

The following pages include mechanical, packaging, and orderable information. This information is the most current data available for the designated devices. This data is subject to change without notice and revision of this document. For browser-based versions of this data sheet, refer to the left-hand navigation.

重要なお知らせと免責事項

テキサス・インスツルメンツは、技術データと信頼性データ(データシートを含みます)、設計リソース(リファレンス デザインを含みます)、アプリケーションや設計に関する各種アドバイス、Web ツール、安全性情報、その他のリソースを、欠陥が存在する可能性のある「現状のまま」提供しており、商品性および特定目的に対する適合性の黙示保証、第三者の知的財産権の非侵害保証を含むいかなる保証も、明示的または黙示的にかかわらず拒否します。

これらのリソースは、テキサス・インスツルメンツ製品を使用する設計の経験を積んだ開発者への提供を意図したものです。(1) お客様のアプリケーションに適したテキサス・インスツルメンツ製品の選定、(2) お客様のアプリケーションの設計、検証、試験、(3) お客様のアプリケーションに該当する各種規格や、その他のあらゆる安全性、セキュリティ、規制、または他の要件への確実な適合に関する責任を、お客様のみが単独で負うものとします。

上記の各種リソースは、予告なく変更される可能性があります。これらのリソースは、リソースで説明されているテキサス・インスツルメンツ製品を使用するアプリケーションの開発の目的でのみ、テキサス・インスツルメンツはその使用をお客様に許諾します。これらのリソースに関して、他の目的で複製することや掲載することは禁止されています。テキサス・インスツルメンツや第三者の知的財産権のライセンスが付与されている訳ではありません。お客様は、これらのリソースを自身で使用した結果発生するあらゆる申し立て、損害、費用、損失、責任について、テキサス・インスツルメンツおよびその代理人を完全に補償するものとし、テキサス・インスツルメンツは一切の責任を拒否します。

テキサス・インスツルメンツの製品は、[テキサス・インスツルメンツの販売条件](#)、または [ti.com](https://www.ti.com) やかかるテキサス・インスツルメンツ製品の関連資料などのいずれかを通じて提供する適用可能な条項の下で提供されています。テキサス・インスツルメンツがこれらのリソースを提供することは、適用されるテキサス・インスツルメンツの保証または他の保証の放棄の拡大や変更を意味するものではありません。

お客様がいかなる追加条項または代替条項を提案した場合でも、テキサス・インスツルメンツはそれらに異議を唱え、拒否します。

郵送先住所: Texas Instruments, Post Office Box 655303, Dallas, Texas 75265
Copyright © 2024, Texas Instruments Incorporated

PACKAGING INFORMATION

Orderable Device	Status (1)	Package Type	Package Drawing	Pins	Package Qty	Eco Plan (2)	Lead finish/ Ball material (6)	MSL Peak Temp (3)	Op Temp (°C)	Device Marking (4/5)	Samples
SN74AC241DBR	ACTIVE	SSOP	DB	20	2000	RoHS & Green	NIPDAU	Level-1-260C-UNLIM	-40 to 85	AC241	Samples
SN74AC241DW	OBSOLETE	SOIC	DW	20		TBD	Call TI	Call TI	-40 to 85	AC241	
SN74AC241DWR	ACTIVE	SOIC	DW	20	2000	RoHS & Green	NIPDAU	Level-1-260C-UNLIM	-40 to 85	AC241	Samples
SN74AC241N	ACTIVE	PDIP	N	20	20	RoHS & Green	NIPDAU	N / A for Pkg Type	-40 to 85	SN74AC241N	Samples
SN74AC241NSR	ACTIVE	SOP	NS	20	2000	RoHS & Green	NIPDAU	Level-1-260C-UNLIM	-40 to 85	AC241	Samples
SN74AC241PW	OBSOLETE	TSSOP	PW	20		TBD	Call TI	Call TI	-40 to 85	AC241	
SN74AC241PWR	ACTIVE	TSSOP	PW	20	2000	RoHS & Green	NIPDAU	Level-1-260C-UNLIM	-40 to 85	AC241	Samples

(1) The marketing status values are defined as follows:

ACTIVE: Product device recommended for new designs.

LIFEBUY: TI has announced that the device will be discontinued, and a lifetime-buy period is in effect.

NRND: Not recommended for new designs. Device is in production to support existing customers, but TI does not recommend using this part in a new design.

PREVIEW: Device has been announced but is not in production. Samples may or may not be available.

OBSOLETE: TI has discontinued the production of the device.

(2) **RoHS:** TI defines "RoHS" to mean semiconductor products that are compliant with the current EU RoHS requirements for all 10 RoHS substances, including the requirement that RoHS substance do not exceed 0.1% by weight in homogeneous materials. Where designed to be soldered at high temperatures, "RoHS" products are suitable for use in specified lead-free processes. TI may reference these types of products as "Pb-Free".

RoHS Exempt: TI defines "RoHS Exempt" to mean products that contain lead but are compliant with EU RoHS pursuant to a specific EU RoHS exemption.

Green: TI defines "Green" to mean the content of Chlorine (Cl) and Bromine (Br) based flame retardants meet JS709B low halogen requirements of <=1000ppm threshold. Antimony trioxide based flame retardants must also meet the <=1000ppm threshold requirement.

(3) MSL, Peak Temp. - The Moisture Sensitivity Level rating according to the JEDEC industry standard classifications, and peak solder temperature.

(4) There may be additional marking, which relates to the logo, the lot trace code information, or the environmental category on the device.

(5) Multiple Device Markings will be inside parentheses. Only one Device Marking contained in parentheses and separated by a "-" will appear on a device. If a line is indented then it is a continuation of the previous line and the two combined represent the entire Device Marking for that device.

(6) Lead finish/Ball material - Orderable Devices may have multiple material finish options. Finish options are separated by a vertical ruled line. Lead finish/Ball material values may wrap to two lines if the finish value exceeds the maximum column width.

Important Information and Disclaimer: The information provided on this page represents TI's knowledge and belief as of the date that it is provided. TI bases its knowledge and belief on information provided by third parties, and makes no representation or warranty as to the accuracy of such information. Efforts are underway to better integrate information from third parties. TI has taken and continues to take reasonable steps to provide representative and accurate information but may not have conducted destructive testing or chemical analysis on incoming materials and chemicals. TI and TI suppliers consider certain information to be proprietary, and thus CAS numbers and other limited information may not be available for release.

In no event shall TI's liability arising out of such information exceed the total purchase price of the TI part(s) at issue in this document sold by TI to Customer on an annual basis.

TAPE AND REEL INFORMATION

QUADRANT ASSIGNMENTS FOR PIN 1 ORIENTATION IN TAPE

*All dimensions are nominal

Device	Package Type	Package Drawing	Pins	SPQ	Reel Diameter (mm)	Reel Width W1 (mm)	A0 (mm)	B0 (mm)	K0 (mm)	P1 (mm)	W (mm)	Pin1 Quadrant
SN74AC241DBR	SSOP	DB	20	2000	330.0	16.4	8.2	7.5	2.5	12.0	16.0	Q1
SN74AC241DWR	SOIC	DW	20	2000	330.0	24.4	10.8	13.3	2.7	12.0	24.0	Q1
SN74AC241NSR	SOP	NS	20	2000	330.0	24.4	8.4	13.0	2.5	12.0	24.0	Q1
SN74AC241PWR	TSSOP	PW	20	2000	330.0	16.4	6.95	7.1	1.6	8.0	16.0	Q1
SN74AC241PWR	TSSOP	PW	20	2000	330.0	16.4	6.95	7.0	1.4	8.0	16.0	Q1

TAPE AND REEL BOX DIMENSIONS



*All dimensions are nominal

Device	Package Type	Package Drawing	Pins	SPQ	Length (mm)	Width (mm)	Height (mm)
SN74AC241DBR	SSOP	DB	20	2000	356.0	356.0	35.0
SN74AC241DWR	SOIC	DW	20	2000	367.0	367.0	45.0
SN74AC241NSR	SOP	NS	20	2000	367.0	367.0	45.0
SN74AC241PWR	TSSOP	PW	20	2000	356.0	356.0	35.0
SN74AC241PWR	TSSOP	PW	20	2000	353.0	353.0	32.0

TUBE

*All dimensions are nominal

Device	Package Name	Package Type	Pins	SPQ	L (mm)	W (mm)	T (μm)	B (mm)
SN74AC241N	N	PDIP	20	20	506	13.97	11230	4.32

N (R-PDIP-T**)

PLASTIC DUAL-IN-LINE PACKAGE

16 PINS SHOWN



- NOTES:
- A. All linear dimensions are in inches (millimeters).
 - B. This drawing is subject to change without notice.
 - Falls within JEDEC MS-001, except 18 and 20 pin minimum body length (Dim A).
 - The 20 pin end lead shoulder width is a vendor option, either half or full width.

DW0020A



PACKAGE OUTLINE

SOIC - 2.65 mm max height

SOIC



NOTES:

1. All linear dimensions are in millimeters. Dimensions in parenthesis are for reference only. Dimensioning and tolerancing per ASME Y14.5M.
2. This drawing is subject to change without notice.
3. This dimension does not include mold flash, protrusions, or gate burrs. Mold flash, protrusions, or gate burrs shall not exceed 0.15 mm per side.
4. This dimension does not include interlead flash. Interlead flash shall not exceed 0.43 mm per side.
5. Reference JEDEC registration MS-013.

EXAMPLE BOARD LAYOUT

DW0020A

SOIC - 2.65 mm max height

SOIC



LAND PATTERN EXAMPLE
SCALE:6X



SOLDER MASK DETAILS

4220724/A 05/2016

NOTES: (continued)

- 6. Publication IPC-7351 may have alternate designs.
- 7. Solder mask tolerances between and around signal pads can vary based on board fabrication site.

EXAMPLE STENCIL DESIGN

DW0020A

SOIC - 2.65 mm max height

SOIC



SOLDER PASTE EXAMPLE
BASED ON 0.125 mm THICK STENCIL
SCALE:6X

4220724/A 05/2016

NOTES: (continued)

8. Laser cutting apertures with trapezoidal walls and rounded corners may offer better paste release. IPC-7525 may have alternate design recommendations.
9. Board assembly site may have different recommendations for stencil design.

PW0020A



PACKAGE OUTLINE
TSSOP - 1.2 mm max height

SMALL OUTLINE PACKAGE



4220206/A 02/2017

EXAMPLE BOARD LAYOUT

PW0020A

TSSOP - 1.2 mm max height

SMALL OUTLINE PACKAGE



LAND PATTERN EXAMPLE
EXPOSED METAL SHOWN
SCALE: 10X



4220206/A 02/2017

NOTES: (continued)

- 6. Publication IPC-7351 may have alternate designs.
- 7. Solder mask tolerances between and around signal pads can vary based on board fabrication site.

EXAMPLE STENCIL DESIGN

PW0020A

TSSOP - 1.2 mm max height

SMALL OUTLINE PACKAGE



SOLDER PASTE EXAMPLE
BASED ON 0.125 mm THICK STENCIL
SCALE: 10X

4220206/A 02/2017

NOTES: (continued)

8. Laser cutting apertures with trapezoidal walls and rounded corners may offer better paste release. IPC-7525 may have alternate design recommendations.
9. Board assembly site may have different recommendations for stencil design.

DB0020A



PACKAGE OUTLINE

SSOP - 2 mm max height

SMALL OUTLINE PACKAGE



4214851/B 08/2019

NOTES:

1. All linear dimensions are in millimeters. Any dimensions in parenthesis are for reference only. Dimensioning and tolerancing per ASME Y14.5M.
2. This drawing is subject to change without notice.
3. This dimension does not include mold flash, protrusions, or gate burrs. Mold flash, protrusions, or gate burrs shall not exceed 0.15 mm per side.
4. This dimension does not include interlead flash. Interlead flash shall not exceed 0.25 mm per side.
5. Reference JEDEC registration MO-150.

EXAMPLE BOARD LAYOUT

DB0020A

SSOP - 2 mm max height

SMALL OUTLINE PACKAGE



LAND PATTERN EXAMPLE
EXPOSED METAL SHOWN
SCALE: 10X



4214851/B 08/2019

NOTES: (continued)

- 6. Publication IPC-7351 may have alternate designs.
- 7. Solder mask tolerances between and around signal pads can vary based on board fabrication site.

EXAMPLE STENCIL DESIGN

DB0020A

SSOP - 2 mm max height

SMALL OUTLINE PACKAGE



SOLDER PASTE EXAMPLE
BASED ON 0.125 mm THICK STENCIL
SCALE: 10X

4214851/B 08/2019

NOTES: (continued)

8. Laser cutting apertures with trapezoidal walls and rounded corners may offer better paste release. IPC-7525 may have alternate design recommendations.
9. Board assembly site may have different recommendations for stencil design.

MECHANICAL DATA

NS (R-PDSO-G**)

PLASTIC SMALL-OUTLINE PACKAGE

14-PINS SHOWN



- NOTES:
- A. All linear dimensions are in millimeters.
 - B. This drawing is subject to change without notice.
 - C. Body dimensions do not include mold flash or protrusion, not to exceed 0,15.

重要なお知らせと免責事項

TI は、技術データと信頼性データ (データシートを含みます)、設計リソース (リファレンス・デザインを含みます)、アプリケーションや設計に関する各種アドバイス、Web ツール、安全性情報、その他のリソースを、欠陥が存在する可能性のある「現状のまま」提供しており、商品性および特定目的に対する適合性の黙示保証、第三者の知的財産権の非侵害保証を含むいかなる保証も、明示的または黙示的にかかわらず拒否します。

これらのリソースは、TI 製品を使用する設計の経験を積んだ開発者への提供を意図したものです。(1) お客様のアプリケーションに適した TI 製品の選定、(2) お客様のアプリケーションの設計、検証、試験、(3) お客様のアプリケーションに該当する各種規格や、その他のあらゆる安全性、セキュリティ、規制、または他の要件への確実な適合に関する責任を、お客様のみが単独で負うものとし、

上記の各種リソースは、予告なく変更される可能性があります。これらのリソースは、リソースで説明されている TI 製品を使用するアプリケーションの開発の目的でのみ、TI はその使用をお客様に許諾します。これらのリソースに関して、他の目的で複製することや掲載することは禁止されています。TI や第三者の知的財産権のライセンスが付与されている訳ではありません。お客様は、これらのリソースを自身で使用した結果発生するあらゆる申し立て、損害、費用、損失、責任について、TI およびその代理人を完全に補償するものとし、TI は一切の責任を拒否します。

TI の製品は、[TI の販売条件](#)、または [ti.com](#) やかかる TI 製品の関連資料などのいずれかを通じて提供する適用可能な条項の下で提供されています。TI がこれらのリソースを提供することは、適用される TI の保証または他の保証の放棄の拡大や変更を意味するものではありません。

お客様がいかなる追加条項または代替条項を提案した場合でも、TI はそれらに異議を唱え、拒否します。

郵送先住所 : Texas Instruments, Post Office Box 655303, Dallas, Texas 75265
Copyright © 2024, Texas Instruments Incorporated