

TL331B-Q1、TL391B-Q1、TL331-Q1 車載用シングルコンパレータ

1 特長

- 車載アプリケーション認定済み
- 以下の結果で AEC-Q100 認定済み:
 - デバイス温度グレード 0: -40°C ~ 150°C の周囲動作温度範囲 (E バージョン)
 - デバイス温度グレード 1: 動作時周囲温度範囲 -40°C ~ 125°C (B および Q バージョン)
 - デバイス温度グレード 3: -40°C ~ 85°C の周囲動作温度範囲 (I バージョン)
 - デバイス HBM ESD 分類レベル 2
 - デバイス CDM ESD 分類レベル C5
- 新しい **TL331B-Q1** および **TL391B-Q1**
- 広い電源電圧範囲、 2V ~ 36V
- 電源電圧にかかわらず低い電源電流ドレイン: 標準値 0.43mA (B バージョン)
- 低い入力バイアス電流、 3.5nA (B バージョン)
- 低い入力オフセット電圧、代表値 0.37mV (B バージョン)
- 差動入力電圧範囲は最大定格電源電圧と同じ、 $\pm 36\text{V}$
- 入力範囲はグラウンドを含む
- **ピン配置が異なる TL391B-Q1**
- TTL、MOS、CMOS 互換出力

2 アプリケーション

- 車載用
- HEV/EV およびパワートレイン
- インフォテインメントおよびクラスタ
- ボディコントロール モジュール

3 概要

TL331B-Q1 および **TL391B-Q1** デバイスは、業界標準の **TL331-Q1** コンパレータの次世代バージョンです。これらの次世代デバイスは、小さいオフセット電圧、高い電源電圧への対応、小さい消費電流、小さい入力バイアス電流、小さい伝搬遅延、専用の ESD 保護セル、負電圧入力対応の改善などの特長があり、コストの制約が厳しい用途で大きな価値を提供します。TL331B-Q1 は、TL331-Q1 の「I」バージョンと「Q」バージョンの両方にそのまま代替可能です。TL391B-Q1 は、TL331B-Q1 のピン配置が異なる製品です。TL331E-Q1 は温度範囲が 150°C まで拡張され、AEC-Q100 グレード 0 の温度要件を満たしています。

このデバイスは、広い電圧範囲にわたって単一電源で動作するように設計されたシングル電圧コンパレータです。デュアル電源での動作も可能です。この場合、2 つの電源の差が 2V ~ 36V で、 V_{CC} が入力同相電圧よりも 1.5V 以上高いことが条件です。電流ドレインは、電源電圧に依存しません。出力を他のオープンコレクタ出力に接続して、ワイヤード AND の関係を構成できます。

製品情報

部品番号	パッケージ (1)	本体サイズ (公称)
TL331B-Q1、 TL391B-Q1、 TL331-Q1、 TL331E-Q1	SOT-23 (5)	2.90mm × 1.60mm

(1) 利用可能なすべてのパッケージについては、データシートの末尾にある注文情報を参照してください。

ファミリ比較表

仕様	TL331B-Q1 TL391B-Q1	TL331I-Q1	TL331Q-Q1	TL331E-Q1	単位
電源電圧	2~36	2~36	2~36	2~36	V
総電源電流 (5V~36V (最大値))	0.43	0.7	0.7	0.7	mA
温度範囲	-40~125	-40~85	-40~125	-40~150	$^{\circ}\text{C}$
静電気放電 (HBM)	2000	2000	2000	2000	V
オフセット電圧 (全温度範囲での最大値)	± 4	± 9	± 9	± 9	mV
入力バイアス電流 (標準値 / 最大値)	3.5 / 25	25 / 250	25 / 250	25 / 250	nA
応答時間 (標準値)	1	1.3	1.3	1.3	μsec



Table of Contents

1 特長	1	5.11 Typical Characteristics.....	8
2 アプリケーション	1	6 Detailed Description	14
3 概要	1	6.1 Overview.....	14
4 Pin Configuration and Functions	3	6.2 Functional Block Diagram.....	14
5 Specifications	4	6.3 Feature Description.....	14
5.1 Absolute Maximum Ratings, TL331-Q1, TL331E-Q1.....	4	6.4 Device Functional Modes.....	15
5.2 Absolute Maximum Ratings, TL331B-Q1 and TL391B-Q1.....	4	7 Application and Implementation	16
5.3 ESD Ratings, All Devices.....	4	7.1 Application Information.....	16
5.4 Recommended Operating Conditions, TL331- Q1, TL331E-Q1.....	5	7.2 Typical Application.....	16
5.5 Recommended Operating Conditions, TL331B- Q1 and TL391B-Q1.....	5	7.3 Power Supply Recommendations.....	18
5.6 Thermal Information.....	5	7.4 Layout.....	18
5.7 Electrical Characteristics, TL331B-Q1 and TL391B-Q1.....	6	8 Device and Documentation Support	19
5.8 Switching Characteristics, TL331B-Q1 and TL391B-Q1.....	6	8.1 Documentation Support.....	19
5.9 Electrical Characteristics, TL331-Q1, TL331E-Q1.....	7	8.2 Receiving Notification of Documentation Updates....	19
5.10 Switching Characteristics, TL331-Q1, TL331E- Q1.....	7	8.3 サポート・リソース.....	19
		8.4 Trademarks.....	19
		8.5 静電気放電に関する注意事項.....	19
		8.6 用語集.....	19
		9 Revision History	20
		10 Mechanical, Packaging, and Orderable Information	20

4 Pin Configuration and Functions

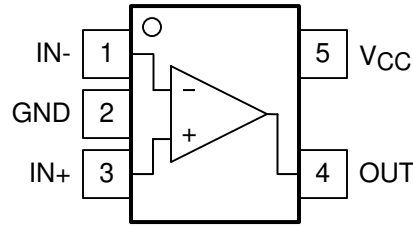

Note reversed inputs compared to similar popular pinout

4-1. TL331-Q1, TL331B-Q1 DBV Package
5-Pin SOT-23
Top View

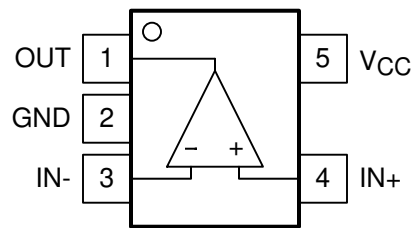

Note reversed inputs compared to similar popular pinout



4-2. TL391B-Q1 DBV Package
5-Pin SOT-23
Top View

表 4-1. Pin Functions

NAME	PIN		TYPE	DESCRIPTION
	TL331-Q1, TL331B-Q1 NO.	TL391B-Q1 NO.		
IN+	3	4	I	Positive Input
IN-	1	3	I	Negative Input
OUT	4	1	O	Open Collector/Drain Output
V _{CC}	5	5	—	Power Supply Input
GND	2	2	—	Ground

5 Specifications

5.1 Absolute Maximum Ratings, TL331-Q1, TL331E-Q1

over operating free-air temperature range (unless otherwise noted)⁽¹⁾

	MIN	MAX	UNIT
V _{CC} Supply voltage ⁽²⁾	0	36	V
V _{ID} Differential input voltage ⁽³⁾	-36	36	V
V _I Input voltage range (either input)	-0.3	36	V
V _O Output voltage	0	36	V
I _O Output current	0	20	mA
Duration of output short-circuit to ground ⁽⁴⁾	Unlimited		
T _J Operating virtual junction temperature	150		°C
T _{stg} Storage temperature	-65	150	°C

- (1) Stresses beyond those listed under *Absolute Maximum Ratings* can cause permanent damage to the device. These are stress ratings only, which do not imply functional operation of the device at these or any other conditions beyond those indicated under *Recommended Operating Conditions*. Exposure to absolute-maximum-rated conditions for extended periods can affect device reliability.
- (2) All voltage values, except differential voltages, are with respect to the network ground.
- (3) Differential voltages are at IN+ with respect to IN-.
- (4) Short circuits from outputs to V_{CC} can cause excessive heating and eventual destruction.

5.2 Absolute Maximum Ratings, TL331B-Q1 and TL391B-Q1

over operating free-air temperature range (unless otherwise noted)⁽¹⁾

	MIN	MAX	UNIT
V _{CC} Supply voltage ⁽²⁾	-0.3	38	V
V _{ID} Differential input voltage ⁽³⁾	-38	38	V
V _I Input voltage range (either input)	-0.3	38	V
V _O Output voltage	-0.3	38	V
I _O Output current		20	mA
Duration of output short-circuit to ground ⁽⁴⁾	Unlimited		
I _{IK} Input current ⁽⁵⁾		-50	mA
T _J Operating virtual junction temperature	-40	150	°C
T _{stg} Storage temperature	-65	150	°C

- (1) Stresses beyond those listed under *Absolute Maximum Ratings* can cause permanent damage to the device. These are stress ratings only, which do not imply functional operation of the device at these or any other conditions beyond those indicated under *Recommended Operating Conditions*. Exposure to absolute-maximum-rated conditions for extended periods can affect device reliability.
- (2) All voltage values, except differential voltages, are with respect to the network ground.
- (3) Differential voltages are at IN+ with respect to IN-.
- (4) Short circuits from outputs to V_{CC} can cause excessive heating and eventual destruction.
- (5) Input current flows thorough parasitic diode to ground and can turn on parasitic transistors that can increase ICC and can cause output to be incorrect. Normal operation resumes when input current is removed.

5.3 ESD Ratings, All Devices

	VALUE	UNIT
V _(ESD) Electrostatic discharge	Human-body model (HBM), per AEC Q100-002 ⁽¹⁾	±2000
	Charged-device model (CDM), per AEC Q100-0111	±750

- (1) AEC Q100-002 indicates that HBM stressing shall be in accordance with the ANSI/ESDA/JEDEC JS-001 specification.

5.4 Recommended Operating Conditions, TL331-Q1, TL331E-Q1

over operating free-air temperature range (unless otherwise noted)

		MIN	MAX	UNIT
V _{CC}	Supply voltage	2	36	V
T _J	Junction temperature, TL331IDBVRQ1	-40	85	°C
T _J	Junction temperature, TL331QDBVRQ1	-40	125	°C
T _J	Junction temperature, TL331EDBVRQ1	-40	150	°C

5.5 Recommended Operating Conditions, TL331B-Q1 and TL391B-Q1

over operating free-air temperature range (unless otherwise noted)

		MIN	MAX	UNIT
V _{CC}	Supply voltage	2	36	V
T _J	Junction temperature	-40	125	°C

5.6 Thermal Information

THERMAL METRIC ⁽¹⁾		TL331x-Q1, TL391B-Q1	UNIT
		DBV (SOT-23)	
		5 PINS	
R _{θJA}	Junction-to-ambient thermal resistance	211.7	°C/W
R _{θJC(top)}	Junction-to-case (top) thermal resistance	133.6	°C/W
R _{θJB}	Junction-to-board thermal resistance	79.9	°C/W
ψ _{JT}	Junction-to-top characterization parameter	56.4	°C/W
ψ _{JB}	Junction-to-board characterization parameter	79.6	°C/W

(1) For more information about traditional and new thermal metrics, see the [Semiconductor and IC Package Thermal Metrics](#) report.

5.7 Electrical Characteristics, TL331B-Q1 and TL391B-Q1

 $V_S = 5V$, $V_{CM} = (V_-)$; $T_A = 25^\circ C$ (unless otherwise noted).

PARAMETER		TEST CONDITIONS	MIN	TYP	MAX	UNIT
V_{IO}	Input offset voltage	$V_S = 5$ to $36V$	-2.5	± 0.37	2.5	mV
		$V_S = 5$ to $36V$, $T_A = -40^\circ C$ to $+125^\circ C$	-4		4	
I_B	Input bias current			-3.5	-25	nA
		$T_A = -40^\circ C$ to $+125^\circ C$			-50	nA
I_{OS}	Input offset current		-10	± 0.5	10	nA
		$T_A = -40^\circ C$ to $+125^\circ C$			-25	25
V_{CM}	Common mode range	$V_S = 3$ to $36V$	$(V_-) - 0.1$		$(V_+) - 1.5$	V
		$V_S = 3$ to $36V$, $T_A = -40^\circ C$ to $+125^\circ C$	$(V_-) - 0.05$		$(V_+) - 2.0$	V
A_{VD}	Large signal differential voltage amplification	$V_S = 15V$, $V_O = 1.4V$ to $11.4V$; $R_L \geq 15k$ to (V_+)	50	200		V/mV
V_{OL}	Low level output Voltage {swing from (V_-) }	$I_{SINK} \leq 4mA$, $V_{ID} = -1V$		110	400	mV
		$I_{SINK} \leq 4mA$, $V_{ID} = -1V$ $T_A = -40^\circ C$ to $+125^\circ C$			550	mV
I_{OH-LKG}	High-level output leakage current	$(V_+) = V_O = 5V$; $V_{ID} = 1V$		0.1	20	nA
I_{OH-LKG}	High-level output leakage current	$(V_+) = V_O = 36V$; $V_{ID} = 1V$; $T_A = -40^\circ C$ to $+125^\circ C$			1000	nA
I_{OL}	Low level output current	$V_{OL} = 1.5V$; $V_{ID} = -1V$; $V_S = 5V$	6	18		mA
I_Q	Quiescent current	$V_S = 5V$, no load		210	330	μA
		$V_S = 36V$, no load, $T_A = -40^\circ C$ to $+125^\circ C$		275	430	μA

5.8 Switching Characteristics, TL331B-Q1 and TL391B-Q1

 $V_S = 5V$, $V_{O_PULLUP} = 5V$, $V_{CM} = V_S/2$, $C_L = 15pF$, $R_L = 5.1k\ \Omega$, $T_A = 25^\circ C$ (unless otherwise noted).

PARAMETER		TEST CONDITIONS	MIN	TYP	MAX	UNIT
$t_{response}$	Propagation delay time, high-to-low; Small scale input signal ⁽¹⁾	Input overdrive = 5mV, Input step = 100mV		1000		ns
$t_{response}$	Propagation delay time, high-to-low; TTL input signal ⁽¹⁾	TTL input with $V_{ref} = 1.4V$		300		ns

(1) High-to-low and low-to-high refers to the transition at the input.

5.9 Electrical Characteristics, TL331-Q1, TL331E-Q1

at specified free-air temperature, $V_{CC} = 5V$ (unless otherwise noted)

PARAMETER		TEST CONDITIONS ⁽¹⁾	T_A	MIN	TYP	MAX	UNIT
V_{IO}	Input offset voltage	$V_{CC} = 5V$ to $30V$, $V_O = 1.4V$, $V_{IC} = V_{IC(min)}$	25°C		2	5	mV
			Over Temp			9	
I_{IO}	Input offset current	$V_O = 1.4V$	25°C		5	50	nA
			Over Temp			250	
I_{IB}	Input bias current	$V_O = 1.4V$	25°C		-25	-250	nA
			Over Temp			-400	
V_{ICR}	Common-mode input voltage range ⁽²⁾		25°C	0 to $V_{CC} - 1.5$		V	
			Over Temp	0 to $V_{CC} - 2$			
A_{VD}	Large-signal differential-voltage amplification	$V_{CC} = 15V$, $V_O = 1.4V$ to $11.4V$, $R_L \geq 15k\Omega$ to V_{CC}	25°C	50	200		V/mV
I_{OH}	High-level output current	$V_{OH} = 5V$, $V_{ID} = 1V$	25°C		0.1	50	nA
		$V_{OH} = 30V$, $V_{ID} = 1V$	Over Temp			1	μA
V_{OL}	Low-level output voltage	$I_{OL} = 4mA$, $V_{ID} = -1V$	25°C		150	400	mV
			Over Temp			700	
I_{OL}	Low-level output current	$V_{OL} = 1.5V$, $V_{ID} = -1V$	25°C	6			mA
I_{CC}	Supply current	$R_L = \infty$, $V_{CC} = 5V$	25°C		0.4	0.7	mA

(1) All characteristics are measured with zero common-mode input voltage, unless otherwise specified.

(2) The voltage at either input or common-mode can not be allowed to go negative by more than 0.3V. The upper end of the common-mode voltage range is $V_{CC+} - 1.5V$ at 25°C, but either or both inputs can go to 30V without damage.

5.10 Switching Characteristics, TL331-Q1, TL331E-Q1

$V_{CC} = 5V$, $T_A = 25^\circ C$

PARAMETER	TEST CONDITIONS		TYP	UNIT
Response time	R_L connected to 5V through 5.1k Ω , $C_L = 15pF$ ^{(1) (2)}	100mV input step with 5mV overdrive	1.3	μs
		TTL-level input step	0.3	

(1) C_L includes probe and jig capacitance.

(2) The response time specified is the interval between the input step function and the instant when the output crosses 1.4V.

5.11 Typical Characteristics

$T_A = 25^\circ\text{C}$, $V_S = 5\text{V}$, $R_{\text{PULLUP}} = 5.1\text{k}$, $C_L = 15\text{pF}$, $V_{\text{CM}} = 0\text{V}$, $V_{\text{UNDERDRIVE}} = 100\text{mV}$, $V_{\text{OVERDRIVE}} = 100\text{mV}$ unless otherwise noted.

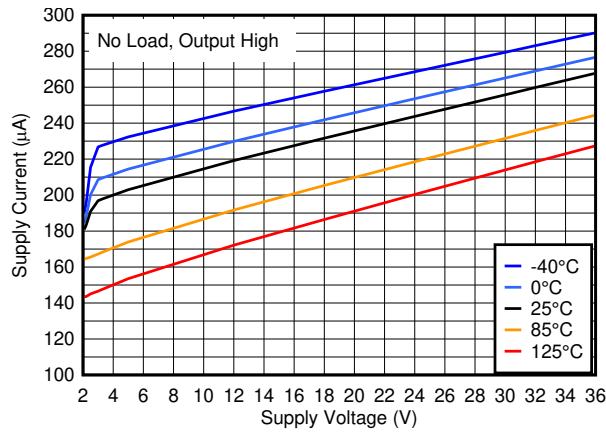

Figure 5-1. Supply Current vs. Supply Voltage

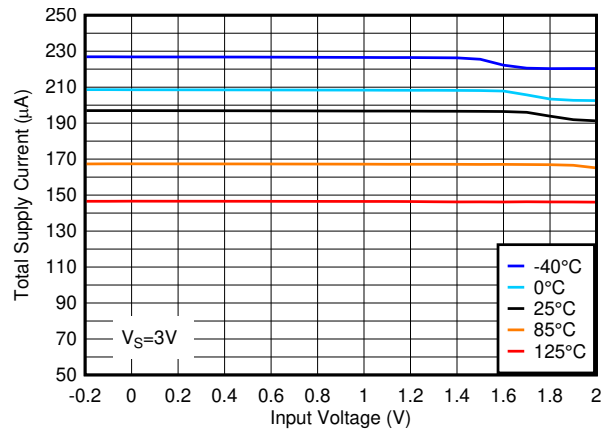

Figure 5-2. Total Supply Current vs. Input Voltage at 3V

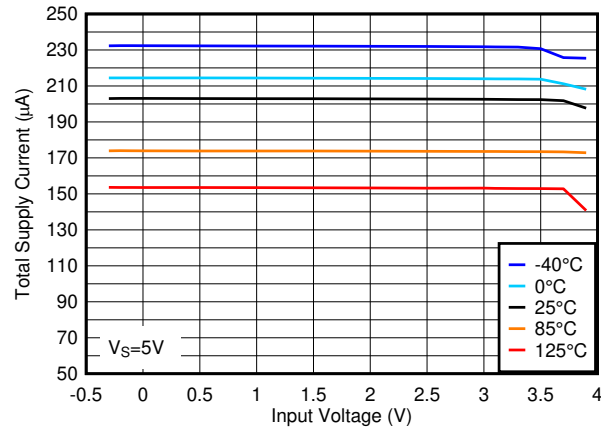

Figure 5-3. Total Supply Current vs. Input Voltage at 3.3V

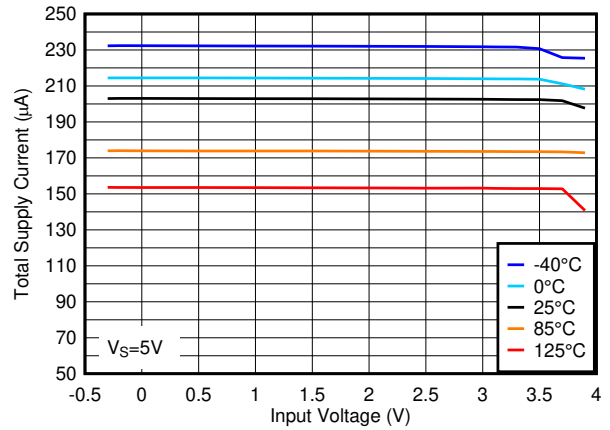

Figure 5-4. Total Supply Current vs. Input Voltage at 5V

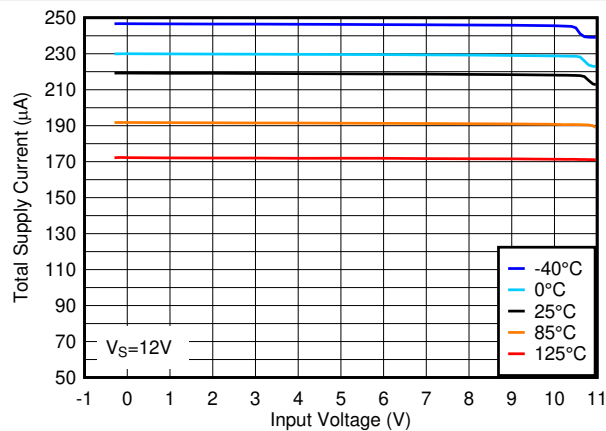

Figure 5-5. Total Supply Current vs. Input Voltage at 12V

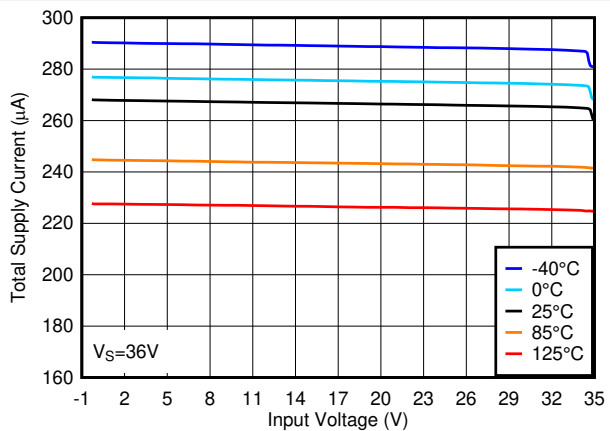
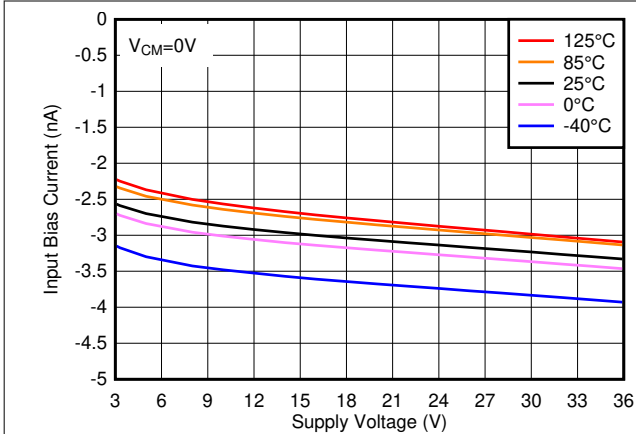

Figure 5-6. Total Supply Current vs. Input Voltage at 36V

5.11 Typical Characteristics (continued)

$T_A = 25^\circ\text{C}$, $V_S = 5\text{V}$, $R_{\text{PULLUP}} = 5.1\text{k}$, $C_L = 15\text{pF}$, $V_{\text{CM}} = 0\text{V}$, $V_{\text{UNDERDRIVE}} = 100\text{mV}$, $V_{\text{OVERDRIVE}} = 100\text{mV}$ unless otherwise noted.



5-7. Input Bias Current vs. Supply Voltage

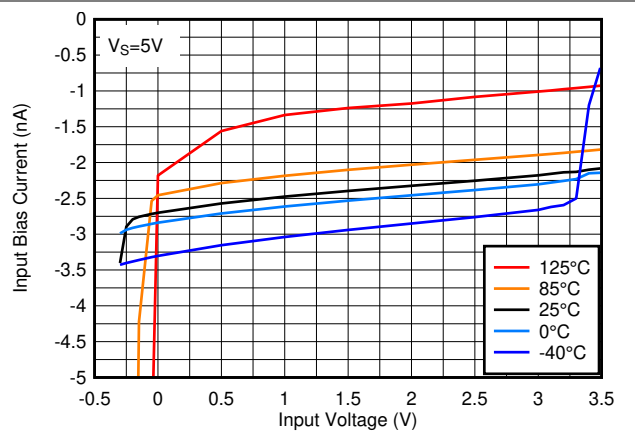

5-8. Input Bias Current vs. Input Voltage at 5V

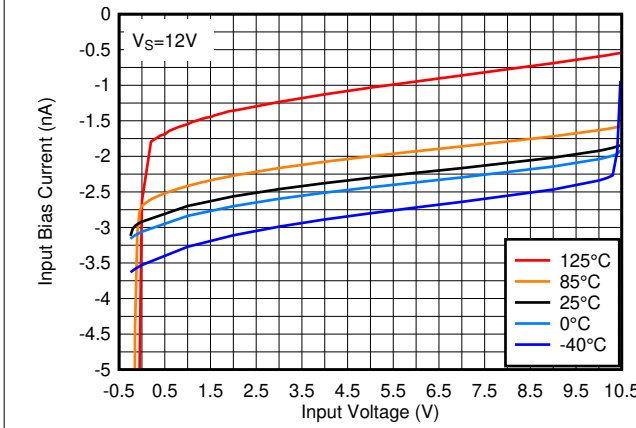

5-9. Input Bias Current vs. Input Voltage at 12V

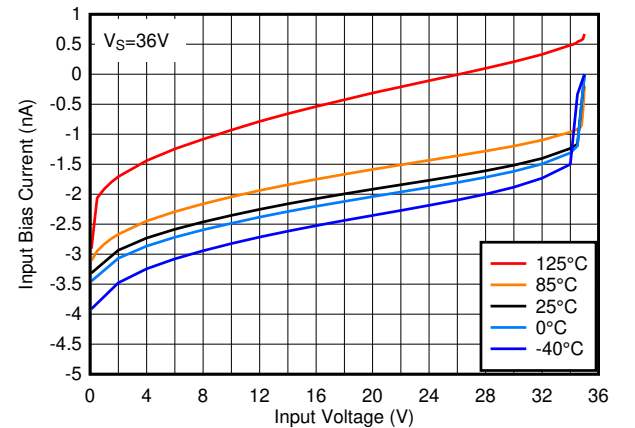

5-10. Input Bias Current vs. Input Voltage at 36V

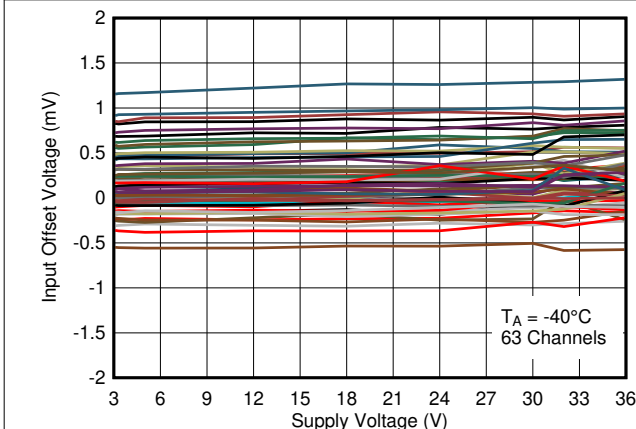

5-11. Input Offset Voltage vs. Supply Voltage at -40°C

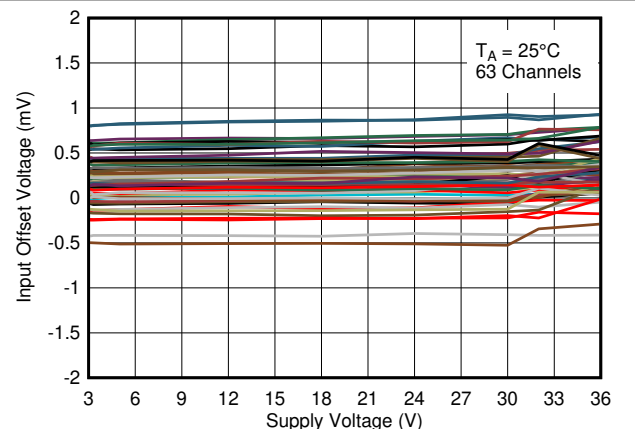

5-12. Input Offset Voltage vs. Supply Voltage at 25°C

5.11 Typical Characteristics (continued)

$T_A = 25^\circ\text{C}$, $V_S = 5\text{V}$, $R_{\text{PULLUP}} = 5.1\text{k}$, $C_L = 15\text{pF}$, $V_{\text{CM}} = 0\text{V}$, $V_{\text{UNDERDRIVE}} = 100\text{mV}$, $V_{\text{OVERDRIVE}} = 100\text{mV}$ unless otherwise noted.

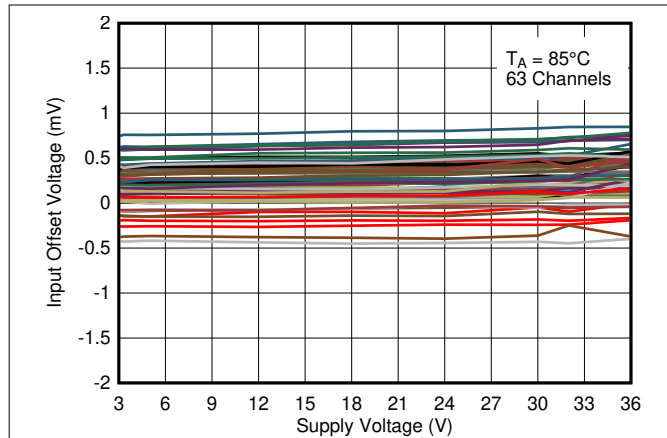

5-13. Input Offset Voltage vs. Supply Voltage at 85°C

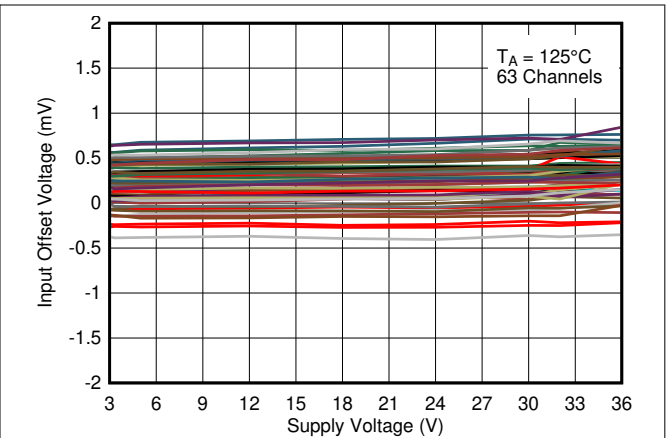

5-14. Input Offset Voltage vs. Supply Voltage at 125°C

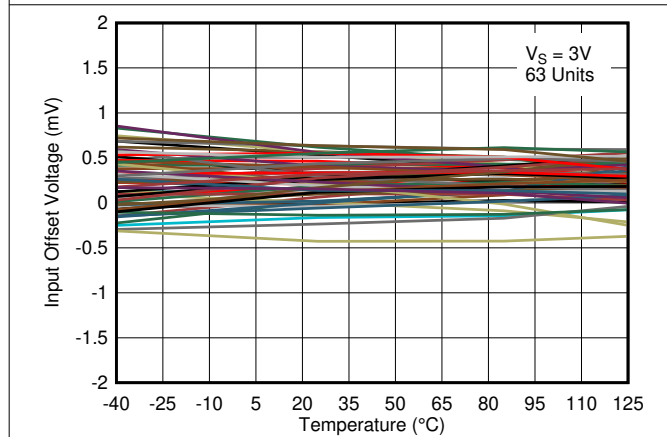

5-15. Input Offset Voltage vs. Temperature at 3V

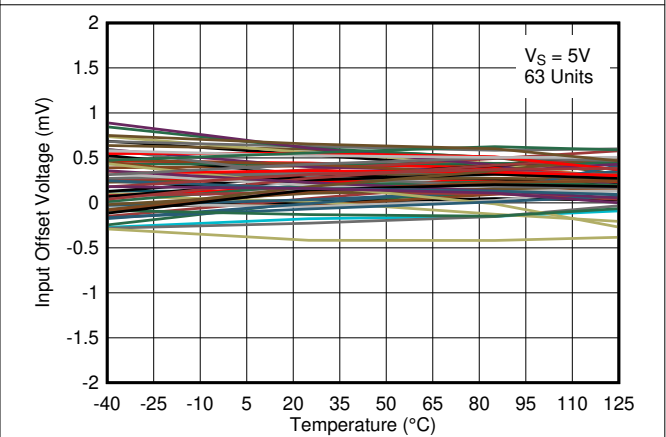

5-16. Input Offset Voltage vs. Temperature at 5V

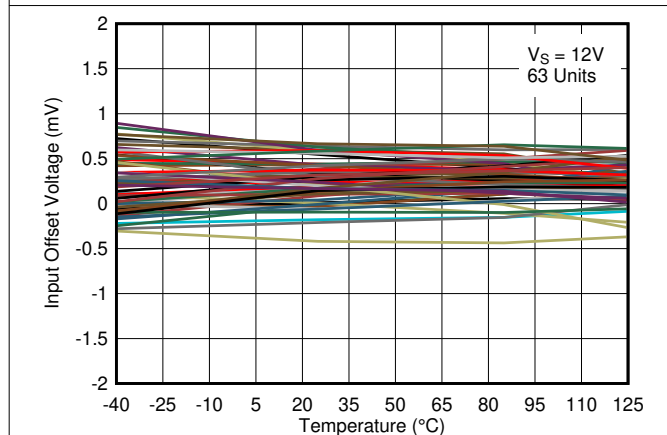

5-17. Input Offset Voltage vs. Temperature at 12V

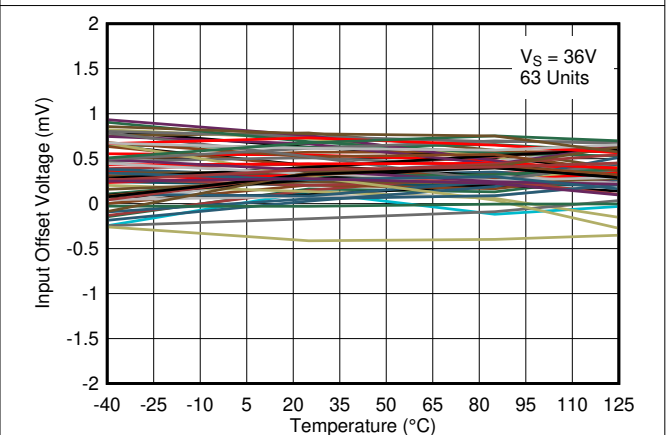

5-18. Input Offset Voltage vs. Temperature at 36V

5.11 Typical Characteristics (continued)

$T_A = 25^\circ\text{C}$, $V_S = 5\text{V}$, $R_{\text{PULLUP}} = 5.1\text{k}$, $C_L = 15\text{pF}$, $V_{\text{CM}} = 0\text{V}$, $V_{\text{UNDERDRIVE}} = 100\text{mV}$, $V_{\text{OVERDRIVE}} = 100\text{mV}$ unless otherwise noted.

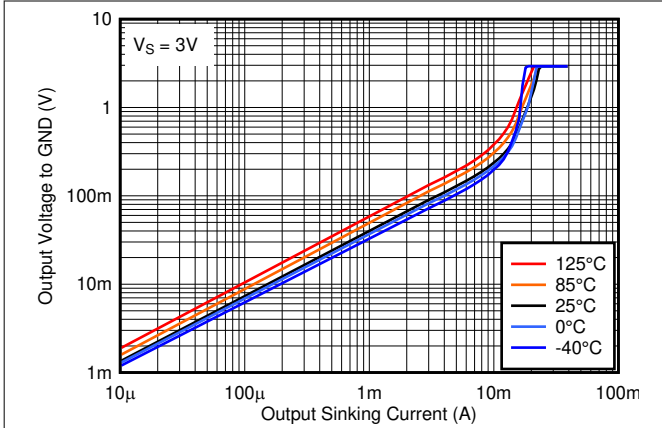

5-19. Output Low Voltage vs. Output Sinking Current at 3V

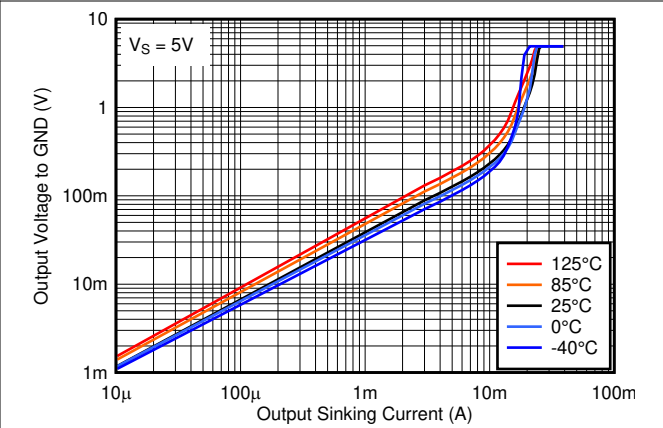

5-20. Output Low Voltage vs. Output Sinking Current at 5V

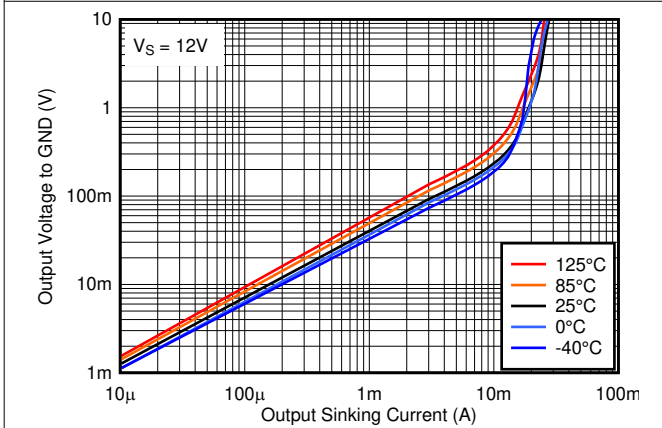

5-21. Output Low Voltage vs. Output Sinking Current at 12V

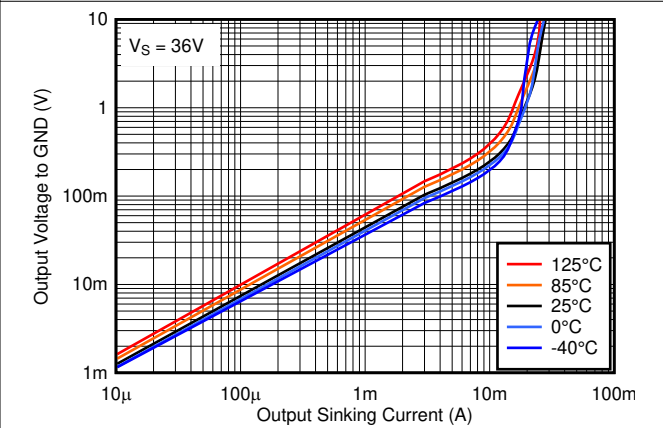

5-22. Output Low Voltage vs. Output Sinking Current at 36V

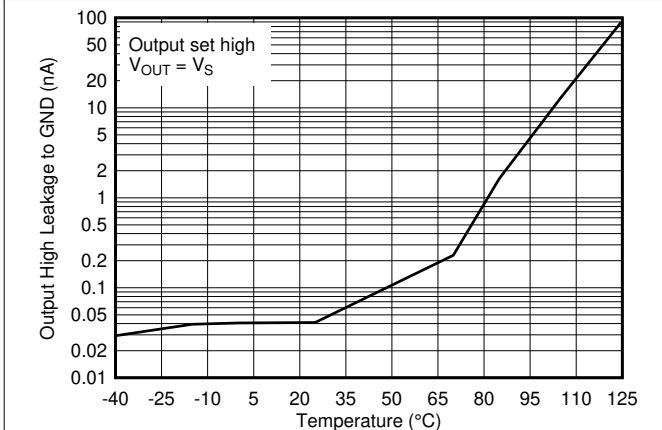

5-23. Output High Leakage Current vs. Temperature at 5V

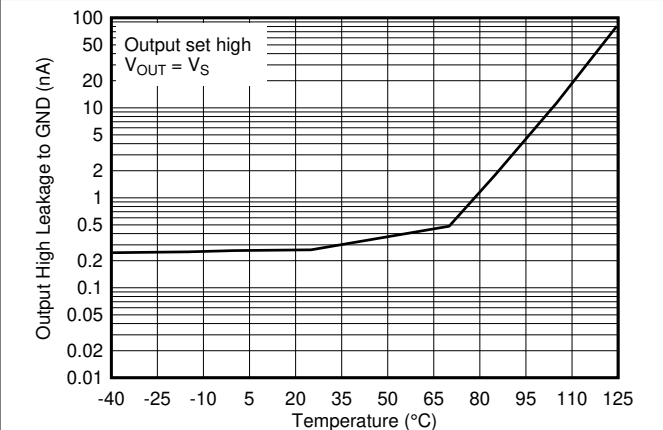

5-24. Output High Leakage Current vs. Temperature at 36V

5.11 Typical Characteristics (continued)

$T_A = 25^\circ\text{C}$, $V_S = 5\text{V}$, $R_{\text{PULLUP}} = 5.1\text{k}$, $C_L = 15\text{pF}$, $V_{\text{CM}} = 0\text{V}$, $V_{\text{UNDERDRIVE}} = 100\text{mV}$, $V_{\text{OVERDRIVE}} = 100\text{mV}$ unless otherwise noted.

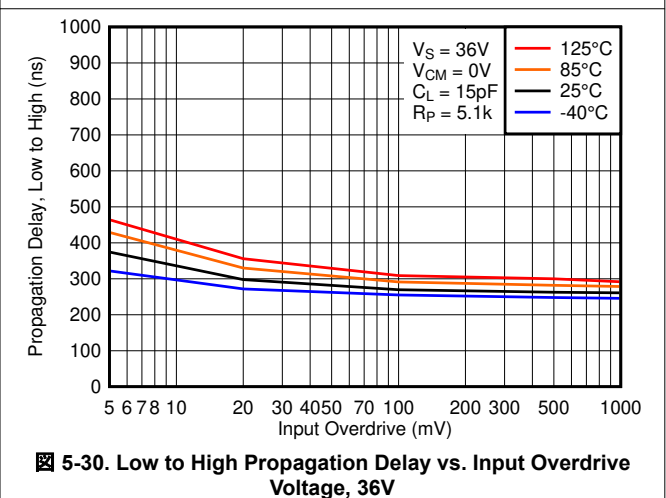
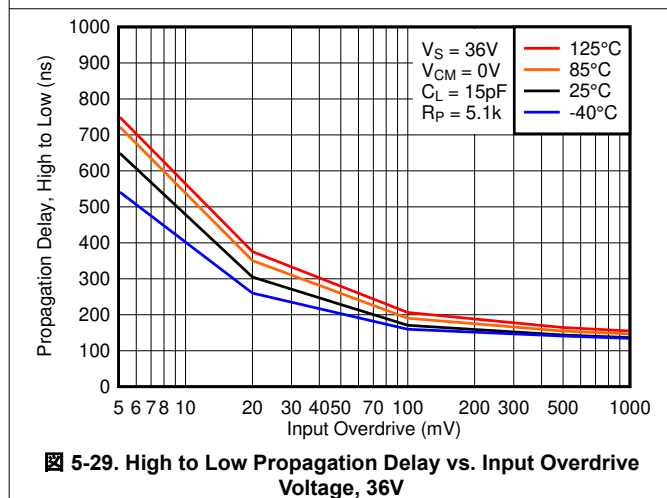
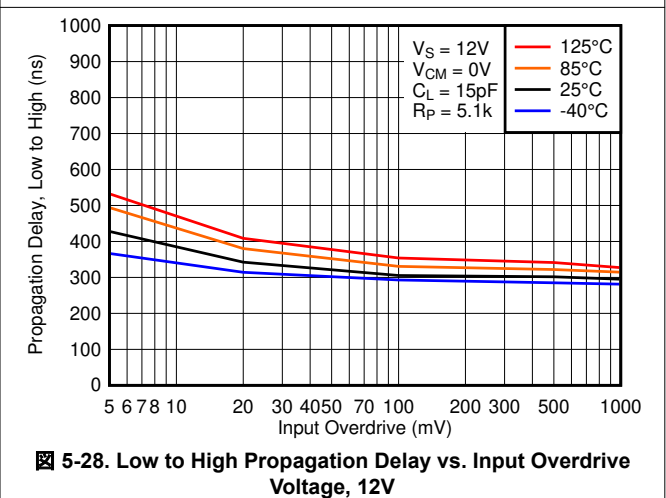
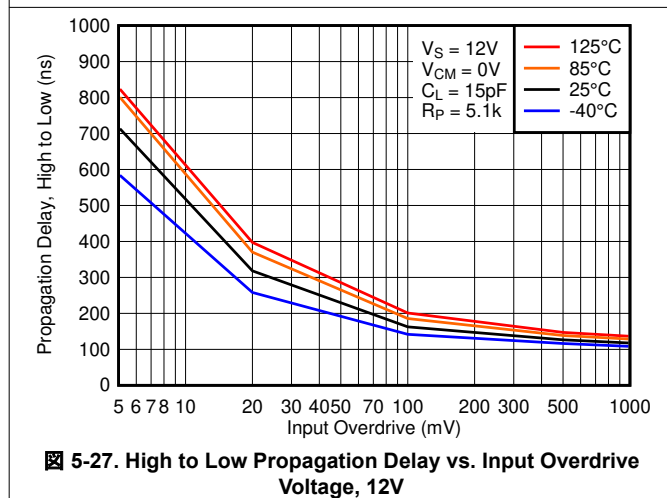
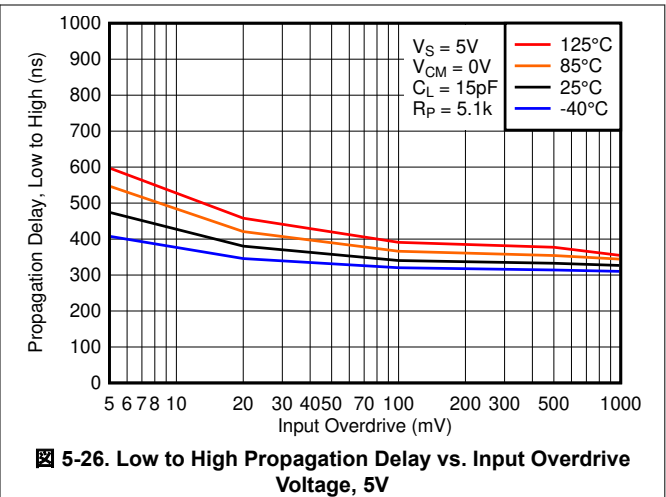
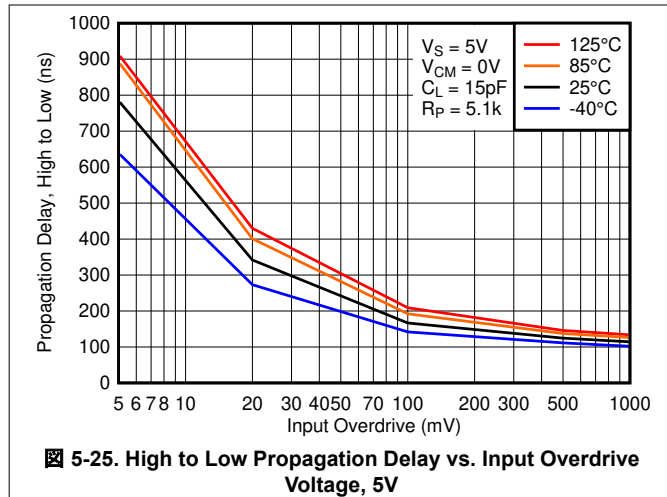

5.11 Typical Characteristics (continued)

$T_A = 25^\circ\text{C}$, $V_S = 5\text{V}$, $R_{\text{PULLUP}} = 5.1\text{k}$, $C_L = 15\text{pF}$, $V_{\text{CM}} = 0\text{V}$, $V_{\text{UNDERDRIVE}} = 100\text{mV}$, $V_{\text{OVERDRIVE}} = 100\text{mV}$ unless otherwise noted.



5-31. Response Time for Various Overdrives, High-to-Low Transition



5-32. Response Time for Various Overdrives, Low-to-High Transition

6 Detailed Description

6.1 Overview

The TL331-Q1 is a single comparator with the ability to operate up to 36V on the supply pin. This standard device has proven ubiquity and versatility across a wide range of applications. This is due to the very wide supply voltage range (2V to 36V), low I_q , and fast response.

The open-collector output allows the user to configure the output's logic low voltage (V_{OL}) and can be utilized to enable the comparator to be used in AND functionality.

The TL331B-Q1 and TL391B-Q1 are performance upgrades to industry standard TL331-Q1 using the latest semiconductor process technologies that allows for lower offset voltages, lower input bias and supply currents and faster response times. The TL331B can drop-in replace the "I" or "Q" versions of TL331-Q1. The TL391B-Q1 is an alternate pinout of the TL331B-Q1 for replacing competitive devices.

6.2 Functional Block Diagram

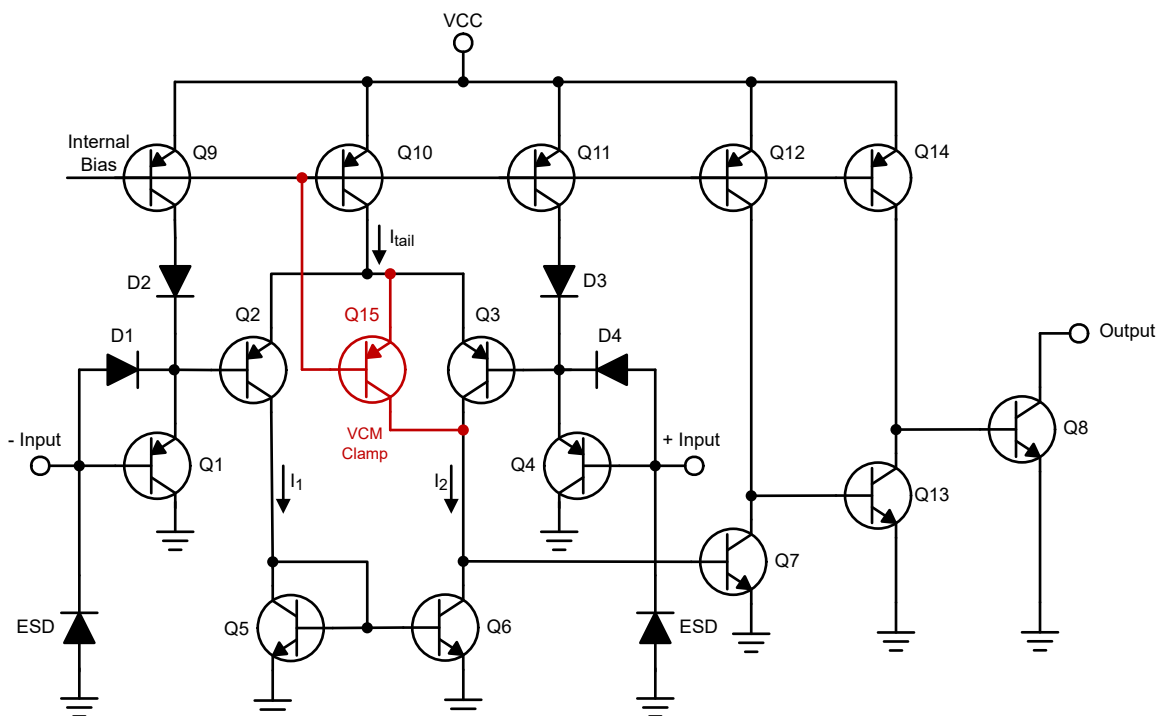

6.3 Feature Description

The TL331-Q1 consists of a PNP Darlington pair input, allowing the device to operate with very high gain and fast response with minimal input bias current. The input Darlington pair creates a limit on the input common mode voltage capability, allowing TL331-Q1 to accurately function from ground to $V_{CC} - 1.5V$ differential input. A clamp (Q15) was added around Q3 to force the output low when both inputs are taken above the VCM range.

The output consists of an open collector NPN (pull-down or low side) transistor. The output NPN sinks current when the negative input voltage is higher than the positive input voltage and the offset voltage. The V_{OL} is resistive and scales with the output current. Please see [Output Low Voltage vs. Output Sinking Current at 5V](#) for V_{OL} values with respect to the output current.

6.4 Device Functional Modes

6.4.1 Voltage Comparison

The TL331-Q1 operates solely as a voltage comparator, comparing the differential voltage between the positive and negative pins and outputting a logic low or high impedance (logic high with pull-up) based on the input differential polarity.

7 Application and Implementation

注

以下のアプリケーション情報は、TI の製品仕様に含まれるものではなく、TI ではその正確性または完全性を保証いたしません。個々の目的に対する製品の適合性については、お客様の責任で判断していただくこととなります。お客様は自身の設計実装を検証しテストすることで、システムの機能を確認する必要があります。

7.1 Application Information

TL331-Q1 is typically used to compare a single signal to a reference or two signals against each other. Many users take advantage of the open collector output to drive the comparison logic output to a logic voltage level to an MCU or logic device. The wide supply range and high voltage capability makes TL331-Q1 an excellent choice for level shifting to a higher or lower voltage.

7.2 Typical Application



図 7-1. Typical Application Schematic

7.2.1 Design Requirements

For this design example, use the parameters listed in 表 7-1 as the input parameters.

表 7-1. Design Parameters

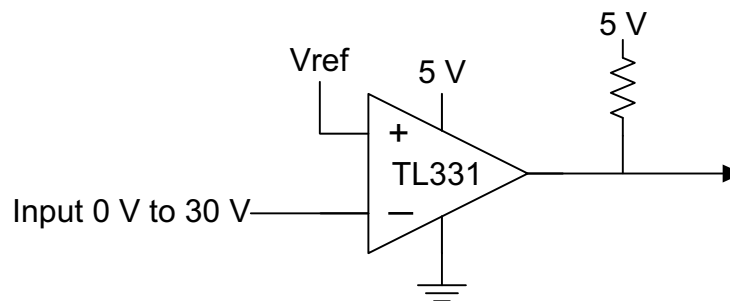
DESIGN PARAMETER	EXAMPLE VALUE
Input Voltage Range	0V to $V_{CC} - 1.5V$
Supply Voltage	2V to 36V
Logic Supply Voltage (R_{PULLUP} Voltage)	2V to 36V
Output Current (V_{LOGIC}/R_{PULLUP})	1 μ A to 4mA
Input Overdrive Voltage	100mV
Reference Voltage	2.5V
Load Capacitance (C_L)	15pF

7.2.2 Detailed Design Procedure

When using TL331-Q1 in a general comparator application, determine the following:

- Input voltage range
- Minimum overdrive voltage
- Output and drive current
- Response time

7.2.2.1 Input Voltage Range

When choosing the input voltage range, the input common mode voltage range (V_{ICR}) must be taken in to account. If temperature operation is above or below 25°C the V_{ICR} can range from 0V to $V_{CC} - 1.5V$. This limits

the input voltage range to as high as $V_{CC} - 1.5V$ and as low as 0V. Operation outside of this range can yield incorrect comparisons.

Below is a list of input voltage situation and the outcomes:

1. When both IN- and IN+ are both within the common mode range:
 - a. If IN- is higher than IN+ and the offset voltage, the output is low and the output transistor is sinking current
 - b. If IN- is lower than IN+ and the offset voltage, the output is high impedance and the output transistor is not conducting
2. When IN- is higher than common mode and IN+ is within common mode, the output is low and the output transistor is sinking current
3. When IN+ is higher than common mode and IN- is within common mode, the output is high impedance and the output transistor is not conducting
4. When IN- and IN+ are both higher than common mode, see Section 2 of [Application Design Guidelines for LM339, LM393, TL331 Family Comparators Including the New B-versions](#).

7.2.2.2 ESD Protection

The TL331x-Q1 family have dedicated ESD protection on all the pins for improved ESD performance as well as improved negative input voltage handling. Please see Application Note [SNOAA35](#) for more information.

7.2.2.3 Minimum Overdrive Voltage

Overdrive Voltage is the differential voltage produced between the positive and negative inputs of the comparator over the offset voltage (V_{IO}). To make an accurate comparison the Overdrive Voltage (V_{OD}) must exceed the input offset voltage (V_{IO}). Overdrive voltage can also determine the response time of the comparator, with the response time decreasing with increasing overdrive. [Figure 7-2](#) and [Figure 7-3](#) show positive and negative response times with respect to overdrive voltage.

7.2.2.4 Output and Drive Current

Output current is determined by the load/pull-up resistance and logic/pull-up voltage. The output current determines the output low voltage (V_{OL}) from the comparator. V_{OL} is proportional to the output current. Use [Output Low Voltage vs. Output Sinking Current at 5V](#) to determine V_{OL} based on the output current.

The output current can also effect the transient response. More is explained in the next section.

7.2.2.5 Response Time

Response time is a function of input over drive. See [Application Curves](#) for typical response times. The rise and fall times can be determined by the load capacitance (C_L), load/pullup resistance (R_{PULLUP}), and equivalent collector-emitter resistance (R_{CE}).

- The rise time (T_R) is approximately $T_R = R_{PULLUP} \times C_L$
- The fall time (T_F) is approximately $T_F = R_{CE} \times C_L$
 - R_{CE} can be determined by taking the slope of [Output Low Voltage vs. Output Sinking Current at 5V](#) in the linear region at the desired temperature, or by dividing the V_{OL} by I_{out}

7.2.3 Application Curves

The following curves were generated with 5V on V_{CC} and V_{Logic} , $R_{PULLUP} = 5.1k\Omega$, and 50pF scope probe.

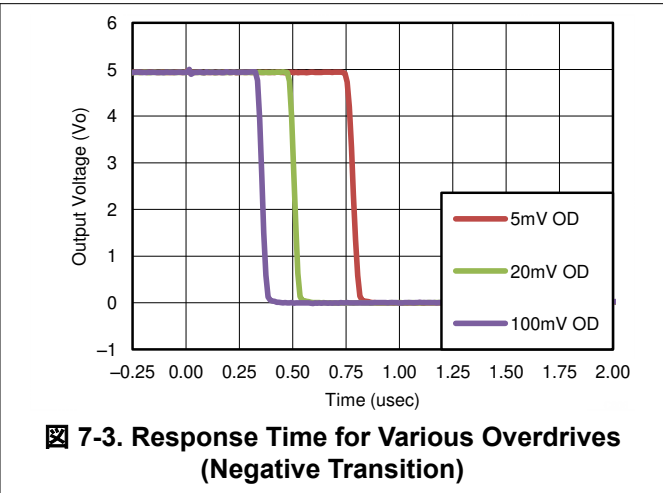
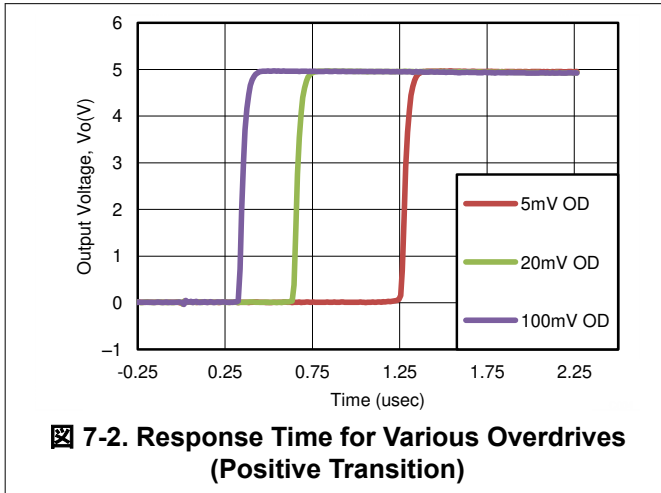

7.3 Power Supply Recommendations

For fast response and comparison applications with noisy or AC inputs, TI recommends using a bypass capacitor on the supply pin to reject any variation on the supply voltage. This variation can distort the comparator's input common mode range and create an inaccurate comparison.

7.4 Layout

7.4.1 Layout Guidelines

For accurate comparator applications without hysteresis, a stable supply is important to minimize noise and glitches, which can affect the high level input common mode voltage range. To achieve this, add a bypass capacitor between the supply voltage and ground. This must be implemented on the positive power supply and negative supply (if available). If a negative supply is not being used, tie the GND pin directly to system ground.

7.4.2 Layout Example

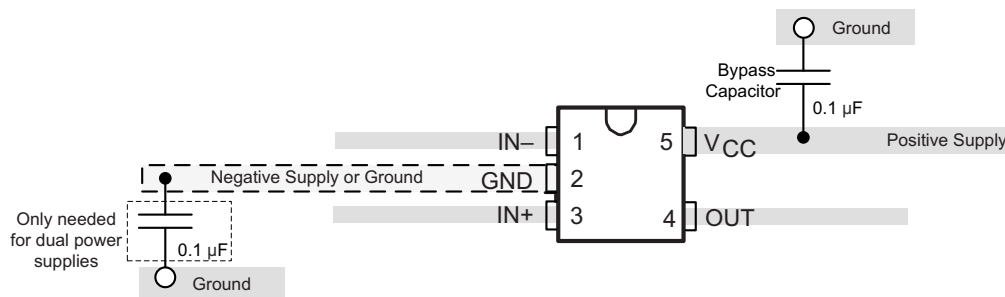

7-4. TL331-Q1 Layout Example

8 Device and Documentation Support

8.1 Documentation Support

8.1.1 Related Documentation

[Application Design Guidelines for LM339, LM393, TL331 Family Comparators](#) - SNOAA35

[Analog Engineers Circuit Cookbook: Amplifiers \(See Comparators section\)](#) - SLYY137

[Precision Design, Comparator with Hysteresis Reference Design](#)- TIDU020

[Window comparator circuit](#) - SBOA221

[Reference Design, Window Comparator Reference Design](#)- TIPD178

[Comparator with and without hysteresis circuit](#) - SBOA219

[Inverting comparator with hysteresis circuit](#) - SNOA997

[Non-Inverting Comparator With Hysteresis Circuit](#) - SBOA313

[Zero crossing detection using comparator circuit](#) - SNOA999

[A Quad of Independently Functioning Comparators](#) - SNOA654

8.2 Receiving Notification of Documentation Updates

To receive notification of documentation updates, navigate to the device product folder on ti.com. In the upper right corner, click on *Alert me* to register and receive a weekly digest of any product information that has changed. For change details, review the revision history included in any revised document.

8.3 サポート・リソース

テキサス・インスツルメンツ E2E™ サポート・フォーラムは、エンジニアが検証済みの回答と設計に関するヒントをエキスパートから迅速かつ直接得ることができる場所です。既存の回答を検索したり、独自の質問をしたりすることで、設計に必要な支援を迅速に得ることができます。

リンクされているコンテンツは、各寄稿者により「現状のまま」提供されるものです。これらはテキサス・インスツルメンツの仕様を構成するものではなく、必ずしもテキサス・インスツルメンツの見解を反映したものではありません。テキサス・インスツルメンツの[使用条件](#)を参照してください。

8.4 Trademarks

テキサス・インスツルメンツ E2E™ is a trademark of Texas Instruments.

すべての商標は、それぞれの所有者に帰属します。

8.5 静電気放電に関する注意事項



この IC は、ESD によって破損する可能性があります。テキサス・インスツルメンツは、IC を取り扱う際には常に適切な注意を払うことを推奨します。正しい取り扱いおよび設置手順に従わない場合、デバイスを破損するおそれがあります。

ESD による破損は、わずかな性能低下からデバイスの完全な故障まで多岐にわたります。精密な IC の場合、パラメータがわずかに変化するだけで公表されている仕様から外れる可能性があるため、破損が発生しやすくなっています。

8.6 用語集

[テキサス・インスツルメンツ用語集](#)

この用語集には、用語や略語の一覧および定義が記載されています。

9 Revision History

資料番号末尾の英字は改訂を表しています。その改訂履歴は英語版に準じています。

Changes from Revision G (August 2023) to Revision H (January 2025)	Page
• 全体を通して TL331E-Q1 を追加.....	1
• Removed Legacy device graphs.....	8
• Updated <i>Functional Block Diagram</i>	14
• Added mention of VCM clamp.....	14
• Updated ESD Protection Section.....	17

Changes from Revision F (January 2021) to Revision G (August 2023)	Page
• Added reference to Application Note.....	16

Changes from Revision E (November 2020) to Revision F (January 2021)	Page
• 表紙のリンク テキストで欠けていた「B」を追加.....	1

Changes from Revision D (June 2020) to Revision E (November 2020)	Page
• ドキュメント全体にわたって表、図、相互参照の採番方法を更新.....	1
• データシート全体にわたり TL331B-Q1 および TL391B-Q1 の最小推奨電源電圧を 2V に変更.....	1
• 「ファミリ比較表」ですべてのデバイスの電源電圧を訂正.....	1
• Added TL331B-Q1 and TLV391B-Q1 Typical Graphs.....	8

Changes from Revision C (October 2013) to Revision D (June 2020)	Page
• B デバイスを追加。新しい TI データシートのフォーマットに更新。表紙のテキストを変更し、B バージョンを強調。	1
• 「ファミリ比較表」を追加。	1
• 「ファミリ表」にリンクを追加.....	1

Changes from Revision B (September 2012) to Revision C (October 2013)	Page
• Changed V_{ICR} in the Electrical Characteristics.....	7
• Changed test conditions of I_{OL} in the Electrical Characteristics.....	7

Changes from Revision A (July 2010) to Revision B (September 2012)	Page
• Changed V_{ICR} in the Electrical Characteristics.....	7

10 Mechanical, Packaging, and Orderable Information

The following pages include mechanical, packaging, and orderable information. This information is the most current data available for the designated devices. This data is subject to change without notice and revision of this document. For browser-based versions of this data sheet, refer to the left-hand navigation.

重要なお知らせと免責事項

テキサス・インスツルメンツは、技術データと信頼性データ (データシートを含みます)、設計リソース (リファレンス デザインを含みます)、アプリケーションや設計に関する各種アドバイス、Web ツール、安全性情報、その他のリソースを、欠陥が存在する可能性のある「現状のまま」提供しており、商品性および特定目的に対する適合性の黙示保証、第三者の知的財産権の非侵害保証を含むいかなる保証も、明示的または黙示的にかかわらず拒否します。

これらのリソースは、テキサス・インスツルメンツ製品を使用する設計の経験を積んだ開発者への提供を意図したものです。(1) お客様のアプリケーションに適した テキサス・インスツルメンツ製品の選定、(2) お客様のアプリケーションの設計、検証、試験、(3) お客様のアプリケーションに該当する各種規格や、その他のあらゆる安全性、セキュリティ、規制、または他の要件への確実な適合に関する責任を、お客様のみが単独で負うものとします。

上記の各種リソースは、予告なく変更される可能性があります。これらのリソースは、リソースで説明されている テキサス・インスツルメンツ製品を使用するアプリケーションの開発の目的でのみ、テキサス・インスツルメンツはその使用をお客様に許諾します。これらのリソースに関して、他の目的で複製することや掲載することは禁止されています。テキサス・インスツルメンツや第三者の知的財産権のライセンスが付与されている訳ではありません。お客様は、これらのリソースを自身で使用した結果発生するあらゆる申し立て、損害、費用、損失、責任について、テキサス・インスツルメンツおよびその代理人を完全に補償するものとし、テキサス・インスツルメンツは一切の責任を拒否します。

テキサス・インスツルメンツの製品は、[テキサス・インスツルメンツの販売条件](#)、または [ti.com](https://www.ti.com) やかかる テキサス・インスツルメンツ製品の関連資料などのいずれかを通じて提供する適用可能な条項の下で提供されています。テキサス・インスツルメンツがこれらのリソースを提供することは、適用されるテキサス・インスツルメンツの保証または他の保証の放棄の拡大や変更を意味するものではありません。

お客様がいかなる追加条項または代替条項を提案した場合でも、テキサス・インスツルメンツはそれらに異議を唱え、拒否します。

郵送先住所: Texas Instruments, Post Office Box 655303, Dallas, Texas 75265

Copyright © 2025, Texas Instruments Incorporated

PACKAGING INFORMATION

Orderable part number	Status (1)	Material type (2)	Package Pins	Package qty Carrier	RoHS (3)	Lead finish/ Ball material (4)	MSL rating/ Peak reflow (5)	Op temp (°C)	Part marking (6)
TL331BQDBVRQ1	Active	Production	SOT-23 (DBV) 5	3000 LARGE T&R	Yes	NIPDAU	Level-1-260C-UNLIM	-40 to 125	31BQ
TL331BQDBVRQ1.B	Active	Production	SOT-23 (DBV) 5	3000 LARGE T&R	Yes	NIPDAU	Level-1-260C-UNLIM	-40 to 125	31BQ
TL331EDBVRQ1	Active	Production	SOT-23 (DBV) 5	3000 LARGE T&R	Yes	NIPDAU	Level-1-260C-UNLIM	-40 to 150	3ISF
TL331EDBVRQ1.A	Active	Production	SOT-23 (DBV) 5	3000 LARGE T&R	Yes	NIPDAU	Level-1-260C-UNLIM	-40 to 150	3ISF
TL331IDBVRQ1	Active	Production	SOT-23 (DBV) 5	3000 LARGE T&R	Yes	NIPDAU SN	Level-1-260C-UNLIM	-40 to 85	TQ1U
TL331IDBVRQ1.A	Active	Production	SOT-23 (DBV) 5	3000 LARGE T&R	Yes	NIPDAU	Level-1-260C-UNLIM	-40 to 85	TQ1U
TL331IDBVRQ1.B	Active	Production	SOT-23 (DBV) 5	3000 LARGE T&R	Yes	NIPDAU	Level-1-260C-UNLIM	-40 to 85	TQ1U
TL331QDBVRQ1	Active	Production	SOT-23 (DBV) 5	3000 LARGE T&R	Yes	NIPDAU SN	Level-1-260C-UNLIM	-40 to 125	T1RU
TL331QDBVRQ1.A	Active	Production	SOT-23 (DBV) 5	3000 LARGE T&R	Yes	NIPDAU	Level-1-260C-UNLIM	See TL331QDBVRQ1	T1RU
TL331QDBVRQ1.B	Active	Production	SOT-23 (DBV) 5	3000 LARGE T&R	Yes	NIPDAU	Level-1-260C-UNLIM	See TL331QDBVRQ1	T1RU
TL391BQDBVRQ1	Active	Production	SOT-23 (DBV) 5	3000 LARGE T&R	Yes	NIPDAU	Level-1-260C-UNLIM	-40 to 125	91BQ
TL391BQDBVRQ1.B	Active	Production	SOT-23 (DBV) 5	3000 LARGE T&R	Yes	NIPDAU	Level-1-260C-UNLIM	-40 to 125	91BQ

(1) **Status:** For more details on status, see our [product life cycle](#).

(2) **Material type:** When designated, preproduction parts are prototypes/experimental devices, and are not yet approved or released for full production. Testing and final process, including without limitation quality assurance, reliability performance testing, and/or process qualification, may not yet be complete, and this item is subject to further changes or possible discontinuation. If available for ordering, purchases will be subject to an additional waiver at checkout, and are intended for early internal evaluation purposes only. These items are sold without warranties of any kind.

(3) **RoHS values:** Yes, No, RoHS Exempt. See the [TI RoHS Statement](#) for additional information and value definition.

(4) **Lead finish/Ball material:** Parts may have multiple material finish options. Finish options are separated by a vertical ruled line. Lead finish/Ball material values may wrap to two lines if the finish value exceeds the maximum column width.

(5) **MSL rating/Peak reflow:** The moisture sensitivity level ratings and peak solder (reflow) temperatures. In the event that a part has multiple moisture sensitivity ratings, only the lowest level per JEDEC standards is shown. Refer to the shipping label for the actual reflow temperature that will be used to mount the part to the printed circuit board.

(6) **Part marking:** There may be an additional marking, which relates to the logo, the lot trace code information, or the environmental category of the part.

Multiple part markings will be inside parentheses. Only one part marking contained in parentheses and separated by a "-" will appear on a part. If a line is indented then it is a continuation of the previous line and the two combined represent the entire part marking for that device.

Important Information and Disclaimer:The information provided on this page represents TI's knowledge and belief as of the date that it is provided. TI bases its knowledge and belief on information provided by third parties, and makes no representation or warranty as to the accuracy of such information. Efforts are underway to better integrate information from third parties. TI has taken and continues to take reasonable steps to provide representative and accurate information but may not have conducted destructive testing or chemical analysis on incoming materials and chemicals. TI and TI suppliers consider certain information to be proprietary, and thus CAS numbers and other limited information may not be available for release.

In no event shall TI's liability arising out of such information exceed the total purchase price of the TI part(s) at issue in this document sold by TI to Customer on an annual basis.

OTHER QUALIFIED VERSIONS OF TL331-Q1, TL331B-Q1, TL391B-Q1 :

- Catalog : [TL331](#), [TL331B](#), [TL391B](#)
- Enhanced Product : [TL331-EP](#)

NOTE: Qualified Version Definitions:

- Catalog - TI's standard catalog product
- Enhanced Product - Supports Defense, Aerospace and Medical Applications

TAPE AND REEL INFORMATION

QUADRANT ASSIGNMENTS FOR PIN 1 ORIENTATION IN TAPE

*All dimensions are nominal

Device	Package Type	Package Drawing	Pins	SPQ	Reel Diameter (mm)	Reel Width W1 (mm)	A0 (mm)	B0 (mm)	K0 (mm)	P1 (mm)	W (mm)	Pin1 Quadrant
TL331BQDBVRQ1	SOT-23	DBV	5	3000	180.0	8.4	3.2	3.2	1.4	4.0	8.0	Q3
TL331BQDBVRQ1	SOT-23	DBV	5	3000	180.0	8.4	3.2	3.2	1.4	4.0	8.0	Q3
TL331EDBVRQ1	SOT-23	DBV	5	3000	180.0	8.4	3.2	3.2	1.4	4.0	8.0	Q3
TL331IDBVRQ1	SOT-23	DBV	5	3000	180.0	8.4	3.2	3.2	1.4	4.0	8.0	Q3
TL331IDBVRQ1	SOT-23	DBV	5	3000	180.0	8.4	3.2	3.2	1.4	4.0	8.0	Q3
TL331IDBVRQ1	SOT-23	DBV	5	3000	180.0	8.4	3.2	3.2	1.4	4.0	8.0	Q3
TL331QDBVRQ1	SOT-23	DBV	5	3000	180.0	8.4	3.2	3.2	1.4	4.0	8.0	Q3
TL331QDBVRQ1	SOT-23	DBV	5	3000	180.0	8.4	3.2	3.2	1.4	4.0	8.0	Q3
TL331QDBVRQ1	SOT-23	DBV	5	3000	180.0	8.4	3.2	3.2	1.4	4.0	8.0	Q3
TL331QDBVRQ1	SOT-23	DBV	5	3000	180.0	8.4	3.2	3.2	1.4	4.0	8.0	Q3
TL391BQDBVRQ1	SOT-23	DBV	5	3000	180.0	8.4	3.2	3.2	1.4	4.0	8.0	Q3
TL391BQDBVRQ1	SOT-23	DBV	5	3000	180.0	8.4	3.2	3.2	1.4	4.0	8.0	Q3

TAPE AND REEL BOX DIMENSIONS

*All dimensions are nominal

Device	Package Type	Package Drawing	Pins	SPQ	Length (mm)	Width (mm)	Height (mm)
TL331BQDBVRQ1	SOT-23	DBV	5	3000	210.0	185.0	35.0
TL331BQDBVRQ1	SOT-23	DBV	5	3000	210.0	185.0	35.0
TL331EDBVRQ1	SOT-23	DBV	5	3000	210.0	185.0	35.0
TL331IDBVRQ1	SOT-23	DBV	5	3000	210.0	185.0	35.0
TL331IDBVRQ1	SOT-23	DBV	5	3000	210.0	185.0	35.0
TL331IDBVRQ1	SOT-23	DBV	5	3000	210.0	185.0	35.0
TL331QDBVRQ1	SOT-23	DBV	5	3000	210.0	185.0	35.0
TL331QDBVRQ1	SOT-23	DBV	5	3000	210.0	185.0	35.0
TL331QDBVRQ1	SOT-23	DBV	5	3000	210.0	185.0	35.0
TL391BQDBVRQ1	SOT-23	DBV	5	3000	210.0	185.0	35.0
TL391BQDBVRQ1	SOT-23	DBV	5	3000	210.0	185.0	35.0

EXAMPLE BOARD LAYOUT

DBV0005A

SOT-23 - 1.45 mm max height

SMALL OUTLINE TRANSISTOR



LAND PATTERN EXAMPLE
EXPOSED METAL SHOWN
SCALE:15X



SOLDER MASK DETAILS

4214839/K 08/2024

NOTES: (continued)

- 6. Publication IPC-7351 may have alternate designs.
- 7. Solder mask tolerances between and around signal pads can vary based on board fabrication site.

EXAMPLE STENCIL DESIGN

DBV0005A

SOT-23 - 1.45 mm max height

SMALL OUTLINE TRANSISTOR



SOLDER PASTE EXAMPLE
BASED ON 0.125 mm THICK STENCIL
SCALE:15X

4214839/K 08/2024

NOTES: (continued)

8. Laser cutting apertures with trapezoidal walls and rounded corners may offer better paste release. IPC-7525 may have alternate design recommendations.
9. Board assembly site may have different recommendations for stencil design.

重要なお知らせと免責事項

TI は、技術データと信頼性データ (データシートを含みます)、設計リソース (リファレンス デザインを含みます)、アプリケーションや設計に関する各種アドバイス、Web ツール、安全性情報、その他のリソースを、欠陥が存在する可能性のある「現状のまま」提供しており、商品性および特定目的に対する適合性の黙示保証、第三者の知的財産権の非侵害保証を含むいかなる保証も、明示的または黙示的にかかわらず拒否します。

これらのリソースは、TI 製品を使用する設計の経験を積んだ開発者への提供を意図したものです。(1) お客様のアプリケーションに適した TI 製品の選定、(2) お客様のアプリケーションの設計、検証、試験、(3) お客様のアプリケーションに該当する各種規格や、その他のあらゆる安全性、セキュリティ、規制、または他の要件への確実な適合に関する責任を、お客様のみが単独で負うものとし、

上記の各種リソースは、予告なく変更される可能性があります。これらのリソースは、リソースで説明されている TI 製品を使用するアプリケーションの開発の目的でのみ、TI はその使用をお客様に許諾します。これらのリソースに関して、他の目的で複製することや掲載することは禁止されています。TI や第三者の知的財産権のライセンスが付与されている訳ではありません。お客様は、これらのリソースを自身で使用した結果発生するあらゆる申し立て、損害、費用、損失、責任について、TI およびその代理人を完全に補償するものとし、TI は一切の責任を拒否します。

TI の製品は、[TI の販売条件](#)、[TI の総合的な品質ガイドライン](#)、[ti.com](#) または TI 製品などに関連して提供される他の適用条件に従い提供されます。TI がこれらのリソースを提供することは、適用される TI の保証または他の保証の放棄の拡大や変更を意味するものではありません。TI がカスタム、またはカスタマー仕様として明示的に指定していない限り、TI の製品は標準的なカタログに掲載される汎用機器です。

お客様がいかなる追加条項または代替条項を提案する場合も、TI はそれらに異議を唱え、拒否します。

Copyright © 2026, Texas Instruments Incorporated

最終更新日 : 2025 年 10 月