

TLV704 24V、150mA、3.2μA 静止電流の低ドロップアウト・リニア・レギュレータ

1 特長

- 入力電圧範囲:
 - 2.5V~24V (新しいチップのみ最大 30V)
- 選択可能な出力電圧:
 - 固定: 1.8V~5V
- 出力電流: 最大 150mA
- 超低 I_Q : 100mA の負荷電流で 3.4μA
- 0.47μF 以上の出力コンデンサで安定動作
- 過電流保護
- パッケージ: 5 ピン SOT-23 (DBV)
- 動作時接合部温度: -40°C~+125°C

2 アプリケーション

- ホーム/ビルディング・オートメーション
- リテール・オートメーションおよびペイメント
- グリッド・インフラストラクチャ
- 医療用アプリケーション
- 照明用途

3 概要

TLV704 低ドロップアウト (LDO) リニア電圧レギュレータは低静止時電流のデバイスで、幅広い入力電圧範囲と低消費電力動作の利点を小型パッケージで提供します。このため、TLV704 はバッテリー駆動アプリケーションや、低消費電力マイコンの電力管理外付け機能用に設計されています。

TLV704 LDO は、100mA の負荷電流で標準 850mV の低ドロップアウトをサポートしています。静止時電流が低く (標準値 3.4μA)、出力負荷電流の全範囲 (0mA~150mA) にわたって安定しています。また、TLV704 には内部ソフトスタートが搭載されており、突入電流を低減できます。過電流制限保護機能が組み込まれているため、負荷の短絡やフォルトが発生してもレギュレータが保護されます。

TLV704 は 2.90mm x 1.60mm の SOT23-5 パッケージで供給され、コスト効率の優れた基板製造に役立ちます。

パッケージ情報

部品番号	パッケージ(1)	本体サイズ (公称)
TLV704	DBV (SOT-23, 5)	2.90mm x 1.60mm

- (1) 利用可能なパッケージについては、このデータシートの末尾にある注文情報を参照してください。



図 3-1. TLV704xx の静止時電流と負荷電流との関係 (新しいチップのみ)



代表的なアプリケーション

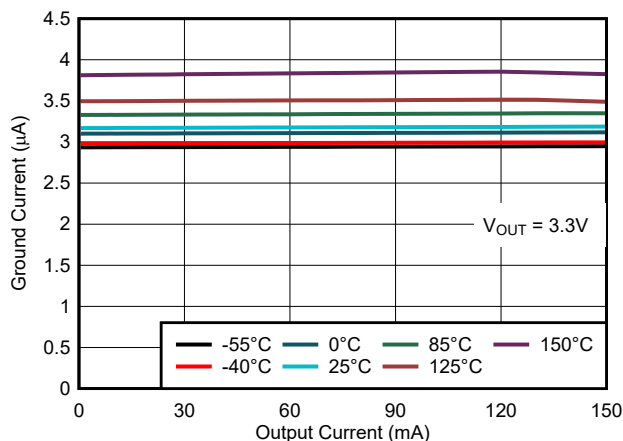
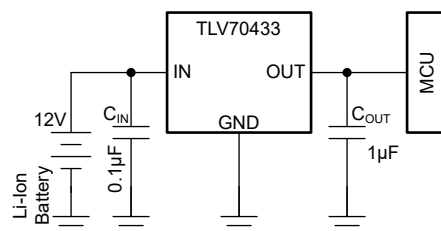

Table of Contents

1 特長	1	8 Application and Implementation	15
2 アプリケーション	1	8.1 Application Information.....	15
3 概要	1	8.2 Typical Application.....	15
4 Revision History	2	8.3 Best Design Practices.....	19
5 Pin Configuration and Functions	3	8.4 Power Supply Recommendations.....	20
6 Specifications	4	8.5 Layout.....	20
6.1 Absolute Maximum Ratings.....	4	9 Device and Documentation Support	21
6.2 ESD Ratings.....	4	9.1 Device Support.....	21
6.3 Recommended Operating Conditions.....	5	9.2 Documentation Support.....	21
Thermal Information.....	5	9.3 ドキュメントの更新通知を受け取る方法.....	21
6.4 Electrical Characteristics.....	6	9.4 サポート・リソース.....	21
6.5 Typical Characteristics.....	7	9.5 Trademarks.....	21
7 Detailed Description	12	9.6 静電気放電に関する注意事項.....	21
7.1 Overview.....	12	9.7 用語集.....	21
7.2 Functional Block Diagram.....	12	10 Mechanical, Packaging, and Orderable Information	22
7.3 Feature Description.....	12		
7.4 Device Functional Modes.....	14		

4 Revision History

資料番号末尾の英字は改訂を表しています。その改訂履歴は英語版に準じています。

Changes from Revision E (December 2022) to Revision F (March 2023)	Page
• 固定出力オプションをそれぞれ個別に記載せず、「特長」セクションにオプションの範囲を表記するように変更.....	1
• Corrected the abs max rating of V_{OUT} pin for legacy chip	4
• Corrected the operating max range of V_{OUT} pin.....	5
• Corrected the supported output current range from 50 mA to 150 mA.....	5
• 「アプリケーション曲線」セクションを変更.....	18

Changes from Revision D (January 2015) to Revision E (December 2022)	Page
• ドキュメントのタイトル、「特長」、「アプリケーション」、「概要」セクションを変更し、M3 デバイスの情報をドキュメントに追加.....	1
• Changed <i>Pin Configuration and Functions</i> section.....	3
• Added new chip specific curves to <i>Typical Characteristics</i> section.....	7
• Changed <i>Overview</i> section.....	12
• Changed <i>Functional Block Diagram</i> image.....	12
• Changed <i>Feature Description</i> section.....	12
• Deleted thermal shutdown discussion from <i>Current Limit</i> section.....	13
• Changed <i>Normal Operation</i> section.....	14
• Changed <i>Dropout Operation</i> section.....	14
• Changed <i>Application Information</i> section.....	15
• Added <i>External Capacitor Requirements</i> , <i>Reverse Current</i> , and <i>Power Dissipation</i> sub-sections to <i>Detailed Design Procedure</i> section.....	15
• Changed <i>Input and Output Capacitor Requirements</i> section.....	15
• Added <i>Reverse Current</i> section.....	16
• Changed <i>Estimating Junction Temperature</i> section.....	17
• Added <i>Best Design Practices</i> section.....	19
• Changed <i>Power Supply Recommendations</i> section.....	20
• Changed <i>Layout Guidelines</i> section.....	20
• Changed <i>Power Dissipation</i> section: changed title and deleted last sentence from section.....	20
• Added M3 row to <i>Available Options</i> table.....	21

5 Pin Configuration and Functions



图 5-1. DBV Package, 5-Pin SOT-23 (Top View)

表 5-1. Pin Functions

PIN		TYPE	DESCRIPTION
NAME	DBV		
GND	1	—	Ground pin.
IN	2	I	Input supply pin. A capacitor with a value of 0.1 μF or larger is recommended from this pin to ground. See the Input and Output Capacitor Requirements section for more information.
OUT	3	O	Output of the regulator. A capacitor with a value of 1 μF or larger is required from this pin to ground. ⁽¹⁾ See the Input and Output Capacitor Requirements section for more information.
NC	4, 5	—	Not internally connected. This pin can be left open or tied to ground for improved thermal performance.

- (1) The nominal output capacitance must be greater than 0.47 μF . Throughout this document, the nominal derating on these capacitors is 50%. Make sure that the effective capacitance at the pin is greater than 0.47 μF .

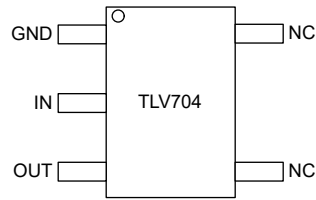
6 Specifications

6.1 Absolute Maximum Ratings

over operating temperature range (unless otherwise noted)⁽¹⁾ ⁽²⁾

		MIN	MAX	UNIT
Voltage	V _{IN} (for legacy chip only)	–0.3	24	V
	V _{IN} (for new chip only)	–0.3	30	
Voltage	V _{OUT} (for legacy chip only)	–0.3	5.0	V
Voltage	V _{OUT} (for fixed output new chip only)	–0.3	$2 \times V_{OUT(\text{typ})}$ or $V_{IN} + 0.3$ or 5.5 (whichever is lower)	V
Current	Peak output current	Internally limited		
Temperature	Junction, T _J	–40	150	°C
	Storage, T _{stg}	–65	150	

- (1) Stresses beyond those listed under *Absolute Maximum Ratings* may cause permanent damage to the device. These are stress ratings only, which do not imply functional operation of the device at these or any other conditions beyond those indicated under *Recommended Operating Conditions*. Exposure to absolute-maximum-rated conditions for extended periods may affect device reliability.
- (2) All voltage values are with respect to network ground terminal.

6.2 ESD Ratings

		VALUE	UNIT
V _(ESD)	Electrostatic discharge	Human body model (HBM), per ANSI/ESDA/JEDEC JS-001, all pins ⁽¹⁾	±2000
		Charged device model (CDM), per JEDEC specification JESD22-C101, all pins ⁽²⁾	±500

- (1) JEDEC document JEP155 states that 500-V HBM allows safe manufacturing with a standard ESD control process.
- (2) JEDEC document JEP157 states that 250-V CDM allows safe manufacturing with a standard ESD control process.

6.3 Recommended Operating Conditions

over operating free-air temperature range (unless otherwise noted)⁽¹⁾

		MIN	NOM	MAX	UNIT
V _{IN}	Input supply voltage	2.5		24	V
V _{OUT}	Output voltage	1.205		5	V
I _{OUT}	Output current	0		150	mA
C _{IN}	Input capacitor ⁽²⁾	0	0.047		μF
C _{OUT}	Output capacitor (for legacy chip only)	0.47	1		
	Output capacitor (for new chip only) ⁽³⁾	1			
T _J	Operating junction temperature	-40		125	°C

- (1) All voltages are with respect to GND.
- (2) An input capacitor is not required for LDO stability. However, an input capacitor with an effective value of 0.047 μF is recommended to counteract the effect of source resistance and inductance, which may in some cases cause symptoms of system level instability such as ringing or oscillation, especially in the presence of load transients.
- (3) All capacitor values are assumed to derate to 50% of the nominal capacitor value. Maintain an effective output capacitance of 0.47 μF minimum for the stability.

Thermal Information

THERMAL METRIC ⁽¹⁾		Legacy Chip	New Chip	UNIT
		DBV (SOT-23)	DBV (SOT-23)	
		5 PINS	5 PINS	
R _{θJA}	Junction-to-ambient thermal resistance	213.1	170.8	°C/W
R _{θJC(top)}	Junction-to-case (top) thermal resistance	110.9	68.7	°C/W
R _{θJB}	Junction-to-board thermal resistance	97.4	76.7	°C/W
ψ _{JT}	Junction-to-top characterization parameter	22.0	10.3	°C/W
ψ _{JB}	Junction-to-board characterization parameter	78.4	76.3	°C/W

- (1) For more information about traditional and new thermal metrics, see the [Semiconductor and IC package thermal metrics](#) application report.

6.4 Electrical Characteristics

over operating junction temperature range ($T_J = -40^\circ\text{C}$ to 125°C), $V_{IN} = V_{OUT(nom)} + 1\text{ V}$, $I_{OUT} = 1\text{ mA}$, and $C_{OUT} = 1\text{ }\mu\text{F}$ (unless otherwise noted); typical values are at $T_J = 25^\circ\text{C}$

PARAMETER		TEST CONDITIONS	MIN	TYP	MAX	UNIT
V_{IN}	Input voltage range ⁽¹⁾	$T_J = 25^\circ\text{C}$			24	V
V_{OUT}	Output voltage range ⁽¹⁾	$T_J = 25^\circ\text{C}$	1.2		5	V
V_{OUT}	DC output accuracy ⁽¹⁾	$T_J = 25^\circ\text{C}$	-2		2	%
I_{GND}	Ground pin current (legacy chip) ⁽³⁾	$I_{OUT} = 0\text{ mA}$, $T_J = 25^\circ\text{C}$		3.2	4.5	μA
		$I_{OUT} = 100\text{ mA}$, $T_J = 25^\circ\text{C}$		3.2	5.5	
	Ground pin current (new chip) ⁽³⁾	$I_{OUT} = 0\text{ mA}$, $T_J = 25^\circ\text{C}$		3.2	4.1	
		$I_{OUT} = 100\text{ mA}$, $T_J = 25^\circ\text{C}$		3.4	4.5	
$\Delta V_{OUT} (\Delta I_{OUT})$	Load regulation	$V_{OUT} < 3.3\text{ V}$, $0 < I_{OUT} < 10\text{ mA}$, $T_J = 25^\circ\text{C}$		10		mV
		$V_{OUT} < 3.3\text{ V}$, $0 < I_{OUT} < 50\text{ mA}$, $T_J = 25^\circ\text{C}$		25		
		$V_{OUT} < 3.3\text{ V}$, $0 < I_{OUT} < 100\text{ mA}$, $T_J = 25^\circ\text{C}$		33	50	
		$V_{OUT} \geq 3.3\text{ V}$, $0 < I_{OUT} < 10\text{ mA}$, $T_J = 25^\circ\text{C}$		7		
		$V_{OUT} \geq 3.3\text{ V}$, $0 < I_{OUT} < 50\text{ mA}$, $T_J = 25^\circ\text{C}$		35		
		$V_{OUT} \geq 3.3\text{ V}$, $0 < I_{OUT} < 100\text{ mA}$, $T_J = 25^\circ\text{C}$		50	75	
$\Delta V_{OUT} (\Delta V_{IN})$	Line regulation ⁽¹⁾	$V_{OUT(nom)} + 1\text{ V} \leq V_{IN} \leq 24\text{ V}$, $T_J = 25^\circ\text{C}$		20	50	mV
I_{CL}	Output current limit (legacy chip)	$V_{OUT} = 0\text{ V}$, $T_J = 25^\circ\text{C}$	160		1000	mA
	Output current limit (new chip)		160		500	
PSRR	Power-supply ripple rejection	$f = 100\text{ kHz}$, $C_{OUT} = 10\text{ }\mu\text{F}$		60		dB
V_{DO}	Dropout voltage	$V_{IN} = V_{OUT(nom)} - 0.1\text{ V}$, $I_{OUT} = 10\text{ mA}$, $T_J = 25^\circ\text{C}$		75		mV
		$V_{IN} = V_{OUT(nom)} - 0.1\text{ V}$, $I_{OUT} = 50\text{ mA}$, $T_J = 25^\circ\text{C}$		400		
		$V_{IN} = V_{OUT(nom)} - 0.1\text{ V}$, $I_{OUT} = 100\text{ mA}$, $T_J = 25^\circ\text{C}$		850	1100	
T_J	Operating junction temperature		-40		125	$^\circ\text{C}$

(1) Minimum $V_{IN} = V_{OUT} + V_{DO}$ or the value shown for *Input voltage* in this table, whichever is greater.

(2) This device employs a leakage null control circuit. This circuit is active only if output current is less than pass transistor leakage current. The circuit is typically active when output load is less than $5\text{ }\mu\text{A}$, V_{IN} is greater than 18 V , and die temperature is greater than 100°C .

6.5 Typical Characteristics

at operating temperature $T_J = 25^\circ\text{C}$, $V_{IN} = V_{OUT(NOM)} + 1.0\text{ V}$ or 2.5 V (whichever is greater), $I_{OUT} = 1\text{ mA}$, $C_{IN} = 1\text{ }\mu\text{F}$, and $C_{OUT} = 1\text{ }\mu\text{F}$ (unless otherwise noted)

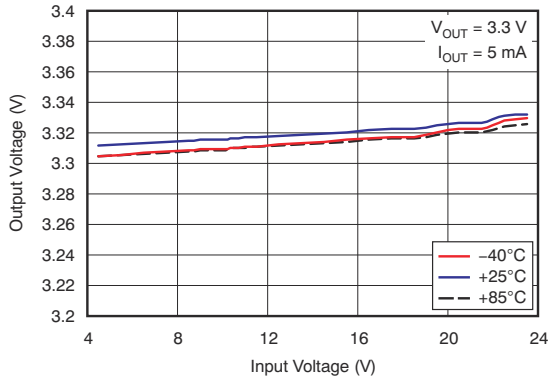

6-1. Line Regulation for Legacy Chip

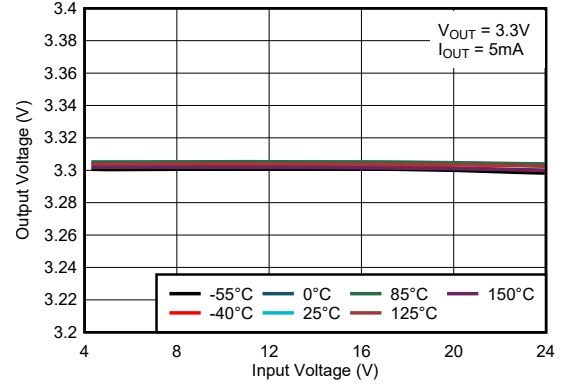

6-2. Line Regulation for New Chip

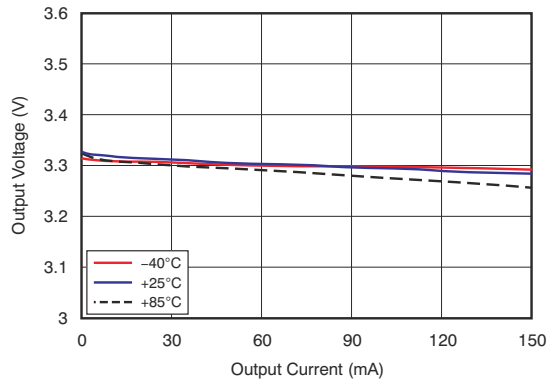

6-3. Load Regulation ($V_{OUT} = 3.3\text{ V}$) for Legacy Chip

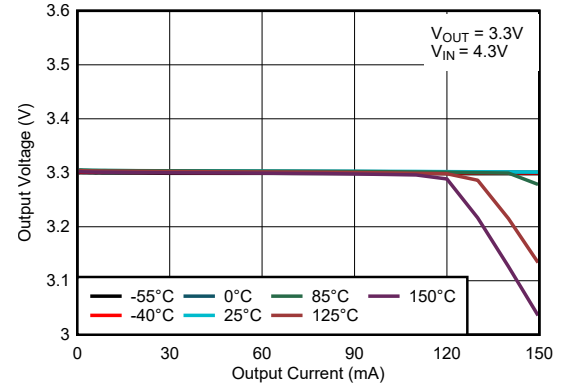

6-4. Load Regulation ($V_{OUT} = 3.3\text{ V}$) for New Chip

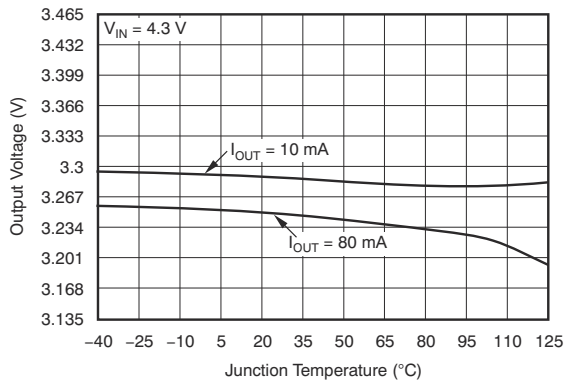

6-5. Output Voltage vs Junction Temperature for Legacy Chip

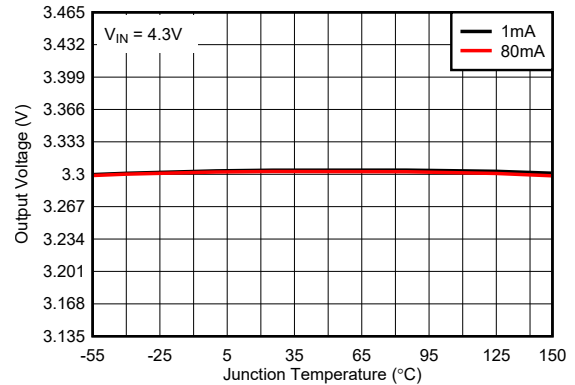

6-6. Output Voltage vs Junction Temperature for New Chip

6.5 Typical Characteristics (continued)

at operating temperature $T_J = 25^\circ\text{C}$, $V_{IN} = V_{OUT(NOM)} + 1.0\text{ V}$ or 2.5 V (whichever is greater), $I_{OUT} = 1\text{ mA}$, $C_{IN} = 1\text{ }\mu\text{F}$, and $C_{OUT} = 1\text{ }\mu\text{F}$ (unless otherwise noted)



6-7. Dropout Voltage vs Input Voltage (TLV70433) for Legacy Chip

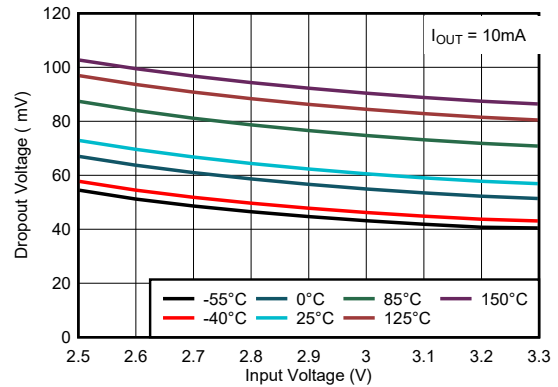

6-8. Dropout Voltage vs Input Voltage (TLV70433) for New Chip

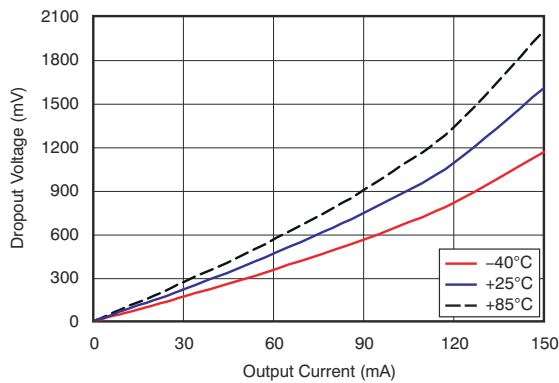

6-9. Dropout Voltage vs Output Current for Legacy Chip

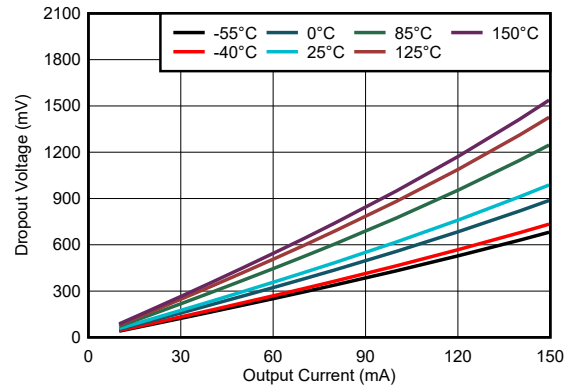

6-10. Dropout Voltage vs Output Current for New Chip

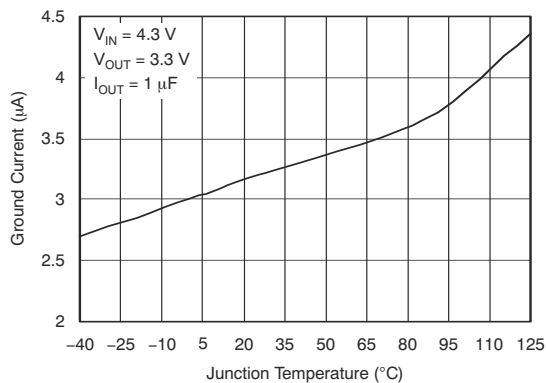

6-11. Ground Current vs Junction Temperature for Legacy Chip

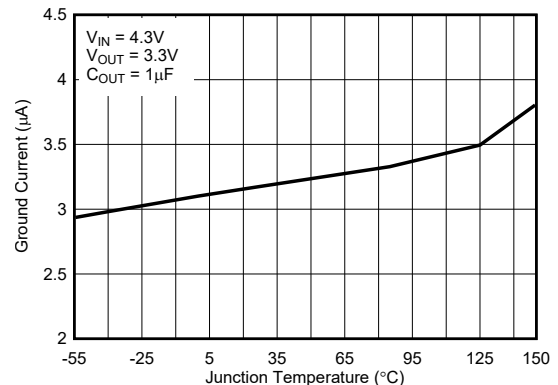

6-12. Ground Current vs Junction Temperature for New Chip

6.5 Typical Characteristics (continued)

at operating temperature $T_J = 25^\circ\text{C}$, $V_{IN} = V_{OUT(NOM)} + 1.0\text{ V}$ or 2.5 V (whichever is greater), $I_{OUT} = 1\text{ mA}$, $C_{IN} = 1\text{ }\mu\text{F}$, and $C_{OUT} = 1\text{ }\mu\text{F}$ (unless otherwise noted)



6-13. Ground Pin Current vs Input Voltage for Legacy Chip

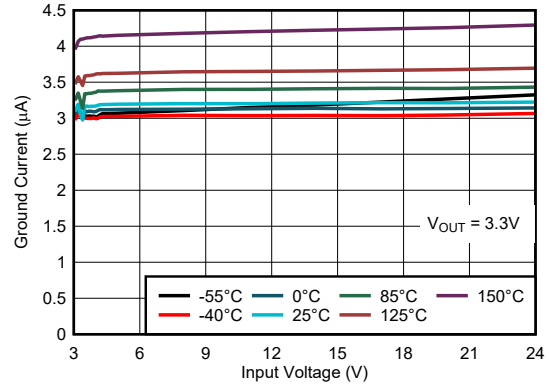

6-14. Ground Pin Current vs Input Voltage for New Chip

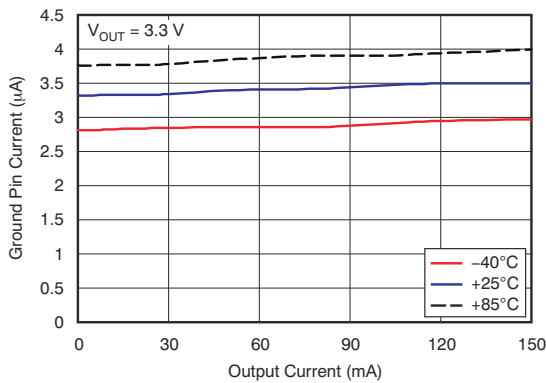

6-15. Ground Pin Current vs Load Current for Legacy Chip

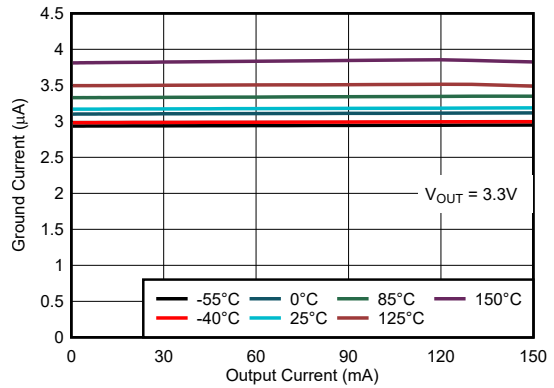

6-16. Ground Pin Current vs Load Current for New Chip

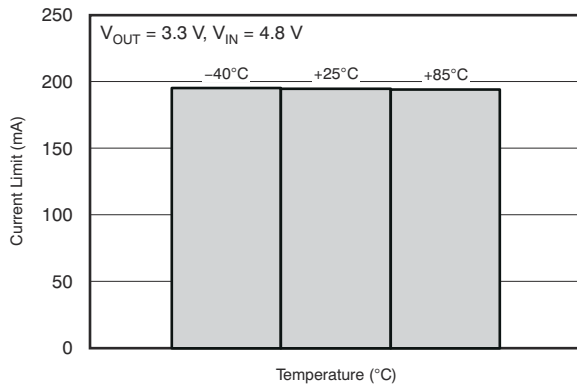

6-17. Current Limit vs Junction Temperature for Legacy Chip

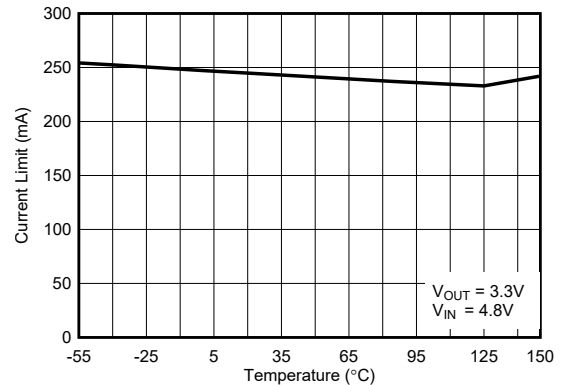

6-18. Current Limit vs Junction Temperature for New Chip

6.5 Typical Characteristics (continued)

at operating temperature $T_J = 25^\circ\text{C}$, $V_{IN} = V_{OUT(NOM)} + 1.0\text{ V}$ or 2.5 V (whichever is greater), $I_{OUT} = 1\text{ mA}$, $C_{IN} = 1\text{ }\mu\text{F}$, and $C_{OUT} = 1\text{ }\mu\text{F}$ (unless otherwise noted)



6-19. Output Spectral Noise Density vs Frequency for Legacy Chip

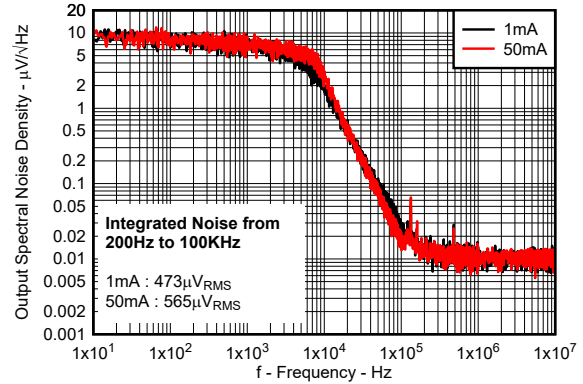

6-20. Output Spectral Noise Density vs Frequency for New Chip

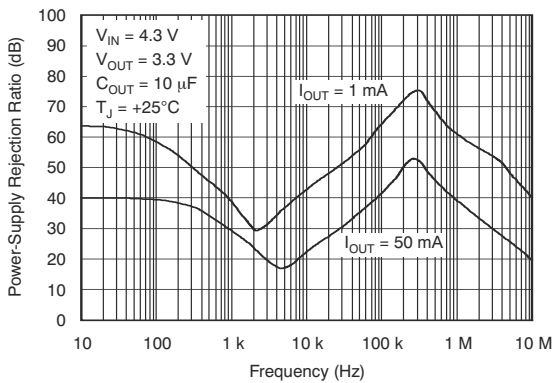

6-21. Power-Supply Ripple Rejection vs Frequency for Legacy Chip

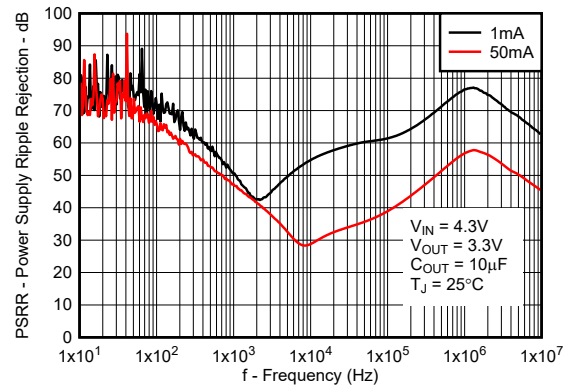

6-22. Power-Supply Ripple Rejection vs Frequency for New Chip

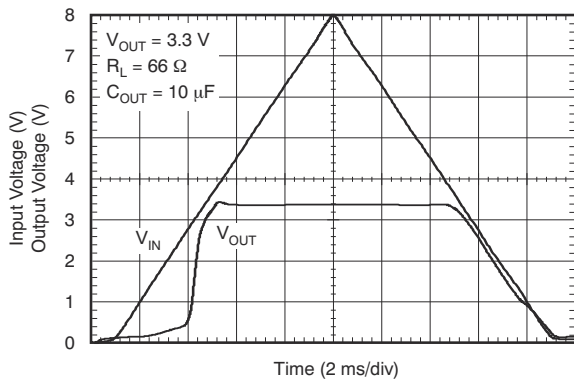

6-23. Power-Up, Power-Down for Legacy Chip

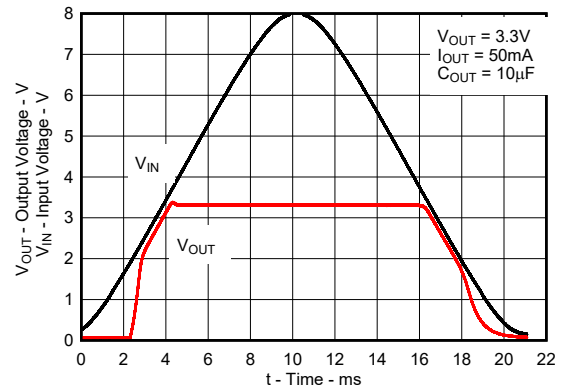

6-24. Power-Up, Power-Down for New Chip

6.5 Typical Characteristics (continued)

at operating temperature $T_J = 25^\circ\text{C}$, $V_{IN} = V_{OUT(NOM)} + 1.0\text{ V}$ or 2.5 V (whichever is greater), $I_{OUT} = 1\text{ mA}$, $C_{IN} = 1\text{ }\mu\text{F}$, and $C_{OUT} = 1\text{ }\mu\text{F}$ (unless otherwise noted)

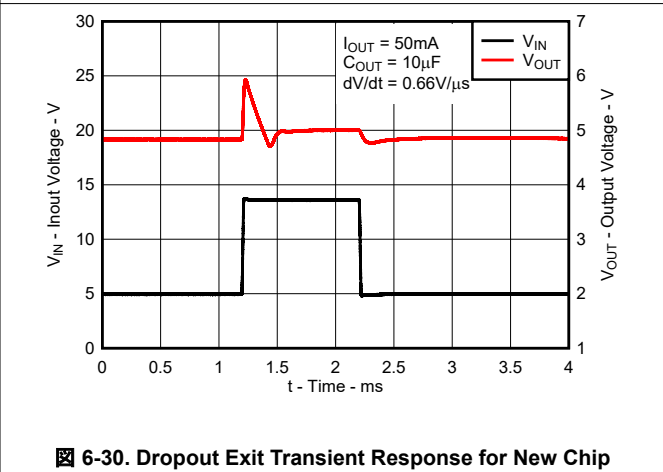
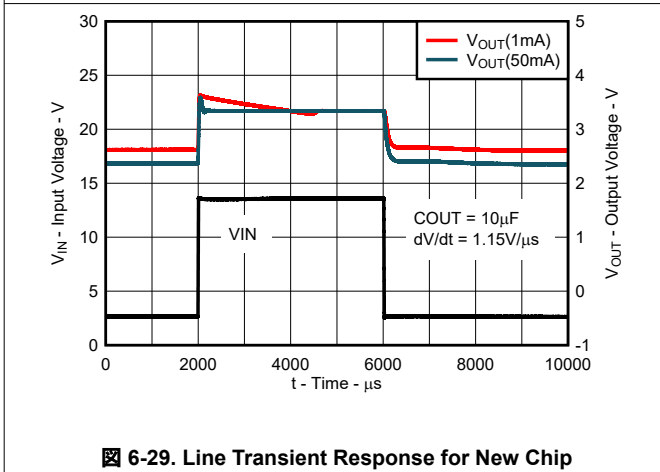
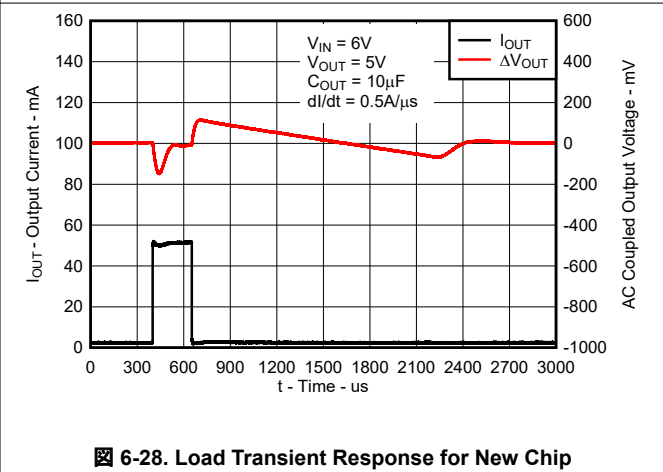
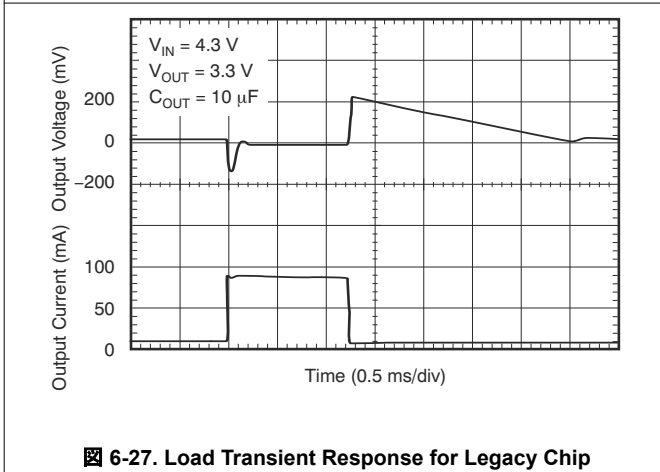
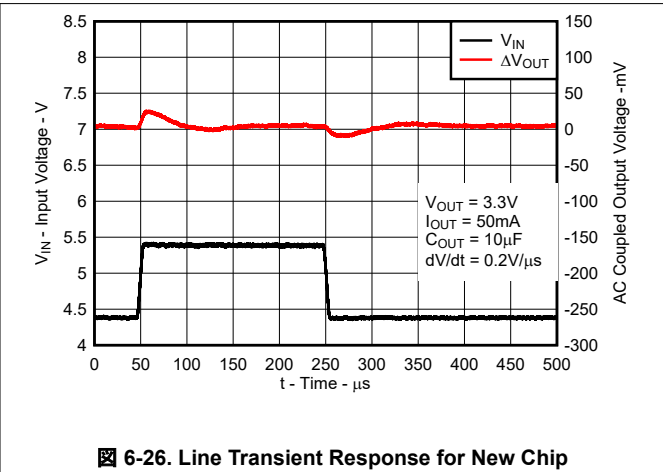
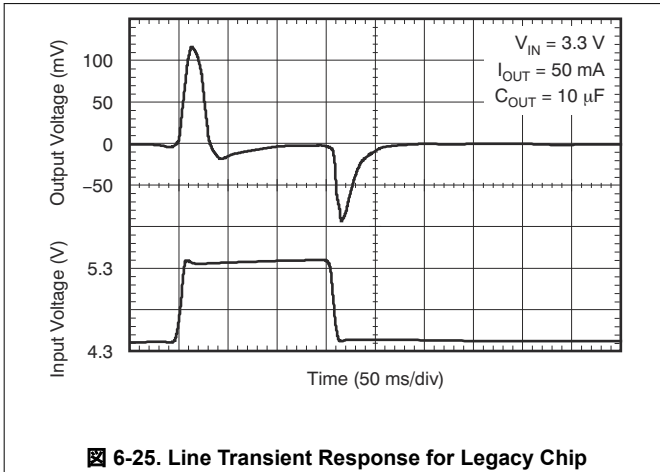

7 Detailed Description

7.1 Overview

The TLV704 low-dropout regulator (LDO) consumes only 3.4 μA of quiescent current across the entire output current range, and offers a wide input voltage range and low-dropout voltage in a small package. The device, which operates over an input range of 2.5 V to 24 V, is stable with any output capacitor greater than or equal to 0.47 μF . The low quiescent current across the complete load current range makes the TLV704 designed for powering battery-operated applications. The TLV704 has internal soft-start to control inrush current into the output capacitor. This LDO also has overcurrent protection during a load-short or fault condition on the output.

7.2 Functional Block Diagram



7.3 Feature Description

7.3.1 Wide Supply Range

This device has an operational input supply range of 2.5 V to 24 V, allowing for a wide range of applications. This wide supply range is designed for applications that have either large transients or high DC voltage supplies.

7.3.2 Low Quiescent Current

This device only requires 3.4 μA (typical) of quiescent current across the complete load current range (0 mA to 150 mA) and has a maximum current consumption of 4.5 μA (for new device only) at -40°C to $+125^{\circ}\text{C}$.

7.3.3 Dropout Voltage (V_{DO})

Dropout voltage (V_{DO}) is defined as the input voltage minus the output voltage ($V_{\text{IN}} - V_{\text{OUT}}$) at the rated output current (I_{RATED}), where the pass transistor is fully on. I_{RATED} is the maximum I_{OUT} listed in the [Recommended Operating Conditions](#) table. In dropout operation, the pass transistor is in the ohmic or triode region of operation, and acts as a switch. The dropout voltage indirectly specifies a minimum input voltage greater than the nominal programmed output voltage at which the output voltage is expected to stay in regulation. If the input voltage falls to less than the value required to maintain output regulation, the output voltage falls as well.

For a CMOS regulator, the dropout voltage is determined by the drain-source, on-state resistance ($R_{\text{DS(ON)}}$) of the pass transistor. Therefore, if the linear regulator operates at less than the rated current, the dropout voltage for that current scales accordingly. Use [Equation 1](#) to calculate the $R_{\text{DS(ON)}}$ of the device.

$$R_{\text{DS(ON)}} = \frac{V_{\text{DO}}}{I_{\text{RATED}}} \quad (1)$$

7.3.4 Current Limit

The device has an internal current limit circuit that protects the regulator during transient high-load current faults or shorting events. The current limit is a brick-wall scheme. In a high-load current fault, the brick-wall scheme limits the output current to the current limit (I_{CL}). I_{CL} is listed in the [Electrical Characteristics](#) table.

The output voltage is not regulated when the device is in current limit. When a current limit event occurs, the device begins to heat up because of the increase in power dissipation. When the device is in brick-wall current limit, the pass transistor dissipates power $[(V_{IN} - V_{OUT}) \times I_{CL}]$. For more information on current limits, see the [Know Your Limits application note](#).

☒ 7-1 shows a diagram of the current limit.

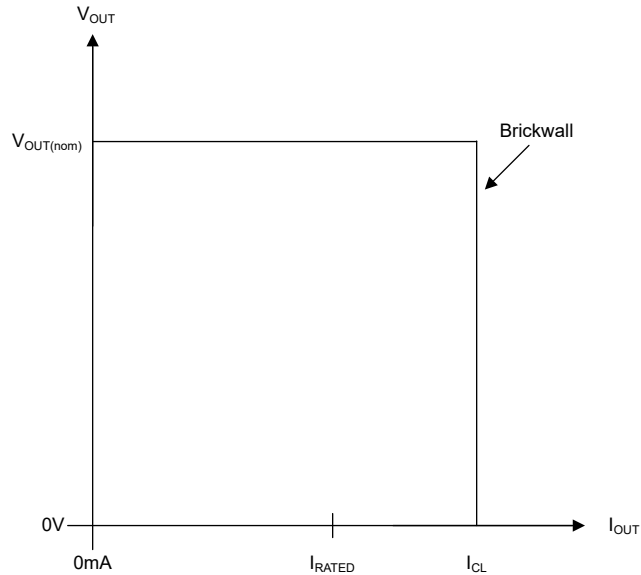

☒ 7-1. Current Limit

7.4 Device Functional Modes

表 7-1 provides a quick comparison between the normal, dropout, and disabled modes of operation.

表 7-1. Device Functional Mode Comparison

OPERATING MODE	PARAMETER	
	V_{IN}	I_{OUT}
Normal	$V_{IN} > V_{OUT(nom)} + V_{DO}$	$I_{OUT} < I_{CL}$
Dropout	$V_{IN} < V_{OUT(nom)} + V_{DO}$	$I_{OUT} < I_{CL}$

7.4.1 Normal Operation

The device regulates to the nominal output voltage under the following conditions:

- The input voltage is greater than the nominal output voltage plus the dropout voltage ($V_{OUT(nom)} + V_{DO}$)
- The output current is less than the current limit ($I_{OUT} < I_{CL}$)
- The device junction temperature is greater than -40°C and less than $+125^{\circ}\text{C}$

7.4.2 Dropout Operation

If the input voltage is lower than the nominal output voltage plus the specified dropout voltage, but all other conditions are met for normal operation, the device operates in dropout mode. In this mode, the output voltage tracks the input voltage. During this mode, the transient performance of the device becomes significantly degraded because the pass transistor is in the ohmic or triode region, and acts as a switch. Line or load transients in dropout can result in large output voltage deviations.

When the device is in a steady dropout state (defined as when the device is in dropout, $V_{IN} < V_{OUT(NOM)} + V_{DO}$, directly after being in a normal regulation state, but *not* during start up), the pass transistor is driven into the ohmic or triode region. When the input voltage returns to a value greater than or equal to the nominal output voltage plus the dropout voltage ($V_{OUT(NOM)} + V_{DO}$), the output voltage can overshoot for a short period of time while the device pulls the pass transistor back into the linear region.

8 Application and Implementation

注

以下のアプリケーション情報は、TI の製品仕様に含まれるものではなく、TI ではその正確性または完全性を保証いたしません。個々の目的に対する製品の適合性については、お客様の責任で判断していただくこととなります。お客様は自身の設計実装を検証しテストすることで、システムの機能を確認する必要があります。

8.1 Application Information

The TLV704 LDO regulator is designed for battery-powered applications and is a good attachment to low-power microcontrollers (such as the [MSP430](#)) because of the device low I_Q performance across the entire load current range. The ultra-low supply current of the TLV704 maximizes efficiency at light loads, and the high input voltage range and flexibility of output voltage selection in fixed output levels makes the device applicable for supplies such as unconditioned solar panels.

8.2 Typical Application



図 8-1. Typical Application

8.2.1 Design Requirements

Select the desired device based on the output voltage.

Provide an input supply with adequate headroom to account for dropout and output current to account for the GND terminal current, and power the load.

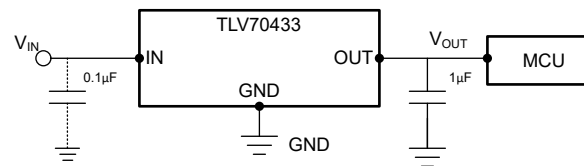
8.2.2 Detailed Design Procedure

8.2.2.1 External Capacitor Requirements

The device is designed to be stable using low equivalent series resistance (ESR) ceramic capacitors at the input and output. Multilayer ceramic capacitors have become the industry standard for these types of applications and are recommended, but must be used with good judgment. Ceramic capacitors that employ X7R-, X5R-, and C0G-rated dielectric materials provide relatively good capacitive stability across temperature, whereas the use of Y5V-rated capacitors is discouraged because of large variations in capacitance.

Regardless of the ceramic capacitor type selected, the effective capacitance varies with operating voltage and temperature. Generally, expect the effective capacitance to decrease by as much as 50%. The input and output capacitors recommended in the [Recommended Operating Conditions](#) table account for an effective capacitance of approximately 50% of the nominal value.

8.2.2.2 Input and Output Capacitor Requirements

Although an input capacitor is not required for stability, good analog design practice is to connect a capacitor from IN to GND. This capacitor counteracts reactive input sources and improves transient response, input ripple, and PSRR. Use an input capacitor if the source impedance is more than 0.5 Ω . A higher value capacitor can be necessary if large, fast rise-time load or line transients are anticipated or if the device is located several inches from the input power source.

Dynamic performance of the device is improved by using a large output capacitor. Use an output capacitor within the range specified in the [Recommended Operating Conditions](#) table for stability.

8.2.2.3 Reverse Current

Excessive reverse current can damage this device. Reverse current flows through the intrinsic body diode of the PMOS pass transistor instead of the normal conducting channel. At high magnitudes, this current flow degrades the long-term reliability of the device.

Conditions where reverse current can occur are outlined in this section, all of which can exceed the absolute maximum rating of $V_{OUT} \leq V_{IN} + 0.3 \text{ V}$. These conditions are:

- If the device has a large C_{OUT} and the input supply collapses with little or no load current
- The output is biased when the input supply is not established
- The output is biased above the input supply

If reverse current flow is expected in the application, external protection is recommended to protect the device. Reverse current is not limited in the device, so external limiting is required if extended reverse voltage operation is anticipated. Limit reverse current to 5% or less of the rated output current of the device in the event this current cannot be avoided.

Figure 8-2 shows one approach for protecting the device.

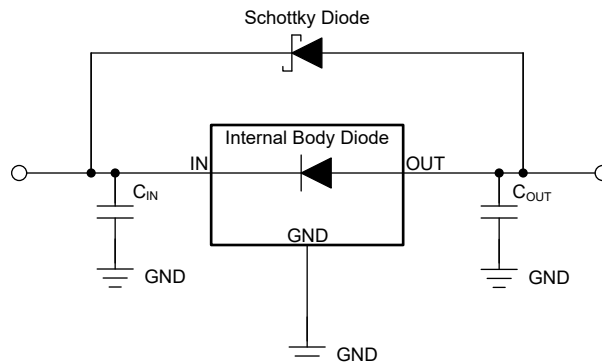

Figure 8-2. Example Circuit for Reverse Current Protection Using a Schottky Diode

8.2.2.4 Power Dissipation (P_D)

Circuit reliability requires consideration of the device power dissipation, location of the circuit on the printed circuit board (PCB), and correct sizing of the thermal plane. The PCB area around the regulator must have few or no other heat-generating devices that cause added thermal stress.

To first-order approximation, power dissipation in the regulator depends on the input-to-output voltage difference and load conditions. The following equation calculates power dissipation (P_D).

$$P_D = (V_{IN} - V_{OUT}) \times I_{OUT} \quad (2)$$

注

Power dissipation can be minimized, and therefore greater efficiency can be achieved, by correct selection of the system voltage rails. For the lowest power dissipation, use the minimum input voltage required for correct output regulation.

For devices with a thermal pad, the primary heat conduction path for the device package is through the thermal pad to the PCB. Solder the thermal pad to a copper pad area under the device. This pad area must contain an array of plated vias that conduct heat to additional copper planes for increased heat dissipation.

The maximum power dissipation determines the maximum allowable ambient temperature (T_A) for the device. According to the following equation, power dissipation and junction temperature are most often related by the junction-to-ambient thermal resistance ($R_{\theta JA}$) of the combined PCB and device package and the temperature of the ambient air (T_A).

$$T_J = T_A + (R_{\theta JA} \times P_D) \quad (3)$$

Thermal resistance ($R_{\theta JA}$) is highly dependent on the heat-spreading capability built into the particular PCB design, and therefore varies according to the total copper area, copper weight, and location of the planes. The junction-to-ambient thermal resistance listed in the [Thermal Information](#) table is determined by the JEDEC standard PCB and copper-spreading area, and is used as a relative measure of package thermal performance.

8.2.2.5 Estimating Junction Temperature

The JEDEC standard now recommends the use of psi (Ψ) thermal metrics to estimate the junction temperatures of the linear regulator when in-circuit on a typical PCB board application. These metrics are not thermal resistance parameters and instead offer a practical and relative way to estimate junction temperature. These psi metrics are determined to be significantly independent of the copper area available for heat-spreading. The [Thermal Information](#) table lists the primary thermal metrics, which are the junction-to-top characterization parameter (ψ_{JT}) and junction-to-board characterization parameter (ψ_{JB}). These parameters provide two methods for calculating the junction temperature (T_J), as described in the following equations. Use the junction-to-top characterization parameter (ψ_{JT}) with the temperature at the center-top of device package (T_T) to calculate the junction temperature. Use the junction-to-board characterization parameter (ψ_{JB}) with the PCB surface temperature 1 mm from the device package (T_B) to calculate the junction temperature.

$$T_J = T_T + \psi_{JT} \times P_D \quad (4)$$

where:

- P_D is the dissipated power
- T_T is the temperature at the center-top of the device package

$$T_J = T_B + \psi_{JB} \times P_D \quad (5)$$

where:

- T_B is the PCB surface temperature measured 1 mm from the device package and centered on the package edge

For detailed information on the thermal metrics and how to use them, see the [Semiconductor and IC Package Thermal Metrics application note](#).

8.2.3 アプリケーション曲線



図 8-3. レガシー・チップの電源オン/オフ



図 8-4. 新しいチップの電源オン/オフ

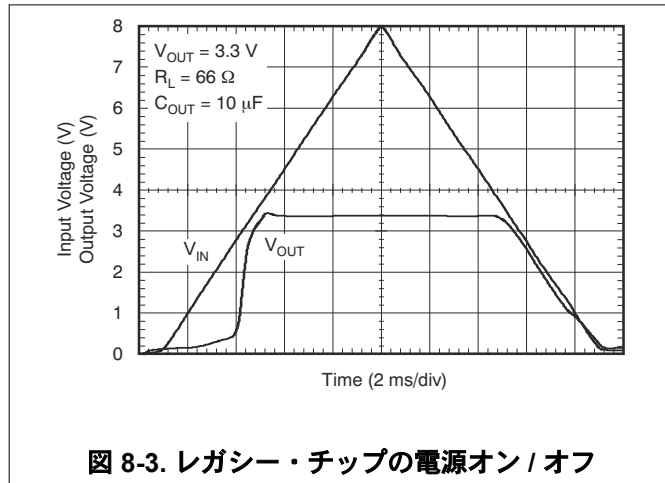

図 8-5. レガシー・チップのライン過渡応答

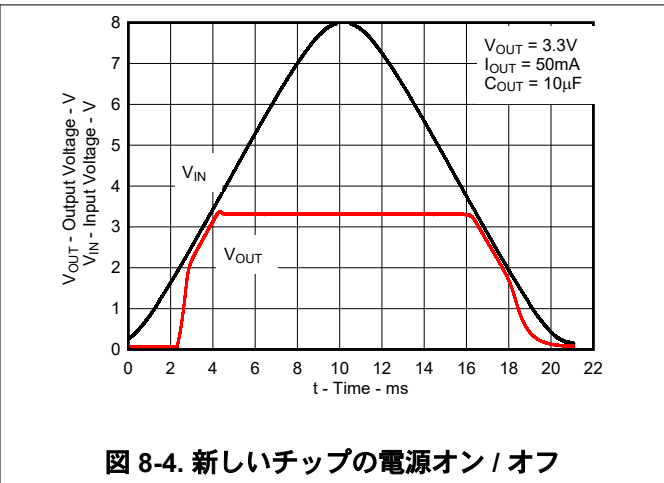

図 8-6. 新しいチップのライン過渡応答

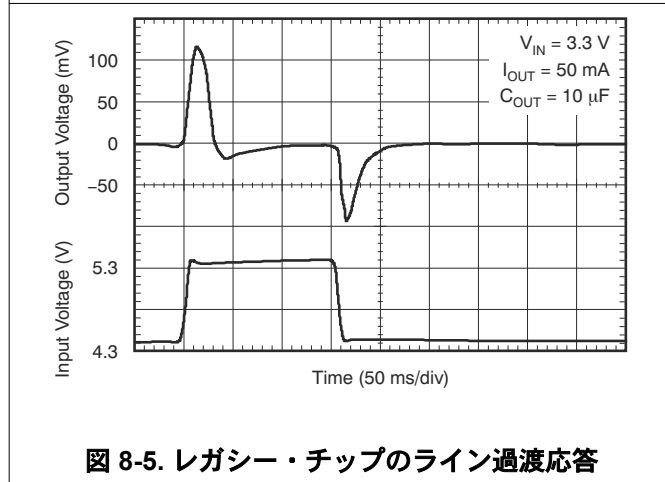

図 8-7. レガシー・チップの負荷過渡応答

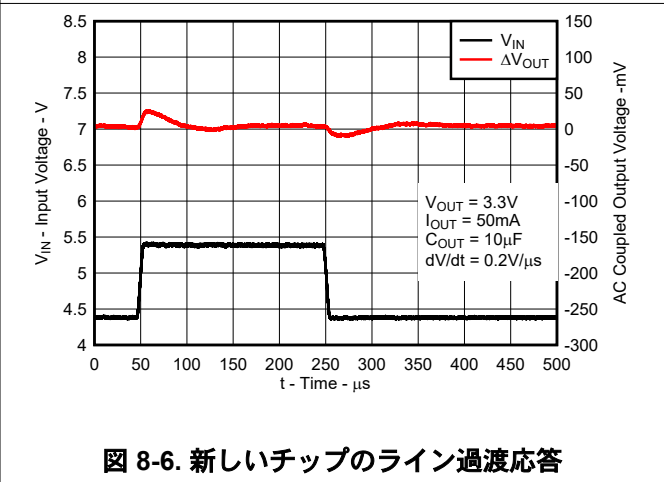

図 8-8. 新しいチップの負荷過渡応答

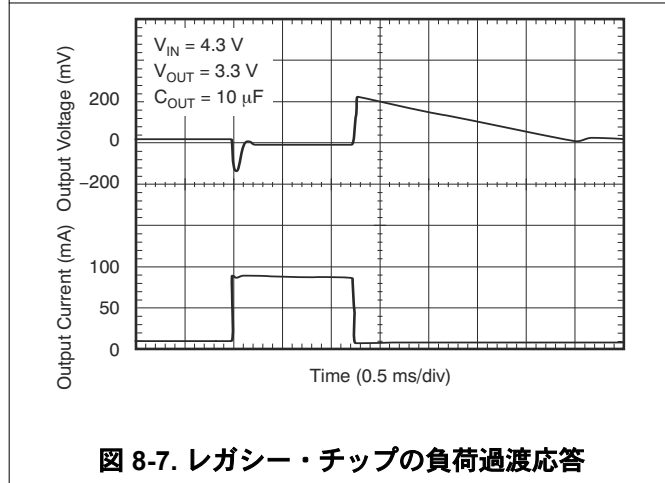

図 8-9. 新しいチップのライン過渡応答

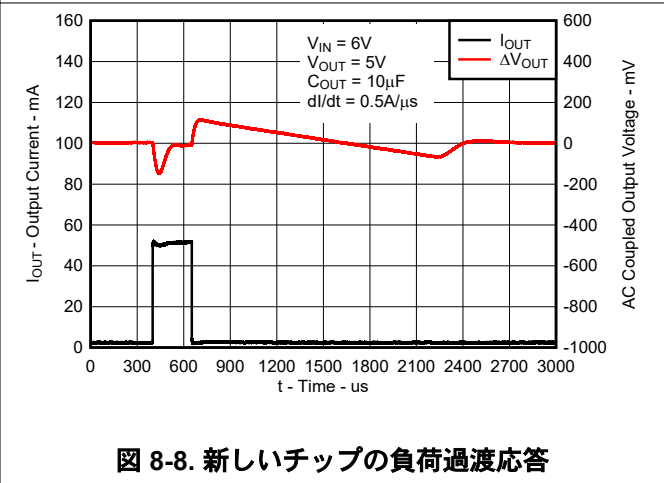

図 8-10. 新しいチップのドロップアウト終了過渡応答

8.3 Best Design Practices

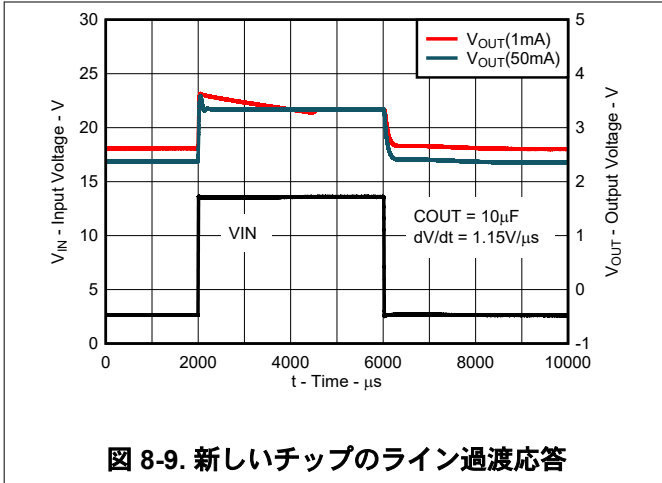
Place at least one 0.47-µF capacitor as close as possible to the OUT and GND pins of the regulator.

Do not connect the output capacitor to the regulator using a long, thin trace.

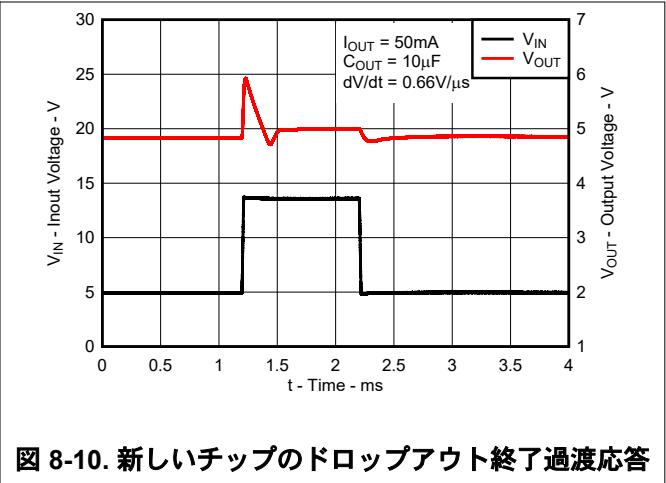
Connect an input capacitor as close as possible to the IN and GND pins of the regulator for best performance.

Do not exceed the absolute maximum ratings.

8.4 Power Supply Recommendations

The TLV704 is designed to operate from an input voltage supply range between 2.5 V and 24 V. The input voltage range must provide adequate headroom for the device to have a regulated output. Inductive impedances between the input supply and the IN pin can create significant voltage excursions at the IN pin during start-up or load transient events. If inductive impedances are unavoidable, use an input capacitor.

8.5 Layout

8.5.1 Layout Guidelines

For best overall performance, place all circuit components on the same side of the printed-circuit-board and as near as practical to the respective LDO pin connections. Place ground return connections for the input and output capacitors as close to the GND pin as possible, using wide, component-side, copper planes. Do not use vias and long traces to create LDO circuit connections to the input capacitor, output capacitor, or the resistor divider because this practice negatively affects system performance. This grounding and layout scheme minimizes inductive parasitics, and thereby reduces load-current transients, minimizes noise, and increases circuit stability. A ground reference plane is also recommended and is either embedded in the PCB or located on the bottom side of the PCB opposite the components. This reference plane serves to assure accuracy of the output voltage and shield the LDO from noise.

8.5.1.1 Power Dissipation

To provide reliable operation, worst-case junction temperature must not exceed 125°C. This restriction limits the power dissipation the regulator can handle in any given application. To make sure the junction temperature is within acceptable limits, calculate the maximum allowable dissipation, $P_{D(max)}$, and the actual dissipation, P_D , which must be less than or equal to $P_{D(max)}$.

The maximum-power-dissipation limit is determined using 式 6:

$$P_{D(max)} = \frac{T_{Jmax} - T_A}{R_{\theta JA}} \quad (6)$$

where:

- T_{Jmax} is the maximum allowable junction temperature
- $R_{\theta JA}$ is the thermal resistance junction-to-ambient for the package (see the [Thermal Information](#) table)
- T_A is the ambient temperature

The regulator dissipation is calculated using 式 7:

$$P_D = (V_{IN} - V_{OUT}) \times I_{OUT} \quad (7)$$

8.5.2 Layout Example

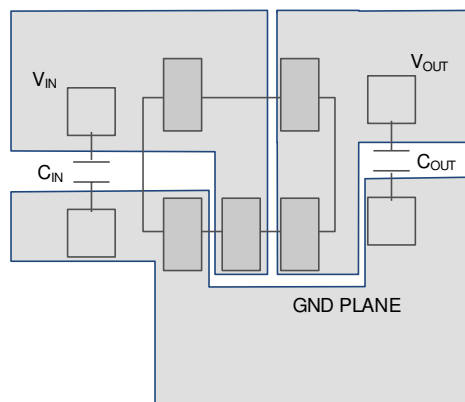

8-11. Layout Example for the DBV Package

9 Device and Documentation Support

9.1 Device Support

9.1.1 Development Support

9.1.1.1 Evaluation Module

An evaluation module (EVM) is available to assist in the initial circuit performance evaluation using the TLV704. The [TLV70433DBVEVM-712 evaluation module](#) (and [related user guide](#)) can be requested at the Texas Instruments website through the product folders or purchased directly from the [TI eStore](#).

9.1.2 Device Nomenclature

表 9-1. Available Options⁽¹⁾

PRODUCT	V _{OUT}
TLV704xxyyyz Legacy chip	xx is the nominal output voltage (for example 33 = 3.3 V). yyy is the package designator. z is the package quantity.
TLV704xxyyyz M3 New chip	xx is the nominal output voltage (for example 33 = 3.3 V). yyy is the package designator. z is the package quantity. M3 is a suffix designator for newer chip redesigns, fabricated on the latest TI process technology.

(1) For the most current package and ordering information, see the Package Option Addendum at the end of this document, or visit the device product folder at www.ti.com.

9.2 Documentation Support

9.2.1 Related Documentation

For related documentation see the following:

- Texas Instruments, [TLV70433DBVEVM-712](#), [TLV70433PKEVM-712 Evaluation Modules user guide](#)

9.3 ドキュメントの更新通知を受け取る方法

ドキュメントの更新についての通知を受け取るには、ti.com のデバイス製品フォルダを開いてください。「更新の通知を受け取る」をクリックして登録すると、変更されたすべての製品情報に関するダイジェストを毎週受け取れます。変更の詳細については、修正されたドキュメントに含まれている改訂履歴をご覧ください。

9.4 サポート・リソース

[TI E2E™ サポート・フォーラム](#)は、エンジニアが検証済みの回答と設計に関するヒントをエキスパートから迅速かつ直接得ることができる場所です。既存の回答を検索したり、独自の質問をしたりすることで、設計に必要な支援を迅速に得ることができます。

リンクされているコンテンツは、該当する貢献者により、現状のまま提供されるものです。これらは TI の仕様を構成するものではなく、必ずしも TI の見解を反映したものではありません。TI の[使用条件](#)を参照してください。

9.5 Trademarks

TI E2E™ is a trademark of Texas Instruments.

すべての商標は、それぞれの所有者に帰属します。

9.6 静電気放電に関する注意事項



この IC は、ESD によって破損する可能性があります。テキサス・インスツルメンツは、IC を取り扱う際には常に適切な注意を払うことを推奨します。正しい取り扱いおよび設置手順に従わない場合、デバイスを破損するおそれがあります。

ESD による破損は、わずかな性能低下からデバイスの完全な故障まで多岐にわたります。精密な IC の場合、パラメータがわずかに変化するだけで公表されている仕様から外れる可能性があるため、破損が発生しやすくなっています。

9.7 用語集

[テキサス・インスツルメンツ用語集](#)

この用語集には、用語や略語の一覧および定義が記載されています。

10 Mechanical, Packaging, and Orderable Information

The following pages include mechanical, packaging, and orderable information. This information is the most current data available for the designated devices. This data is subject to change without notice and revision of this document. For browser-based versions of this data sheet, refer to the left-hand navigation.

PACKAGING INFORMATION

Orderable part number	Status (1)	Material type (2)	Package Pins	Package qty Carrier	RoHS (3)	Lead finish/ Ball material (4)	MSL rating/ Peak reflow (5)	Op temp (°C)	Part marking (6)
TLV70418DBVR	Active	Production	SOT-23 (DBV) 5	3000 LARGE T&R	Yes	NIPDAU	Level-1-260C-UNLIM	-40 to 125	1NG
TLV70418DBVR.A	Active	Production	SOT-23 (DBV) 5	3000 LARGE T&R	Yes	NIPDAU	Level-1-260C-UNLIM	-40 to 125	1NG
TLV70430DBVR	Active	Production	SOT-23 (DBV) 5	3000 LARGE T&R	Yes	NIPDAU	Level-1-260C-UNLIM	-40 to 125	QUQ
TLV70430DBVR.A	Active	Production	SOT-23 (DBV) 5	3000 LARGE T&R	Yes	NIPDAU	Level-1-260C-UNLIM	-40 to 125	QUQ
TLV70430DBVRG4	Active	Production	SOT-23 (DBV) 5	3000 LARGE T&R	Yes	NIPDAU	Level-1-260C-UNLIM	-40 to 125	QUQ
TLV70430DBVRG4.A	Active	Production	SOT-23 (DBV) 5	3000 LARGE T&R	Yes	NIPDAU	Level-1-260C-UNLIM	-40 to 125	QUQ
TLV70430DBVT	Active	Production	SOT-23 (DBV) 5	250 SMALL T&R	Yes	NIPDAU	Level-1-260C-UNLIM	-40 to 125	QUQ
TLV70430DBVT.A	Active	Production	SOT-23 (DBV) 5	250 SMALL T&R	Yes	NIPDAU	Level-1-260C-UNLIM	-40 to 125	QUQ
TLV70433DBVR	Active	Production	SOT-23 (DBV) 5	3000 LARGE T&R	Yes	NIPDAU SN	Level-1-260C-UNLIM	-40 to 125	PAO
TLV70433DBVR.A	Active	Production	SOT-23 (DBV) 5	3000 LARGE T&R	Yes	SN	Level-1-260C-UNLIM	-40 to 125	PAO
TLV70433DBVRG4	Active	Production	SOT-23 (DBV) 5	3000 LARGE T&R	Yes	NIPDAU	Level-1-260C-UNLIM	-40 to 125	PAO
TLV70433DBVRG4.A	Active	Production	SOT-23 (DBV) 5	3000 LARGE T&R	Yes	NIPDAU	Level-1-260C-UNLIM	-40 to 125	PAO
TLV70433DBVRM3	Active	Production	SOT-23 (DBV) 5	3000 LARGE T&R	Yes	NIPDAU	Level-1-260C-UNLIM	-40 to 125	PAO
TLV70433DBVRM3.A	Active	Production	SOT-23 (DBV) 5	3000 LARGE T&R	Yes	NIPDAU	Level-1-260C-UNLIM	-40 to 125	PAO
TLV70433DBVT	Active	Production	SOT-23 (DBV) 5	250 SMALL T&R	Yes	NIPDAU SN	Level-1-260C-UNLIM	-40 to 125	PAO
TLV70433DBVT.A	Active	Production	SOT-23 (DBV) 5	250 SMALL T&R	Yes	SN	Level-1-260C-UNLIM	-40 to 125	PAO
TLV704345DBVR	Active	Production	SOT-23 (DBV) 5	3000 LARGE T&R	Yes	NIPDAU	Level-1-260C-UNLIM	-40 to 125	13T
TLV704345DBVR.A	Active	Production	SOT-23 (DBV) 5	3000 LARGE T&R	Yes	NIPDAU	Level-1-260C-UNLIM	-40 to 125	13T
TLV704345DBVRM3	Active	Production	SOT-23 (DBV) 5	3000 LARGE T&R	Yes	NIPDAU	Level-1-260C-UNLIM	-40 to 125	13T
TLV704345DBVRM3.A	Active	Production	SOT-23 (DBV) 5	3000 LARGE T&R	Yes	NIPDAU	Level-1-260C-UNLIM	-40 to 125	13T
TLV704345DBVT	Active	Production	SOT-23 (DBV) 5	250 SMALL T&R	Yes	NIPDAU	Level-1-260C-UNLIM	-40 to 125	13T
TLV704345DBVT.A	Active	Production	SOT-23 (DBV) 5	250 SMALL T&R	Yes	NIPDAU	Level-1-260C-UNLIM	-40 to 125	13T
TLV70436DBVR	Active	Production	SOT-23 (DBV) 5	3000 LARGE T&R	Yes	NIPDAU SN	Level-1-260C-UNLIM	-40 to 125	PAW
TLV70436DBVR.A	Active	Production	SOT-23 (DBV) 5	3000 LARGE T&R	Yes	NIPDAU	Level-1-260C-UNLIM	-40 to 125	PAW
TLV70436DBVRG4	Active	Production	SOT-23 (DBV) 5	3000 LARGE T&R	Yes	NIPDAU	Level-1-260C-UNLIM	-40 to 125	PAW
TLV70436DBVRG4.A	Active	Production	SOT-23 (DBV) 5	3000 LARGE T&R	Yes	NIPDAU	Level-1-260C-UNLIM	-40 to 125	PAW
TLV70436DBVRM3	Active	Production	SOT-23 (DBV) 5	3000 LARGE T&R	Yes	NIPDAU	Level-1-260C-UNLIM	-40 to 125	PAW
TLV70436DBVRM3.A	Active	Production	SOT-23 (DBV) 5	3000 LARGE T&R	Yes	NIPDAU	Level-1-260C-UNLIM	-40 to 125	PAW
TLV70436DBVT	Active	Production	SOT-23 (DBV) 5	250 SMALL T&R	Yes	NIPDAU	Level-1-260C-UNLIM	-40 to 125	PAW

Orderable part number	Status (1)	Material type (2)	Package Pins	Package qty Carrier	RoHS (3)	Lead finish/ Ball material (4)	MSL rating/ Peak reflow (5)	Op temp (°C)	Part marking (6)
TLV70436DBVT.A	Active	Production	SOT-23 (DBV) 5	250 SMALL T&R	Yes	NIPDAU	Level-1-260C-UNLIM	-40 to 125	PAW
TLV70450DBVR	Active	Production	SOT-23 (DBV) 5	3000 LARGE T&R	Yes	NIPDAU	Level-1-260C-UNLIM	-40 to 125	PAX
TLV70450DBVR.A	Active	Production	SOT-23 (DBV) 5	3000 LARGE T&R	Yes	NIPDAU	Level-1-260C-UNLIM	-40 to 125	PAX
TLV70450DBVRG4	Active	Production	SOT-23 (DBV) 5	3000 LARGE T&R	Yes	NIPDAU	Level-1-260C-UNLIM	-40 to 125	PAX
TLV70450DBVRG4.A	Active	Production	SOT-23 (DBV) 5	3000 LARGE T&R	Yes	NIPDAU	Level-1-260C-UNLIM	-40 to 125	PAX
TLV70450DBVRM3	Active	Production	SOT-23 (DBV) 5	3000 LARGE T&R	Yes	NIPDAU	Level-1-260C-UNLIM	-40 to 125	PAX
TLV70450DBVRM3.A	Active	Production	SOT-23 (DBV) 5	3000 LARGE T&R	Yes	NIPDAU	Level-1-260C-UNLIM	-40 to 125	PAX
TLV70450DBVT	Active	Production	SOT-23 (DBV) 5	250 SMALL T&R	Yes	NIPDAU	Level-1-260C-UNLIM	-40 to 125	PAX
TLV70450DBVT.A	Active	Production	SOT-23 (DBV) 5	250 SMALL T&R	Yes	NIPDAU	Level-1-260C-UNLIM	-40 to 125	PAX

(1) **Status:** For more details on status, see our [product life cycle](#).

(2) **Material type:** When designated, preproduction parts are prototypes/experimental devices, and are not yet approved or released for full production. Testing and final process, including without limitation quality assurance, reliability performance testing, and/or process qualification, may not yet be complete, and this item is subject to further changes or possible discontinuation. If available for ordering, purchases will be subject to an additional waiver at checkout, and are intended for early internal evaluation purposes only. These items are sold without warranties of any kind.

(3) **RoHS values:** Yes, No, RoHS Exempt. See the [TI RoHS Statement](#) for additional information and value definition.

(4) **Lead finish/Ball material:** Parts may have multiple material finish options. Finish options are separated by a vertical ruled line. Lead finish/Ball material values may wrap to two lines if the finish value exceeds the maximum column width.

(5) **MSL rating/Peak reflow:** The moisture sensitivity level ratings and peak solder (reflow) temperatures. In the event that a part has multiple moisture sensitivity ratings, only the lowest level per JEDEC standards is shown. Refer to the shipping label for the actual reflow temperature that will be used to mount the part to the printed circuit board.

(6) **Part marking:** There may be an additional marking, which relates to the logo, the lot trace code information, or the environmental category of the part.

Multiple part markings will be inside parentheses. Only one part marking contained in parentheses and separated by a "~" will appear on a part. If a line is indented then it is a continuation of the previous line and the two combined represent the entire part marking for that device.

Important Information and Disclaimer: The information provided on this page represents TI's knowledge and belief as of the date that it is provided. TI bases its knowledge and belief on information provided by third parties, and makes no representation or warranty as to the accuracy of such information. Efforts are underway to better integrate information from third parties. TI has taken and continues to take reasonable steps to provide representative and accurate information but may not have conducted destructive testing or chemical analysis on incoming materials and chemicals. TI and TI suppliers consider certain information to be proprietary, and thus CAS numbers and other limited information may not be available for release.

In no event shall TI's liability arising out of such information exceed the total purchase price of the TI part(s) at issue in this document sold by TI to Customer on an annual basis.

TAPE AND REEL INFORMATION

QUADRANT ASSIGNMENTS FOR PIN 1 ORIENTATION IN TAPE

*All dimensions are nominal

Device	Package Type	Package Drawing	Pins	SPQ	Reel Diameter (mm)	Reel Width W1 (mm)	A0 (mm)	B0 (mm)	K0 (mm)	P1 (mm)	W (mm)	Pin1 Quadrant
TLV70418DBVR	SOT-23	DBV	5	3000	180.0	8.4	3.2	3.2	1.4	4.0	8.0	Q3
TLV70418DBVR	SOT-23	DBV	5	3000	180.0	8.4	3.2	3.2	1.4	4.0	8.0	Q3
TLV70430DBVR	SOT-23	DBV	5	3000	180.0	8.4	3.2	3.2	1.4	4.0	8.0	Q3
TLV70430DBVR	SOT-23	DBV	5	3000	180.0	8.4	3.2	3.2	1.4	4.0	8.0	Q3
TLV70430DBVRG4	SOT-23	DBV	5	3000	180.0	8.4	3.2	3.2	1.4	4.0	8.0	Q3
TLV70430DBVRG4	SOT-23	DBV	5	3000	180.0	8.4	3.2	3.2	1.4	4.0	8.0	Q3
TLV70430DBVT	SOT-23	DBV	5	250	178.0	8.4	3.23	3.17	1.37	4.0	8.0	Q3
TLV70433DBVR	SOT-23	DBV	5	3000	180.0	8.4	3.2	3.2	1.4	4.0	8.0	Q3
TLV70433DBVR	SOT-23	DBV	5	3000	180.0	8.4	3.2	3.2	1.4	4.0	8.0	Q3
TLV70433DBVRG4	SOT-23	DBV	5	3000	180.0	8.4	3.2	3.2	1.4	4.0	8.0	Q3
TLV70433DBVRG4	SOT-23	DBV	5	3000	180.0	8.4	3.2	3.2	1.4	4.0	8.0	Q3
TLV70433DBVRM3	SOT-23	DBV	5	3000	180.0	8.4	3.2	3.2	1.4	4.0	8.0	Q3
TLV70433DBVRM3	SOT-23	DBV	5	3000	180.0	8.4	3.2	3.2	1.4	4.0	8.0	Q3
TLV70433DBVT	SOT-23	DBV	5	250	180.0	8.4	3.2	3.2	1.4	4.0	8.0	Q3
TLV70433DBVT	SOT-23	DBV	5	250	180.0	8.4	3.2	3.2	1.4	4.0	8.0	Q3
TLV704345DBVR	SOT-23	DBV	5	3000	180.0	8.4	3.2	3.2	1.4	4.0	8.0	Q3

Device	Package Type	Package Drawing	Pins	SPQ	Reel Diameter (mm)	Reel Width W1 (mm)	A0 (mm)	B0 (mm)	K0 (mm)	P1 (mm)	W (mm)	Pin1 Quadrant
TLV704345DBVR	SOT-23	DBV	5	3000	180.0	8.4	3.2	3.2	1.4	4.0	8.0	Q3
TLV704345DBVRM3	SOT-23	DBV	5	3000	180.0	8.4	3.2	3.2	1.4	4.0	8.0	Q3
TLV704345DBVRM3	SOT-23	DBV	5	3000	180.0	8.4	3.2	3.2	1.4	4.0	8.0	Q3
TLV704345DBVT	SOT-23	DBV	5	250	178.0	8.4	3.23	3.17	1.37	4.0	8.0	Q3
TLV70436DBVR	SOT-23	DBV	5	3000	180.0	8.4	3.2	3.2	1.4	4.0	8.0	Q3
TLV70436DBVR	SOT-23	DBV	5	3000	180.0	8.4	3.2	3.2	1.4	4.0	8.0	Q3
TLV70436DBVRG4	SOT-23	DBV	5	3000	180.0	8.4	3.2	3.2	1.4	4.0	8.0	Q3
TLV70436DBVRG4	SOT-23	DBV	5	3000	180.0	8.4	3.2	3.2	1.4	4.0	8.0	Q3
TLV70436DBVRM3	SOT-23	DBV	5	3000	180.0	8.4	3.2	3.2	1.4	4.0	8.0	Q3
TLV70436DBVRM3	SOT-23	DBV	5	3000	180.0	8.4	3.2	3.2	1.4	4.0	8.0	Q3
TLV70436DBVT	SOT-23	DBV	5	250	178.0	8.4	3.23	3.17	1.37	4.0	8.0	Q3
TLV70450DBVR	SOT-23	DBV	5	3000	180.0	8.4	3.2	3.2	1.4	4.0	8.0	Q3
TLV70450DBVR	SOT-23	DBV	5	3000	180.0	8.4	3.2	3.2	1.4	4.0	8.0	Q3
TLV70450DBVRG4	SOT-23	DBV	5	3000	180.0	8.4	3.2	3.2	1.4	4.0	8.0	Q3
TLV70450DBVRG4	SOT-23	DBV	5	3000	180.0	8.4	3.2	3.2	1.4	4.0	8.0	Q3
TLV70450DBVRM3	SOT-23	DBV	5	3000	180.0	8.4	3.2	3.2	1.4	4.0	8.0	Q3
TLV70450DBVRM3	SOT-23	DBV	5	3000	180.0	8.4	3.2	3.2	1.4	4.0	8.0	Q3
TLV70450DBVT	SOT-23	DBV	5	250	180.0	8.4	3.2	3.2	1.4	4.0	8.0	Q3
TLV70450DBVT	SOT-23	DBV	5	250	180.0	8.4	3.2	3.2	1.4	4.0	8.0	Q3

TAPE AND REEL BOX DIMENSIONS

*All dimensions are nominal

Device	Package Type	Package Drawing	Pins	SPQ	Length (mm)	Width (mm)	Height (mm)
TLV70418DBVR	SOT-23	DBV	5	3000	210.0	185.0	35.0
TLV70418DBVR	SOT-23	DBV	5	3000	210.0	185.0	35.0
TLV70430DBVR	SOT-23	DBV	5	3000	210.0	185.0	35.0
TLV70430DBVR	SOT-23	DBV	5	3000	210.0	185.0	35.0
TLV70430DBVRG4	SOT-23	DBV	5	3000	210.0	185.0	35.0
TLV70430DBVRG4	SOT-23	DBV	5	3000	210.0	185.0	35.0
TLV70430DBVT	SOT-23	DBV	5	250	180.0	180.0	18.0
TLV70433DBVR	SOT-23	DBV	5	3000	210.0	185.0	35.0
TLV70433DBVR	SOT-23	DBV	5	3000	210.0	185.0	35.0
TLV70433DBVRG4	SOT-23	DBV	5	3000	210.0	185.0	35.0
TLV70433DBVRG4	SOT-23	DBV	5	3000	210.0	185.0	35.0
TLV70433DBVRM3	SOT-23	DBV	5	3000	210.0	185.0	35.0
TLV70433DBVRM3	SOT-23	DBV	5	3000	210.0	185.0	35.0
TLV70433DBVT	SOT-23	DBV	5	250	210.0	185.0	35.0
TLV70433DBVT	SOT-23	DBV	5	250	210.0	185.0	35.0
TLV704345DBVR	SOT-23	DBV	5	3000	210.0	185.0	35.0
TLV704345DBVR	SOT-23	DBV	5	3000	210.0	185.0	35.0
TLV704345DBVRM3	SOT-23	DBV	5	3000	210.0	185.0	35.0

Device	Package Type	Package Drawing	Pins	SPQ	Length (mm)	Width (mm)	Height (mm)
TLV704345DBVRM3	SOT-23	DBV	5	3000	210.0	185.0	35.0
TLV704345DBVT	SOT-23	DBV	5	250	180.0	180.0	18.0
TLV70436DBVR	SOT-23	DBV	5	3000	210.0	185.0	35.0
TLV70436DBVR	SOT-23	DBV	5	3000	210.0	185.0	35.0
TLV70436DBVRG4	SOT-23	DBV	5	3000	210.0	185.0	35.0
TLV70436DBVRG4	SOT-23	DBV	5	3000	210.0	185.0	35.0
TLV70436DBVRM3	SOT-23	DBV	5	3000	210.0	185.0	35.0
TLV70436DBVRM3	SOT-23	DBV	5	3000	210.0	185.0	35.0
TLV70436DBVT	SOT-23	DBV	5	250	180.0	180.0	18.0
TLV70450DBVR	SOT-23	DBV	5	3000	210.0	185.0	35.0
TLV70450DBVR	SOT-23	DBV	5	3000	210.0	185.0	35.0
TLV70450DBVRG4	SOT-23	DBV	5	3000	210.0	185.0	35.0
TLV70450DBVRG4	SOT-23	DBV	5	3000	210.0	185.0	35.0
TLV70450DBVRM3	SOT-23	DBV	5	3000	210.0	185.0	35.0
TLV70450DBVRM3	SOT-23	DBV	5	3000	210.0	185.0	35.0
TLV70450DBVT	SOT-23	DBV	5	250	210.0	185.0	35.0
TLV70450DBVT	SOT-23	DBV	5	250	210.0	185.0	35.0

DBV0005A



PACKAGE OUTLINE

SOT-23 - 1.45 mm max height

SMALL OUTLINE TRANSISTOR

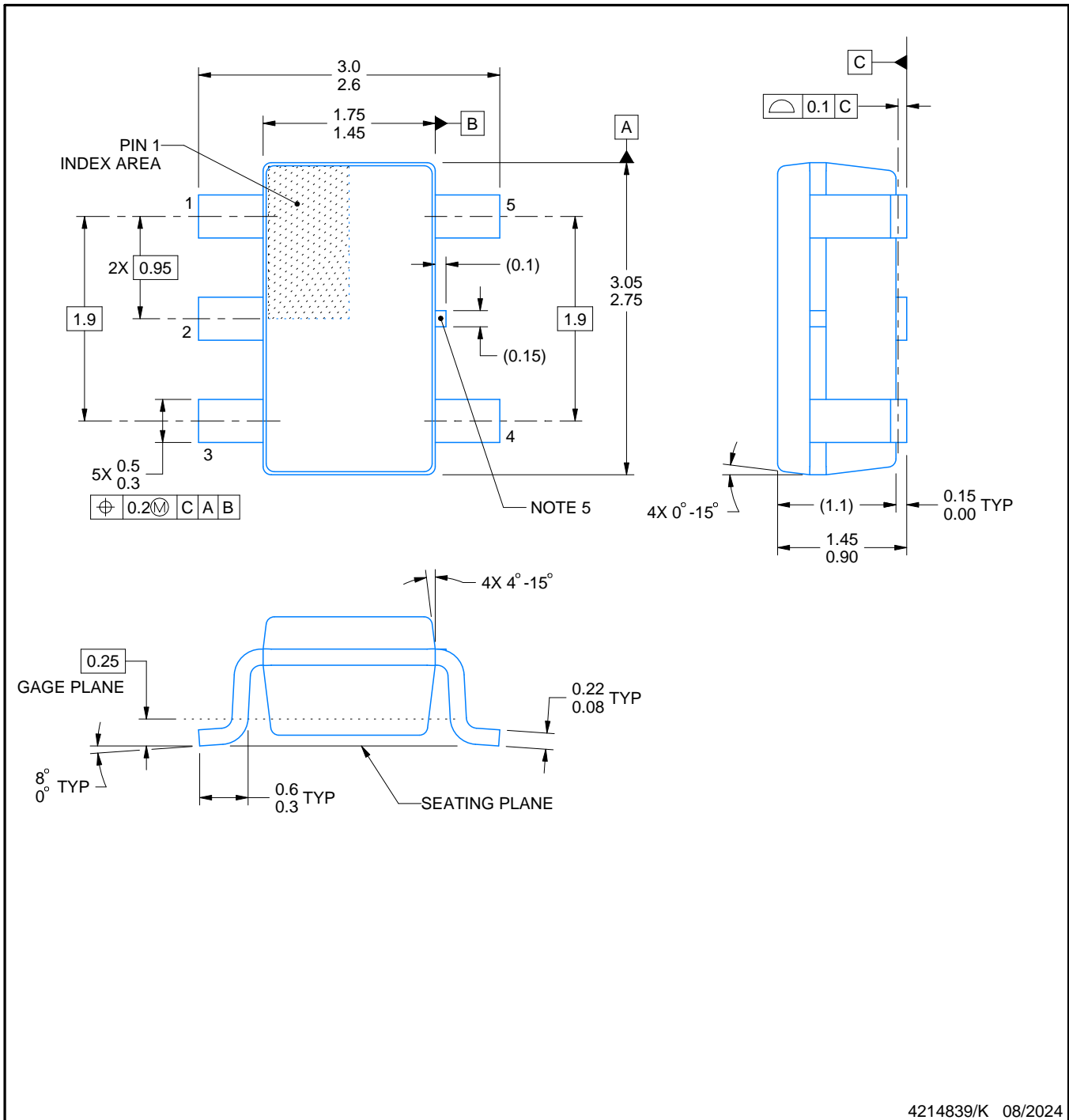

4214839/K 08/2024

NOTES:

1. All linear dimensions are in millimeters. Any dimensions in parenthesis are for reference only. Dimensioning and tolerancing per ASME Y14.5M.
2. This drawing is subject to change without notice.
3. Reference JEDEC MO-178.
4. Body dimensions do not include mold flash, protrusions, or gate burrs. Mold flash, protrusions, or gate burrs shall not exceed 0.25 mm per side.
5. Support pin may differ or may not be present.

EXAMPLE BOARD LAYOUT

DBV0005A

SOT-23 - 1.45 mm max height

SMALL OUTLINE TRANSISTOR



LAND PATTERN EXAMPLE
EXPOSED METAL SHOWN
SCALE:15X



SOLDER MASK DETAILS

4214839/K 08/2024

NOTES: (continued)

- 6. Publication IPC-7351 may have alternate designs.
- 7. Solder mask tolerances between and around signal pads can vary based on board fabrication site.

EXAMPLE STENCIL DESIGN

DBV0005A

SOT-23 - 1.45 mm max height

SMALL OUTLINE TRANSISTOR



SOLDER PASTE EXAMPLE
BASED ON 0.125 mm THICK STENCIL
SCALE:15X

4214839/K 08/2024

NOTES: (continued)

8. Laser cutting apertures with trapezoidal walls and rounded corners may offer better paste release. IPC-7525 may have alternate design recommendations.
9. Board assembly site may have different recommendations for stencil design.

重要なお知らせと免責事項

TI は、技術データと信頼性データ (データシートを含みます)、設計リソース (リファレンス デザインを含みます)、アプリケーションや設計に関する各種アドバイス、Web ツール、安全性情報、その他のリソースを、欠陥が存在する可能性のある「現状のまま」提供しており、商品性および特定目的に対する適合性の黙示保証、第三者の知的財産権の非侵害保証を含むいかなる保証も、明示的または黙示的にかかわらず拒否します。

これらのリソースは、TI 製品を使用する設計の経験を積んだ開発者への提供を意図したものです。(1) お客様のアプリケーションに適した TI 製品の選定、(2) お客様のアプリケーションの設計、検証、試験、(3) お客様のアプリケーションに該当する各種規格や、その他のあらゆる安全性、セキュリティ、規制、または他の要件への確実な適合に関する責任を、お客様のみが単独で負うものとし、

上記の各種リソースは、予告なく変更される可能性があります。これらのリソースは、リソースで説明されている TI 製品を使用するアプリケーションの開発の目的でのみ、TI はその使用をお客様に許諾します。これらのリソースに関して、他の目的で複製することや掲載することは禁止されています。TI や第三者の知的財産権のライセンスが付与されている訳ではありません。お客様は、これらのリソースを自身で使用した結果発生するあらゆる申し立て、損害、費用、損失、責任について、TI およびその代理人を完全に補償するものとし、TI は一切の責任を拒否します。

TI の製品は、[TI の販売条件](#)、[TI の総合的な品質ガイドライン](#)、[ti.com](#) または TI 製品などに関連して提供される他の適用条件に従い提供されます。TI がこれらのリソースを提供することは、適用される TI の保証または他の保証の放棄の拡大や変更を意味するものではありません。TI がカスタム、またはカスタマー仕様として明示的に指定していない限り、TI の製品は標準的なカタログに掲載される汎用機器です。

お客様がいかなる追加条項または代替条項を提案する場合も、TI はそれらに異議を唱え、拒否します。

Copyright © 2026, Texas Instruments Incorporated

最終更新日 : 2025 年 10 月