

TMAG5124-Q1 車載用 2 線式、高精度、ホール・エフェクト・スイッチ・センサ

1 特長

- 下記内容で AEC-Q100 認定済み:
 - デバイス温度グレード 0: $-40^{\circ}\text{C} \sim 150^{\circ}\text{C}$ の動作時周囲温度範囲
- 2 線式インターフェイス搭載、ホール・エフェクト・スイッチ
- ローレベル電流出力オプション:
 - TMAG5124A/B/C/D-Q1: 3.5mA
 - TMAG5124E/F/G/H-Q1: 6mA
- 磁気感度:
 - TMAG5124A/E-Q1: $\pm 4\text{mT}$ (標準値)
 - TMAG5124B/F-Q1: $\pm 6\text{mT}$ (標準値)
 - TMAG5124C/G-Q1: $\pm 10\text{mT}$ (標準値)
 - TMAG5124D/H-Q1: $\pm 15\text{mT}$ (標準値)
- 高速センシング帯域幅: 40kHz
- 広い電圧範囲をサポート
 - 動作 V_{CC} 範囲: 2.7V~38V
 - 外部レギュレータ不要
- 保護機能:
 - 最大 40V のロード・ダンプに対応
 - 逆極性保護
- SOT-23 パッケージ・オプション

2 アプリケーション

- シート位置 / コンフォート・シート・モジュール
- ドア・ハンドル・モジュール
- ワイパー・モジュール
- トランク・モジュール
- ルーフ・モーター・モジュール
- ブレーキ・システム
- 電動パワー・ステアリング (EPS)

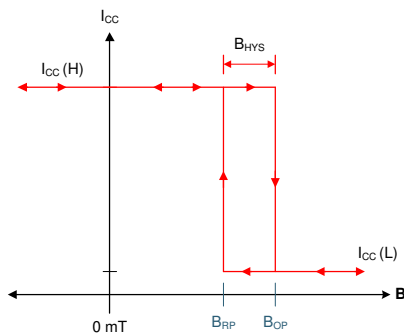

出力状態

3 概要

TMAG5124-Q1 デバイスは、車載用設計向けの 2 線式インターフェイスを提供する高精度ホール・エフェクト・センサです。

TMAG5124-Q1 には電流源が内蔵されており、部品に印加される磁界の値に応じて 2 レベル間で切り替えできます。大きい方の値は固定されていますが、小さい方の値は 2 つの範囲から選択できます。この種のインターフェイスは、センサとコントローラの間で信頼性の高い通信を実現し、長距離伝送を可能にし、接続切断の検出に役立つとともに、配線の数を 2 本に限定できます。

このデバイスは 3 ピン SOT-23 パッケージで供給されます。パッケージには 3 本のピンがありますが、このデバイスは VCC と GND ピンのみで動作します。電流は、これら 2 つのピンのいずれかから測定でき、ハイサイド構成またはローサイド構成が可能になります。

さまざまな製品バリエーションによってさまざまなレベルの磁気感度の選択が可能であり、アプリケーション固有の要件に合わせるすることができます。

TMAG5124-Q1 は、広い動作電圧範囲と逆極性保護機能を備え、さまざまな車載用アプリケーションに対応しています。

製品情報

部品番号	パッケージ ⁽¹⁾	本体サイズ (公称)
TMAG5124-Q1	SOT-23 (3)	2.92mm × 1.30mm

- (1) 利用可能なすべてのパッケージについては、このデータシートの末尾にあるパッケージ・オプションについての付録を参照してください。

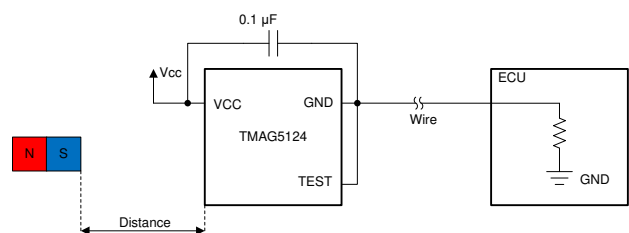

代表的な回路図



Table of Contents

1 特長	1	8.4 Device Functional Modes.....	16
2 アプリケーション	1	9 Application and Implementation	17
3 概要	1	9.1 Application Information.....	17
4 Revision History	2	9.2 Typical Applications.....	17
5 Device Comparison	3	10 Power Supply Recommendations	20
6 Pin Configuration and Functions	3	10.1 Power Derating.....	20
7 Specifications	4	11 Layout	21
7.1 Absolute Maximum Ratings.....	4	11.1 Layout Guidelines.....	21
7.2 ESD Ratings.....	4	11.2 Layout Example.....	21
7.3 Recommended Operating Conditions.....	4	12 Device and Documentation Support	22
7.4 Thermal Information.....	4	12.1 Documentation Support.....	22
7.5 Electrical Characteristics.....	5	12.2 ドキュメントの更新通知を受け取る方法.....	22
7.6 Magnetic Characteristics.....	5	12.3 サポート・リソース.....	22
7.7 Typical Characteristics.....	6	12.4 Trademarks.....	22
8 Detailed Description	11	12.5 静電気放電に関する注意事項.....	22
8.1 Overview.....	11	12.6 用語集.....	22
8.2 Functional Block Diagram.....	11	13 Mechanical, Packaging, and Orderable Information	22
8.3 Feature Description.....	11		

4 Revision History

資料番号末尾の英字は改訂を表しています。その改訂履歴は英語版に準じています。

DATE	REVISION	NOTES
November 2021	*	Initial Release

5 Device Comparison

表 5-1. Device Comparison

DEVICE	DEVICE OPTION	THRESHOLD LEVEL (BOP)	LOW-CURRENT LEVEL
TMAG5124-Q1	A1	4 mT	3.5 mA
	B1	6 mT	
	C1	10 mT	
	D1	15 mT	
	E1	4 mT	6 mA
	F1	6 mT	
	G1	10 mT	
	H1	15 mT	

6 Pin Configuration and Functions



図 6-1. DBZ Package 3-Pin SOT-23 Top View

表 6-1. Pin Functions

PIN		TYPE	DESCRIPTION
NO.	NAME		
1	VCC	Power supply	Power supply of 2.7 V to 38 V. Connect a ceramic capacitor with a value of at least 0.01 μ F between VCC and ground.
2	TEST	—	Must be connected to pin 3.
3	GND	Ground	Ground reference.

7 Specifications

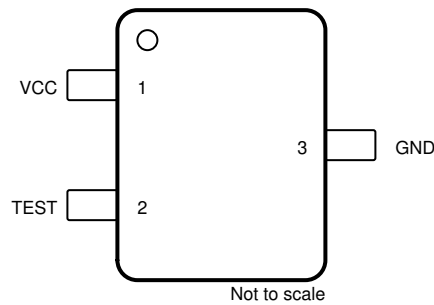
7.1 Absolute Maximum Ratings

over operating free-air temperature range (unless otherwise noted)⁽¹⁾

		MIN	MAX	UNIT
V _{CC}	Power supply voltage	-20	40	V
Magnetic Flux Density, B _{MAX}		Unlimited		T
T _J	Junction temperature		170	°C
Storage temperature, T _{stg}		-65	150	°C

- (1) Stresses beyond those listed under *Absolute Maximum Rating* may cause permanent damage to the device. These are stress ratings only, which do not imply functional operation of the device at these or any other conditions beyond those indicated under *Recommended Operating Condition*. Exposure to absolute-maximum-rated conditions for extended periods may affect device reliability.

7.2 ESD Ratings

			VALUE	UNIT
V _(ESD)	Electrostatic discharge	Human-body model (HBM), per AEC Q100-002 ⁽¹⁾ HBM ESD classification level 2	±2000	V
		Charged-device model (CDM), per AEC Q100-011 CDM ESD Classification level C4A	±500	

- (1) AEC Q100-002 indicates that HBM stressing shall be in accordance with the ANSI/ESDA/JEDEC JS-001 specification.

7.3 Recommended Operating Conditions

over operating free-air temperature range (unless otherwise noted)

		MIN	MAX	UNIT
V _{CC}	Power supply voltage	2.7	38	V
T _A	Ambient temperature	-40	150	°C

7.4 Thermal Information

THERMAL METRIC ⁽¹⁾		TMAG5124	UNIT
		DBV (SOT-23)	
		3 PINS	
R _{θJA}	Junction-to-ambient thermal resistance	198.5	°C/W
R _{θJC(top)}	Junction-to-case (top) thermal resistance	88.9	°C/W
R _{θJB}	Junction-to-board thermal resistance	28	°C/W
Ψ _{JT}	Junction-to-top characterization parameter	4	°C/W
Ψ _{JB}	Junction-to-board characterization parameter	27.7	°C/W
R _{θJC(bot)}	Junction-to-case (bottom) thermal resistance	—	°C/W

- (1) For more information about traditional and new thermal metrics, see the [Semiconductor and IC Package Thermal Metrics](#) application report.

7.5 Electrical Characteristics

over operating free-air temperature range (unless otherwise noted)

PARAMETER		TEST CONDITIONS	MIN	TYP	MAX	UNIT
POWER SUPPLY						
$I_{CC(L1)}$	Low-level supply current option 1	$V_{CC} = 2.7\text{ V to }38\text{ V}$, $T_A = -40^\circ\text{C to }150^\circ\text{C}$	2	3.5	5	mA
$I_{CC(L2)}$	Low-level supply current option 2	$V_{CC} = 2.7\text{ V to }38\text{ V}$, $T_A = -40^\circ\text{C to }150^\circ\text{C}$	4.8	6	7.8	
$I_{CC(H)}$	High-level supply current	$V_{CC} = 2.7\text{ V to }38\text{ V}$, $T_A = -40^\circ\text{C to }150^\circ\text{C}$	10.5	14.5	18	
I_{RCC}	Reverse supply current	$V_{RCC} = -20\text{ V}$			-100	μA
t_{ON}	Power-on-time			62.5		μs
OUTPUT						
di/dt	Supply Current Slew Rate	$V_{CC} = 12\text{V}$, $I_{CC(L)}$ to $I_{CC(H)}$, $I_{CC(H)}$ to $I_{CC(L)}$, $C_{BYP} = 0.01\mu\text{F}$		10		$\text{mA}/\mu\text{s}$
t_{PD}	Propagation delay time	Change in B field to change in output		12.5		μs
FREQUENCY RESPONSE						
f_{CHOP}	Chopping frequency			320		kHz
f_{BW}	Signal bandwidth			40		

7.6 Magnetic Characteristics

over operating free-air temperature range (unless otherwise noted)

PARAMETER		TEST CONDITIONS	MIN	TYP	MAX	UNIT
TMAG5124A, TMAG5124E						
B_{OP}	Magnetic field operating point	$V_{CC} = 2.7\text{ V to }38\text{ V}$, $T_A = -40^\circ\text{C to }150^\circ\text{C}$	3	4	5	mT
B_{RP}	Magnetic field release point		1	2	3	
B_{HYS}	Magnetic hysteresis $B_{OP} - B_{RP}$		0.6	2	3.4	
TMAG5124B, TMAG5124F						
B_{OP}	Magnetic field operating point	$V_{CC} = 2.7\text{ V to }38\text{ V}$, $T_A = -40^\circ\text{C to }150^\circ\text{C}$	5	6	7	mT
B_{RP}	Magnetic field release point		3	4	5	
B_{HYS}	Magnetic hysteresis $B_{OP} - B_{RP}$		0.6	2	3.4	
TMAG5124C, TMAG5124G						
B_{OP}	Magnetic field operating point	$V_{CC} = 2.7\text{ V to }38\text{ V}$, $T_A = -40^\circ\text{C to }150^\circ\text{C}$	8.8	10	11	mT
B_{RP}	Magnetic field release point		6.8	8	9.4	
B_{HYS}	Magnetic hysteresis $B_{OP} - B_{RP}$		0.6	2	3.4	
TMAG5124D, TMAG5124H						
B_{OP}	Magnetic field operating point	$V_{CC} = 2.7\text{ V to }38\text{ V}$, $T_A = -40^\circ\text{C to }150^\circ\text{C}$	13.6	15	16.1	mT
B_{RP}	Magnetic field release point		11.4	13	14.2	
B_{HYS}	Magnetic hysteresis $B_{OP} - B_{RP}$		0.6	2	3.4	

7.7 Typical Characteristics

7.7.1 TMAG5124A and TMAG5124E

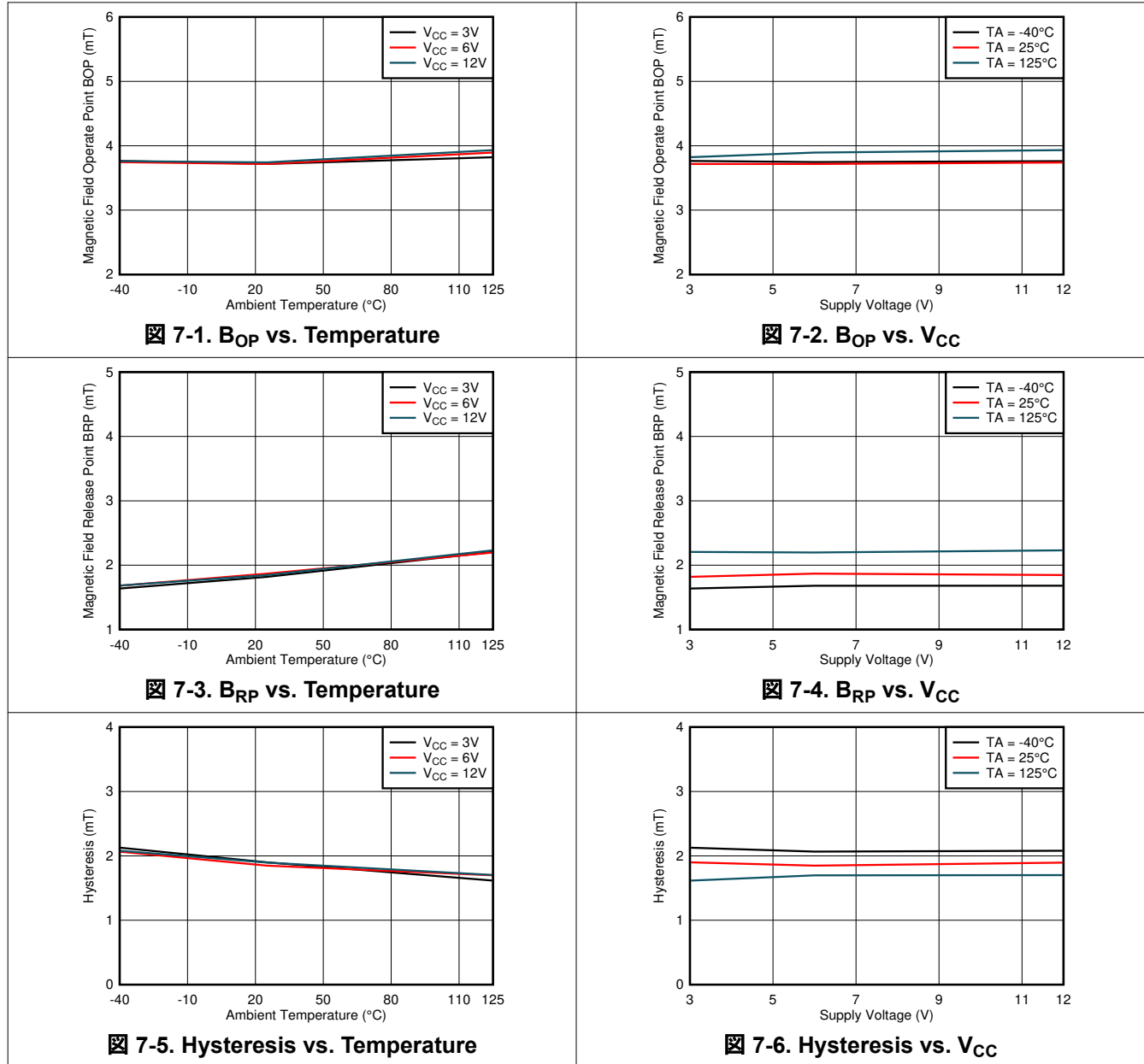

7.7.2 TMAG5124B and TMAG5124F

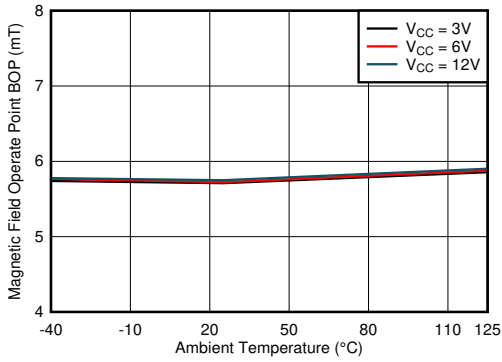

7-7. B_{OP} vs. Temperature

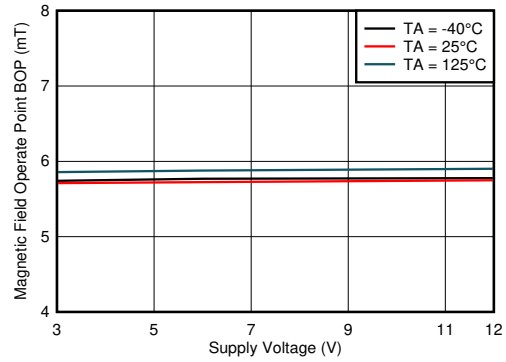

7-8. B_{OP} vs. V_{CC}

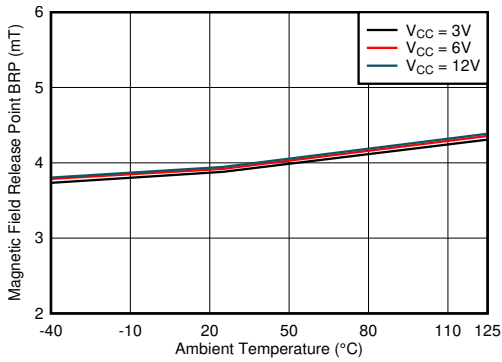

7-9. B_{RP} vs. Temperature

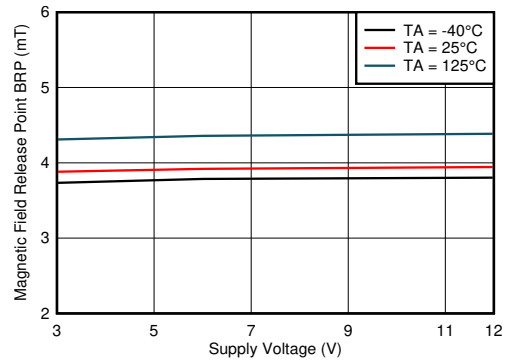

7-10. B_{RP} vs. V_{CC}

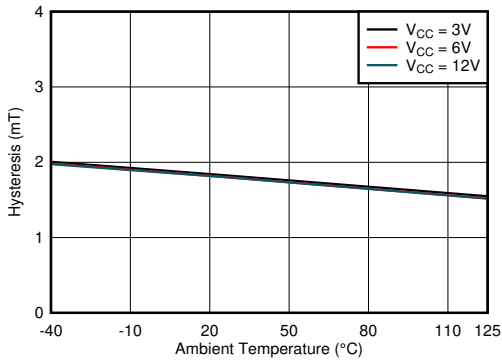

7-11. Hysteresis vs. Temperature

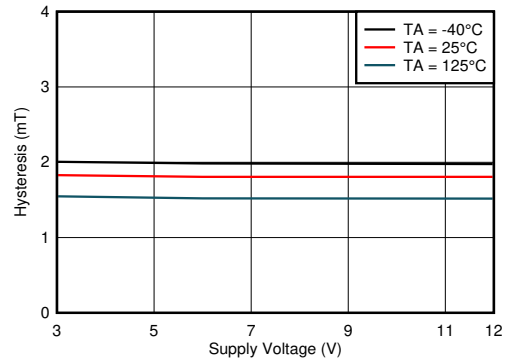

7-12. Hysteresis vs. V_{CC}

7.7.3 TMAG5124C and TMAG5124G

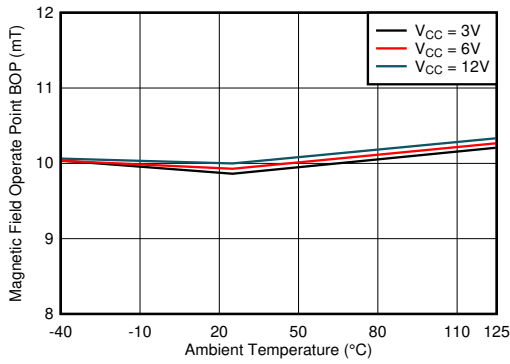

7-13. B_{OP} vs. Temperature

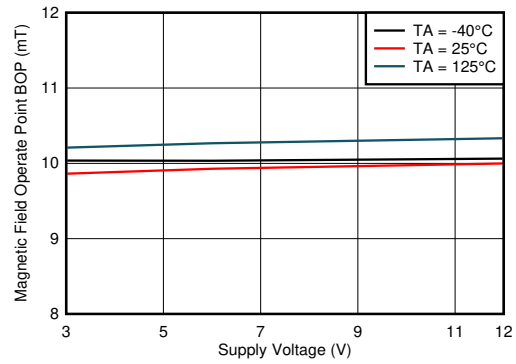

7-14. B_{OP} vs. V_{CC}

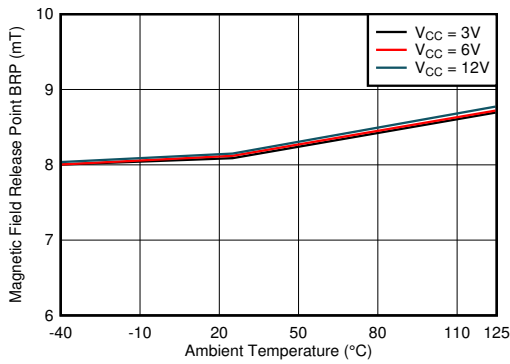

7-15. B_{RP} vs. Temperature

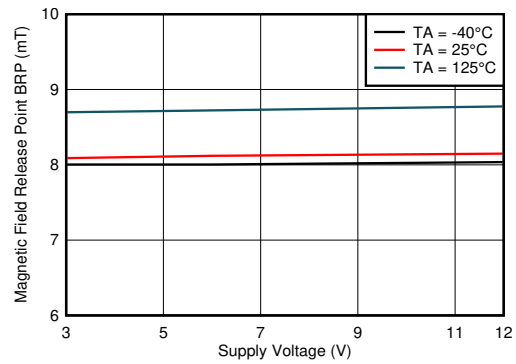

7-16. B_{RP} vs. V_{CC}

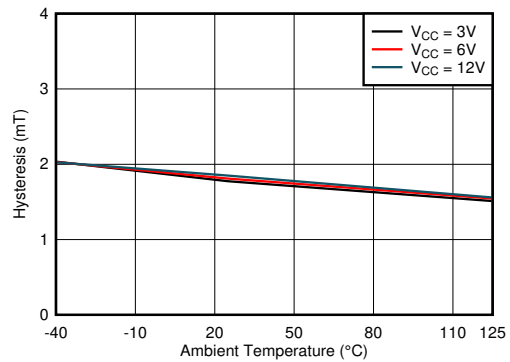

7-17. Hysteresis vs. Temperature

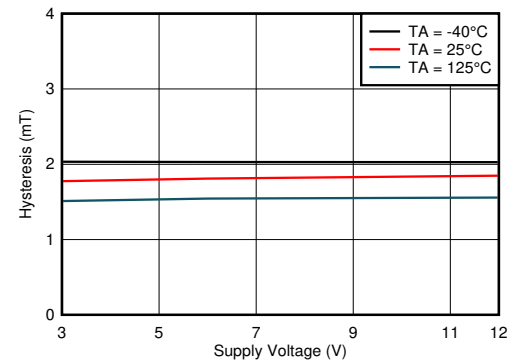

7-18. Hysteresis vs. V_{CC}

7.7.4 TMAG5124D and TMAG5124H



図 7-19. B_{OP} vs. Temperature



図 7-20. B_{OP} vs. V_{CC}

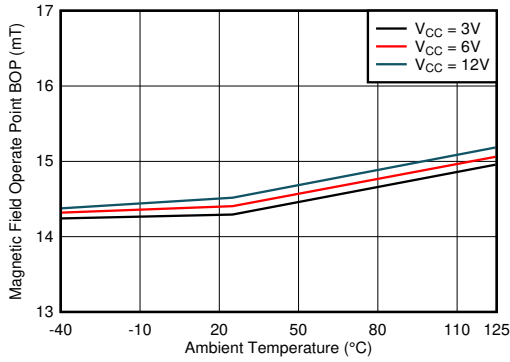

図 7-21. B_{RP} vs. Temperature

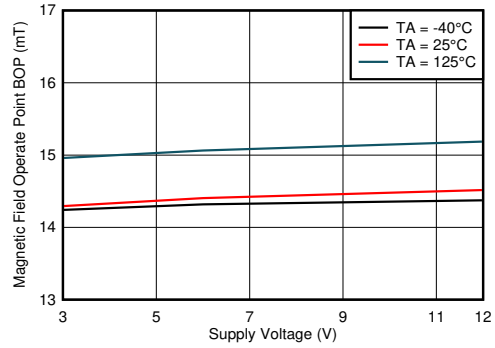

図 7-22. B_{RP} vs. V_{CC}

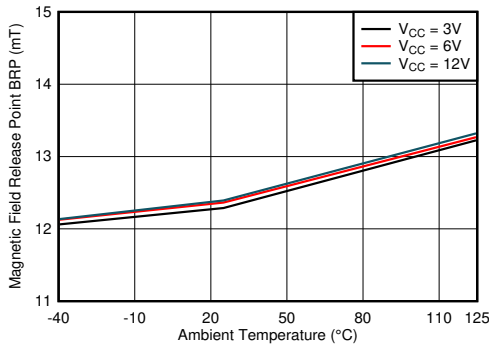

図 7-23. Hysteresis vs. Temperature

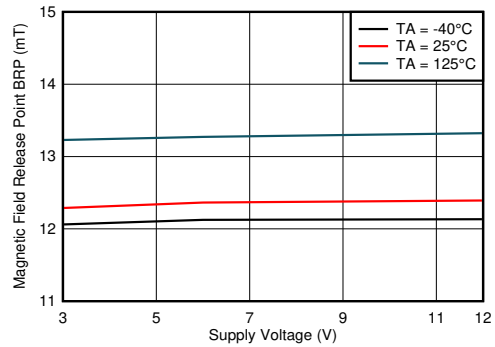

図 7-24. Hysteresis vs. V_{CC}

7.7.5 Current Output Level

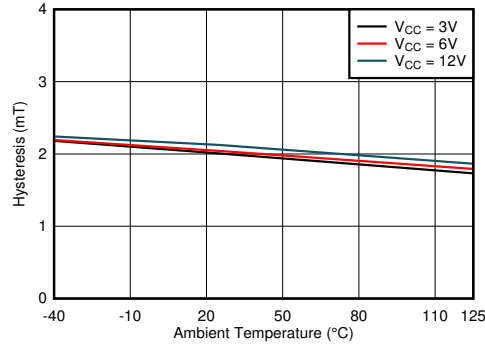
7.7.5.1 Low-Level Current Output for TMAG5124A/B/C/D

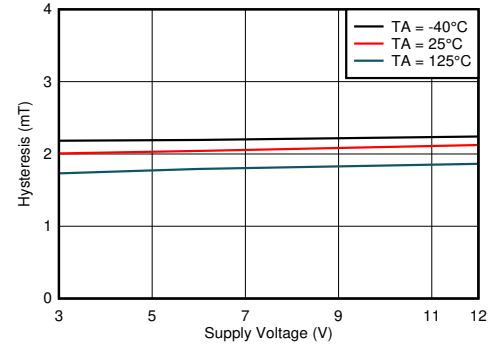
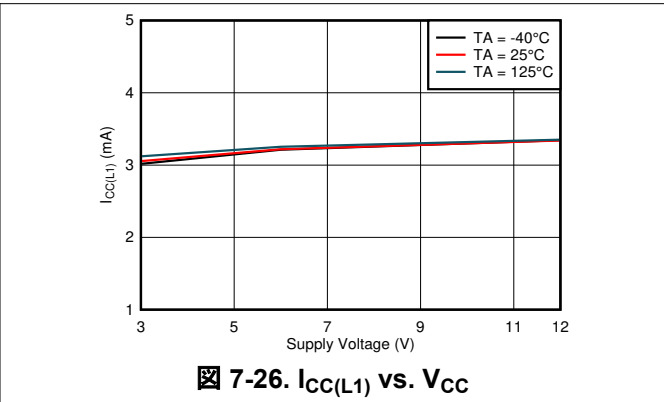
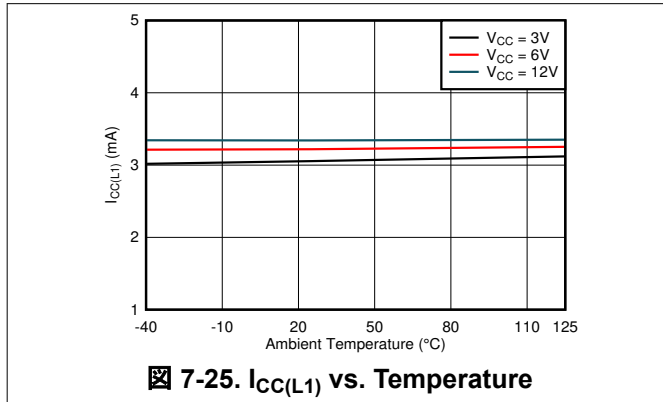

7.7.5.2 Low-Level Current Output for TMAG5124E/F/G/H

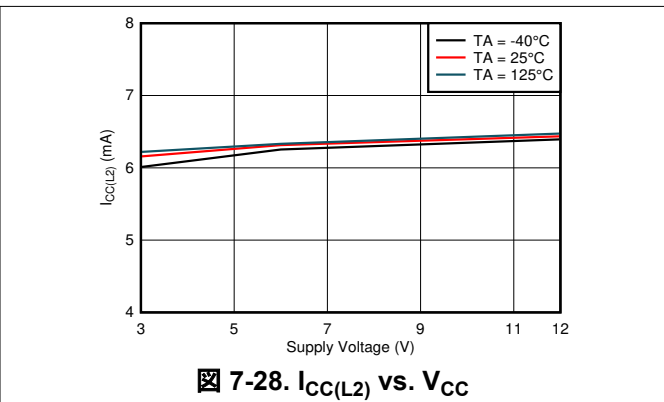
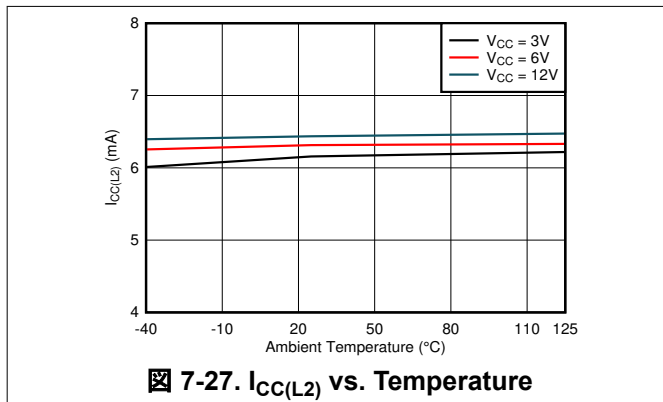

7.7.5.3 High-Level Current Output for Every Version

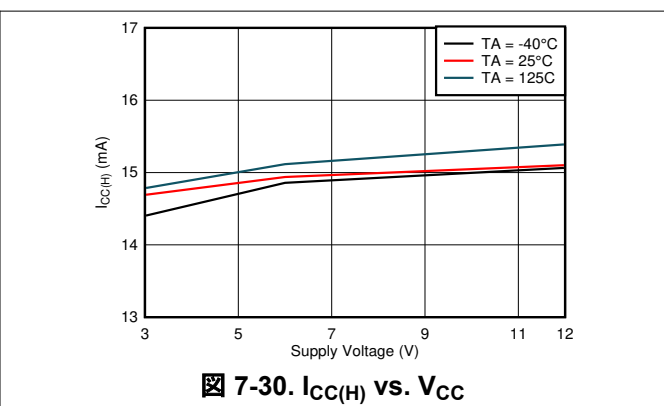
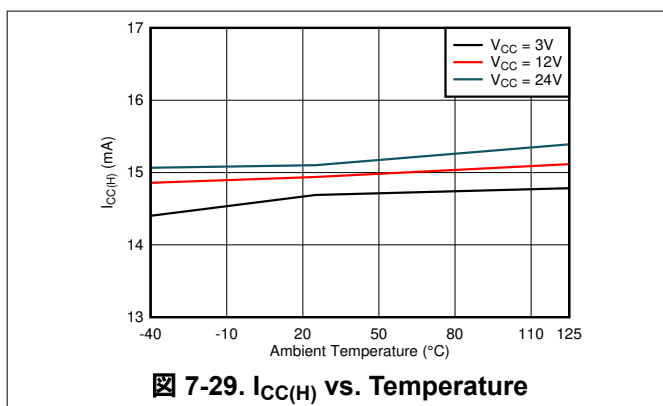

8 Detailed Description

8.1 Overview

The TMAG5124-Q1 is a magnetic sensor with a current interface, also called 2-wire interface, that indicates when the magnetic field threshold has been reached. A specific current level is generated depending on its status. All versions have a high-current level of 14.5 mA. Version A to D have a low-current level of 3.5 mA while version E to H have a low-current level of 6 mA.

The field polarity is defined as follows: a south pole near the marked side of the package has a positive magnetic field. A north pole near the marked side of the package has a negative magnetic field.

The unipolar south configuration allows the hall sensor to only respond to a south pole. A strong magnetic field of south polarity will cause the device to go into a low-current level (operate point, BOP), and a weaker magnetic field will cause the device to go into a high-current level (release point, BRP). Hysteresis is included in between the operate and release points, so magnetic field noise will not trip the device level accidentally.

The device does not have an output, therefore the magnitude of device supply current will indicate if the magnetic field exceeds the threshold or not. A resistor can be placed before the VCC pin or after the GND pin to transform the current into a voltage that can be read by a microcontroller. See [Application and Implementation](#) for more information.

8.2 Functional Block Diagram



図 8-1. Block Diagram

8.3 Feature Description

8.3.1 Field Direction Definition

図 8-2 shows that the TMAG5124-Q1 is sensitive to a south pole near the marked side of the package.

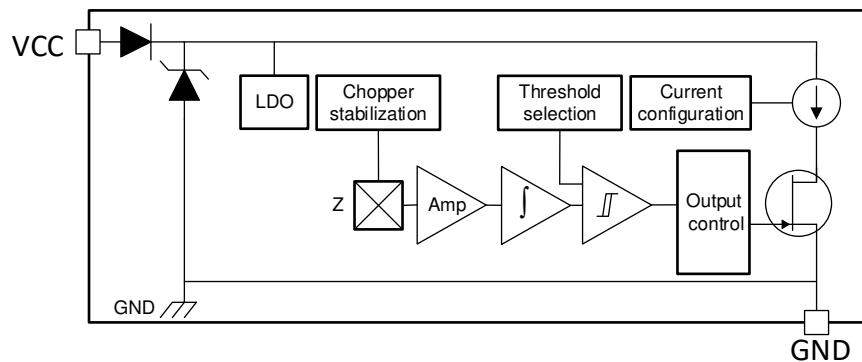

図 8-2. Field Direction Definition

8.3.2 Device Output

When the device is powered on and no magnetic field is applied, the output stays at $I_{CC(H)}$. If the magnetic field increases above the B_{OP} value, then the output turns to $I_{CC(L)}$. The output will remain at this value until the magnetic field decreases to a field value smaller than the B_{RP} threshold.

The $I_{CC(H)}$ for all TMAG5124x versions is between 12 mA to 17 mA. The $I_{CC(L)}$ option for the TMAG5124D versions is $I_{CC(L1)}$, which is typically 3.5 mA, while The $I_{CC(L)}$ for the TMAG5124H versions is $I_{CC(L2)}$ and is typically 6 mA.

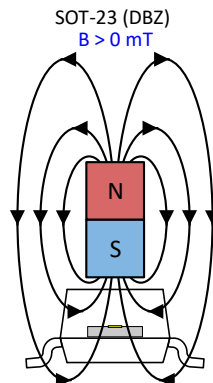

图 8-3. Unipolar Functionality

8.3.3 Protection Circuits

The TMAG5124-Q1 device is protected against load dump and reverse polarity conditions.

8.3.3.1 Load Dump Protection

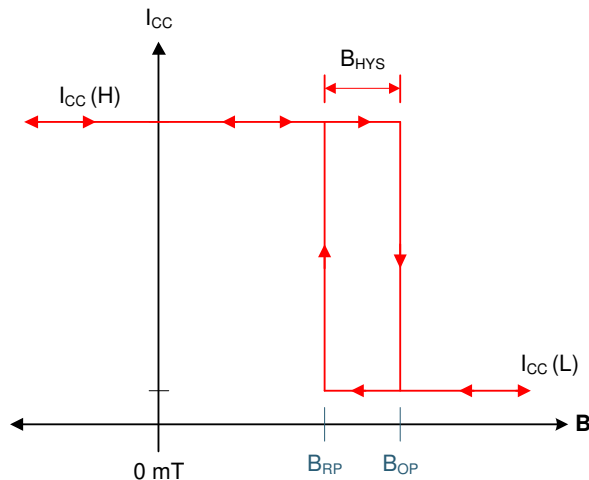
The TMAG5124-Q1 device operates at DC V_{CC} conditions up to 38 V nominally, and can additionally withstand $V_{CC} = 40$ V. No current-limiting series resistor is required for this protection.

8.3.3.2 Reverse Polarity Protection

The TMAG5124-Q1 device is protected in the event that the VCC pin and the GND pin are reversed (up to -20 V).

8.3.4 Power-On Time

 **8-4** shows the behavior of the device after the V_{CC} voltage is applied and when the field is below the B_{OP} threshold. When the minimum value for V_{CC} is reached, the TMAG5124-Q1 will take time t_{ON} to power up and then time t_d to update the output to a high level.

 **8-5** shows the behavior of the device after the V_{CC} voltage is applied and when the field is above the B_{OP} threshold. When the minimum value for V_{CC} is reached, the TMAG5124-Q1 will take time t_{ON} to power up and then time t_d to update the output to a high level.

The output value during t_{ON} is unknown in both cases. The output value during t_d will be set at high.

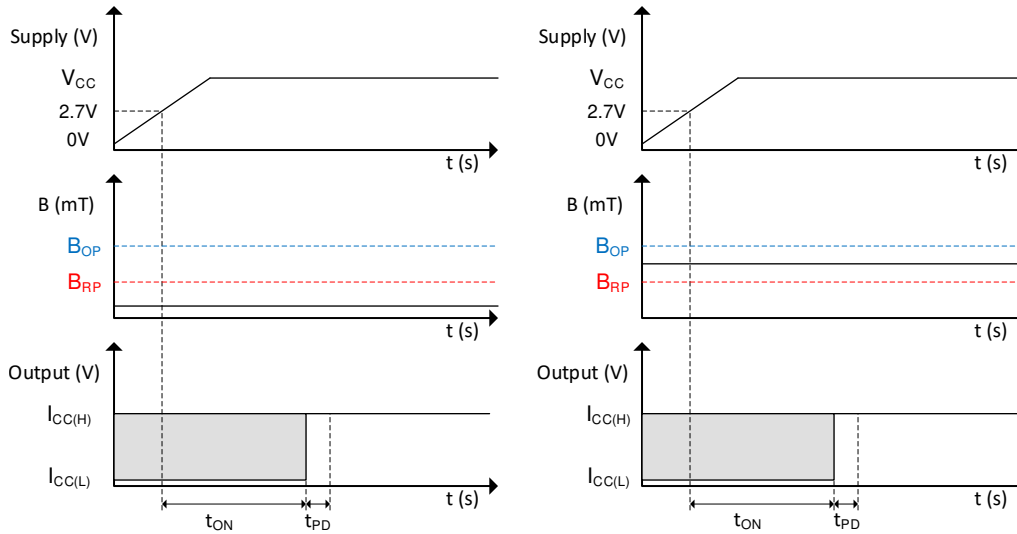

 **8-4. Power-On Time When $B < B_{OP}$**

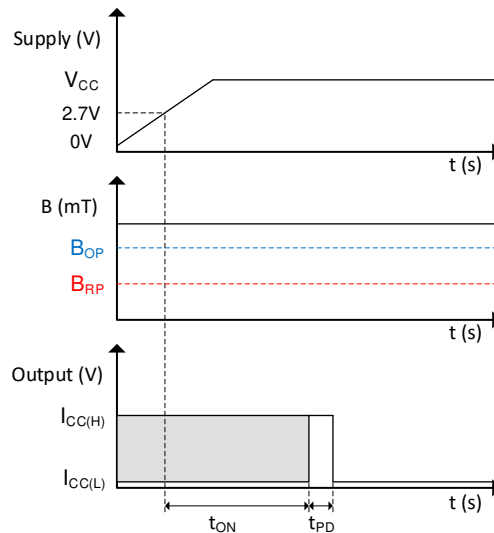

 **8-5. Power-On Time When $B > B_{OP}$**

8.3.5 Hall Element Location

The sensing element inside the device is at the center of the package when viewed from the top. [Figure 8-6](#) shows the position of the sensor inside the package.

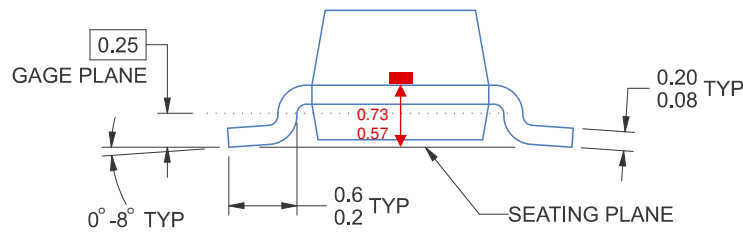
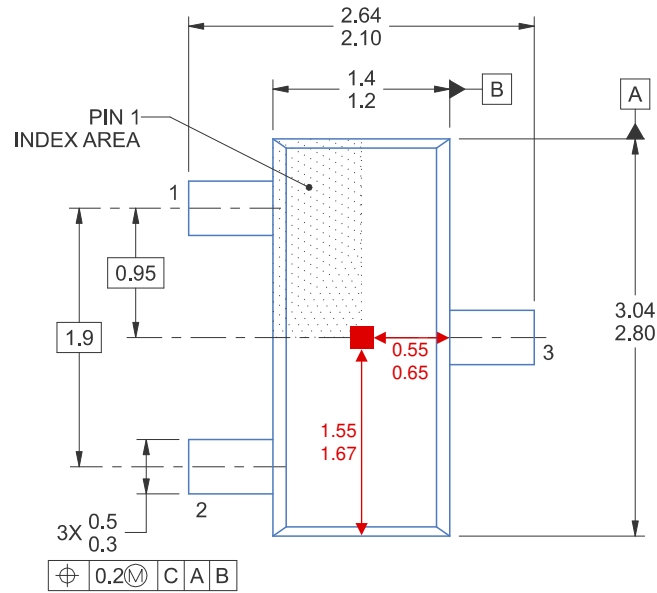

Figure 8-6. Hall Element Location

8.3.6 Propagation Delay

The TMAG5124-Q1 samples the Hall element at a nominal sampling interval of 12.5 μs to detect the presence of a magnetic south pole. Between each sampling interval, the device calculates the average magnetic field applied to the device. If this average value crosses the B_{OP} or B_{RP} threshold, the device changes the corresponding level as defined in [Figure 8-3](#). The hall sensor + magnet system is by nature asynchronous, therefore the propagation delay (t_d) will vary depending on when the magnetic field goes above the B_{OP} value. [Figure 8-7](#) shows that the output delay also depends on when the magnetic field goes above the B_{OP} value.

The first graph in [Figure 8-7](#) shows the typical case. The magnetic field goes above the B_{OP} value at the moment the output is updated. The part will only require one sampling period of 12.5 μs to update the output.

The second graph in [Figure 8-7](#) shows a magnetic field going above the B_{OP} value just before half of the sampling period. This is the best-case scenario where the output is updated in just half of the sampling period.

Finally, the third graph in [Figure 8-7](#) shows the worst-case scenario where the magnetic field goes above the B_{OP} value just after half of the sampling period. At the next output update, the device will still see the magnetic field under the B_{OP} threshold and will require a whole new sampling period to update the output.

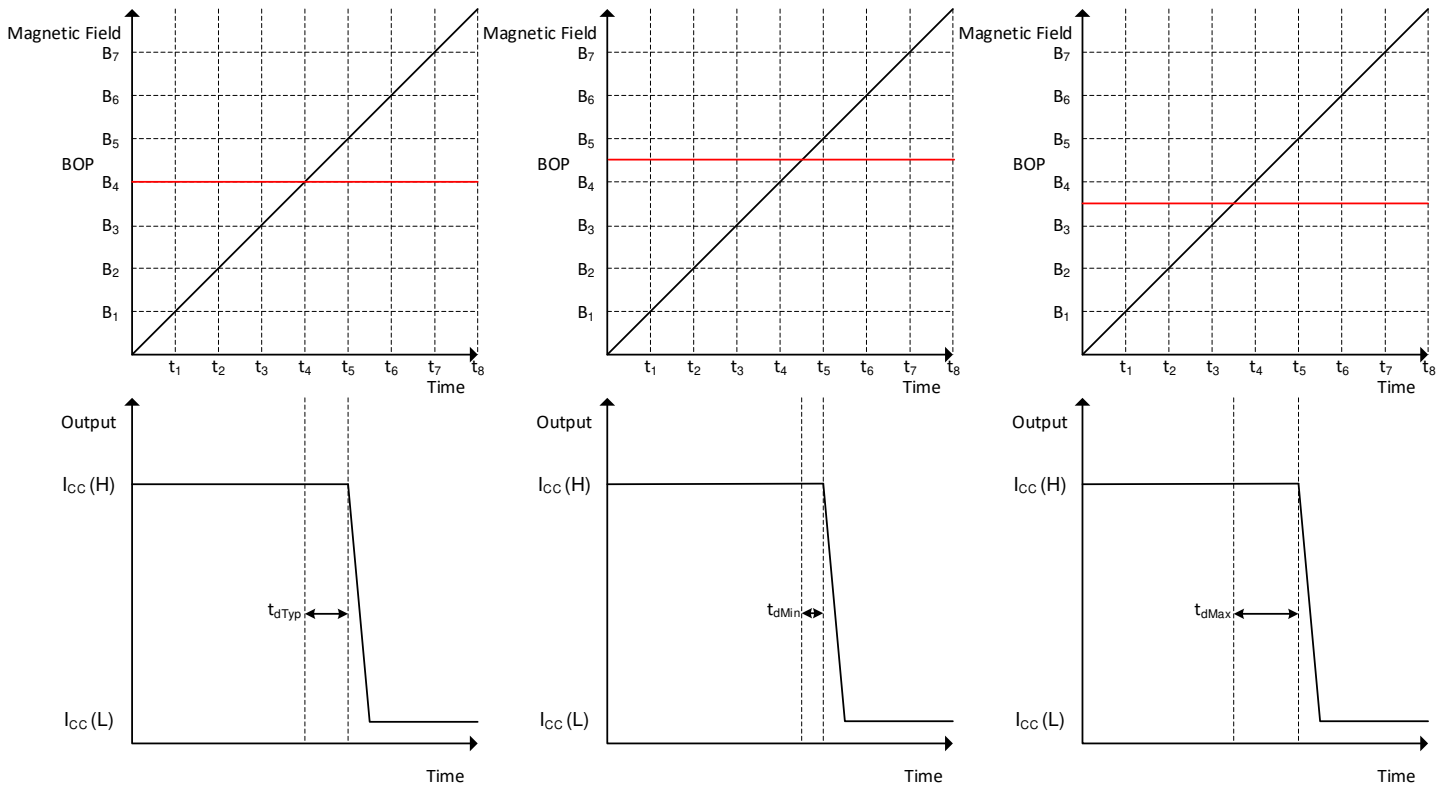

Figure 8-7. Field Sampling Timing

[Figure 8-8](#) shows the TMAG5124-Q1 propagation delay analysis when a magnetic south pole is applied. The Hall element of the TMAG5124-Q1 experiences an increasing magnetic field as a magnetic south pole approaches the device, as well as a decreasing magnetic field as a magnetic south pole moves away. At time t_1 , the magnetic field goes above the B_{OP} threshold. The output will then start to move after the propagation delay (t_d). This time will vary depending on when the sampling period is, as shown in [Figure 8-7](#). At t_2 , the output start pulling to the low current value. At t_3 , the output is completely pulled down to the lower current value. The same process happens on the other way when the magnetic value is going under the B_{RP} threshold.



図 8-8. Propagation Delay

8.3.7 Chopper Stabilization

The Basic Hall-effect sensor consists of four terminals where a current is injected through two opposite terminals and a voltage is measured through the other opposite terminals. The voltage measured is proportional to the current injected and the magnetic field measured. By knowing the current injected, the device can then know the magnetic field strength. The problem is that the voltage generated is small in amplitude while the offset voltage generated is more significant. To create a precise sensor, the offset voltage must be minimized.

Chopper stabilization is one way to significantly minimize this offset. It is achieved by "spinning" the sensor and sequentially applying the bias current and measuring the voltage for each pair of terminals. This means that a measurement is completed once the spinning cycle is completed. The full cycle is completed after four measurements. The output of the sensor is connected to an amplifier and an integrator that will accumulate and filter out a voltage proportional to the magnetic field present. Finally, a comparator will switch the output if the voltage reaches either the BOP or BRP threshold (depending on which state the output voltage was previously in).

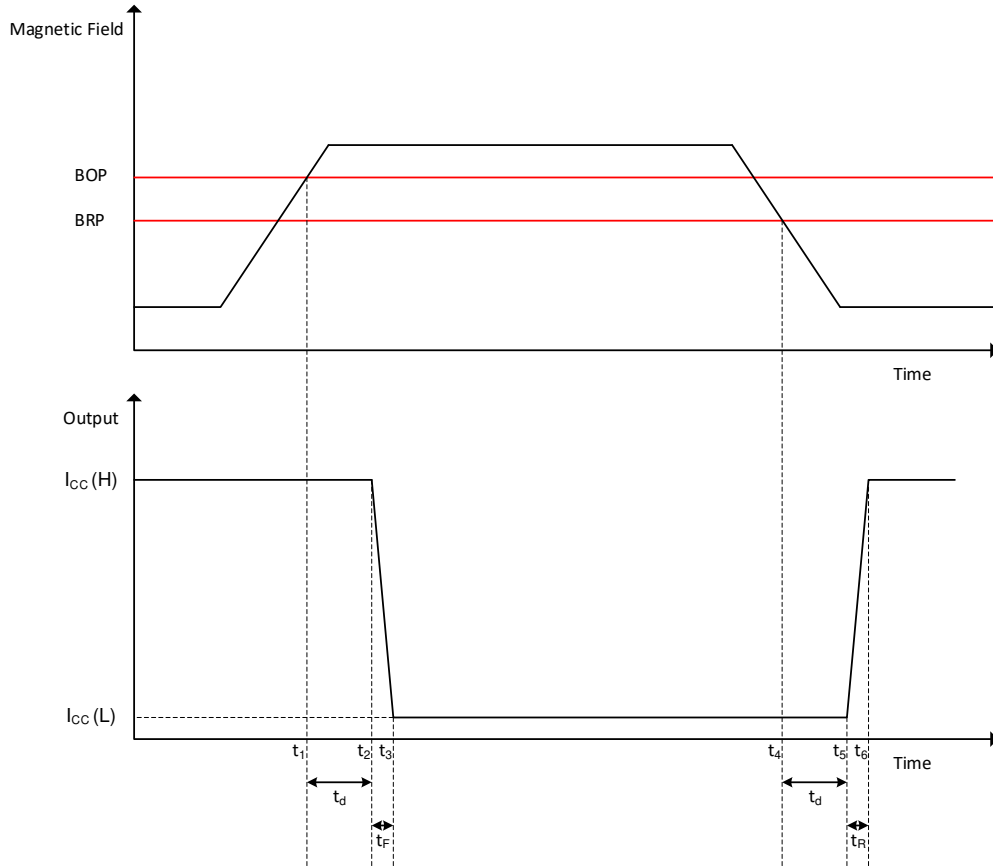
The frequency of each individual measurement is referred to as the Chopping frequency, or f_{CHOP} . The total conversion time is referred to as the Propagation delay time, t_{PD} , and is basically equal to $4/f_{\text{CHOP}}$. Finally, the Signal bandwidth, f_{BW} , represents the maximum value of the magnetic field frequency, and is equal to $(f_{\text{CHOP}}/4)/2$ as defined by the sampling theorem.

8.4 Device Functional Modes

The device operates in only one mode when operated within the *Recommended Operating Conditions*.

9 Application and Implementation

注

以下のアプリケーション情報は、TI の製品仕様に含まれるものではなく、TI ではその正確性または完全性を保証いたしません。個々の目的に対する製品の適合性については、お客様の責任で判断していただくことになります。お客様は自身の設計実装を検証しテストすることで、システムの機能を確認する必要があります。

9.1 Application Information

The TMAG5124 is typically used in magnetic-field sensing applications to detect the proximity of a magnet. The magnet is often attached to a movable component in the system.

The TMAG5124 is a Hall sensor that uses current as the signal of interest. Unlike voltage signals, current signals are much more robust for common problems voltages face in electrical systems, such as voltage source fluctuations and source impedance. A major factor that often leads to the choice of a current signal device is immunity to loop impedance, meaning the signal is capable of being transmitted long distances with ease. To accomplish this, the device requires a termination resistor at the end of the path for interfacing the reconstructed voltage to an input, such as a comparator. Also, diagnostic tools are easily implemented, as disconnects in the loop are easily detected due to a lack of signal.

9.2 Typical Applications

9.2.1 High-Side and Low-Side Typical Application Diagrams



図 9-1. Typical High-Side Sensing Diagram



図 9-2. Typical Low-Side Sensing Diagram

9.2.1.1 Design Requirements

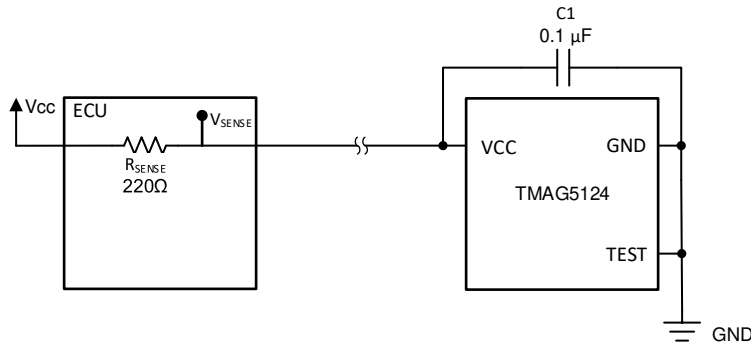
For this design example, use the parameters listed in 表 9-1.

表 9-1. Design Parameters

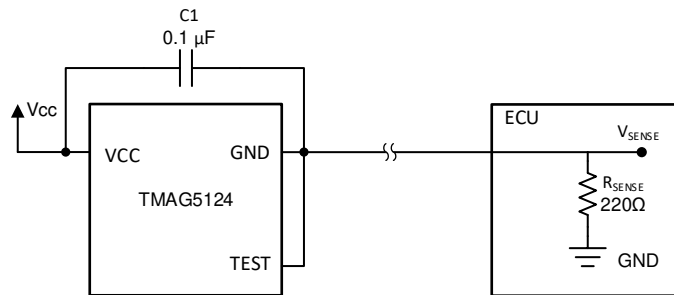
DESIGN PARAMETER	EXAMPLE VALUE
V _{CC}	12 V
TMAG5124 Device	TMAG5124A1
Magnet	1-cm Cube NdFeB (N45)
Minimum magnet distance	3 cm
Magnetic flux density at closest distance	5.0 mT
Magnetic flux density when magnet moves away	Close to 0 mT

9.2.1.2 Detailed Design Procedure

When designing a digital-switch magnetic sensing system, three variables should always be considered: the magnet, sensing distance, and threshold of the sensor.

The TMAG5124 device has a detection threshold specified by parameter B_{OP}, which is the amount of magnetic flux required to pass through the Hall sensor mounted inside the TMAG5124. To reliably activate the sensor, the magnet must apply a flux greater than the maximum specified B_{OP}. In such a system, the sensor typically detects the magnet before it has moved to the closest position, but designing to the maximum parameter ensures robust turn-on for all possible values of B_{OP}. When the magnet moves away from the sensor, it must apply less than the minimum specified B_{RP} to reliably release the sensor.

Magnets are made from various ferromagnetic materials that have tradeoffs in cost, drift with temperature, absolute maximum temperature ratings, remanence or residual induction (B_r), and coercivity (H_c). The B_r and the dimensions of a magnet determine the magnetic flux density (B) it produces in 3-dimensional space. For simple magnet shapes, such as rectangular blocks and cylinders, there are simple equations that solve B at a given distance centered with the magnet.



図 9-3. Rectangular Block and Cylinder Magnets

Use 式 1 for the rectangular block shown in 図 9-3:

$$\vec{B} = \frac{B_r}{\pi} \left(\arctan \left(\frac{WL}{2D\sqrt{4D^2 + W^2 + L^2}} \right) - \arctan \left(\frac{WL}{2(D+T)\sqrt{4(D+T)^2 + W^2 + L^2}} \right) \right) \quad (1)$$

Use 式 2 for the cylinder shown in 図 9-3:

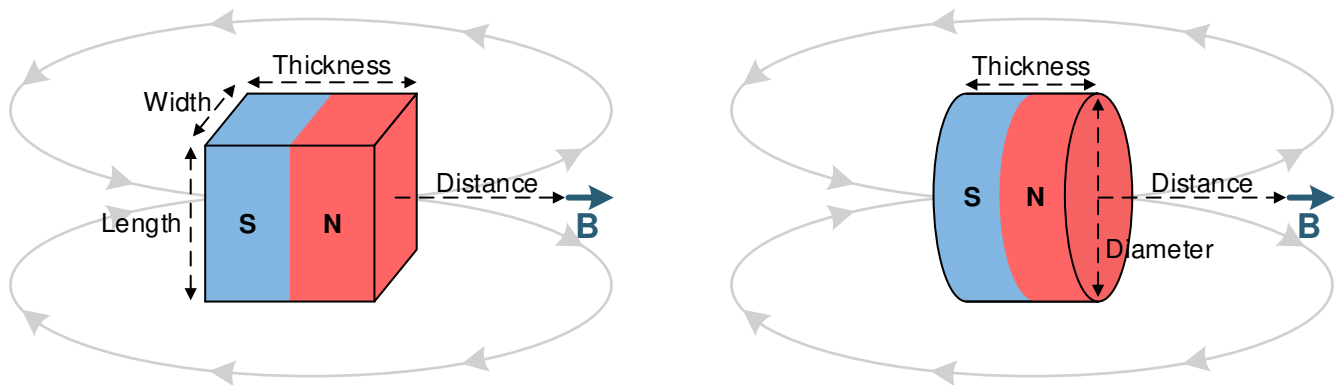
$$\vec{B} = \frac{B_r}{2} \left(\frac{D+T}{\sqrt{(0.5C)^2 + (D+T)^2}} - \frac{D}{\sqrt{(0.5C)^2 + D^2}} \right) \quad (2)$$

where

- W is width.
- L is length.
- T is thickness (the direction of magnetization).
- D is distance.
- C is diameter.

The *Hall Effect Switch Magnetic Field Calculator* is an online tool that uses these formulas available here: <http://www.ti.com/product/tmag5124>.

All magnetic materials generally have a lower B_r at higher temperatures. Systems should have margin to account for this, as well as for mechanical tolerances.

For the TMAG5124A1, the maximum B_{OP} is 5 mT. When choosing a 1-cm cube NdFeB N45 magnet, 式 1 shows that this point occurs at 3 cm. This means that the magnet will activate the sensor if the design places the magnet within 3 cm from the sensor during a "turn-on" event. If the magnet is pulled away from the device, the magnetic field will go below the minimum B_{RP} point and the device will return to its initial state.

9.2.1.3 Application Curve



図 9-4. Magnetic Profile of a 1-cm Cube NdFeB Magnet

10 Power Supply Recommendations

The TMAG5124-Q1 is powered from a DC power supply of 2.7 V to 38 V. A decoupling capacitor close to the device must be used to provide local energy with minimal inductance. TI recommends using a ceramic capacitor with a value of at least 0.01 μF .

10.1 Power Derating

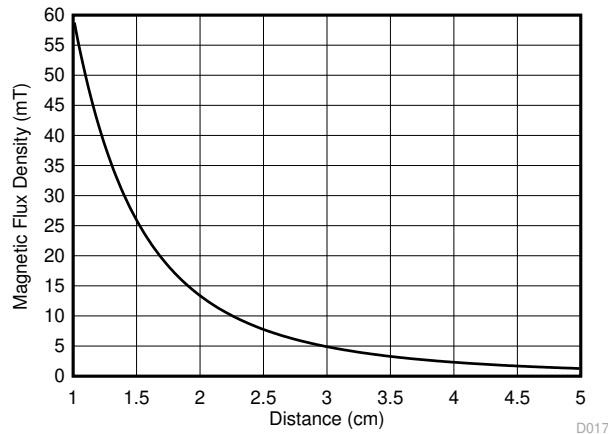
The device is specified from -40°C to 150°C for a voltage rating of 2.7 V to 38 V. The part drains at its maximum current of 17 mA, therefore the maximum voltage that can be applied to the device will depend on what maximum ambient temperature is acceptable for the application. The curve in [Figure 10-1](#) shows the maximum acceptable power supply voltage versus the maximum acceptable ambient temperature.

Use [Equation 3](#), [Equation 4](#), and [Equation 5](#) to populate the data shown in [Figure 10-1](#):

$$T_J = T_A + \Delta T \quad (3)$$

where

- T_J is the junction temperature.
- T_A is the ambient temperature.
- ΔT is the difference between the junction temperature and the ambient temperature.

$$\Delta T = P_D \times R_{\theta JA} \quad (4)$$

where

- P_D is the power dissipated by the part.
- $R_{\theta JA}$ is the junction to ambient thermal resistance.

$$P_D = V_{CC} \times I_{CC} \quad (5)$$

where

- V_{CC} is the voltage supply of the device.
- I_{CC} is the current consumption of the device.

Combining these equations gives [Equation 6](#), which can be used to determine the maximum voltage the part can handle in regards of the ambient temperature.

$$V_{CC \max} = \frac{T_{J \max} - T_A}{I_{CC \max} \times R_{\theta JA}} \quad (6)$$

For example, if an application must work under an ambient temperature maximum of 100°C , and the $T_{J \max}$, $R_{\theta JA}$ and $I_{CC \max}$ are the same values defined in the data sheet, then the maximum voltage allowed for this application is calculated in [Equation 7](#):

$$V_{CC \max} = \frac{170^{\circ}\text{C} - 120^{\circ}\text{C}}{17 \text{ mA} \times 198.5^{\circ}\text{C} / \text{W}} = 14.82 \text{ V} \quad (7)$$



図 10-1. Power Derating Curve

11 Layout

11.1 Layout Guidelines

The bypass capacitor should be placed near the TMAG5124-Q1 to reduce noise. The TEST pin must be connected directly to the GND pin. It is good practice to connect the pins under the package to reduce the connection length.

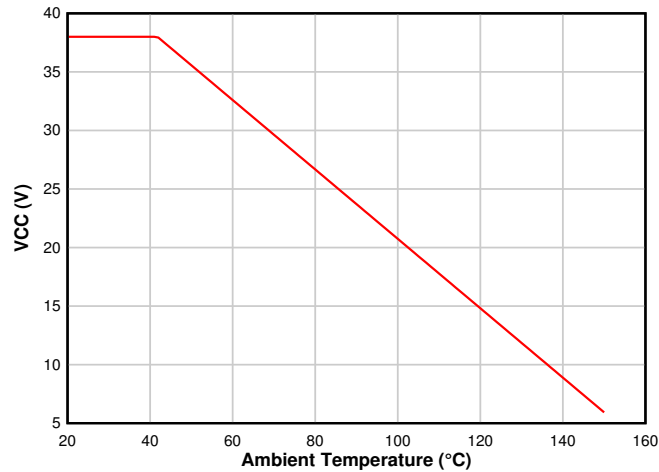
Generally, using PCB copper planes underneath the TMAG5124-Q1 device has no effect on magnetic flux and does not interfere with device performance. This is because copper is not a ferromagnetic material. However, if nearby system components contain iron or nickel, they may redirect magnetic flux in unpredictable ways.

11.2 Layout Example



図 11-1. TMAG5124-Q1 Layout Example

12 Device and Documentation Support

12.1 Documentation Support

12.2 ドキュメントの更新通知を受け取る方法

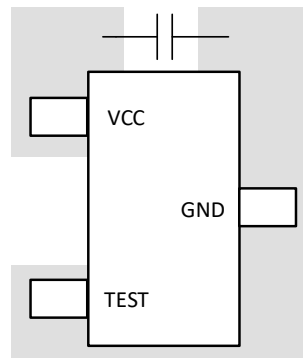
ドキュメントの更新についての通知を受け取るには、[ti.com](https://www.ti.com) のデバイス製品フォルダを開いてください。「更新の通知を受け取る」をクリックして登録すると、変更されたすべての製品情報に関するダイジェストを毎週受け取れます。変更の詳細については、修正されたドキュメントに含まれている改訂履歴をご覧ください。

12.3 サポート・リソース

[TI E2E™ サポート・フォーラム](#)は、エンジニアが検証済みの回答と設計に関するヒントをエキスパートから迅速かつ直接得ることができる場所です。既存の回答を検索したり、独自の質問をしたりすることで、設計に必要な支援を迅速に得ることができます。

リンクされているコンテンツは、該当する貢献者により、現状のまま提供されるものです。これらは TI の仕様を構成するものではなく、必ずしも TI の見解を反映したものではありません。TI の[使用条件](#)を参照してください。

12.4 Trademarks

TI E2E™ is a trademark of Texas Instruments.

すべての商標は、それぞれの所有者に帰属します。

12.5 静電気放電に関する注意事項



この IC は、ESD によって破損する可能性があります。テキサス・インスツルメンツは、IC を取り扱う際には常に適切な注意を払うことを推奨します。正しい取り扱いおよび設置手順に従わない場合、デバイスを破損するおそれがあります。

ESD による破損は、わずかな性能低下からデバイスの完全な故障まで多岐にわたります。精密な IC の場合、パラメータがわずかに変化するだけで公表されている仕様から外れる可能性があるため、破損が発生しやすくなっています。

12.6 用語集

[テキサス・インスツルメンツ用語集](#) この用語集には、用語や略語の一覧および定義が記載されています。

13 Mechanical, Packaging, and Orderable Information

The following pages include mechanical, packaging, and orderable information. This information is the most current data available for the designated devices. This data is subject to change without notice and revision of this document. For browser-based versions of this data sheet, refer to the left-hand navigation.

PACKAGING INFORMATION

Orderable part number	Status (1)	Material type (2)	Package Pins	Package qty Carrier	RoHS (3)	Lead finish/ Ball material (4)	MSL rating/ Peak reflow (5)	Op temp (°C)	Part marking (6)
TMAG5124A1CEDBZRQ1	Active	Production	SOT-23 (DBZ) 3	3000 LARGE T&R	Yes	SN	Level-3-260C-168 HR	-40 to 150	4A1Z
TMAG5124A1CEDBZRQ1.A	Active	Production	SOT-23 (DBZ) 3	3000 LARGE T&R	Yes	SN	Level-3-260C-168 HR	-40 to 150	4A1Z
TMAG5124B1CEDBZRQ1	Active	Production	SOT-23 (DBZ) 3	3000 LARGE T&R	Yes	SN	Level-3-260C-168 HR	-40 to 150	4B1Z
TMAG5124B1CEDBZRQ1.A	Active	Production	SOT-23 (DBZ) 3	3000 LARGE T&R	Yes	SN	Level-3-260C-168 HR	-40 to 150	4B1Z
TMAG5124C1CEDBZRQ1	Active	Production	SOT-23 (DBZ) 3	3000 LARGE T&R	Yes	SN	Level-3-260C-168 HR	-40 to 150	4C1Z
TMAG5124C1CEDBZRQ1.A	Active	Production	SOT-23 (DBZ) 3	3000 LARGE T&R	Yes	SN	Level-3-260C-168 HR	-40 to 150	4C1Z
TMAG5124D1CEDBZRQ1	Active	Production	SOT-23 (DBZ) 3	3000 LARGE T&R	Yes	SN	Level-3-260C-168 HR	-40 to 150	4D1Z
TMAG5124D1CEDBZRQ1.A	Active	Production	SOT-23 (DBZ) 3	3000 LARGE T&R	Yes	SN	Level-3-260C-168 HR	-40 to 150	4D1Z
TMAG5124E1CEDBZRQ1	Active	Production	SOT-23 (DBZ) 3	3000 LARGE T&R	Yes	SN	Level-3-260C-168 HR	-40 to 150	4E1Z
TMAG5124E1CEDBZRQ1.A	Active	Production	SOT-23 (DBZ) 3	3000 LARGE T&R	Yes	SN	Level-3-260C-168 HR	-40 to 150	4E1Z
TMAG5124F1CEDBZRQ1	Active	Production	SOT-23 (DBZ) 3	3000 LARGE T&R	Yes	SN	Level-3-260C-168 HR	-40 to 150	4F1Z
TMAG5124F1CEDBZRQ1.A	Active	Production	SOT-23 (DBZ) 3	3000 LARGE T&R	Yes	SN	Level-3-260C-168 HR	-40 to 150	4F1Z
TMAG5124G1CEDBZRQ1	Active	Production	SOT-23 (DBZ) 3	3000 LARGE T&R	Yes	SN	Level-3-260C-168 HR	-40 to 150	4G1Z
TMAG5124G1CEDBZRQ1.A	Active	Production	SOT-23 (DBZ) 3	3000 LARGE T&R	Yes	SN	Level-3-260C-168 HR	-40 to 150	4G1Z
TMAG5124H1CEDBZRQ1	Active	Production	SOT-23 (DBZ) 3	3000 LARGE T&R	Yes	SN	Level-3-260C-168 HR	-40 to 150	4H1Z
TMAG5124H1CEDBZRQ1.A	Active	Production	SOT-23 (DBZ) 3	3000 LARGE T&R	Yes	SN	Level-3-260C-168 HR	-40 to 150	4H1Z

(1) **Status:** For more details on status, see our [product life cycle](#).

(2) **Material type:** When designated, preproduction parts are prototypes/experimental devices, and are not yet approved or released for full production. Testing and final process, including without limitation quality assurance, reliability performance testing, and/or process qualification, may not yet be complete, and this item is subject to further changes or possible discontinuation. If available for ordering, purchases will be subject to an additional waiver at checkout, and are intended for early internal evaluation purposes only. These items are sold without warranties of any kind.

(3) **RoHS values:** Yes, No, RoHS Exempt. See the [TI RoHS Statement](#) for additional information and value definition.

(4) **Lead finish/Ball material:** Parts may have multiple material finish options. Finish options are separated by a vertical ruled line. Lead finish/Ball material values may wrap to two lines if the finish value exceeds the maximum column width.

(5) **MSL rating/Peak reflow:** The moisture sensitivity level ratings and peak solder (reflow) temperatures. In the event that a part has multiple moisture sensitivity ratings, only the lowest level per JEDEC standards is shown. Refer to the shipping label for the actual reflow temperature that will be used to mount the part to the printed circuit board.

(6) **Part marking:** There may be an additional marking, which relates to the logo, the lot trace code information, or the environmental category of the part.

Multiple part markings will be inside parentheses. Only one part marking contained in parentheses and separated by a "-" will appear on a part. If a line is indented then it is a continuation of the previous line and the two combined represent the entire part marking for that device.

Important Information and Disclaimer:The information provided on this page represents TI's knowledge and belief as of the date that it is provided. TI bases its knowledge and belief on information provided by third parties, and makes no representation or warranty as to the accuracy of such information. Efforts are underway to better integrate information from third parties. TI has taken and continues to take reasonable steps to provide representative and accurate information but may not have conducted destructive testing or chemical analysis on incoming materials and chemicals. TI and TI suppliers consider certain information to be proprietary, and thus CAS numbers and other limited information may not be available for release.

In no event shall TI's liability arising out of such information exceed the total purchase price of the TI part(s) at issue in this document sold by TI to Customer on an annual basis.

OTHER QUALIFIED VERSIONS OF TMAG5124-Q1 :

- Catalog : [TMAG5124](#)

NOTE: Qualified Version Definitions:

- Catalog - TI's standard catalog product

TAPE AND REEL INFORMATION

QUADRANT ASSIGNMENTS FOR PIN 1 ORIENTATION IN TAPE

*All dimensions are nominal

Device	Package Type	Package Drawing	Pins	SPQ	Reel Diameter (mm)	Reel Width W1 (mm)	A0 (mm)	B0 (mm)	K0 (mm)	P1 (mm)	W (mm)	Pin1 Quadrant
TMAG5124A1CEDBZRQ1	SOT-23	DBZ	3	3000	178.0	9.0	3.15	2.77	1.22	4.0	8.0	Q3
TMAG5124B1CEDBZRQ1	SOT-23	DBZ	3	3000	178.0	9.0	3.15	2.77	1.22	4.0	8.0	Q3
TMAG5124C1CEDBZRQ1	SOT-23	DBZ	3	3000	178.0	9.0	3.15	2.77	1.22	4.0	8.0	Q3
TMAG5124D1CEDBZRQ1	SOT-23	DBZ	3	3000	178.0	9.0	3.15	2.77	1.22	4.0	8.0	Q3
TMAG5124E1CEDBZRQ1	SOT-23	DBZ	3	3000	178.0	9.0	3.15	2.77	1.22	4.0	8.0	Q3
TMAG5124F1CEDBZRQ1	SOT-23	DBZ	3	3000	178.0	9.0	3.15	2.77	1.22	4.0	8.0	Q3
TMAG5124G1CEDBZRQ1	SOT-23	DBZ	3	3000	178.0	9.0	3.15	2.77	1.22	4.0	8.0	Q3
TMAG5124H1CEDBZRQ1	SOT-23	DBZ	3	3000	178.0	9.0	3.15	2.77	1.22	4.0	8.0	Q3

TAPE AND REEL BOX DIMENSIONS

*All dimensions are nominal

Device	Package Type	Package Drawing	Pins	SPQ	Length (mm)	Width (mm)	Height (mm)
TMAG5124A1CEDBZRQ1	SOT-23	DBZ	3	3000	180.0	180.0	18.0
TMAG5124B1CEDBZRQ1	SOT-23	DBZ	3	3000	180.0	180.0	18.0
TMAG5124C1CEDBZRQ1	SOT-23	DBZ	3	3000	180.0	180.0	18.0
TMAG5124D1CEDBZRQ1	SOT-23	DBZ	3	3000	180.0	180.0	18.0
TMAG5124E1CEDBZRQ1	SOT-23	DBZ	3	3000	180.0	180.0	18.0
TMAG5124F1CEDBZRQ1	SOT-23	DBZ	3	3000	180.0	180.0	18.0
TMAG5124G1CEDBZRQ1	SOT-23	DBZ	3	3000	180.0	180.0	18.0
TMAG5124H1CEDBZRQ1	SOT-23	DBZ	3	3000	180.0	180.0	18.0

DBZ0003A



PACKAGE OUTLINE

SOT-23 - 1.12 mm max height

SMALL OUTLINE TRANSISTOR

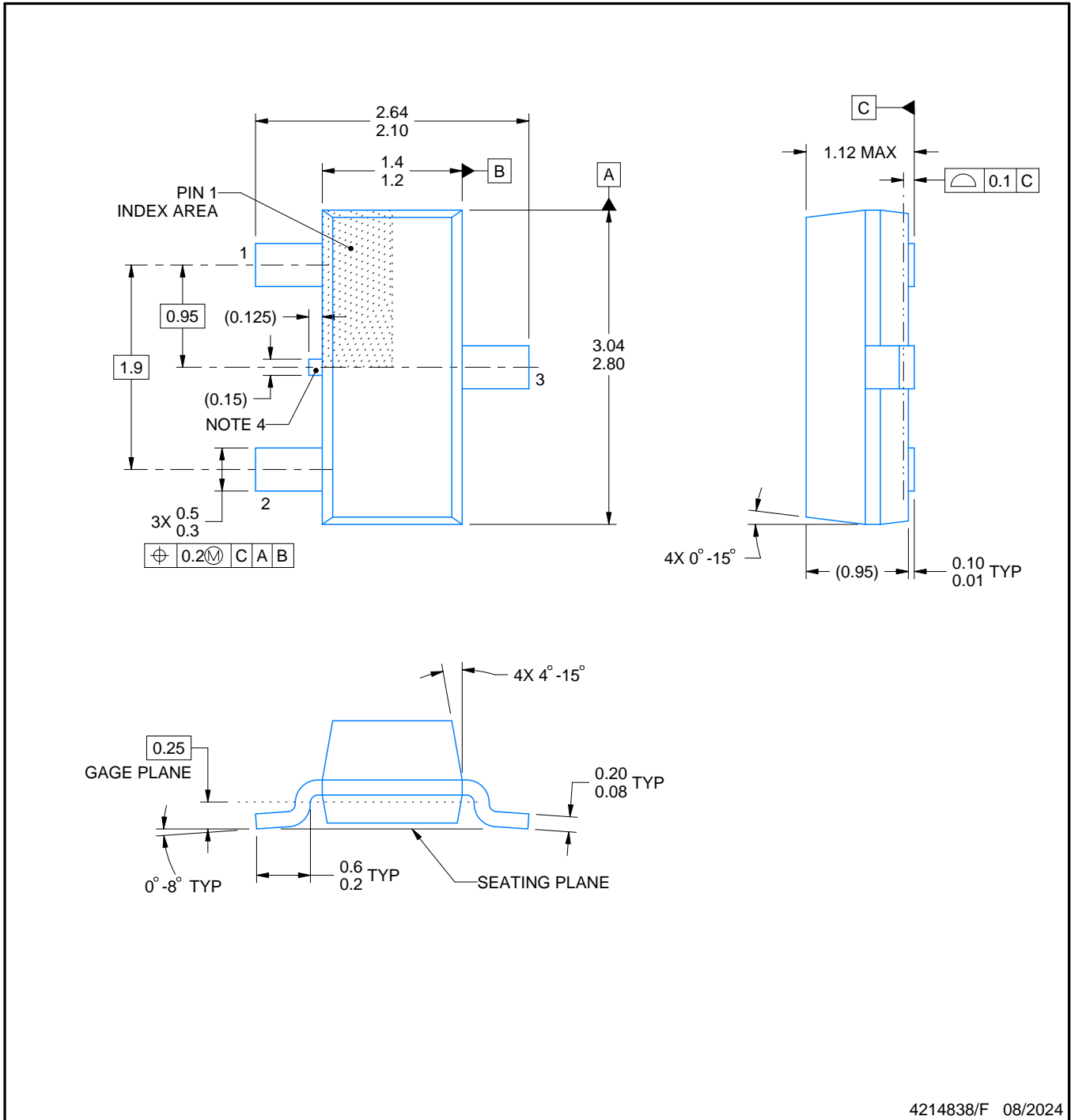

4214838/F 08/2024

NOTES:

1. All linear dimensions are in millimeters. Any dimensions in parenthesis are for reference only. Dimensioning and tolerancing per ASME Y14.5M.
2. This drawing is subject to change without notice.
3. Reference JEDEC registration TO-236, except minimum foot length.
4. Support pin may differ or may not be present.
5. Body dimensions do not include mold flash, protrusions, or gate burrs. Mold flash, protrusions, or gate burrs shall not exceed 0.25mm per side

EXAMPLE BOARD LAYOUT

DBZ0003A

SOT-23 - 1.12 mm max height

SMALL OUTLINE TRANSISTOR

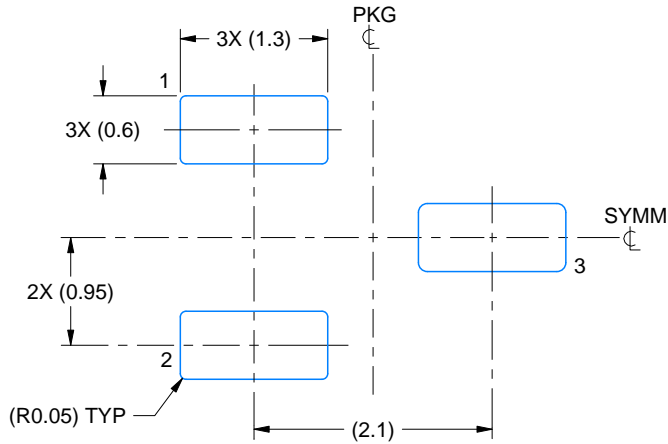

LAND PATTERN EXAMPLE
SCALE:15X

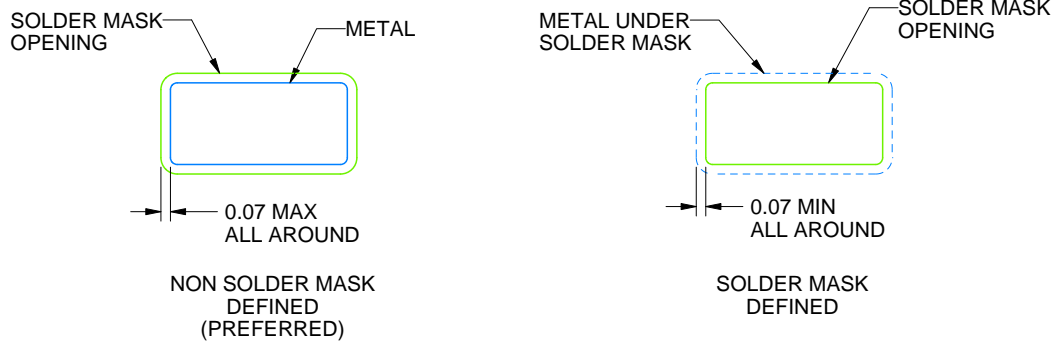

SOLDER MASK DETAILS

4214838/F 08/2024

NOTES: (continued)

5. Publication IPC-7351 may have alternate designs.
6. Solder mask tolerances between and around signal pads can vary based on board fabrication site.

EXAMPLE STENCIL DESIGN

DBZ0003A

SOT-23 - 1.12 mm max height

SMALL OUTLINE TRANSISTOR

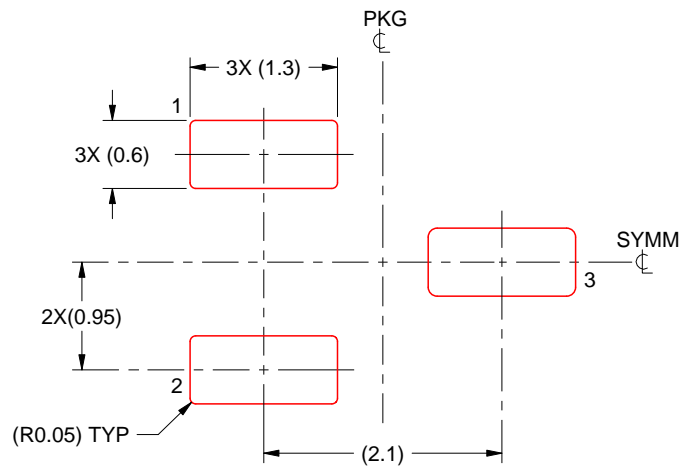

SOLDER PASTE EXAMPLE
BASED ON 0.125 THICK STENCIL
SCALE:15X

4214838/F 08/2024

NOTES: (continued)

7. Laser cutting apertures with trapezoidal walls and rounded corners may offer better paste release. IPC-7525 may have alternate design recommendations.
8. Board assembly site may have different recommendations for stencil design.

重要なお知らせと免責事項

TI は、技術データと信頼性データ（データシートを含みます）、設計リソース（リファレンス デザインを含みます）、アプリケーションや設計に関する各種アドバイス、Web ツール、安全性情報、その他のリソースを、欠陥が存在する可能性のある「現状のまま」提供しており、商品性および特定目的に対する適合性の黙示保証、第三者の知的財産権の非侵害保証を含むいかなる保証も、明示的または黙示的にかかわらず拒否します。

これらのリソースは、TI 製品を使用する設計の経験を積んだ開発者への提供を意図したものです。(1) お客様のアプリケーションに適した TI 製品の選定、(2) お客様のアプリケーションの設計、検証、試験、(3) お客様のアプリケーションに該当する各種規格や、その他のあらゆる安全性、セキュリティ、規制、または他の要件への確実な適合に関する責任を、お客様のみが単独で負うものとし、

上記の各種リソースは、予告なく変更される可能性があります。これらのリソースは、リソースで説明されている TI 製品を使用するアプリケーションの開発の目的でのみ、TI はその使用をお客様に許諾します。これらのリソースに関して、他の目的で複製することや掲載することは禁止されています。TI や第三者の知的財産権のライセンスが付与されている訳ではありません。お客様は、これらのリソースを自身で使用した結果発生するあらゆる申し立て、損害、費用、損失、責任について、TI およびその代理人を完全に補償するものとし、TI は一切の責任を拒否します。

TI の製品は、[TI の販売条件](#)、[TI の総合的な品質ガイドライン](#)、[ti.com](#) または TI 製品などに関連して提供される他の適用条件に従い提供されます。TI がこれらのリソースを提供することは、適用される TI の保証または他の保証の放棄の拡大や変更を意味するものではありません。TI がカスタム、またはカスタマー仕様として明示的に指定していない限り、TI の製品は標準的なカタログに掲載される汎用機器です。

お客様がいかなる追加条項または代替条項を提案する場合も、TI はそれらに異議を唱え、拒否します。

Copyright © 2025, Texas Instruments Incorporated

最終更新日：2025 年 10 月