

TPPM0302
**400-mA LOW-DROPOUT REGULATOR
 WITH AUXILIARY POWER MANAGEMENT AND POK**
 SLVS316 – NOVEMBER 2000

- Automatic Input Voltage Source Selection
- Glitch-Free Regulated Output
- 5-V Input Voltage Source Detector With Hysteresis
- 400-mA Load Current Capability With 5-V or 3.3-V Input Source
- Power OK Feature Based on Voltage Supervisor of 3.3VOUT
- Low $r_{DS(on)}$ Auxiliary Switch
- Thermally Enhanced PowerPAD™ Packaging Concept for Efficient Heat Management

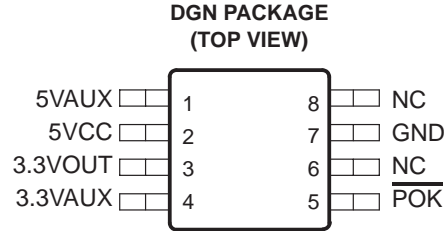

NC – No connect

description

The TPPM0302 is a low-dropout regulator with auxiliary power management that provides a constant 3.3-V supply at the output capable of driving a 400-mA load.

The TPPM0302 provides a regulated power output for systems that have multiple input sources and require a constant voltage source with a low-dropout voltage. This is a single output, multiple input, intelligent power source selection device with a low-dropout regulator for either 5VCC or 5VAUX inputs, and a low-resistance bypass switch for the 3.3VAUX input.

Transitions may occur from one input supply to another without generating a glitch, outside of the specification range, on the 3.3-V output. The device has an incorporated reverse blocking scheme to prevent excess leakage from the input terminals in the event that the output voltage is greater than the input voltage. The output voltage is continually monitored for constant output, and any deviation from the internal set limit (≈ 2.8 V) is reported by a low signal on the \overline{POK} output.

The input voltage is prioritized in the following order: 5VCC, 5VAUX, and 3.3VAUX.



Please be aware that an important notice concerning availability, standard warranty, and use in critical applications of Texas Instruments semiconductor products and disclaimers thereto appears at the end of this data sheet.

PowerPAD is a trademark of Texas Instruments.

PRODUCTION DATA information is current as of publication date. Products conform to specifications per the terms of Texas Instruments standard warranty. Production processing does not necessarily include testing of all parameters.



POST OFFICE BOX 655303 • DALLAS, TEXAS 75265

Copyright © 2000, Texas Instruments Incorporated

TPPM0302
400-mA LOW-DROPOUT REGULATOR
WITH AUXILIARY POWER MANAGEMENT AND POK

SLVS316 – NOVEMBER 2000

functional block diagram

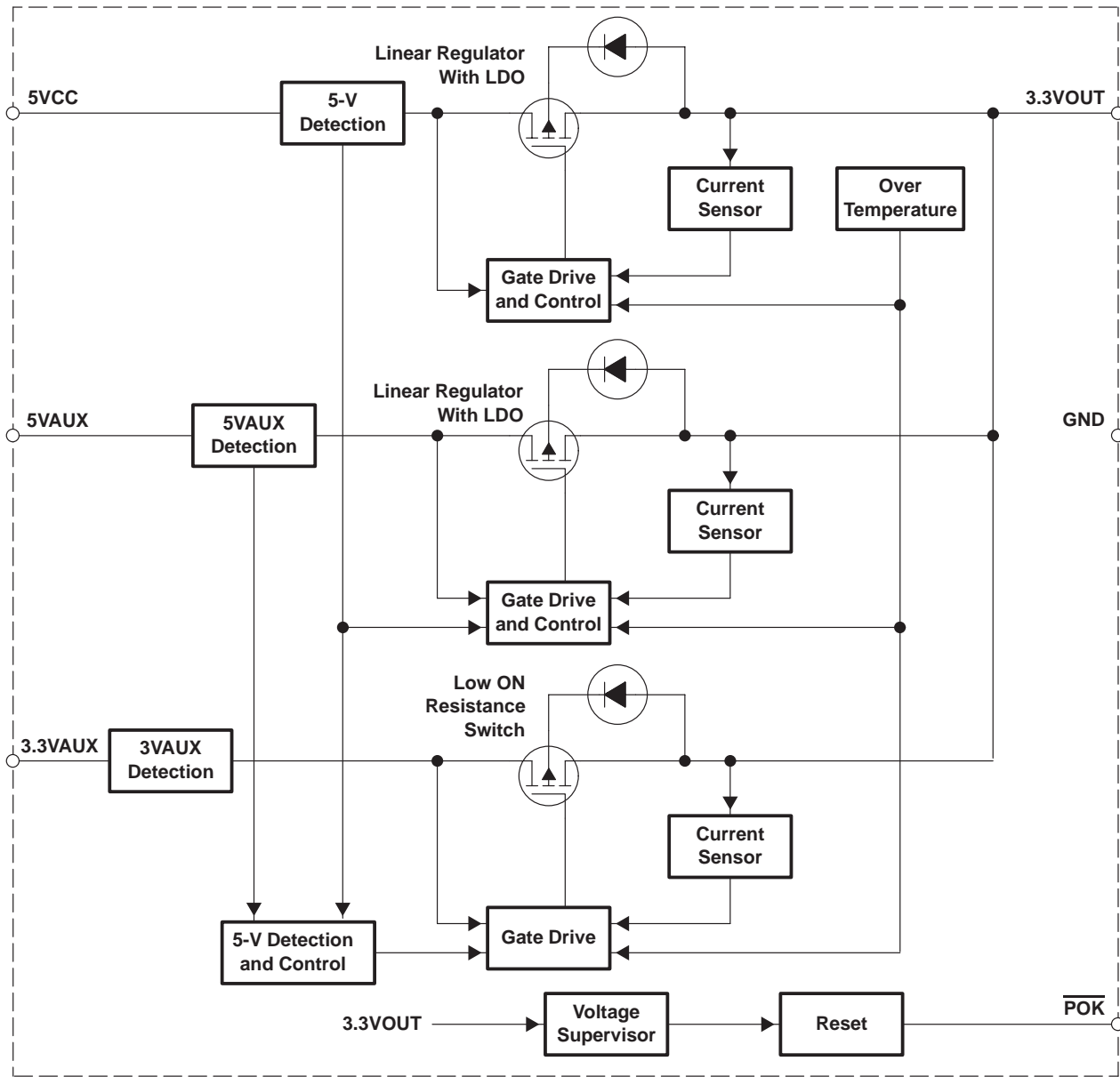

Terminal Functions

| TERMINAL NAME | NO. | I/O | DESCRIPTION |
|---------------|------|-----|---|
| 3.3VAUX | 4 | I | 3.3-V auxiliary input |
| 3.3VOUT | 3 | O | 3.3-V output with a typical capacitance load of 4.7 μ F |
| 5VAUX | 1 | I | 5-V auxiliary input |
| 5VCC | 2 | I | 5-V main input |
| GND | 7 | I | Ground |
| NC | 6, 8 | I | No internal connection |
| POK | 5 | O | Power OK |



Table 1. Input Selection

| INPUT VOLTAGE STATUS (V) | | | INPUT SELECTED | OUTPUT (V) | OUTPUT (I) |
|--------------------------|-------|---------|--------------------|------------|---------------------|
| 5VCC | 5VAUX | 3.3VAUX | 5VCC/5VAUX/3.3VAUX | 3.3VOUT | I _L (mA) |
| 0 | 0 | 0 | None | 0 | 0 |
| 0 | 0 | 3.3 | 3.3VAUX | 3.3 | 375 |
| 0 | 5 | 0 | 5VAUX | 3.3 | 400 |
| 0 | 5 | 3.3 | 5VAUX | 3.3 | 400 |
| 5 | 0 | 0 | 5VCC | 3.3 | 400 |
| 5 | 0 | 3.3 | 5VCC | 3.3 | 400 |
| 5 | 5 | 0 | 5VCC | 3.3 | 400 |
| 5 | 5 | 3.3 | 5VCC | 3.3 | 400 |

absolute maximum ratings over operating free-air temperature (unless otherwise noted)†

| | |
|---|----------------|
| Supply voltage, 5-V main input, V _(5VCC) (see Notes 1 and 2) | 7 V |
| Auxiliary voltage, 5-V input, V _(5VAUX) (see Notes 1 and 2) | 7 V |
| Auxiliary voltage, 3.3-V input, V _(3.3VAUX) (see Notes 1 and 2) | 5 V |
| 3.3-V output current limit, I _(LIMIT) | 1.5 A |
| Continuous power dissipation, P _D (see Note 3) | 1.36 W |
| Electrostatic discharge susceptibility, human body model, V _(HBMESD) | 2 kV |
| Operating ambient temperature range, T _A | 0°C to 70°C |
| Storage temperature range, T _{stg} | –55°C to 150°C |
| Operating junction temperature range, T _J | –5°C to 120°C |
| Lead temperature (soldering, 10 second), T _(LEAD) | 260°C |

† Stresses beyond those listed under “absolute maximum ratings” may cause permanent damage to the device. These are stress ratings only, and functional operation of the device at these or any other conditions beyond those indicated under “recommended operating conditions” is not implied. Exposure to absolute-maximum-rated conditions for extended periods may affect device reliability.

- NOTES: 1. All voltage values are with respect to GND.
 2. Absolute negative voltage on these terminal should not be below –0.5 V.
 3. Refer to the Thermal Information Section.

recommended operating conditions

| | MIN | TYP | MAX | UNIT |
|---|------|-----|------|------|
| 5-V main input, V _(5VCC) | 4.5 | | 5.5 | V |
| 5-V auxiliary input, V _(5VAUX) | 4.5 | | 5.5 | V |
| 3.3-V auxiliary input, V _(3.3VAUX) | 3 | | 3.6 | V |
| Load capacitance, C _L | 4.23 | 4.7 | 5.17 | μF |
| Load current, I _L | 0 | | 400 | mA |
| Ambient temperature, T _A | 0 | | 70 | °C |

TPPM0302
400-mA LOW-DROPOUT REGULATOR
WITH AUXILIARY POWER MANAGEMENT AND POK

SLVS316 – NOVEMBER 2000

electrical characteristics over recommended operating free-air temperature range, $T_A = 0^\circ\text{C}$ to 70°C , $C_L = 4.7\ \mu\text{F}$ (unless otherwise noted)

| PARAMETER | TEST CONDITIONS | MIN | TYP | MAX | UNIT |
|--|--|-------|-----|-------|------------------|
| $V_{(5VCC)}/V_{(5VAUX)}$ 5-V inputs | | 4.5 | 5 | 5.5 | V |
| $I_{(Q)}$ Quiescent supply current | From 5VCC or 5VAUX terminals, $I_L = 0$ mA to 400 mA | | 2.5 | 5 | mA |
| | From 3.3VAUX terminal, $I_L = 0$ A | | 250 | 500 | μA |
| I_L Output load current | | 0.4 | | | A |
| $I_{(LIMIT)}$ Output current limit | $3.3V_{OUT} = 0$ V | | 1 | 1.5 | A |
| $T_{(TSD)}^\dagger$ Thermal shutdown | 3.3V _{OUT} output shorted to 0 V | | 150 | 180 | $^\circ\text{C}$ |
| T_{hys}^\dagger Thermal hysteresis | | | 15 | | |
| $V_{(3.3V_{OUT})}$ 3.3-V output | $I_L = 400$ mA | 3.135 | 3.3 | 3.465 | V |
| C_L Load capacitance | Minimal ESR to insure stability of regulated output | | 4.7 | | μF |
| $I_{lkg(REV)}$ Reverse leakage output current | Tested for input that is grounded. 3.3VAUX, 5VAUX, or 5VCC = GND, 3.3V _{OUT} = 3.3 V | | | 50 | μA |

[†] Design targets only. Not tested in production.

5-V detect

| PARAMETER | TEST CONDITIONS | MIN | TYP | MAX | UNIT |
|---|----------------------------|------|------|------|------|
| $V_{(TO_LO)}$ Threshold voltage, low | 5VAUX or 5VCC \downarrow | 3.85 | 4.05 | 4.25 | V |
| $V_{(TO_HI)}$ Threshold voltage, high | 5VAUX or 5VCC \uparrow | 4.1 | 4.3 | 4.5 | V |

auxiliary switch

| PARAMETER | TEST CONDITIONS | MIN | TYP | MAX | UNIT |
|--|---|-----|-----|-----|----------|
| $R_{(SWITCH)}$ Auxiliary switch resistance | 5VAUX = 5VCC = 0 V, 3.3VAUX = 3.3 V, $I_L = 150$ mA | | | 0.4 | Ω |
| $\Delta V_{O(\Delta VI)}$ Line regulation voltage | 5VAUX or 5VCC = 4.5 V to 5.5 V | | 2 | | mV |
| $\Delta V_{O(\Delta IO)}$ Load regulation voltage | 20 mA < I_L < 400 mA | | 40 | | mV |
| $V_I - V_O$ Dropout voltage | $I_L < 400$ mA | | | 1 | V |

Power OK (\overline{POK})

| PARAMETER | TEST CONDITIONS | MIN | TYP | MAX | UNIT |
|--|---|------|-----|------|---------------|
| $V_{(TO_POK)}$ POK threshold voltage | 3.3V _{OUT} = 0 \rightarrow 3.3 V and starts \overline{POK} delay timer | 2.67 | 2.8 | 2.93 | V |
| V_{OL} Output low voltage | | | | 0.4 | |
| I_{OH} Output high current | | | | 200 | μA |
| V_{OH} Output high voltage | 5K pullup to 3.3V _{OUT} | | 3.3 | | V |

timing characteristics, $T_A = 0^\circ\text{C}$ to 70°C , $C_L = 4.7\ \mu\text{F}$ (unless otherwise noted)[†]

| PARAMETER | TEST CONDITIONS | MIN | TYP | MAX | UNIT |
|-------------------------|---|-----|-----|-----|------|
| t_d Power OK delay | 5VCC or 5VAUX or 3.3VAUX > V_{TO} and \overline{POK} \uparrow | | 5 | 10 | ms |

[†] Design targets only. Not tested in production.

thermal characteristics[‡]

| PARAMETER | MIN | TYP | MAX | UNIT |
|---|-----|-----|-----|---------------------------|
| $R_{\theta JC}$ Thermal impedance, junction-to-case | | 4.7 | | $^\circ\text{C}/\text{W}$ |
| $R_{\theta JA}$ Thermal impedance, junction-to-ambient | | 59 | | $^\circ\text{C}/\text{W}$ |

[‡] Based on Texas Instrument recommended board for PowerPAD package.



PARAMETER MEASUREMENT INFORMATION

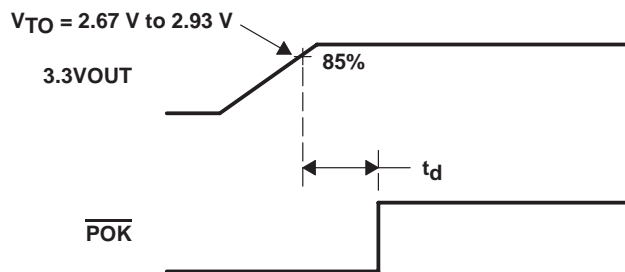

Figure 1. Power OK Timing Diagram

TYPICAL CHARACTERISTICS

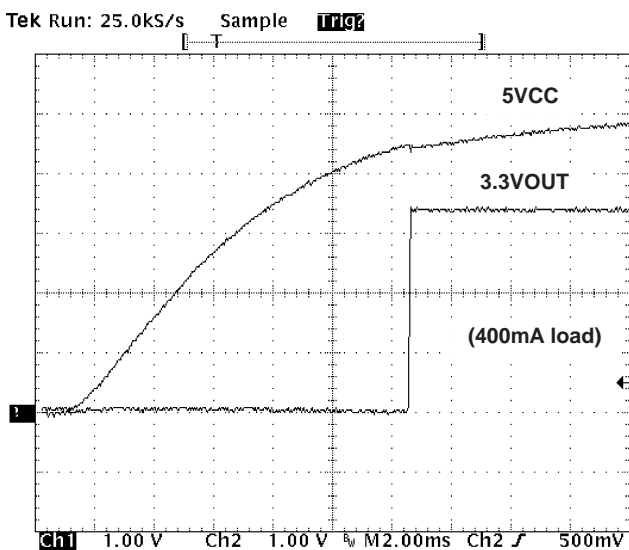

Figure 2. 5VCC Cold Start

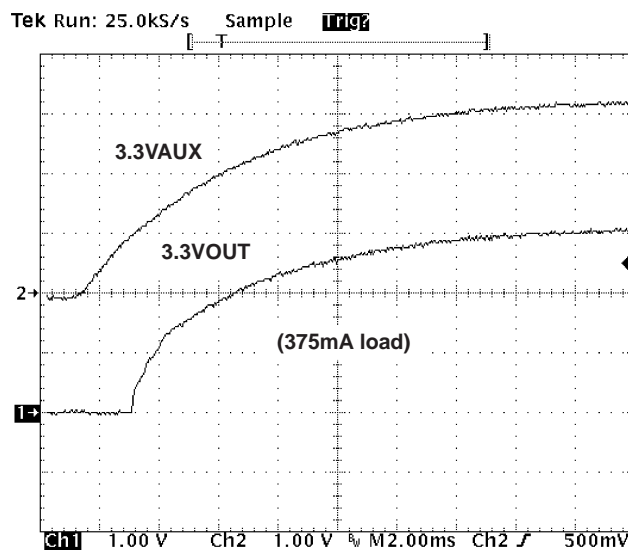

Figure 3. 3.3VAUX Cold Start

TYPICAL CHARACTERISTICS

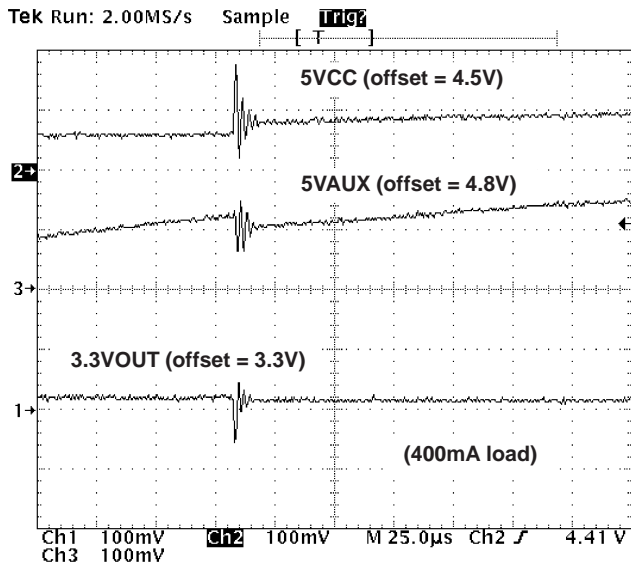

Figure 4. 5VCC Power Up (5VAUX = 5 V)

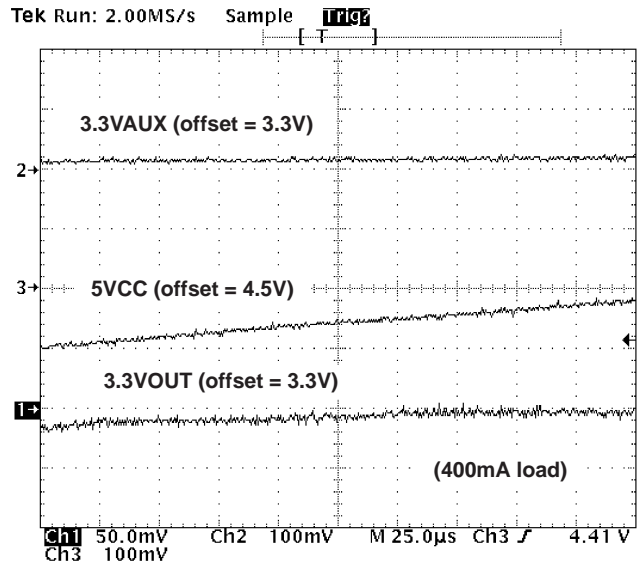

Figure 5. 5VCC Power Up (3.3VAUX = 3.3 V)

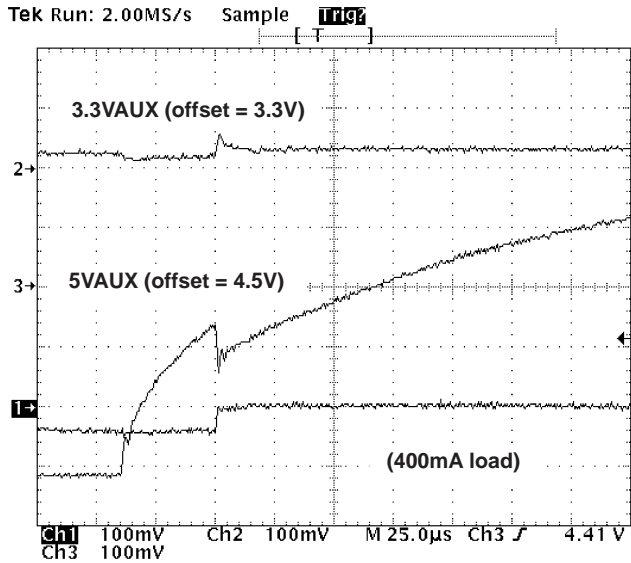

Figure 6. 5VAUX Power Up (3.3VAUX = 3.3 V)

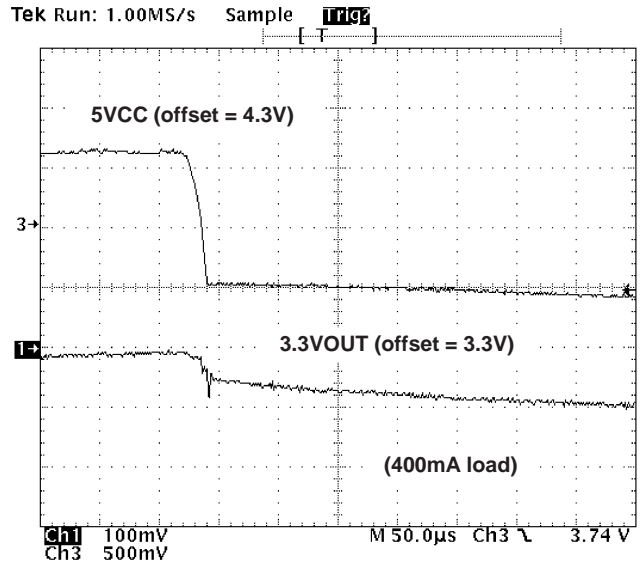

Figure 7. 5VCC Power Down (3.3VAUX = 3.3 V)

TYPICAL CHARACTERISTICS

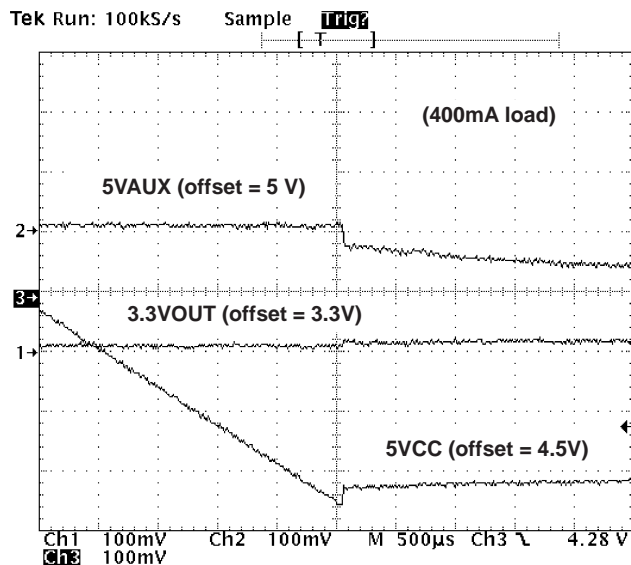

Figure 8. 5VCC Power Down (5VAUX = 5 V)

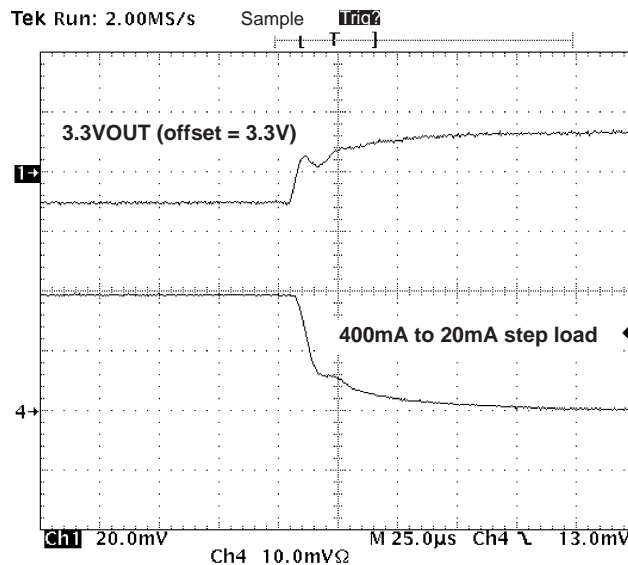

Figure 9. 5VCC Load Transient Responses Falling

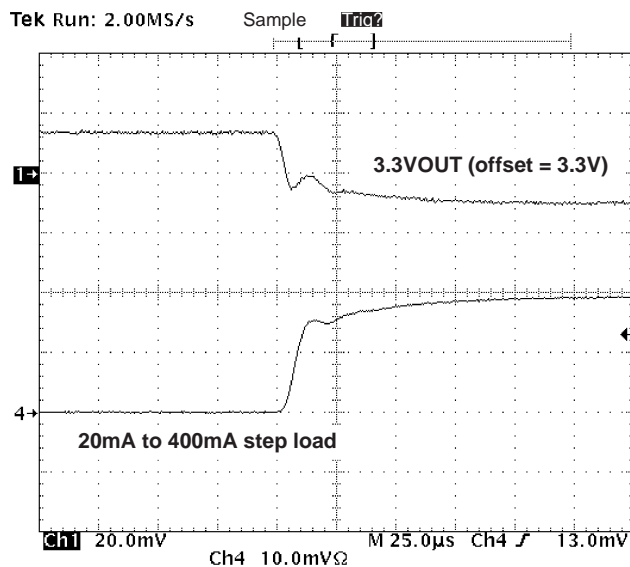

Figure 10. 5VCC Load Transient Response Rising

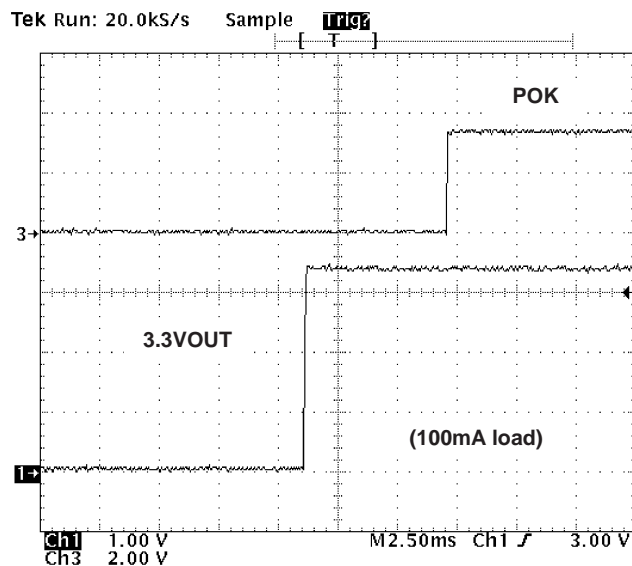

Figure 11. 5VCC Cold Start, \overline{POK} Released

THERMAL INFORMATION

To ensure reliable operation of the device, the junction temperature of the output device must be within the safe operating area (SOA). This is achieved by having a means to dissipate the heat generated from the junction of the output structure. There are two components that contribute to thermal resistance. They consist of two paths in series. The first is the junction to case thermal resistance, $R_{\theta JC}$; the second is the case to ambient thermal resistance, $R_{\theta CA}$. The overall junction to ambient thermal resistance, $R_{\theta JA}$, is determined by:

$$R_{\theta JA} = R_{\theta JC} + R_{\theta CA}$$

The ability to efficiently dissipate the heat from the junction is a function of the package style and board layout incorporated in the application. The operating junction temperature is determined by the operating ambient temperature, T_A , and the junction power dissipation, P_J .

The junction temperature, T_J , is equal to the following thermal equation:

$$T_J = T_A + P_J (R_{\theta JC}) + P_J (R_{\theta CA})$$

$$T_J = T_A + P_J (R_{\theta JA})$$

This particular application uses the 8-pin DGN PowerPAD package with a standard lead frame with dedicated ground terminal. Using a multilayer printed-circuit board (PCB), the power pad is mounted as recommended in the TI packaging application. The power pad is electrically connected to the ground plane of the circuit board through the dedicated ground pin and the die mount power pad. This will provide a means for heat spreading through the copper plane associated within the PCB (GND Layer). This concept could provide a thermal resistance from junction to ambient, $R_{\theta JA}$, of 59°C/W if implemented correctly.

Hence, maximum power dissipation allowable for an operating ambient temperature of 70°C, and a maximum junction temperature of 150°C is determined as:

$$P_J = (T_J - T_A) / R_{\theta JA}$$

$$P_J = (150 - 70) / 59 = 1.36 \text{ W}$$

Using a multilayer board and utilizing the ground plane for heat spreading.

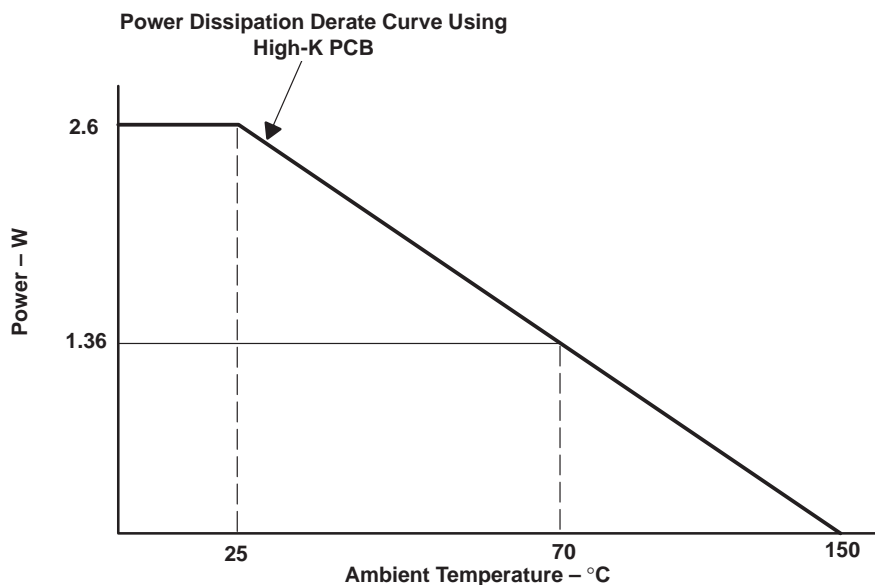

NOTE: This curve is to be used for guideline purposes only. For a particular application, a more specific thermal characterization is required.

Figure 12. Power Dissipation Derating Curve

APPLICATION INFORMATION

packaging

To maximize the efficiency of this package for application on a single layer or multilayer PCB, certain guidelines must be followed.

The following information is to be used as a guideline only. For further information, refer to the PowerPAD concept implementation document.

multilayer PCB

Guidelines for mounting the PowerPAD IC on a multilayer PCB with a ground plane.

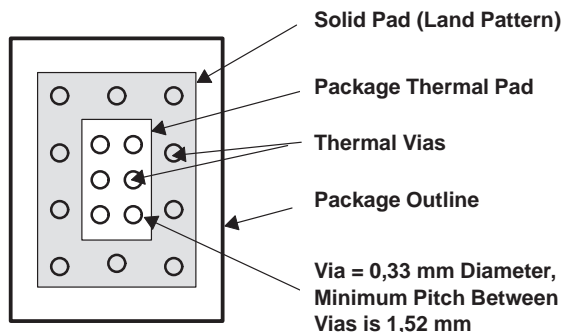

Figure 13. Package and Land Configuration for a Multilayer PCB

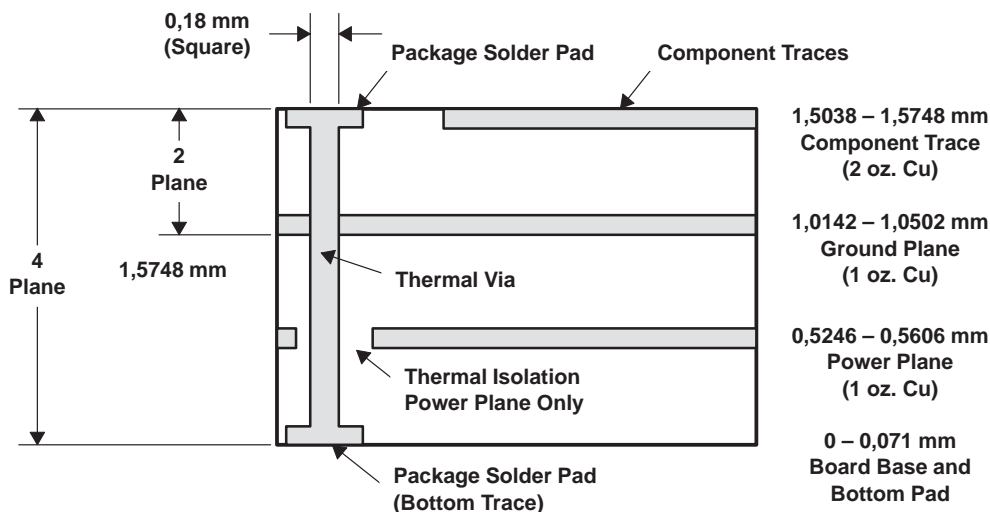

Figure 14. Multilayer Board (Side View)

APPLICATION INFORMATION

In a multilayer board application, the thermal vias are the primary method of heat transfer from the package thermal pad to the internal ground plane. The efficiency of this method depends on several factors (die area, number of thermal vias, thickness of copper) Consult the *PowerPAD Thermally Enhanced Package Technical Brief*.

single-layer PCB

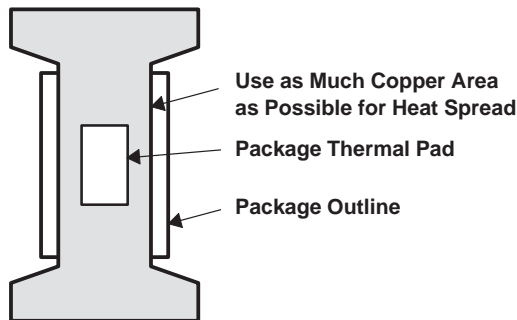

Figure 15. Land Configuration for Single-layer PCB

Layout recommendations for a single-layer PCB utilize as much copper area as possible for power management.

In a single layer board application, the thermal pad is attached to a heat spreader (copper area) by using low thermal impedance attachment method (solder paste or thermal conductive epoxy).

In both of the methods mentioned above, it is advisable to use as many copper traces as possible to dissipate the heat.

IMPORTANT

If the attachment method is NOT implemented correctly, the functionality of the product is not efficient. Power dissipation capability will be adversely affected if the device is incorrectly mounted onto the circuit board.

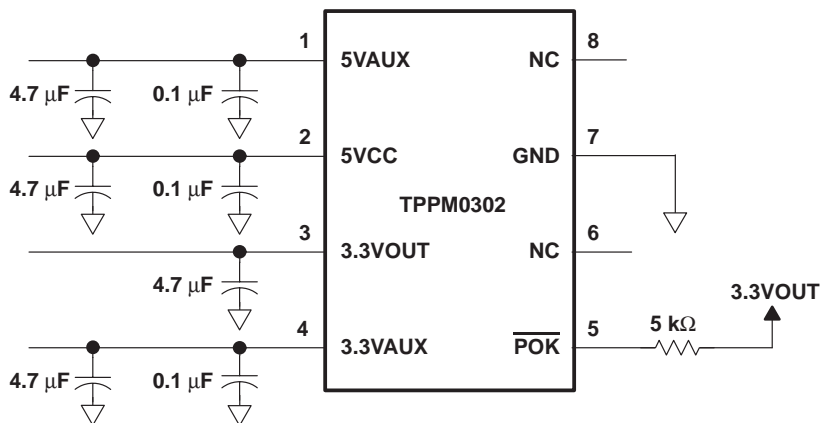

Figure 16. Typical Application Schematic

PACKAGING INFORMATION

| Orderable Device | Status (1) | Package Type | Package Drawing | Pins | Package Qty | Eco Plan (2) | Lead finish/ Ball material (6) | MSL Peak Temp (3) | Op Temp (°C) | Device Marking (4/5) | Samples |
|------------------|---------------|--------------|--------------------|------|----------------|-----------------|--------------------------------------|----------------------|--------------|-------------------------|---------|
| TPPM0302DGN | ACTIVE | HVSSOP | DGN | 8 | 80 | RoHS & Green | NIPDAU | Level-1-260C-UNLIM | 0 to 70 | APF | Samples |

(1) The marketing status values are defined as follows:

ACTIVE: Product device recommended for new designs.

LIFEBUY: TI has announced that the device will be discontinued, and a lifetime-buy period is in effect.

NRND: Not recommended for new designs. Device is in production to support existing customers, but TI does not recommend using this part in a new design.

PREVIEW: Device has been announced but is not in production. Samples may or may not be available.

OBSOLETE: TI has discontinued the production of the device.

(2) **RoHS:** TI defines "RoHS" to mean semiconductor products that are compliant with the current EU RoHS requirements for all 10 RoHS substances, including the requirement that RoHS substance do not exceed 0.1% by weight in homogeneous materials. Where designed to be soldered at high temperatures, "RoHS" products are suitable for use in specified lead-free processes. TI may reference these types of products as "Pb-Free".

RoHS Exempt: TI defines "RoHS Exempt" to mean products that contain lead but are compliant with EU RoHS pursuant to a specific EU RoHS exemption.

Green: TI defines "Green" to mean the content of Chlorine (Cl) and Bromine (Br) based flame retardants meet JS709B low halogen requirements of <=1000ppm threshold. Antimony trioxide based flame retardants must also meet the <=1000ppm threshold requirement.

(3) MSL, Peak Temp. - The Moisture Sensitivity Level rating according to the JEDEC industry standard classifications, and peak solder temperature.

(4) There may be additional marking, which relates to the logo, the lot trace code information, or the environmental category on the device.

(5) Multiple Device Markings will be inside parentheses. Only one Device Marking contained in parentheses and separated by a "-" will appear on a device. If a line is indented then it is a continuation of the previous line and the two combined represent the entire Device Marking for that device.

(6) Lead finish/Ball material - Orderable Devices may have multiple material finish options. Finish options are separated by a vertical ruled line. Lead finish/Ball material values may wrap to two lines if the finish value exceeds the maximum column width.

Important Information and Disclaimer: The information provided on this page represents TI's knowledge and belief as of the date that it is provided. TI bases its knowledge and belief on information provided by third parties, and makes no representation or warranty as to the accuracy of such information. Efforts are underway to better integrate information from third parties. TI has taken and continues to take reasonable steps to provide representative and accurate information but may not have conducted destructive testing or chemical analysis on incoming materials and chemicals. TI and TI suppliers consider certain information to be proprietary, and thus CAS numbers and other limited information may not be available for release.

In no event shall TI's liability arising out of such information exceed the total purchase price of the TI part(s) at issue in this document sold by TI to Customer on an annual basis.

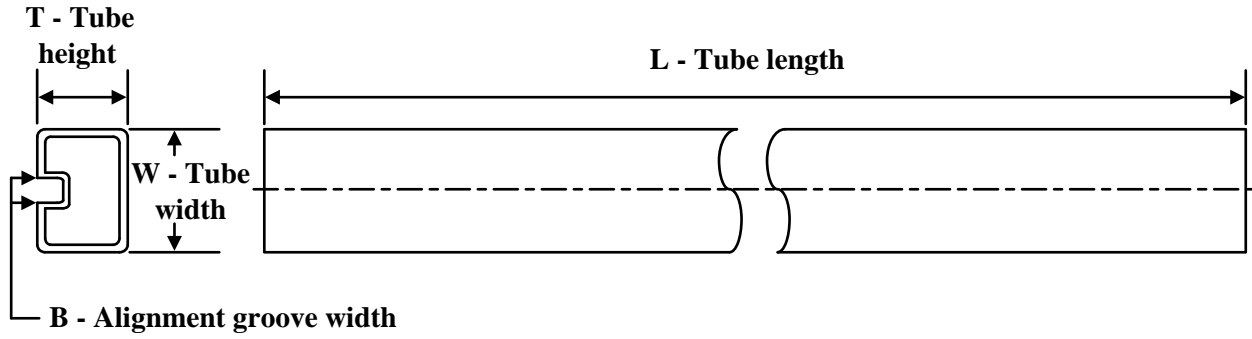
TUBE

*All dimensions are nominal

| Device | Package Name | Package Type | Pins | SPQ | L (mm) | W (mm) | T (μm) | B (mm) |
|-------------|--------------|--------------|------|-----|--------|--------|--------|--------|
| TPPM0302DGN | DGN | HVSSOP | 8 | 80 | 331.47 | 6.55 | 3000 | 2.88 |

GENERIC PACKAGE VIEW

DGN 8

PowerPAD™ HVSSOP - 1.1 mm max height

3 x 3, 0.65 mm pitch

SMALL OUTLINE PACKAGE

This image is a representation of the package family, actual package may vary.
Refer to the product data sheet for package details.

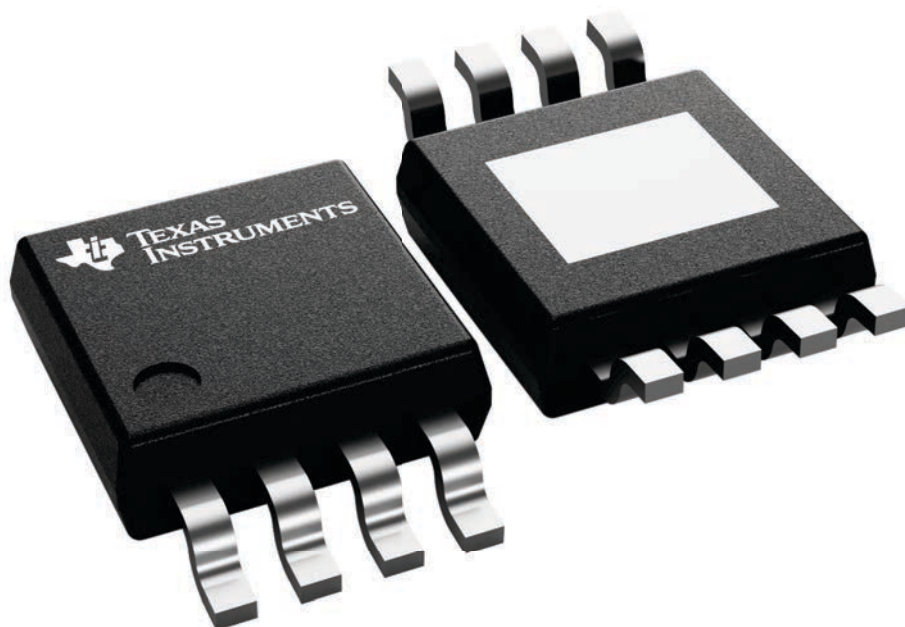

4225482/B

EXAMPLE BOARD LAYOUT

DGN0008D

PowerPAD™ VSSOP - 1.1 mm max height

SMALL OUTLINE PACKAGE

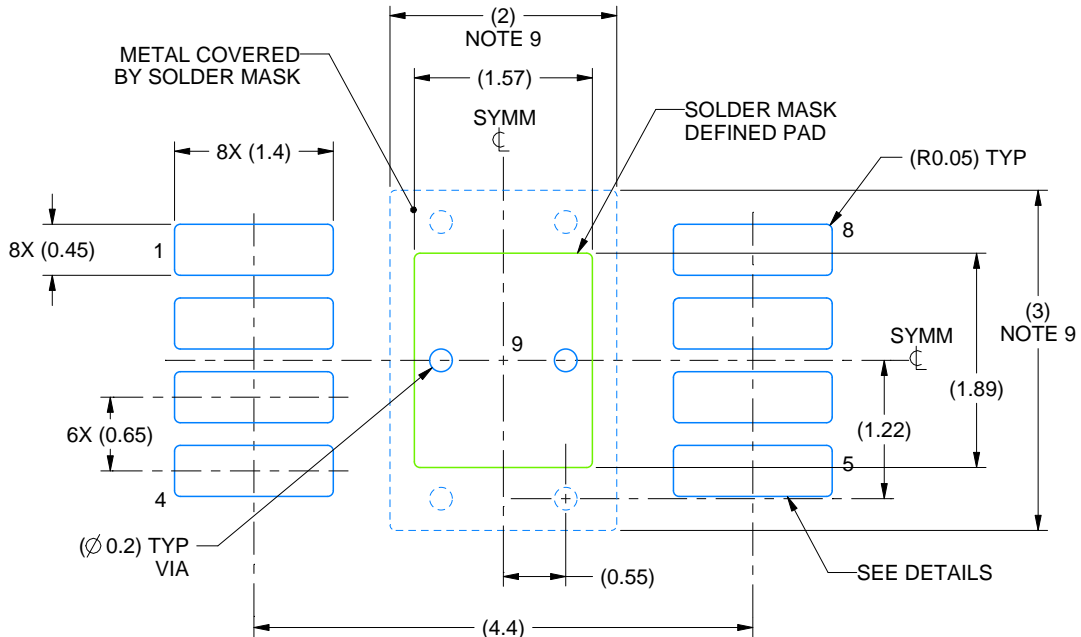

LAND PATTERN EXAMPLE
EXPOSED METAL SHOWN
SCALE: 15X

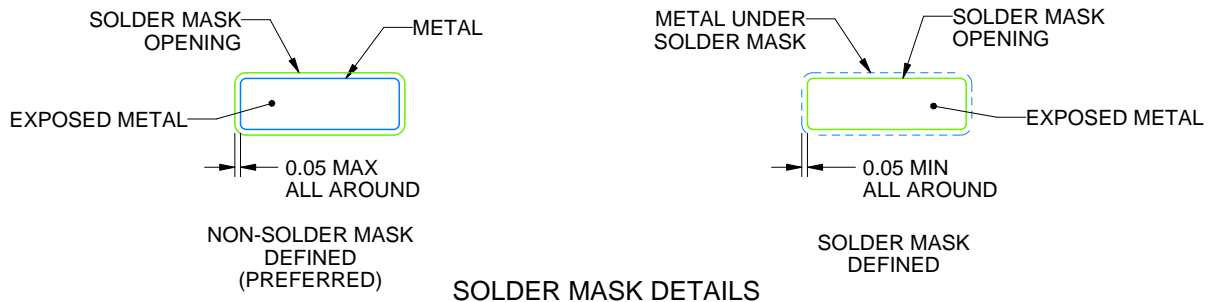

4225481/A 11/2019

NOTES: (continued)

6. Publication IPC-7351 may have alternate designs.
7. Solder mask tolerances between and around signal pads can vary based on board fabrication site.
8. Vias are optional depending on application, refer to device data sheet. If any vias are implemented, refer to their locations shown on this view. It is recommended that vias under paste be filled, plugged or tented.
9. Size of metal pad may vary due to creepage requirement.

EXAMPLE STENCIL DESIGN

DGN0008D

PowerPAD™ VSSOP - 1.1 mm max height

SMALL OUTLINE PACKAGE

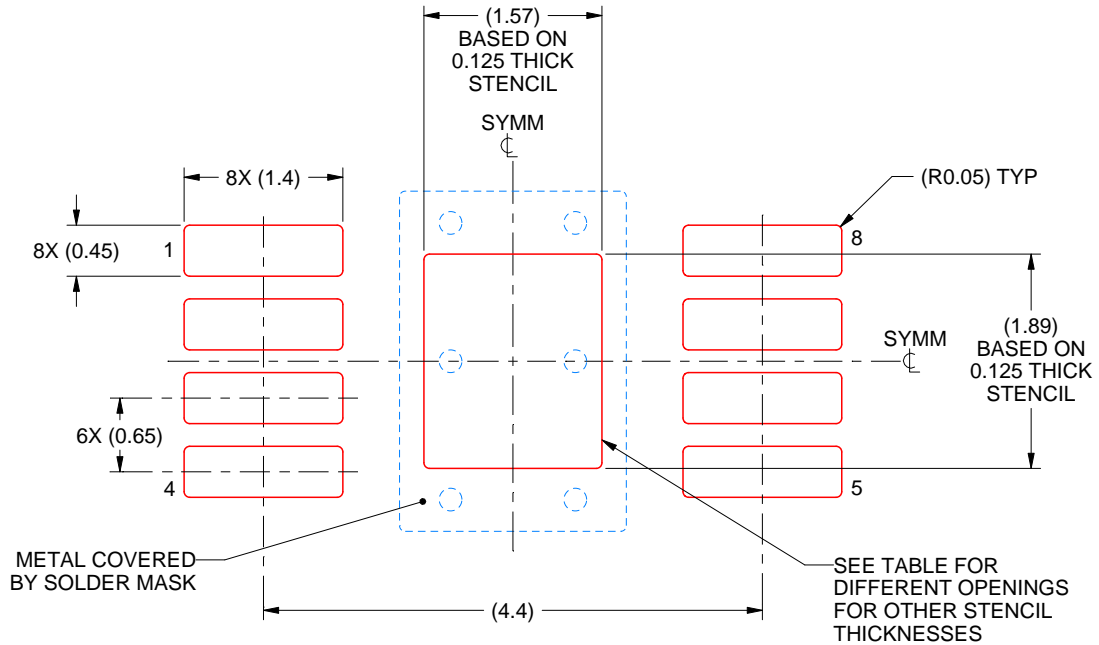

SOLDER PASTE EXAMPLE
EXPOSED PAD 9:
100% PRINTED SOLDER COVERAGE BY AREA
SCALE: 15X

| STENCIL THICKNESS | SOLDER STENCIL OPENING |
|-------------------|------------------------|
| 0.1 | 1.76 X 2.11 |
| 0.125 | 1.57 X 1.89 (SHOWN) |
| 0.15 | 1.43 X 1.73 |
| 0.175 | 1.33 X 1.60 |

4225481/A 11/2019

NOTES: (continued)

10. Laser cutting apertures with trapezoidal walls and rounded corners may offer better paste release. IPC-7525 may have alternate design recommendations.
11. Board assembly site may have different recommendations for stencil design.

IMPORTANT NOTICE AND DISCLAIMER

TI PROVIDES TECHNICAL AND RELIABILITY DATA (INCLUDING DATA SHEETS), DESIGN RESOURCES (INCLUDING REFERENCE DESIGNS), APPLICATION OR OTHER DESIGN ADVICE, WEB TOOLS, SAFETY INFORMATION, AND OTHER RESOURCES "AS IS" AND WITH ALL FAULTS, AND DISCLAIMS ALL WARRANTIES, EXPRESS AND IMPLIED, INCLUDING WITHOUT LIMITATION ANY IMPLIED WARRANTIES OF MERCHANTABILITY, FITNESS FOR A PARTICULAR PURPOSE OR NON-INFRINGEMENT OF THIRD PARTY INTELLECTUAL PROPERTY RIGHTS.

These resources are intended for skilled developers designing with TI products. You are solely responsible for (1) selecting the appropriate TI products for your application, (2) designing, validating and testing your application, and (3) ensuring your application meets applicable standards, and any other safety, security, regulatory or other requirements.

These resources are subject to change without notice. TI grants you permission to use these resources only for development of an application that uses the TI products described in the resource. Other reproduction and display of these resources is prohibited. No license is granted to any other TI intellectual property right or to any third party intellectual property right. TI disclaims responsibility for, and you will fully indemnify TI and its representatives against, any claims, damages, costs, losses, and liabilities arising out of your use of these resources.

TI's products are provided subject to [TI's Terms of Sale](#) or other applicable terms available either on [ti.com](https://www.ti.com) or provided in conjunction with such TI products. TI's provision of these resources does not expand or otherwise alter TI's applicable warranties or warranty disclaimers for TI products.

TI objects to and rejects any additional or different terms you may have proposed.

Mailing Address: Texas Instruments, Post Office Box 655303, Dallas, Texas 75265
Copyright © 2024, Texas Instruments Incorporated