

3-V TO 20-V INPUT SYNCHRONOUS BUCK CONTROLLER

Check for Samples: [TPS40304A](#)

FEATURES

- Input Voltage Range from 3 V to 20 V
- Fixed 600-kHz Switching Frequency
- High- and Low-Side FET $R_{DS(on)}$ Current Sensing
- Programmable Thermally Compensated OCP Levels
- Programmable Soft-Start
- 591-mV, 1% Reference Voltage
- Voltage Feed-Forward Compensation
- Supports Pre-Biased Output
- Frequency Spread Spectrum
- Thermal Shutdown Protection at 145°C
- 10-Pin 3 mm × 3 mm SON Package with Ground Connection to Thermal Pad

CONTENTS

Device Ratings	2
Electrical Characteristics	3
Device Information	8
Application Information	10
Additional References	13

APPLICATIONS

- POL Modules
- Printer
- Digital TV
- Telecom

DESCRIPTION

The TPS40304A is a cost-optimized synchronous buck controller that operates from 3-V to 20-V input. The controller implements a voltage-mode control architecture with input-voltage feed-forward compensation that responds instantly to input voltage change. The switching frequency is fixed at 600 kHz.

Frequency Spread Spectrum feature adds dither to the switching frequency, significantly reducing the peak EMI noise and making it much easier to comply with EMI standards.

The TPS40304A offers design with a variety of user programmable functions, including soft-start, overcurrent protection (OCP) levels, and loop compensation.

The OCP level is programmed by a single external resistor connected from LDRV pin to circuit ground. During initial power on, the TPS40304A enters a calibration cycle, measures the voltage at the LDRV pin, and sets an internal OCP voltage level. During operation, the programmed OCP voltage level is compared to the voltage drop across the low-side FET when it is on to determine whether there is an overcurrent condition. The TPS40304A then enters a shutdown and restart cycle until the fault is removed.

SIMPLIFIED APPLICATION DIAGRAM

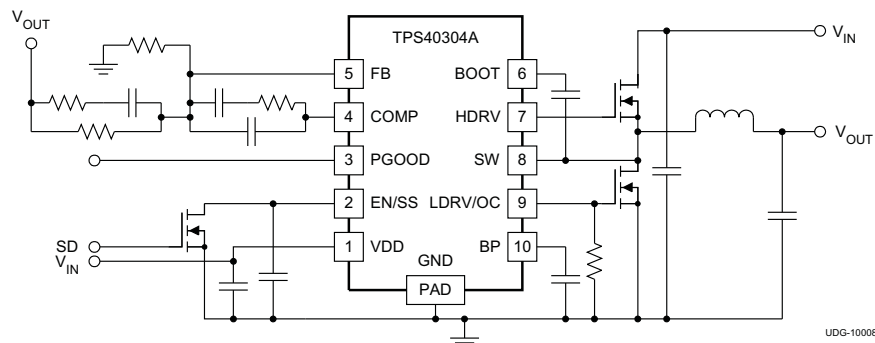

UDG-10008



Please be aware that an important notice concerning availability, standard warranty, and use in critical applications of Texas Instruments semiconductor products and disclaimers thereto appears at the end of this data sheet.

TPS40304A

SLUSA30 –FEBRUARY 2010

www.ti.com

This integrated circuit can be damaged by ESD. Texas Instruments recommends that all integrated circuits be handled with appropriate precautions. Failure to observe proper handling and installation procedures can cause damage.

ESD damage can range from subtle performance degradation to complete device failure. Precision integrated circuits may be more susceptible to damage because very small parametric changes could cause the device not to meet its published specifications.

ORDERING INFORMATION

OPERATING FREQUENCY	PACKAGE	TAPE AND REEL QUANTITY	PART NUMBER
600 kHz	Plastic 10-Pin SON (DRC)	250	TPS40304ADRCT
		3000	TPS40304ADRCR

ABSOLUTE MAXIMUM RATINGS

over operating free-air temperature range (unless otherwise noted)⁽¹⁾

	VALUE	UNIT
VDD	-0.3 to 22	V
SW	-3 to 27	V
SW (< 100 ns pulse width, 10 μ J)	-5	V
BOOT	-0.3 to 30	V
HDRV	-5 to 30	V
BOOT-SW, HDRV-SW (differential from BOOT or HDRV to SW)	-0.3 to 7	V
COMP, PGOOD, FB, BP, LDRV, EN/SS	-0.3 to 7	V
T _J Operating junction temperature range	-40 to 145	°C
T _{stg} Storage temperature	-55 to 150	°C

(1) Stresses beyond those listed under *absolute maximum ratings* may cause permanent damage to the device. These are stress ratings only and functional operation of the device at these or any other condition beyond those included under *recommended operating conditions* is not implied. Exposure to absolute-maximum-rated conditions for extended periods of time may affect device reliability.

DISSIPATION RATINGS

PACKAGE	AIRFLOW (LFM)	R _{θJA} HIGH-K BOARD ⁽¹⁾ (°C/W)	POWER RATING (W) T _A = 25°C	POWER RATING (W) T _A = 85°C
10-Pin SON (DRC)	0 (Natural Convection)	47.9	2.08	0.835
	200	40.5	2.46	0.987
	400	38.2	2.61	1.04

(1) Ratings based on JEDEC High Thermal Conductivity (High K) Board. For more information on the test method, see TI technical brief [\(SZZA017\)](#).

RECOMMENDED OPERATING CONDITIONS

	MIN	NOM	MAX	UNIT
VDD Input voltage	3		20	V
T _J Operating junction temperature	-40		125	°C

ELECTROSTATIC DISCHARGE (ESD) PROTECTION

	MIN	TYP	MAX	UNIT
Human body model (HBM)		2000		V
Charge device model (CDM)		1500		V

ELECTRICAL CHARACTERISTICS
 $T_J = -40^{\circ}\text{C}$ to 125°C , $V_{VDD} = 12\text{ V}$, all parameters at zero power dissipation (unless otherwise noted)

PARAMETER		TEST CONDITIONS	MIN	TYP	MAX	UNIT
VOLTAGE REFERENCE						
V_{FB}	FB input voltage	$T_J = 25^{\circ}\text{C}$, $3\text{ V} < V_{VDD} < 20\text{ V}$	588	591	594	mV
		$-40^{\circ}\text{C} < T_J < 125^{\circ}\text{C}$, $3\text{ V} < V_{VDD} < 20\text{ V}$	585	591	597	
INPUT SUPPLY						
V_{VDD}	Input supply voltage range		3		20	V
I_{DDSD}	Shutdown supply current	$V_{EN/SS} < 0.2\text{ V}$		70	100	μA
I_{DDQ}	Quiescent, non-switching	Let EN/SS float, $V_{FB} = 1\text{ V}$		2.5	3.5	mA
ENABLE/SOFT-START						
V_{IH}	High-level input voltage, EN/SS		0.55	0.70	1.00	V
V_{IL}	Low-level input voltage, EN/SS		0.27	0.30	0.33	V
I_{SS}	Soft-start source current		8	10	12	μA
V_{SS}	Soft-start voltage level		0.4	0.8	1.3	V
BP REGULATOR						
V_{BP}	Output voltage	$I_{BP} = 10\text{ mA}$	6.2	6.5	6.8	V
V_{DO}	Regulator dropout voltage, $V_{VDD} - V_{BP}$	$I_{BP} = 25\text{ mA}$, $V_{VDD} = 3\text{ V}$		70	110	mV
OSCILLATOR						
f_{SW}	PWM frequency	$3\text{ V} < V_{VDD} < 20\text{ V}$	540	600	660	kHz
$V_{RAMP}^{(1)}$	Ramp amplitude		$V_{VDD}/6.6$	$V_{VDD}/6$	$V_{VDD}/5.4$	V
f_{SWFSS}	Frequency spread spectrum frequency deviation		12%			f_{SW}
f_{MOD}	Modulation frequency			25		KHz
PWM						
$D_{MAX}^{(1)}$	Maximum duty cycle	$V_{FB} = 0\text{ V}$, $3\text{ V} < V_{VDD} < 20\text{ V}$	90%			
$t_{ON(min)}^{(1)}$	Minimum controllable pulse width			45	75	ns
t_{DEAD}	Output driver dead time	HDRV off to LDRV on	5	25	35	ns
		LDRV off to HDRV on	5	25	30	
ERROR AMPLIFIER						
$G_{BWP}^{(1)}$	Gain bandwidth product		10	24		MHz
$A_{OL}^{(1)}$	Open loop gain		60			dB
I_{IB}	Input bias current (current out of FB pin)	$V_{FB} = 0.6\text{ V}$			75	nA
I_{EAOP}	Output source current	$V_{FB} = 0\text{ V}$	2			mA
I_{EAOM}	Output sink current	$V_{FB} = 1\text{ V}$	2			

(1) Ensured by design. Not production tested.

ELECTRICAL CHARACTERISTICS (continued)
 $T_J = -40^{\circ}\text{C}$ to 125°C , $V_{DD} = 12\text{ V}$, all parameters at zero power dissipation (unless otherwise noted)

PARAMETER		TEST CONDITIONS	MIN	TYP	MAX	UNIT
PGOOD						
V_{OV}	Feedback upper voltage limit for PGOOD		646	666	691	mV
V_{UV}	Feedback lower voltage limit for PGOOD		491	516	541	
$V_{PGD-HYST}$	PGOOD hysteresis voltage at FB			25	40	
R_{PGD}	PGOOD pull down resistance	$V_{FB} = 0\text{ V}$, $I_{FB} = 5\text{ mA}$		30	70	Ω
I_{PGDLK}	PGOOD leakage current	$541\text{ mV} < V_{FB} < 646\text{ mV}$, $V_{PGOOD} = 5\text{ V}$		10	20	μA
OUTPUT DRIVERS						
R_{HDHI}	High-side driver pull-up resistance	$V_{BOOT} - V_{SW} = 5\text{ V}$, $I_{HDRV} = -100\text{ mA}$	0.8	1.5	2.5	Ω
R_{HDLO}	High-side driver pull-down resistance	$V_{BOOT} - V_{SW} = 5\text{ V}$, $I_{HDRV} = 100\text{ mA}$	0.5	1.0	2.2	Ω
R_{LDHI}	Low-side driver pull-up resistance	$I_{LDRV} = -100\text{ mA}$	0.8	1.5	2.5	Ω
R_{LDLO}	Low-side driver pull-down resistance	$I_{LDRV} = 100\text{ mA}$	0.35	0.60	1.20	Ω
$t_{HRISE}^{(2)}$	High-side driver rise time	$C_{LOAD} = 5\text{ nF}$		15		ns
$t_{HFFALL}^{(2)}$	High-side driver fall time			12		ns
$t_{LRISE}^{(2)}$	Low-side driver rise time			15		ns
$t_{LFFALL}^{(2)}$	Low-side driver fall time			10		ns
OVERCURRENT PROTECTION						
$t_{PSSC(min)}^{(2)}$	Minimum pulse time during short circuit			250		ns
$t_{BLNKH}^{(2)}$	Switch leading-edge blanking pulse time			150		ns
V_{OCH}	OC threshold for high-side FET	$T_J = 25^{\circ}\text{C}$	360	450	580	mV
I_{OCSET}	OCSET current source	$T_J = 25^{\circ}\text{C}$	9.5	10.0	10.5	μA
$V_{LD-CLAMP}$	Maximum clamp voltage at LDRV		260	340	400	mV
V_{OCLOS}	OC comparator offset voltage for low-side FET	$T_J = 25^{\circ}\text{C}$	-8		8	mV
$V_{OCLPRO}^{(2)}$	Programmable OC range for low-side FET	$T_J = 25^{\circ}\text{C}$	12		300	mV
$V_{THTC}^{(2)}$	OC threshold temperature coefficient (both high-side and low-side)			3000		ppm
t_{OFF}	OC retry cycles on EN/SS pin			4		Cycle
BOOT DIODE						
V_{DFWD}	Bootstrap diode forward voltage	$I_{BOOT} = 5\text{ mA}$		0.8		V
THERMAL SHUTDOWN						
$T_{JSD}^{(2)}$	Junction shutdown temperature			145		$^{\circ}\text{C}$
$T_{JSDH}^{(2)}$	Hysteresis			20		$^{\circ}\text{C}$

(2) Ensured by design. Not production tested.

TYPICAL CHARACTERISTICS

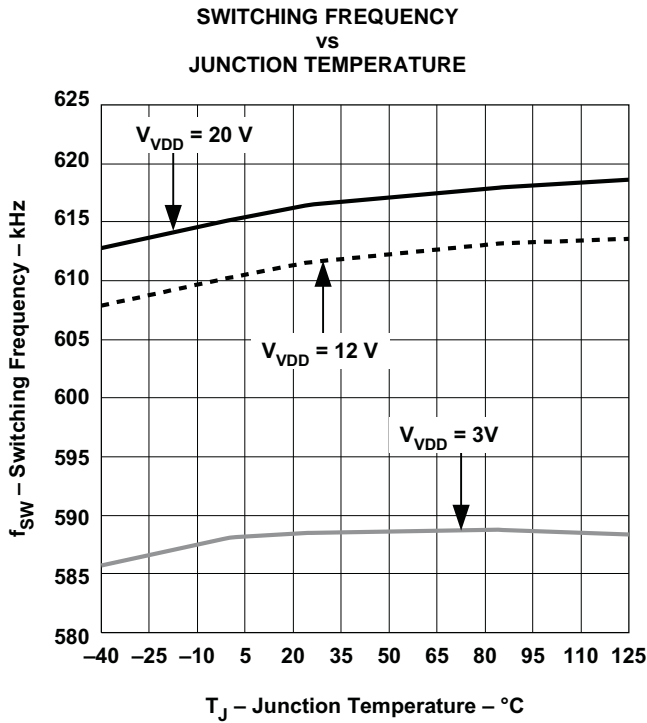

Figure 1.

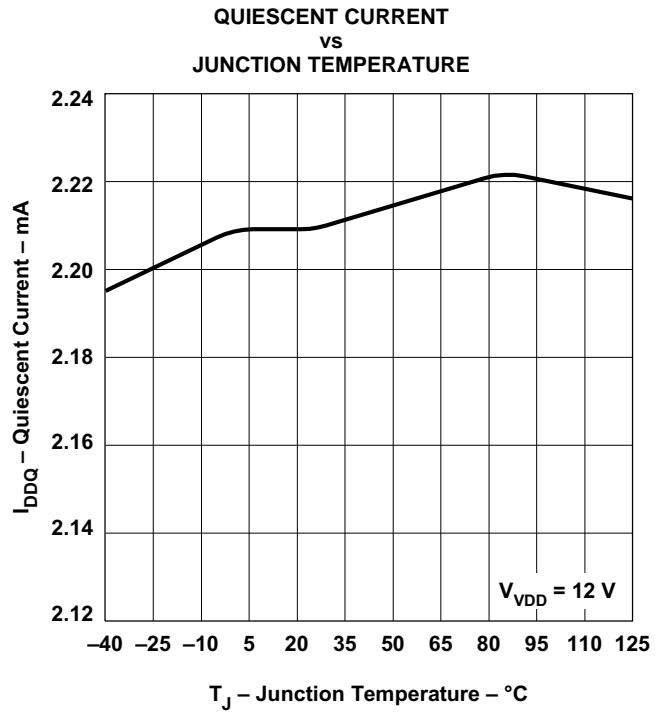

Figure 2.

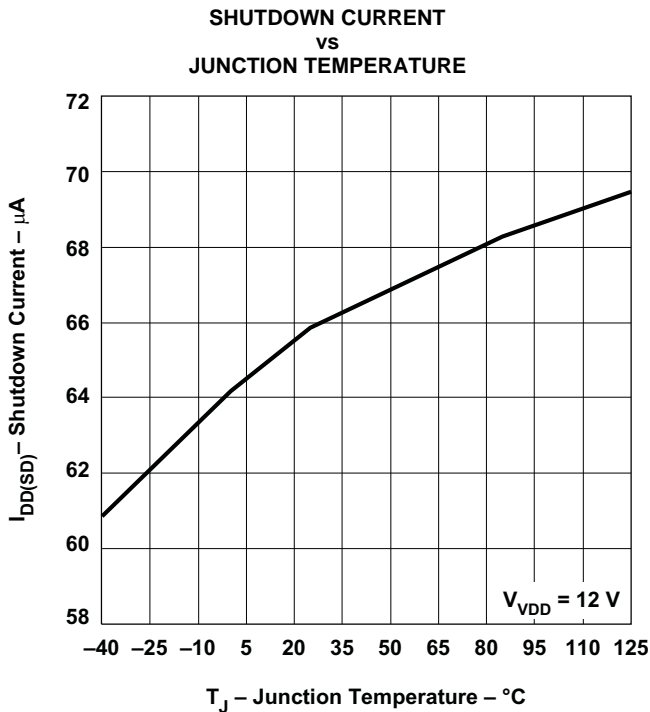

Figure 3.

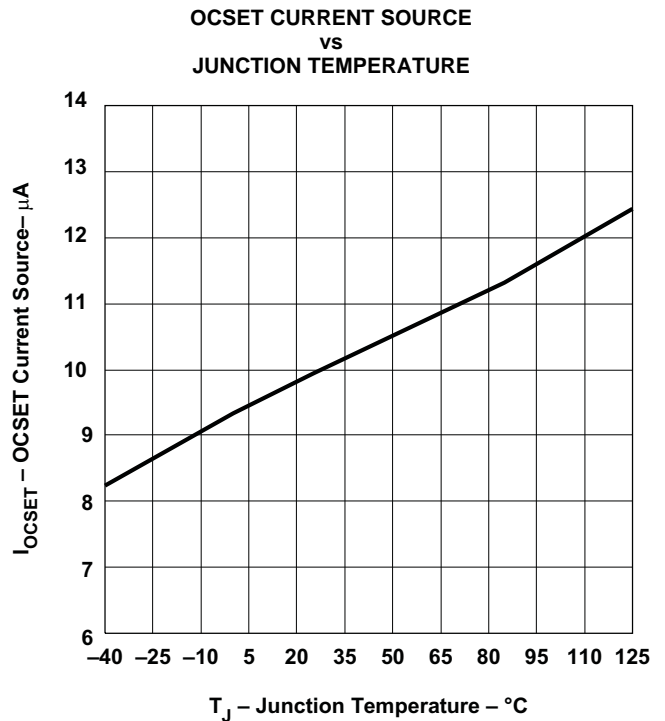

Figure 4.

TYPICAL CHARACTERISTICS (continued)

FEEDBACK REFERENCE VOLTAGE
vs
JUNCTION TEMPERATURE

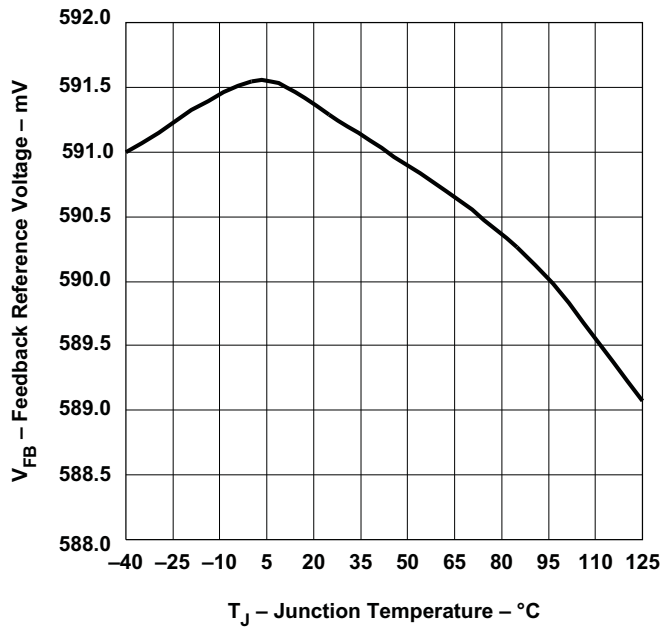

Figure 5.

ENABLE HIGH-LEVEL THRESHOLD VOLTAGE
vs
JUNCTION TEMPERATURE

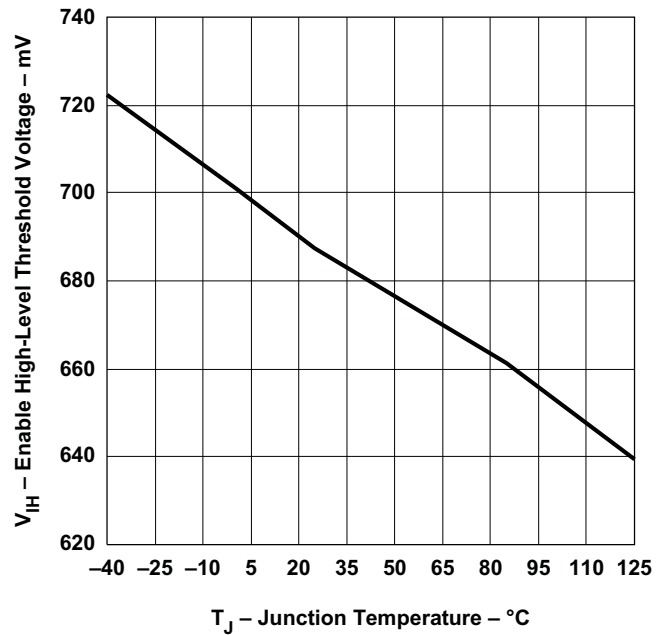

Figure 6.

ENABLE LOW-LEVEL THRESHOLD VOLTAGE
vs
JUNCTION TEMPERATURE

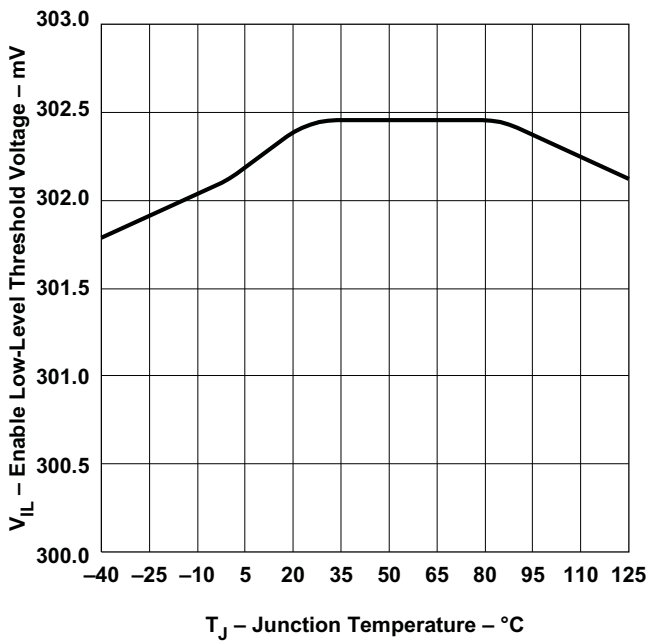

Figure 7.

HIGH-SIDE OVERCURRENT THRESHOLD
vs
JUNCTION TEMPERATURE

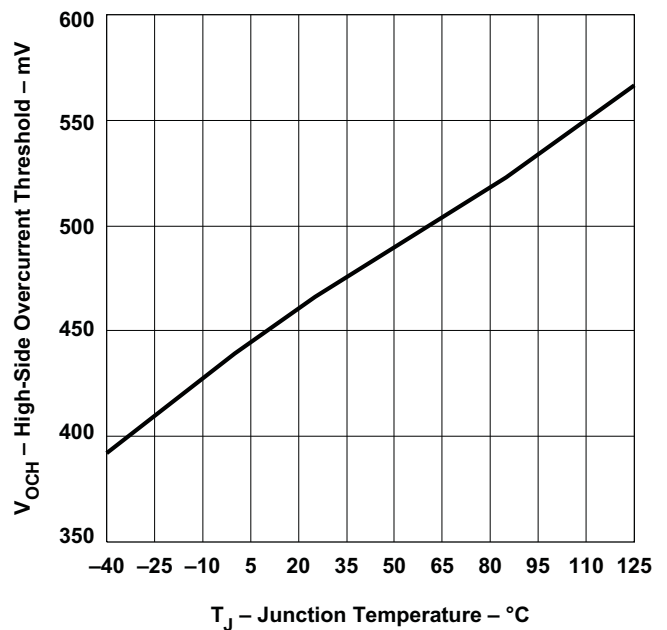

Figure 8.

TYPICAL CHARACTERISTICS (continued)

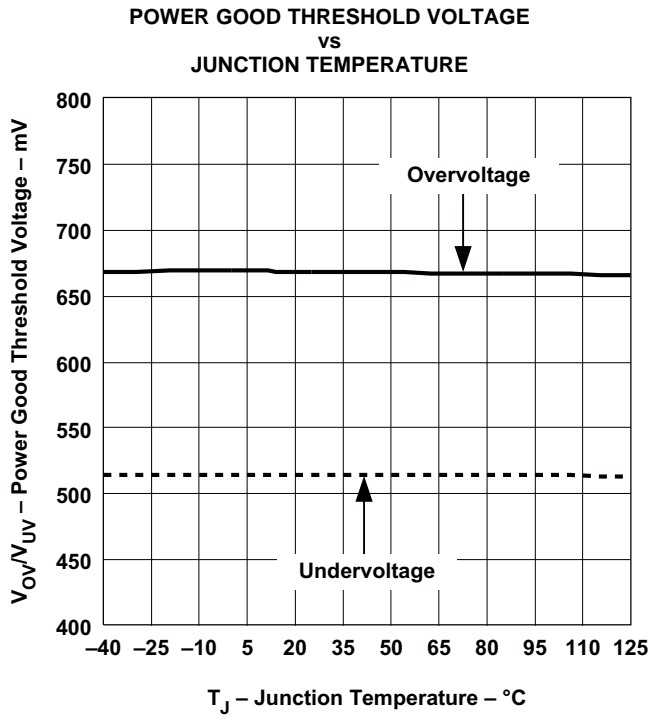

Figure 9.

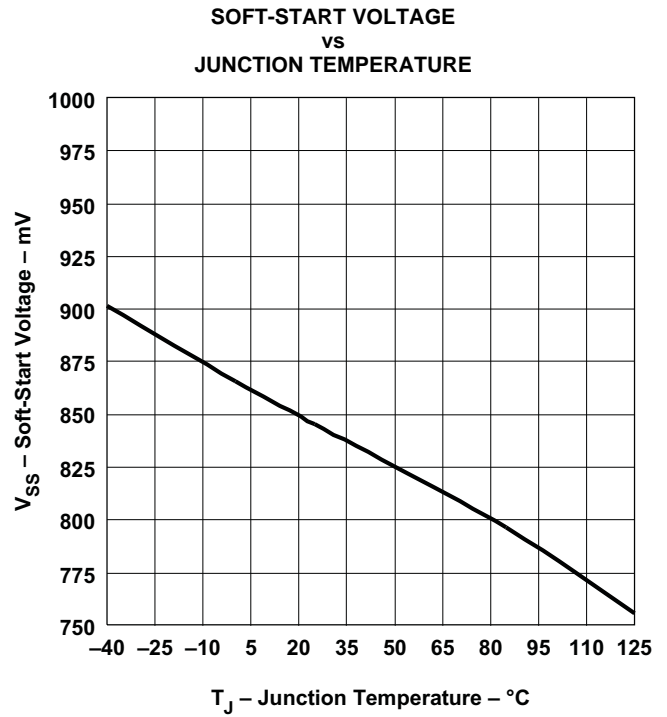
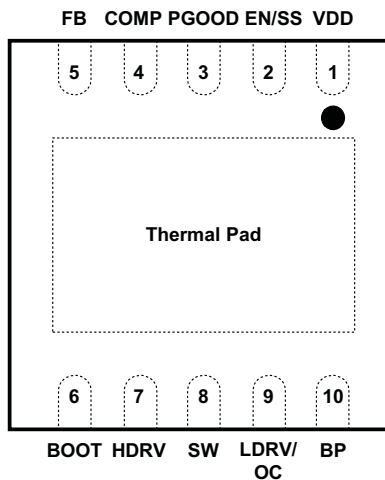

Figure 10.

DEVICE INFORMATION

TERMINAL CONFIGURATION

The package is an 10-Pin SON (DRC) package. Note: The thermal pad is an electrical ground connection.



PIN FUNCTIONS

TERMINAL		I/O	DESCRIPTION
NAME	NO.		
BOOT	6	I	Gate drive voltage for the high-side N-channel MOSFET. A 100 nF capacitor (typical) must be connected between this pin and SW. For low input voltage operation, an external schottky diode from BP to BOOT is recommended to maximize the gate drive voltage for the high-side.
BP	10	O	Output bypass for the internal regulator. Connect a low ESR bypass ceramic capacitor of 1 μ F or greater from this pin to GND.
COMP	4	O	Output of the error amplifier and connection node for loop feedback components.
EN/SS	2	I	Logic level input which starts or stops the controller via an external user command. Letting this pin float turns the controller on. Pulling this pin low disables the controller. This is also the soft-start programming pin. A capacitor connected from this pin to GND programs the soft-start time. The capacitor is charged with an internal current source of 10 μ A. The resulting voltage ramp of this pin is also used as a second non-inverting input to the error amplifier after a 0.8 V (typical) level shift downwards. Output regulation is controlled by the internal level shifted voltage ramp until that voltage reaches the internal reference voltage of 591 mV – the voltage ramp of this pin reaches 1.4 V (typical). Optionally, a 267 k Ω resistor from this pin to BP enables frequency spread spectrum feature.
FB	5	I	Inverting input to the error amplifier. In normal operation, the voltage on this pin is equal to the internal reference voltage.
PGOOD	3	O	Open drain power good output.
HDRV	7	O	Bootstrapped gate drive output for the high-side N-channel MOSFET.
LDRV/OC	9	O	Gate drive output for the low-side synchronous rectifier N-channel MOSFET. A resistor from this pin to GND is also used to determine the voltage level for OCP. An internal current source of 10 μ A flows through the resistor during initial calibration and that sets up the voltage trip point used for OCP.
VDD	1	I	Power input to the controller. Bypass VDD to GND with a low ESR ceramic capacitor of at least 1.0- μ F close to the device.
SW	8	O	Sense line for the adaptive anti-cross conduction circuitry. Serves as common connection for the flying high-side FET driver.
GND	Thermal Pad		Ground connection to the controller. This is also the thermal pad used to conduct heat from the device. This connection serves a twofold purpose. The first is to provide an electrical ground connection for the device. The second is to provide a low thermal impedance path from the device die to the PCB. This pad should be tied externally to a ground plane.

TPS40304A BLOCK DIAGRAM

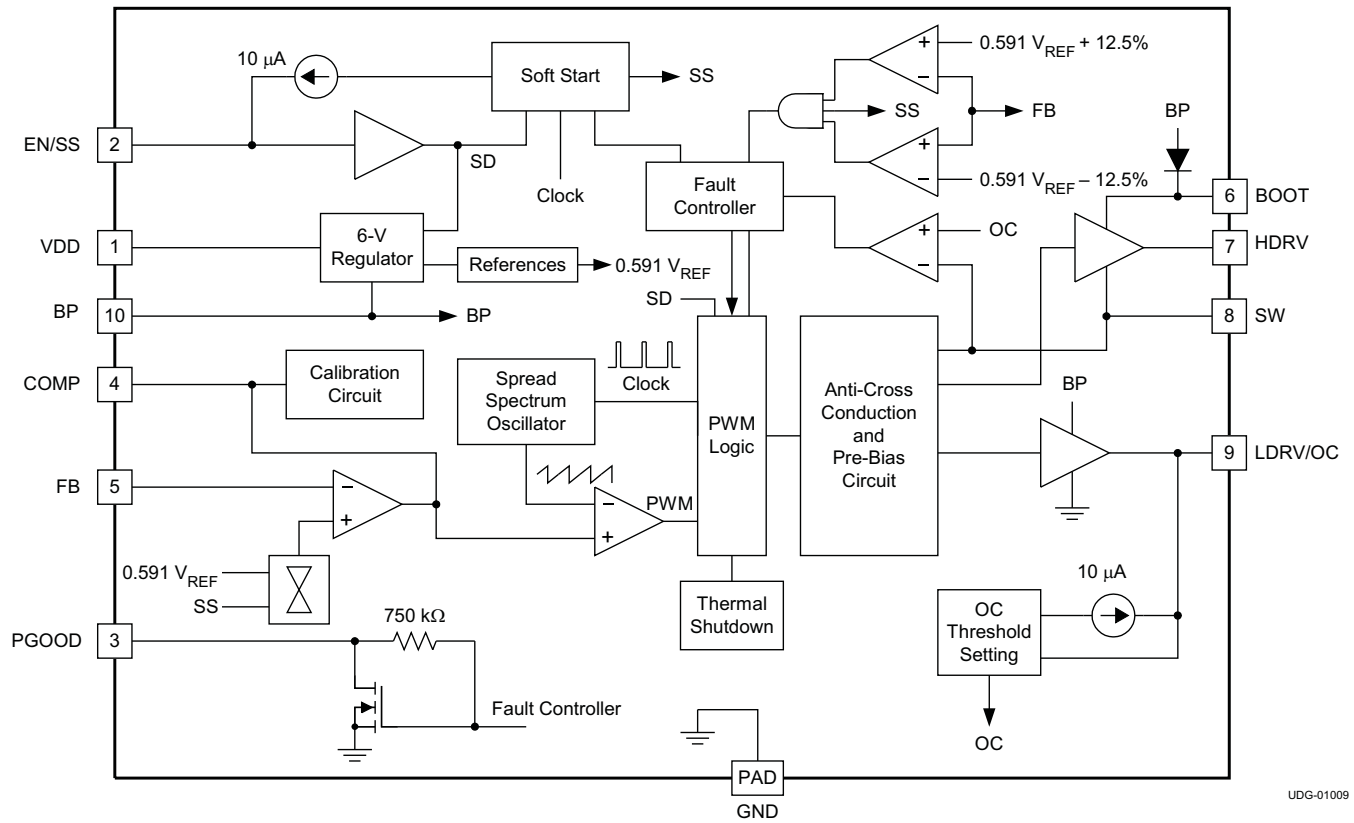

UDG-01009

APPLICATION INFORMATION

Introduction

The TPS40304A is a cost-optimized synchronous buck controller providing high-end features to construct high-performance DC/DC converters. Pre-bias capability eliminates concerns about damaging sensitive loads during startup. Programmable overcurrent protection levels and hiccup overcurrent fault recovery maximize design flexibility and minimize power dissipation in the event of a prolonged output short. Frequency Spread Spectrum (FSS) feature reduces peak EMI noise by spreading the initial energy of each harmonic along a frequency band, thus giving a wider spectrum with lower amplitudes.

Voltage Reference

The 591-mV band gap cell is internally connected to the non-inverting input of the error amplifier. The reference voltage is trimmed with the error amplifier in a unity gain configuration to remove amplifier offset from the final regulation voltage. The 1% tolerance on the reference voltage allows the user to design a very accurate power supply.

Enable Functionality, Startup Sequence and Timing

After input power is applied, an internal current source of 40 μA starts to charge up the soft-start capacitor connected from EN/SS to GND. When the voltage across that capacitor increases to 0.7 V, it enables the internal BP regulator followed by a calibration. The total calibration time is about 1.9 ms. See Figure 11. During the calibration, the device performs in the following way. It disables the LDRV drive and injects an internal 10 μA current source to the resistor connected from LDRV to GND. The voltage developed across that resistor is then sampled and latched internally as the OCP trip level until one cycles the input or toggles the EN/SS.

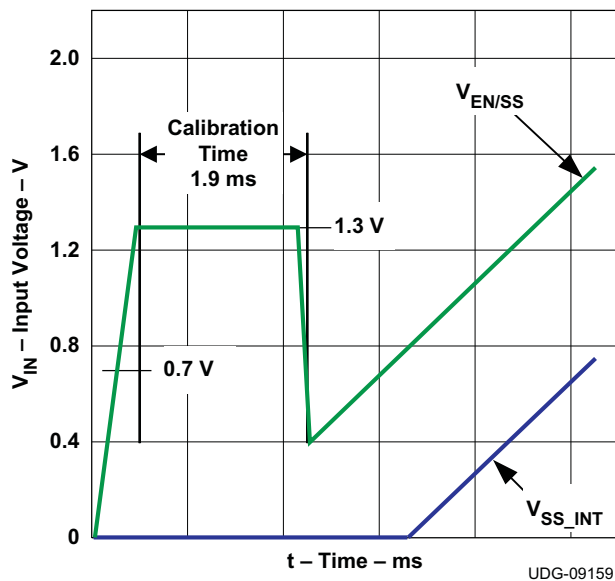

Figure 11. Startup Sequence and Timing

The voltage at EN/SS is internally clamped to 1.3 V before and/or during calibration to minimize the discharging time once calibration is complete. The discharging current is from an internal current source of 140 μA and it pulls the voltage down to 0.4 V. It then initiates the soft-start by charging up the capacitor using an internal current source of 10 μA . The resulting voltage ramp on this pin is used as a second non-inverting input to the error amplifier after an 800 mV (typical) downward level-shift; therefore, actual soft-start will not take place until the voltage at this pin reaches 800 mV.

If EN/SS is left floating, the controller starts automatically. EN/SS must be pulled down to less than 270 mV to guarantee that the chip is in shutdown mode.

Soft-Start Time

The soft-start time of the TPS40304A is user programmable by selecting a single capacitor. The EN/SS pin sources 10 μA to charge this capacitor. The actual output ramp-up time is the amount of time that it takes for the 10 μA to charge the capacitor through a 591-mV range. There is some initial lag due to calibration and an offset (800 mV) from the actual EN/SS pin voltage to the voltage applied to the error amplifier.

The soft-start is done in a closed loop fashion, meaning that the error amplifier controls the output voltage at all times during the soft start period and the feedback loop is never open as occurs in duty cycle limit soft-start schemes. The error amplifier has two non-inverting inputs, one connected to the 591-mV reference voltage, and the other connected to the offset EN/SS pin voltage. The lower of these two voltages is what the error amplifier controls the FB pin to. As the voltage on the EN/SS pin ramps up past approximately 1.4 V (800 mV offset voltage plus the 591-mV reference voltage), the 591-mV reference voltage becomes the dominant input and the converter has reached its final regulation voltage.

The capacitor required for a given soft-start ramp time for the output voltage is given by [Equation 1](#).

$$C_{SS} = \left(\frac{I_{SS}}{V_{FB}} \right) \times t_{SS}$$

where

- C_{SS} is the required capacitance on the EN/SS pin (F)
 - I_{SS} is the soft-start source current (10 μA)
 - V_{FB} is the feedback reference voltage (591 mV)
 - t_{SS} is the desired soft-start ramp time (s)
- (1)

Oscillator and Frequency Spread Spectrum (FSS)

The oscillator frequency is internally fixed at 600 kHz.

Connecting a resistor with a value of 267 $\text{k}\Omega \pm 10\%$ from BP to EN/SS enables the FSS feature. When enabled, it spreads the internal oscillator frequency over a minimum 12% window using a 25-kHz modulation frequency with triangular profile. By modulating the switching frequency, side-bands are created. The emission power of the fundamental switching frequency and its harmonics is distributed into smaller pieces scattered around many side-band frequencies. The effect significantly reduces the peak EMI noise and makes it much easier for the resultant emission spectrum to pass EMI regulations.

Overcurrent Protection

Programmable OCP level at LDRV is from 6 mV to 150 mV at room temperature with 3000 ppm temperature coefficient to help compensate for changes in the low-side FET channel resistance as temperature increases. With a scale factor of 2, the actual trip point across the low-side FET is in the range of 12 mV to 300 mV. The accuracy of the internal current source is $\pm 5\%$. Overall offset voltage, including the offset voltage of the internal comparator and the amplifier for scale factor of 2, is limited to ± 8 mV.

Maximum clamp voltage at LDRV is 340 mV to avoid turning on the low-side FET during calibration and in a pre-biased condition. The maximum clamp voltage is fixed and it does not change with temperature. If the voltage drop across R_{OCSET} reaches the 340 mV maximum clamp voltage during calibration (No R_{OCSET} resistor included), it disables OCP. Once disabled, there is no low-side or high-side current sensing.

OCP level at HDRV is fixed at 450 mV with 3000 ppm temperature coefficient to help compensate for changes in the high-side FET channel resistance as temperature increases. OCP at HDRV provides pulse-by-pulse current limiting.

OCP sensing at LDRV is a true inductor valley current detection, using sample and hold. Equation 2 can be used to calculate R_{OCSET} :

$$R_{OCSET} = \left(\frac{\left(I_{OUT(max)} - \left(\frac{I_{P-P}}{2} \right) \right) \times R_{DS(on)} - V_{OCLOS}}{2 \times I_{OCSET}} \right)$$

where

- I_{OCSET} is the internal current source
- V_{OCLOS} is the overall offset voltage
- I_{P-P} is the peak-to-peak inductor current
- $R_{DS(on)}$ is the drain to source on-resistance of the low-side FET
- $I_{OUT(max)}$ is the trip point for OCP
- R_{OCSET} is the resistor used for setting the OCP level (2)

To avoid overcurrent tripping in normal operating load range, calculate R_{OCSET} using the equation above with:

- The maximum $R_{DS(ON)}$ at room temperature
- The lower limit of V_{OCLOS} (–8 mV) and the lower limit of I_{OCSET} (9.5 μ A) from the *Electrical Characteristics* table.
- The peak-to-peak inductor current I_{P-P} at minimum input voltage

Overcurrent is sensed across both the low-side FET and the high-side FET. If the voltage drop across either FET exceeds the OC threshold, a count increments one count. If no OC is detected on either FET, the fault counter decrements by one count. If three OC pulses are summed, a fault condition is declared which cycles the soft-start function in a hiccup mode. Hiccup mode consists of four dummy soft-start timeouts followed by a real one if overcurrent condition is encountered during normal operation, or five dummy soft-start timeouts followed by a real one if overcurrent condition occurs from the beginning during start. This cycle continues indefinitely until the fault condition is removed.

Drivers

The drivers for the external high-side and low-side MOSFETs are capable of driving a gate-to-source voltage of V_{BP} . The LDRV driver for the low-side MOSFET switches between BP and GND, while HDRV driver for the high-side MOSFET is referenced to SW and switches between BOOT and SW. The drivers have non-overlapping timing that is governed by an adaptive delay circuit to minimize body diode conduction in the synchronous rectifier.

Pre-Bias Startup

The TPS40304A contains a circuit to prevent current from being pulled from the output during startup in the condition the output is pre-biased. There are no PWM pulses until the internal soft-start voltage rises above the error amplifier input (FB pin), if the output is pre-biased. Once the soft-start voltage exceeds the error amplifier input, the controller slowly initiates synchronous rectification by starting the synchronous rectifier with a narrow on time. It then increments that on time on a cycle-by-cycle basis until it coincides with the time dictated by $(1-D)$, where D is the duty cycle of the converter. This approach prevents the sinking of current from a pre-biased output, and ensures the output voltage startup and ramp to regulation is smooth and controlled.

Power Good

The TPS40304A provides an indication that output is good for the converter. This is an open drain signal and pulls low when any condition exists that would indicate that the output of the supply might be out of regulation. These conditions include the following:

- V_{FB} is more than $\pm 12.5\%$ from nominal
- Soft-start is active
- A short circuit condition has been detected

NOTE

When there is no power to the device, PGOOD is not able to pull close to GND if an auxiliary supply is used for the power good indication. In this case, a built in resistor connected from drain to gate on the PGOOD pull down device makes the PGOOD pin look approximately like a diode to GND.

Thermal Shutdown

If the junction temperature of the device reaches the thermal shutdown limit of 145°C, the PWM and the oscillator are turned off and HDRV and LDRV are driven low. When the junction cools to the required level (125°C typical), the PWM initiates soft start as during a normal power-up cycle.

ADDITIONAL REFERENCES

Related Devices

The devices listed in have characteristics similar to the TPS40304A and may be of interest.

Table 1. Related Devices

DEVICE	DESCRIPTION
TPS40303/4/5	3-V to 20-V Input Synchronous Buck Controller

References

These references, design tools and links to additional references, including design software, may be found at <http://power.ti.com>

1. Additional PowerPAD™ information may be found in Applications Briefs ([SLMA002A](#)) and ([SLMA004](#)).
2. *Under The Hood Of Low Voltage DC/DC Converters* – SEM1500 Topic 5 – 2002 Seminar Series
3. *Understanding Buck Power Stages in Switchmode Power Supplies*, ([SLVA057](#)), March 1999
4. *Designing Stable Control Loops* – SEM 1400 – 2001 Seminar Series

Package Outline and Recommended PCB Footprint

The following pages outline the mechanical dimensions of the 10-pin DRC package and provide recommendations for PCB layout.

PACKAGING INFORMATION

Orderable Device	Status (1)	Package Type	Package Drawing	Pins	Package Qty	Eco Plan (2)	Lead finish/ Ball material (6)	MSL Peak Temp (3)	Op Temp (°C)	Device Marking (4/5)	Samples
TPS40304ADRCR	ACTIVE	VSON	DRC	10	3000	RoHS & Green	NIPDAUAG	Level-2-260C-1 YEAR	-40 to 145	304A	Samples
TPS40304ADRCT	ACTIVE	VSON	DRC	10	250	RoHS & Green	NIPDAUAG	Level-2-260C-1 YEAR	-40 to 145	304A	Samples

(1) The marketing status values are defined as follows:

ACTIVE: Product device recommended for new designs.

LIFEBUY: TI has announced that the device will be discontinued, and a lifetime-buy period is in effect.

NRND: Not recommended for new designs. Device is in production to support existing customers, but TI does not recommend using this part in a new design.

PREVIEW: Device has been announced but is not in production. Samples may or may not be available.

OBSOLETE: TI has discontinued the production of the device.

(2) **RoHS:** TI defines "RoHS" to mean semiconductor products that are compliant with the current EU RoHS requirements for all 10 RoHS substances, including the requirement that RoHS substance do not exceed 0.1% by weight in homogeneous materials. Where designed to be soldered at high temperatures, "RoHS" products are suitable for use in specified lead-free processes. TI may reference these types of products as "Pb-Free".

RoHS Exempt: TI defines "RoHS Exempt" to mean products that contain lead but are compliant with EU RoHS pursuant to a specific EU RoHS exemption.

Green: TI defines "Green" to mean the content of Chlorine (Cl) and Bromine (Br) based flame retardants meet JS709B low halogen requirements of <=1000ppm threshold. Antimony trioxide based flame retardants must also meet the <=1000ppm threshold requirement.

(3) MSL, Peak Temp. - The Moisture Sensitivity Level rating according to the JEDEC industry standard classifications, and peak solder temperature.

(4) There may be additional marking, which relates to the logo, the lot trace code information, or the environmental category on the device.

(5) Multiple Device Markings will be inside parentheses. Only one Device Marking contained in parentheses and separated by a "~" will appear on a device. If a line is indented then it is a continuation of the previous line and the two combined represent the entire Device Marking for that device.

(6) Lead finish/Ball material - Orderable Devices may have multiple material finish options. Finish options are separated by a vertical ruled line. Lead finish/Ball material values may wrap to two lines if the finish value exceeds the maximum column width.

Important Information and Disclaimer:The information provided on this page represents TI's knowledge and belief as of the date that it is provided. TI bases its knowledge and belief on information provided by third parties, and makes no representation or warranty as to the accuracy of such information. Efforts are underway to better integrate information from third parties. TI has taken and continues to take reasonable steps to provide representative and accurate information but may not have conducted destructive testing or chemical analysis on incoming materials and chemicals. TI and TI suppliers consider certain information to be proprietary, and thus CAS numbers and other limited information may not be available for release.

In no event shall TI's liability arising out of such information exceed the total purchase price of the TI part(s) at issue in this document sold by TI to Customer on an annual basis.

TAPE AND REEL INFORMATION

QUADRANT ASSIGNMENTS FOR PIN 1 ORIENTATION IN TAPE

*All dimensions are nominal

Device	Package Type	Package Drawing	Pins	SPQ	Reel Diameter (mm)	Reel Width W1 (mm)	A0 (mm)	B0 (mm)	K0 (mm)	P1 (mm)	W (mm)	Pin1 Quadrant
TPS40304ADRCR	VSON	DRC	10	3000	330.0	12.4	3.3	3.3	1.1	8.0	12.0	Q2
TPS40304ADRCT	VSON	DRC	10	250	180.0	12.4	3.3	3.3	1.1	8.0	12.0	Q2

TAPE AND REEL BOX DIMENSIONS

*All dimensions are nominal

Device	Package Type	Package Drawing	Pins	SPQ	Length (mm)	Width (mm)	Height (mm)
TPS40304ADRCR	VSON	DRC	10	3000	356.0	356.0	35.0
TPS40304ADRCT	VSON	DRC	10	250	210.0	185.0	35.0

GENERIC PACKAGE VIEW

DRC 10

VSON - 1 mm max height

3 x 3, 0.5 mm pitch

PLASTIC SMALL OUTLINE - NO LEAD

This image is a representation of the package family, actual package may vary.
Refer to the product data sheet for package details.

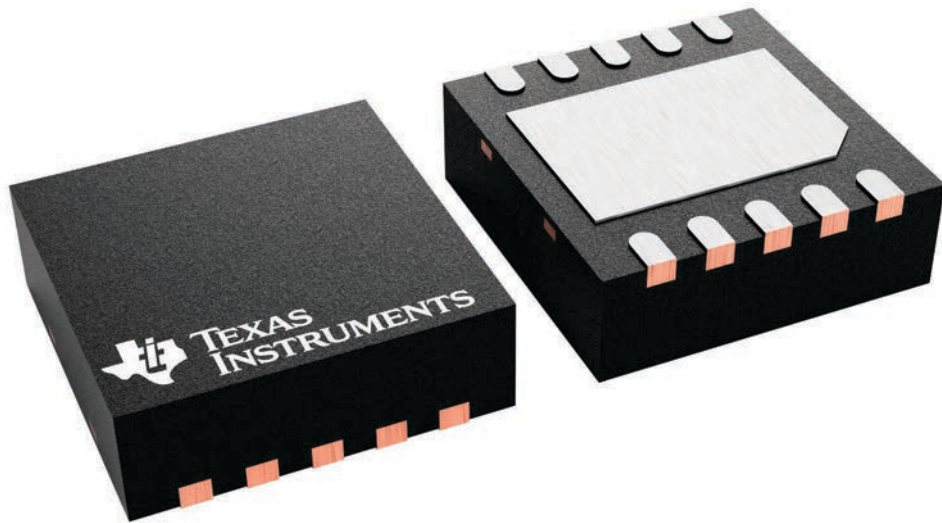

4226193/A

EXAMPLE BOARD LAYOUT

DRC0010J

VSON - 1 mm max height

PLASTIC SMALL OUTLINE - NO LEAD



LAND PATTERN EXAMPLE
EXPOSED METAL SHOWN
SCALE:20X



SOLDER MASK DETAILS

4218878/B 07/2018

NOTES: (continued)

4. This package is designed to be soldered to a thermal pad on the board. For more information, see Texas Instruments literature number SLUA271 (www.ti.com/lit/sluea271).
5. Vias are optional depending on application, refer to device data sheet. If any vias are implemented, refer to their locations shown on this view. It is recommended that vias under paste be filled, plugged or tented.

EXAMPLE STENCIL DESIGN

DRC0010J

VSON - 1 mm max height

PLASTIC SMALL OUTLINE - NO LEAD

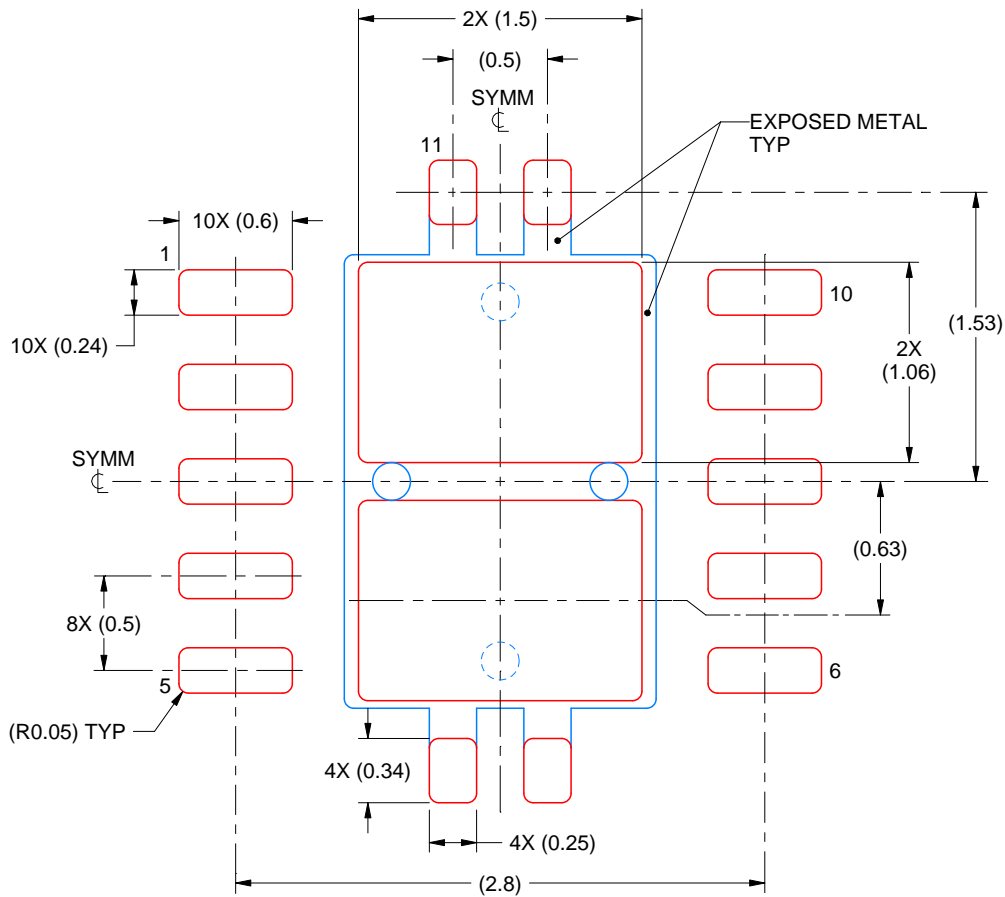

SOLDER PASTE EXAMPLE
BASED ON 0.125 mm THICK STENCIL

EXPOSED PAD 11:
80% PRINTED SOLDER COVERAGE BY AREA
SCALE:25X

4218878/B 07/2018

NOTES: (continued)

6. Laser cutting apertures with trapezoidal walls and rounded corners may offer better paste release. IPC-7525 may have alternate design recommendations.

IMPORTANT NOTICE AND DISCLAIMER

TI PROVIDES TECHNICAL AND RELIABILITY DATA (INCLUDING DATA SHEETS), DESIGN RESOURCES (INCLUDING REFERENCE DESIGNS), APPLICATION OR OTHER DESIGN ADVICE, WEB TOOLS, SAFETY INFORMATION, AND OTHER RESOURCES "AS IS" AND WITH ALL FAULTS, AND DISCLAIMS ALL WARRANTIES, EXPRESS AND IMPLIED, INCLUDING WITHOUT LIMITATION ANY IMPLIED WARRANTIES OF MERCHANTABILITY, FITNESS FOR A PARTICULAR PURPOSE OR NON-INFRINGEMENT OF THIRD PARTY INTELLECTUAL PROPERTY RIGHTS.

These resources are intended for skilled developers designing with TI products. You are solely responsible for (1) selecting the appropriate TI products for your application, (2) designing, validating and testing your application, and (3) ensuring your application meets applicable standards, and any other safety, security, regulatory or other requirements.

These resources are subject to change without notice. TI grants you permission to use these resources only for development of an application that uses the TI products described in the resource. Other reproduction and display of these resources is prohibited. No license is granted to any other TI intellectual property right or to any third party intellectual property right. TI disclaims responsibility for, and you will fully indemnify TI and its representatives against, any claims, damages, costs, losses, and liabilities arising out of your use of these resources.

TI's products are provided subject to [TI's Terms of Sale](#) or other applicable terms available either on [ti.com](https://www.ti.com) or provided in conjunction with such TI products. TI's provision of these resources does not expand or otherwise alter TI's applicable warranties or warranty disclaimers for TI products.

TI objects to and rejects any additional or different terms you may have proposed.

Mailing Address: Texas Instruments, Post Office Box 655303, Dallas, Texas 75265
Copyright © 2024, Texas Instruments Incorporated