

TPS568215 4.5V~17V 入力、8A 同期整流降圧型 SWIFT™ コンバータ

1 特長

- 19mΩ / 9.4mΩ の MOSFET を内蔵
- F_{SW} として 400kHz、800kHz、1.2MHz を選択可能
- 可変電流制限設定、ヒックアップ再起動機能付き
- 温度範囲全体にわたって $\pm 1\%$ 精度の 0.6V 基準電圧
- 外部の 5V バイアスのサポートによる効率向上 (オプション)
- D-CAP3™ 制御モードによる高速過渡応答
- 厳しい出力電圧リップルに対応する強制連続導通モード (FCCM) と、軽負荷時に効率性を上げる自動スキップ Eco-mode™ から選択可能
- 0.6V~5.5V の出力電圧範囲
- すべてのセラミック・コンデンサに対応
- プリバイアスされた出力への単調なスタートアップ
- 可変ソフトスタート、デフォルトのソフトスタート時間は 1ms
- 動作時接合部温度: -40°C~150°C
- 小型の 3.5mm × 3.5mm HotRod™ QFN パッケージ
- 8A の [TPS568231](#) および 12-A [TPS56C231](#) および [TPS56C215](#) とピン互換
- WEBENCH® 設計センターでのサポート

2 アプリケーション

- サーバーおよびストレージ
- セットトップ・ボックス、ハイエンド DTV
- テレコムおよびネットワークング、ポイント・オブ・ロード (POL)

- IPC、ファクトリ・オートメーション

3 概要

TPS568215 はテキサス・インスツルメンツで最小のモノリシック、8A 同期整流降圧型コンバータで、アダプティブ・オンタイム D-CAP3™ 制御モードが搭載されています。このデバイスは、低 $R_{DS(on)}$ のパワー MOSFET を内蔵して高効率を実現し、外付け部品数が最小になるため、スペースの制約が厳しい電力システムでも使いやすくなっています。主要な機能として、非常に正確な基準電圧、高速負荷過渡応答、自動スキップ・モードの動作による軽負荷時の高効率、可変の電流制限、外部補償が不要なことが挙げられます。強制連続導通モードにより、高性能 DSP や FPGA に求められる厳しい電圧レギュレーション精度要件を満たすことができます。TPS568215 は放熱特性の優れた 18 ピン HotRod QFN パッケージで供給され、-40°C~150°C の接合部温度で動作するよう設計されています。TPS568215 は TPS56C215 とピン互換性があり、同じ占有面積で 6A~12A のソリューションを柔軟に選択できます。

パッケージ情報

| 部品番号 | パッケージ (1) | 本体サイズ (公称) |
|-----------|----------------|---------------|
| TPS568215 | RNN (VQFN, 18) | 3.5mm × 3.5mm |

- (1) 利用可能なすべてのパッケージについては、データシートの末尾にある注文情報を参照してください。

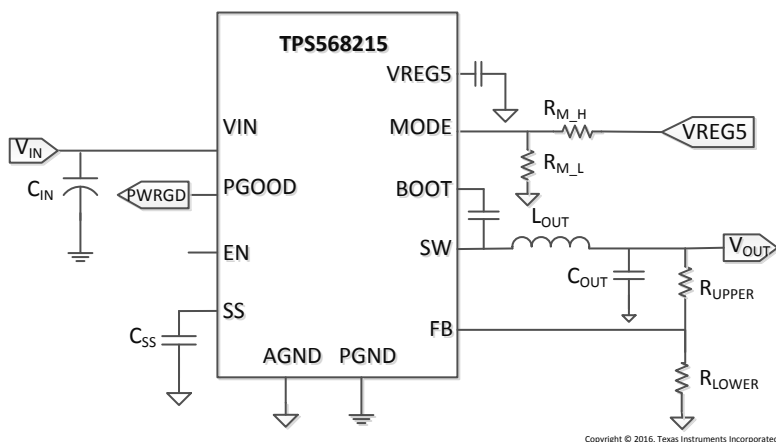

Copyright © 2016, Texas Instruments Incorporated

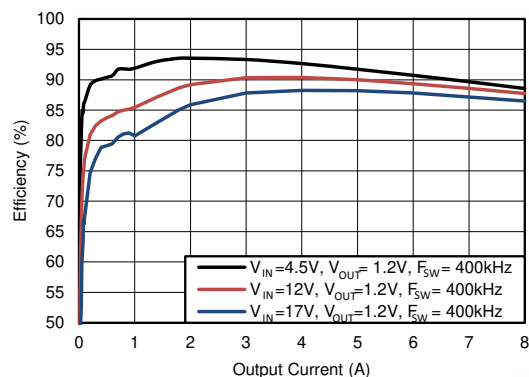

Table of Contents

| | | | |
|--|----|--|----|
| 1 特長 | 1 | 7.3 Feature Description..... | 13 |
| 2 アプリケーション | 1 | 7.4 Device Functional Modes..... | 18 |
| 3 概要 | 1 | 8 Application and Implementation | 19 |
| 4 Revision History | 2 | 8.1 Application Information..... | 19 |
| 5 Pin Configuration and Functions | 3 | 8.2 Typical Application..... | 19 |
| 6 Specifications | 4 | 8.3 Power Supply Recommendations..... | 24 |
| 6.1 Absolute Maximum Ratings..... | 4 | 8.4 Layout..... | 25 |
| 6.2 ESD Ratings..... | 4 | 9 Device and Documentation Support | 28 |
| 6.3 Recommended Operating Conditions..... | 4 | 9.1 Device Support..... | 28 |
| 6.4 Thermal Information..... | 5 | 9.2 ドキュメントの更新通知を受け取る方法..... | 28 |
| 6.5 Electrical Characteristics..... | 5 | 9.3 サポート・リソース..... | 28 |
| 6.6 Timing Requirements..... | 6 | 9.4 Trademarks..... | 28 |
| 6.7 Typical Characteristics..... | 7 | 9.5 静電気放電に関する注意事項..... | 28 |
| 7 Detailed Description | 11 | 9.6 用語集..... | 28 |
| 7.1 Overview..... | 11 | 10 Mechanical, Packaging, and Orderable Information | 28 |
| 7.2 Functional Block Diagram..... | 12 | | |

4 Revision History

資料番号末尾の英字は改訂を表しています。その改訂履歴は英語版に準じています。

Changes from Revision B (August 2023) to Revision C (August 2023) Page

- 「特長」一覧にピン互換のデータシートのリンクを追加 1

Changes from Revision A (October 2016) to Revision B (August 2023) Page

- ドキュメント全体にわたって表、図、相互参照の採番方法を更新..... 1
- 「特長」一覧を、ピン互換デバイスで更新 1

Changes from Revision * (October 2016) to Revision A (October 2016) Page

- 「製品プレビュー」から「量産データ」のリリースに変更..... 1
- Changed  image 14

5 Pin Configuration and Functions



图 5-1. RNN Package 18-Pin VQFN

表 5-1. Pin Functions

| PIN | | I/O | DESCRIPTION |
|-------------------|-------|-----|--|
| NO. | NAME | | |
| 1 | BOOT | I | Supply input for the gate drive voltage of the high-side MOSFET. Connect a 0.1- μ F bootstrap capacitor between BOOT and SW. |
| 2,11 | VIN | P | Input voltage supply pin for the control circuitry. Connect the input decoupling capacitors between VIN and PGND. |
| 3, 4, 5, 8, 9, 10 | PGND | G | Power GND terminal for the controller circuit and the internal circuitry. |
| 6, 7 | SW | O | Switch node terminal. Connect the output inductor to this pin. |
| 12 | AGND | G | Ground of internal analog circuitry. Connect AGND to PGND plane. |
| 13 | FB | I | Converter feedback input. Connect to the resistor divider between output voltage and AGND. |
| 14 | SS | O | Soft-Start time selection pin. Connecting an external capacitor sets the soft-start time and if no external capacitor is connected, the soft-start time in 1ms. |
| 15 | EN | I | Enable input control, leaving this pin floating enables the converter. It can also be used to adjust the input UVLO by connecting to the resistor divider between VIN and EN. |
| 16 | PGOOD | O | Open Drain Power Good Indicator, it is asserted low if output voltage is out of PGOOD threshold, Overvoltage or if the device is under thermal shutdown, EN shutdown or during soft start. |
| 17 | VREG5 | I/O | 4.7-V internal LDO output which can also be driven externally with a 5V input. This pin supplies voltage to the internal circuitry and gate driver. Bypass this pin with a 4.7- μ F capacitor. |
| 18 | MODE | I | Switching Frequency, Current Limit selection and Light load operation mode selection pin. Connect this pin to a resistor divider from VREG5 and AGND for different MODE options shown in table 4. |

6 Specifications

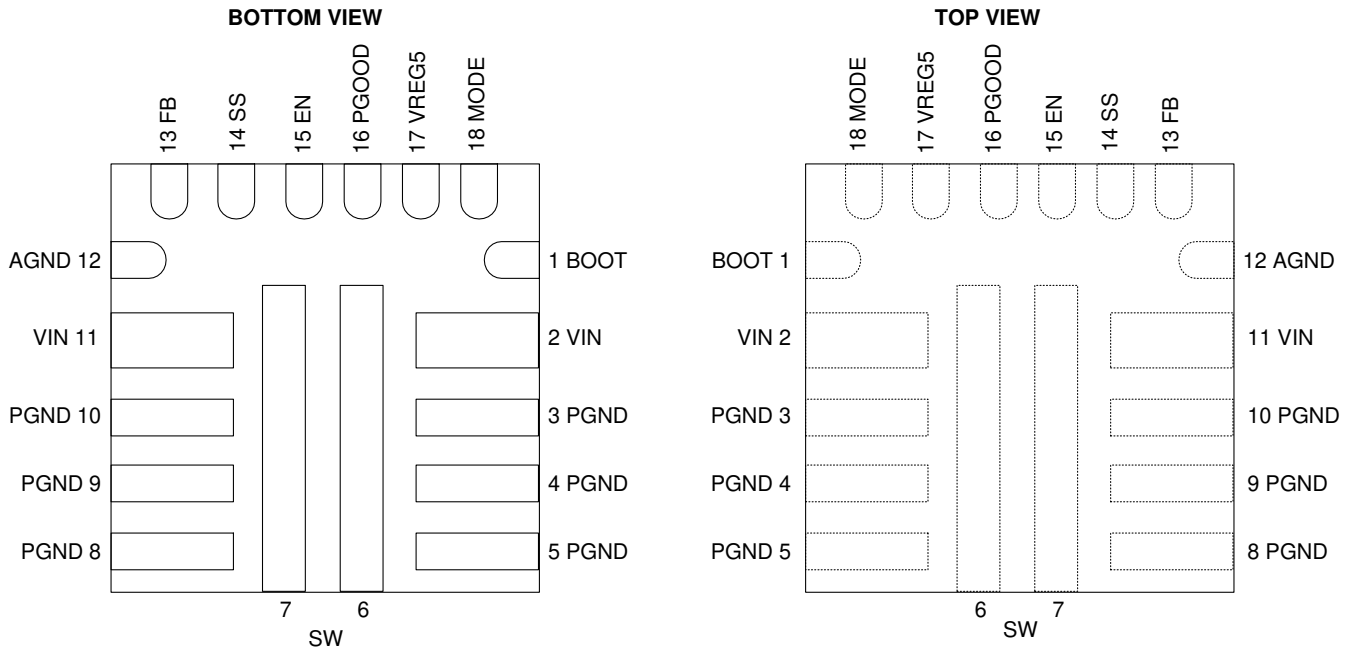
6.1 Absolute Maximum Ratings

over operating free-air temperature range (unless otherwise noted) ⁽¹⁾

| | | MIN | MAX | UNIT |
|-------------------------------|--------------------------------|------|------|------|
| Input Voltage | V _{IN} | -0.3 | 20 | V |
| | SW | -2 | 19 | |
| | SW(10 ns transient) | -3 | 20 | |
| | EN | -0.3 | 6.5 | |
| | BOOT –SW | -0.3 | 6.5 | |
| | BOOT | -0.3 | 25.5 | |
| | SS, MODE, FB | -0.3 | 6.5 | |
| | VREG5 | -0.3 | 6 | |
| Output Voltage | PGOOD | -0.3 | 6.5 | V |
| Output Current ⁽²⁾ | I _{OUT} | | 10 | A |
| T _J | Operating junction temperature | -40 | 150 | °C |
| T _{stg} | Storage temperature | -55 | 150 | °C |

- Stresses beyond those listed under *Absolute Maximum Ratings* may cause permanent damage to the device. These are stress ratings only, which do not imply functional operation of the device at these or any other conditions beyond those indicated under *Recommended Operating Conditions*. Exposure to absolute-maximum-rated conditions for extended periods may affect device reliability.
- To be consistent with the TI reliability requirement of 100k Power-On-Hours at 105°C junction temperature, the output current must not exceed 10A continuously under 100% duty operation as to prevent electromigration failure in the solder. Higher junction temperature or longer power-on hours are achievable at lower than 10A continuous output current.

6.2 ESD Ratings

| | | VALUE | UNIT |
|--|--|-------|------|
| V _(ESD) Electrostatic discharge | Human-body model (HBM), per ANSI/ESDA/JEDEC JS-001 ⁽¹⁾ | ±2000 | V |
| | Charged-device model (CDM), per JEDEC specification JESD22-C101 ⁽²⁾ | ±500 | |

- JEDEC document JEP155 states that 500-V HBM allows safe manufacturing with a standard ESD control process.
- JEDEC document JEP157 states that 250-V CDM allows safe manufacturing with a standard ESD control process.

6.3 Recommended Operating Conditions

over operating free-air temperature range (unless otherwise noted)

| | | MIN | NOM | MAX | UNIT |
|--------------------------------|-------------------|------|-----|------|------|
| Input Voltage | V _{IN} | 4.5 | | 17 | V |
| | SW | -1.8 | | 17 | |
| | BOOT | -0.1 | | 23.5 | |
| | VREG5 | -0.1 | | 5.2 | |
| Output Current | I _{LOAD} | 0 | | 8 | A |
| Operating junction temperature | T _J | -40 | | 150 | °C |

6.4 Thermal Information

| THERMAL METRIC ⁽¹⁾ | | RNN PACKAGE | UNIT |
|-------------------------------|--|-------------|------|
| | | 18 PINS | |
| R _{θJA} | Junction-to-ambient thermal resistance | 42.3 | °C/W |
| R _{θJC(top)} | Junction-to-case (top) thermal resistance | 23.9 | °C/W |
| R _{θJB} | Junction-to-board thermal resistance | 10.0 | °C/W |
| Ψ _{JT} | Junction-to-top characterization parameter | 0.5 | °C/W |
| Ψ _{JB} | Junction-to-board characterization parameter | 10.0 | °C/W |
| R _{θJC(bot)} | Junction-to-case (bottom) thermal resistance | 0.5 | °C/W |

(1) For more information about traditional and new thermal metrics, see the [Semiconductor and IC Package Thermal Metrics](#) application report.

6.5 Electrical Characteristics

T_J = -40°C to 150°C, V_{IN}=12V (unless otherwise noted)

| PARAMETER | | CONDITIONS | MIN | TYP | MAX | UNIT |
|---------------------------------------|-----------------------------------|--|-------|-------|-------|-------------------|
| SUPPLY CURRENT | | | | | | |
| I _{IN} | V _{IN} supply current | T _J = 25°C, V _{EN} =5 V, non switching | | 600 | 700 | μA |
| I _{VINSDN} | V _{IN} shutdown current | T _J = 25°C, V _{EN} =0 V | | 7 | | μA |
| LOGIC THRESHOLD | | | | | | |
| V _{ENH} | EN H-level threshold voltage | | 1.175 | 1.225 | 1.3 | V |
| V _{ENL} | EN L-level threshold voltage | | 1.025 | 1.104 | 1.15 | V |
| V _{ENHYS} | | | | 0.121 | | V |
| I _{ENp1} | EN pull-up current | V _{EN} = 1.0 V | 0.35 | 1.91 | 2.95 | μA |
| I _{ENp2} | | V _{EN} = 1.3 V | 3 | 4.197 | 5.5 | μA |
| FEEDBACK VOLTAGE | | | | | | |
| V _{FB} | FB voltage | T _J = 25°C | 598 | 600 | 602 | mV |
| | | T _J = 0°C to 85°C | 597.5 | 600 | 602.5 | mV |
| | | T _J = -40°C to 85°C | 594 | 600 | 602.5 | mV |
| | | T _J = -40°C to 150°C | 594 | 600 | 606 | mV |
| LDO VOLTAGE | | | | | | |
| V _{REG5} | LDO Output voltage | T _J = -40°C to 150°C | 4.58 | 4.7 | 4.83 | V |
| I _{LIM5} | LDO Output Current limit | T _J = -40°C to 150°C | 100 | 150 | 200 | mA |
| MOSFET | | | | | | |
| R _{DS(on)H} | High side switch resistance | T _J = 25°C, V _{VREG5} = 4.7 V | | 19 | | mΩ |
| R _{DS(on)L} | Low side switch resistance | T _J = 25°C, V _{VREG5} = 4.7 V | | 9.4 | | mΩ |
| SOFT START | | | | | | |
| I _{SS} | Soft start charge current | T _J = -40°C to 150°C | 4.9 | 6 | 7.1 | μA |
| CURRENT LIMIT | | | | | | |
| I _{OCL} | Current Limit (Low side sourcing) | ILIM-1 option, Valley Current | 6 | 7.1 | 8.15 | A |
| | | ILIM option, Valley Current | 8 | 9.4 | 10.8 | A |
| | Current Limit (Low side negative) | Valley Current | | 3 | | A |
| POWER GOOD | | | | | | |
| V _{PGOODTH} | PGOOD threshold | V _{FB} falling (fault) | | 84% | | %V _{REF} |
| | | V _{FB} rising (good) | | 93% | | %V _{REF} |
| | | V _{FB} rising (fault) | | 116% | | %V _{REF} |
| | | V _{FB} falling (good) | | 107% | | %V _{REF} |
| OUTPUT UNDERVOLTAGE PROTECTION | | | | | | |

$T_J = -40^{\circ}\text{C}$ to 150°C , $V_{IN}=12\text{V}$ (unless otherwise noted)

| PARAMETER | | CONDITIONS | MIN | TYP | MAX | UNIT |
|-------------------------|----------------------------------|-----------------------|------|----------------------|-----|--------------------|
| V_{UVP} | Output UVP threshold | Hiccup detect | | $68\% \times V_{FB}$ | | |
| THERMAL SHUTDOWN | | | | | | |
| T_{SDN} | Thermal shutdown threshold | Shutdown temperature | | 160 | | $^{\circ}\text{C}$ |
| | | Hysteresis | | 15 | | $^{\circ}\text{C}$ |
| $T_{SDN\ VREG5}$ | VREG5 thermal shutdown threshold | Shutdown temperature | | 171 | | $^{\circ}\text{C}$ |
| | | Hysteresis | | 18 | | $^{\circ}\text{C}$ |
| UVLO | | | | | | |
| UVLO | UVLO threshold | VREG5 rising voltage | 4.1 | 4.3 | 4.5 | V |
| | | VREG5 falling voltage | 3.34 | 3.57 | 3.8 | V |
| | | VREG5 hysteresis | | 730 | | mV |

6.6 Timing Requirements

| PARAMETER | | CONDITIONS | MIN | TYP | MAX | UNIT |
|---|--|---|-----|-------|-----|-------|
| ON-TIME TIMER CONTROL | | | | | | |
| t_{ON} | SW On Time | $V_{IN} = 12\text{ V}$, $V_{OUT}=3.3\text{ V}$, $F_{SW} = 800\text{ kHz}$ | 310 | 340 | 380 | ns |
| $t_{ON\ min}$ | SW Minimum on time | $V_{IN} = 17\text{ V}$, $V_{OUT}=0.6\text{ V}$, $F_{SW}= 1200\text{ kHz}$ | | 54 | | ns |
| t_{OFF} | SW Minimum off time | 25°C , $V_{FB}=0.5\text{ V}$ | | | 310 | ns |
| SOFT START | | | | | | |
| t_{SS} | Soft start time | Internal soft start time | | 1.045 | | ms |
| OUTPUT UNDERVOLTAGE AND OVERVOLTAGE PROTECTION | | | | | | |
| t_{UVPDEL} | Output Hiccup delay relative to SS time | UVP detect | | 1 | | cycle |
| t_{UVPEN} | Output Hiccup enable delay relative to SS time | UVP detect | | 7 | | cycle |

6.7 Typical Characteristics

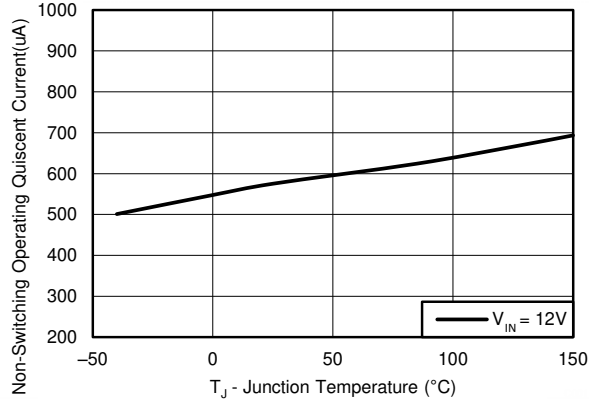

6-1. Quiescent Current vs Temperature

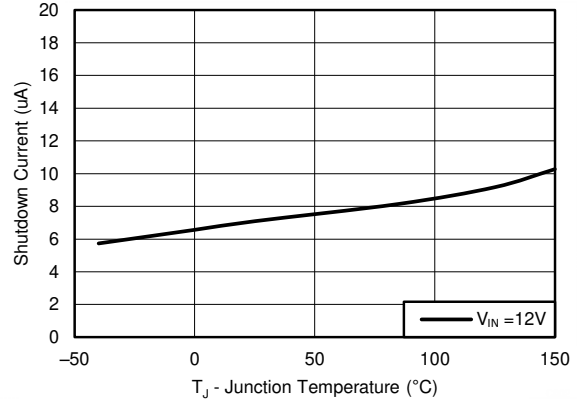

6-2. Shutdown Current vs Temperature

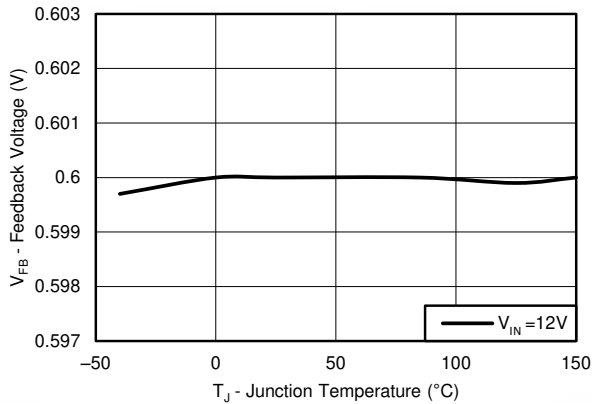

6-3. Feedback Voltage vs Temperature

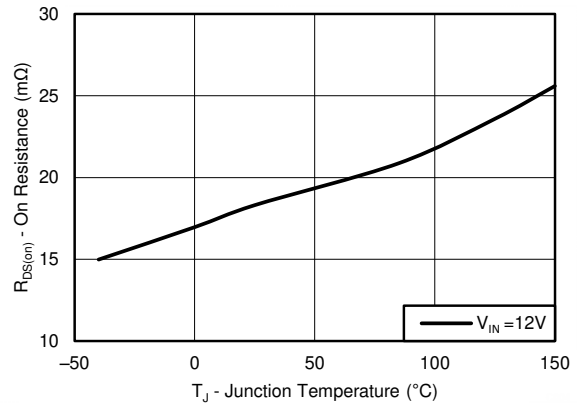

6-4. High-side R_{ds(on)} vs Temperature

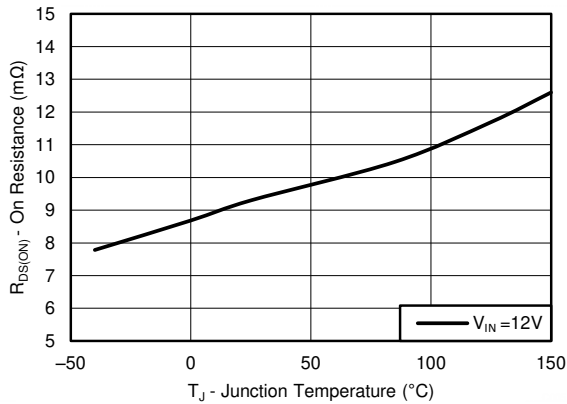

6-5. Low-side R_{ds(on)} vs Temperature

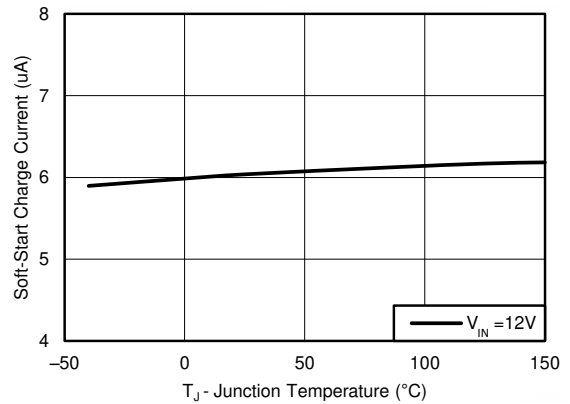

6-6. Soft-Start Charge Current vs Temperature

6.7 Typical Characteristics (continued)

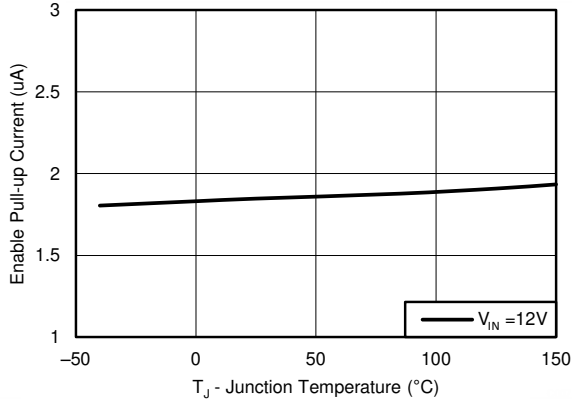

Figure 6-7. Enable Pull-Up Current, $V_{EN} = 1.0V$

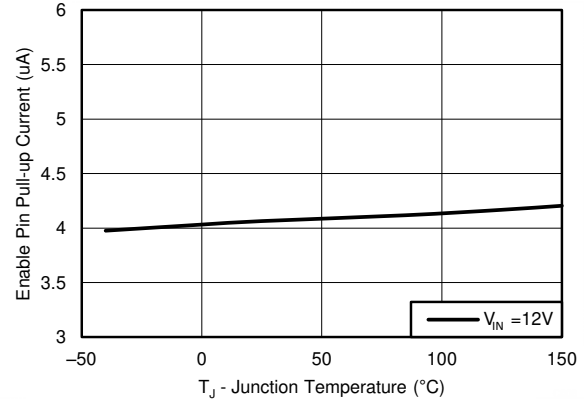

Figure 6-8. Enable Pull-Up Current, $V_{EN} = 1.3V$

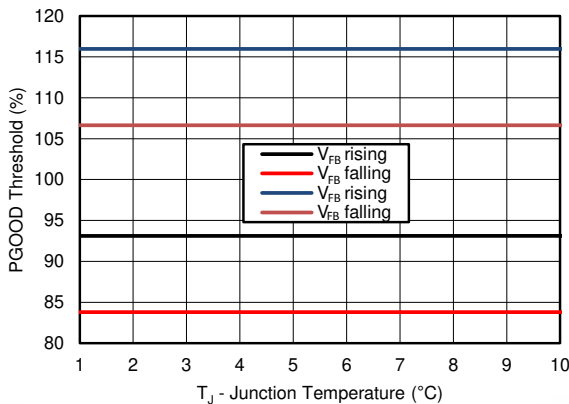

Figure 6-9. PGOOD Threshold vs Temperature

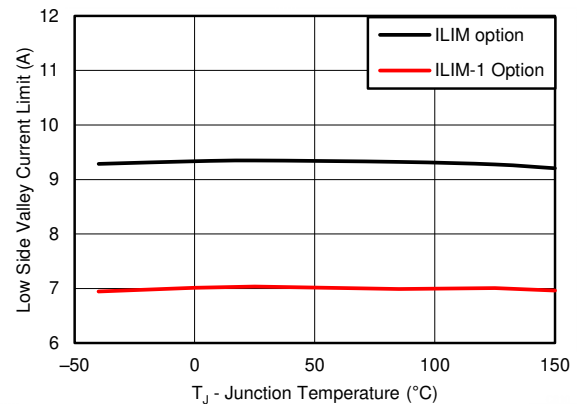

Figure 6-10. Valley Current Limit vs Temperature

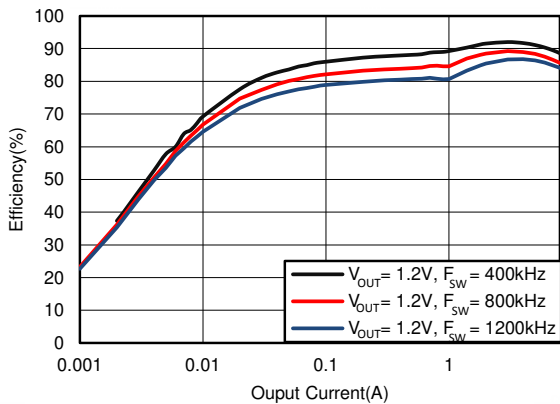

Figure 6-11. Efficiency with Internal VREG5 = 4.7 V, $V_{IN} = 12 V$

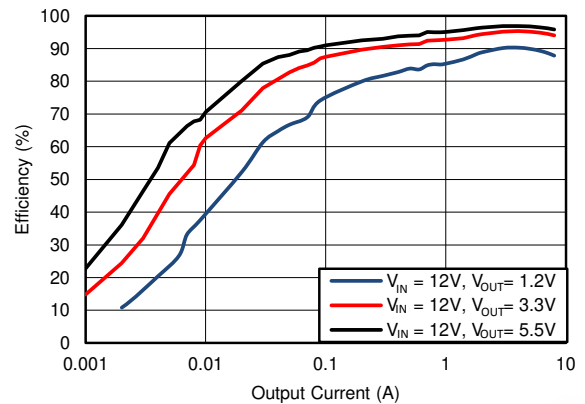
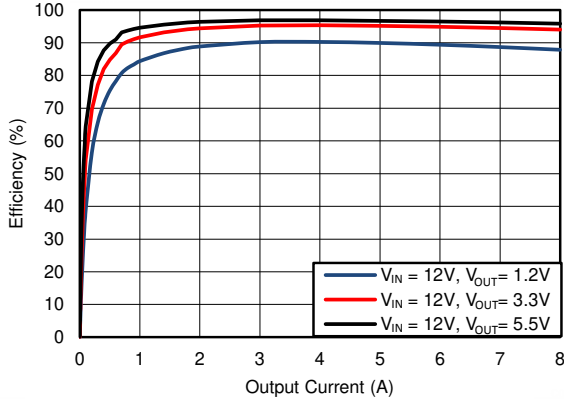
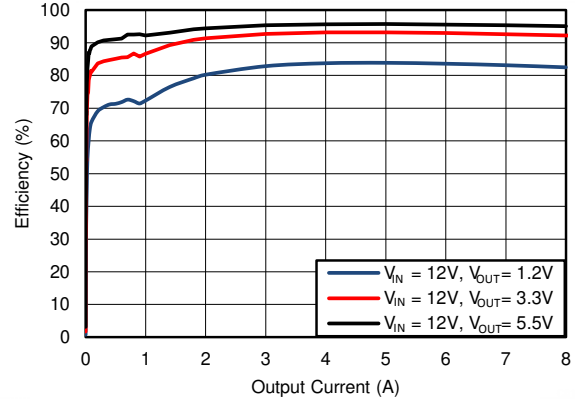

Figure 6-12. Efficiency, Mode = DCM, $F_{SW} = 400kHz$

6.7 Typical Characteristics (continued)



6-13. Efficiency, Mode = FCCM, $F_{SW} = 400\text{kHz}$



6-14. Efficiency, Mode = DCM, $F_{SW} = 1200\text{kHz}$

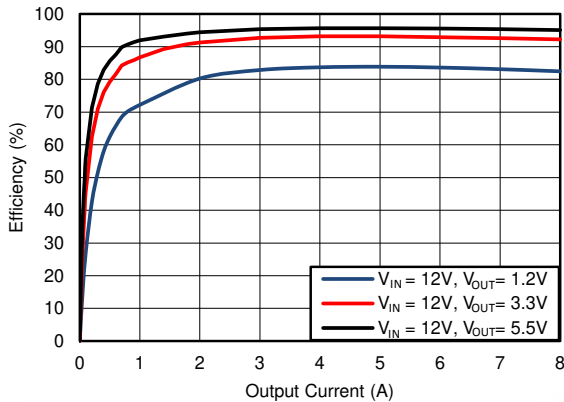

6-15. Efficiency, Mode = FCCM, $F_{SW} = 1200\text{kHz}$

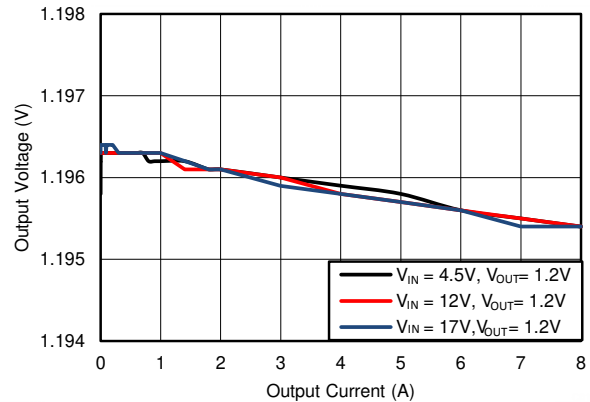

6-16. Load Regulation, $F_{SW} = 400\text{kHz}$

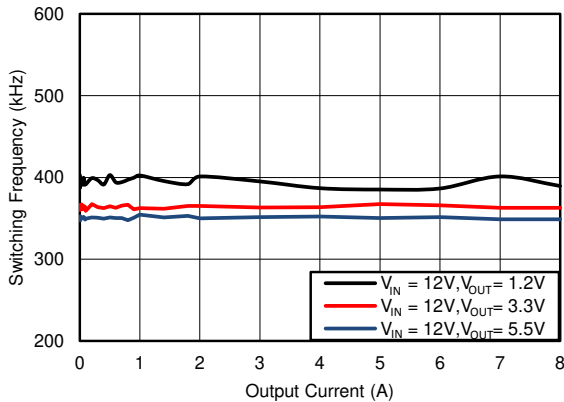

6-17. F_{SW} Load Regulation, Mode = FCCM, $F_{SW} = 400\text{kHz}$

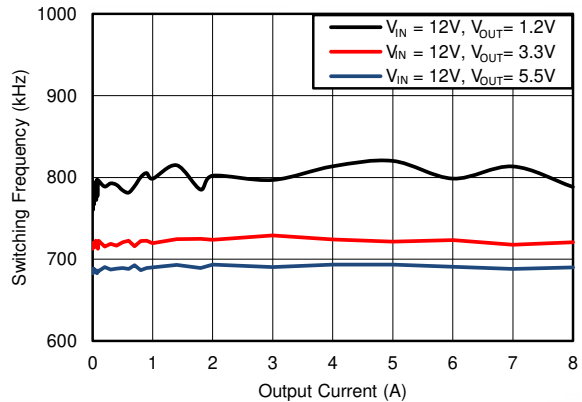

6-18. F_{SW} Load Regulation, Mode = FCCM, $F_{SW} = 800\text{kHz}$

6.7 Typical Characteristics (continued)

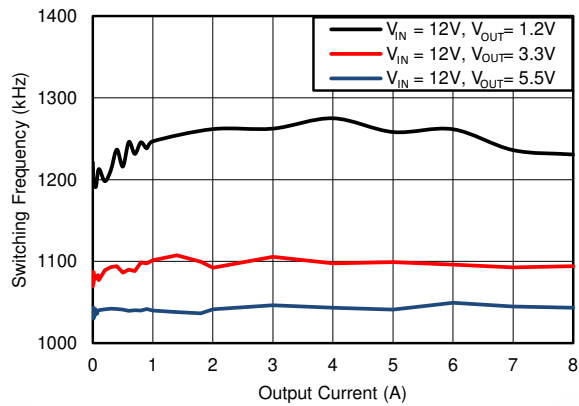

6-19. F_{SW} Load Regulation, Mode = FCCM, $F_{SW} = 1200\text{kHz}$

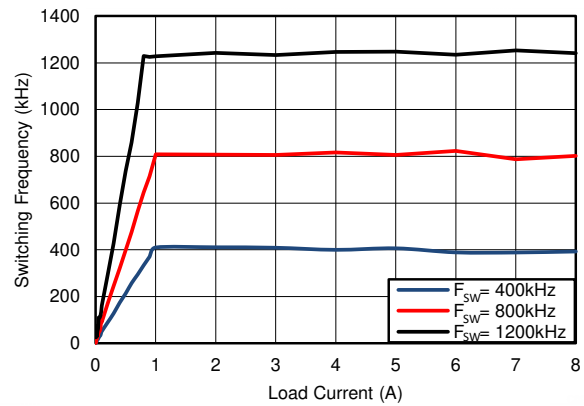

6-20. F_{SW} Load Regulation, Mode = DCM, $V_{IN} = 12\text{V}$, $V_{OUT} = 1.2\text{V}$

7 Detailed Description

7.1 Overview

The TPS568215 is a high-density, synchronous, step-down buck converter which can operate from 4.5-V to 17-V input voltage (V_{IN}). The device has 19-m Ω and 9-m Ω integrated MOSFETs that enable high efficiency up to 8 A. The device employs D-CAP3™ control mode that provides fast transient response with no external compensation components and an accurate feedback voltage. The control topology provides seamless transition between FCCM operating mode at higher load condition and DCM/Eco-mode™ operation at lighter load condition. DCM/Eco-mode™ allows the TPS568215 to maintain high efficiency at light load. The TPS568215 is able to adapt to both low equivalent series resistance (ESR) output capacitors such as POSCAP or SP-CAP, and ultra-low ESR ceramic capacitors.

The TPS568215 has three selectable switching frequencies (F_{SW}) 400 kHz, 800 kHz, and 1200 kHz which gives the flexibility to optimize the design for higher efficiency or smaller size. There are two selectable current limits. All these options are configured by choosing the right voltage on the MODE pin.

The TPS568215 has a 4.7-V internal LDO that creates bias for all internal circuitry. There is a feature to overdrive this internal LDO with an external voltage on the VREG5 pin which improves the converter efficiency. The undervoltage lockout (UVLO) circuit monitors the VREG5 pin voltage to protect the internal circuitry from low input voltages. The device has an internal pullup current source on the EN pin which can enable the device even with the pin floating.

Soft-start time can be selected by connecting a capacitor to the SS pin. The device is protected from output short, undervoltage, and overtemperature conditions.

7.3 Feature Description

7.3.1 PWM Operation and D-CAP3™ Control Mode

The TPS568215 operates using the adaptive on-time PWM control with a proprietary D-CAP3 control mode which enables low external component count with a fast load transient response while maintaining a good output voltage accuracy. At the beginning of each switching cycle the high side MOSFET is turned on for an on-time set by an internal one shot timer. This on-time is set based on the converter's input voltage, output voltage and the pseudo-fixed frequency hence this type of control topology is called an adaptive on-time control. The one shot timer resets and turns on again after the feedback voltage (V_{FB}) falls below the internal reference voltage (V_{REF}). An internal ramp is generated which is fed to the FB pin to simulate the output voltage ripple. This enables the use of very low-ESR output capacitors such as multi-layered ceramic caps (MLCC). No external current sense network or loop compensation is required for DCAP3™ control topology.

The TPS568215 includes an error amplifier that makes the output voltage very accurate. This error amplifier is absent in other flavors of D-CAP3 control mode. For any control topology that is compensated internally, there is a range of the output filter it can support. The output filter used with the TPS568215 is a low pass L-C circuit. This L-C filter has double pole that is described in

$$f_P = \frac{1}{2 \times \pi \times \sqrt{L_{OUT} \times C_{OUT}}} \quad (1)$$

At low frequencies, the overall loop gain is set by the output set-point resistor divider network and the internal gain of the TPS568215. The low frequency L-C double pole has a 180 degree in phase. At the output filter frequency, the gain rolls off at a -40dB per decade rate and the phase drops rapidly. The internal ripple generation network introduces a high-frequency zero that reduces the gain roll off from -40dB to -20dB per decade and increases the phase to 90 degree one decade above the zero frequency. The internal ripple injection high frequency zero is changed according to the switching frequency selected as shown in table below. The inductor and capacitor selected for the output filter must be such that the double pole is located close enough to the high-frequency zero so that the phase boost provided by this high-frequency zero provides adequate phase margin for the stability requirement. The crossover frequency of the overall system must usually be targeted to be less than one-fifth of the switching frequency (F_{SW}).

表 7-1. Ripple Injection Zero

| Switching Frequency (kHz) | Zero Location (kHz) |
|---------------------------|---------------------|
| 400 | 7.1 |
| 800 | 14.3 |
| 1200 | 21.4 |

表 7-2 lists the inductor values and part numbers that are used to plot the efficiency curves in the [セクション 6.7](#) section.

表 7-2. Inductor Values

| $V_{OUT}(V)$ | $F_{SW}(kHz)$ | $L_{OUT}(\mu H)$ | Würth Part Number ⁽¹⁾ |
|--------------|---------------|------------------|----------------------------------|
| 1.2 | 400 | 1.2 | 744325120 |
| | 800 | 0.68 | 744311068 |
| | 1200 | 0.47 | 744314047 |
| 3.3 | 400 | 2.4 | 744325240 |
| | 800 | 1.5 | 744314150 |
| | 1200 | 1.1 | 744314110 |

表 7-2. Inductor Values (continued)

| V _{OUT} (V) | F _{SW} (kHz) | L _{OUT} (μH) | Würth Part Number ⁽¹⁾ |
|----------------------|-----------------------|-----------------------|----------------------------------|
| 5.5 | 400 | 3.3 | 744325330 |
| | 800 | 2.4 | 744325240 |
| | 1200 | 1.2 | 744325120 |

(1) See [Third-Party Products](#) disclaimer

7.3.2 Eco-mode™ Control

The TPS568215 is designed with Eco-mode™ control to increase efficiency at light loads. This option can be chosen using the MODE pin as shown in table 3. As the output current decreases from heavy load condition, the inductor current is also reduced. If the output current is reduced enough, the valley of the inductor current reaches the zero level, which is the boundary between continuous conduction and discontinuous conduction modes. The low-side MOSFET is turned off when a zero inductor current is detected. As the load current further decreases the converter runs into discontinuous conduction mode. The on-time is kept approximately the same as it is in continuous conduction mode. The off-time increases as it takes more time to discharge the output with a smaller load current. The light load current where the transition to Eco-mode™ operation happens (I_{OUT(LL)}) can be calculated from 式 2.

$$I_{OUT(LL)} = \frac{1}{2 \times L_{OUT} \times F_{SW}} \times \frac{(V_{IN} - V_{OUT}) \times V_{OUT}}{V_{IN}} \quad (2)$$

After identifying the application requirements, design the output inductance so that the inductor peak-to-peak ripple current is approximately between 20% and 30% of the I_{CC(max)} (peak current in the application). It is also important to size the inductor properly so that the valley current doesn't hit the negative low side current limit.

7.3.3 4.7 V LDO and External Bias

The VREG5 pin is the output of the internal 4.7-V linear regulator that creates the bias for all the internal circuitry and MOSFET gate drivers. The VREG5 pin needs to be bypassed with a 4.7-μF capacitor. An external voltage that is above the LDO's internal output voltage can override the internal LDO, switching it to the external rail after a higher voltage is detected. This enhances the efficiency of the converter because the quiescent current now runs off this external rail instead of the input power supply. The UVLO circuit monitors the VREG5 pin voltage and disables the output when VREG5 falls below the UVLO threshold. When using an external bias on the VREG5 rail, any power-up and power-down sequencing can be applied but it is important to understand that if there is a discharge path on the VREG5 rail that can pull a current higher than the internal LDO's current limit (ILIM5) from the VREG5, then the VREG5 LDO turns off thereby shutting down the output of TPS568215. If such condition does not exist and if the external VREG5 rail is turned off, the VREG5 voltage switches over to the internal LDO voltage which is 4.7 V typically in a few nanoseconds. Figure 26 below shows this transition of the VREG5 voltage from an external bias of 5.5 V to the internal LDO output of 4.7 V when the external bias to VREG5 is disabled while the output of TPS568215 remains unchanged.

7.3.4 MODE Selection

TPS568215 has a MODE pin that can offer 12 different states of operation as a combination of Current Limit, Switching Frequency and Light Load operation. The device can operate at two different current limits ILIM-1 and ILIM to support an output continuous current of 6 A, 8 A respectively. The TPS568215 is designed to compare the valley current of the inductor against the current limit thresholds so understand that the output current is half the ripple current above the valley current. TPS568215 can operate at three different frequencies of 400 kHz, 800 kHz and 1200 kHz and also can choose between Eco-mode™ and FCCM mode. The device reads the voltage on the MODE pin during start-up and latches onto one of the MODE options listed below in table 3. The voltage on the MODE pin can be set by connecting this pin to the center tap of a resistor divider connected between VREG5 and AGND. A guideline for the top resistor (R_{M_H}) and the bottom resistor (R_{M_L}) as 5% resistors is shown in Table 3. It is important that the voltage for the MODE pin is derived from the VREG5 rail

only must internally this voltage is referenced to detect the MODE option. The MODE pin setting can be reset only by a VIN power cycling.

表 7-3. Mode Pin Resistor Settings

| R _{M_L} (kΩ) | R _{M_H} (kΩ) | Light Load Operation | Current Limit | Frequency (kHz) |
|-----------------------|-----------------------|----------------------|---------------|-----------------|
| 5.1 | 300 | FCCM | ILIM-1 | 400 |
| 10 | 200 | FCCM | ILIM | 400 |
| 20 | 160 | FCCM | ILIM-1 | 800 |
| 20 | 120 | FCCM | ILIM | 800 |
| 51 | 200 | FCCM | ILIM-1 | 1200 |
| 51 | 180 | FCCM | ILIM | 1200 |
| 51 | 150 | DCM | ILIM-1 | 400 |
| 51 | 120 | DCM | ILIM | 400 |
| 51 | 91 | DCM | ILIM-1 | 800 |
| 51 | 82 | DCM | ILIM | 800 |
| 51 | 62 | DCM | ILIM-1 | 1200 |
| 51 | 51 | DCM | ILIM | 1200 |

☒ 7-1 below shows the typical start-up sequence of the device after the enable signal crosses the EN turn-on threshold. After the voltage on VREG5 crosses the rising UVLO threshold it takes about 500 us to read the first mode setting and approximately 100 us from there to finish the last mode setting. The output voltage starts ramping after the mode reading is done.

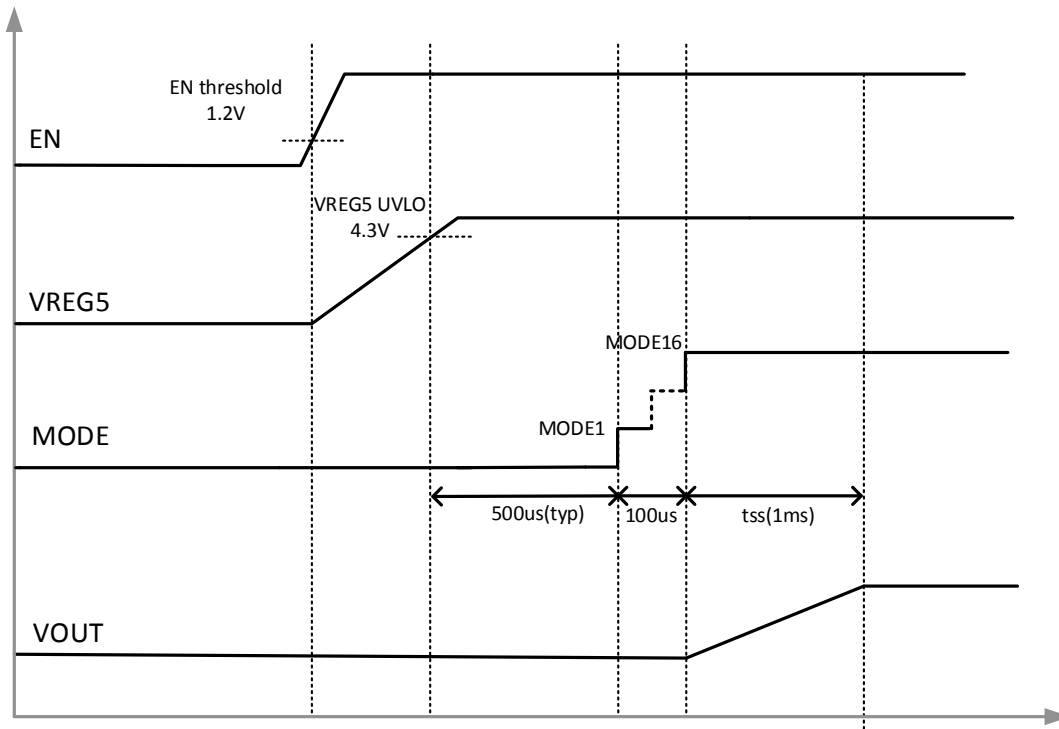

☒ 7-1. Power-Up Sequence

7.3.5 Soft Start and Pre-biased Soft Start

The TPS568215 has an adjustable soft-start time that can be set by connecting a capacitor on SS pin. When the EN pin becomes high, the soft-start charge current (I_{SS}) begins charging the external capacitor (C_{SS}) connected

between SS and AGND. The device tracks the lower of the internal soft-start voltage or the external soft-start voltage as the reference. The equation for the soft-start time (T_{SS}) is shown in 式 3:

$$T_{SS(S)} = \frac{C_{SS} \times V_{REF}}{I_{SS}} \quad (3)$$

where

- V_{REF} is 0.6 V and I_{SS} is 6 μ A

If the output capacitor is pre-biased at startup, the device initiates switching and starts ramping up only after the internal reference voltage becomes greater than the feedback voltage V_{FB} . This scheme ensures that the converters ramp up smoothly into regulation point.

7.3.6 Enable and Adjustable UVLO

The EN pin controls the turn-on and turn-off of the device. When EN pin voltage is above the turn-on threshold which is around 1.2 V, the device starts switching and when the EN pin voltage falls below the turn-off threshold which is around 1.1V it stops switching. If the user application requires a different turn-on (V_{START}) and turn-off thresholds (V_{STOP}) respectively, the EN pin can be configured as shown in 图 7-2 by connecting a resistor divider between V_{IN} and EN. The EN pin has a pull-up current I_{p1} that sets the default state of the pin when it is floating. This current increases to I_{p2} when the EN pin voltage crosses the turn-on threshold. The UVLO thresholds can be set by using 式 4 and 式 5.



图 7-2. Adjustable VIN Under Voltage Lock Out

$$R1 = \frac{V_{START} \left(\frac{V_{ENFALLING}}{V_{ENRISING}} \right) - V_{STOP}}{I_{p1} \left(1 - \frac{V_{ENFALLING}}{V_{ENRISING}} \right) + I_h} \quad (4)$$

$$R2 = \frac{R1 \times V_{ENFALLING}}{V_{STOP} - V_{ENFALLING} + R1 I_{p2}} \quad (5)$$

where

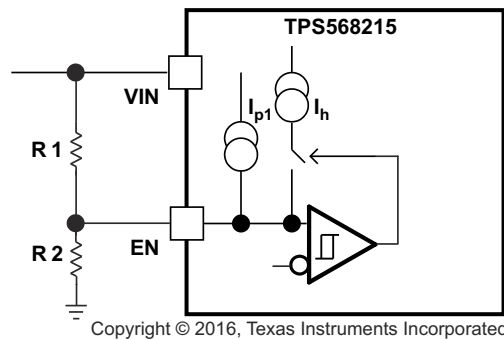
- $I_{p2} = 4.197 \mu$ A
- $I_{p1} = 1.91 \mu$ A
- $I_h = 2.287 \mu$ A
- $V_{ENRISING} = 1.225$ V
- $V_{ENFALLING} = 1.104$ V

7.3.7 Power Good

The Power-Good (PGOOD) pin is an open drain output. After the FB pin voltage is between 93% and 107% of the internal reference voltage (V_{REF}) the PGOOD is de-asserted and floats after a 200 μ s de-glitch time. TI recommends a pullup resistor of 10 k Ω to pull it up to VREG5. The PGOOD pin is pulled low when the FB pin voltage is lower than V_{UVP} or greater than V_{OVP} threshold; or, in an event of thermal shutdown or during the soft-start period.

7.3.8 Overcurrent Protection and Undervoltage Protection

The output overcurrent limit (OCL) is implemented using a cycle-by-cycle valley detect control circuit. The switch current is monitored during the OFF state by measuring the low-side FET drain to source voltage. This voltage is proportional to the switch current. During the on time of the high-side FET switch, the switch current increases at a linear rate determined by input voltage, output voltage, the on-time and the output inductor value. During the on time of the low-side FET switch, this current decreases linearly. The average value of the switch current is the load current I_{OUT} . If the measured drain to source voltage of the low-side FET is above the voltage proportional to current limit, the low side FET stays on until the current level becomes lower than the OCL level which reduces the output current available. When the current is limited the output voltage tends to drop because the load demand is higher than what the converter can support. When the output voltage falls below 68% of the target voltage, the UVP comparator detects it and shuts down the device after a wait time of 1ms, the device re-starts after a hiccup time of 7ms. In this type of valley detect control the load current is higher than the OCL threshold by one half of the peak to peak inductor ripple current. When the overcurrent condition is removed, the output voltage returns to the regulated value. If an OCL condition happens during start-up then the device enters hiccup-mode immediately without a wait time of 1 ms.

7.3.9 Out-of-Bounds Operation

The device has an out-of-bounds (OOB) overvoltage protection that protects the output load at a much lower overvoltage threshold of 8% above the target voltage. OOB protection does not trigger an overvoltage fault, OOB protection operates as an early no-fault overvoltage protection mechanism. During the OOB operation, the controller operates in forced PWM mode only by turning on the low-side FET. Turning on the low-side FET beyond the zero inductor current quickly discharges the output capacitor thus causing the output voltage to fall quickly toward the setpoint. During the operation, the cycle-by cycle negative current limit is also activated to ensure the safe operation of the internal FETs.

7.3.10 UVLO Protection

Under voltage lock out protection (UVLO) monitors the internal VREG5 regulator voltage. When the VREG5 voltage is lower than UVLO threshold voltage, the device is shut off. This protection is non-latching.

7.3.11 Thermal Shutdown

The device monitors the internal die temperature. If this temperature exceeds the thermal shutdown threshold value (T_{SDN} typically 160°C) the device shuts off. This is a non-latch protection. During start up, if the device temperature is higher than 160°C the device does not start switching and does not load the MODE settings. If the device temp goes higher than T_{SDN} threshold after startup, it stops switching with SS reset to ground and an internal discharge switch turns on to quickly discharge the output voltage. The device re-starts switching when the temperature goes below the thermal shutdown threshold but the MODE settings are not re-loaded again. There is a second higher thermal protection on the device $T_{SDN VREG5}$ which protects it from over temperature conditions not caused by the switching of the device itself. This threshold is at typically 170°C. Even under nonswitching condition of the device after exceeding T_{SDN} threshold, if it still continues to heat up the VREG5 output shuts off after temperature goes beyond $T_{SDN VREG5}$, thereby shutting down the device completely.

7.3.12 Output Voltage Discharge

The device has a 500ohm discharge switch that discharges the output V_{OUT} through SW node during any event of fault like output overvoltage, output undervoltage, TSD, if VREG5 voltage below the UVLO and when the EN pin voltage (V_{EN}) is below the turn-on threshold.

7.4 Device Functional Modes

7.4.1 Light Load Operation

When the MODE pin is selected to operate in FCCM mode, the converter operates in continuous conduction mode (FCCM) during light-load conditions. During FCCM, the switching frequency (F_{SW}) is maintained at an almost constant level over the entire load range which is suitable for applications requiring tight control of the switching frequency and output voltage ripple at the cost of lower efficiency under light load. If the MODE pin is selected to operate in DCM/Eco-mode™, the device enters pulse skip mode after the valley of the inductor ripple current crosses zero. The Eco-mode™ maintains higher efficiency at light load with a lower switching frequency.

7.4.2 Standby Operation

The TPS568215 can be placed in standby mode by pulling the EN pin low. The device operates with a shutdown current of 7uA when in standby condition.

8 Application and Implementation

注

以下のアプリケーション情報は、TI の製品仕様に含まれるものではなく、TI ではその正確性または完全性を保証いたしません。個々の目的に対する製品の適合性については、お客様の責任で判断していただくこととなります。お客様は自身の設計実装を検証しテストすることで、システムの機能を確認する必要があります。

8.1 Application Information

The schematic of [図 8-1](#) shows a typical application for TPS568215. This design converts an input voltage range of 4.5 V to 17 V down to 1.2 V with a maximum output current of 8 A.

8.2 Typical Application

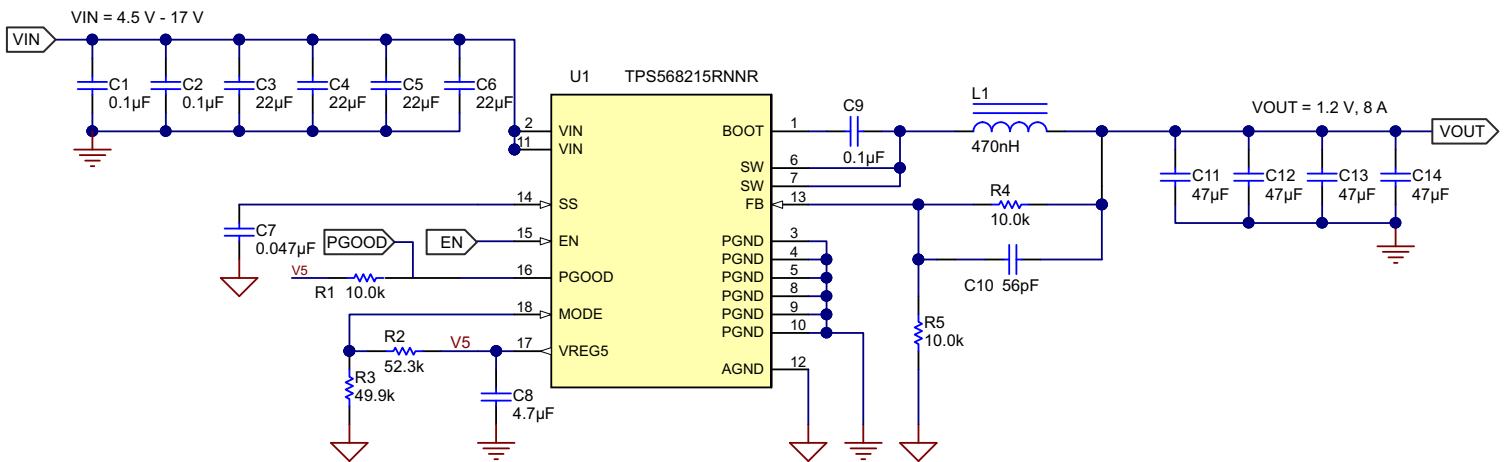

Copyright © 2016, Texas Instruments Incorporated

図 8-1. Application Schematic

8.2.1 Design Requirements

表 8-1. Design Parameters

| PARAMETER | CONDITIONS | MIN | TYP | MAX | UNIT |
|-------------------|-----------------------|-----------------------|---------------|-----|---------------------|
| V_{OUT} | Output voltage | | 1.2 | | V |
| I_{OUT} | Output current | | 8 | | A |
| ΔV_{OUT} | Transient response | 4-A load step | ± 30 | | mV |
| V_{IN} | Input voltage | 4.5 | 12 | 17 | V |
| $V_{OUT(ripple)}$ | Output voltage ripple | | <10 | | mV _(p-p) |
| | Start input voltage | Input voltage rising | Internal UVLO | | V |
| | Stop input voltage | Input voltage falling | Internal UVLO | | V |
| f_{SW} | Switching frequency | | 1.2 | | MHz |
| Operating Mode | | | DCM | | |
| T_A | Ambient temperature | | 25 | | °C |

8.2.2 Detailed Design Procedure

8.2.2.1 External Component Selection

8.2.2.1.1 Output Voltage Set Point

To change the output voltage of the application, it is necessary to change the value of the upper feedback resistor. By changing this resistor the user can change the output voltage above 0.6 V. See 式 6

$$V_{OUT} = 0.6 \times \left(1 + \frac{R_{UPPER}}{R_{LOWER}} \right) \quad (6)$$

8.2.2.1.2 Switching Frequency and Mode Selection

Switching Frequency, current limit and switching mode (DCM or FCCM) are set by a voltage divider from VREG5 to GND connected to the MODE pin. See 表 7-3 for possible MODE pin configurations. Switching frequency selection is a tradeoff between higher efficiency and smaller system solution size. Lower switching frequency yields higher overall efficiency but relatively bigger external components. Higher switching frequencies cause additional switching losses which impact efficiency and thermal performance. For this design 1.2 MHz is chosen as the switching frequency, the switching mode is DCM and the output current is 8 A.

8.2.2.1.3 Inductor Selection

The inductor ripple current is filtered by the output capacitor. A higher inductor ripple current means the output capacitor must have a ripple current rating higher than the inductor ripple current. See 表 8-2 for recommended inductor values.

The RMS and peak currents through the inductor can be calculated using 式 7 and 式 8. It is important that the inductor is rated to handle these currents.

$$I_{L(rms)} = \sqrt{\left(I_{OUT}^2 + \frac{1}{12} \times \left(\frac{V_{OUT} \times (V_{IN(max)} - V_{OUT})}{V_{IN(max)} \times L_{OUT} \times F_{SW}} \right)^2 \right)} \quad (7)$$

$$I_{L(peak)} = I_{OUT} + \frac{I_{OUT(ripple)}}{2} \quad (8)$$

During transient/short circuit conditions the inductor current can increase up to the current limit of the device so it is safe to choose an inductor with a saturation current higher than the peak current under current limit condition.

8.2.2.1.4 Output Capacitor Selection

After selecting the inductor the output capacitor needs to be optimized. In D-CAP3 control mode, the regulator reacts within one cycle to the change in the duty cycle so the good transient performance can be achieved without needing large amounts of output capacitance. The recommended output capacitance range is given in 表 8-2

Ceramic capacitors have very low ESR, otherwise the maximum ESR of the capacitor must be less than $V_{OUT(ripple)}/I_{OUT(ripple)}$

表 8-2. Recommended Component Values

| V _{OUT} (V) | R _{LOWER} (kΩ) | R _{UPPER} (kΩ) | F _{SW} (kHz) | L _{OUT} (μH) | C _{OUT(min)} (μF) | C _{OUT(max)} (μF) | C _{FF} (pF) |
|----------------------|-------------------------|-------------------------|-----------------------|-----------------------|----------------------------|----------------------------|----------------------|
| 0.6 | 10 | 0 | 400 | 0.68 | 300 | 500 | – |
| | | | 800 | 0.47 | 100 | 500 | – |
| | | | 1200 | 0.33 | 88 | 500 | – |
| 1.2 | | 10 | 400 | 1.2 | 100 | 500 | – |
| | | | 800 | 0.68 | 88 | 500 | – |
| | | | 1200 | 0.47 | 88 | 500 | – |

表 8-2. Recommended Component Values (continued)

| V _{OUT} (V) | R _{LOWER} (kΩ) | R _{UPPER} (kΩ) | F _{SW} (kHz) | L _{OUT} (μH) | C _{OUT(min)} (μF) | C _{OUT(max)} (μF) | C _{FF} (pF) |
|----------------------|-------------------------|-------------------------|-----------------------|-----------------------|----------------------------|----------------------------|----------------------|
| 3.3 | | 45.3 | 400 | 2.4 | 88 | 500 | 100–220 |
| | | | 800 | 1.5 | 88 | 500 | 100–220 |
| | | | 1200 | 1.1 | 88 | 500 | 100–220 |
| 5.5 | | 82.5 | 400 | 3.3 | 88 | 500 | 100–220 |
| | | | 800 | 2.4 | 88 | 500 | 100–220 |
| | | | 1200 | 1.2 | 88 | 700 | 100–220 |

8.2.2.1.5 Input Capacitor Selection

The minimum input capacitance required is given in 式 9.

$$C_{IN(min)} = \frac{I_{OUT} \times V_{OUT}}{V_{INripple} \times V_{IN} \times F_{SW}} \quad (9)$$

TI recommends using a high quality X5R or X7R input decoupling capacitors of 40 μF on the input voltage pin. The voltage rating on the input capacitor must be greater than the maximum input voltage. The capacitor must also have a ripple current rating greater than the maximum input current ripple of the application. The input ripple current is calculated by 式 10 below:

$$I_{CIN(rms)} = I_{OUT} \times \sqrt{\frac{V_{OUT}}{V_{IN(min)}} \times \frac{(V_{IN(min)} - V_{OUT})}{V_{IN(min)}}} \quad (10)$$

8.2.3 Application Curves

Figure 8-2 through Figure 8-18 apply to the circuit of Figure 8-1. $V_{IN} = 12\text{ V}$. $T_a = 25\text{ }^\circ\text{C}$ unless otherwise specified.

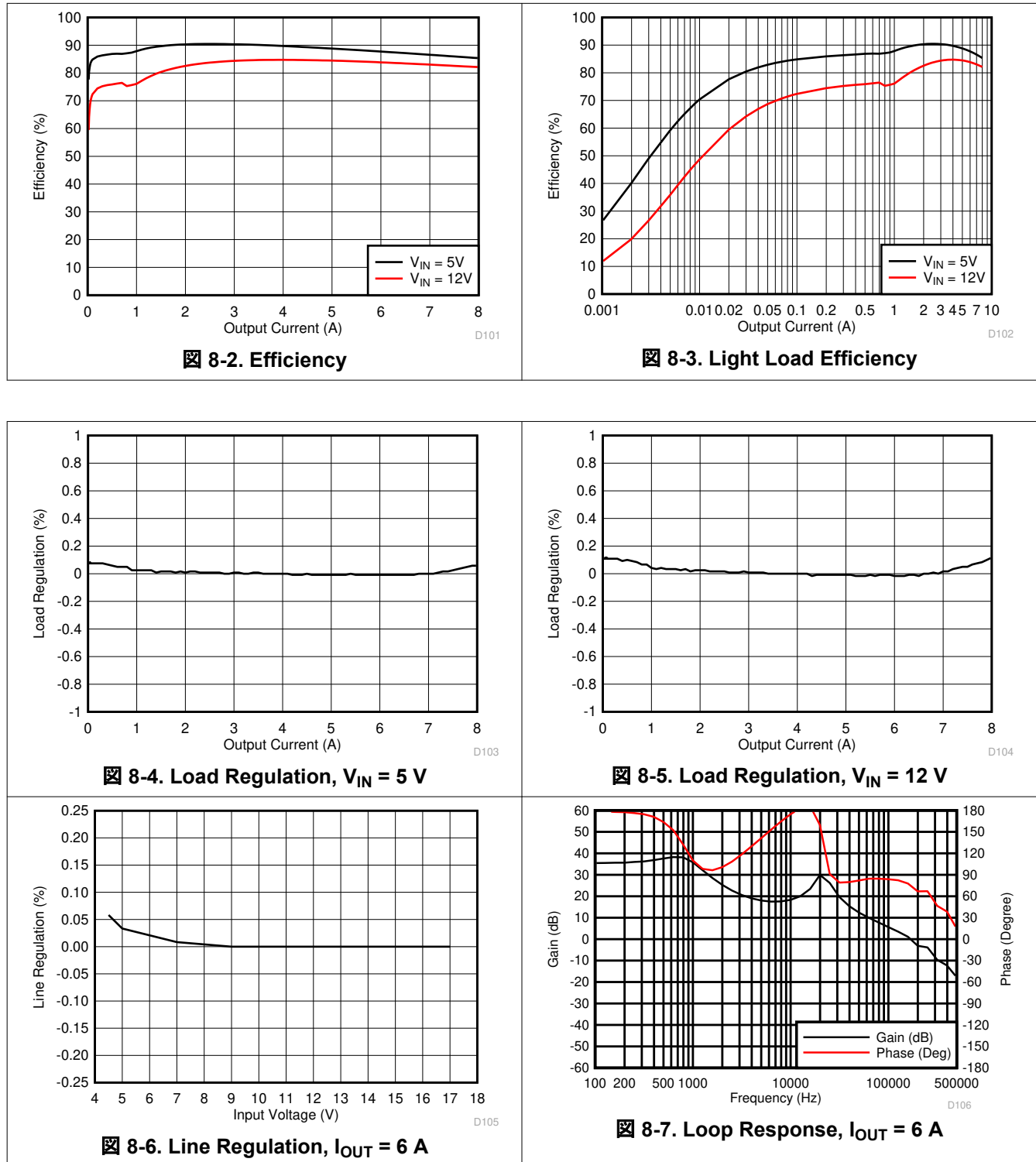

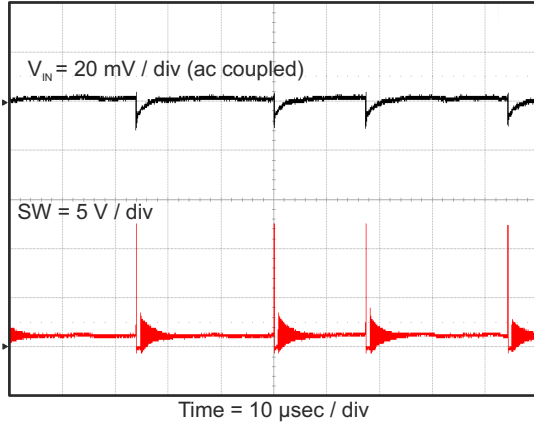

8-8. Input Voltage Ripple, $I_{OUT} = 10\text{ mA}$

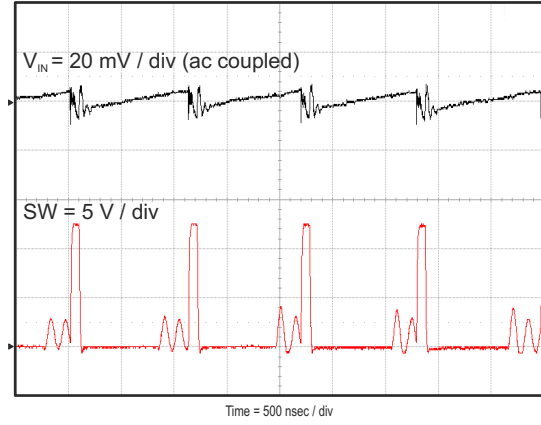

8-9. Input Voltage Ripple, $I_{OUT} = 700\text{ mA}$

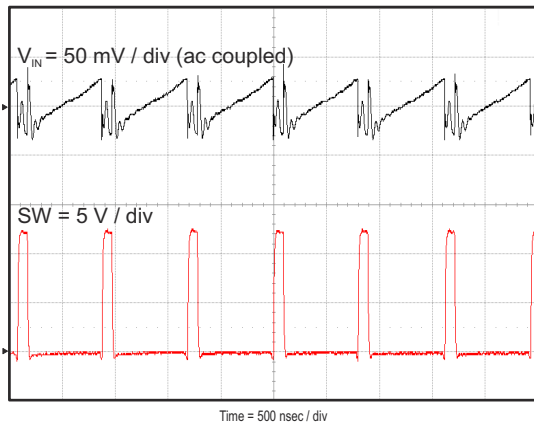

8-10. Input Voltage Ripple, $I_{OUT} = 8\text{ A}$

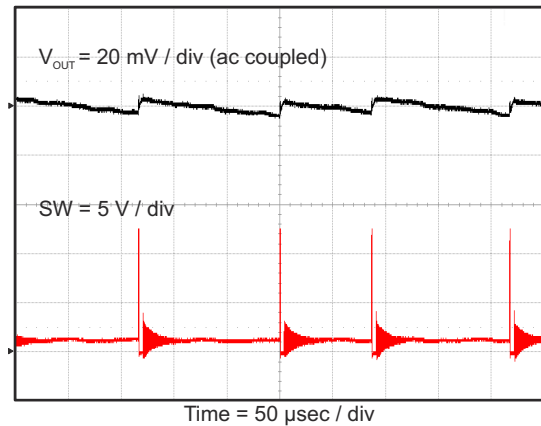

8-11. Output Voltage Ripple, $I_{OUT} = 10\text{ mA}$

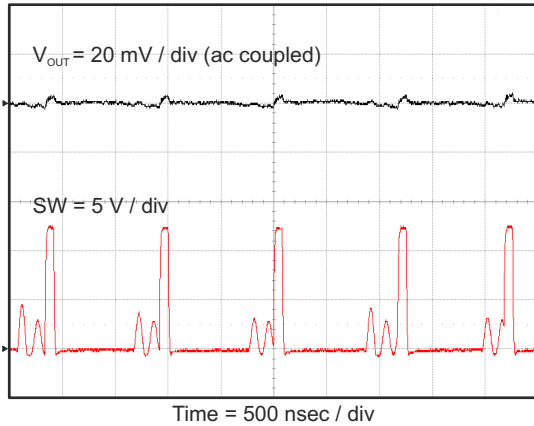

8-12. Output Voltage Ripple, $I_{OUT} = 700\text{ mA}$

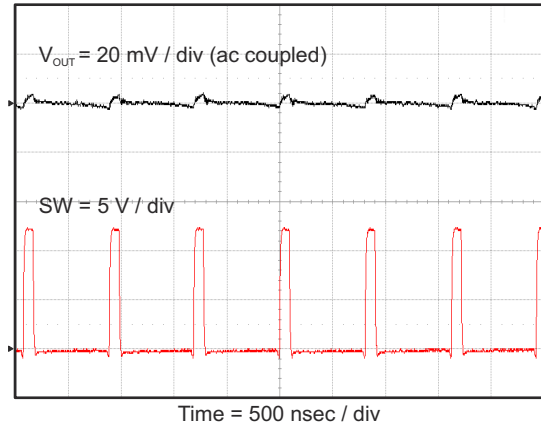

8-13. Output Voltage Ripple, $I_{OUT} = 8\text{ A}$

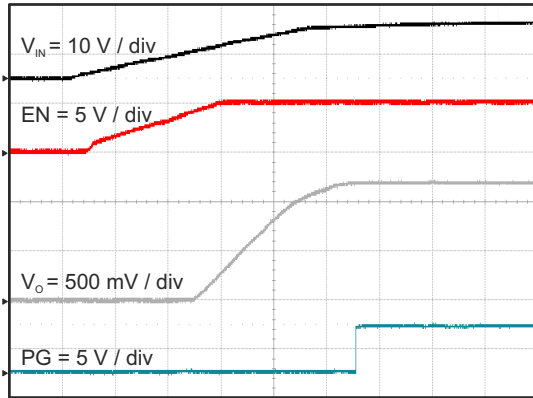

8-14. Start Up Relative to V_{IN} Rising

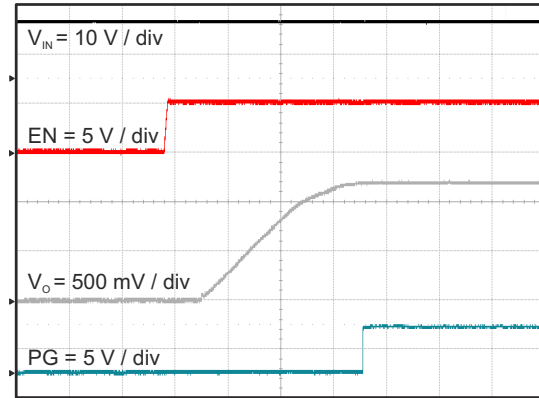

8-15. Start Up Relative to EN Rising

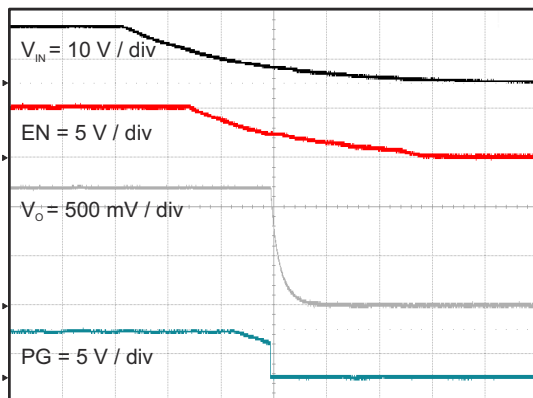

8-16. Shut Down Relative to V_{IN} Falling

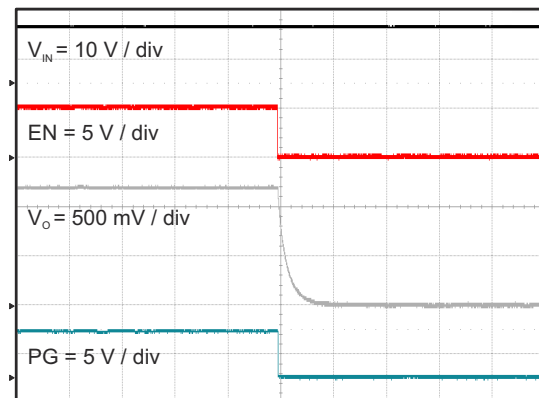

8-17. Shut Down Relative to EN Falling

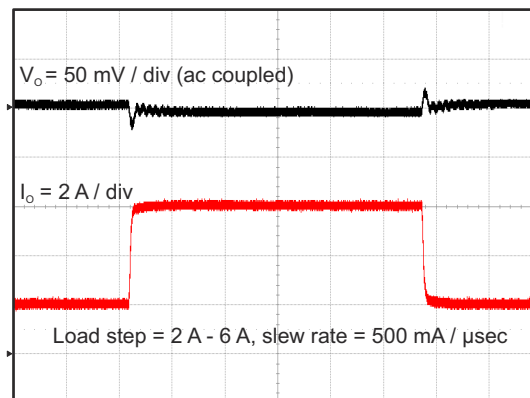

8-18. Transient Response

8.3 Power Supply Recommendations



The TPS568215 is intended to be powered by a well regulated dc voltage. The input voltage range is 4.5 to 17 V. TPS568215 is a buck converter. The input supply voltage must be greater than the desired output voltage for proper operation. Input supply current must be appropriate for the desired output current. If the input voltage supply is located far from the TPS568215 circuit, TI recommends some additional input bulk capacitance. Typical values are 100 μ F to 470 μ F.

8.4 Layout

8.4.1 Layout Guidelines

- Recommend a four-layer or six-layer PCB for good thermal performance and with maximum ground plane. 3" × 3", four-layer PCB with 2-oz. copper used as example.
- Recommend having equal caps on each side of the IC. Place them right across VIN as close as possible.
- Inner layer 1 is ground with the PGND to AGND net tie.
- Inner layer 2 has VIN copper pour that has vias to the top layer VIN. *Place multiple vias under the device near VIN and GND and near input capacitors* to reduce parasitic inductance and improve thermal performance
- Bottom later is GND with the BOOT trace routing.
- Reference feedback to the quite AGND and routed away from the switch node.
- Make VIN trace wide to reduce the trace impedance.

8.4.2 Layout Example

 8-19 shows the recommended top side layout. Component reference designators are the same as the circuit shown in  8-1. Resistor divider for EN is not used in the circuit of  8-1, but are shown in the layout for reference.

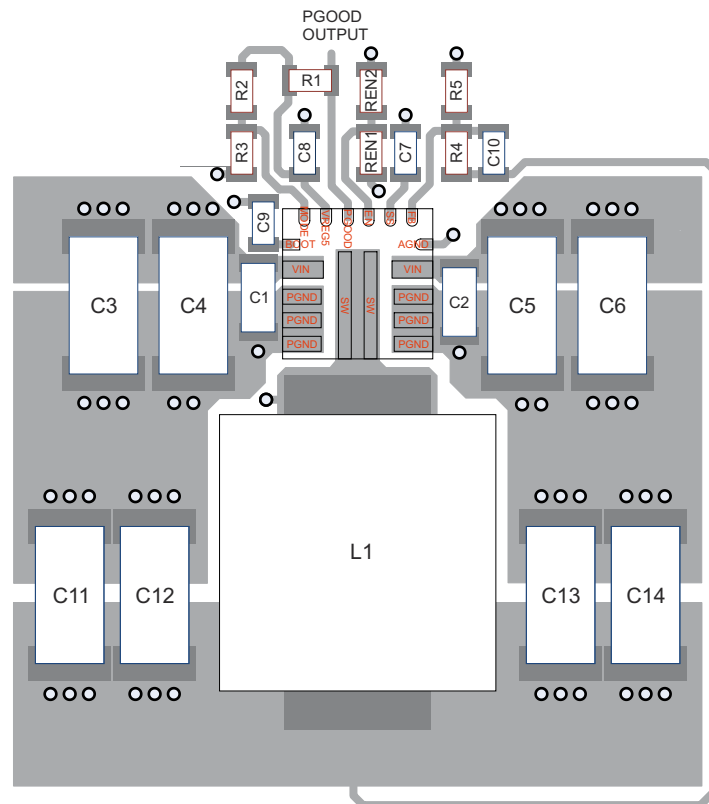

 8-19. Top Side Layout

☒ 8-20 shows the recommended layout for the first internal layer. It is comprised of a large PGND plane and a smaller ANGD island. AGND and PGND are connected at a single point to reduce circulating currents.

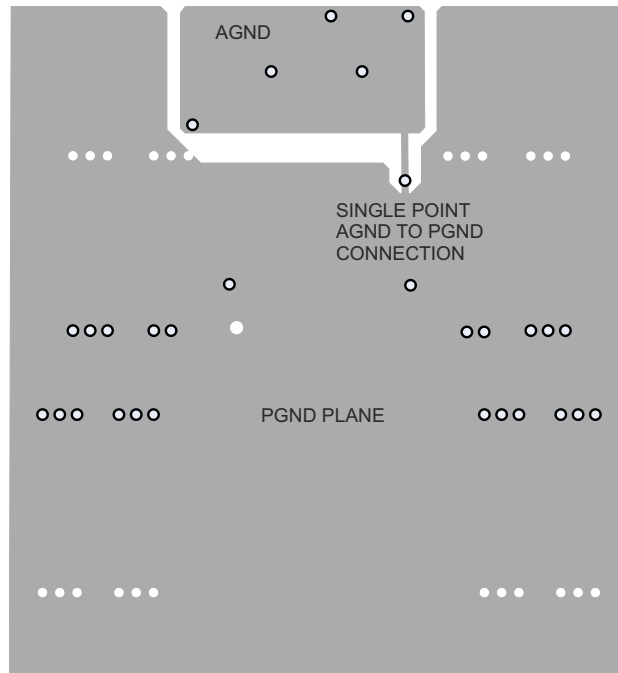

☒ 8-20. Mid Layer 1 Layout

☒ 8-21 shows the recommended layout for the second internal layer. It is comprised of a large PGND plane, a smaller copper fill area to connect the two top side V_{IN} copper areas and a second V_{OUT} copper fill area.

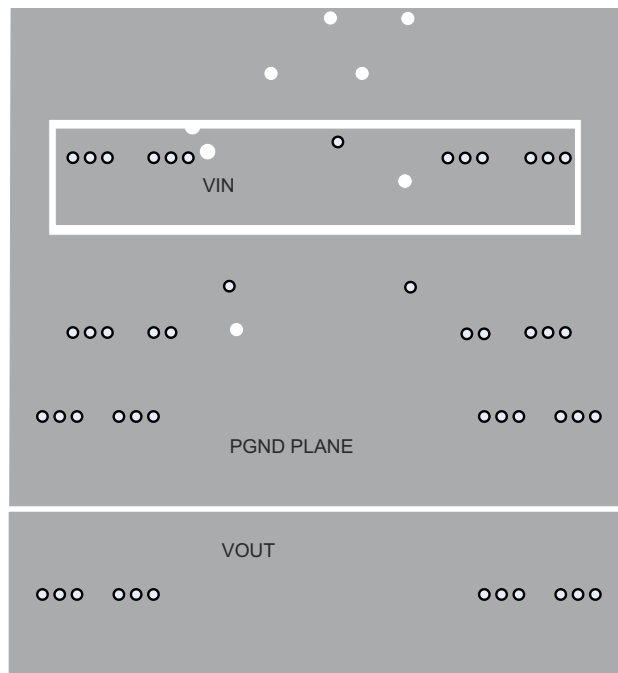

☒ 8-21. Mid Layer 2 Layout

☒ 8-22 shows the recommended layout for the bottom layer. It is comprised of a large PGND plane and a trace to connect the BOOT capacitor to the SW node.

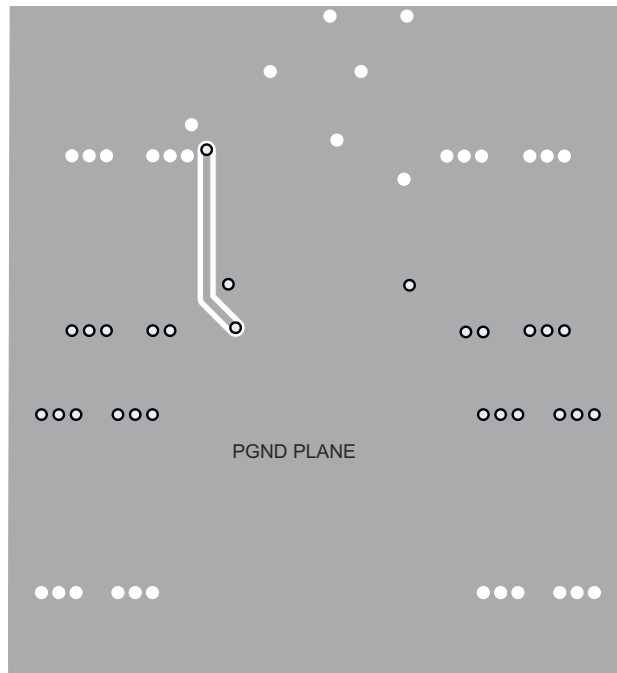

☒ 8-22. Bottom Layer Layout

9 Device and Documentation Support

9.1 Device Support

9.1.1 サード・パーティ製品に関する免責事項

サード・パーティ製品またはサービスに関するテキサス・インスツルメンツの出版物は、単独またはテキサス・インスツルメンツの製品、サービスと一緒に提供される場合に関係なく、サード・パーティ製品またはサービスの適合性に関する是認、サード・パーティ製品またはサービスの是認の表明を意味するものではありません。

9.1.2 Development Support

- [TPS568215EVM-762 8-A, SWIFT™ Regulator Evaluation Module User's Guide](#)

9.2 ドキュメントの更新通知を受け取る方法

ドキュメントの更新についての通知を受け取るには、[ti.com](#) のデバイス製品フォルダを開いてください。「更新の通知を受け取る」をクリックして登録すると、変更されたすべての製品情報に関するダイジェストを毎週受け取れます。変更の詳細については、修正されたドキュメントに含まれている改訂履歴をご覧ください。

9.3 サポート・リソース

[TI E2E™ サポート・フォーラム](#)は、エンジニアが検証済みの回答と設計に関するヒントをエキスパートから迅速かつ直接得ることができる場所です。既存の回答を検索したり、独自の質問をしたりすることで、設計に必要な支援を迅速に得ることができます。

リンクされているコンテンツは、該当する貢献者により、現状のまま提供されるものです。これらは TI の仕様を構成するものではなく、必ずしも TI の見解を反映したものではありません。TI の[使用条件](#)を参照してください。

9.4 Trademarks

SWIFT™, D-CAP3™, HotRod™, and Eco-mode™, and TI E2E™ are trademarks of Texas Instruments.

WEBENCH® is a registered trademark of Texas Instruments.

すべての商標は、それぞれの所有者に帰属します。

9.5 静電気放電に関する注意事項



この IC は、ESD によって破損する可能性があります。テキサス・インスツルメンツは、IC を取り扱う際には常に適切な注意を払うことを推奨します。正しい取り扱いおよび設置手順に従わない場合、デバイスを破損するおそれがあります。

ESD による破損は、わずかな性能低下からデバイスの完全な故障まで多岐にわたります。精密な IC の場合、パラメータがわずかに変化するだけで公表されている仕様から外れる可能性があるため、破損が発生しやすくなっています。

9.6 用語集

[テキサス・インスツルメンツ用語集](#) この用語集には、用語や略語の一覧および定義が記載されています。

10 Mechanical, Packaging, and Orderable Information

The following pages include mechanical, packaging, and orderable information. This information is the most current data available for the designated devices. This data is subject to change without notice and revision of this document. For browser-based versions of this data sheet, refer to the left-hand navigation.

PACKAGING INFORMATION

| Orderable Device | Status (1) | Package Type | Package Drawing | Pins | Package Qty | Eco Plan (2) | Lead finish/ Ball material (6) | MSL Peak Temp (3) | Op Temp (°C) | Device Marking (4/5) | Samples |
|------------------|---------------|--------------|-----------------|------|-------------|-----------------|--------------------------------------|----------------------|--------------|-------------------------|-------------------------|
| TPS568215RNNR | ACTIVE | VQFN-HR | RNN | 18 | 3000 | RoHS & Green | Call TI SN | Level-2-260C-1 YEAR | -40 to 125 | 568215 | Samples |
| TPS568215RNNT | ACTIVE | VQFN-HR | RNN | 18 | 250 | RoHS & Green | Call TI SN | Level-2-260C-1 YEAR | -40 to 125 | 568215 | Samples |

(1) The marketing status values are defined as follows:

ACTIVE: Product device recommended for new designs.

LIFEBUY: TI has announced that the device will be discontinued, and a lifetime-buy period is in effect.

NRND: Not recommended for new designs. Device is in production to support existing customers, but TI does not recommend using this part in a new design.

PREVIEW: Device has been announced but is not in production. Samples may or may not be available.

OBSOLETE: TI has discontinued the production of the device.

(2) **RoHS:** TI defines "RoHS" to mean semiconductor products that are compliant with the current EU RoHS requirements for all 10 RoHS substances, including the requirement that RoHS substance do not exceed 0.1% by weight in homogeneous materials. Where designed to be soldered at high temperatures, "RoHS" products are suitable for use in specified lead-free processes. TI may reference these types of products as "Pb-Free".

RoHS Exempt: TI defines "RoHS Exempt" to mean products that contain lead but are compliant with EU RoHS pursuant to a specific EU RoHS exemption.

Green: TI defines "Green" to mean the content of Chlorine (Cl) and Bromine (Br) based flame retardants meet JS709B low halogen requirements of <=1000ppm threshold. Antimony trioxide based flame retardants must also meet the <=1000ppm threshold requirement.

(3) MSL, Peak Temp. - The Moisture Sensitivity Level rating according to the JEDEC industry standard classifications, and peak solder temperature.

(4) There may be additional marking, which relates to the logo, the lot trace code information, or the environmental category on the device.

(5) Multiple Device Markings will be inside parentheses. Only one Device Marking contained in parentheses and separated by a "~" will appear on a device. If a line is indented then it is a continuation of the previous line and the two combined represent the entire Device Marking for that device.

(6) Lead finish/Ball material - Orderable Devices may have multiple material finish options. Finish options are separated by a vertical ruled line. Lead finish/Ball material values may wrap to two lines if the finish value exceeds the maximum column width.

Important Information and Disclaimer:The information provided on this page represents TI's knowledge and belief as of the date that it is provided. TI bases its knowledge and belief on information provided by third parties, and makes no representation or warranty as to the accuracy of such information. Efforts are underway to better integrate information from third parties. TI has taken and continues to take reasonable steps to provide representative and accurate information but may not have conducted destructive testing or chemical analysis on incoming materials and chemicals. TI and TI suppliers consider certain information to be proprietary, and thus CAS numbers and other limited information may not be available for release.

In no event shall TI's liability arising out of such information exceed the total purchase price of the TI part(s) at issue in this document sold by TI to Customer on an annual basis.

TAPE AND REEL INFORMATION

QUADRANT ASSIGNMENTS FOR PIN 1 ORIENTATION IN TAPE



*All dimensions are nominal

| Device | Package Type | Package Drawing | Pins | SPQ | Reel Diameter (mm) | Reel Width W1 (mm) | A0 (mm) | B0 (mm) | K0 (mm) | P1 (mm) | W (mm) | Pin1 Quadrant |
|---------------|--------------|-----------------|------|-----|--------------------|--------------------|---------|---------|---------|---------|--------|---------------|
| TPS568215RNNT | VQFN-HR | RNN | 18 | 250 | 180.0 | 12.4 | 3.75 | 3.75 | 1.15 | 8.0 | 12.0 | Q2 |

TAPE AND REEL BOX DIMENSIONS

*All dimensions are nominal

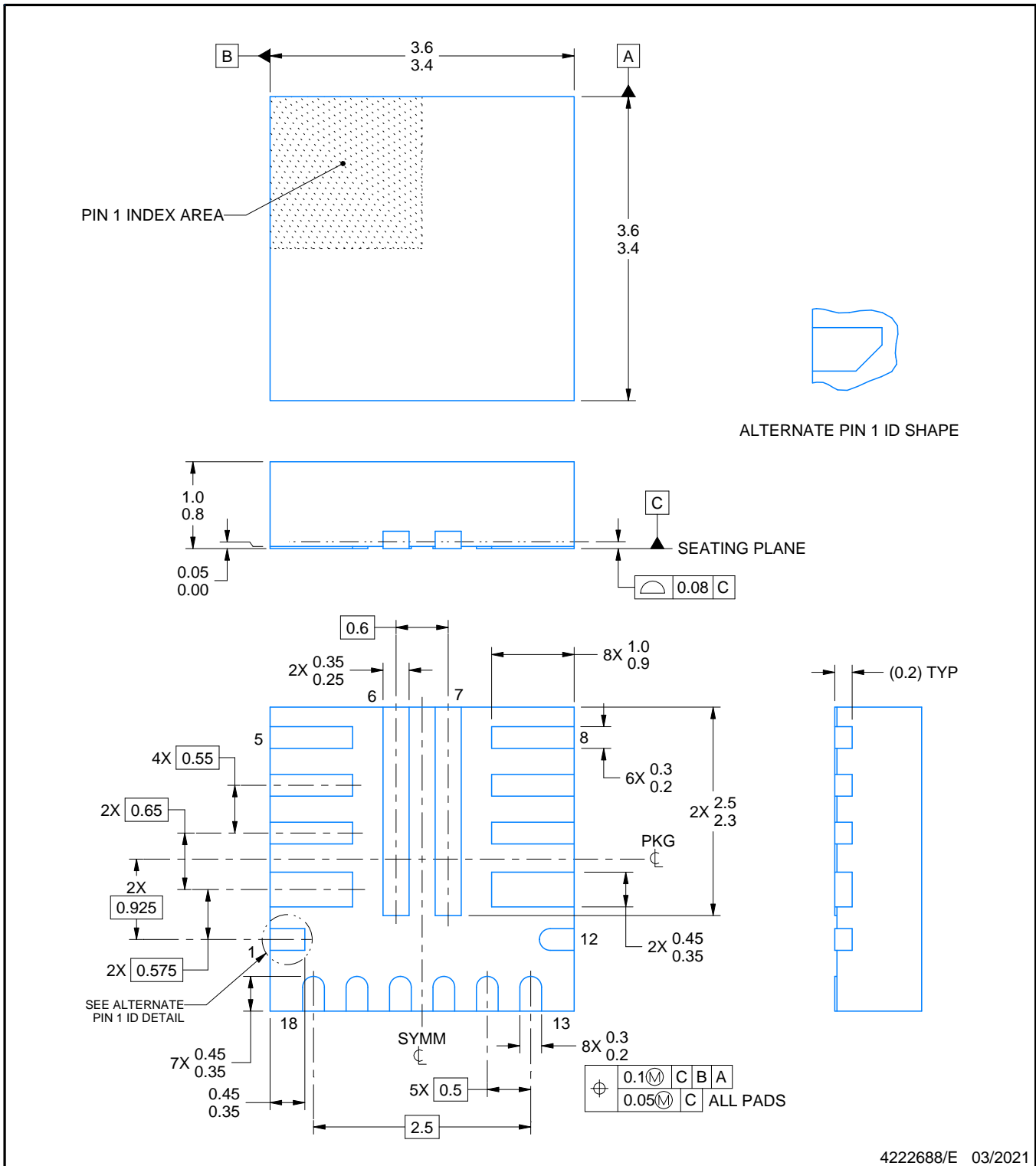
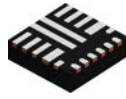
| Device | Package Type | Package Drawing | Pins | SPQ | Length (mm) | Width (mm) | Height (mm) |
|---------------|--------------|-----------------|------|-----|-------------|------------|-------------|
| TPS568215RNNT | VQFN-HR | RNN | 18 | 250 | 341.0 | 185.0 | 80.0 |



NOTES:

1. All linear dimensions are in millimeters. Any dimensions in parenthesis are for reference only. Dimensioning and tolerancing per ASME Y14.5M.
2. This drawing is subject to change without notice.

EXAMPLE BOARD LAYOUT

RNN0018A

VQFN-HR - 1 mm max height

PLASTIC QUAD FLATPACK - NO LEAD

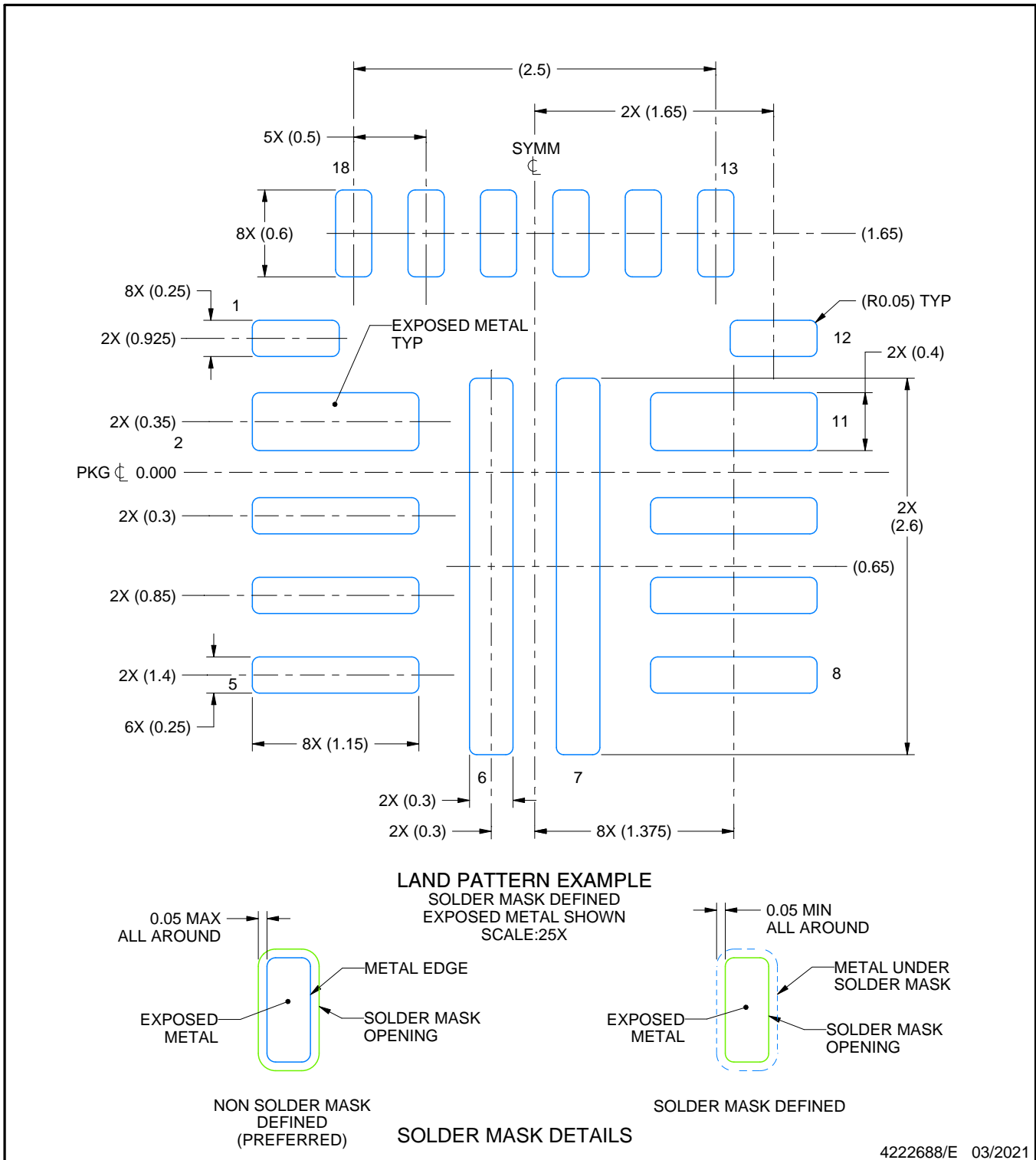

NOTES: (continued)

- This package is designed to be soldered to a thermal pad on the board. For more information, see Texas Instruments literature number SLUA271 (www.ti.com/lit/slua271).
- Solder mask tolerances between and around signal pads can vary based on board fabrication site.

EXAMPLE STENCIL DESIGN

RNN0018A

VQFN-HR - 1 mm max height

PLASTIC QUAD FLATPACK - NO LEAD

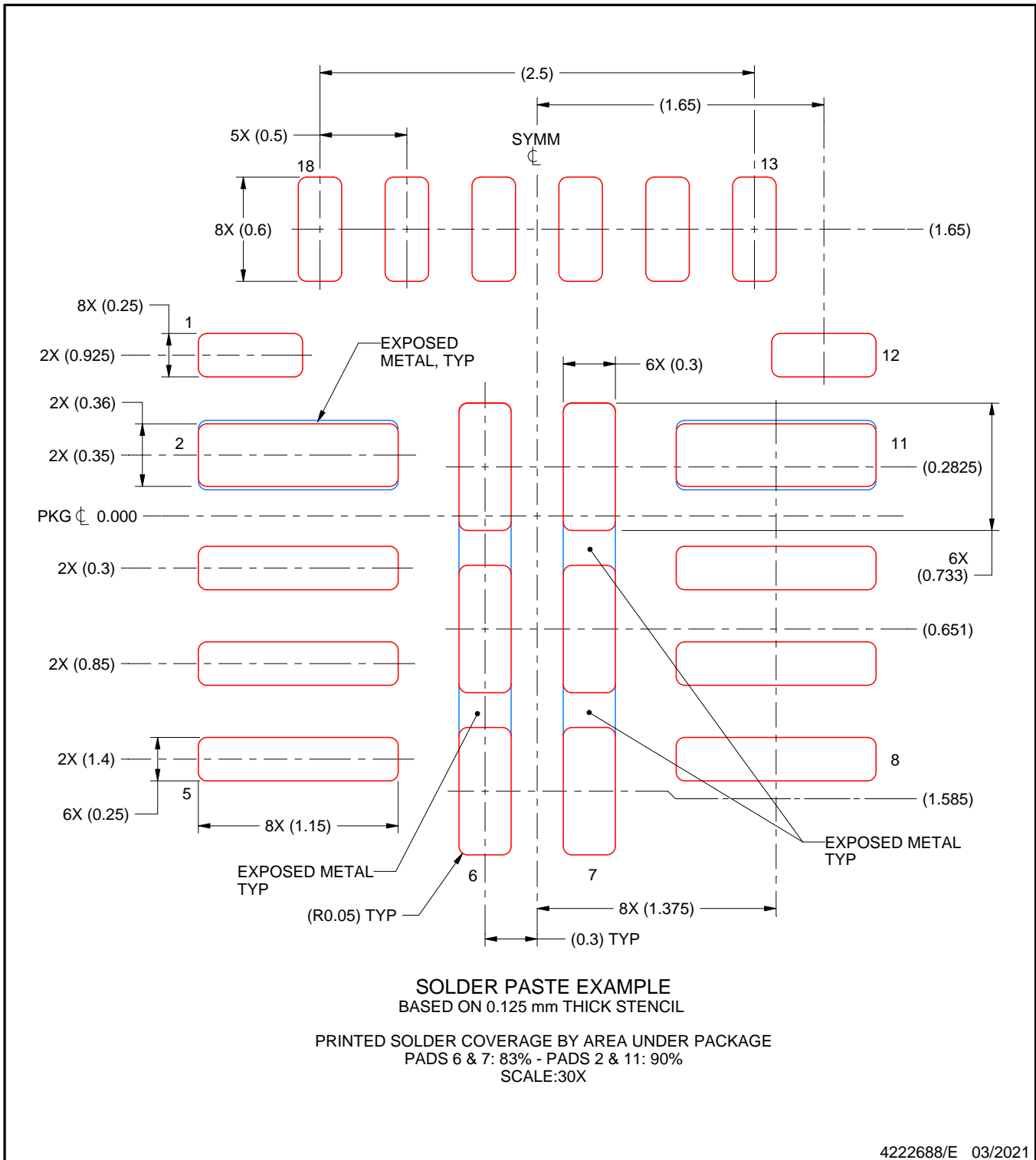

NOTES: (continued)

5. For alternate stencil design recommendations, see IPC-7525 or board assembly site preference.

重要なお知らせと免責事項

TI は、技術データと信頼性データ(データシートを含みます)、設計リソース(リファレンス・デザインを含みます)、アプリケーションや設計に関する各種アドバイス、Web ツール、安全性情報、その他のリソースを、欠陥が存在する可能性のある「現状のまま」提供しており、商品性および特定目的に対する適合性の黙示保証、第三者の知的財産権の非侵害保証を含むいかなる保証も、明示的または黙示的にかかわらず拒否します。

これらのリソースは、TI 製品を使用する設計の経験を積んだ開発者への提供を意図したものです。(1) お客様のアプリケーションに適した TI 製品の選定、(2) お客様のアプリケーションの設計、検証、試験、(3) お客様のアプリケーションに該当する各種規格や、その他のあらゆる安全性、セキュリティ、規制、または他の要件への確実な適合に関する責任を、お客様のみが単独で負うものとし、

上記の各種リソースは、予告なく変更される可能性があります。これらのリソースは、リソースで説明されている TI 製品を使用するアプリケーションの開発の目的でのみ、TI はその使用をお客様に許諾します。これらのリソースに関して、他の目的で複製することや掲載することは禁止されています。TI や第三者の知的財産権のライセンスが付与されている訳ではありません。お客様は、これらのリソースを自身で使用した結果発生するあらゆる申し立て、損害、費用、損失、責任について、TI およびその代理人を完全に補償するものとし、TI は一切の責任を拒否します。

TI の製品は、[TI の販売条件](#)、または [ti.com](#) やかかる TI 製品の関連資料などのいずれかを通じて提供する適用可能な条項の下で提供されています。TI がこれらのリソースを提供することは、適用される TI の保証または他の保証の放棄の拡大や変更を意味するものではありません。

お客様がいかなる追加条項または代替条項を提案した場合でも、TI はそれらに異議を唱え、拒否します。

郵送先住所 : Texas Instruments, Post Office Box 655303, Dallas, Texas 75265
Copyright © 2024, Texas Instruments Incorporated