

TPS61322 静止電流 6.5 μ A、スイッチ電流 1.8A の昇圧コンバータ

1 特長

- 動作時入力電圧範囲: 0.9V~5.5V
- 出力電圧範囲: 1.8 V~5.5V
- VO_{UT} ピンへの静止電流 6.5 μ A
- 温度範囲全体にわたって \pm 3% の出力電圧精度
- 最小スイッチ ピーク電流制限
 - TPS613223A: 0.42 A
 - TPS61322: 0.5 A
 - TPS613221A および TPS613226A: 0.75A
 - TPS613222A: 1.10A
- 1.5V から 2.2V への変換で、10mA 負荷において 90% 以上の効率
- サーマル シャットダウン保護
- 2.9mm \times 1.3mm の 3 ピン SOT パッケージおよび 2.9mm \times 1.6mm の 5 ピン SOT パッケージ
- WEBENCH[®] Power Designer により、TPS61322 を使用するカスタム設計を作成

2 アプリケーション

- 1~3 セルのアルカリまたは NiMH バッテリ駆動のアプリケーション
- ゲーム用コントローラ
- タブレット
- ポータブル エレクトロニクス
- 医療用機器

3 概要

TPS61322 は同期整流昇圧型コンバータで、静止電流が 6.5 μ A と非常に低いのが特長です。TPS61322 は、アルカリ バッテリ、NiMH 充電式バッテリ、または 1 セルのリチウムイオン バッテリで駆動される製品向けの電源ソリューションです。昇圧コンバータは、同期整流を使用するヒステリシス式の制御トポロジに基づいて、最小の静止電流で最大の効率を実現します。また、TPS61322 では小型の外付けインダクタおよびコンデンサを使用できます。1.5V の入力から 2.2V の出力への変換において、10mA の負荷で 90% を超える効率を達成できます。

また、TPS61322 は外付けのショットキー ダイオードにより、高い出力電流のアプリケーションをサポートします。TPS61322A は、外付けのショットキー ダイオードを内蔵の整流 FET と並列に使用することにより、3V の入力電圧から 5V の出力電圧への変換で、500mA を超える出力電流能力を持ちます。

出力電圧は内部で 1.8V~5.5V の固定出力電圧に 0.1V 刻みで設定できます。このため、目的の出力電圧を得るために外付け部品は 2 個しか必要としません。また、TPS61322 にはサーマル シャットダウン保護機能が実装されています。

TPS61322 は 2.9mm \times 1.3mm の 3 ピン SOT パッケージ、または 2.9mm \times 1.6mm の 5 ピン SOT パッケージで供給されます。

製品情報⁽¹⁾

部品番号	パッケージ	本体サイズ (公称)
TPS61322	SOT-23 (3)	2.90mm \times 1.30mm
	SOT-23 (5)	2.90mm \times 1.60mm

(1) 利用可能なすべてのパッケージについては、データシートの末尾にある注文情報を参照してください。

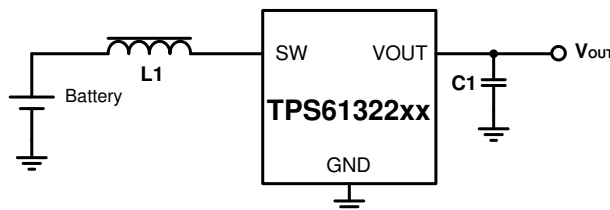

代表的なアプリケーション回路



Table of Contents

1 特長	1	8.1 Application Information.....	11
2 アプリケーション	1	8.2 Typical Application.....	11
3 概要	1	8.3 System Examples.....	20
4 Device Comparison Table	3	9 Power Supply Recommendations	21
5 Pin Configuration and Functions	3	10 Layout	22
Pin Functions.....	3	10.1 Layout Guidelines.....	22
6 Specifications	4	10.2 Layout Examples.....	23
6.1 Absolute Maximum Ratings.....	4	11 Device and Documentation Support	24
6.2 ESD Ratings.....	4	11.1 Device Support.....	24
6.3 Recommended Operating Conditions.....	4	11.2 Documentation Support.....	24
6.4 Thermal Information.....	4	11.3 Receiving Notification of Documentation Updates..	24
6.5 Electrical Characteristics.....	5	11.4 サポート・リソース.....	24
6.6 Typical Characteristics.....	6	11.5 Trademarks.....	24
7 Detailed Description	9	11.6 静電気放電に関する注意事項.....	25
7.1 Overview.....	9	11.7 用語集.....	25
7.2 Functional Block Diagram.....	9	12 Revision History	25
7.3 Feature Description.....	9	13 Mechanical, Packaging, and Orderable Information	26
8 Application and Implementation	11		

4 Device Comparison Table

PART NUMBER	OUTPUT VOLTAGE	TYPICAL CURRENT LIMIT
TPS61322	2.2 V	0.75A
TPS613221A	3.3 V	1.2 A
TPS613222A	5 V	1.8 A
TPS613223A	2 V	0.75 A
TPS613224A ⁽¹⁾	2.5 V	0.75 A
TPS613225A ⁽¹⁾	3 V	1.2 A
TPS613226A	3.6 V	1.2 A

(1) Product Preview. Contact TI factory for more information.

5 Pin Configuration and Functions

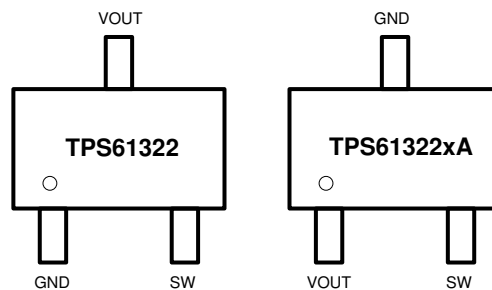

☒ 5-1. DBZ Package 3-Pin SOT Top View

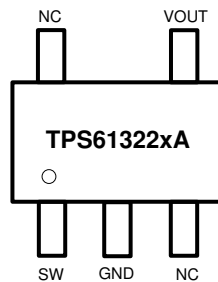

☒ 5-2. DBV Package 5-Pin SOT Top View

Pin Functions

PIN			NAME	TYPE	DESCRIPTION
TPS61322	TPS61322xA				
DBZ	DBZ	DBV			
1	3	2	GND	PWR	Ground of the IC.
2	2	1	SW	PWR	The switch pin of the converter. It is connected to the inductor.
3	1	4	VOUT	PWR	Boost converter output.
-	-	3	NC	-	No connection inside the device.
-	-	5	NC	-	No connection inside the device.

6 Specifications

6.1 Absolute Maximum Ratings

over operating free-air temperature range (unless otherwise noted)⁽¹⁾

	MIN	MAX	UNIT
Voltage range at terminals ⁽²⁾ SW, VOUT	-0.3	6.0	V
Operating Junction Temperature, T _J	-40	150	°C
Storage Temperature, T _{stg}	-65	150	°C

- (1) Stresses beyond those listed under *Absolute Maximum Ratings* may cause permanent damage to the device. These are stress ratings only, which do not imply functional operation of the device at these or any other conditions beyond those indicated under *Recommended Operating Conditions*. Exposure to absolute-maximum-rated conditions for extended periods may affect device reliability.
- (2) All voltage values are with respect to network ground terminal.

6.2 ESD Ratings

	VALUE	UNIT
V _(ESD) Electrostatic discharge	Human-body model (HBM), per ANSI/ESDA/JEDEC JS-001 ⁽¹⁾	±2000
	Charged-device model (CDM), per JEDEC specification JESD22-C101 ⁽²⁾	±500

- (1) JEDEC document JEP155 states that 500-V HBM allows safe manufacturing with a standard ESD control process.
- (2) JEDEC document JEP157 states that 250-V CDM allows safe manufacturing with a standard ESD control process.

6.3 Recommended Operating Conditions

over operating free-air temperature range (unless otherwise noted)

	MIN	NOM	MAX	UNIT
V _{IN} Input voltage range	0.9		5.5	V
V _{OUT} Output voltage range	1.8		5.5	V
L Inductor (effective)	0.7	2.2	13	μH
C _{OUT} Output capacitor (effective)	4.7	16	100	μF
T _J Operating junction temperature	-40		125	°C

6.4 Thermal Information

THERMAL METRIC ⁽¹⁾	TPS61322		UNIT
	DBZ (SOT-23)	DBV (SOT-23)	
	3-PIN	5-PIN	
R _{θJA} Junction-to-ambient thermal resistance	322.2	189.7	°C/W
R _{θJC(top)} Junction-to-case (top) thermal resistance	107.0	109.4	°C/W
R _{θJB} Junction-to-board thermal resistance	65.8	56.5	°C/W
ψ _{JT} Junction-to-top characterization parameter	7.5	33.3	°C/W
ψ _{JB} Junction-to-board characterization parameter	64.5	56.5	°C/W
R _{θJC(bot)} Junction-to-case (bottom) thermal resistance	N/A	N/A	°C/W

- (1) For more information about traditional and new thermal metrics, see the [Semiconductor and IC Package Thermal Metrics](#) application report.

6.5 Electrical Characteristics

$T_J = -40^{\circ}\text{C}$ to $+125^{\circ}\text{C}$ and $V_{IN} = 0.9\text{ V}$ to 5.5 V . Typical values are at $V_{IN} = 1.2\text{ V}$, $T_J = 25^{\circ}\text{C}$, unless otherwise noted

PARAMETER		TEST CONDITIONS	MIN	TYP	MAX	UNIT	
POWER SUPPLY							
V_{IN}	Input voltage range		0.9		5.5	V	
V_{VOUT_START}	Minimum voltage for startup at VOUT pin	$R_{Load} \geq 250\Omega$, $T_J = -40^{\circ}\text{C}$ to 85°C		0.83	0.87	V	
I_Q	Quiescent current into VOUT pin	$V_{OUT} = 1.2 \times \text{Target}$		6.5	10	μA	
OUTPUT							
V_{OUT}		TPS61322	$V_{IN} < V_{OUT}$, $T_J = -40^{\circ}\text{C}$ to 125°C	2.134	2.2	2.266	V
		TPS613221A	$V_{IN} < V_{OUT}$, $T_J = -40^{\circ}\text{C}$ to 125°C	3.2	3.3	3.4	V
		TPS613222A	$V_{IN} < V_{OUT}$, $T_J = -40^{\circ}\text{C}$ to 125°C	4.85	5.0	5.15	V
		TPS613223A	$V_{IN} < V_{OUT}$, $T_J = -40^{\circ}\text{C}$ to 125°C	1.94	2.0	2.06	V
		TPS613226A	$V_{IN} < V_{OUT}$, $T_J = -40^{\circ}\text{C}$ to 125°C	3.49	3.6	3.71	V
I_{SW_LKG}	Leakage current into SW pin	$V_{SW} = V_{OUT} = 1.2 \times \text{Target}$		3.5		nA	
POWER SWITCH							
$R_{DS(on)_LS}$	Low side switch on resistance	TPS61322		300		m Ω	
		TPS613221A		200		m Ω	
		TPS613222A		150		m Ω	
		TPS613223A		400		m Ω	
		TPS613226A		190		m Ω	
$R_{DS(on)_HS}$	High side switch on resistance	TPS61322		1300		m Ω	
		TPS613221A		1000		m Ω	
		TPS613222A		750		m Ω	
		TPS613223A		1680		m Ω	
		TPS613226A		950		m Ω	
I_{LIM}	Peak switch current limit	TPS61322		0.50	0.75	1.20	A
		TPS613221A		0.75	1.20	1.60	A
		TPS613222A		1.10	1.80	2.50	A
		TPS613223A		0.42	0.75	1.2	A
		TPS613226A		0.75	1.20	1.60	A
Protection							
T_{SD}	Over-temperature protection	T_J rising		150		$^{\circ}\text{C}$	
T_{SD_HYS}	Over-temperature protection hysteresis			20		$^{\circ}\text{C}$	

6.6 Typical Characteristics

T_J = 25°C unless otherwise noted.

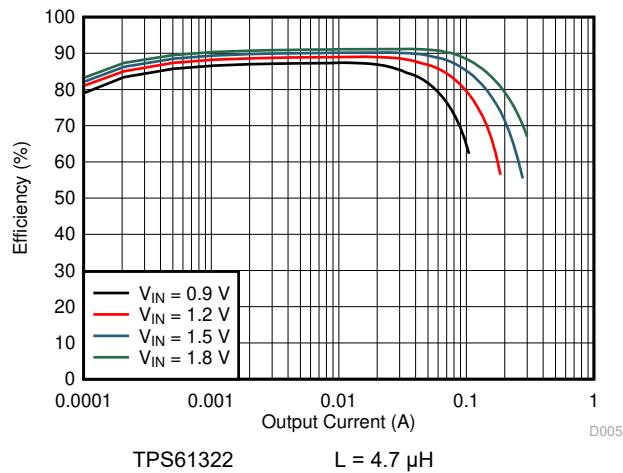

6-1. Load Efficiency with Different Inputs

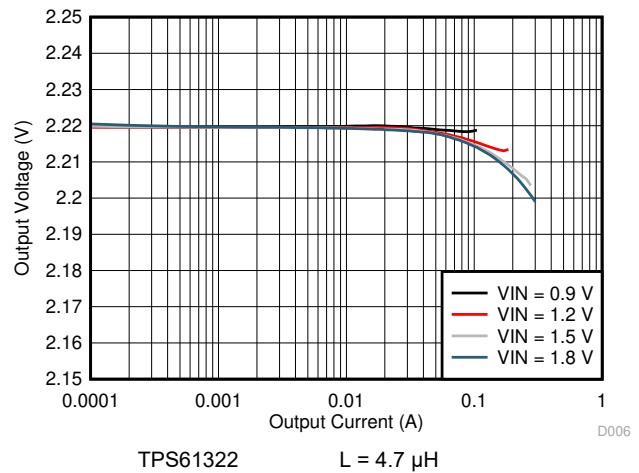

6-2. Load Regulation

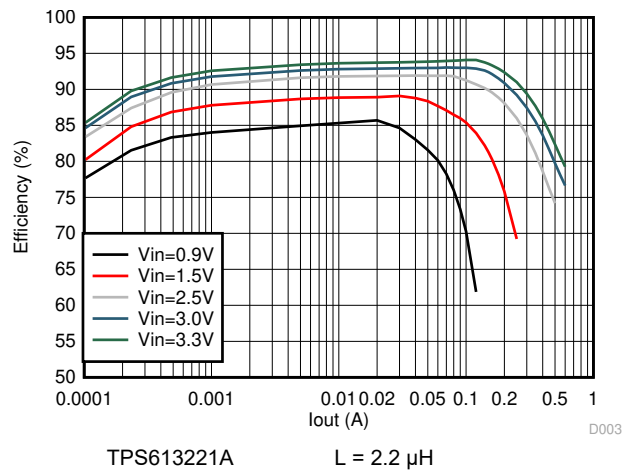

6-3. Load Efficiency with Different Inputs

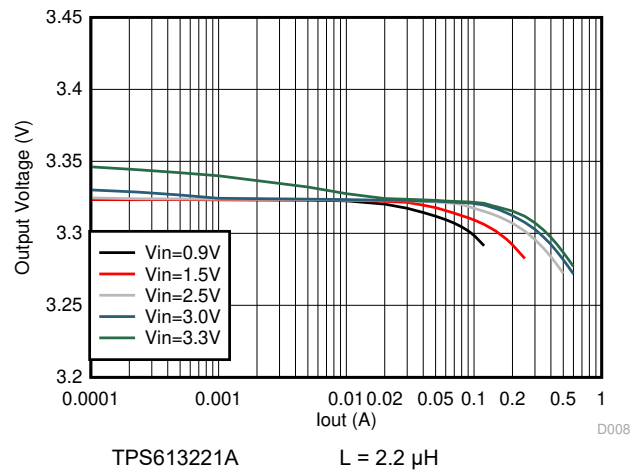

6-4. Load Regulation

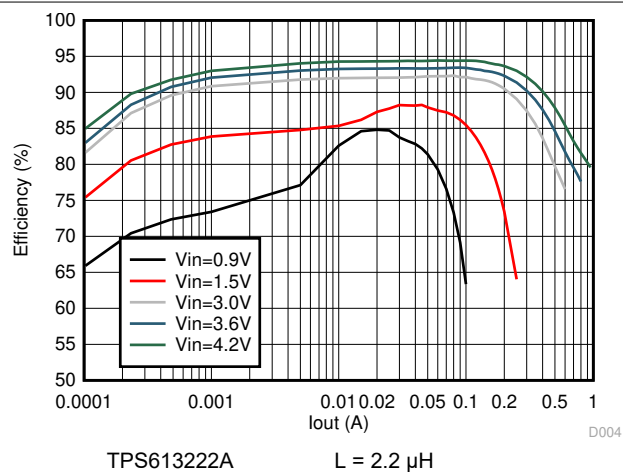

6-5. Load Efficiency with Different Inputs

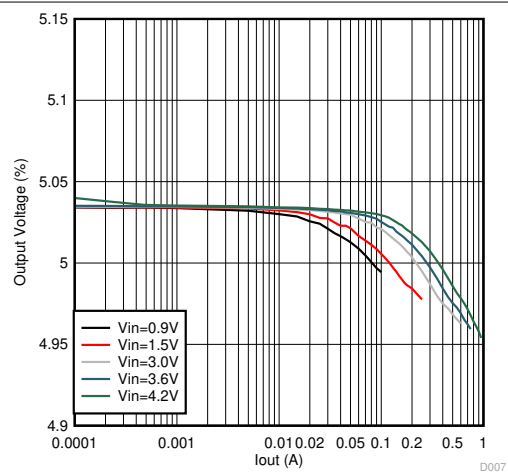

6-6. Load Regulation

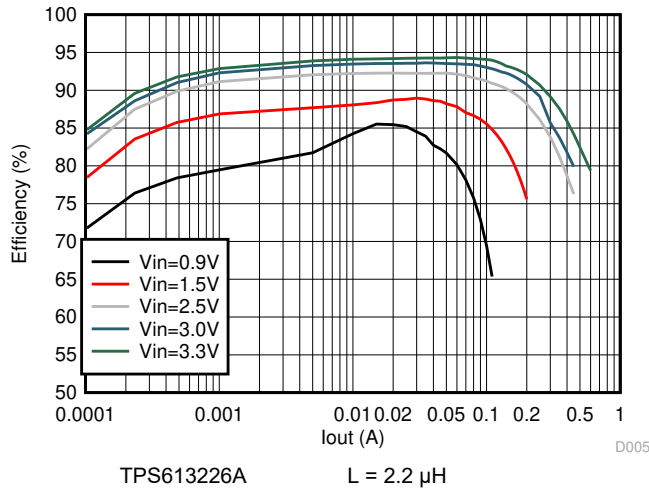

6-7. Load Efficiency with Different Inputs

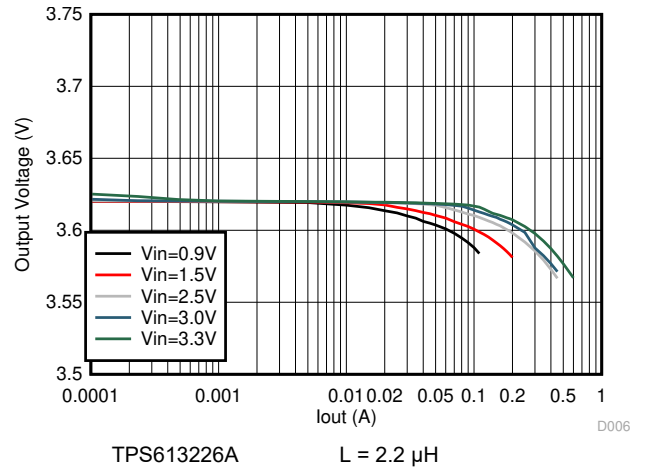

6-8. Load Regulation

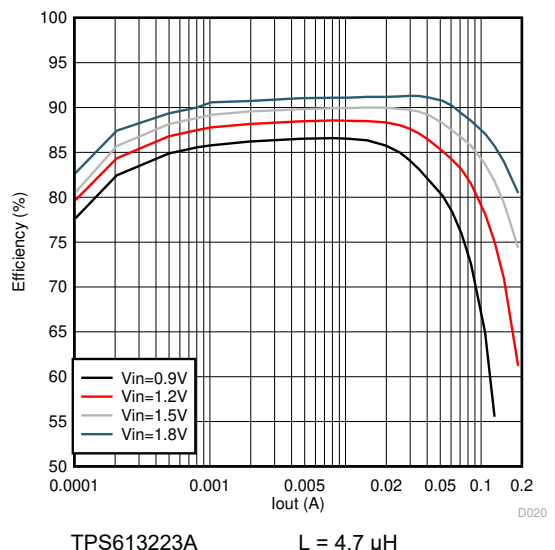

6-9. Load Efficiency with Different Inputs

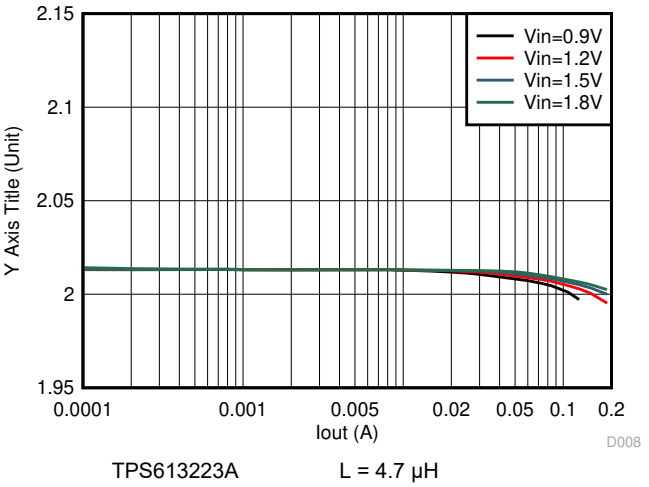

6-10. Load Regulation

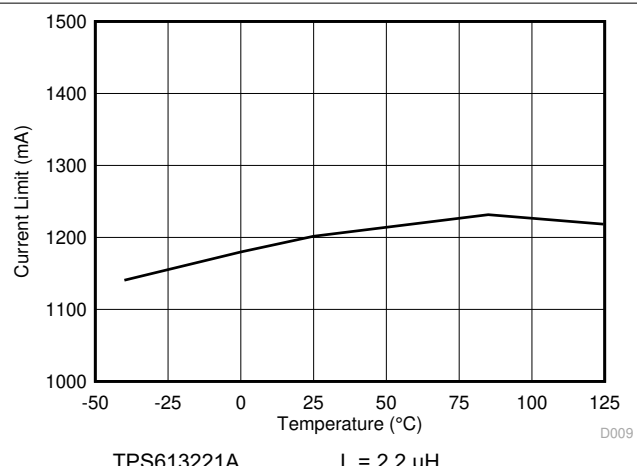

6-11. Current Limit with Different Temperature

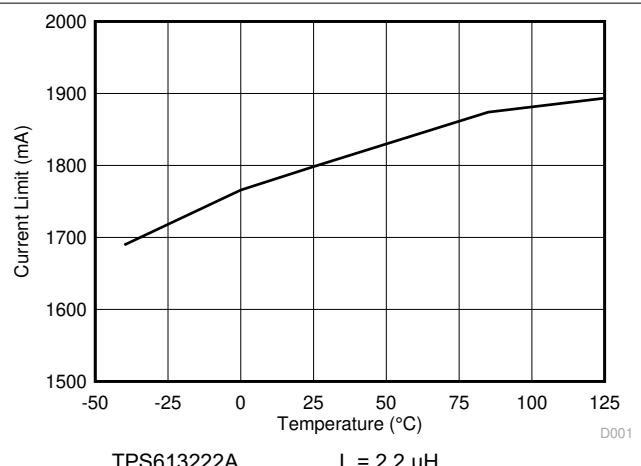

6-12. Current Limit with Different Temperature

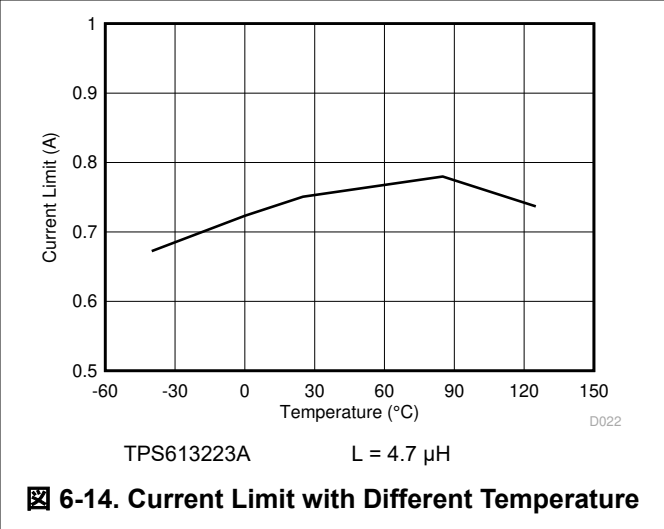
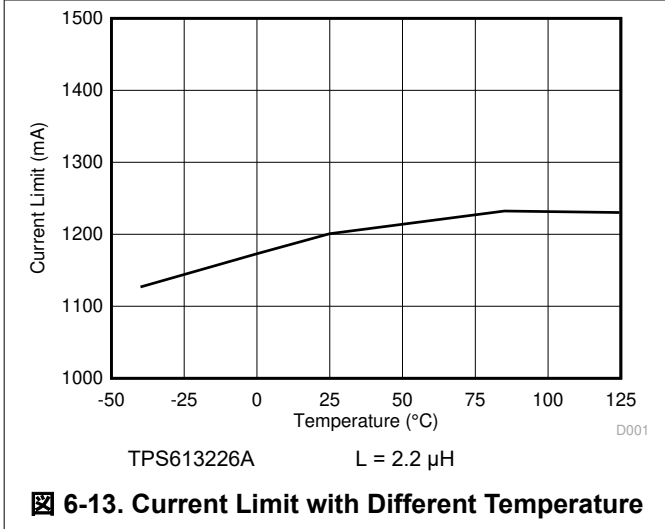

7 Detailed Description

7.1 Overview

The TPS61322xx is a low quiescent current, high efficiency synchronous boost converter. The TPS61322xx uses hysteretic current control scheme. The TPS61322xx is designed for systems powered by alkaline battery, NiMH rechargeable battery, Li-ion battery or Li-polymer battery. The input voltage range is from 0.9 V to 5.5 V. After start-up is completed, the TPS61322xx can work with the input voltage down to 0.4 V. The TPS61322xx consumes only 6.5- μ A quiescent current and achieves high efficiency under light load conditions. The TPS61322xx is designed as an always-on power. Higher than 90% efficiency is achieved under 10-mA load from 1.5-V input voltage to 2.2-V output voltage conversion to extend battery lifetime. The TPS61322A can support as high as 500-mA output current from 3-V input voltage to 5-V output voltage conversion with an external schottky diode in parallel with internal high-side MOSFET.

7.2 Functional Block Diagram

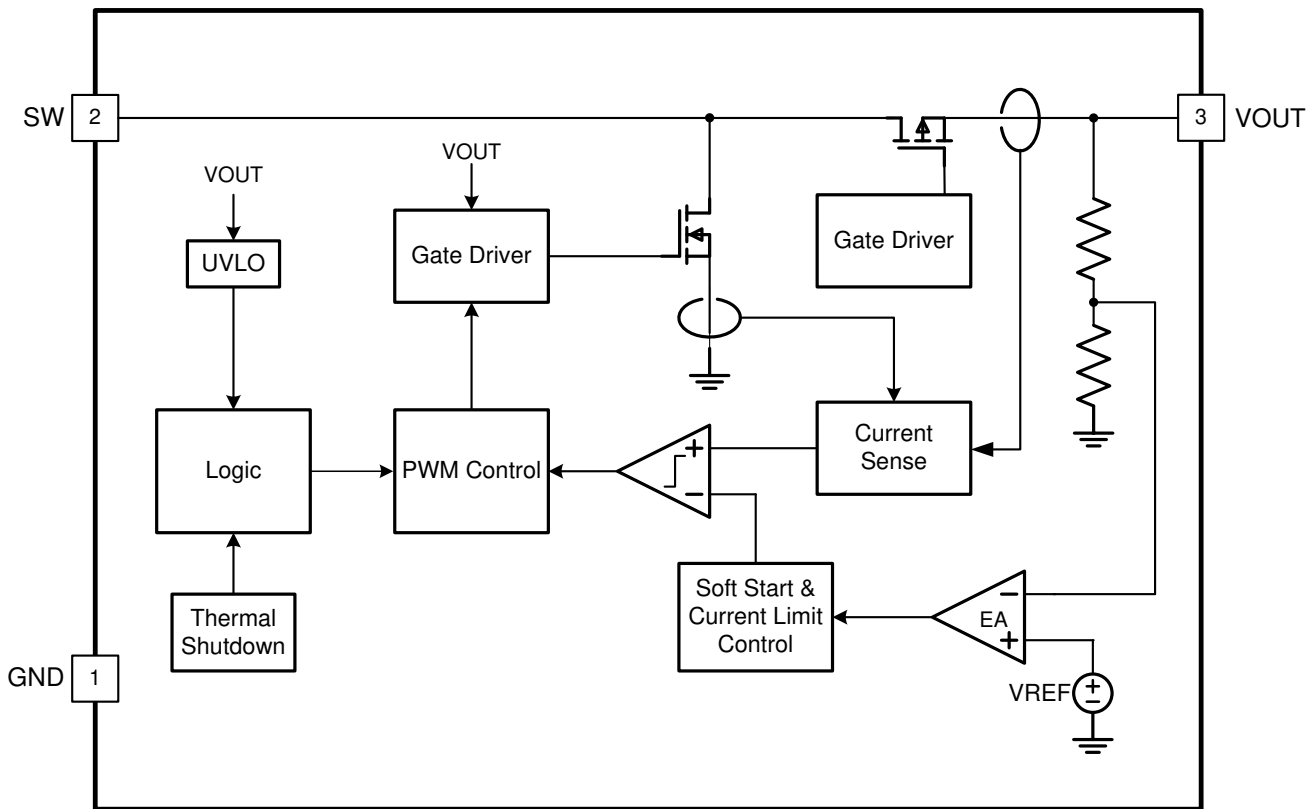

Copyright © 2017, Texas Instruments Incorporated

7.3 Feature Description

7.3.1 Soft Start

When the input voltage is applied, the high side MOSFET is turned on. The input voltage charges the output capacitors through the inductor and the high side MOSFET. When the output capacitors are charged to 0.83-V typical value, the TPS61322xx starts switching at 1.6-MHz fixed frequency and the high-side MOSFET is turned off. When the output voltage goes up to typical 1.6 V, an internal soft-start control circuit ramps the reference voltage to 0.8 V within 2 ms. In this way, the soft-start function reduces the input inrush current. After the output voltage reaches the target value, soft start ends, and the inductor peak current is determined by the output of an internal error amplifier. After start-up, the TPS61322xx can work with the input voltage down to 0.4 V.

7.3.2 Boost Controller Circuit

The TPS61322xx boost converter is controlled by a hysteretic current mode scheme. The TPS61322xx regulates the output voltage by keeping the inductor ripple constant of 200-mA typical value and adjusting the offset of this inductor current depending on the output load. If the required average input current is lower than average inductor current defined by this constant ripple current, the inductor current becomes discontinuous to keep the efficiency high under light load conditions. [Figure 7-1](#) illustrates the hysteretic current operation.

The output voltage V_{OUT} is monitored via the internal feedback network connected to a voltage error amplifier. To regulate the output voltage, the voltage error amplifier compares this feedback voltage to the internal voltage reference and adjusts the required offset of the inductor current accordingly.

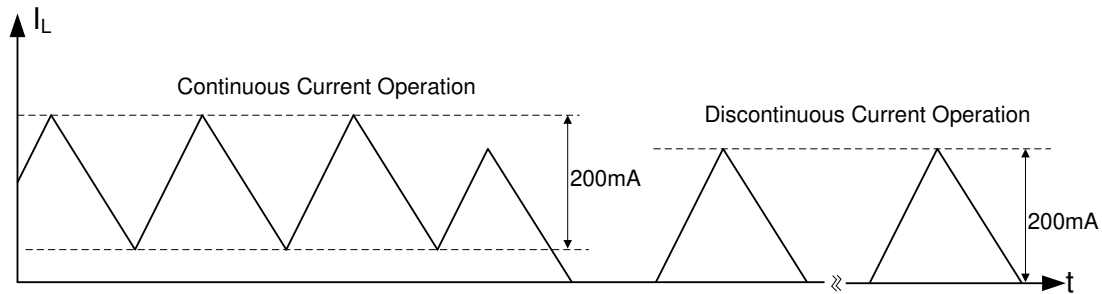

Figure 7-1. Hysteretic Current Operation

7.3.3

The TPS61322xx boost converter can increase the output load capacity by connecting an external schottky diode from SW pin to VOUT pin. Higher than 500 mA output current is supported for 5-V output voltage applications such as USB OTG and HDMI power supply. For such applications, an adaptive constant off time circuit will generate the signal to turn off high-side FET. The inductor current ripple is greater than 200 mA if with this external diode. A higher inductance can help reduce the inductor current ripple.

7.3.4 Undervoltage Lockout

An undervoltage lockout function stops operation of the converter if the input voltage drops below the typical undervoltage lockout threshold of 0.4 V while the output voltage is still higher than 1.8 V. A hysteresis of 100 mV is added so that the device does not switch again until the input voltage goes up to 0.5 V.

7.3.5 Current Limit Operation

The TPS61322xx employs cycle-by-cycle peak current limit operation. If the inductor peak current hits the peak current limit I_{LIM} , the low-side MOSFET is turned off and stops the further increase of the inductor current. In this case the output voltage drops until power balance between the input side and output side is achieved. If the output voltage drops below the input voltage, the inductor current will be clamped by the DCR of the inductor and the on-resistance ($R_{ds,on}$) of the high-side MOSFET.

7.3.6 Overtemperature Protection

The TPS61322xx has a built-in temperature sensor which monitors the internal junction temperature in boost mode operation. If the junction temperature exceeds the threshold 150°C, the device stops operating. As soon as the junction temperature drops below the shutdown temperature minus the hysteresis, typically 130°C, the device starts operating again.

7.3.7 Device Functional Modes

- [セクション 7.3.2](#) - Continuous and discontinuous current operation
- Protective mechanisms
 - [セクション 7.3.5](#)
 - [セクション 7.3.4](#)
 - [セクション 7.3.6](#)

8 Application and Implementation

注

以下のアプリケーション情報は、TI の製品仕様に含まれるものではなく、TI ではその正確性または完全性を保証いたしません。個々の目的に対する製品の適合性については、お客様の責任で判断していただくこととなります。お客様は自身の設計実装を検証しテストすることで、システムの機能を確認する必要があります。

8.1 Application Information

The TPS61322xx is designed to operate at a wide input voltage range from 0.9-V to 5.5-V. The minimum peak switch current limit is 0.5 A for TPS61322, with 0.75 A for TPS613221A and 1.1 A for TPS613222A. The TPS61322xx supports output voltage from 1.8 V to 5.5 V with increment of 0.1 V, refer to [セクション 4](#) for device details to select the right device for the target applications. Use the following design procedure to select component values for the TPS61322xx.

8.2 Typical Application

8.2.1 Boost without Schottky Diode

A typical application example is the wireless mouse, which normally requires 2.2-V voltage as its supply voltage and consumes less than 50-mA current from one-cell alkaline battery. The following design procedure can be used to select external component values for TPS61322xx.

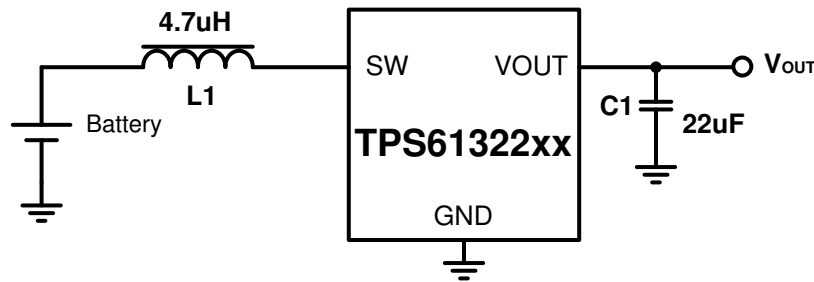

Copyright © 2017, Texas Instruments Incorporated

図 8-1. Typical Application Circuit without Schottky Diode

8.2.1.1 Design Requirements

表 8-1. Design Requirements

PARAMETERS	VALUES
Input voltage	0.9 V to 1.6 V
Output voltage	2.2 V
Output current	50 mA
Output voltage ripple	±10 mV

8.2.1.2 Detailed Design Procedure

8.2.1.2.1 Custom Design With WEBENCH® Tools

[Click here](#) to create a custom design using the TPS61322 device with the WEBENCH® Power Designer.

1. Start by entering the input voltage (V_{IN}), output voltage (V_{OUT}), and output current (I_{OUT}) requirements.
2. Optimize the design for key parameters such as efficiency, footprint, and cost using the optimizer dial.
3. Compare the generated design with other possible solutions from Texas Instruments.

The WEBENCH Power Designer provides a customized schematic along with a list of materials with real-time pricing and component availability.

In most cases, these actions are available:

- Run electrical simulations to see important waveforms and circuit performance
- Run thermal simulations to understand board thermal performance
- Export customized schematic and layout into popular CAD formats
- Print PDF reports for the design, and share the design with colleagues

Get more information about WEBENCH tools at www.ti.com/WEBENCH.

8.2.1.2.2 Maximum Output Current

For boost converters, the maximum output current capability is determined by the input to output ratio, the efficiency, the inductor current ripple and the current limit. The maximum output current can be estimated by [式 1](#)

$$I_{OUT (max)} = \frac{V_{IN} \times (I_{LIM} - \frac{I_{LH}}{2}) \times \eta}{V_{OUT}} \quad (1)$$

where

- I_{LIM} is the peak inductor current limit
- I_{LH} is the inductor current ripple
- η is the boost converter power convert efficiency

Minimum input voltage, maximum boost output voltage and minimum current limit should be used as the worst case condition for the estimation.

In this example, assume the power efficiency is 70% at the minimum input voltage of 0.9 V. The calculated maximum output current is 114 mA, which satisfies the application requirements.

8.2.1.2.3 Inductor Selection

Because the inductor affects steady state operation, transient behavior, and loop stability, the inductor is the most important component in power regulator design. There are three important inductor specifications, inductor value, saturation current, and dc resistance (DCR).

The TPS61322xx is optimized to work with inductor values between 0.7 μ H and 13 μ H. The inductor values affect the switching frequency. The estimated switching frequency in continuous conduction mode (CCM) can be calculated by [式 2](#). The switching frequency f_{SW} is not a constant value, which is determined by the inductance, the inductor current ripple, the input voltage and the output voltage. The current ripple I_{LH} is fixed to 200 mA typically, but it can be affected by the inductor value indirectly. Normally when a smaller inductor value is applied, the inductor current ramps up and down more quickly. The current ripple becomes bigger because the internal current comparator has delay to respond. If a smaller inductor peak current is required in applications, a higher inductor value can be used. However, The inductor and output capacitor must be considered together for the loop stability. The output capacitor and the inductance will influence the bandwidth and phase margin of the converter. Consequently, with a larger inductor, a bigger capacitor normally must be used to ensure the same L/C ratio for a stable loop. For best stability consideration, a 4.7- μ H inductor is recommended for 2.2-V output voltage application.

$$f_{sw} = \frac{V_{IN} \times (V_{OUT} - V_{IN} \times \eta)}{L \times I_{LH} \times V_{OUT}} \quad (2)$$

where

- f_{sw} is the switching frequency of the converter
- I_{LH} is the inductor current ripple
- η is the boost converter power convert efficiency

Having selected the inductance value, follow 式 3 to 式 5 to calculate the inductor's peak current for the application. Depending on different load conditions, the TPS61322xx works in continuous current mode or discontinuous conduction mode(DCM). In different modes, the peak currents of the inductor are also different. 式 3 provides an easy way to estimate whether the device works in CCM or DCM. 式 4 shows the peak current when the device works in CCM and 式 5 shows the peak current when the device works in DCM.

$$\frac{V_{OUT} \times I_{OUT}}{V_{IN} \times \eta} > \frac{I_{LH}}{2} \quad (3)$$

where

- I_{LH} is the inductor current ripple
- η is the boost converter power convert efficiency

$$I_{L,peak} = \frac{V_{OUT} \times I_{OUT}}{V_{IN} \times \eta} + \frac{I_{LH}}{2} \quad (4)$$

where

- $I_{L,peak}$ is the peak current of the inductor
- I_{LH} is the inductor current ripple
- η is the boost converter power convert efficiency

$$I_{L,peak} = I_{LH} \quad (5)$$

where

- $I_{L,peak}$ is the peak inductor.
- I_{LH} is the inductor current ripple

The saturation current of the inductor must be higher than the calculated peak inductor current, otherwise the excessive peak current in the inductor harms the device and reduces the system reliability.

8.2.1.2.4

In this example, the maximum load for the boost converter is 50 mA, the minimum input voltage is 0.9 V, and the efficiency under this condition can be estimated at 80%, so the boost converter works in continuous operation mode by the calculation. The inductor peak current is calculated as 258 mA. To have some margin, a 4.7- μ H inductor with at least 300 mA saturation current is recommended for this application. A 10- μ H inductor can be used as well by increasing the output capacitance to higher than 22 μ F to make the loop stable. 表 8-2 lists the recommended inductors for TPS61322xx device.

表 8-2. List of Inductors

INDUCTAN CE [μ H]	SATURATION CURRENT [A]	DC RESISTANC E [m Ω]	SIZE (L*W*H)(mm)	PART NUMBER	MANUFACTURER ⁽¹⁾
4.7	1.7	165	2.5 × 2 × 1.2	DFE252012P-4R7M=P2	MURATA
4.7	1.5	141	3 × 3 × 1.5	74438335047	Wurth

表 8-2. List of Inductors (続き)

INDUCTANCE [μH]	SATURATION CURRENT [A]	DC RESISTANCE [mΩ]	SIZE (L×W×H)(mm)	PART NUMBER	MANUFACTURER ⁽¹⁾
4.7	1.5	209	2.5 × 2 × 1.2	SDEM25201B-4R7MS	CYNTEC

(1) See [Third-party Products Disclaimer](#)

8.2.1.2.5 Capacitor Selection

For better output voltage filtering, TI recommends low ESR X5R or X7R ceramic capacitors.

For the output capacitor at the VOUT pin, TI recommends small ceramic capacitors. Place the capacitors as close as possible to the VOUT and GND pins of the device to depress the SW spike. The device can normally work with SW negative spike of -0.7V within 1ns. However, larger negative spike may potentially shoot the MOSFET inside. If, for any reason, the application requires the use of large capacitors that cannot be placed close to the device, the use of a small ceramic capacitor with a capacitance value of 1μF in parallel to the large one is recommended. Place this small capacitor as close as possible to the VOUT and GND pins of the device.

Considering loop stability, for inductance of 4.7 μH, the minimal output capacitor value is 10 μF (effective value). Refer to [表 8-3](#) for inductor and capacitor combination. Increasing the output capacitor makes the output ripple smaller.

When selecting capacitors, ceramic capacitor's derating effect under DC bias voltage must be considered. Choose the right nominal capacitance by checking capacitor's DC bias characteristics. In this example, GRM188R60J106ME84D, which is a 10-μF ceramic capacitor with high effective capacitance value at DC biased condition, is selected for V_{OUT} rail. Two 10-μF capacitors in parallel are recommended to get the desired effective capacitance.

8.2.1.2.6

表 8-3. List of Inductor and Capacitor

INDUCTANCE [μH]	CAPACITANCE [μF]	LOAD [mA]	PACKAGE	PART NUMBER	MANUFACTURER ⁽¹⁾
1.0	2 × 10	50	0603	GRM188R60J106ME84D	MURATA
2.2	2 × 10	50	0603	GRM188R60J106ME84D	MURATA
4.7	22	50	0805	GRM21BZ71A226ME15	MURATA

(1) See [Third-party Products Disclaimer](#)

8.2.1.3 Application Curves

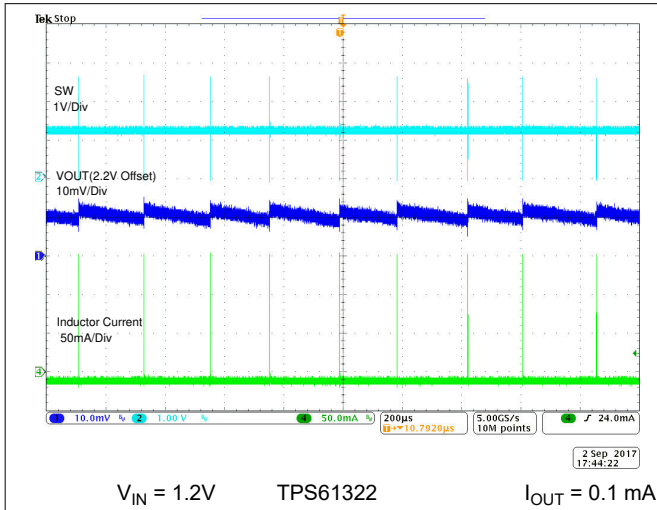

8-2. Switching Waveform at Light Load

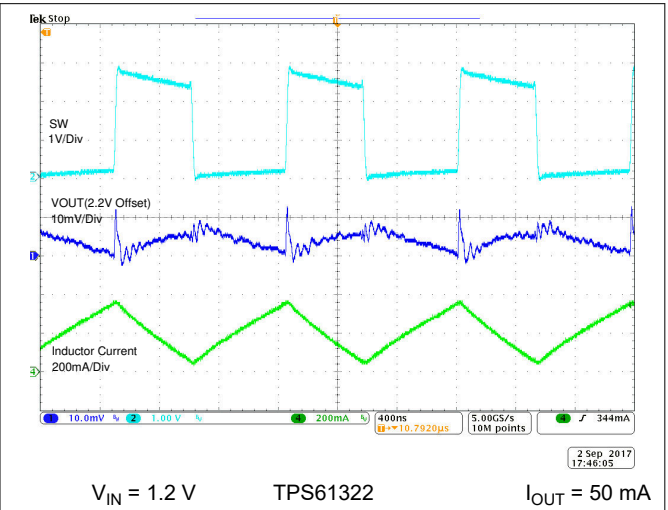

8-3. Switching Waveform at Heavy Load

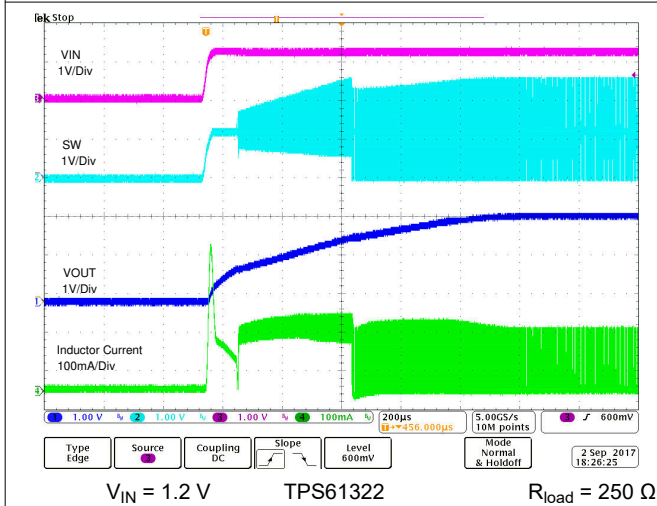

8-4. Start-up by VIN

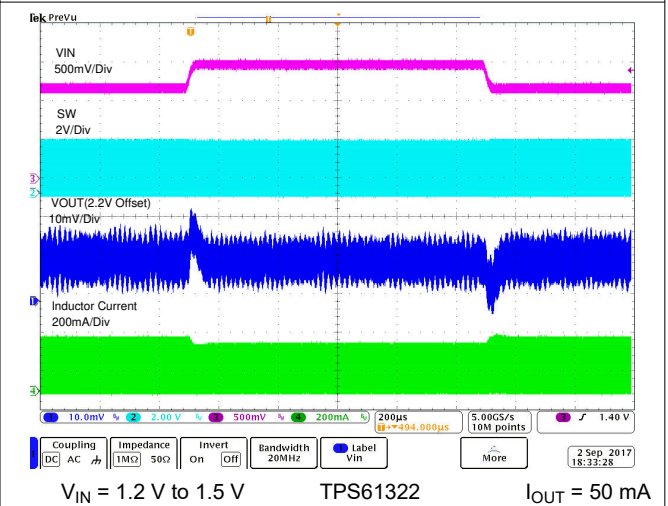

8-5. Line Transient

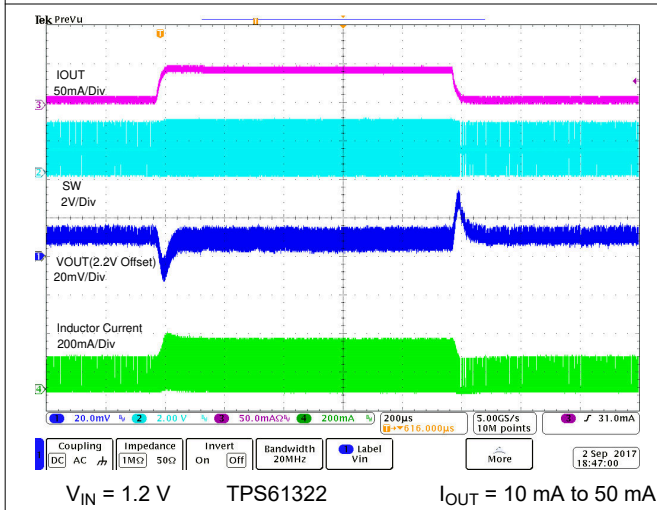

8-6. Load Transient

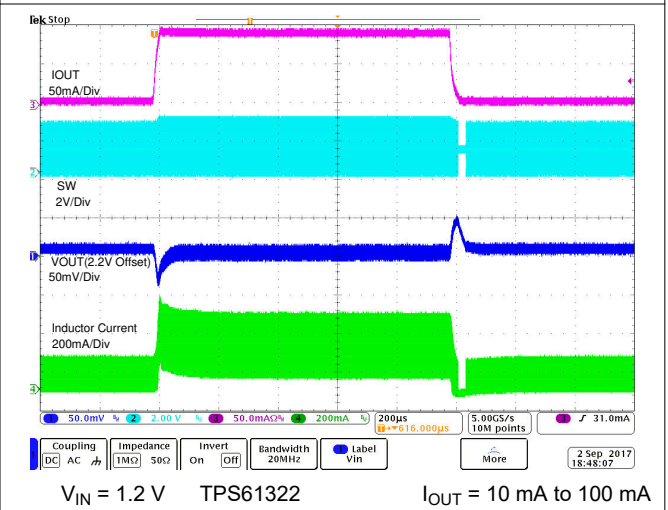

8-7. Load Transient

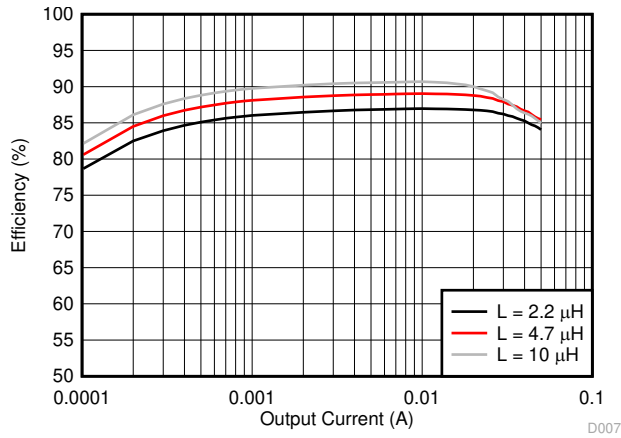

Würth Electronics, 74438335XXX family

2.2 μH, 4.7 μH, 10 μH

$V_{IN} = 1.2\text{ V}$

TPS61322

図 8-8. Efficiency with Different Inductance

8.2.2 Boost with Schottky Diode

Another typical application example is the USB OTG which normally requires 5-V output as its supply voltage and consumes as high as 500-mA current. The following design procedure can be used to select external component values for this application.



図 8-9. Typical Application Circuit with Schottky Diode

8.2.2.1 Design Requirements

表 8-4. Design Requirements

PARAMETERS	VALUES
Input voltage	3 V to 4.35 V
Output voltage	5 V
Output current	500 mA
Output voltage ripple	± 25 mV

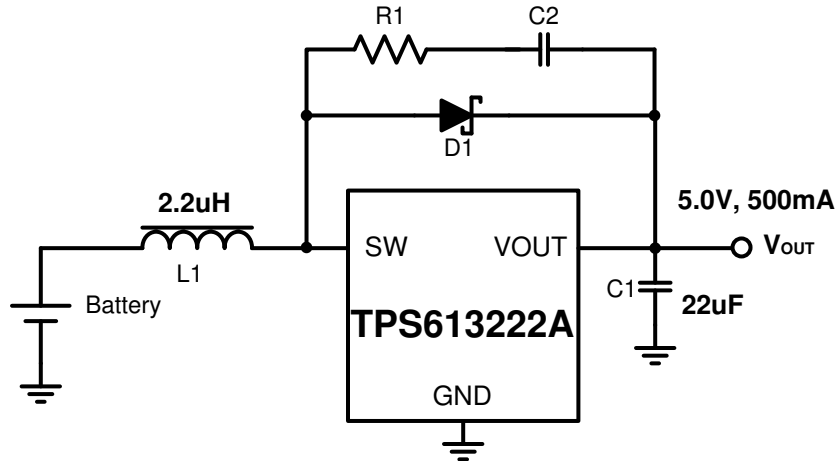
8.2.2.2 Detailed Design Procedure

8.2.2.2.1 Inductor Selection

The peak current is calculated according to 式 4 and 式 5. The saturation current of the inductor must be higher than the calculated peak inductor current.

In this example, the maximum load for the boost converter is 500 mA, and the minimum input voltage is 3 V. Assuming the efficiency under this condition is 90%, and a typical 2.2-μH inductor is adopted in this application, so the boost converter works in continuous operation mode by the calculation. The current ripple is 500mA and the inductor peak current is calculated as 1.18 A. To leave some margin, a 2.2-μH inductor with at least 1.4-A saturation current is recommended for this application. 表 8-5 lists the recommended inductors for TPS61322A device.

表 8-5. List of Inductors

INDUCTANCE [μH]	SATURATION CURRENT [A]	DC RESISTANCE [mΩ]	SIZE (L×W×H) (mm)	PART NUMBER	MANUFACTURER ⁽¹⁾
2.2	2.3	82	2.5 × 2 × 1.2	DFE252012F-2R2M	MURATA
2.2	2.4	89	2.5 × 2 × 1	HMLQ25201T-2R2MSR	CYNTEC
2.2	2.5	75	3.2 × 2.5 × 1.2	HMME32251B--2R2MS	CYNTEC

(1) See [Third-party Products Disclaimer](#)

8.2.2.2.2 Schottky Diode Selection

The high switching frequency of TPS61322xx demands a high-speed rectifying switch for optimum efficiency. Ensure that the average and peak current rating of the diode exceeds the average output current and peak inductor current. In addition, the reverse breakdown voltage of the diode must exceed the maximum output voltage of the converter. A snubber circuit consisting of a resistor R1 and a capacitor C2 is needed if the Schottky diode D1 is soldered. The capacitance of C2 must be larger than triple times of the diode capacitance. The typical value of the resistor R1 is 5 Ω, and the typical value of the capacitor C2 is 120 pF.

8.2.2.2.3 Capacitor Selection

Refer to [セクション 8.2.1.2.5](#) for the detailed design steps.表 8-6 lists the recommended inductor and capacitor combination. Three 10-μF capacitors in parallel are recommended to get the desired effective capacitance.

表 8-6. List of Inductor and Capacitor

INDUCTANCE [μH]	CAPACITANCE [μF]	LOAD [mA]	PACKAGE	PART NUMBER	MANUFACTURER ⁽¹⁾
1	3 × 10	500	0603	GRM188R60J106ME84D	MURATA
2.2	3 × 10	500	0603	GRM188R60J106ME84D	MURATA
4.7	2 × 22	500	0805	GRM21BZ71A226ME15	MURATA

(1) See [Third-party Products Disclaimer](#)

8.2.2.3 Application Curves



図 8-10. Switching Waveform at Light Load



図 8-11. Switching Waveform at Heavy Load

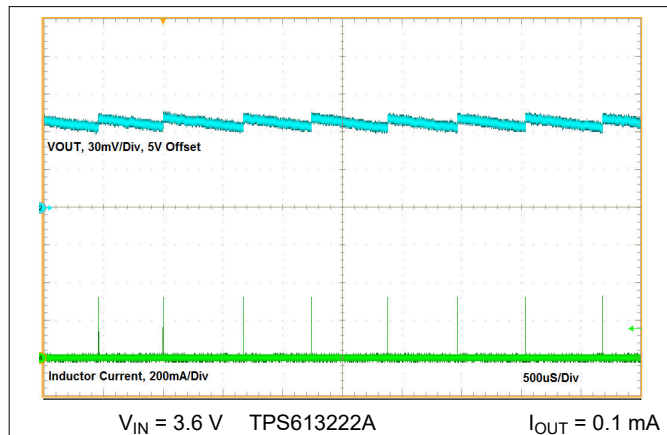

図 8-12. Switching Waveform at Heavy Load

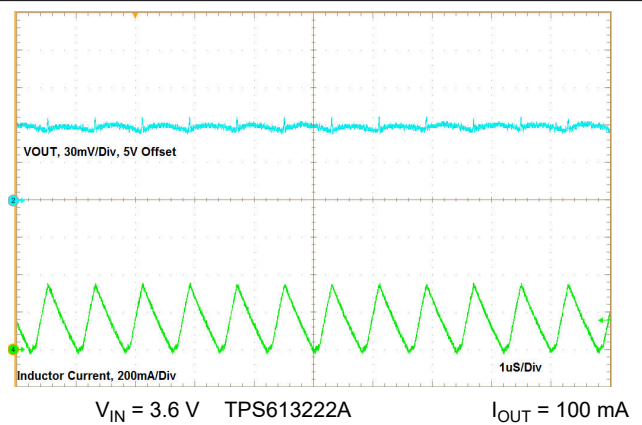

図 8-13. Start-up by VIN

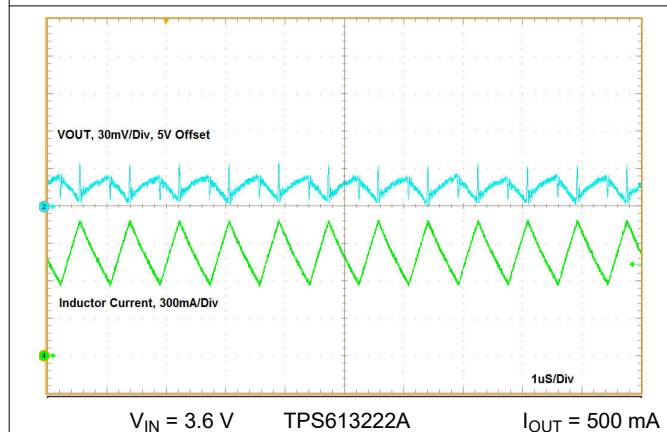

$V_{IN} = 2.7\text{ V to } 4.3\text{ V}$ TPS613222A $I_{OUT} = 500\text{ mA}$

8-14. Line Transient

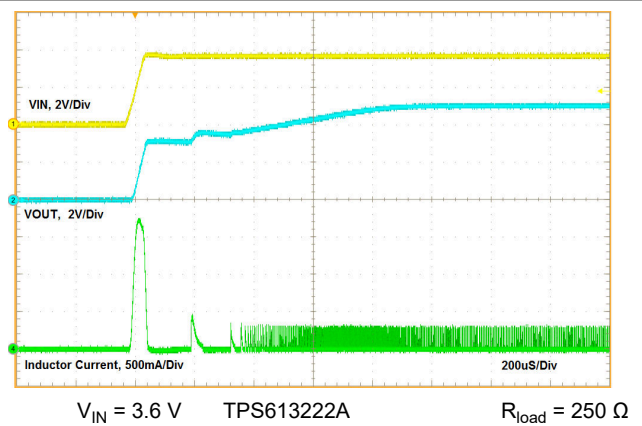
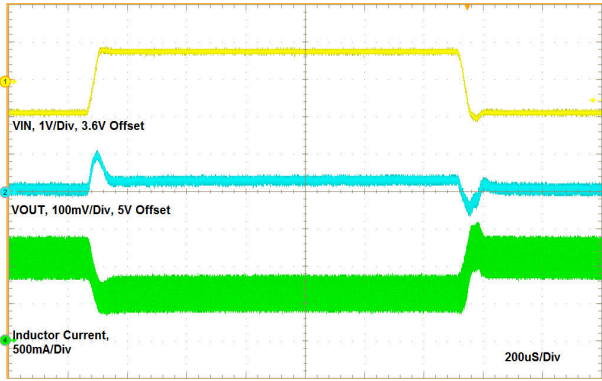
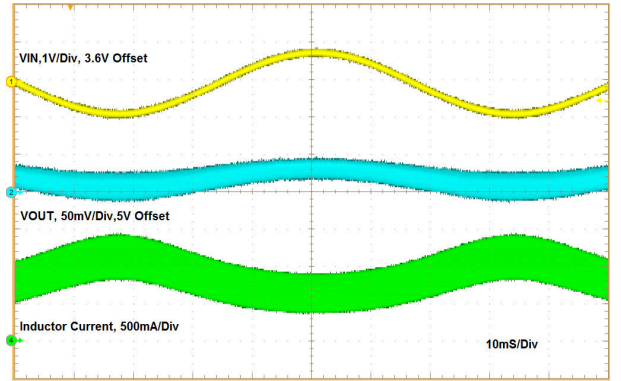

$V_{IN} = 2.7\text{ V to } 4.4\text{ V}$ TPS613222A $I_{OUT} = 500\text{ mA}$

8-15. Line Regulation

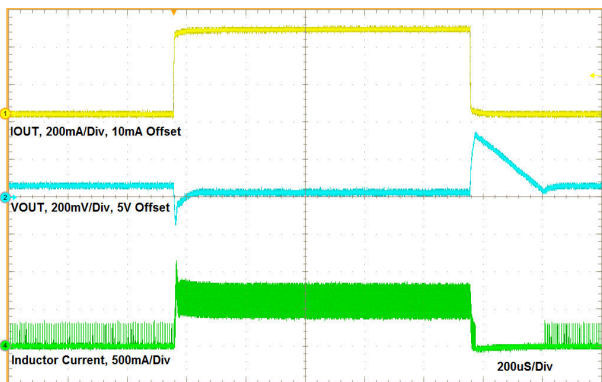

$V_{IN} = 3.6\text{ V}$ TPS613222A $I_{OUT} = 10\text{ mA to } 500\text{ mA}$

8-16. Load Transient

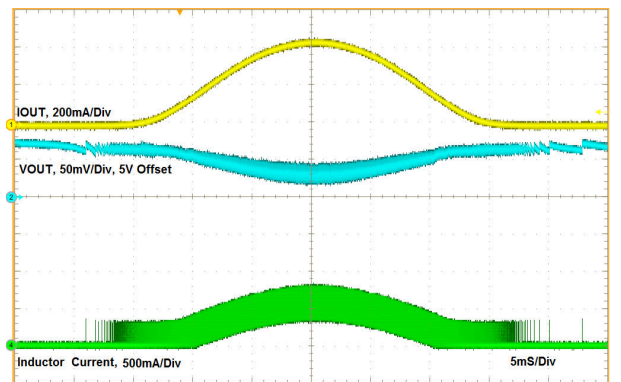

$V_{IN} = 3.6\text{ V}$ TPS613222A $I_{OUT} = 0\text{ mA to } 500\text{ mA}$

8-17. Load Regulation

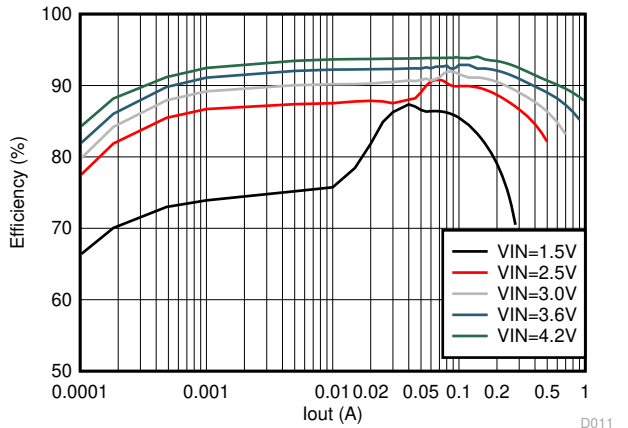

8-18. Efficiency with Different Input Voltage

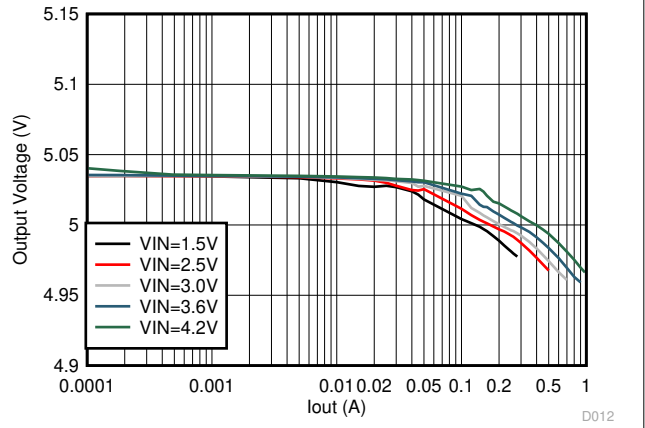

8-19. Load Regulation

8.3 System Examples

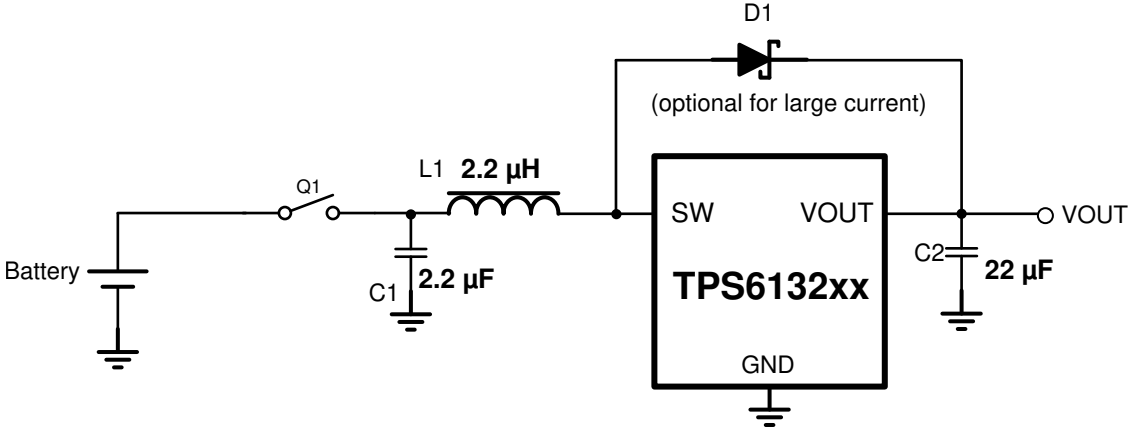
TPS61322xx can be easily shut down with an external switch Q1 as shown in  8-20. The switch can be mechanical switch, a P-channel MOSFET, or a PNP transistor. For a mechanical switch, there is no control logic needed to turn on or turn off the switch.

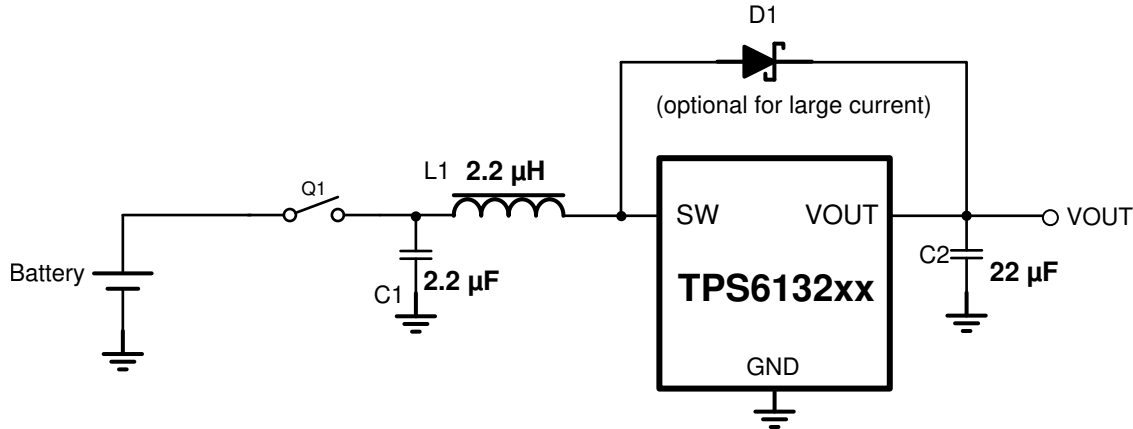

Copyright © 2017, Texas Instruments Incorporated

 8-20. True Shutdown for TPS61322xx

8.3.1 Detail Design Schematics

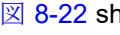
The  8-21 shows the application circuit when the power supply of the micro controller unit (MCU) is not less than the battery voltage. The  8-22 shows the application circuit when the power supply of the micro controller unit (MCU) is less than the battery voltage

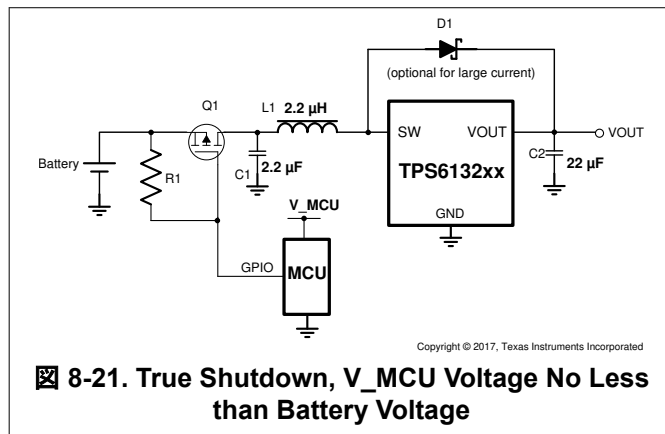

Copyright © 2017, Texas Instruments Incorporated

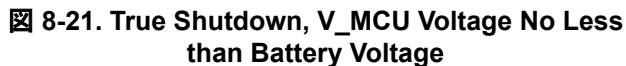
 8-21. True Shutdown, V_MCU Voltage No Less than Battery Voltage

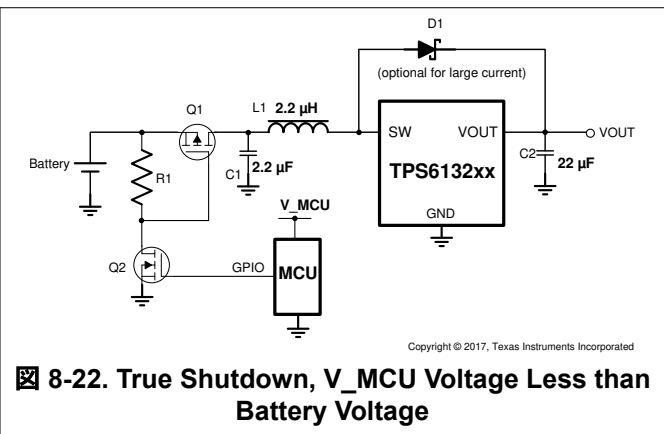

Copyright © 2017, Texas Instruments Incorporated

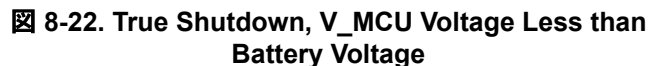
 8-22. True Shutdown, V_MCU Voltage Less than Battery Voltage

9 Power Supply Recommendations

The TPS61322xx is designed to operate from an input voltage supply range between 0.9 V to 5.5 V. The power supply can be alkaline battery, NiMH rechargeable battery, Li-Mn battery or rechargeable Li-ion battery. The input supply must be well regulated with the rating of the TPS61322xx.

10 Layout

10.1 Layout Guidelines

As for all switching power supplies, the layout is an important step in the design, especially at high peak currents and high switching frequencies. If the layout is not carefully done, the regulator could show stability problems as well as EMI problems. Therefore, use wide and short traces for the main current path and for the power ground paths. Place the output capacitor, as well as the inductor, as close as possible to the device.

10.2 Layout Examples

A large ground plane on the top and bottom is good for thermal performance.

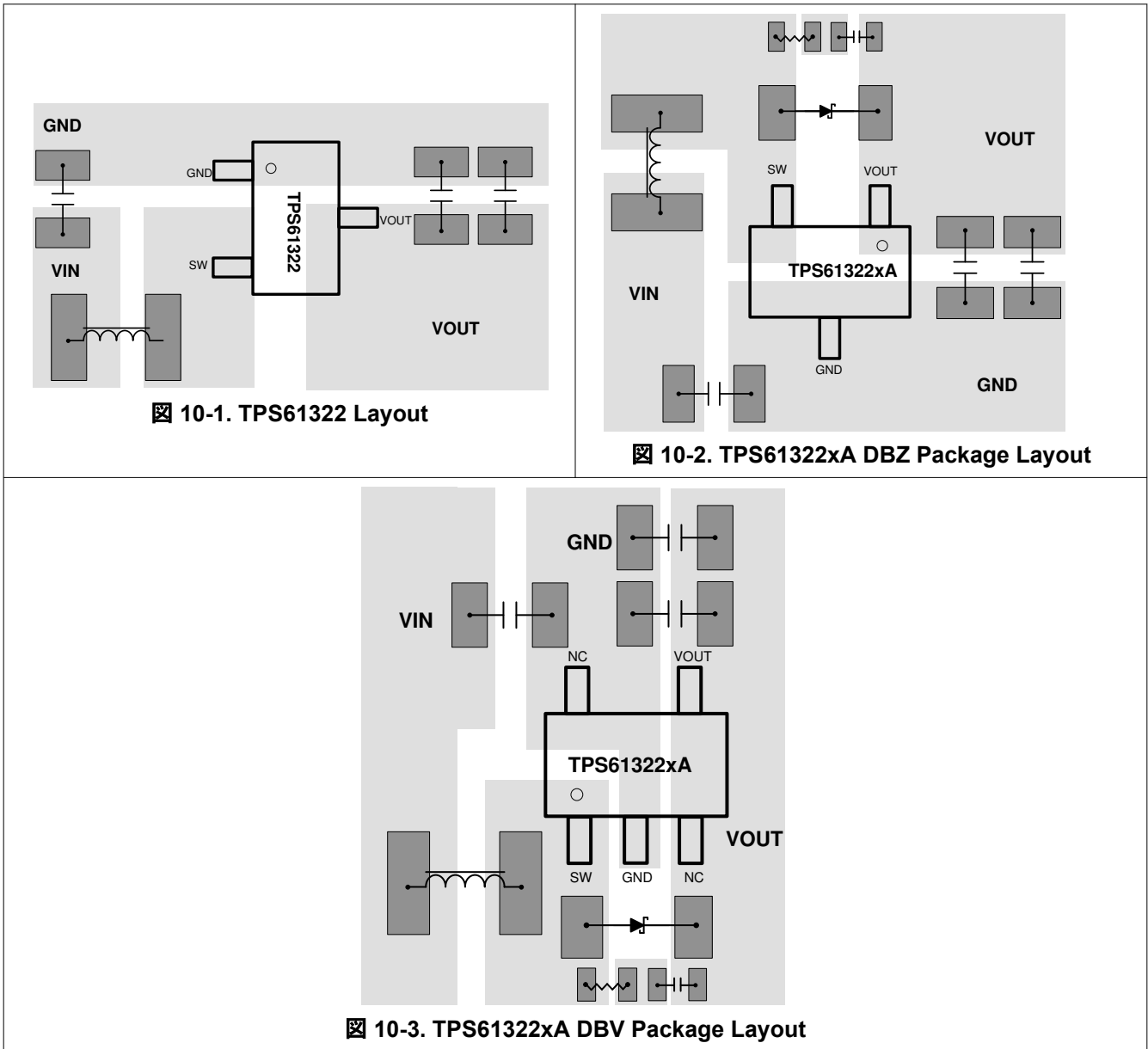

11 Device and Documentation Support

11.1 Device Support

11.1.1 サード・パーティ製品に関する免責事項

サード・パーティ製品またはサービスに関するテキサス・インスツルメンツの出版物は、単独またはテキサス・インスツルメンツの製品、サービスと一緒に提供される場合に関係なく、サード・パーティ製品またはサービスの適合性に関する是認、サード・パーティ製品またはサービスの是認の表明を意味するものではありません。

11.1.2 Development Support

11.1.2.1 Custom Design With WEBENCH® Tools

[Click here](#) to create a custom design using the TPS61322 device with the WEBENCH® Power Designer.

1. Start by entering the input voltage (V_{IN}), output voltage (V_{OUT}), and output current (I_{OUT}) requirements.
2. Optimize the design for key parameters such as efficiency, footprint, and cost using the optimizer dial.
3. Compare the generated design with other possible solutions from Texas Instruments.

The WEBENCH Power Designer provides a customized schematic along with a list of materials with real-time pricing and component availability.

In most cases, these actions are available:

- Run electrical simulations to see important waveforms and circuit performance
- Run thermal simulations to understand board thermal performance
- Export customized schematic and layout into popular CAD formats
- Print PDF reports for the design, and share the design with colleagues

Get more information about WEBENCH tools at www.ti.com/WEBENCH.

11.2 Documentation Support

11.2.1 Related Documentation

For related documentation see the following:

[TPS61322-BMC001 Evaluation Module User's Guide](#)

11.3 Receiving Notification of Documentation Updates

To receive notification of documentation updates, navigate to the device product folder on ti.com. In the upper right corner, click on *Alert me* to register and receive a weekly digest of any product information that has changed. For change details, review the revision history included in any revised document.

11.4 サポート・リソース

テキサス・インスツルメンツ E2E™ サポート・フォーラムは、エンジニアが検証済みの回答と設計に関するヒントをエキスパートから迅速かつ直接得ることができる場所です。既存の回答を検索したり、独自の質問をしたりすることで、設計に必要な支援を迅速に得ることができます。

リンクされているコンテンツは、各寄稿者により「現状のまま」提供されるものです。これらはテキサス・インスツルメンツの仕様を構成するものではなく、必ずしもテキサス・インスツルメンツの見解を反映したものではありません。テキサス・インスツルメンツの[使用条件](#)を参照してください。

11.5 Trademarks

テキサス・インスツルメンツ E2E™ is a trademark of Texas Instruments.

WEBENCH® is a registered trademark of Texas Instruments.

すべての商標は、それぞれの所有者に帰属します。

11.6 静電気放電に関する注意事項



この IC は、ESD によって破損する可能性があります。テキサス・インスツルメンツは、IC を取り扱う際には常に適切な注意を払うことを推奨します。正しい取り扱いおよび設置手順に従わない場合、デバイスを破損するおそれがあります。

ESD による破損は、わずかな性能低下からデバイスの完全な故障まで多岐にわたります。精密な IC の場合、パラメータがわずかに変化するだけで公表されている仕様から外れる可能性があるため、破損が発生しやすくなっています。

11.7 用語集

[テキサス・インスツルメンツ用語集](#) この用語集には、用語や略語の一覧および定義が記載されています。

12 Revision History

資料番号末尾の英字は改訂を表しています。その改訂履歴は英語版に準じています。

Changes from February 19, 2019 to February 21, 2024 (from Revision D (February 2019) to Revision E (February 2024))	Page
• Updated second paragraph with additional information.....	14

Changes from Revision C (May 2018) to Revision D (February 2019)	Page
• TPS61322 のタイトルから「疑似 GPN」を削除、「TPS61322xx」を「TPS61322」に変更。.....	1
• WEBENCH のリンクを追加.....	1
• Changed the NFET symbol in セクション 7.2	9
• Added セクション 7.3.7	10

Changes from Revision B (April 2018) to Revision C (May 2018)	Page
• Deleted Cross Reference to セクション 4 and the Electrical Characteristics table footnotes regarding device TPS61223A, that was <i>Product Preview</i> device in the SLVSDY5B revision.....	3
• Deleted Cross Reference to セクション 6.5 footnote regarding device TPS61223A, that was <i>Product Preview</i> in the SLVSDY5B revision.	5
• Added graphs pertaining to TPS613223A device to the Typical Characteristics matrix.	6

Changes from Revision A (January 2018) to Revision B (April 2018)	Page
• Deleted Cross Reference to セクション 4 and the Electrical Characteristics table footnotes regarding devices TPS61221A, TPS61222A, and TPS61226A that were <i>Product Preview</i> devices in the SLVSDY5A revision....	3
• Deleted Cross Reference to セクション 6.5 footnote regarding devices TPS61221A, TPS61222A, and TPS61226A that were <i>Product Preview</i> in the SLVSDY5A revision.	5
• Added 図 6-3 , 図 6-4 and 図 6-5	6
• Added 図 6-7 , 図 6-8 , and 図 6-11	6

Changes from Revision * (September 2017) to Revision A (January 2018)	Page
• 2018 年 1 月に量産データをリリース。.....	1

13 Mechanical, Packaging, and Orderable Information

The following pages include mechanical, packaging, and orderable information. This information is the most current data available for the designated devices. This data is subject to change without notice and revision of this document. For browser-based versions of this data sheet, refer to the left-hand navigation.

重要なお知らせと免責事項

テキサス・インスツルメンツは、技術データと信頼性データ(データシートを含みます)、設計リソース(リファレンス デザインを含みます)、アプリケーションや設計に関する各種アドバイス、Web ツール、安全性情報、その他のリソースを、欠陥が存在する可能性のある「現状のまま」提供しており、商品性および特定目的に対する適合性の黙示保証、第三者の知的財産権の非侵害保証を含むいかなる保証も、明示的または黙示的にかかわらず拒否します。

これらのリソースは、テキサス・インスツルメンツ製品を使用する設計の経験を積んだ開発者への提供を意図したものです。(1) お客様のアプリケーションに適したテキサス・インスツルメンツ製品の選定、(2) お客様のアプリケーションの設計、検証、試験、(3) お客様のアプリケーションに該当する各種規格や、その他のあらゆる安全性、セキュリティ、規制、または他の要件への確実な適合に関する責任を、お客様のみが単独で負うものとします。

上記の各種リソースは、予告なく変更される可能性があります。これらのリソースは、リソースで説明されているテキサス・インスツルメンツ製品を使用するアプリケーションの開発の目的でのみ、テキサス・インスツルメンツはその使用をお客様に許諾します。これらのリソースに関して、他の目的で複製することや掲載することは禁止されています。テキサス・インスツルメンツや第三者の知的財産権のライセンスが付与されている訳ではありません。お客様は、これらのリソースを自身で使用した結果発生するあらゆる申し立て、損害、費用、損失、責任について、テキサス・インスツルメンツおよびその代理人を完全に補償するものとし、テキサス・インスツルメンツは一切の責任を拒否します。

テキサス・インスツルメンツの製品は、[テキサス・インスツルメンツの販売条件](#)、または [ti.com](https://www.ti.com) やかかるテキサス・インスツルメンツ製品の関連資料などのいずれかを通じて提供する適用可能な条項の下で提供されています。テキサス・インスツルメンツがこれらのリソースを提供することは、適用されるテキサス・インスツルメンツの保証または他の保証の放棄の拡大や変更を意味するものではありません。

お客様がいかなる追加条項または代替条項を提案した場合でも、テキサス・インスツルメンツはそれらに異議を唱え、拒否します。

郵送先住所: Texas Instruments, Post Office Box 655303, Dallas, Texas 75265
Copyright © 2024, Texas Instruments Incorporated

PACKAGING INFORMATION

Orderable part number	Status (1)	Material type (2)	Package Pins	Package qty Carrier	RoHS (3)	Lead finish/ Ball material (4)	MSL rating/ Peak reflow (5)	Op temp (°C)	Part marking (6)
TPS613221ADBVR	Active	Production	SOT-23 (DBV) 5	3000 LARGE T&R	Yes	NIPDAU SN	Level-1-260C-UNLIM	-40 to 125	1N4L
TPS613221ADBVR.B	Active	Production	SOT-23 (DBV) 5	3000 LARGE T&R	Yes	NIPDAU	Level-1-260C-UNLIM	-40 to 125	1N4L
TPS613221ADBVT	Active	Production	SOT-23 (DBV) 5	250 SMALL T&R	Yes	NIPDAU SN	Level-1-260C-UNLIM	-40 to 125	1N4L
TPS613221ADBVT.B	Active	Production	SOT-23 (DBV) 5	250 SMALL T&R	Yes	SN	Level-1-260C-UNLIM	-40 to 125	1N4L
TPS613222ADBVR	Active	Production	SOT-23 (DBV) 5	3000 LARGE T&R	Yes	NIPDAU SN	Level-1-260C-UNLIM	-40 to 125	1N5L
TPS613222ADBVR.B	Active	Production	SOT-23 (DBV) 5	3000 LARGE T&R	Yes	NIPDAU	Level-1-260C-UNLIM	-40 to 125	1N5L
TPS613222ADBVT	Active	Production	SOT-23 (DBV) 5	250 SMALL T&R	Yes	NIPDAU SN	Level-1-260C-UNLIM	-40 to 125	1N5L
TPS613222ADBVT.B	Active	Production	SOT-23 (DBV) 5	250 SMALL T&R	Yes	SN	Level-1-260C-UNLIM	-40 to 125	1N5L
TPS613222ADBVTG4	Active	Production	SOT-23 (DBV) 5	250 SMALL T&R	Yes	NIPDAU	Level-1-260C-UNLIM	-40 to 125	1N5L
TPS613222ADBVTG4.B	Active	Production	SOT-23 (DBV) 5	250 SMALL T&R	Yes	NIPDAU	Level-1-260C-UNLIM	-40 to 125	1N5L
TPS613223ADBVR	Active	Production	SOT-23 (DBV) 5	3000 LARGE T&R	Yes	NIPDAU SN	Level-1-260C-UNLIM	-40 to 125	1NRL
TPS613223ADBVR.B	Active	Production	SOT-23 (DBV) 5	3000 LARGE T&R	Yes	SN	Level-1-260C-UNLIM	-40 to 125	1NRL
TPS613223ADBVT	Active	Production	SOT-23 (DBV) 5	250 SMALL T&R	Yes	NIPDAU SN	Level-1-260C-UNLIM	-40 to 125	1NRL
TPS613223ADBVT.B	Active	Production	SOT-23 (DBV) 5	250 SMALL T&R	Yes	SN	Level-1-260C-UNLIM	-40 to 125	1NRL
TPS613226ADBVR	Active	Production	SOT-23 (DBV) 5	3000 LARGE T&R	Yes	NIPDAU SN	Level-1-260C-UNLIM	-40 to 125	1N6L
TPS613226ADBVR.B	Active	Production	SOT-23 (DBV) 5	3000 LARGE T&R	Yes	SN	Level-1-260C-UNLIM	-40 to 125	1N6L
TPS613226ADBVT	Active	Production	SOT-23 (DBV) 5	250 SMALL T&R	Yes	NIPDAU SN	Level-1-260C-UNLIM	-40 to 125	1N6L
TPS613226ADBVT.B	Active	Production	SOT-23 (DBV) 5	250 SMALL T&R	Yes	NIPDAU	Level-1-260C-UNLIM	-40 to 125	1N6L
TPS61322DBZR	Active	Production	SOT-23 (DBZ) 3	3000 LARGE T&R	Yes	NIPDAU SN	Level-1-260C-UNLIM	-40 to 125	1EME
TPS61322DBZR.B	Active	Production	SOT-23 (DBZ) 3	3000 LARGE T&R	Yes	NIPDAU	Level-1-260C-UNLIM	-40 to 125	1EME
TPS61322DBZT	Active	Production	SOT-23 (DBZ) 3	250 SMALL T&R	Yes	NIPDAU SN	Level-1-260C-UNLIM	-40 to 125	1EME
TPS61322DBZT.B	Active	Production	SOT-23 (DBZ) 3	250 SMALL T&R	Yes	NIPDAU	Level-1-260C-UNLIM	-40 to 125	1EME
XTPS61322DBZT	Obsolete	Preproduction	SOT-23 (DBZ) 3	-	-	Call TI	Call TI	-40 to 125	

(1) **Status:** For more details on status, see our [product life cycle](#).

(2) **Material type:** When designated, preproduction parts are prototypes/experimental devices, and are not yet approved or released for full production. Testing and final process, including without limitation quality assurance, reliability performance testing, and/or process qualification, may not yet be complete, and this item is subject to further changes or possible discontinuation. If available for ordering, purchases will be subject to an additional waiver at checkout, and are intended for early internal evaluation purposes only. These items are sold without warranties of any kind.

(3) **RoHS values:** Yes, No, RoHS Exempt. See the [TI RoHS Statement](#) for additional information and value definition.

(4) **Lead finish/Ball material:** Parts may have multiple material finish options. Finish options are separated by a vertical ruled line. Lead finish/Ball material values may wrap to two lines if the finish value exceeds the maximum column width.

(5) **MSL rating/Peak reflow:** The moisture sensitivity level ratings and peak solder (reflow) temperatures. In the event that a part has multiple moisture sensitivity ratings, only the lowest level per JEDEC standards is shown. Refer to the shipping label for the actual reflow temperature that will be used to mount the part to the printed circuit board.

(6) **Part marking:** There may be an additional marking, which relates to the logo, the lot trace code information, or the environmental category of the part.

Multiple part markings will be inside parentheses. Only one part marking contained in parentheses and separated by a "~" will appear on a part. If a line is indented then it is a continuation of the previous line and the two combined represent the entire part marking for that device.

Important Information and Disclaimer: The information provided on this page represents TI's knowledge and belief as of the date that it is provided. TI bases its knowledge and belief on information provided by third parties, and makes no representation or warranty as to the accuracy of such information. Efforts are underway to better integrate information from third parties. TI has taken and continues to take reasonable steps to provide representative and accurate information but may not have conducted destructive testing or chemical analysis on incoming materials and chemicals. TI and TI suppliers consider certain information to be proprietary, and thus CAS numbers and other limited information may not be available for release.

In no event shall TI's liability arising out of such information exceed the total purchase price of the TI part(s) at issue in this document sold by TI to Customer on an annual basis.

TAPE AND REEL INFORMATION



QUADRANT ASSIGNMENTS FOR PIN 1 ORIENTATION IN TAPE



*All dimensions are nominal

Device	Package Type	Package Drawing	Pins	SPQ	Reel Diameter (mm)	Reel Width W1 (mm)	A0 (mm)	B0 (mm)	K0 (mm)	P1 (mm)	W (mm)	Pin1 Quadrant
TPS613221ADBVR	SOT-23	DBV	5	3000	178.0	8.4	3.2	3.2	1.4	4.0	8.0	Q3
TPS613221ADBVT	SOT-23	DBV	5	250	180.0	8.4	3.2	3.2	1.4	4.0	8.0	Q3
TPS613222ADBVR	SOT-23	DBV	5	3000	180.0	8.4	3.2	3.2	1.4	4.0	8.0	Q3
TPS613222ADBVR	SOT-23	DBV	5	3000	180.0	8.4	3.2	3.2	1.4	4.0	8.0	Q3
TPS613222ADBVT	SOT-23	DBV	5	250	180.0	8.4	3.2	3.2	1.4	4.0	8.0	Q3
TPS613222ADBVT	SOT-23	DBV	5	250	180.0	8.4	3.2	3.2	1.4	4.0	8.0	Q3
TPS613222ADBVTG4	SOT-23	DBV	5	250	180.0	8.4	3.2	3.2	1.4	4.0	8.0	Q3
TPS613223ADBVR	SOT-23	DBV	5	3000	180.0	8.4	3.2	3.2	1.4	4.0	8.0	Q3
TPS613223ADBVR	SOT-23	DBV	5	3000	180.0	8.4	3.2	3.2	1.4	4.0	8.0	Q3
TPS613223ADBVT	SOT-23	DBV	5	250	180.0	8.4	3.2	3.2	1.4	4.0	8.0	Q3
TPS613223ADBVT	SOT-23	DBV	5	250	180.0	8.4	3.2	3.2	1.4	4.0	8.0	Q3
TPS613226ADBVR	SOT-23	DBV	5	3000	178.0	8.4	3.2	3.2	1.4	4.0	8.0	Q3
TPS613226ADBVT	SOT-23	DBV	5	250	180.0	8.4	3.2	3.2	1.4	4.0	8.0	Q3
TPS61322DBZR	SOT-23	DBZ	3	3000	180.0	8.4	3.2	2.85	1.3	4.0	8.0	Q3
TPS61322DBZR	SOT-23	DBZ	3	3000	180.0	8.4	2.9	3.35	1.35	4.0	8.0	Q3
TPS61322DBZR	SOT-23	DBZ	3	3000	178.0	9.0	3.15	2.77	1.22	4.0	8.0	Q3

Device	Package Type	Package Drawing	Pins	SPQ	Reel Diameter (mm)	Reel Width W1 (mm)	A0 (mm)	B0 (mm)	K0 (mm)	P1 (mm)	W (mm)	Pin1 Quadrant
TPS61322DBZT	SOT-23	DBZ	3	250	180.0	8.4	2.9	3.35	1.35	4.0	8.0	Q3
TPS61322DBZT	SOT-23	DBZ	3	250	180.0	8.4	3.2	2.85	1.3	4.0	8.0	Q3
TPS61322DBZT	SOT-23	DBZ	3	250	178.0	9.0	3.15	2.77	1.22	4.0	8.0	Q3

TAPE AND REEL BOX DIMENSIONS

*All dimensions are nominal

Device	Package Type	Package Drawing	Pins	SPQ	Length (mm)	Width (mm)	Height (mm)
TPS613221ADBVR	SOT-23	DBV	5	3000	208.0	191.0	35.0
TPS613221ADBVT	SOT-23	DBV	5	250	210.0	185.0	35.0
TPS613222ADBVR	SOT-23	DBV	5	3000	210.0	185.0	35.0
TPS613222ADBVR	SOT-23	DBV	5	3000	210.0	185.0	35.0
TPS613222ADBVT	SOT-23	DBV	5	250	210.0	185.0	35.0
TPS613222ADBVT	SOT-23	DBV	5	250	210.0	185.0	35.0
TPS613222ADBVTG4	SOT-23	DBV	5	250	210.0	185.0	35.0
TPS613223ADBVR	SOT-23	DBV	5	3000	210.0	185.0	35.0
TPS613223ADBVR	SOT-23	DBV	5	3000	210.0	185.0	35.0
TPS613223ADBVT	SOT-23	DBV	5	250	210.0	185.0	35.0
TPS613223ADBVT	SOT-23	DBV	5	250	210.0	185.0	35.0
TPS613226ADBVR	SOT-23	DBV	5	3000	208.0	191.0	35.0
TPS613226ADBVT	SOT-23	DBV	5	250	210.0	185.0	35.0
TPS61322DBZR	SOT-23	DBZ	3	3000	210.0	185.0	35.0
TPS61322DBZR	SOT-23	DBZ	3	3000	210.0	185.0	35.0
TPS61322DBZR	SOT-23	DBZ	3	3000	180.0	180.0	18.0
TPS61322DBZT	SOT-23	DBZ	3	250	210.0	185.0	35.0
TPS61322DBZT	SOT-23	DBZ	3	250	210.0	185.0	35.0

Device	Package Type	Package Drawing	Pins	SPQ	Length (mm)	Width (mm)	Height (mm)
TPS61322DBZT	SOT-23	DBZ	3	250	180.0	180.0	18.0

DBV0005A



PACKAGE OUTLINE

SOT-23 - 1.45 mm max height

SMALL OUTLINE TRANSISTOR

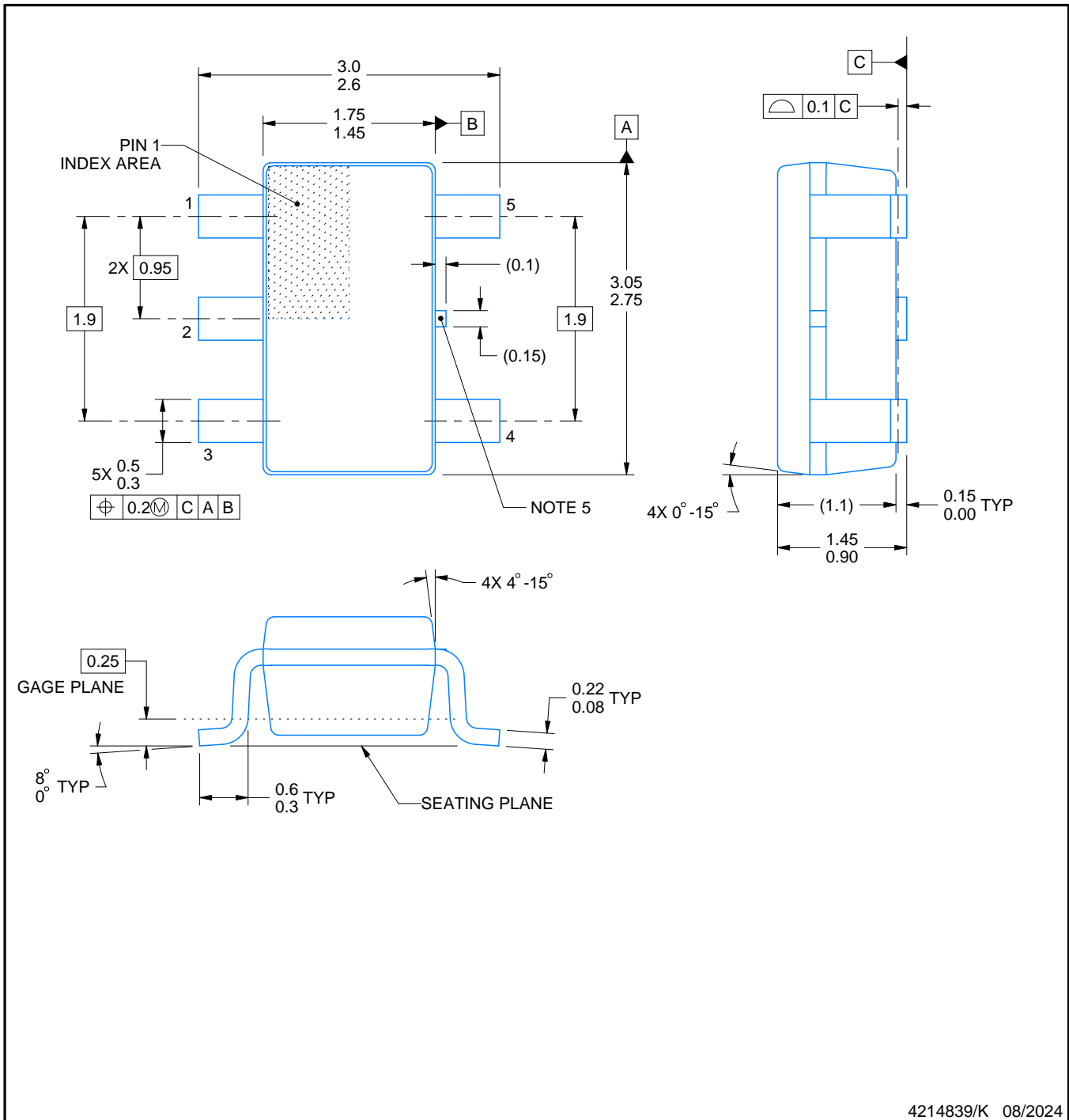

4214839/K 08/2024

NOTES:

1. All linear dimensions are in millimeters. Any dimensions in parenthesis are for reference only. Dimensioning and tolerancing per ASME Y14.5M.
2. This drawing is subject to change without notice.
3. Reference JEDEC MO-178.
4. Body dimensions do not include mold flash, protrusions, or gate burrs. Mold flash, protrusions, or gate burrs shall not exceed 0.25 mm per side.
5. Support pin may differ or may not be present.

EXAMPLE BOARD LAYOUT

DBV0005A

SOT-23 - 1.45 mm max height

SMALL OUTLINE TRANSISTOR



LAND PATTERN EXAMPLE
EXPOSED METAL SHOWN
SCALE:15X



SOLDER MASK DETAILS

4214839/K 08/2024

NOTES: (continued)

- 6. Publication IPC-7351 may have alternate designs.
- 7. Solder mask tolerances between and around signal pads can vary based on board fabrication site.

EXAMPLE STENCIL DESIGN

DBV0005A

SOT-23 - 1.45 mm max height

SMALL OUTLINE TRANSISTOR



SOLDER PASTE EXAMPLE
BASED ON 0.125 mm THICK STENCIL
SCALE:15X

4214839/K 08/2024

NOTES: (continued)

8. Laser cutting apertures with trapezoidal walls and rounded corners may offer better paste release. IPC-7525 may have alternate design recommendations.
9. Board assembly site may have different recommendations for stencil design.

EXAMPLE BOARD LAYOUT

DBZ0003A

SOT-23 - 1.12 mm max height

SMALL OUTLINE TRANSISTOR

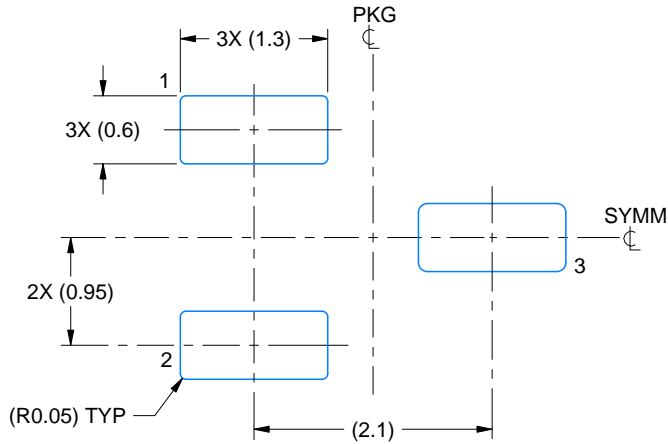

LAND PATTERN EXAMPLE
SCALE:15X

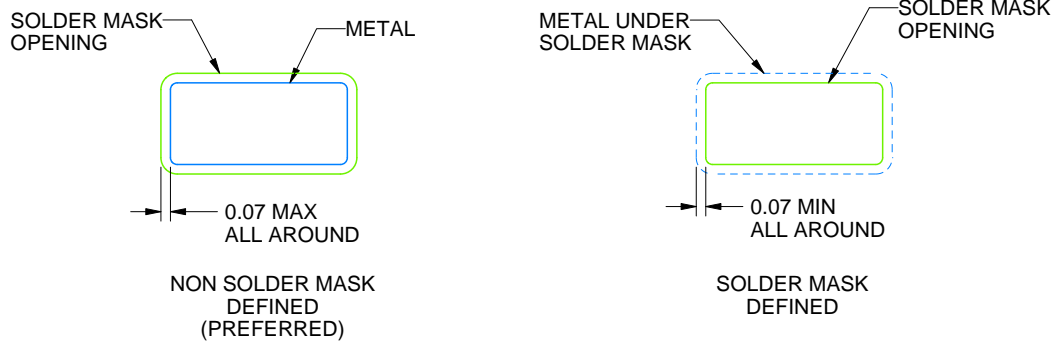

SOLDER MASK DETAILS

4214838/F 08/2024

NOTES: (continued)

5. Publication IPC-7351 may have alternate designs.
6. Solder mask tolerances between and around signal pads can vary based on board fabrication site.

EXAMPLE STENCIL DESIGN

DBZ0003A

SOT-23 - 1.12 mm max height

SMALL OUTLINE TRANSISTOR

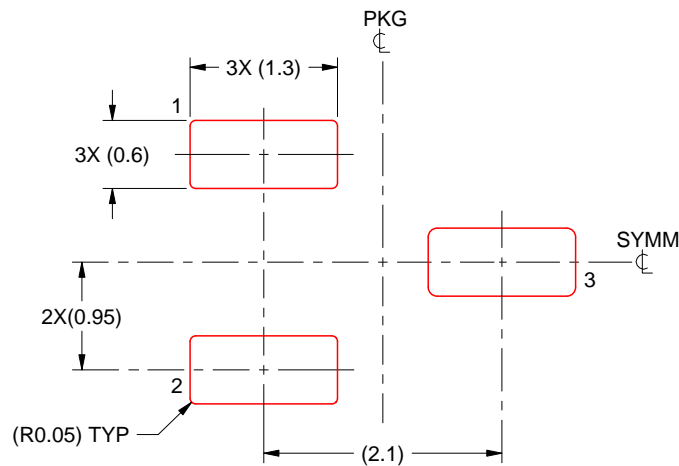

SOLDER PASTE EXAMPLE
BASED ON 0.125 THICK STENCIL
SCALE:15X

4214838/F 08/2024

NOTES: (continued)

7. Laser cutting apertures with trapezoidal walls and rounded corners may offer better paste release. IPC-7525 may have alternate design recommendations.
8. Board assembly site may have different recommendations for stencil design.

重要なお知らせと免責事項

TI は、技術データと信頼性データ (データシートを含みます)、設計リソース (リファレンス デザインを含みます)、アプリケーションや設計に関する各種アドバイス、Web ツール、安全性情報、その他のリソースを、欠陥が存在する可能性のある「現状のまま」提供しており、商品性および特定目的に対する適合性の黙示保証、第三者の知的財産権の非侵害保証を含むいかなる保証も、明示的または黙示的にかかわらず拒否します。

これらのリソースは、TI 製品を使用する設計の経験を積んだ開発者への提供を意図したものです。(1) お客様のアプリケーションに適した TI 製品の選定、(2) お客様のアプリケーションの設計、検証、試験、(3) お客様のアプリケーションに該当する各種規格や、その他のあらゆる安全性、セキュリティ、規制、または他の要件への確実な適合に関する責任を、お客様のみが単独で負うものとし、

上記の各種リソースは、予告なく変更される可能性があります。これらのリソースは、リソースで説明されている TI 製品を使用するアプリケーションの開発の目的でのみ、TI はその使用をお客様に許諾します。これらのリソースに関して、他の目的で複製することや掲載することは禁止されています。TI や第三者の知的財産権のライセンスが付与されている訳ではありません。お客様は、これらのリソースを自身で使用した結果発生するあらゆる申し立て、損害、費用、損失、責任について、TI およびその代理人を完全に補償するものとし、TI は一切の責任を拒否します。

TI の製品は、[TI の販売条件](#)、[TI の総合的な品質ガイドライン](#)、[ti.com](#) または TI 製品などに関連して提供される他の適用条件に従い提供されます。TI がこれらのリソースを提供することは、適用される TI の保証または他の保証の放棄の拡大や変更を意味するものではありません。TI がカスタム、またはカスタマー仕様として明示的に指定していない限り、TI の製品は標準的なカタログに掲載される汎用機器です。

お客様がいかなる追加条項または代替条項を提案する場合も、TI はそれらに異議を唱え、拒否します。

Copyright © 2026, Texas Instruments Incorporated

最終更新日 : 2025 年 10 月