

# TPS6223xx 2MHz/3MHz超小型降圧コンバータ、1x1.5mm USONパッケージ

## 1 特長

- 2MHz/3MHzのスイッチング周波数
- 最大94%の効率
- 最大500mAの出力ピーク電流
- 動作時の接合部温度: -40°C~125°C
- 高PSRR (最大90dB)
- 小さな外部出力フィルタ部品: 1μHおよび4.7μF
- $V_{IN}$ 範囲2.05V~6V
- パワーセーブ・モードの最適化により低い出力リップル電圧を実現
- 強制PWMモード動作
- 標準値22μAの静止電流
- 100%デューティ・サイクル動作により低いドロップアウト電圧を実現
- 1mmx1.5mmx0.6mmの小型USONパッケージ
- 最小12mm<sup>2</sup>のソリューション・サイズ
- 最大高さ0.6mmのソリューションをサポート

## 2 アプリケーション

- LODの代替品
- ポータブルのオーディオおよびメディア
- 低消費電力ワイヤレス
- 低消費電力DSPコア電源
- デジタル・カメラ

## 3 概要

TPS6223xデバイス・ファミリは高周波数、同期整流降圧型のDC/DCコンバータで、バッテリー駆動のポータブル・アプリケーション用に最適化されています。最大500mAの出力電流に対応し、小型で低コストのチップ・インダクタおよびコンデンサを使用できます。

このデバイスは2.05V~6Vの広い入力電圧範囲で動作するため、拡張電圧範囲のリチウムイオン電池で動作するアプリケーションをサポートしています。最小入力電圧が2.05Vであるため、リチウム一次電池や、2個のアルカリ電池でも動作できます。1.0Vから3.3Vの間で、各種の固定出力電圧のバージョンが利用可能です。

TPS6223xシリーズのスイッチング周波数は最大3.8MHzです。中負荷から重負荷では、コンバータはパルス幅変調(PWM)モードで動作し、軽負荷電流時には自動的にパワー・セーブ・モードへ移行するため、負荷電流のあらゆる範囲にわたって高い効率が維持されます。

このデバイスは、電源電圧除去比(PSRR)およびAC負荷レギュレーション性能が非常に優れているため、リア・レギュレータの置き換えに適切で、より優れた電力変換効率が得られます。

TPS6223xのパワー・セーブ・モードでは、軽負荷動作時の静止電流が22μAまで低減します。小さな外付け部品を使用しても、出力電圧リップルが非常に低くなるよう最適化されており、また非常に優れたAC負荷レギュレーションが特長です。

ノイズに非常に敏感なアプリケーションでは、MODEピンをHIGHにすると、負荷範囲の全体にわたって強制的にPWMモードでデバイスを動作させることもできます。シャットダウン・モードでは、電流消費が1μA未満に減少します。TPS6223xは、-40°C~125°Cの接合部温度範囲で動作します。1mmx1.5mmx0.6mmの6ピンSONパッケージで供給されます。

### 製品情報(1)

型番	パッケージ	本体サイズ(公称)
TPS6223xx	USON (6)	1.45mmx1.00mm

(1) 提供されているすべてのパッケージについては、データシートの末尾にある注文情報を参照してください。

### 代表的なアプリケーションの回路図

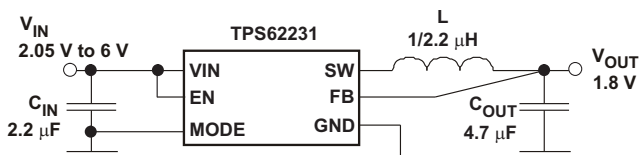

Copyright © 2016, Texas Instruments Incorporated

### 小さなPCBレイアウトのサイズ

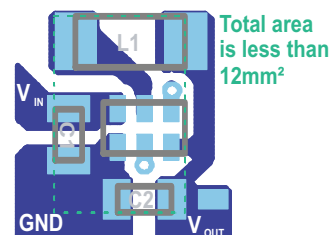

## 目次

1	特長	1	9	Application and Implementation	13
2	アプリケーション	1	9.1	Application Information	13
3	概要	1	9.2	Typical Application	13
4	改訂履歴	2	9.3	System Examples	26
5	Device Comparison Table	4	10	Power Supply Recommendations	27
6	Pin Configuration and Functions	5	11	Layout	27
7	Specifications	5	11.1	Layout Guidelines	27
7.1	Absolute Maximum Ratings	5	11.2	Layout Example	27
7.2	ESD Ratings	5	12	デバイスおよびドキュメントのサポート	28
7.3	Recommended Operating Conditions	6	12.1	デバイス・サポート	28
7.4	Thermal Information	6	12.2	関連リンク	28
7.5	Electrical Characteristics	7	12.3	ドキュメントの更新通知を受け取る方法	28
7.6	Typical Characteristics	8	12.4	コミュニティ・リソース	29
8	Detailed Description	9	12.5	商標	29
8.1	Overview	9	12.6	静電気放電に関する注意事項	29
8.2	Functional Block Diagram	10	12.7	Glossary	29
8.3	Feature Description	10	13	メカニカル、パッケージ、および注文情報	29
8.4	Device Functional Modes	11			

## 4 改訂履歴

資料番号末尾の英字は改訂を表しています。その改訂履歴は英語版に準じています。

Revision F (July 2015) から Revision G に変更	Page
• Added device TPS622319	4
• Deleted Package information from <i>Device Comparison Table</i> , and added footnote	4
• 追加「ドキュメントの更新通知を受け取る方法」セクション	28

Revision E (December 2010) から Revision F に変更	Page
• 「ピン構成および機能」セクション、「ESD定格」表、「機能説明」セクション、「デバイスの機能モード」セクション、「アプリケーションと実装」セクション、「電源に関する推奨事項」セクション、「レイアウト」セクション、「デバイスおよびドキュメントのサポート」セクション、「メカニカル、パッケージ、および注文情報」セクション 追加	1

Revision D (August 2010) から Revision E に変更	Page
• デバイス番号TPS622318を 追加	1

Revision C (April 2010) から Revision D に変更	Page
• デバイス番号TPS622315、TPS622316、TPS622317を 追加	1
• データシートの状態を「製品ミックス」から「量産データ」へ 変更	1
• Deleted table footnote regarding "other voltage options"	4

Revision B (December 2009) から Revision C に変更	Page
• デバイス番号TPS622312、TPS622313、TPS622314を 追加	1

<b>Revision A (August 2009) から Revision B に変更</b>	<b>Page</b>
• デバイス番号TPS62235、TPS62236、TPS62237、TPS622311を 追加 .....	1
• タイトルを「3MHz超小型降圧コンバータ、1×1.5 SONパッケージ」から「2MHz/3MHz超小型降圧コンバータ、1×1.5 SON パッケージ」へ 変更 .....	1
• 「特長」の「3MHzのスイッチング周波数」を「2MHz/3MHzのスイッチング周波数」へ 変更 .....	1
• 追加 <a href="#">図 6</a> , <a href="#">図 7</a> , and <a href="#">図 10</a> .....	16
• 追加 <a href="#">図 15</a> .....	17
• 追加 <a href="#">図 24</a> , and <a href="#">図 25</a> .....	19
• 追加 <a href="#">図 32</a> .....	21
• 追加 <a href="#">図 41</a> , and <a href="#">図 42</a> .....	23
<hr/>	
<b>2009年4月発行のものから更新</b>	<b>Page</b>
• データシートにデバイス番号TPS62233、TPS62234、TPS62238、TPS62239、TPS622310を 追加 .....	1

## 5 Device Comparison Table

PART NUMBER <sup>(1)</sup>	OUTPUT VOLTAGE	FREQUENCY [MHz]	Pulldown EN, MODE	PACKAGE MARKING
TPS62230	2.5 V	3	no	GV
TPS62231	1.8 V	3	no	GW
TPS62232	1.2 V	3	no	GX
TPS62239	1.0 V	3	no	OP
TPS622311	1.1V	2	no	PA
TPS622315	1.15V	2	no	RI
TPS62235	1.2V	2	no	OQ
TPS622318	1.25V	3	no	ST
TPS622319	1.2V	2	yes	3O
TPS622313	1.3 V	3	no	QF
TPS622314	1.5 V	3	no	QG
TPS62236	1.85V	2	no	OR
TPS622312	2.0 V	3	no	QE
TPS62234	2.1 V	3	no	OH
TPS62238	2.25 V	3	no	ON
TPS622310	2.3 V	3	no	OT
TPS622316	2.7 V	3	no	RJ
TPS622317	2.9 V	3	no	RK
TPS62233	3.0 V	3	no	OG
TPS62237	3.3 V	2	no	OS

(1) For detailed ordering information see the PACKAGE OPTION ADDENDUM at the end of this data sheet.

## 6 Pin Configuration and Functions

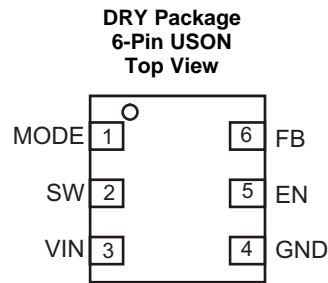

### Pin Functions

PIN		TYPE	DESCRIPTION
NAME	NO		
VIN	3	Power	V <sub>IN</sub> power supply pin
GND	4	Power	GND supply pin
EN	5	Input	This is the enable pin of the device. Pulling this pin to low forces the device into shutdown mode. Pulling this pin to high enables the device. This pin must be terminated except for the TPS622319, which has an integrated 1M $\Omega$ always active pull-down resistor.
SW	2	Output	This is the switch pin and is connected to the internal MOSFET switches. Connect the inductor to this terminal
FB	6	Input	Feedback pin for the internal regulation loop. Connect this pin directly to the output capacitor.
MODE	1	Input	MODE pin = High forces the device to operate in PWM mode. Mode = Low enables the power save mode with automatic transition from pulse frequency modulation (PFM) to pulse width modulation (PWM) mode. This pin must be terminated except for the TPS622319, which has an integrated 1M $\Omega$ always active pull-down resistor.

## 7 Specifications

### 7.1 Absolute Maximum Ratings

over operating free-air temperature range (unless otherwise noted)<sup>(1)</sup>

		MIN	MAX	UNIT
V <sub>IN</sub>	Voltage at VIN and SW pin <sup>(2)</sup>	-0.3	7	V
	Voltage at EN, MODE pin <sup>(2)</sup>	-0.3	V <sub>IN</sub> + 0.3, $\leq 7$	V
	Voltage at FB pin <sup>(2)</sup>	-0.3	3.6	V
	Peak output current	Internally limited		A
	Power dissipation	Internally limited		
T <sub>J</sub>	Operating junction Temperature Range	-40	150	°C
T <sub>stg</sub>	Storage Temperature Range	-65	150	°C

- (1) Stresses beyond those listed under *Absolute Maximum Ratings* may cause permanent damage to the device. These are stress ratings only and functional operation of the device at these or any other conditions beyond those indicated under *Recommended Operating Conditions* is not implied. Exposure to absolute-maximum-rated conditions for extended periods may affect device reliability.
- (2) All voltage values are with respect to network ground terminal.

### 7.2 ESD Ratings

		VALUE	UNIT
V <sub>(ESD)</sub>	Electrostatic discharge	Human body model (HBM), per ANSI/ESDA/JEDEC JS-001, all pins <sup>(1)</sup>	$\pm 2000$
		Charge- device model (CDM), per JEDEC specification JESD22-C101, all pins <sup>(2)</sup>	$\pm 1000$

- (1) JEDEC document JEP155 states that 500-V HBM allows safe manufacturing with a standard ESD control process.
- (2) JEDEC document JEP157 states that 250-V CDM allows safe manufacturing with a standard ESD control process.

### 7.3 Recommended Operating Conditions

over operating junction temperature range (unless otherwise noted)<sup>(1)</sup>

		MIN	NOM	MAX	UNIT
Supply voltage $V_{IN}$ <sup>(2)</sup>		2.05		6	V
Effective inductance			2.2		$\mu$ H
Effective capacitance		2	4.7		$\mu$ F
Recommended minimum supply voltage	$V_{OUT} \leq V_{IN} - 1$ V <sup>(3)</sup>	500 mA maximum $I_{OUT}$ <sup>(4)</sup>		3	3.6
		350 mA maximum $I_{OUT}$ <sup>(4)</sup>		2.5	2.7
	$V_{OUT} \leq 1.8$ V	60 mA maximum output current <sup>(4)</sup>		2.05	
Operating junction temperature, $T_J$		-40		125	$^{\circ}$ C

- (1) In applications where high power dissipation and/or poor package thermal resistance is present, the maximum ambient temperature may have to be derated. Maximum ambient temperature ( $T_{A(max)}$ ) is dependent on the maximum operating junction temperature ( $T_{J(max)}$ ), the maximum power dissipation of the device in the application ( $P_{D(max)}$ ), and the junction-to-ambient thermal resistance of the part/package in the application ( $R_{\theta JA}$ ), as given by the following equation:  $T_{A(max)} = T_{J(max)} - (R_{\theta JA} \times P_{D(max)})$ .
- (2) The minimum required supply voltage for startup is 2.05 V. The part is functional down to the falling undervoltage lockout (UVL) threshold.
- (3) For a voltage difference between minimum  $V_{IN}$  and  $V_{OUT}$  of  $\geq 1$  V
- (4) Typical value applies for  $T_A = 25^{\circ}$ C, maximum value applies for  $T_J \leq 125^{\circ}$ C, PCB layout must support proper thermal performance.

### 7.4 Thermal Information

THERMAL METRIC <sup>(1)</sup>		TPS6223x	UNIT
		DRY (USON)	
		6 PINS	
$R_{\theta JA}$	Junction-to-ambient thermal resistance	294.5	$^{\circ}$ C/W
$R_{\theta JC(top)}$	Junction-to-case (top) thermal resistance	166.5	$^{\circ}$ C/W
$R_{\theta JB}$	Junction-to-board thermal resistance	166.1	$^{\circ}$ C/W
$\Psi_{JT}$	Junction-to-top characterization parameter	27.3	$^{\circ}$ C/W
$\Psi_{JB}$	Junction-to-board characterization parameter	159.9	$^{\circ}$ C/W
$R_{\theta JC(bot)}$	Junction-to-case (bottom) thermal resistance	—	$^{\circ}$ C/W

- (1) For more information about traditional and new thermal metrics, see the *Semiconductor and IC Package Thermal Metrics* application report, [SPRA953](#).

## 7.5 Electrical Characteristics

$V_{IN} = 3.6\text{ V}$ ,  $V_{OUT} = 1.8\text{ V}$ ,  $EN = V_{IN}$ ,  $MODE = GND$ ,  $T_J = -40^\circ\text{C}$  to  $125^\circ\text{C}$  typical values are at  $T_J = 25^\circ\text{C}$  (unless otherwise noted),  $C_{IN} = 2.2\ \mu\text{F}$ ,  $L = 2.2\ \mu\text{H}$ ,  $C_{OUT} = 4.7\ \mu\text{F}$ .<sup>(1)</sup>

PARAMETER		TEST CONDITIONS	MIN	TYP	MAX	UNIT	
<b>SUPPLY</b>							
$V_{IN}$	Input voltage <sup>(2)</sup>		2.05		6	V	
$I_Q$	Operating quiescent current	PFM operation (MODE = GND), $I_{OUT} = 0\text{ mA}$ , device not switching, $T_J = -40^\circ\text{C}$ to $85^\circ\text{C}$		22	40	$\mu\text{A}$	
		PFM operation (MODE = GND), $I_{OUT} = 0\text{ mA}$ , device switching, $V_{OUT} = 1.2\text{ V}$		25		$\mu\text{A}$	
		PWM operation (MODE = $V_{IN}$ ), $I_{OUT} = 0\text{ mA}$ , device switching		3		mA	
$I_{SD}$	Shutdown current	EN = GND, $T_J = -40^\circ\text{C}$ to $85^\circ\text{C}$		0.1	1	$\mu\text{A}$	
$V_{UVLO}$	Undervoltage lockout threshold	Falling		1.8	1.9	V	
		Rising		1.9	2.05	V	
<b>ENABLE, MODE THRESHOLD</b>							
$V_{IH\ TH}$	Threshold for detecting high EN, MODE	$2.05\text{ V} \leq V_{IN} \leq 6\text{ V}$ , rising edge		0.8	1	V	
$V_{IL\ TH\ HYS}$	Threshold for detecting low EN, MODE	$2.05\text{ V} \leq V_{IN} \leq 6\text{ V}$ , falling edge, $T_J = -40^\circ\text{C}$ to $85^\circ\text{C}$	0.4	0.6		V	
$R_{pd}$	Pull-down resistor EN, MODE	TPS622319		1		M $\Omega$	
$I_{IN}$	Input bias current, EN, MODE	EN, MODE = GND or $V_{IN}$ , $T_J = -40^\circ\text{C}$ to $85^\circ\text{C}$ , except TPS622319		0.01	0.5	$\mu\text{A}$	
<b>POWER SWITCH</b>							
$R_{DS(ON)}$	High side MOSFET ON-resistance	$V_{IN} = 3.6\text{ V}$ , $T_J = -40^\circ\text{C}$ to $85^\circ\text{C}$		600	850	m $\Omega$	
	Low Side MOSFET ON-resistance			350	480		
$I_{LIMF}$	Forward current limit MOSFET high-side	$V_{IN} = 3.6\text{ V}$ , open-loop		690	850	1050	mA
	Forward current limit MOSFET low-side			550	840	1220	mA
$T_{JSD}$	Thermal shutdown	Increasing junction temperature		150		$^\circ\text{C}$	
	Thermal shutdown hysteresis	Decreasing junction temperature		20		$^\circ\text{C}$	
<b>CONTROLLER</b>							
$t_{ONmin}$	Minimum ON-time	MODE = $V_{IN}$ , $I_{OUT} = 0\text{ mA}$		135		ns	
$t_{OFFmin}$	Minimum OFF-time			40		ns	
<b>OUTPUT</b>							
$V_{REF}$	Internal reference voltage			0.7		V	
$V_{OUT}$	Output voltage accuracy <sup>(3)</sup>	MODE = GND, $I_{OUT} = 0\text{ mA}$		0%			
		MODE = $V_{IN}$ , $I_{OUT} = 0\text{ mA}$	$T_J = 25^\circ\text{C}$	-2%	2%		
			$T_J = -40^\circ\text{C}$ to $125^\circ\text{C}$	-2.5%	2.5%		
	DC output voltage load regulation	MODE = $V_{IN}$		0.001		%/mA	
	DC output voltage line regulation	MODE = $V_{IN}$ , $I_{OUT} = 0\text{ mA}$ , $2.05\text{ V} \leq V_{IN} \leq 6\text{ V}$		0		%/V	
$t_{Start}$	Start-up time	Time from active EN to $V_{OUT} = 1.8\text{ V}$ , 10- $\Omega$ load		100		$\mu\text{s}$	
$I_{LK\_SW}$	Leakage current into SW pin	$V_{IN} = V_{OUT} = V_{SW} = 3.6\text{ V}$ , EN = GND <sup>(4)</sup> , $T_J = -40^\circ\text{C}$ to $85^\circ\text{C}$		0.1	0.5	$\mu\text{A}$	

- In applications where high power dissipation and/or poor package thermal resistance is present, the maximum ambient temperature may have to be derated. Maximum ambient temperature ( $T_{A(max)}$ ) is dependent on the maximum operating junction temperature ( $T_{J(max)}$ ), the maximum power dissipation of the device in the application ( $P_{D(max)}$ ), and the junction-to-ambient thermal resistance of the part/package in the application ( $R_{\theta JA}$ ), as given by the following equation:  $T_{A(max)} = T_{J(max)} - (R_{\theta JA} \times P_{D(max)})$ .
- The minimum required supply voltage for startup is 2.05 V. The part is functional down to the falling under voltage lockout (UVL) threshold.
- $V_{IN} = V_O + 1.0\text{ V}$
- The internal resistor divider network is disconnected from FB pin.

## 7.6 Typical Characteristics

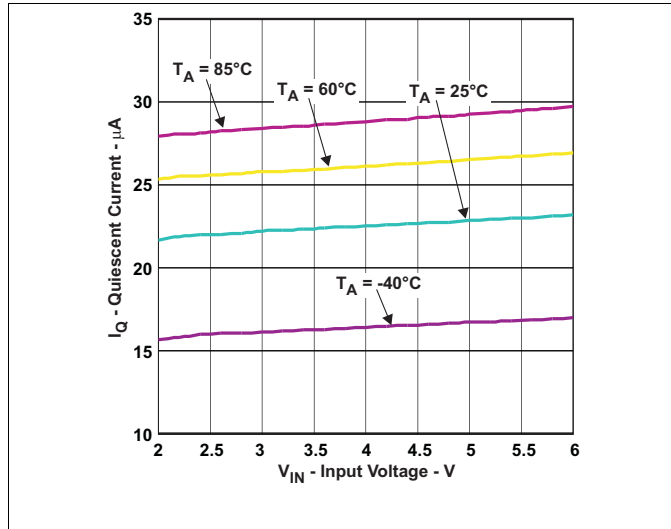

1. Quiescent Current  $I_Q$  vs Ambient Temperature  $T_A$

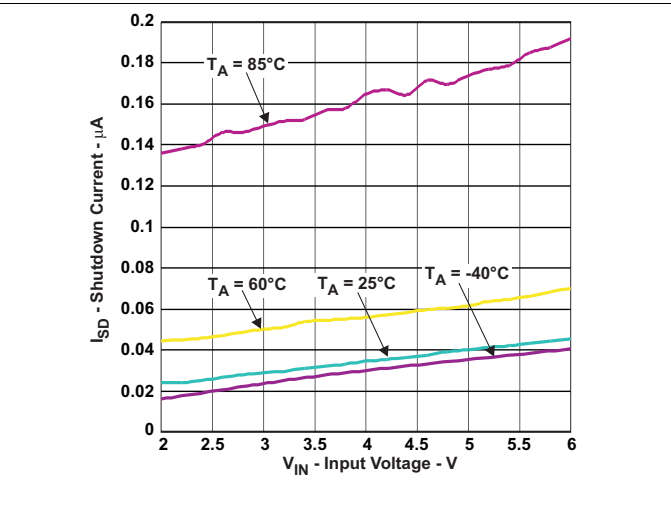

2. Shutdown Current  $I_{SD}$  vs Ambient Temperature  $T_A$

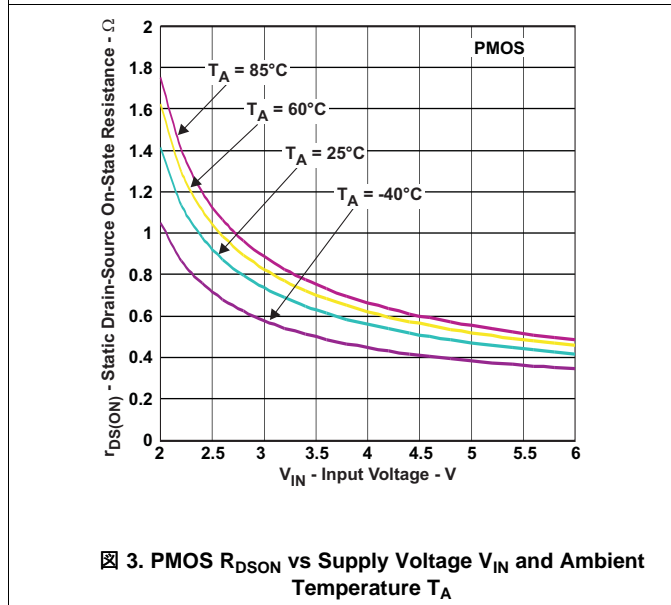

3. PMOS  $R_{DS(ON)}$  vs Supply Voltage  $V_{IN}$  and Ambient Temperature  $T_A$

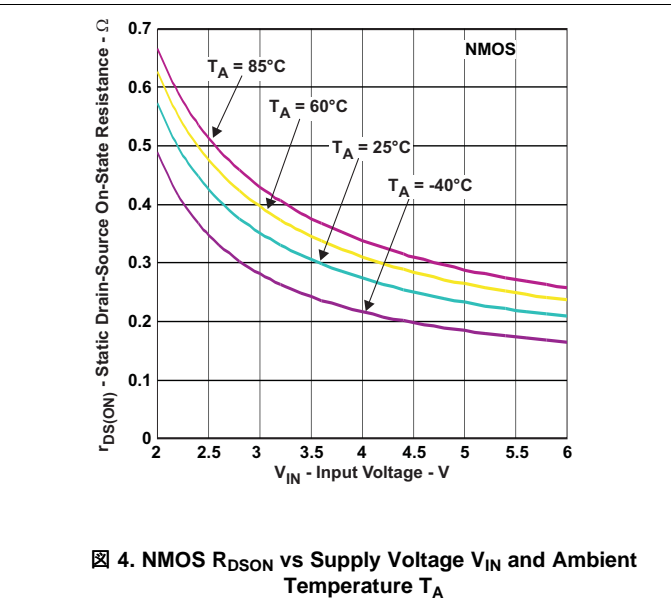

4. NMOS  $R_{DS(ON)}$  vs Supply Voltage  $V_{IN}$  and Ambient Temperature  $T_A$



## 8 Detailed Description

### 8.1 Overview

The TPS6223x synchronous step-down DC – DC converter family includes a unique hysteretic PWM controller scheme which enables switch frequencies over 3 MHz, excellent transient and AC load regulation as well as operation with cost-competitive external components.

The controller topology supports forced PWM mode as well as power-save mode operation. Power-save mode operation reduces the quiescent current consumption down to 22  $\mu$ A and ensures high conversion efficiency at light loads by skipping switch pulses. In forced PWM mode, the device operates on a quasi-fixed frequency, avoids pulse skipping, and allows filtering of the switch noise by external filter components.

The TPS6223x devices offer fixed output voltage options featuring smallest solution size by using only three external components.

The internal switch current limit of typical 850 mA supports output currents of up to 500 mA, depending on the operating condition.

A significant advantage of TPS6223x compared to other hysteretic PWM controller topologies is its excellent DC and AC load regulation capability in combination with low-output voltage ripple over the entire load range which makes this part well suited for audio and RF applications.

Once the output voltage falls below the threshold of the error comparator, a switch pulse is initiated, and the high-side switch is turned on. It remains turned on until a minimum ON-time of  $t_{ONmin}$  expires and the output voltage trips the threshold of the error comparator or the inductor current reaches the high-side switch current limit. Once the high-side switch turns off, the low-side switch rectifier is turned on and the inductor current ramps down until the high-side switch turns on again or the inductor current reaches zero.

In forced PWM mode operation, negative inductor current is allowed to enable continuous conduction mode even at no load condition.

## 8.2 Functional Block Diagram

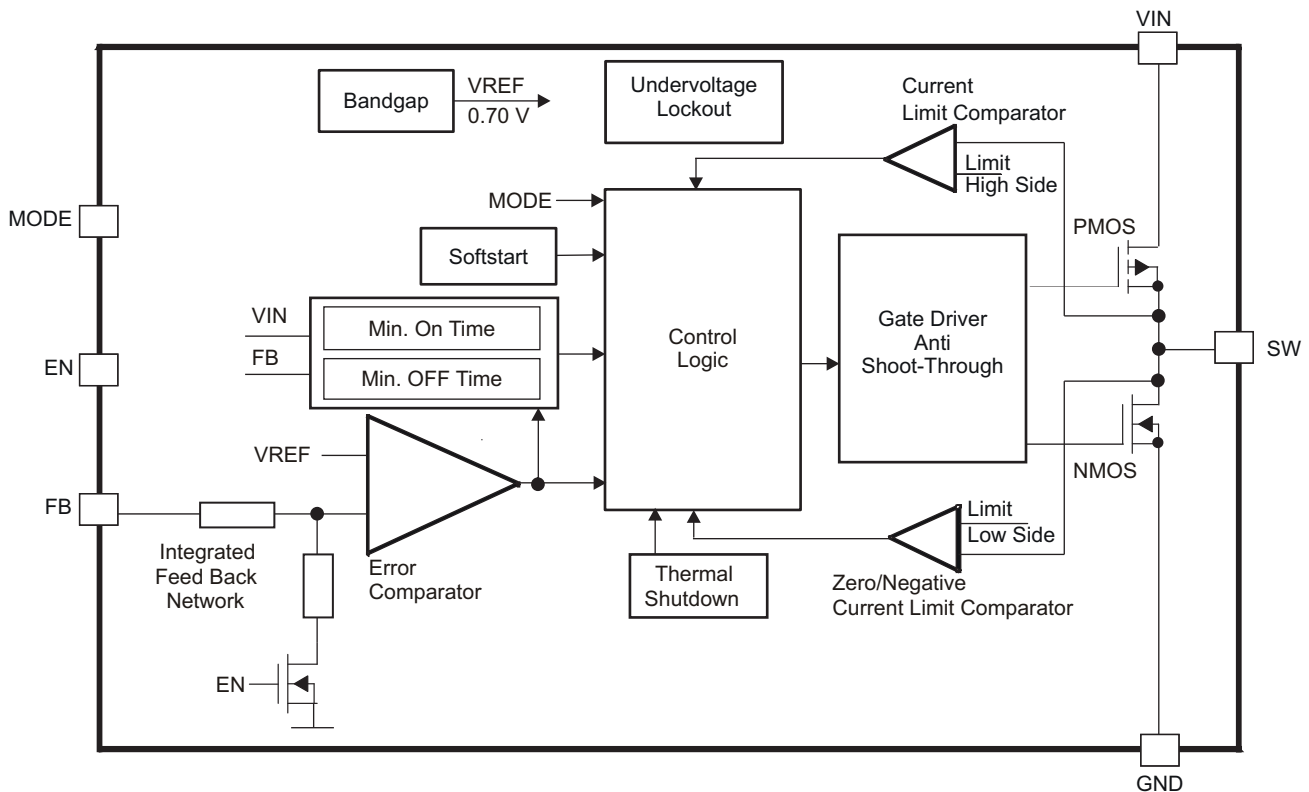

Copyright © 2016, Texas Instruments Incorporated

## 8.3 Feature Description

### 8.3.1 Undervoltage Lockout

The undervoltage lockout circuit prevents the device from misoperation at low input voltages. It prevents the converter from turning on the switch or rectifier MOSFET under undefined conditions. The TPS6223x devices have a UVLO threshold set to 1.8 V (typical). Fully functional operation is permitted for input voltage down to the falling UVLO threshold level. The converter starts operation again once the input voltage trips the rising UVLO threshold level.

### 8.3.2 Enable and Shutdown

The device starts operation when EN is set high and starts up with the soft-start as previously described. For proper operation, the EN pin must be terminated and must not be left floating, except for the TPS622319, which has an integrated 1M $\Omega$  always active pull-down resistor.

Pulling the EN pin low forces the device into shutdown, with a shutdown quiescent current of typically 0.1  $\mu$ A. In this mode, the P- and N-channel MOSFETs are turned off, the internal resistor feedback divider is disconnected, and the entire internal-control circuitry is switched off.

The EN input can be used to control power sequencing in a system with various DC – DC converters. The EN pin can be connected to the output of another converter, to drive the EN pin high and getting a sequencing of supply rails.

### 8.3.3 Thermal Shutdown

As soon as the junction temperature,  $T_j$ , exceeds 150°C (typical) the device goes into thermal shutdown. In this mode, the high-side and low-side MOSFETs are turned off. The device continues its operation when the junction temperature falls below the thermal shutdown hysteresis.

## 8.4 Device Functional Modes

### 8.4.1 Soft-Start

The TPS6223x has an internal soft start circuit that controls the ramp up of the output voltage and limits the inrush current during start-up. This limits input voltage drops when a battery or a high-impedance power source is connected to the input of the converter.

The soft-start system generates a monotonic ramp up of the output voltage and reaches the nominal output voltage typically 100  $\mu$ s after EN pin was pulled high.

If the output voltage does not reached its target value by this time, such as in the case of heavy load, the converter then operates in a current limit mode set by its switch current limits.

TPS6223x is able to start into a prebiased output capacitor. The converter starts with the applied bias voltage and ramps the output voltage to its nominal value.

### 8.4.2 Power-Save Mode

Connecting the MODE pin to GND enables the automatic PWM and power-save mode operation. The converter operates in quasi-fixed frequency PWM mode at moderate to heavy loads and in the pulse frequency modulation (PFM) mode during light loads, which maintains high efficiency over a wide load current range. In PFM mode, the device starts to skip switch pulses and generates only single pulses with an ON-time of  $t_{ONmin}$ . The PFM mode frequency depends on the load current and the external inductor and output capacitor values. The PFM mode of TPS6223x is optimized for low-output voltage ripple if small external components are used. Even at low output currents, the PFM frequency is above the audible noise spectrum and makes this operation mode suitable for audio applications.

The ON-time  $t_{ONmin}$  can be estimated to:

$$t_{ONmin} = \frac{V_{OUT}}{V_{IN}} \times 260 \text{ ns} \quad (1)$$

Therefore, the peak inductor current in PFM mode is approximately:

$$I_{L_{PFMpeak}} = \frac{(V_{IN} - V_{OUT})}{L} \times t_{ONmin} \quad (2)$$

The transition from PFM into PWM mode and vice versa can be estimated to:

$$I_{OUT\_PFM/PWM} = 0.5 \times I_{L_{PFMpeak}}$$

where

- $t_{ON}$ : High-side switch ON-time [ns]
  - $V_{IN}$ : Input voltage [V]
  - $V_{OUT}$ : Output voltage [V]
  - L: Inductance [ $\mu$ H]
  - $I_{L_{PFMpeak}}$ : PFM inductor peak current [mA]
  - $I_{OUT\_PFM/PWM}$ : Output current for PFM to PWM mode transition and vice versa [mA]
- (3)

### 8.4.3 Forced PWM Mode

Pulling the MODE pin high forces the converter to operate in a continuous conduction PWM mode even at light load currents. The advantage is that the converter operates with a quasi-fixed frequency that allows simple filtering of the switching frequency for noise-sensitive applications. In this mode, the efficiency is lower compared to the power save mode during light loads. This pin must be terminated except for the TPS622319, which has an integrated 1M $\Omega$  always active pull-down resistor.

For additional flexibility, it is possible to switch from power-save mode to forced PWM mode during operation. This allows efficient power management by adjusting the operation of the converter to the specific system requirements.

## Device Functional Modes (continued)

### 8.4.4 100% Duty Cycle Low Dropout Operation

The device starts to enter 100% duty cycle mode once the input voltage comes close to the nominal output voltage. To maintain the output voltage, the high side switch is turned on 100% for one or more cycles.

With further decreasing  $V_{IN}$  the high-side MOSFET switch is turned on completely. In this case the converter offers a low input-to-output voltage difference. This is particularly useful in battery-powered applications to achieve longest operation time by taking full advantage of the whole battery voltage range.

The minimum input voltage to maintain regulation depends on the load current and output voltage, and can be calculated as:

$$V_{INmin} = V_{OUTmax} + I_{OUTmax} \times (R_{DS(on)max} + R_L)$$

where

- $I_{OUTmax}$ : maximum output current plus inductor ripple current
- $R_{DS(on)max}$ : maximum P-channel switch  $R_{DSon}$
- $R_L$ : DC resistance of the inductor
- $V_{OUTmax}$ : nominal output voltage plus maximum output voltage tolerance (4)

### 8.4.5 Short Circuit Protection

The TPS6223x integrates a high-side and low-side MOSFET current limit to protect the device against heavy load or short circuit. The current in the switches is monitored by current limit comparators. When the current in the P-channel MOSFET reaches its current limit, the P-channel MOSFET is turned off and the N-channel MOSFET is turned on to ramp down the current in the inductor. The high-side MOSFET switch can only turn on again, once the current in the low side MOSFET switch has decreased below the threshold of its current limit comparator.

## 9 Application and Implementation

### 注

Information in the following applications sections is not part of the TI component specification, and TI does not warrant its accuracy or completeness. TI's customers are responsible for determining suitability of components for their purposes. Customers should validate and test their design implementation to confirm system functionality.

### 9.1 Application Information

The TPS6223x device family are high-frequency, synchronous, step-down DC-DC converters providing switch frequencies up to 3.8 MHz. Different fixed output voltage versions are available from 1.0 V to 3.3 V.

### 9.2 Typical Application

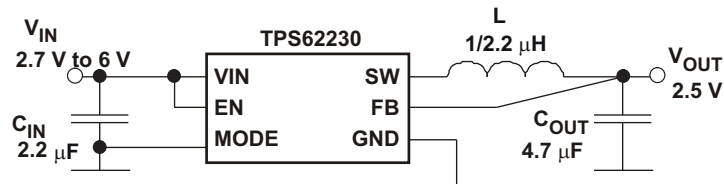

Copyright © 2016, Texas Instruments Incorporated

图 5. TPS62230 2.5-V Output

#### 9.2.1 Design Requirements

The device operates over an input voltage range from 2.05 V to 6 V. The device family offers a broad range of internally fixed output voltage options from 1 V to 3.3 V. The TPS6223x is easy to use and needs just three external components; however, the selection of external components and PCB layout must comply with the design guidelines to achieve specified performance.

#### 9.2.2 Detailed Design Procedure

##### 9.2.2.1 Output Filter Design (Inductor and Output Capacitor)

The TPS6223x is optimized to operate with effective inductance values in the range of 0.7  $\mu\text{H}$  to 4.3  $\mu\text{H}$  and with effective output capacitance in the range of 2.0  $\mu\text{F}$  to 15  $\mu\text{F}$ . The internal compensation is optimized to operate with an output filter of  $L = 1.0 \mu\text{H}/2.2 \mu\text{H}$  and  $C_{\text{OUT}} = 4.7 \mu\text{F}$ . Larger or smaller inductor/capacitor values can be used to optimize the performance of the device for specific operation conditions. For more details, see the [Checking Loop Stability](#) section.

## Typical Application (continued)

### 9.2.2.2 Inductor Selection

The inductor value affects its peak-to-peak ripple current, the PWM-to-PFM transition point, the output voltage ripple and the efficiency. The selected inductor has to be rated for its DC resistance and saturation current. The inductor ripple current ( $\Delta I_L$ ) decreases with higher inductance and increases with higher  $V_{IN}$  or  $V_{OUT}$ . 式 5 calculates the maximum inductor current under static load conditions. The saturation current of the inductor must be rated higher than the maximum inductor current as calculated with 式 6. This is recommended because during heavy load transient the inductor current will rise above the calculated value.

$$\Delta I_L = V_{out} \times \frac{1 - \frac{V_{out}}{V_{in}}}{L \times f} \quad (5)$$

$$I_{Lmax} = I_{outmax} + \frac{\Delta I_L}{2}$$

where

- $f$  = Switching frequency
  - $L$  = Inductor value
  - $\Delta I_L$  = Peak-to-peak inductor ripple current
  - $I_{Lmax}$  = Maximum inductor current
- (6)

In high-frequency converter applications, the efficiency is essentially affected by the inductor AC resistance (that is, quality factor) and to a smaller extent by the inductor DCR value. To achieve high-efficiency operation, take care in selecting inductors featuring a quality factor above 25 at the switching frequency. Increasing the inductor value produces lower RMS currents, but degrades transient response. For a given physical inductor size, increased inductance usually results in an inductor with lower saturation current.

The total losses of the coil consist of both the losses in the DC resistance,  $R_{(DC)}$ , and the following frequency-dependent components:

- The losses in the core material (magnetic hysteresis loss, especially at high switching frequencies)
- Additional losses in the conductor from the skin effect (current displacement at high frequencies)
- Magnetic field losses of the neighboring windings (proximity effect)
- Radiation losses

The following inductor series from different suppliers have been used with the TPS6223x converters.

表 1. List of Inductors

INDUCTANCE ( $\mu$ H)	DIMENSIONS (mm <sup>3</sup> )	INDUCTOR TYPE	SUPPLIER <sup>(1)</sup>
1.0 / 2.2	2.5 × 2.0 × 1.2	LQM2HPN1R0MJ0	Murata
2.2	2.0 × 1.2 × 0.55	LQM21PN2R2	Murata
1.0 / 2.2	2.0 × 1.2 × 1.0	MIPSZ2012	FDK
1.0 / 2.2	2.0 × 2.5 × 1.2	MIPSA2520	FDK
1.0 / 2.2	2.0 × 1.2 × 1.0	KSLI2012 series	Hitachi Metal

(1) See [Third-Party Products Disclaimer](#)

### 9.2.2.3 Output Capacitor Selection

The unique hysteretic PWM control scheme of the TPS62230 allows the use of tiny ceramic capacitors. Ceramic capacitors with low ESR values have the lowest output voltage ripple and are recommended. The output capacitor requires either an X7R or X5R dielectric. Y5V and Z5U dielectric capacitors, aside from their wide variation in capacitance over temperature, become resistive at high frequencies.

At light load currents, the converter operate in power save mode and the output voltage ripple is dependent on the output capacitor value and the PFM peak inductor current. Higher output capacitor values minimize the voltage ripple in PFM mode and tighten DC output accuracy in PFM mode.

### 9.2.2.4 Input Capacitor Selection

Because of the nature of the buck converter having a pulsating input current, a low-ESR input capacitor is required for best input voltage filtering and minimizing the interference with other circuits caused by high input voltage spikes. For most applications a 2.2- $\mu$ F to 4.7- $\mu$ F ceramic capacitor is recommended. The input capacitor can be increased without any limit for better input voltage filtering. Because ceramic capacitor loses up to 80% of its initial capacitance at 5 V, TI recommends using 4.7  $\mu$ F input capacitors for input voltages > 4.5 V.

Take care when using only small ceramic input capacitors. When a ceramic capacitor is used at the input and the power is being supplied through long wires, such as from a wall adapter, a load step at the output or  $V_{IN}$  step on the input can induce ringing at the VIN pin. This ringing can couple to the output and be mistaken as loop instability or could even damage the part by exceeding the maximum ratings.

表 2 shows a list of tested input and output capacitors.

表 2. List of Capacitors

CAPACITANCE [ $\mu$ F]	SIZE	CAPACITOR TYPE	SUPPLIER <sup>(1)</sup>
2.2	0402	GRM155R60J225	Murata
4.7	0402	AMK105BJ475MV	Taiyo Yuden
4.7	0402	GRM155R60J475	Murata
4.7	0402	CL05A475MQ5NRNC	Samsung
4.7	0603	GRM188R60J475	Murata

(1) See [Third-Party Products Disclaimer](#)

### 9.2.2.5 Checking Loop Stability

The first step of circuit and stability evaluation is to look from a steady-state perspective at the following signals:

- Switching node, SW
- Inductor current,  $I_L$
- Output ripple voltage,  $V_{OUT(AC)}$

These are the basic signals that need to be measured when evaluating a switching converter. When the switching waveform shows large duty cycle jitter or the output voltage or inductor current shows oscillations, the regulation loop may be unstable. This is often a result of board layout and/or L-C combination.

As a next step in the evaluation of the regulation loop, the load transient response is tested. The time between the application of the load transient and the turn on of the P-channel MOSFET, the output capacitor must supply all of the current required by the load.  $V_{OUT}$  immediately shifts by an amount equal to  $\Delta I_{(LOAD)} \times ESR$ , where ESR is the effective series resistance of  $C_{OUT}$ .  $\Delta I_{(LOAD)}$  begins to charge or discharge  $C_O$  generating a feedback error signal used by the regulator to return  $V_{OUT}$  to its steady-state value. The results are most easily interpreted when the device operates in PWM mode.

During this recovery time,  $V_{OUT}$  can be monitored for settling time, overshoot or ringing that helps judge the converter's stability. Without any ringing, the loop has usually more than 45° of phase margin.

Because the damping factor of the circuitry is directly related to several resistive parameters (for example, MOSFET  $r_{DS(on)}$ ) that are temperature dependant, the loop stability analysis has to be done over the input voltage range, load current range, and temperature range.

## 9.2.3 Application Curves

### 9.2.3.1 $V_{OUT} = 1.1\text{ V}$ – TPS622311

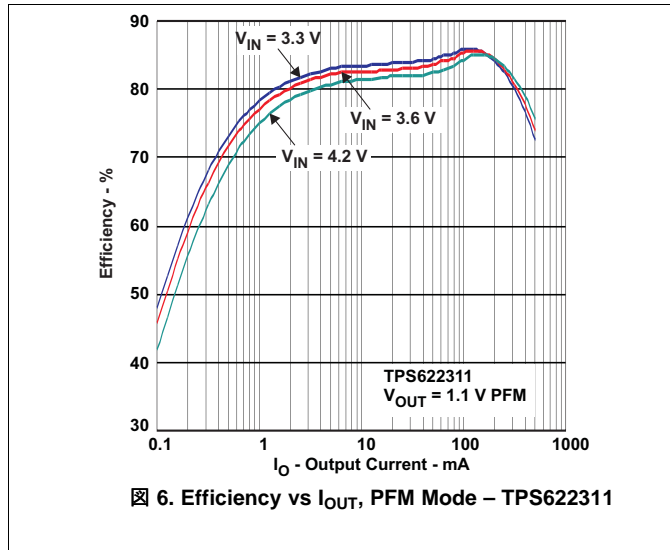

Figure 6. Efficiency vs  $I_{OUT}$ , PFM Mode – TPS622311

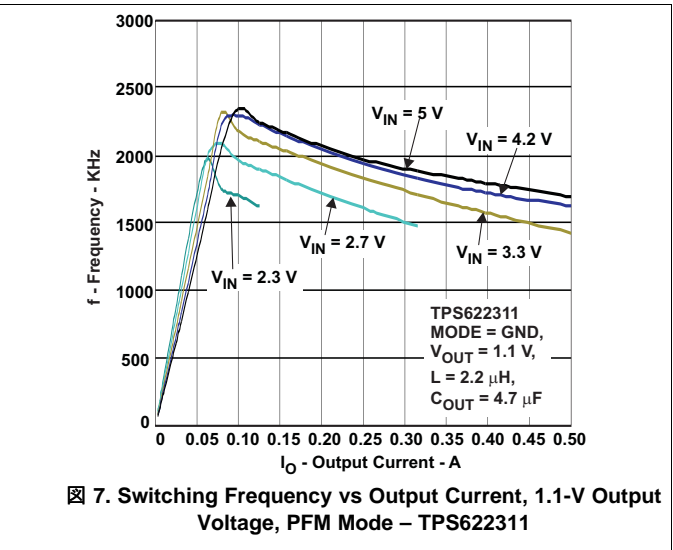

Figure 7. Switching Frequency vs Output Current, 1.1-V Output Voltage, PFM Mode – TPS622311

### 9.2.3.2 $V_{OUT} = 1.2\text{ V}$ – TPS62232/TPS62235

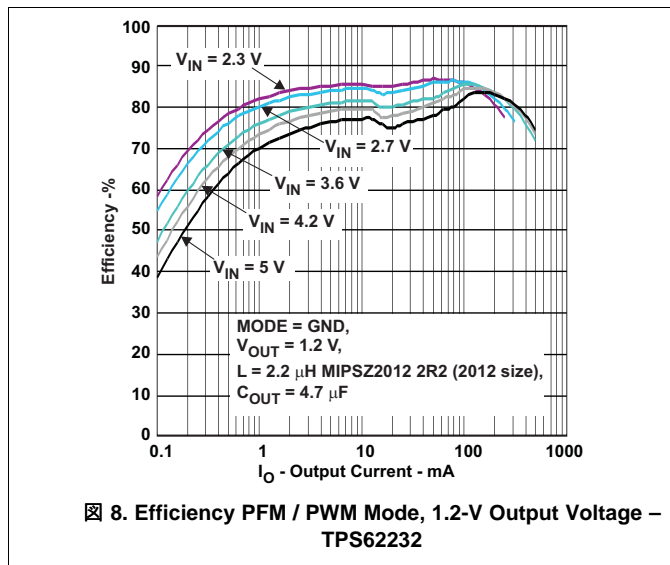

Figure 8. Efficiency PFM / PWM Mode, 1.2-V Output Voltage – TPS62232

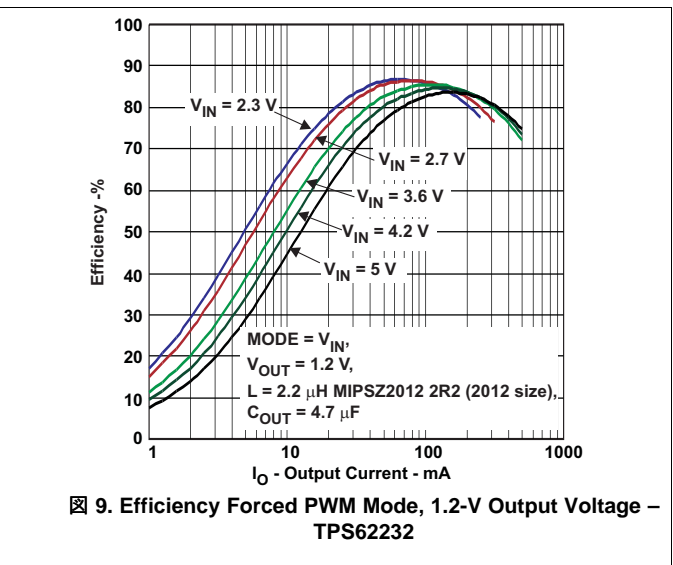
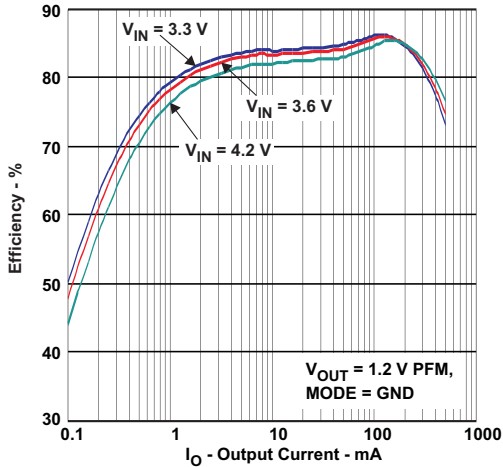
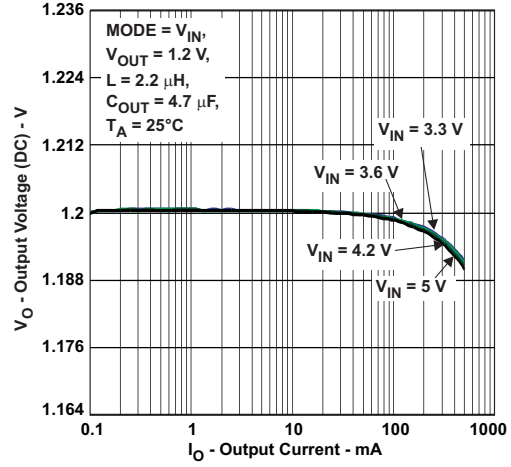

Figure 9. Efficiency Forced PWM Mode, 1.2-V Output Voltage – TPS62232





10. Efficiency vs  $I_{O,UT}$ , PFM / PWM Mode – TPS62235



11. 1.2-V Output Voltage Accuracy Forced PWM Mode – TPS62232

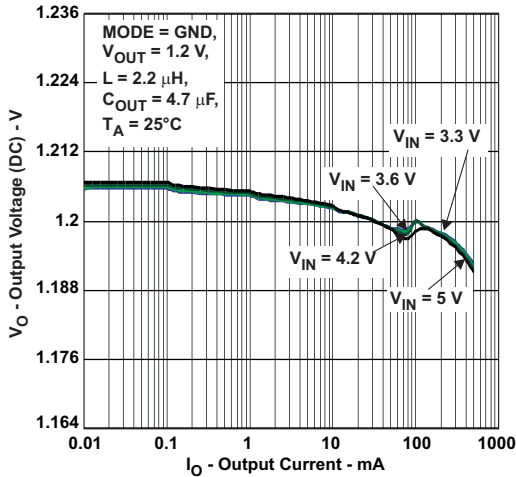

12. 1.2-V Output Voltage Accuracy PFM/PWM Mode – TPS62232

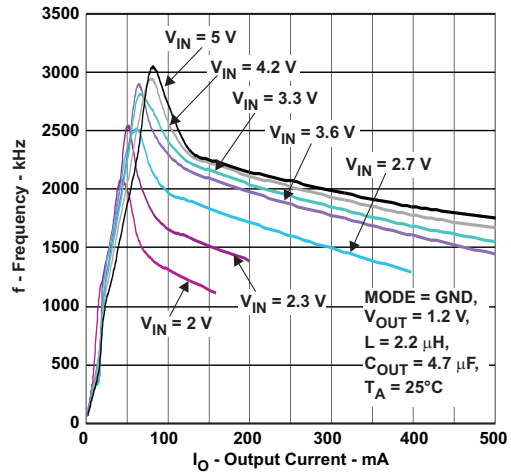

13. Switching Frequency vs Output Current, 1.2-V Output Voltage, PFM/PWM Mode – TPS62232

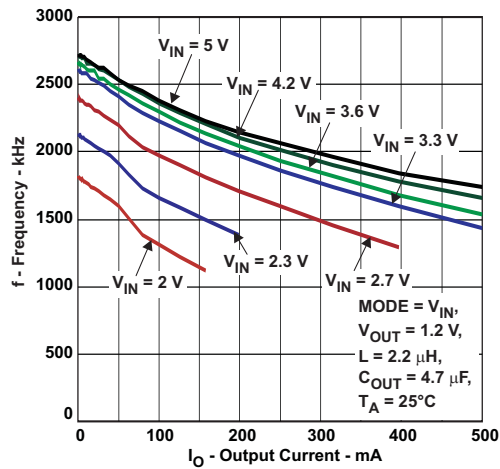

14. Switching Frequency vs Output Current, 1.2-V Output Voltage, Forced PWM Mode – TPS62232

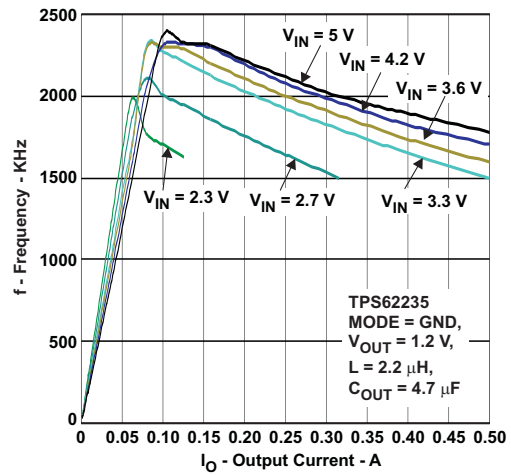

15. Switching Frequency vs Output Current, 1.2-V Output Voltage, PFM/PWM Mode – TPS62235

**9.2.3.3  $V_{OUT} = 1.8\text{ V}$  – TPS62231**

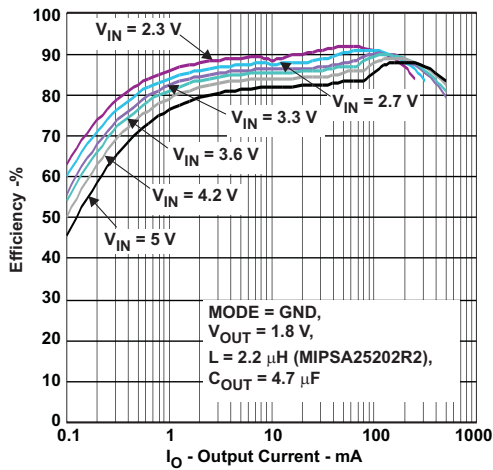

16. Efficiency PFM/PWM Mode, 1.8-V Output Voltage – TPS62231

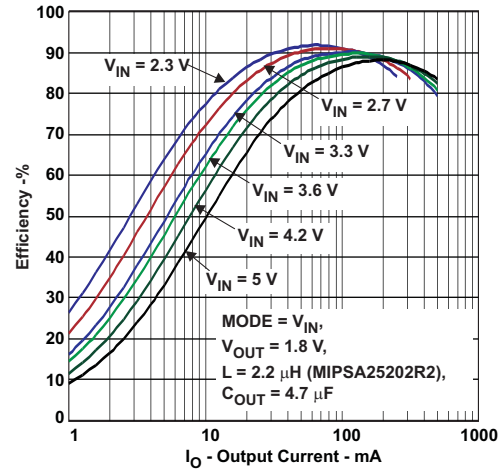

17. Efficiency Forced PWM Mode, 1.8-V Output Voltage – TPS62231

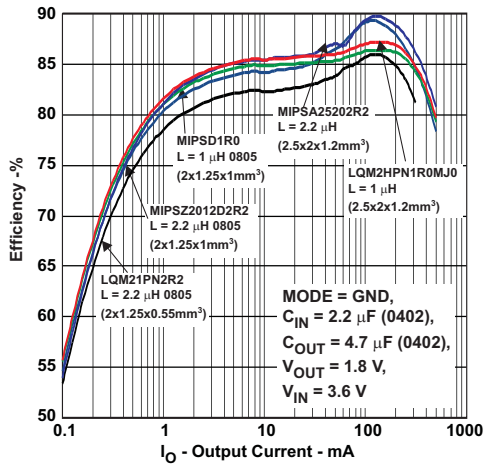

18. Comparison Efficiency vs Inductor Value and Size – TPS62231

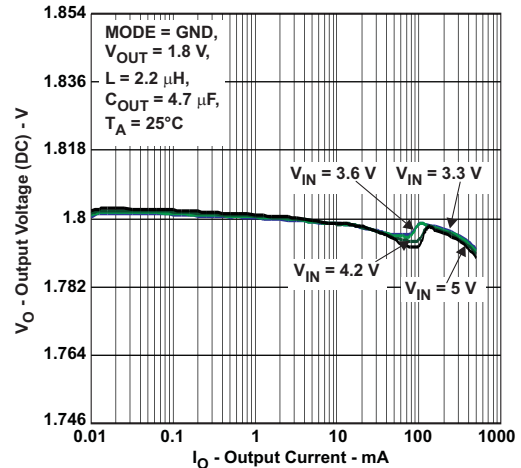

19. 1.8-V Output Voltage Accuracy PFM / PWM Mode – TPS62231

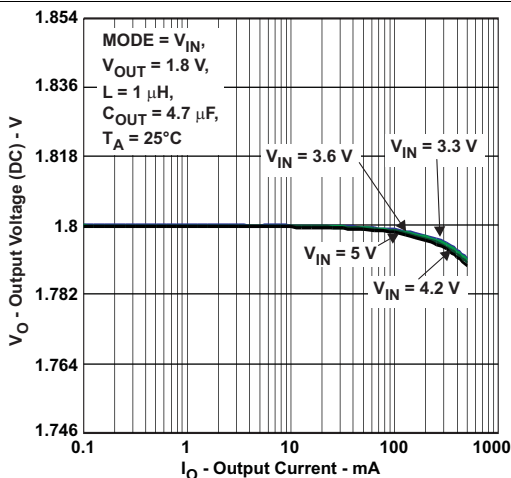

20. 1.8-V Output Voltage Accuracy Forced PWM Mode – TPS62231

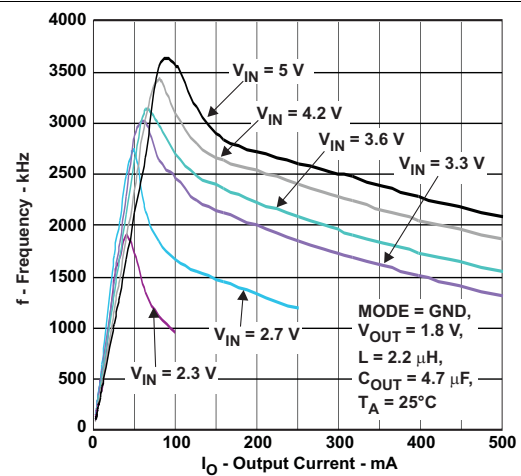

21. Switching Frequency vs Output Current, 1.8-V Output Voltage, PFM/PWM Mode – TPS62231



图 22. Switching Frequency vs Output Current, 1.8-V Output Voltage, PFM/PWM Mode – TPS62231



图 23. Switching Frequency vs Output Current, 1.8-V Output Voltage, Forced PWM Mode – TPS62231

9.2.3.4  $V_{OUT} = 1.85 V$  – TPS62236

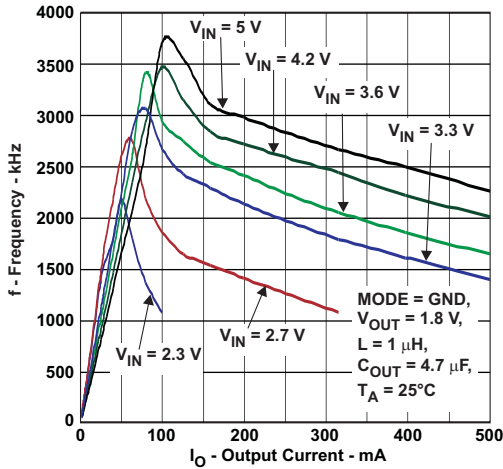

图 24. Efficiency vs  $I_{OUT}$ , PFM/PWM Mode – TPS62236

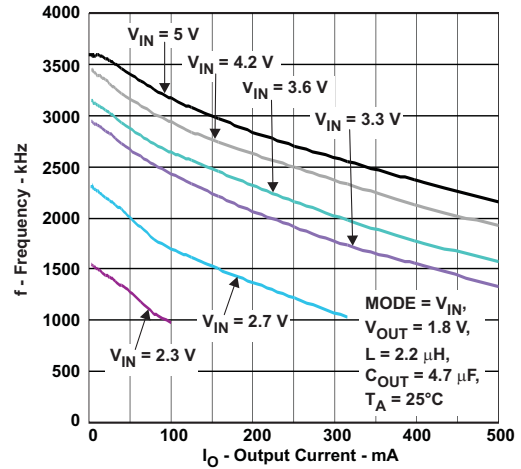

图 25. Switching Frequency vs Output Current, 1.85-V Output Voltage, PFM/PWM Mode – TPS62236

9.2.3.5  $V_{OUT} = 2.5\text{ V}$  – TPS62230

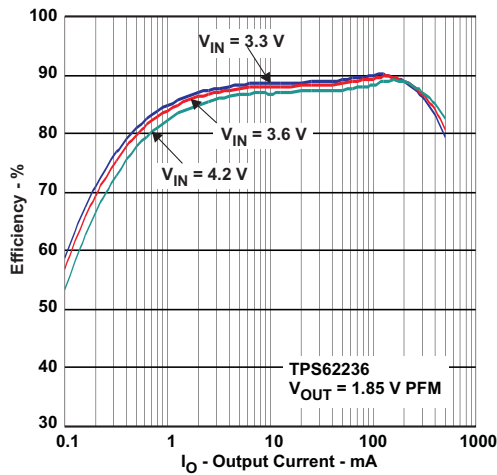

26. Efficiency PFM/PWM Mode, 2.5-V Output Voltage – TPS62230

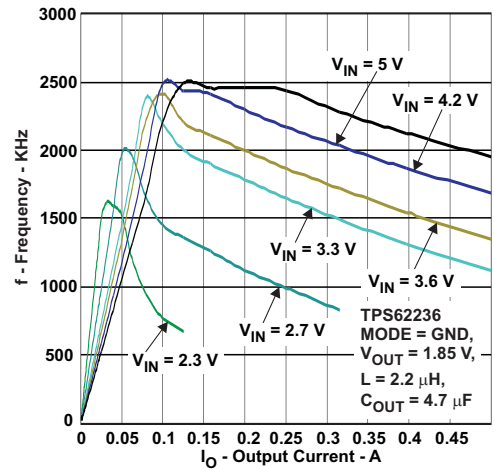
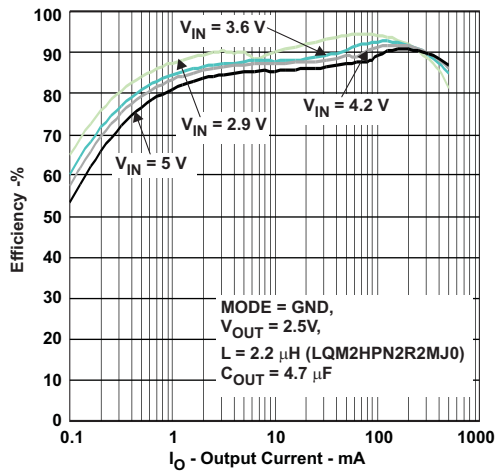
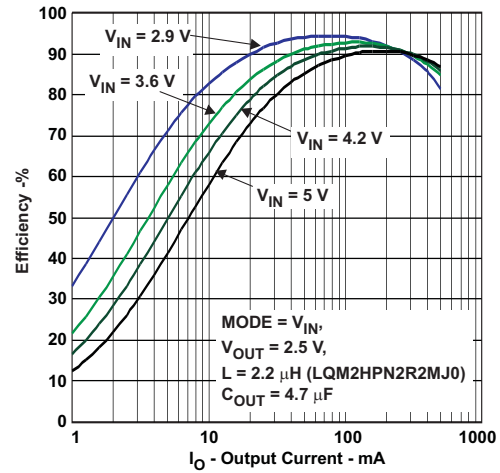

27. Efficiency Forced PWM Mode, 2.5-V Output Voltage – TPS62230

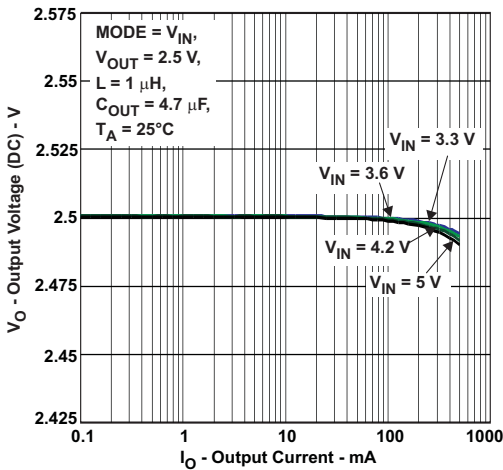

28. 2.5V Output Voltage Accuracy Forced PWM Mode – TPS62230

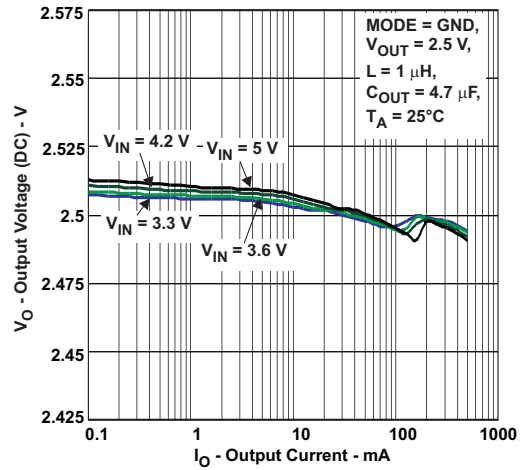

29. 2.5-V Output Voltage Accuracy PFM/PWM Mode – TPS62230

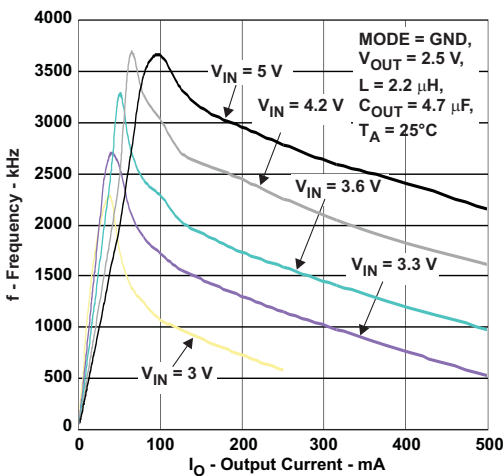

30. Switching Frequency vs Output Current, 2.5-V Output Voltage, PFM/PWM Mode – TPS62230

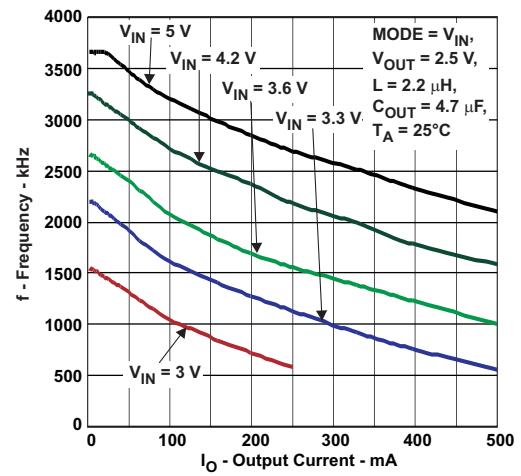

31. Switching Frequency vs Output Current, 2.5-V Output Voltage, Forced PWM Mode – TPS62230

9.2.3.6  $V_{OUT} = 3.0\text{ V} - \text{TPS62233}$

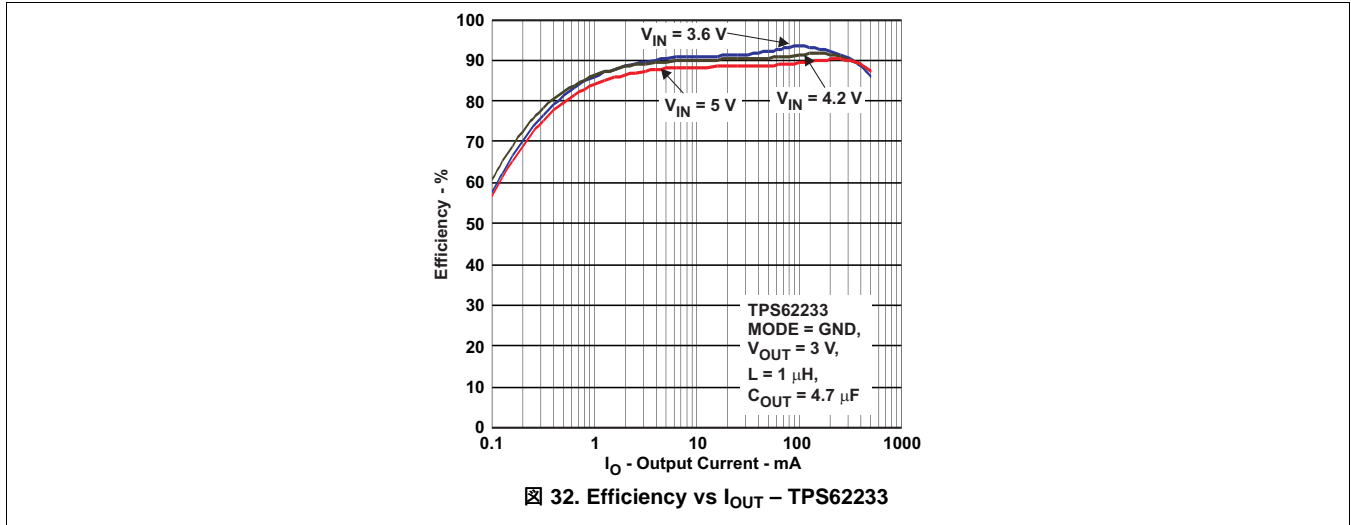

9.2.3.7 Start-Up

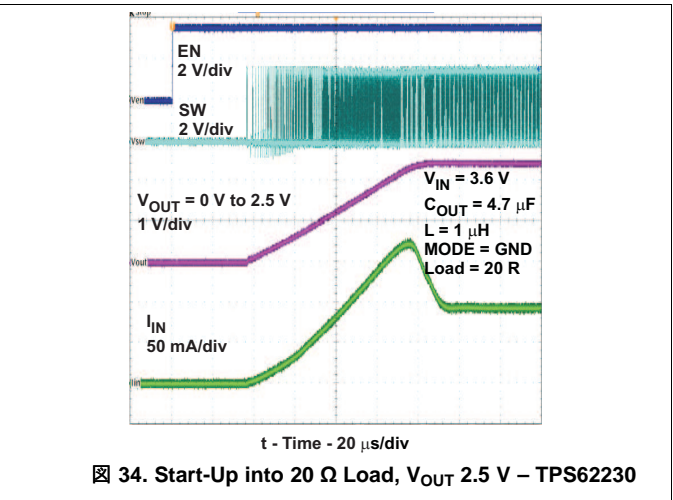
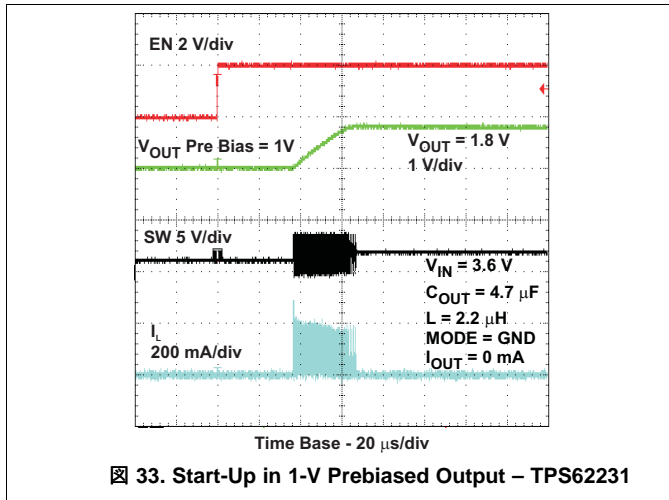

### 9.2.3.8 PFM / PWM Operation

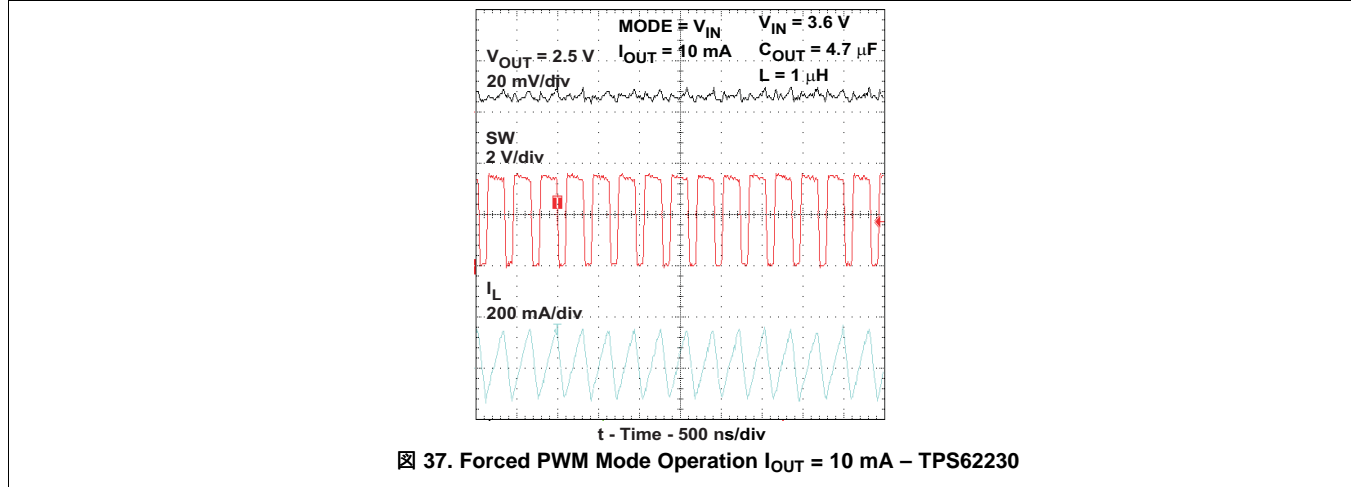
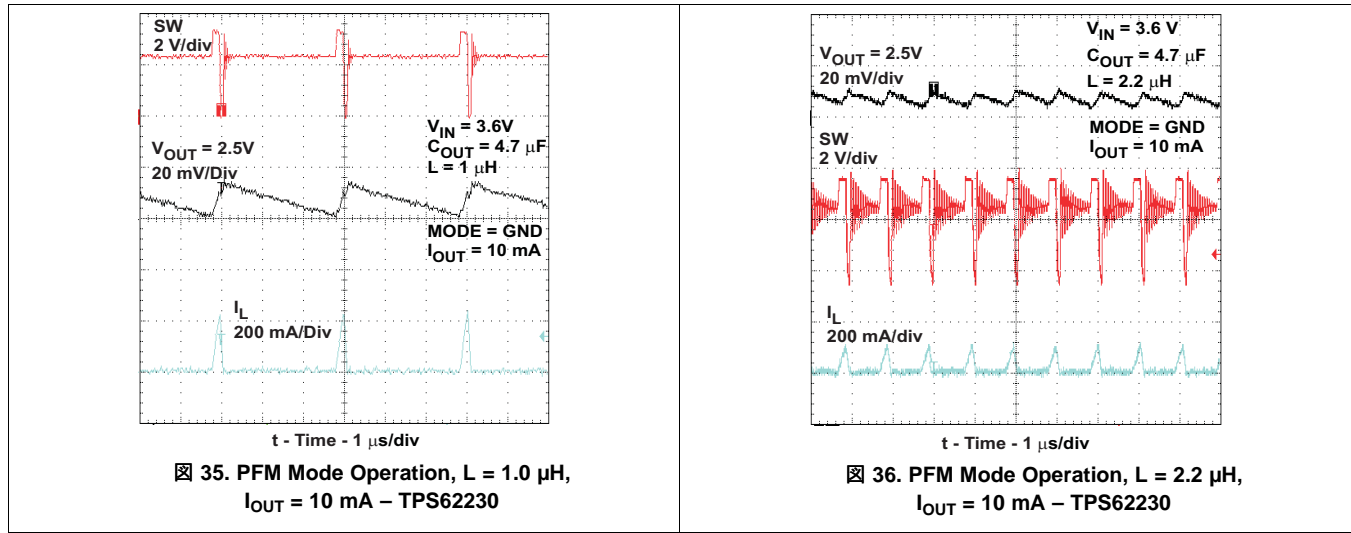

### 9.2.3.9 Peak-to-Peak Output Ripple Voltage

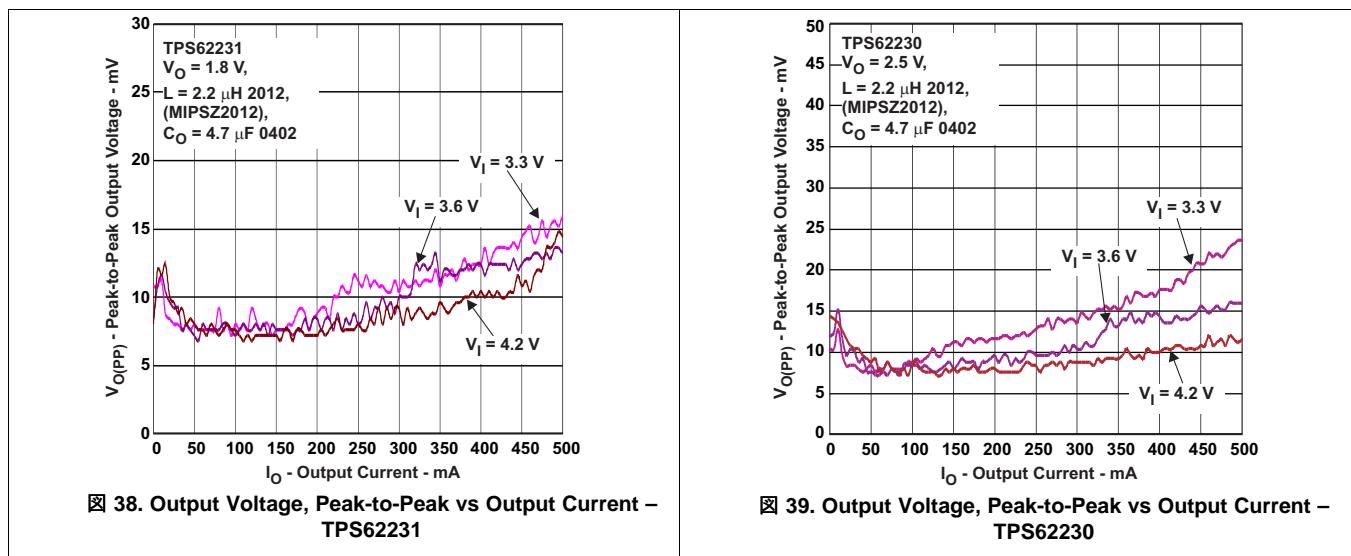

### 9.2.3.10 Power-Supply Rejection

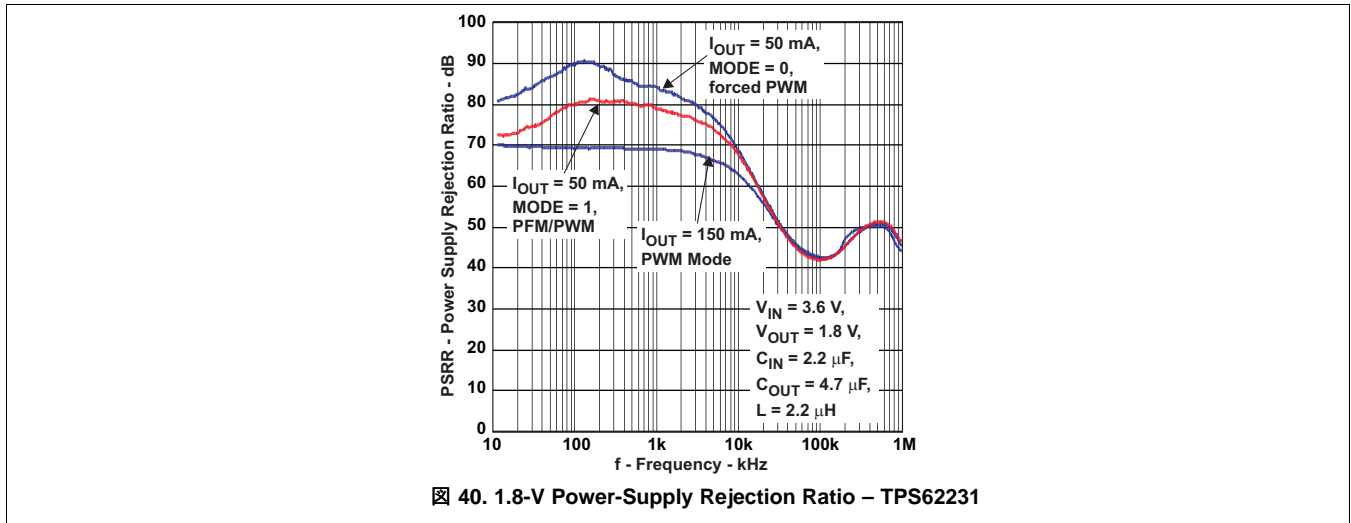

### 9.2.3.11 Spurious Output Noise

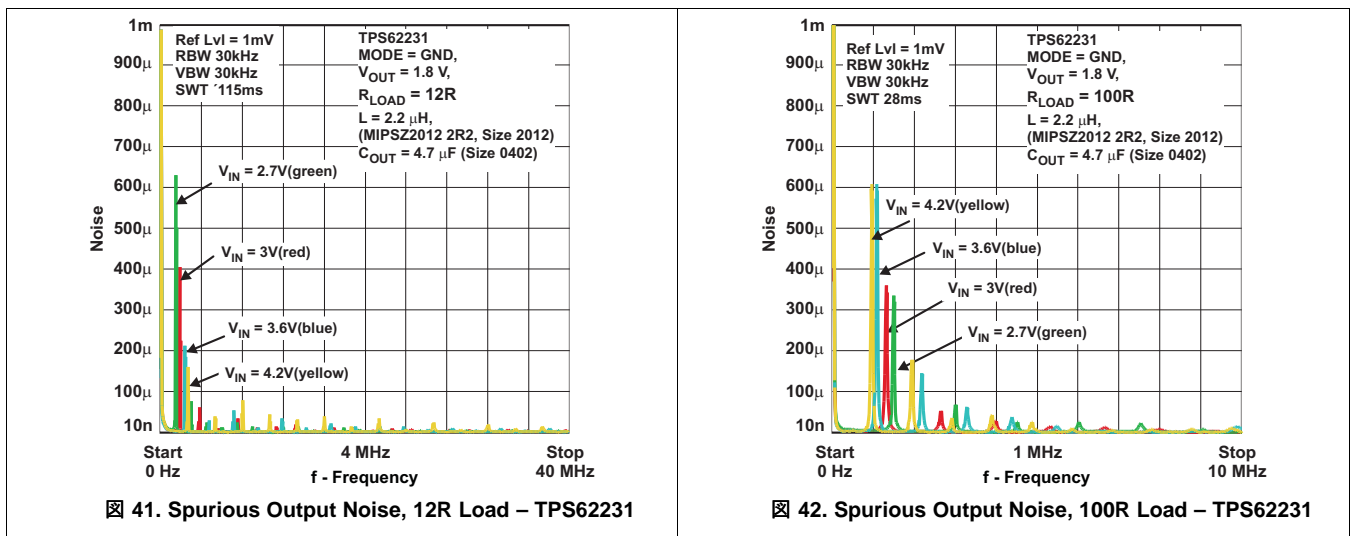

### 9.2.3.12 Line Transient Response

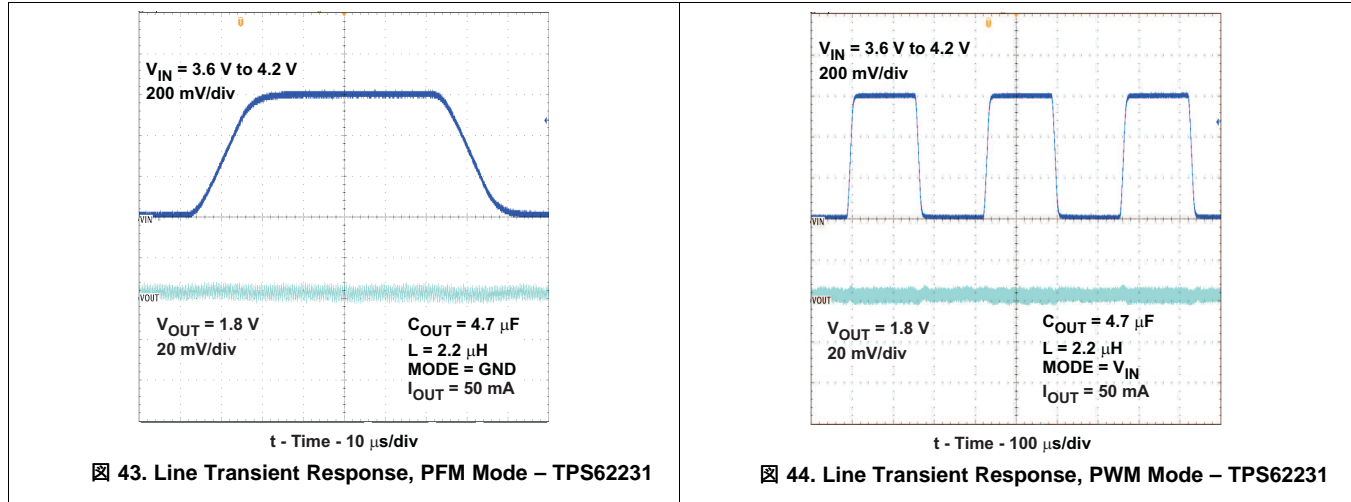

### 9.2.3.13 Mode Transition

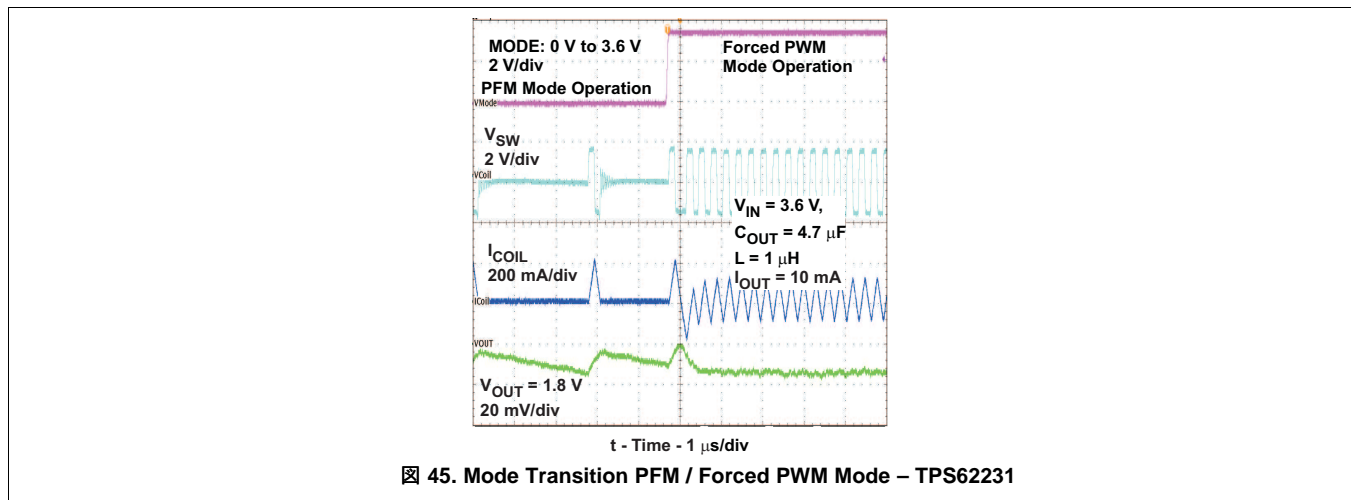



9.2.3.14 AC-Load Regulation

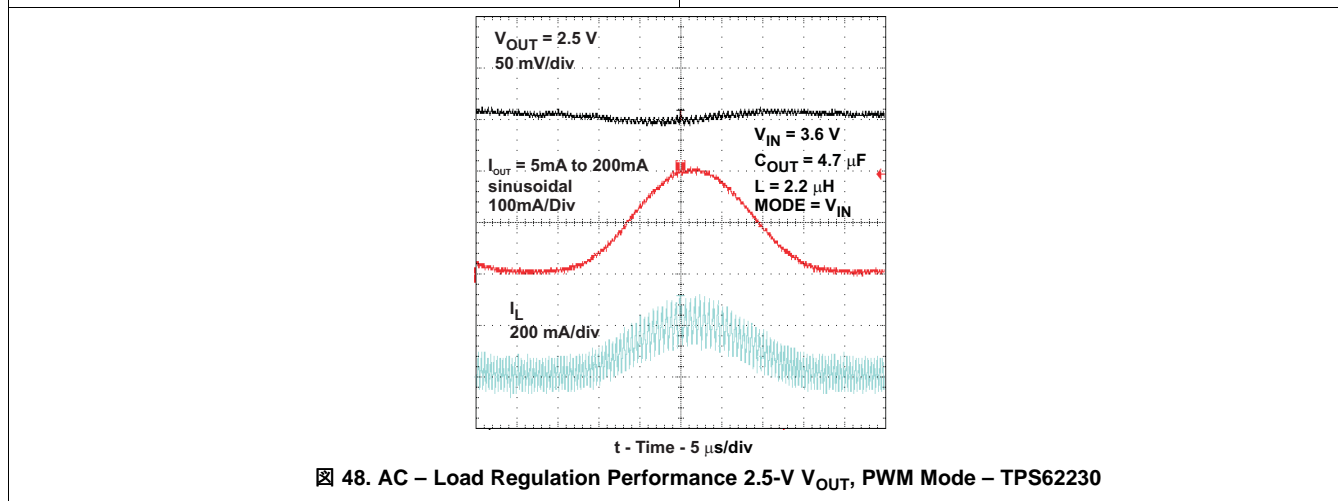
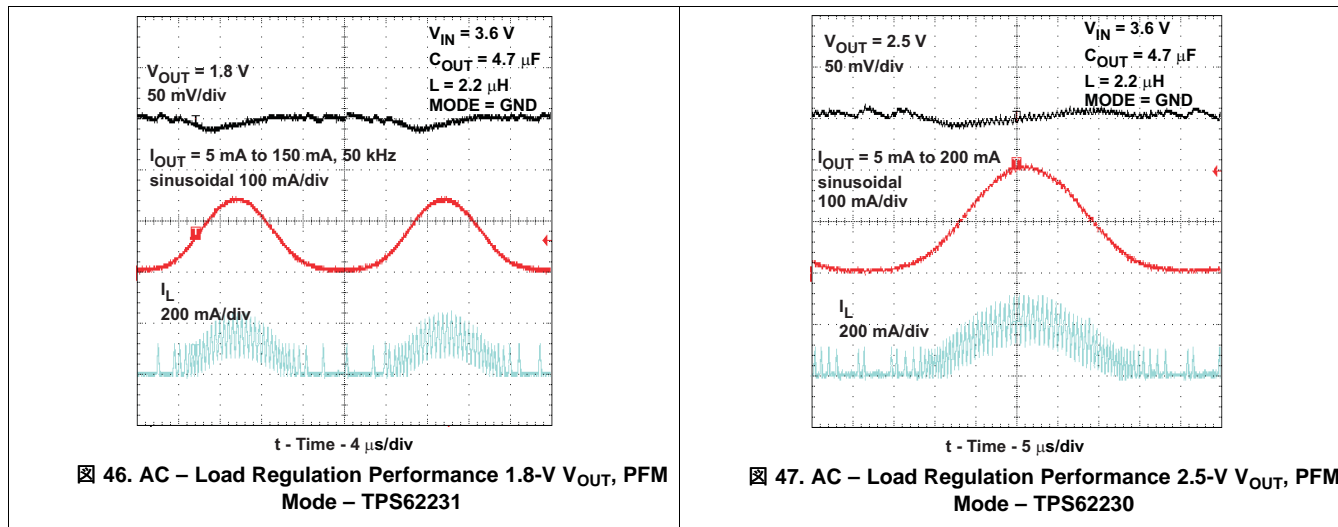

9.2.3.15 Load Transient Response

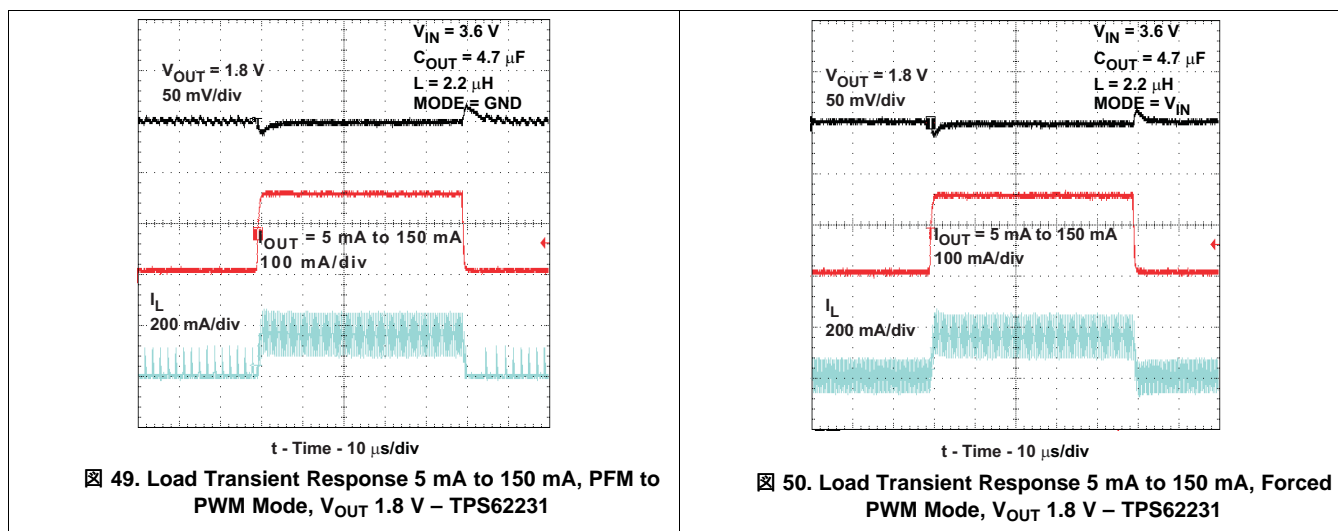

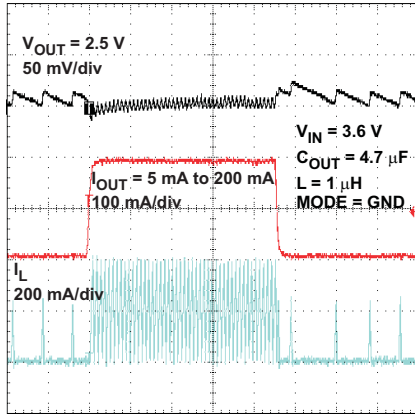

⊠ 51. Load Transient Response 5 mA to 200 mA, PFM to PWM Mode,  $V_{OUT}$  2.5 V – TPS62230

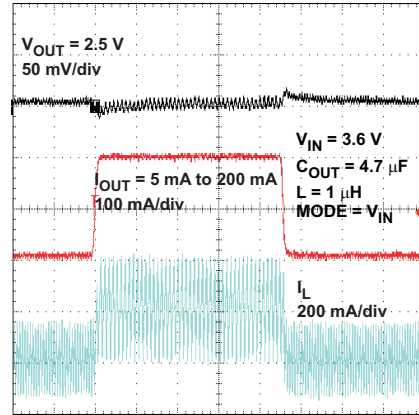

⊠ 52. Load Transient Response 5 mA to 200 mA, Forced PWM Mode,  $V_{OUT}$  2.5 V – TPS62230

### 9.3 System Examples

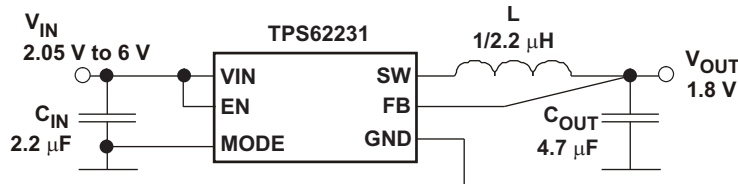

Copyright © 2016, Texas Instruments Incorporated

⊠ 53. TPS62231 1.8-V Output

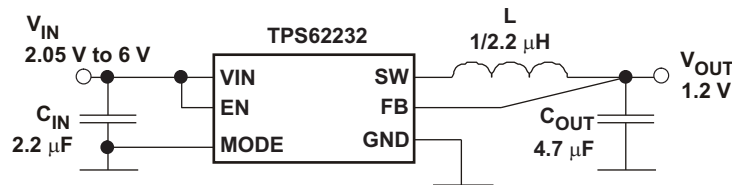

Copyright © 2016, Texas Instruments Incorporated

⊠ 54. TPS62232 1.2-V Output

## 10 Power Supply Recommendations

The TPS6223x device family has no special requirements for its input power supply. The output current of the input power supply must to be rated according to the supply voltage, output voltage and output current of the TPS6223x.

## 11 Layout

### 11.1 Layout Guidelines

As for all switching power supplies, the layout is an important step in the design. Proper function of the device demands careful attention to PCB layout. Take care in the board layout to get the specified performance. If the layout is not carefully done, the regulator could show poor line and/or load regulation, stability issues, as well as EMI problems. It is critical to provide a low-inductance, impedance ground path. Therefore, use wide and short traces for the main current paths. The input capacitor must be placed as close as possible to the IC pins as well as the inductor and output capacitor.

Use a common power GND node and a different node for the signal GND to minimize the effects of ground noise. Keep the common path to the GND pin, which returns the small signal components and the high current of the output capacitors as short as possible to avoid ground noise. The FB line must be connected to the output capacitor and routed away from noisy components and traces (for example, SW line).

### 11.2 Layout Example

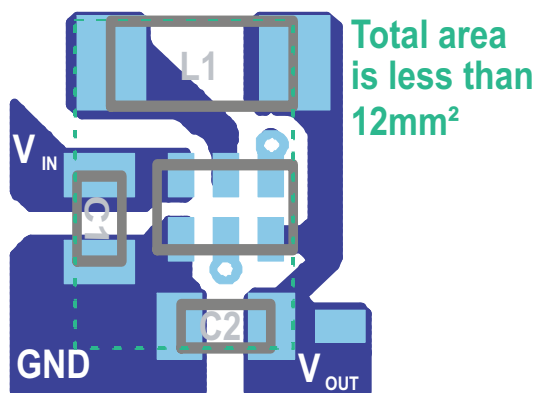

☒ 55. Recommended PCB Layout for TPS6223x

## 12 デバイスおよびドキュメントのサポート

### 12.1 デバイス・サポート

#### 12.1.1 デベロッパー・ネットワークの製品に関する免責事項

デベロッパー・ネットワークの製品またはサービスに関するTIの出版物は、単独またはTIの製品、サービスと一緒に提供される場合に関係なく、デベロッパー・ネットワークの製品またはサービスの適合性に関する是認、デベロッパー・ネットワークの製品またはサービスの是認の表明を意味するものではありません。

### 12.2 関連リンク

次の表に、クイック・アクセス・リンクを示します。カテゴリには、技術資料、サポートおよびコミュニティ・リソース、ツールとソフトウェア、およびサンプル注文またはご購入へのクイック・アクセスが含まれます。

表 3. 関連リンク

製品	プロダクト・フォルダ	サンプルとご購入	技術資料	ツールとソフトウェア	サポートとコミュニティ
TPS62230	<a href="#">ここをクリック</a>	<a href="#">ここをクリック</a>	<a href="#">ここをクリック</a>	<a href="#">ここをクリック</a>	<a href="#">ここをクリック</a>
TPS62231	<a href="#">ここをクリック</a>	<a href="#">ここをクリック</a>	<a href="#">ここをクリック</a>	<a href="#">ここをクリック</a>	<a href="#">ここをクリック</a>
TPS62232	<a href="#">ここをクリック</a>	<a href="#">ここをクリック</a>	<a href="#">ここをクリック</a>	<a href="#">ここをクリック</a>	<a href="#">ここをクリック</a>
TPS62233	<a href="#">ここをクリック</a>	<a href="#">ここをクリック</a>	<a href="#">ここをクリック</a>	<a href="#">ここをクリック</a>	<a href="#">ここをクリック</a>
TPS62234	<a href="#">ここをクリック</a>	<a href="#">ここをクリック</a>	<a href="#">ここをクリック</a>	<a href="#">ここをクリック</a>	<a href="#">ここをクリック</a>
TPS62235	<a href="#">ここをクリック</a>	<a href="#">ここをクリック</a>	<a href="#">ここをクリック</a>	<a href="#">ここをクリック</a>	<a href="#">ここをクリック</a>
TPS62236	<a href="#">ここをクリック</a>	<a href="#">ここをクリック</a>	<a href="#">ここをクリック</a>	<a href="#">ここをクリック</a>	<a href="#">ここをクリック</a>
TPS62237	<a href="#">ここをクリック</a>	<a href="#">ここをクリック</a>	<a href="#">ここをクリック</a>	<a href="#">ここをクリック</a>	<a href="#">ここをクリック</a>
TPS62238	<a href="#">ここをクリック</a>	<a href="#">ここをクリック</a>	<a href="#">ここをクリック</a>	<a href="#">ここをクリック</a>	<a href="#">ここをクリック</a>
TPS62239	<a href="#">ここをクリック</a>	<a href="#">ここをクリック</a>	<a href="#">ここをクリック</a>	<a href="#">ここをクリック</a>	<a href="#">ここをクリック</a>
TPS622310	<a href="#">ここをクリック</a>	<a href="#">ここをクリック</a>	<a href="#">ここをクリック</a>	<a href="#">ここをクリック</a>	<a href="#">ここをクリック</a>
TPS622311	<a href="#">ここをクリック</a>	<a href="#">ここをクリック</a>	<a href="#">ここをクリック</a>	<a href="#">ここをクリック</a>	<a href="#">ここをクリック</a>
TPS622312	<a href="#">ここをクリック</a>	<a href="#">ここをクリック</a>	<a href="#">ここをクリック</a>	<a href="#">ここをクリック</a>	<a href="#">ここをクリック</a>
TPS622313	<a href="#">ここをクリック</a>	<a href="#">ここをクリック</a>	<a href="#">ここをクリック</a>	<a href="#">ここをクリック</a>	<a href="#">ここをクリック</a>
TPS622314	<a href="#">ここをクリック</a>	<a href="#">ここをクリック</a>	<a href="#">ここをクリック</a>	<a href="#">ここをクリック</a>	<a href="#">ここをクリック</a>
TPS622315	<a href="#">ここをクリック</a>	<a href="#">ここをクリック</a>	<a href="#">ここをクリック</a>	<a href="#">ここをクリック</a>	<a href="#">ここをクリック</a>
TPS622316	<a href="#">ここをクリック</a>	<a href="#">ここをクリック</a>	<a href="#">ここをクリック</a>	<a href="#">ここをクリック</a>	<a href="#">ここをクリック</a>
TPS622317	<a href="#">ここをクリック</a>	<a href="#">ここをクリック</a>	<a href="#">ここをクリック</a>	<a href="#">ここをクリック</a>	<a href="#">ここをクリック</a>
TPS622318	<a href="#">ここをクリック</a>	<a href="#">ここをクリック</a>	<a href="#">ここをクリック</a>	<a href="#">ここをクリック</a>	<a href="#">ここをクリック</a>
TPS622319	<a href="#">ここをクリック</a>	<a href="#">ここをクリック</a>	<a href="#">ここをクリック</a>	<a href="#">ここをクリック</a>	<a href="#">ここをクリック</a>

### 12.3 ドキュメントの更新通知を受け取る方法

ドキュメントの更新についての通知を受け取るには、ti.comのデバイス製品フォルダを開いてください。右上の隅にある「通知を受け取る」をクリックして登録すると、変更されたすべての製品情報に関するダイジェストを毎週受け取れます。変更の詳細については、修正されたドキュメントに含まれている改訂履歴をご覧ください。

## 12.4 コミュニティ・リソース

The following links connect to TI community resources. Linked contents are provided "AS IS" by the respective contributors. They do not constitute TI specifications and do not necessarily reflect TI's views; see TI's [Terms of Use](#).

**TI E2E™ Online Community** *TI's Engineer-to-Engineer (E2E) Community*. Created to foster collaboration among engineers. At e2e.ti.com, you can ask questions, share knowledge, explore ideas and help solve problems with fellow engineers.

**Design Support** *TI's Design Support* Quickly find helpful E2E forums along with design support tools and contact information for technical support.

## 12.5 商標

E2E is a trademark of Texas Instruments.  
All other trademarks are the property of their respective owners.

## 12.6 静電気放電に関する注意事項



これらのデバイスは、限定的なESD(静電破壊)保護機能を内蔵しています。保存時または取り扱い時は、MOSゲートに対する静電破壊を防止するために、リード線同士をショートさせておくか、デバイスを導電フォームに入れる必要があります。

## 12.7 Glossary

**SLYZ022** — *TI Glossary*.

This glossary lists and explains terms, acronyms, and definitions.

## 13 メカニカル、パッケージ、および注文情報

以降のページには、メカニカル、パッケージ、および注文に関する情報が記載されています。これらの情報は、指定のデバイスに対して提供されている最新のデータです。このデータは予告なく変更されることがあり、ドキュメントが改訂される場合もあります。本データシートのブラウザ版を使用されている場合は、画面左側の説明をご覧ください。

**PACKAGING INFORMATION**

Orderable part number	Status (1)	Material type (2)	Package   Pins	Package qty   Carrier	RoHS (3)	Lead finish/ Ball material (4)	MSL rating/ Peak reflow (5)	Op temp (°C)	Part marking (6)
<a href="#">TPS62230DRYR</a>	Active	Production	SON (DRY)   6	5000   LARGE T&R	Yes	NIPDAUAG	Level-1-260C-UNLIM	-40 to 125	GV
TPS62230DRYR.A	Active	Production	SON (DRY)   6	5000   LARGE T&R	Yes	NIPDAUAG	Level-1-260C-UNLIM	-40 to 125	GV
<a href="#">TPS62230DRYT</a>	Active	Production	SON (DRY)   6	250   SMALL T&R	Yes	NIPDAUAG	Level-1-260C-UNLIM	-40 to 125	GV
TPS62230DRYT.A	Active	Production	SON (DRY)   6	250   SMALL T&R	Yes	NIPDAUAG	Level-1-260C-UNLIM	-40 to 125	GV
<a href="#">TPS622310DRYR</a>	Active	Production	SON (DRY)   6	5000   LARGE T&R	Yes	NIPDAUAG	Level-1-260C-UNLIM	-40 to 125	OT
TPS622310DRYR.A	Active	Production	SON (DRY)   6	5000   LARGE T&R	Yes	NIPDAUAG	Level-1-260C-UNLIM	-40 to 125	OT
<a href="#">TPS622310DRYT</a>	Active	Production	SON (DRY)   6	250   SMALL T&R	Yes	NIPDAUAG	Level-1-260C-UNLIM	-40 to 125	OT
TPS622310DRYT.A	Active	Production	SON (DRY)   6	250   SMALL T&R	Yes	NIPDAUAG	Level-1-260C-UNLIM	-40 to 125	OT
<a href="#">TPS622311DRYR</a>	Active	Production	SON (DRY)   6	5000   LARGE T&R	Yes	NIPDAU	Level-1-260C-UNLIM	-40 to 125	PA
TPS622311DRYR.A	Active	Production	SON (DRY)   6	5000   LARGE T&R	Yes	NIPDAU	Level-1-260C-UNLIM	-40 to 125	PA
<a href="#">TPS622311DRYT</a>	Active	Production	SON (DRY)   6	250   SMALL T&R	Yes	NIPDAU	Level-1-260C-UNLIM	-40 to 125	PA
TPS622311DRYT.A	Active	Production	SON (DRY)   6	250   SMALL T&R	Yes	NIPDAU	Level-1-260C-UNLIM	-40 to 125	PA
<a href="#">TPS622312DRYR</a>	Active	Production	SON (DRY)   6	5000   LARGE T&R	Yes	NIPDAUAG	Level-1-260C-UNLIM	-40 to 125	QE
TPS622312DRYR.A	Active	Production	SON (DRY)   6	5000   LARGE T&R	Yes	NIPDAUAG	Level-1-260C-UNLIM	-40 to 125	QE
<a href="#">TPS622312DRYT</a>	Active	Production	SON (DRY)   6	250   SMALL T&R	Yes	NIPDAUAG	Level-1-260C-UNLIM	-40 to 125	QE
TPS622312DRYT.A	Active	Production	SON (DRY)   6	250   SMALL T&R	Yes	NIPDAUAG	Level-1-260C-UNLIM	-40 to 125	QE
<a href="#">TPS622313DRYR</a>	Active	Production	SON (DRY)   6	5000   LARGE T&R	Yes	NIPDAUAG	Level-1-260C-UNLIM	-40 to 125	QF
TPS622313DRYR.A	Active	Production	SON (DRY)   6	5000   LARGE T&R	Yes	NIPDAUAG	Level-1-260C-UNLIM	-40 to 125	QF
<a href="#">TPS622313DRYT</a>	Active	Production	SON (DRY)   6	250   SMALL T&R	Yes	NIPDAUAG	Level-1-260C-UNLIM	-40 to 125	QF
TPS622313DRYT.A	Active	Production	SON (DRY)   6	250   SMALL T&R	Yes	NIPDAUAG	Level-1-260C-UNLIM	-40 to 125	QF
<a href="#">TPS622314DRYR</a>	Active	Production	SON (DRY)   6	5000   LARGE T&R	Yes	NIPDAU   NIPDAUAG	Level-1-260C-UNLIM	-40 to 125	QG
TPS622314DRYR.A	Active	Production	SON (DRY)   6	5000   LARGE T&R	Yes	NIPDAUAG	Level-1-260C-UNLIM	-40 to 125	QG
TPS622314DRYRG4.A	Active	Production	SON (DRY)   6	5000   LARGE T&R	Yes	NIPDAU	Level-1-260C-UNLIM	-40 to 125	QG
<a href="#">TPS622314DRYT</a>	Active	Production	SON (DRY)   6	250   SMALL T&R	Yes	NIPDAU   NIPDAUAG	Level-1-260C-UNLIM	-40 to 125	QG
TPS622314DRYT.A	Active	Production	SON (DRY)   6	250   SMALL T&R	Yes	NIPDAUAG	Level-1-260C-UNLIM	-40 to 125	QG
<a href="#">TPS622315DRYR</a>	Active	Production	SON (DRY)   6	5000   LARGE T&R	Yes	NIPDAUAG	Level-1-260C-UNLIM	-40 to 125	RI
TPS622315DRYR.A	Active	Production	SON (DRY)   6	5000   LARGE T&R	Yes	NIPDAUAG	Level-1-260C-UNLIM	-40 to 125	RI
<a href="#">TPS622315DRYT</a>	Active	Production	SON (DRY)   6	250   SMALL T&R	Yes	NIPDAUAG	Level-1-260C-UNLIM	-40 to 125	RI
TPS622315DRYT.A	Active	Production	SON (DRY)   6	250   SMALL T&R	Yes	NIPDAUAG	Level-1-260C-UNLIM	-40 to 125	RI

Orderable part number	Status (1)	Material type (2)	Package   Pins	Package qty   Carrier	RoHS (3)	Lead finish/ Ball material (4)	MSL rating/ Peak reflow (5)	Op temp (°C)	Part marking (6)
<a href="#">TPS622316DRYR</a>	Active	Production	SON (DRY)   6	5000   LARGE T&R	Yes	NIPDAUAG	Level-1-260C-UNLIM	-40 to 125	RJ
TPS622316DRYR.A	Active	Production	SON (DRY)   6	5000   LARGE T&R	Yes	NIPDAUAG	Level-1-260C-UNLIM	-40 to 125	RJ
<a href="#">TPS622316DRYT</a>	Active	Production	SON (DRY)   6	250   SMALL T&R	Yes	NIPDAUAG	Level-1-260C-UNLIM	-40 to 125	RJ
TPS622316DRYT.A	Active	Production	SON (DRY)   6	250   SMALL T&R	Yes	NIPDAUAG	Level-1-260C-UNLIM	-40 to 125	RJ
<a href="#">TPS622317DRYR</a>	Active	Production	SON (DRY)   6	5000   LARGE T&R	Yes	NIPDAUAG	Level-1-260C-UNLIM	-40 to 125	RK
TPS622317DRYR.A	Active	Production	SON (DRY)   6	5000   LARGE T&R	Yes	NIPDAUAG	Level-1-260C-UNLIM	-40 to 125	RK
<a href="#">TPS622317DRYT</a>	Active	Production	SON (DRY)   6	250   SMALL T&R	Yes	NIPDAUAG	Level-1-260C-UNLIM	-40 to 125	RK
TPS622317DRYT.A	Active	Production	SON (DRY)   6	250   SMALL T&R	Yes	NIPDAUAG	Level-1-260C-UNLIM	-40 to 125	RK
<a href="#">TPS622318DRYR</a>	Active	Production	SON (DRY)   6	5000   LARGE T&R	Yes	NIPDAU   NIPDAUAG	Level-1-260C-UNLIM	-40 to 125	ST
TPS622318DRYR.A	Active	Production	SON (DRY)   6	5000   LARGE T&R	Yes	NIPDAU	Level-1-260C-UNLIM	-40 to 125	ST
<a href="#">TPS622318DRYT</a>	Active	Production	SON (DRY)   6	250   SMALL T&R	Yes	NIPDAU   NIPDAUAG	Level-1-260C-UNLIM	-40 to 125	ST
TPS622318DRYT.A	Active	Production	SON (DRY)   6	250   SMALL T&R	Yes	NIPDAU	Level-1-260C-UNLIM	-40 to 125	ST
<a href="#">TPS622319DRYR</a>	Active	Production	SON (DRY)   6	5000   LARGE T&R	Yes	NIPDAUAG	Level-1-260C-UNLIM	-40 to 125	3O
TPS622319DRYR.B	Active	Production	SON (DRY)   6	5000   LARGE T&R	Yes	NIPDAUAG	Level-1-260C-UNLIM	-40 to 125	3O
<a href="#">TPS622319DRYT</a>	Active	Production	SON (DRY)   6	250   SMALL T&R	Yes	NIPDAUAG	Level-1-260C-UNLIM	-40 to 125	3O
TPS622319DRYT.B	Active	Production	SON (DRY)   6	250   SMALL T&R	Yes	NIPDAUAG	Level-1-260C-UNLIM	-40 to 125	3O
<a href="#">TPS62231DRYR</a>	Active	Production	SON (DRY)   6	5000   LARGE T&R	Yes	NIPDAU   NIPDAUAG	Level-1-260C-UNLIM	-40 to 125	GW
TPS62231DRYR.A	Active	Production	SON (DRY)   6	5000   LARGE T&R	Yes	NIPDAUAG	Level-1-260C-UNLIM	-40 to 125	GW
TPS62231DRYRG4.A	Active	Production	SON (DRY)   6	5000   LARGE T&R	Yes	NIPDAU	Level-1-260C-UNLIM	-40 to 125	GW
<a href="#">TPS62231DRYT</a>	Active	Production	SON (DRY)   6	250   SMALL T&R	Yes	NIPDAU   NIPDAUAG	Level-1-260C-UNLIM	-40 to 125	GW
TPS62231DRYT.A	Active	Production	SON (DRY)   6	250   SMALL T&R	Yes	NIPDAUAG	Level-1-260C-UNLIM	-40 to 125	GW
<a href="#">TPS62232DRYR</a>	Active	Production	SON (DRY)   6	5000   LARGE T&R	Yes	NIPDAU	Level-1-260C-UNLIM	-40 to 125	GX
TPS62232DRYR.A	Active	Production	SON (DRY)   6	5000   LARGE T&R	Yes	NIPDAU	Level-1-260C-UNLIM	-40 to 125	GX
TPS62232DRYRG4.A	Active	Production	SON (DRY)   6	5000   LARGE T&R	Yes	NIPDAU	Level-1-260C-UNLIM	-40 to 125	GX
<a href="#">TPS62232DRYT</a>	Active	Production	SON (DRY)   6	250   SMALL T&R	Yes	NIPDAU	Level-1-260C-UNLIM	-40 to 125	GX
TPS62232DRYT.A	Active	Production	SON (DRY)   6	250   SMALL T&R	Yes	NIPDAU	Level-1-260C-UNLIM	-40 to 125	GX
<a href="#">TPS62233DRYR</a>	Active	Production	SON (DRY)   6	5000   LARGE T&R	Yes	NIPDAU   NIPDAUAG	Level-1-260C-UNLIM	-40 to 125	OG
TPS62233DRYR.A	Active	Production	SON (DRY)   6	5000   LARGE T&R	Yes	NIPDAU	Level-1-260C-UNLIM	-40 to 125	OG
<a href="#">TPS62233DRYT</a>	Active	Production	SON (DRY)   6	250   SMALL T&R	Yes	NIPDAU   NIPDAUAG	Level-1-260C-UNLIM	-40 to 125	OG
TPS62233DRYT.A	Active	Production	SON (DRY)   6	250   SMALL T&R	Yes	NIPDAU	Level-1-260C-UNLIM	-40 to 125	OG
<a href="#">TPS62234DRYR</a>	Active	Production	SON (DRY)   6	5000   LARGE T&R	Yes	NIPDAUAG	Level-1-260C-UNLIM	-40 to 125	OH



Orderable part number	Status (1)	Material type (2)	Package   Pins	Package qty   Carrier	RoHS (3)	Lead finish/ Ball material (4)	MSL rating/ Peak reflow (5)	Op temp (°C)	Part marking (6)
TPS62234DRYR.A	Active	Production	SON (DRY)   6	5000   LARGE T&R	Yes	NIPDAUAG	Level-1-260C-UNLIM	-40 to 125	OH
<a href="#">TPS62234DRYT</a>	Active	Production	SON (DRY)   6	250   SMALL T&R	Yes	NIPDAUAG	Level-1-260C-UNLIM	-40 to 125	OH
TPS62234DRYT.A	Active	Production	SON (DRY)   6	250   SMALL T&R	Yes	NIPDAUAG	Level-1-260C-UNLIM	-40 to 125	OH
<a href="#">TPS62235DRYR</a>	Active	Production	SON (DRY)   6	5000   LARGE T&R	Yes	NIPDAUAG	Level-1-260C-UNLIM	-40 to 125	OQ
TPS62235DRYR.A	Active	Production	SON (DRY)   6	5000   LARGE T&R	Yes	NIPDAUAG	Level-1-260C-UNLIM	-40 to 125	OQ
<a href="#">TPS62235DRYT</a>	Active	Production	SON (DRY)   6	250   SMALL T&R	Yes	NIPDAUAG	Level-1-260C-UNLIM	-40 to 125	OQ
TPS62235DRYT.A	Active	Production	SON (DRY)   6	250   SMALL T&R	Yes	NIPDAUAG	Level-1-260C-UNLIM	-40 to 125	OQ
<a href="#">TPS62236DRYR</a>	Active	Production	SON (DRY)   6	5000   LARGE T&R	Yes	NIPDAUAG	Level-1-260C-UNLIM	-40 to 125	OR
TPS62236DRYR.A	Active	Production	SON (DRY)   6	5000   LARGE T&R	Yes	NIPDAUAG	Level-1-260C-UNLIM	-40 to 125	OR
<a href="#">TPS62236DRYT</a>	Active	Production	SON (DRY)   6	250   SMALL T&R	Yes	NIPDAUAG	Level-1-260C-UNLIM	-40 to 125	OR
TPS62236DRYT.A	Active	Production	SON (DRY)   6	250   SMALL T&R	Yes	NIPDAUAG	Level-1-260C-UNLIM	-40 to 125	OR
<a href="#">TPS62237DRYR</a>	Active	Production	SON (DRY)   6	5000   LARGE T&R	Yes	NIPDAU   NIPDAUAG	Level-1-260C-UNLIM	-40 to 125	OS
TPS62237DRYR.A	Active	Production	SON (DRY)   6	5000   LARGE T&R	Yes	NIPDAUAG	Level-1-260C-UNLIM	-40 to 125	OS
TPS62237DRYRG4.A	Active	Production	SON (DRY)   6	5000   LARGE T&R	Yes	NIPDAU	Level-1-260C-UNLIM	-40 to 125	OS
<a href="#">TPS62237DRYT</a>	Active	Production	SON (DRY)   6	250   SMALL T&R	Yes	NIPDAU   NIPDAUAG	Level-1-260C-UNLIM	-40 to 125	OS
TPS62237DRYT.A	Active	Production	SON (DRY)   6	250   SMALL T&R	Yes	NIPDAUAG	Level-1-260C-UNLIM	-40 to 125	OS
<a href="#">TPS62238DRYR</a>	Active	Production	SON (DRY)   6	5000   LARGE T&R	Yes	NIPDAU   NIPDAUAG	Level-1-260C-UNLIM	-40 to 125	ON
TPS62238DRYR.A	Active	Production	SON (DRY)   6	5000   LARGE T&R	Yes	NIPDAU	Level-1-260C-UNLIM	-40 to 125	ON
<a href="#">TPS62238DRYT</a>	Active	Production	SON (DRY)   6	250   SMALL T&R	Yes	NIPDAU   NIPDAUAG	Level-1-260C-UNLIM	-40 to 125	ON
TPS62238DRYT.A	Active	Production	SON (DRY)   6	250   SMALL T&R	Yes	NIPDAU	Level-1-260C-UNLIM	-40 to 125	ON
<a href="#">TPS62239DRYR</a>	Active	Production	SON (DRY)   6	5000   LARGE T&R	Yes	NIPDAUAG	Level-1-260C-UNLIM	-40 to 125	OP
TPS62239DRYR.A	Active	Production	SON (DRY)   6	5000   LARGE T&R	Yes	NIPDAUAG	Level-1-260C-UNLIM	-40 to 125	OP
<a href="#">TPS62239DRYT</a>	Active	Production	SON (DRY)   6	250   SMALL T&R	Yes	NIPDAUAG	Level-1-260C-UNLIM	-40 to 125	OP
TPS62239DRYT.A	Active	Production	SON (DRY)   6	250   SMALL T&R	Yes	NIPDAUAG	Level-1-260C-UNLIM	-40 to 125	OP

<sup>(1)</sup> **Status:** For more details on status, see our [product life cycle](#).

<sup>(2)</sup> **Material type:** When designated, preproduction parts are prototypes/experimental devices, and are not yet approved or released for full production. Testing and final process, including without limitation quality assurance, reliability performance testing, and/or process qualification, may not yet be complete, and this item is subject to further changes or possible discontinuation. If available for ordering, purchases will be subject to an additional waiver at checkout, and are intended for early internal evaluation purposes only. These items are sold without warranties of any kind.

<sup>(3)</sup> **RoHS values:** Yes, No, RoHS Exempt. See the [TI RoHS Statement](#) for additional information and value definition.



(4) **Lead finish/Ball material:** Parts may have multiple material finish options. Finish options are separated by a vertical ruled line. Lead finish/Ball material values may wrap to two lines if the finish value exceeds the maximum column width.

(5) **MSL rating/Peak reflow:** The moisture sensitivity level ratings and peak solder (reflow) temperatures. In the event that a part has multiple moisture sensitivity ratings, only the lowest level per JEDEC standards is shown. Refer to the shipping label for the actual reflow temperature that will be used to mount the part to the printed circuit board.

(6) **Part marking:** There may be an additional marking, which relates to the logo, the lot trace code information, or the environmental category of the part.

Multiple part markings will be inside parentheses. Only one part marking contained in parentheses and separated by a "~" will appear on a part. If a line is indented then it is a continuation of the previous line and the two combined represent the entire part marking for that device.

**Important Information and Disclaimer:** The information provided on this page represents TI's knowledge and belief as of the date that it is provided. TI bases its knowledge and belief on information provided by third parties, and makes no representation or warranty as to the accuracy of such information. Efforts are underway to better integrate information from third parties. TI has taken and continues to take reasonable steps to provide representative and accurate information but may not have conducted destructive testing or chemical analysis on incoming materials and chemicals. TI and TI suppliers consider certain information to be proprietary, and thus CAS numbers and other limited information may not be available for release.

In no event shall TI's liability arising out of such information exceed the total purchase price of the TI part(s) at issue in this document sold by TI to Customer on an annual basis.

**TAPE AND REEL INFORMATION**

**QUADRANT ASSIGNMENTS FOR PIN 1 ORIENTATION IN TAPE**

\*All dimensions are nominal

Device	Package Type	Package Drawing	Pins	SPQ	Reel Diameter (mm)	Reel Width W1 (mm)	A0 (mm)	B0 (mm)	K0 (mm)	P1 (mm)	W (mm)	Pin1 Quadrant
TPS62230DRYR	SON	DRY	6	5000	180.0	8.4	1.25	1.6	0.7	4.0	8.0	Q1
TPS62230DRYT	SON	DRY	6	250	180.0	8.4	1.25	1.6	0.7	4.0	8.0	Q1
TPS622310DRYR	SON	DRY	6	5000	180.0	8.4	1.25	1.6	0.7	4.0	8.0	Q1
TPS622310DRYT	SON	DRY	6	250	180.0	8.4	1.25	1.6	0.7	4.0	8.0	Q1
TPS622311DRYR	SON	DRY	6	5000	180.0	9.5	1.2	1.65	0.7	4.0	8.0	Q1
TPS622311DRYT	SON	DRY	6	250	180.0	9.5	1.2	1.65	0.7	4.0	8.0	Q1
TPS622312DRYR	SON	DRY	6	5000	180.0	8.4	1.25	1.6	0.7	4.0	8.0	Q1
TPS622312DRYT	SON	DRY	6	250	180.0	8.4	1.25	1.6	0.7	4.0	8.0	Q1
TPS622313DRYR	SON	DRY	6	5000	180.0	8.4	1.25	1.6	0.7	4.0	8.0	Q1
TPS622313DRYT	SON	DRY	6	250	180.0	8.4	1.25	1.6	0.7	4.0	8.0	Q1
TPS622314DRYR	SON	DRY	6	5000	180.0	8.4	1.25	1.6	0.7	4.0	8.0	Q1
TPS622314DRYR	SON	DRY	6	5000	180.0	9.5	1.2	1.65	0.7	4.0	8.0	Q1
TPS622314DRYT	SON	DRY	6	250	180.0	9.5	1.2	1.65	0.7	4.0	8.0	Q1
TPS622314DRYT	SON	DRY	6	250	180.0	8.4	1.25	1.6	0.7	4.0	8.0	Q1
TPS622315DRYR	SON	DRY	6	5000	180.0	8.4	1.25	1.6	0.7	4.0	8.0	Q1
TPS622315DRYT	SON	DRY	6	250	180.0	8.4	1.25	1.6	0.7	4.0	8.0	Q1

Device	Package Type	Package Drawing	Pins	SPQ	Reel Diameter (mm)	Reel Width W1 (mm)	A0 (mm)	B0 (mm)	K0 (mm)	P1 (mm)	W (mm)	Pin1 Quadrant
TPS622316DRYR	SON	DRY	6	5000	180.0	8.4	1.25	1.6	0.7	4.0	8.0	Q1
TPS622316DRYT	SON	DRY	6	250	180.0	8.4	1.25	1.6	0.7	4.0	8.0	Q1
TPS622317DRYR	SON	DRY	6	5000	180.0	8.4	1.25	1.6	0.7	4.0	8.0	Q1
TPS622317DRYT	SON	DRY	6	250	180.0	8.4	1.25	1.6	0.7	4.0	8.0	Q1
TPS622318DRYR	SON	DRY	6	5000	180.0	8.4	1.25	1.6	0.7	4.0	8.0	Q1
TPS622318DRYT	SON	DRY	6	250	180.0	8.4	1.25	1.6	0.7	4.0	8.0	Q1
TPS622319DRYR	SON	DRY	6	5000	180.0	8.4	1.25	1.6	0.7	4.0	8.0	Q1
TPS622319DRYT	SON	DRY	6	250	180.0	8.4	1.25	1.6	0.7	4.0	8.0	Q1
TPS62231DRYR	SON	DRY	6	5000	180.0	9.5	1.2	1.65	0.7	4.0	8.0	Q1
TPS62231DRYR	SON	DRY	6	5000	180.0	8.4	1.25	1.6	0.7	4.0	8.0	Q1
TPS62231DRYT	SON	DRY	6	250	180.0	8.4	1.25	1.6	0.7	4.0	8.0	Q1
TPS62231DRYT	SON	DRY	6	250	180.0	9.5	1.2	1.65	0.7	4.0	8.0	Q1
TPS62232DRYR	SON	DRY	6	5000	180.0	9.5	1.2	1.65	0.7	4.0	8.0	Q1
TPS62232DRYT	SON	DRY	6	250	180.0	9.5	1.2	1.65	0.7	4.0	8.0	Q1
TPS62233DRYR	SON	DRY	6	5000	180.0	8.4	1.25	1.6	0.7	4.0	8.0	Q1
TPS62233DRYT	SON	DRY	6	250	180.0	8.4	1.25	1.6	0.7	4.0	8.0	Q1
TPS62234DRYR	SON	DRY	6	5000	180.0	8.4	1.25	1.6	0.7	4.0	8.0	Q1
TPS62234DRYT	SON	DRY	6	250	180.0	8.4	1.25	1.6	0.7	4.0	8.0	Q1
TPS62235DRYR	SON	DRY	6	5000	180.0	8.4	1.25	1.6	0.7	4.0	8.0	Q1
TPS62235DRYT	SON	DRY	6	250	180.0	8.4	1.25	1.6	0.7	4.0	8.0	Q1
TPS62236DRYR	SON	DRY	6	5000	180.0	8.4	1.25	1.6	0.7	4.0	8.0	Q1
TPS62236DRYT	SON	DRY	6	250	180.0	8.4	1.25	1.6	0.7	4.0	8.0	Q1
TPS62237DRYR	SON	DRY	6	5000	180.0	9.5	1.2	1.65	0.7	4.0	8.0	Q1
TPS62237DRYT	SON	DRY	6	250	180.0	8.4	1.25	1.6	0.7	4.0	8.0	Q1
TPS62237DRYT	SON	DRY	6	250	180.0	9.5	1.2	1.65	0.7	4.0	8.0	Q1
TPS62238DRYR	SON	DRY	6	5000	180.0	8.4	1.25	1.6	0.7	4.0	8.0	Q1
TPS62238DRYT	SON	DRY	6	250	180.0	8.4	1.25	1.6	0.7	4.0	8.0	Q1
TPS62239DRYR	SON	DRY	6	5000	180.0	8.4	1.25	1.6	0.7	4.0	8.0	Q1
TPS62239DRYT	SON	DRY	6	250	180.0	8.4	1.25	1.6	0.7	4.0	8.0	Q1

**TAPE AND REEL BOX DIMENSIONS**

\*All dimensions are nominal

Device	Package Type	Package Drawing	Pins	SPQ	Length (mm)	Width (mm)	Height (mm)
TPS62230DRYR	SON	DRY	6	5000	183.0	183.0	20.0
TPS62230DRYT	SON	DRY	6	250	183.0	183.0	20.0
TPS622310DRYR	SON	DRY	6	5000	202.0	201.0	28.0
TPS622310DRYT	SON	DRY	6	250	202.0	201.0	28.0
TPS622311DRYR	SON	DRY	6	5000	189.0	185.0	36.0
TPS622311DRYT	SON	DRY	6	250	189.0	185.0	36.0
TPS622312DRYR	SON	DRY	6	5000	183.0	183.0	20.0
TPS622312DRYT	SON	DRY	6	250	183.0	183.0	20.0
TPS622313DRYR	SON	DRY	6	5000	202.0	201.0	28.0
TPS622313DRYT	SON	DRY	6	250	202.0	201.0	28.0
TPS622314DRYR	SON	DRY	6	5000	202.0	201.0	28.0
TPS622314DRYR	SON	DRY	6	5000	189.0	185.0	36.0
TPS622314DRYT	SON	DRY	6	250	189.0	185.0	36.0
TPS622314DRYT	SON	DRY	6	250	202.0	201.0	28.0
TPS622315DRYR	SON	DRY	6	5000	202.0	201.0	28.0
TPS622315DRYT	SON	DRY	6	250	202.0	201.0	28.0
TPS622316DRYR	SON	DRY	6	5000	202.0	201.0	28.0
TPS622316DRYT	SON	DRY	6	250	202.0	201.0	28.0

Device	Package Type	Package Drawing	Pins	SPQ	Length (mm)	Width (mm)	Height (mm)
TPS622317DRYR	SON	DRY	6	5000	202.0	201.0	28.0
TPS622317DRYT	SON	DRY	6	250	202.0	201.0	28.0
TPS622318DRYR	SON	DRY	6	5000	202.0	201.0	28.0
TPS622318DRYT	SON	DRY	6	250	202.0	201.0	28.0
TPS622319DRYR	SON	DRY	6	5000	183.0	183.0	20.0
TPS622319DRYT	SON	DRY	6	250	183.0	183.0	20.0
TPS62231DRYR	SON	DRY	6	5000	189.0	185.0	36.0
TPS62231DRYR	SON	DRY	6	5000	183.0	183.0	20.0
TPS62231DRYT	SON	DRY	6	250	183.0	183.0	20.0
TPS62231DRYT	SON	DRY	6	250	189.0	185.0	36.0
TPS62232DRYR	SON	DRY	6	5000	189.0	185.0	36.0
TPS62232DRYT	SON	DRY	6	250	189.0	185.0	36.0
TPS62233DRYR	SON	DRY	6	5000	202.0	201.0	28.0
TPS62233DRYT	SON	DRY	6	250	202.0	201.0	28.0
TPS62234DRYR	SON	DRY	6	5000	183.0	183.0	20.0
TPS62234DRYT	SON	DRY	6	250	183.0	183.0	20.0
TPS62235DRYR	SON	DRY	6	5000	183.0	183.0	20.0
TPS62235DRYT	SON	DRY	6	250	183.0	183.0	20.0
TPS62236DRYR	SON	DRY	6	5000	183.0	183.0	20.0
TPS62236DRYT	SON	DRY	6	250	183.0	183.0	20.0
TPS62237DRYR	SON	DRY	6	5000	189.0	185.0	36.0
TPS62237DRYT	SON	DRY	6	250	183.0	183.0	20.0
TPS62237DRYT	SON	DRY	6	250	189.0	185.0	36.0
TPS62238DRYR	SON	DRY	6	5000	202.0	201.0	28.0
TPS62238DRYT	SON	DRY	6	250	202.0	201.0	28.0
TPS62239DRYR	SON	DRY	6	5000	183.0	183.0	20.0
TPS62239DRYT	SON	DRY	6	250	183.0	183.0	20.0

## GENERIC PACKAGE VIEW

**DRY 6**

**USON - 0.6 mm max height**

PLASTIC SMALL OUTLINE - NO LEAD



Images above are just a representation of the package family, actual package may vary.  
Refer to the product data sheet for package details.

4207181/G

DRY0006A



# PACKAGE OUTLINE

USON - 0.6 mm max height

PLASTIC SMALL OUTLINE - NO LEAD



NOTES:

1. All linear dimensions are in millimeters. Any dimensions in parenthesis are for reference only. Dimensioning and tolerancing per ASME Y14.5M.
2. This drawing is subject to change without notice.

# EXAMPLE BOARD LAYOUT

DRY0006A

USON - 0.6 mm max height

PLASTIC SMALL OUTLINE - NO LEAD



LAND PATTERN EXAMPLE  
1:1 RATIO WITH PKG SOLDER PADS  
EXPOSED METAL SHOWN  
SCALE:40X



SOLDER MASK DETAILS

4222894/A 01/2018

NOTES: (continued)

3. For more information, see QFN/SON PCB application report in literature No. SLUA271 ([www.ti.com/lit/sluea271](http://www.ti.com/lit/sluea271)).



# EXAMPLE STENCIL DESIGN

DRY0006A

USON - 0.6 mm max height

PLASTIC SMALL OUTLINE - NO LEAD



SOLDER PASTE EXAMPLE  
BASED ON 0.075 - 0.1 mm THICK STENCIL  
SCALE:40X

4222894/A 01/2018

NOTES: (continued)

4. Laser cutting apertures with trapezoidal walls and rounded corners may offer better paste release. IPC-7525 may have alternate design recommendations.

## 重要なお知らせと免責事項

TI は、技術データと信頼性データ(データシートを含みます)、設計リソース(リファレンス デザインを含みます)、アプリケーションや設計に関する各種アドバイス、Web ツール、安全性情報、その他のリソースを、欠陥が存在する可能性のある「現状のまま」提供しており、商品性および特定目的に対する適合性の黙示保証、第三者の知的財産権の非侵害保証を含むいかなる保証も、明示的または黙示的にかかわらず拒否します。

これらのリソースは、TI 製品を使用する設計の経験を積んだ開発者への提供を意図したものです。(1) お客様のアプリケーションに適した TI 製品の選定、(2) お客様のアプリケーションの設計、検証、試験、(3) お客様のアプリケーションに該当する各種規格や、その他のあらゆる安全性、セキュリティ、規制、または他の要件への確実な適合に関する責任を、お客様のみが単独で負うものとし、

上記の各種リソースは、予告なく変更される可能性があります。これらのリソースは、リソースで説明されている TI 製品を使用するアプリケーションの開発の目的でのみ、TI はその使用をお客様に許諾します。これらのリソースに関して、他の目的で複製することや掲載することは禁止されています。TI や第三者の知的財産権のライセンスが付与されている訳ではありません。お客様は、これらのリソースを自身で使用した結果発生するあらゆる申し立て、損害、費用、損失、責任について、TI およびその代理人を完全に補償するものとし、TI は一切の責任を拒否します。

TI の製品は、[TI の販売条件](#)、[TI の総合的な品質ガイドライン](#)、[ti.com](#) または TI 製品などに関連して提供される他の適用条件に従い提供されます。TI がこれらのリソースを提供することは、適用される TI の保証または他の保証の放棄の拡大や変更を意味するものではありません。TI がカスタム、またはカスタマー仕様として明示的に指定していない限り、TI の製品は標準的なカタログに掲載される汎用機器です。

お客様がいかなる追加条項または代替条項を提案する場合も、TI はそれらに異議を唱え、拒否します。

Copyright © 2025, Texas Instruments Incorporated

最終更新日：2025 年 10 月