

# TPS62816-Q1 2.7V~6V、6A 車載用降圧コンバータ、3mm × 2mm ウェットブル・フランク QFN パッケージ

## 1 特長

- 車載アプリケーション向けに AEC-Q100 認証済み
  - デバイス温度グレード 1:  $-40^{\circ}\text{C} \sim +125^{\circ}\text{C}$ 、 $T_A$
- 機能安全対応
  - 機能安全システムの設計に役立つ資料を利用可能
- 入力電圧範囲: 2.7V~6V
- 静止電流: 26 $\mu\text{A}$  (標準値)
- 出力電圧: 0.6V~5.5V
- 出力電圧精度  $\pm 1\%$  (PWM 動作)
- 調整可能なソフト・スタート
- 強制 PWM または PWM/PFM 動作
- 1.8MHz~4MHz の調整可能なスイッチング周波数
- 高精度の ENABLE 入力
  - ユーザー定義の低電圧誤動作防止機能
  - 正確なシーケンシング
- 100% デューティ・サイクル・モード
- アクティブ出力放電
- 拡散スペクトラム・クロック処理 — オプション
- ウィンドウ・コンパレータを使用したパワー・グッド出力
- ウェットブル・フランク付きパッケージ
- $T_J = -40^{\circ}\text{C} \sim 150^{\circ}\text{C}$

## 2 アプリケーション

- ADAS センサ・フュージョン
- サラウンド・ビュー ECU
- デジタル・コックピット
- 外部アンプ

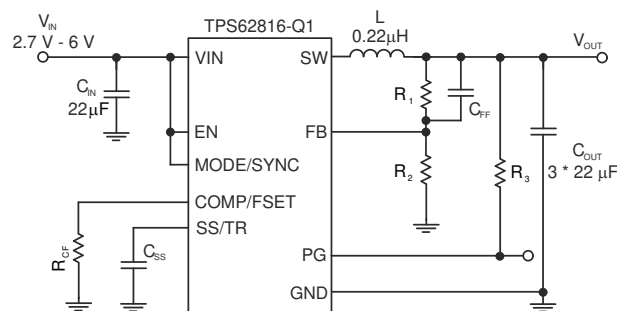

代表的なアプリケーション回路図

## 3 概要

TPS62816-Q1 は、ピン互換の使いやすい高効率同期整流式降圧 DC/DC コンバータです。本デバイスはピーク電流モード制御方式に基づいています。本デバイスは、インフォテインメント、先進運転支援システムなどの車載アプリケーション用に設計されています。低抵抗のスイッチにより、最大 6A の連続出力電流を供給できます。スイッチング周波数は 1.8MHz~4MHz の範囲で外部から変更でき、同じ周波数範囲の外部クロックと同期することもできます。PWM/PFM モードでは、TPS62816-Q1 は負荷が軽いつきに自動的にパワーセーブ・モードへ移行するため、負荷範囲全体にわたって高い効率が維持されます。TPS62816-Q1 は PWM モードで 1% の出力電圧精度を実現するため、出力電圧精度の高い電源の設計に役立ちます。SS/TR ピンを使用して、スタートアップ時間を設定したり、出力電圧が外部ソースに追従するよう設定したりできます。これによって、各種の電源レールの外部シーケンシングが可能で、スタートアップ時の突入電流が制限されます。

TPS62816-Q1 は可変バージョンとして供給され、3mm × 2mm のウェットブル・フランク付き VQFN パッケージに搭載されています。

### 製品情報

部品番号	パッケージ <sup>(1)</sup>	本体サイズ (公称)
TPS62816-Q1	VQFN	3.00mm × 2.00mm

- (1) 利用可能なすべてのパッケージについては、このデータシートの末尾にある注文情報を参照してください。

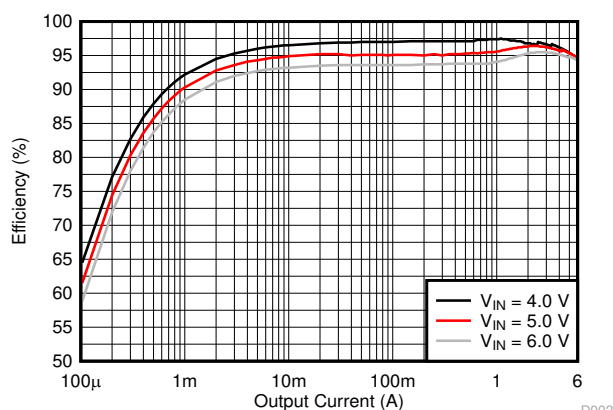

効率と出力電流との関係、  
 $V_{OUT} = 3.3\text{V}$ 、PWM/PFM、 $f_s = 2.25\text{MHz}$

D002



## Table of Contents

<b>1 特長</b> .....	<b>1</b>	<b>10 Application and Implementation</b> .....	<b>14</b>
<b>2 アプリケーション</b> .....	<b>1</b>	10.1 Application Information.....	14
<b>3 概要</b> .....	<b>1</b>	10.2 Typical Application.....	15
<b>4 Revision History</b> .....	<b>2</b>	10.3 System Examples.....	26
<b>5 Device Comparison Table</b> .....	<b>3</b>	<b>11 Power Supply Recommendations</b> .....	<b>29</b>
<b>6 Pin Configuration and Functions</b> .....	<b>3</b>	<b>12 Layout</b> .....	<b>30</b>
<b>7 Specifications</b> .....	<b>4</b>	12.1 Layout Guidelines.....	30
7.1 Absolute Maximum Ratings.....	4	12.2 Layout Example.....	30
7.2 ESD Ratings.....	4	<b>13 Device and Documentation Support</b> .....	<b>31</b>
7.3 Recommended Operating Conditions.....	4	13.1 Device Support.....	31
7.4 Thermal Information.....	5	13.2 Documentation Support.....	31
7.5 Electrical Characteristics.....	5	13.3 Receiving Notification of Documentation Updates..	31
7.6 Typical Characteristics.....	7	13.4 サポート・リソース.....	31
<b>8 Parameter Measurement Information</b> .....	<b>8</b>	13.5 Trademarks.....	31
<b>9 Detailed Description</b> .....	<b>9</b>	13.6 Electrostatic Discharge Caution.....	31
9.1 Overview.....	9	13.7 Glossary.....	31
9.2 Functional Block Diagram.....	9	<b>14 Mechanical, Packaging, and Orderable</b>	
9.3 Feature Description.....	9	<b>Information</b> .....	<b>31</b>
9.4 Device Functional Modes.....	12		

## 4 Revision History

資料番号末尾の英字は改訂を表しています。その改訂履歴は英語版に準じています。

<b>Changes from Revision * (March 2020) to Revision A (December 2021)</b>	<b>Page</b>
• ドキュメントのステータスを事前情報から量産データに変更.....	<b>1</b>

## 5 Device Comparison Table

DEVICE NUMBER	V <sub>OUT</sub> DISCHARGE	FOLDBACK CURRENT LIMIT	SPREAD SPECTRUM CLOCKING (SSC)	OUTPUT VOLTAGE
TPS62816QWRWYRQ1	ON	OFF	by COMP/FSET pin	adjustable

## 6 Pin Configuration and Functions



图 6-1. 9-Pin VQFN RWY Package (Top View)

表 6-1. Pin Functions

PIN		I/O	DESCRIPTION
NAME	NO.		
EN	8	I	This is the enable pin of the device. Connect to logic low to disable the device. Pull high to enable the device. Do not leave this pin unconnected.
FB	5	I	Voltage feedback input. Connect the resistive output voltage divider to this pin.
GND	4		Ground pin
MODE/SYNC	1	I	The device runs in PFM/PWM mode when this pin is pulled low. When the pin is pulled high, the device runs in forced PWM mode. Do not leave this pin unconnected. The mode pin can also be used to synchronize the device to an external frequency. See the <i>Electrical Characteristics</i> for the detailed specification for the digital signal applied to this pin for external synchronization.
COMP/FSET	7	I	Device compensation and frequency set input. A resistor from this pin to GND defines the compensation of the control loop as well as the switching frequency if not externally synchronized.
PG	9	O	Open-drain power-good output
SS/TR	6	I	Soft-start / tracking pin. An external capacitor connected from this pin to GND defines the rise time for the internal reference voltage. The pin can also be used as an input for tracking and sequencing. See <a href="#">セクション 10</a> .
SW	3	O	This is the switch pin of the converter and is connected to the internal power MOSFETs.
VIN	2		Power supply input. Make sure the input capacitor is connected as close as possible between the VIN pin and PGND.

## 7 Specifications

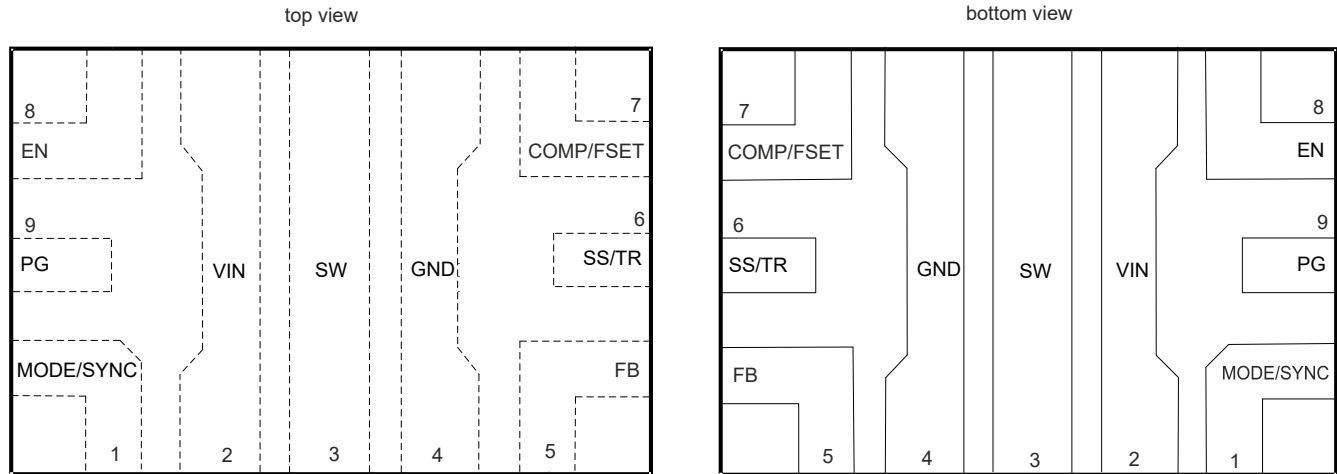
### 7.1 Absolute Maximum Ratings

over operating temperature range (unless otherwise noted)<sup>(1)</sup>

		MIN	MAX	UNIT
Pin voltage <sup>(2)</sup>	V <sub>IN</sub>	-0.3	6.5	V
	SW (DC)	-0.3	V <sub>IN</sub> + 0.3	
	SW (AC, less than 10 ns) <sup>(3)</sup>	-3	10	
	FB	-0.3	4	
	COMP/FSET, PG, SS/TR	-0.3	V <sub>IN</sub> + 0.3	
	EN, MODE/SYNC	-0.3	6.5	
T <sub>stg</sub>	Storage temperature	-65	150	°C

- (1) Stresses beyond those listed under *Absolute Maximum Rating* may cause permanent damage to the device. These are stress ratings only, which do not imply functional operation of the device at these or any other conditions beyond those indicated under *Recommended Operating Conditions*. Exposure to absolute-maximum-rated conditions for extended periods may affect device reliability.
- (2) All voltage values are with respect to the network ground terminal
- (3) While switching

### 7.2 ESD Ratings

			VALUE	UNIT
V <sub>(ESD)</sub>	Electrostatic discharge	Human body model (HBM), per AEC Q100-002 HBM ESD classification level 2 <sup>(1)</sup>	±2000	V
		Charged device model (CDM), per AEC Q100-011 CDM ESD classification level C5	±750	

- (1) AEC Q100-002 indicates that HBM stressing shall be in accordance with the ANSI/ESDA/JEDEC JS-001 specification.

### 7.3 Recommended Operating Conditions

Over operating temperature range (unless otherwise noted)

		MIN	NOM	MAX	UNIT
V <sub>IN</sub>	Input voltage range	2.7		6	V
V <sub>OUT</sub>	Output voltage range	0.6		5.5	V
L	Effective inductance	0.15	0.22	0.3	μH
C <sub>OUT</sub>	Effective output capacitance <sup>(1)</sup>	32	66	470	μF
C <sub>IN</sub>	Effective input capacitance <sup>(1)</sup>	5	10		μF
R <sub>CF</sub>		4.5		100	kΩ
I <sub>SINK_PG</sub>	Sink current at PG pin	0		2	mA
T <sub>J</sub>	Junction temperature	-40		150	°C

- (1) The values given for all the capacitors in the table are effective capacitance, which includes the DC bias effect. Due to the DC bias effect of ceramic capacitors, the effective capacitance is lower than the nominal value when a voltage is applied. Please check the manufacturer's DC bias curves for the effective capacitance versus DC voltage applied. Further restrictions may apply. Please see the feature description for COMP/FSET about the output capacitance versus compensation setting and output voltage.

## 7.4 Thermal Information

THERMAL METRIC <sup>(1)</sup>		TPS62816-Q1	TPS62816-Q1	UNIT
		RWY (JEDEC)	RWY (EVM)	
		9 PINS	9 PINS	
R <sub>θJA</sub>	Junction-to-ambient thermal resistance	71	48	°C/W
R <sub>θJC(top)</sub>	Junction-to-case (top) thermal resistance	37	n/a	°C/W
R <sub>θJB</sub>	Junction-to-board thermal resistance	16.4	n/a	°C/W
Ψ <sub>JT</sub>	Junction-to-top characterization parameter	0.9	n/a	°C/W
Y <sub>JB</sub>	Junction-to-board characterization parameter	16.1	n/a	°C/W
R <sub>θJC(bot)</sub>	Junction-to-case (bottom) thermal resistance	n/a	n/a	°C/W

(1) For more information about traditional and new thermal metrics, see the [Semiconductor and IC Package Thermal Metrics](#) application report.

## 7.5 Electrical Characteristics

Over operating junction temperature range ( $T_J = -40^{\circ}\text{C}$  to  $+150^{\circ}\text{C}$ ) and  $V_{IN} = 2.7\text{ V}$  to  $6\text{ V}$ . Typical values at  $V_{IN} = 5\text{ V}$  and  $T_J = 25^{\circ}\text{C}$ . (unless otherwise noted)

PARAMETER		TEST CONDITIONS	MIN	TYP	MAX	UNIT
<b>SUPPLY</b>						
I <sub>Q</sub>	Quiescent current	EN = V <sub>IN</sub> , no load, device not switching, T <sub>J</sub> = 125°C, MODE = GND			36	μA
I <sub>Q</sub>	Quiescent current	EN = V <sub>IN</sub> , no load, device not switching, MODE = GND, V <sub>OUT</sub> = 0.6 V		26	50	μA
I <sub>SD</sub>	Shutdown current	EN = GND, at T <sub>J</sub> = 125°C			90	μA
I <sub>SD</sub>	Shutdown current	EN = GND, nominal value at T <sub>J</sub> = 25°C, max value at T <sub>J</sub> = 150°C		2.2	230	μA
V <sub>UVLO</sub>	Undervoltage lockout threshold	V <sub>IN</sub> rising	2.45	2.6	2.7	V
		V <sub>IN</sub> falling	2.1	2.5	2.6	V
T <sub>JSD</sub>	Thermal shutdown threshold	T <sub>J</sub> rising		180		°C
	Thermal shutdown hysteresis	T <sub>J</sub> falling		15		°C
<b>CONTROL and INTERFACE</b>						
V <sub>IH,EN</sub>	Input threshold voltage at EN, rising edge		1.05	1.1	1.15	V
V <sub>IL,EN</sub>	Input threshold voltage at EN, falling edge		0.96	1.0	1.05	V
V <sub>IH</sub>	High-level input-threshold voltage at MODE/SYNC		1.1			V
I <sub>IH,EN</sub>	Input leakage current into EN	V <sub>IH</sub> = V <sub>IN</sub> or V <sub>IL</sub> = GND			125	nA
V <sub>IL</sub>	Low-level input-threshold voltage at MODE/SYNC				0.3	V
I <sub>IH</sub>	Input leakage current into MODE/SYNC				250	nA
t <sub>Delay</sub>	Enable delay time	Time from EN high to device starts switching; V <sub>IN</sub> applied already	135	270	520	μs
t <sub>Ramp</sub>	Output voltage ramp time, SS/TR pin open	I <sub>OUT</sub> = 0 mA, time from device starts switching to power good; device not in current limit	90	150	220	μs
I <sub>SS/TR</sub>	SS/TR source current		8	10	12	μA
R <sub>DIS</sub>	Internal discharge resistance on SS/TR when EN = low		0.7	1.1	1.5	kΩ
	Tracking gain	V <sub>FB</sub> / V <sub>SS/TR</sub>		1		
	Tracking offset	V <sub>FB</sub> when V <sub>SS/TR</sub> = 0 V		±1		mV
f <sub>SYNC</sub>	Frequency range on MODE/SYNC pin for synchronization		1.8		4	MHz

**TPS62816-Q1**

JAJSLU4A – MARCH 2020 – REVISED DECEMBER 2021

 Over operating junction temperature range ( $T_J = -40^{\circ}\text{C}$  to  $+150^{\circ}\text{C}$ ) and  $V_{IN} = 2.7\text{ V}$  to  $6\text{ V}$ . Typical values at  $V_{IN} = 5\text{ V}$  and  $T_J = 25^{\circ}\text{C}$ . (unless otherwise noted)

PARAMETER		TEST CONDITIONS	MIN	TYP	MAX	UNIT
	Duty cycle of synchronization signal at MODE/SYNC		20		80	%
	Time to lock to external frequency			50		$\mu\text{s}$
	resistance from COMP/FSET to GND for logic low	Internal frequency setting with $f = 2.25\text{ MHz}$	0		2.5	$\text{k}\Omega$
	Voltage on COMP/FSET for logic high	internal frequency setting with $f = 2.25\text{ MHz}$		$V_{IN}$		V
$V_{TH\_PG}$	UVP power good threshold voltage; dc level	rising ( $\%V_{FB}$ )	92%	95%	98%	
$V_{TH\_PG}$	UVP power good threshold voltage; dc level	falling ( $\%V_{FB}$ )	87%	90%	93%	
$V_{TH\_PG}$	OVP power good threshold voltage; dc level	rising ( $\%V_{FB}$ )	107%	110%	113%	
	OVP power good threshold voltage; dc level	falling ( $\%V_{FB}$ )	104%	107%	111%	
$V_{OL\_PG}$	Low-level output voltage at PG	$I_{SINK\_PG} = 2\text{ mA}$		0.01	0.3	V
$I_{IH\_PG}$	Input leakage current into PG	$V_{PG} = 5\text{ V}$			100	nA
$t_{PG}$	PG deglitch time	For a high level to low level transition on the power good output		40		$\mu\text{s}$
<b>OUTPUT</b>						
$V_{FB}$	Feedback voltage			0.6		V
$I_{IH\_FB}$	Input leakage current into FB	$V_{FB} = 0.6\text{ V}$		1	70	nA
$V_{FB}$	Feedback voltage accuracy	PWM, $V_{IN} \geq V_{OUT} + 1\text{ V}$	-1%		1%	
$V_{FB}$	Feedback voltage accuracy	PFM, $V_{IN} \geq V_{OUT} + 1\text{ V}$ , $V_{OUT} \geq 1.5\text{ V}$ , $C_{o,eff} \geq 47\text{ }\mu\text{F}$	-1%		2%	
$V_{FB}$	Feedback voltage accuracy	PFM, $V_{IN} \geq V_{OUT} + 1\text{ V}$ , $V_{OUT} < 1.5\text{ V}$ , $C_{o,eff} \geq 68\text{ }\mu\text{F}$	-1%		2.5%	
$V_{FB}$	Feedback voltage accuracy with voltage tracking	$V_{IN} \geq V_{OUT} + 1\text{ V}$ , $V_{SS/TR} = 0.3\text{ V}$ , PWM mode	-5%		5%	
	Load regulation	PWM		0.05		%/A
	Line regulation	PWM, $I_{OUT} = 1\text{ A}$ , $V_{IN} \geq V_{OUT} + 1\text{ V}$		0.02		%/V
$R_{DIS}$	Output discharge resistance				50	$\Omega$
$f_{SW}$	PWM switching frequency range	MODE = high, see the FSET pin functionality about setting the switching frequency	1.8	2.25	4	MHz
$f_{SW}$	PWM switching frequency	With COMP/FSET tied to GND or $V_{IN}$	2.08	2.25	2.4	MHz
$f_{SW}$	PWM switching frequency tolerance	using a resistor from COMP/FSET to GND	-12%		12%	
$t_{on,min}$	Minimum on time of high-side FET	$V_{IN} \geq 3.3\text{ V}$ , $T_J = -40^{\circ}\text{C}$ to $125^{\circ}\text{C}$		45	67	ns
$t_{on,min}$	Minimum on time of low-side FET			15		ns
$R_{DS(ON)}$	High-side FET on-resistance	$V_{IN} \geq 5\text{ V}$		11	26	$\text{m}\Omega$
	Low-side FET on-resistance	$V_{IN} \geq 5\text{ V}$		9	19	$\text{m}\Omega$
$I_{IH}$	High-side MOSFET leakage current			0.01	230	$\mu\text{A}$
$I_{IH}$	Low-side MOSFET leakage current	$V(SW) = 6\text{ V}$		0.01	290	$\mu\text{A}$
$I_{IH}$	SW leakage	$V(SW) = 0.6\text{ V}$ , current into SW pin	-0.05		30	$\mu\text{A}$
$I_{LIMH}$	High-side FET switch current limit	DC value, $V_{IN} = 3\text{ V}$ to $6\text{ V}$	7.3	9.2	10.4	A
$I_{LIMNEG}$	Low-side FET negative current limit	DC value		-3		A

## 7.6 Typical Characteristics

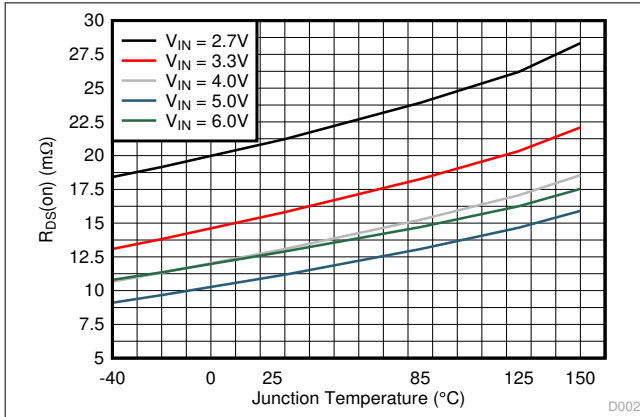

7-1.  $R_{DS(ON)}$  of High-Side Switch

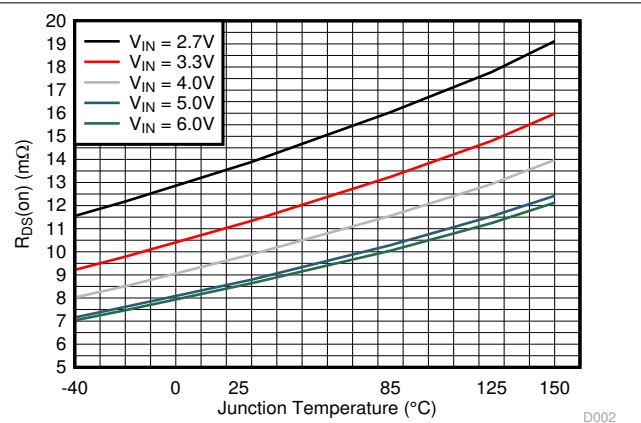

7-2.  $R_{DS(ON)}$  of Low-Side Switch

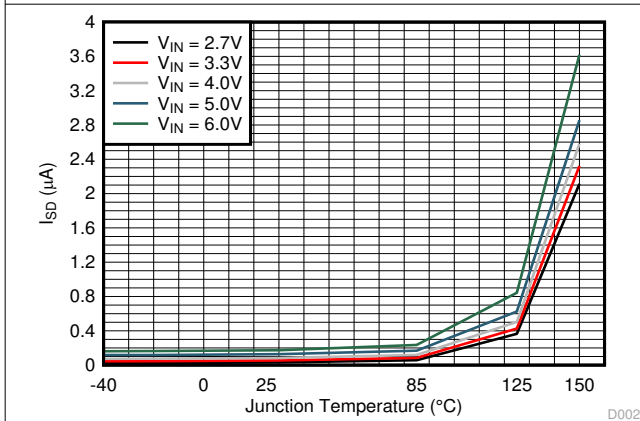

7-3. Shutdown Current vs Temperature

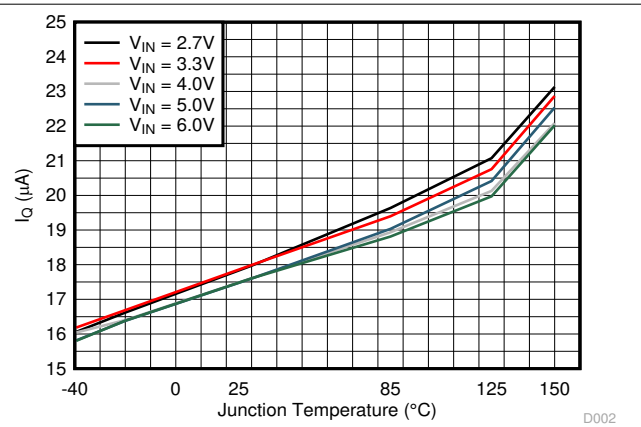

7-4. Quiescent Current vs Temperature

## 8 Parameter Measurement Information

The graphs in this data sheet have been taken based on the schematic and BOM as listed in 表 8-1 if not otherwise mentioned in the plots.



图 8-1. Measurement Setup for TPS62816-Q1

表 8-1. List of Components

REFERENCE	DESCRIPTION	MANUFACTURER <sup>(1)</sup>
IC	TPS62816-Q1	Texas Instruments
L	0.25-µH inductor; XGL4020-251ME	Coilcraft
C <sub>IN</sub>	22 µF / 10 V; GCM31CR71A226KE02L	Murata
C <sub>OUT</sub> for V <sub>OUT</sub> = 0.6 V	5 × 22 µF / 10 V; GCM31CR71A226KE02L	Murata
C <sub>OUT</sub> for V <sub>OUT</sub> ≥ 1 V	3 × 22 µF / 10 V; GCM31CR71A226KE02L	Murata
C <sub>SS</sub>	15 nF (equal to 0.9-ms start-up ramp)	any
R <sub>CF</sub>	8.06 kΩ	any
C <sub>FF</sub>	10 pF	any
R <sub>1</sub>	Depending on V <sub>OUT</sub>	any
R <sub>2</sub>	Depending on V <sub>OUT</sub>	any
R <sub>3</sub>	100 kΩ	any

(1) See the [Third Party-Products Disclaimer](#).

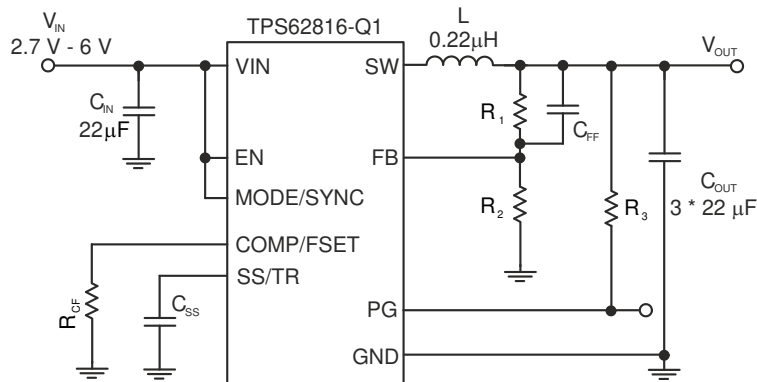

## 9 Detailed Description

### 9.1 Overview

The TPS62816-Q1 synchronous switch mode power converter is based on a peak current mode control topology. The control loop is internally compensated.

To optimize the bandwidth of the control loop to the wide range of output capacitance that can be used with the TPS62816-Q1, the internal compensation has two settings. See [セクション 9.3.2](#). One out of the two compensation settings is chosen either by a resistor from COMP/FSET to GND, or by the logic state of this pin. The regulation network achieves fast and stable operation with small external components and low-ESR ceramic output capacitors. The device requires a small feedforward capacitor on the output voltage divider for best transient response. See [表 10-2](#).

The device supports forced fixed frequency PWM operation with the MODE pin tied to a logic high level. The frequency is defined as either 2.25 MHz internally fixed when COMP/FSET is tied to GND or VIN, or in a range of 1.8 MHz to 4 MHz defined by a resistor from COMP/FSET to GND. Alternatively, the devices can be synchronized to an external clock signal in a range from 1.8 MHz to 4 MHz, applied to the MODE pin with no need for additional passive components. An internal PLL allows the device to change from internal clock to external clock during operation. The synchronization to the external clock is done on a falling edge of the clock applied at MODE to the rising edge on the SW pin. This allows a roughly 180° phase shift when the SW pin is used to generate the synchronization signal for a second converter. When the MODE pin is set to a logic low level, the device operates in power save mode (PFM) at low output current and automatically transfers to fixed-frequency PWM mode at higher output current. In PFM mode, the switching frequency decreases linearly based on the load to sustain high efficiency down to very low output current.

### 9.2 Functional Block Diagram

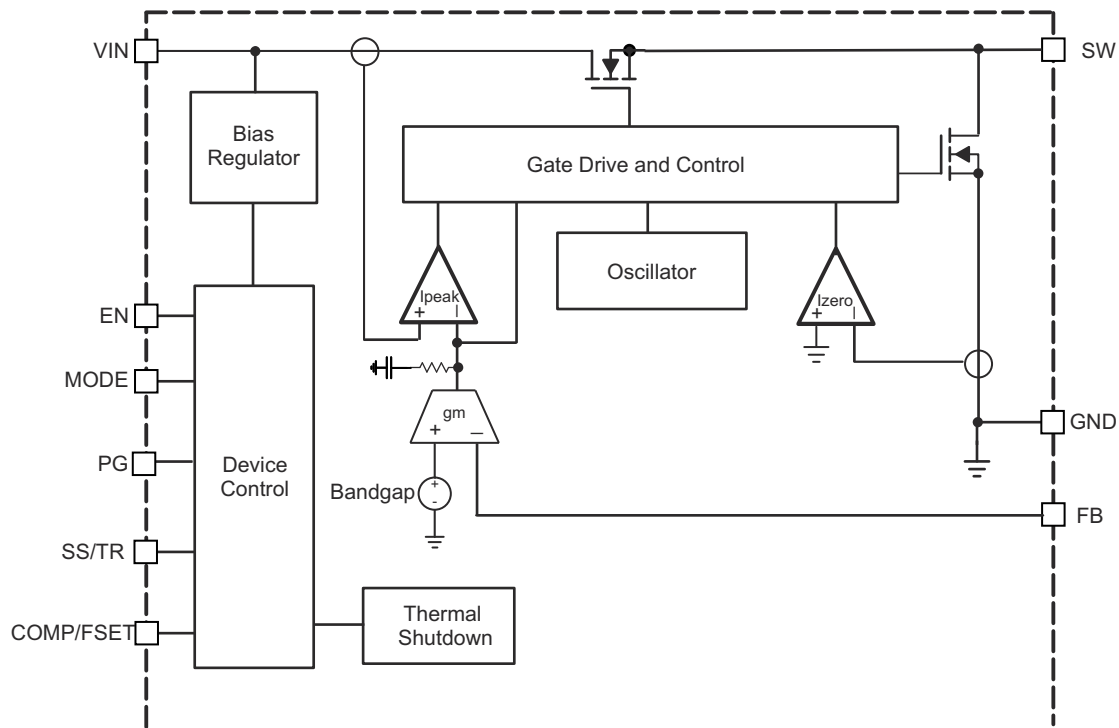

### 9.3 Feature Description

#### 9.3.1 Precise Enable

The voltage applied at the Enable (EN) pin of the TPS62816-Q1 is compared to a fixed threshold of 1.1 V for a rising voltage. This allows the user to drive the pin by a slowly changing voltage and enables the use of an external RC network to achieve a power-up delay.

The precise enable input provides a user-programmable undervoltage lockout by adding a resistor divider to the input of the EN pin.

The enable input threshold for a falling edge is typically 100 mV lower than the rising edge threshold. The TPS62816-Q1 starts operation when the rising threshold is exceeded. For proper operation, the EN pin must be terminated and must not be left floating. Pulling the EN pin low forces the device into shutdown, with a shutdown current of typically 1  $\mu$ A. In this mode, the internal high-side and low-side MOSFETs are turned off and the entire internal control circuitry is switched off.

### 9.3.2 COMP/FSET

This pin allows the user to set two different parameters independently:

- Internal compensation settings for the control loop (three settings available)
- The switching frequency in PWM mode from 1.8 MHz to 4 MHz
- Enable/ disable spread spectrum clocking (SSC)

A resistor from COMP/FSET to GND changes the compensation as well as the switching frequency. The change in compensation allows the user to adopt the device to different values of output capacitance. The resistor must be placed close to the pin to keep the parasitic capacitance on the pin to a minimum. The compensation setting is sampled at the start-up of the converter, so a change in the resistor during operation only has an effect on the switching frequency, but not on the compensation.

To save external components, the pin can also be directly tied to VIN or GND to set a pre-defined switching frequency or compensation. Do not leave the pin floating.

The switching frequency has to be selected based on the input voltage and the output voltage to meet the specifications for the minimum on time and minimum off time.

Example:  $V_{IN} = 5\text{ V}$ ,  $V_{OUT} = 1\text{ V}$  --> duty cycle (DC) =  $1\text{ V} / 5\text{ V} = 0.2$

- with  $t_{on} = DC \times T$  -->  $t_{on,min} = 1/f_{s,max} \times DC$
- -->  $f_{s,max} = 1/t_{on,min} \times DC = 1/0.075\ \mu\text{s} \times 0.2 = 2.6\text{ MHz}$

The compensation range has to be chosen based on the minimum capacitance used. The capacitance can be increased from the minimum value as given in 表 9-1, up to the maximum of 470  $\mu$ F in all of the three compensation ranges. If the capacitance of an output changes during operation, for example, when load switches are used to connect or disconnect parts of the circuitry, the compensation has to be chosen for the minimum capacitance on the output. With large output capacitance, the compensation must be done based on that large capacitance to get the best load transient response. Compensating for large output capacitance but placing less capacitance on the output can lead to instability.

The switching frequency for the different compensation setting is determined by the following equations.

For compensation (comp) setting 1 with spread spectrum clocking (SSC) disabled:

$$R_{CF}(k\Omega) = \frac{18\text{MHz} \cdot k\Omega}{f_s(\text{MHz})} \quad (1)$$

For compensation (comp) setting 1 with spread spectrum clocking (SSC) enabled:

$$R_{CF}(k\Omega) = \frac{60\text{MHz} \cdot k\Omega}{f_s(\text{MHz})} \quad (2)$$

For compensation (comp) setting 2 with spread spectrum clocking (SSC) disabled:

$$R_{CF}(k\Omega) = \frac{180MHz \cdot k\Omega}{f_s(MHz)} \quad (3)$$

**表 9-1. Switching Frequency and Compensation**

COMPENSATION	R <sub>CF</sub>	SWITCHING FREQUENCY	MINIMUM OUTPUT CAPACITANCE
for smallest output capacitance (comp setting 1) SSC disabled	10 kΩ ... 4.5 kΩ	1.8 MHz (10 kΩ) ... 4 MHz (4.5 kΩ) according to 式 1	32 μF × V / V <sub>OUT</sub> [V]
for smallest output capacitance (comp setting 1) SSC enabled	33 kΩ ... 15 kΩ	1.8 MHz (33 kΩ) ... 4 MHz (15 kΩ) according to 式 2	32 μF × V / V <sub>OUT</sub> [V]
for best transient response (larger output capacitance) (comp setting 2) SSC disabled	100 kΩ ... 45 kΩ	1.8 MHz (100 kΩ) ... 4 MHz (45 kΩ) according to 式 3	72 μF × V / V <sub>OUT</sub> [V]
for smallest output capacitance (comp setting 1) SSC disabled	tied to GND	internally fixed 2.25 MHz	32 μF × V / V <sub>OUT</sub> [V]
for best transient response (larger output capacitance) (comp setting 2) SSC enabled	tied to V <sub>IN</sub>	internally fixed 2.25 MHz	72 μF × V / V <sub>OUT</sub> [V]

The minimum output capacitance required for stability depends on the output voltage as stated in 表 9-1. Refer to セクション 10.1.2.2 for further details on the output capacitance required depending on the output voltage.

A too-high resistor value for R<sub>CF</sub> is decoded as "tied to V<sub>IN</sub>" and a value below the lowest range is decoded as "tied to GND". The minimum output capacitance in 表 9-1 is for capacitors close to the output of the device. If the capacitance is distributed, a lower compensation setting can be required.

### 9.3.3 MODE/SYNC

When MODE/SYNC is set low, the device operates in PWM or PFM mode depending on the output current. The MODE/SYNC pin forces PWM mode when set high. The pin also allows the user to apply an external clock in a frequency range from 1.8 MHz to 4 MHz for external synchronization. Similar to COMP/FSET, the specifications for the minimum on time and minimum off time have to be observed when setting the external frequency. For use with external synchronization on the MODE/SYNC pin, the internal switching frequency must be set by R<sub>CF</sub> to a similar value than the externally applied clock. This ensures that if the external clock fails, the switching frequency stays in the same range. When there is no resistor from COMP/FSET to GND but the pin is pulled high or low, external synchronization is not possible.

### 9.3.4 Spread Spectrum Clocking (SSC)

The device offers spread spectrum clocking as an option, set by the COMP/FSET pin. When SSC is enabled, the switching frequency is randomly changed in PWM mode when the internal clock is used. The frequency variation is typically between the nominal switching frequency and up to 288 kHz above the nominal switching frequency. When the device is externally synchronized by applying a clock signal to the MODE/SYNC pin, the TPS62816-Q1 follows the external clock and the internal spread spectrum block is turned off. SSC is also disabled during soft start.

### 9.3.5 Undervoltage Lockout (UVLO)

If the input voltage drops, the undervoltage lockout prevents mis-operation of the device by switching off both of the power FETs. When enabled, the device is fully operational for input voltages above the rising UVLO threshold and turns off if the input voltage trips below the threshold for a falling supply voltage.

### 9.3.6 Power Good Output (PG)

Power good is an open-drain output driven by a window comparator. PG is held low when the device is disabled, in undervoltage lockout, and thermal shutdown. When the output voltage is in regulation hence, within the window defined in the electrical characteristics, the output is high impedance.

表 9-2. PG Status

EN	DEVICE STATUS	PG STATE
X	$V_{IN} < 2\text{ V}$	undefined
low	$V_{IN} \geq 2\text{ V}$	low
high	$2\text{ V} \leq V_{IN} \leq \text{UVLO}$ OR in thermal shutdown OR $V_{OUT}$ not in regulation	low
high	$V_{OUT}$ in regulation	high impedance

### 9.3.7 Thermal Shutdown

The junction temperature ( $T_J$ ) of the device is monitored by an internal temperature sensor. If  $T_J$  exceeds 170°C (typical), the device goes into thermal shutdown. Both the high-side and low-side power FETs are turned off and PG goes low. When  $T_J$  decreases below the hysteresis amount of typically 15°C, the converter resumes normal operation, beginning with soft start. During a PFM pause, the thermal shutdown is not active. After a PFM pause, the device needs up to 9  $\mu\text{s}$  to detect a too-high junction temperature. If the PFM burst is shorter than this delay, the device does not detect a too-high junction temperature.

## 9.4 Device Functional Modes

### 9.4.1 Pulse Width Modulation (PWM) Operation

The TPS62816-Q1 has two operating modes: Forced PWM mode as discussed in this section and PWM/PFM as discussed in [セクション 9.4.2](#).

With the MODE/SYNC pin set to high, the TPS62816-Q1 operates with pulse width modulation in continuous conduction mode (CCM). The switching frequency is either defined by a resistor from the COMP pin to GND or by an external clock signal applied to the MODE/SYNC pin. With an external clock applied to MODE/SYNC, the TPS62816-Q1 follows the frequency applied to the pin. In general, the frequency range in forced PWM mode is 1.8 MHz to 4 MHz. However, the frequency needs to be in a range the TPS62816-Q1 can operate at, taking the minimum on time into account.

### 9.4.2 Power Save Mode Operation (PWM/PFM)

When the MODE/SYNC pin is low, power save mode is allowed. The device operates in PWM mode as long as the peak inductor current is above the PFM threshold of approximately 1.8 A. When the peak inductor current drops below the PFM threshold, the device starts to skip switching pulses. In power save mode, the switching frequency decreases with the load current maintaining high efficiency. In addition, the frequency set with the resistor on COMP/FSET must be in a range of 1.8 MHz to 3.5 MHz. The high-side switch in a PFM pulse is turned on until the inductor current reaches its peak current limit.

### 9.4.3 100% Duty-Cycle Operation

The duty cycle of a buck converter operated in PWM mode is given as  $D = V_{OUT} / V_{IN}$ . The duty cycle increases as the input voltage comes close to the output voltage and the off time gets smaller. When the minimum off time of typically 10 ns is reached, the TPS62816-Q1 skips switching cycles while it approaches 100% mode. In 100% mode, it keeps the high-side switch on continuously. The high-side switch stays turned on as long as the output voltage is below the target. In 100% mode, the low-side switch is turned off. The maximum dropout voltage in 100% mode is the product of the on-resistance of the high-side switch plus the series resistance of the inductor and the load current.

### 9.4.4 Current Limit and Short Circuit Protection

The TPS62816-Q1 is protected against overload and short circuit events. If the inductor current exceeds the current limit  $I_{LIMH}$ , the high-side switch is turned off and the low-side switch is turned on to ramp down the inductor current. The high-side switch turns on again only if the current in the low-side switch has decreased below the low-side current limit. Due to internal propagation delay, the actual current can exceed the static current limit. The dynamic current limit is given as:

$$I_{peak(typ)} = I_{LIMH} + \frac{V_L}{L} \cdot t_{PD} \quad (4)$$

where:

- $I_{LIMH}$  is the static current limit as specified in the electrical characteristics
- $L$  is the effective inductance at the peak current
- $V_L$  is the voltage across the inductor ( $V_{IN} - V_{OUT}$ )
- $t_{PD}$  is the internal propagation delay of typically 50 ns

The current limit can exceed static values, especially if the input voltage is high and very small inductances are used. The dynamic high-side switch peak current can be calculated as follows:

$$I_{peak(typ)} = I_{LIMH} + \frac{V_{IN} - V_{OUT}}{L} \cdot 50ns \quad (5)$$

#### 9.4.5 Foldback Current Limit and Short Circuit Protection

This is valid for devices where foldback current limit is enabled.

When the device detects current limit for more than 1024 subsequent switching cycles, it reduces the current limit from its nominal value to a typical peak current of 3.7 A. Foldback current limit is left when the current limit indication goes away. For the case that device operation continues in current limit, it would, after 3072 switching cycles, try again full current limit for again 1024 switching cycles.

#### 9.4.6 Output Discharge

The purpose of the discharge function is to ensure a defined down-ramp of the output voltage when the device is being disabled, but also to keep the output voltage close to 0 V when the device is off. The output discharge feature is only active once the TPS62816-Q1 has been enabled at least once since the supply voltage was applied. The discharge function is enabled as soon as the device is disabled, in thermal shutdown, or in undervoltage lockout. The minimum supply voltage required for the discharge function to remain active typically is 2 V. Output discharge is not activated during a current limit or foldback current limit event.

#### 9.4.7 Soft Start/Tracking (SS/TR)

The internal soft-start circuitry controls the output voltage slope during start-up. This avoids excessive inrush current and ensures a controlled output voltage rise time. It also prevents unwanted voltage drops from high impedance power sources or batteries. When EN is set high to start operation, the device starts switching after a delay of about 200  $\mu$ s, then the internal reference and hence  $V_{OUT}$  rises with a slope controlled by an external capacitor connected to the SS/TR pin.

Leaving the SS/TR pin disconnected provides the fastest start-up ramp with 150  $\mu$ s typically. A capacitor connected from SS/TR to GND is charged with 10  $\mu$ A by an internal current source during soft start until it reaches the reference voltage of 0.6 V. The capacitance required to set a certain ramp-time ( $t_{ramp}$ ), therefore, is:

$$C_{ss}[nF] = 10\mu A * t_{ramp}[ms] / 0.6V \quad (6)$$

If the device is set to shutdown (EN = GND), undervoltage lockout, or thermal shutdown, an internal resistor pulls the SS/TR pin to GND to ensure a proper low level. Returning from those states causes a new startup sequence.

A voltage applied at SS/TR can be used to track a master voltage. The output voltage follows this voltage in both directions up and down in forced PWM mode. In PFM mode, the output voltage decreases based on the load current. The SS/TR pin must not be connected to the SS/TR pin of other devices. An external voltage applied on SS/TR is internally clamped to the feedback voltage (0.6 V). It is recommended to set the target for the external voltage on SS/TR slightly above the feedback voltage. Given the tolerances of the resistor divider  $R_5$  and  $R_6$  on SS/TR, this makes sure the device "switches" to the internal reference voltage when the power-up sequencing is finished. See [10-57](#).

## 10 Application and Implementation

### Note

以下のアプリケーション情報は、TI の製品仕様に含まれるものではなく、TI ではその正確性または完全性を保証いたしません。個々の目的に対する製品の適合性については、お客様の責任で判断していただくこととなります。お客様は自身の設計実装を検証しテストすることで、システムの機能を確認する必要があります。

### 10.1 Application Information

#### 10.1.1 Programming the Output Voltage

The output voltage of the TPS62816-Q1 is adjustable. It can be programmed for output voltages from 0.6 V to 5.5 V using a resistor divider from VOUT to GND. The voltage at the FB pin is regulated to 600 mV. The value of the output voltage is set by the selection of the resistor divider from 式 7. It is recommended to choose resistor values that allow a current of at least 2 μA, meaning the value of R<sub>2</sub> must not exceed 400 kΩ. Lower resistor values are recommended for the highest accuracy and most robust design.

$$R_1 = R_2 \cdot \left( \frac{V_{OUT}}{V_{FB}} - 1 \right) \quad (7)$$

#### 10.1.2 External Component Selection

##### 10.1.2.1 Inductor Selection

The TPS62816-Q1 is designed for a nominal 0.22-μH inductor with a switching frequency of typically 2.25 MHz. Larger values can be used to achieve a lower inductor current ripple, but they can have a negative impact on efficiency and transient response. Smaller values than 0.22 μH cause a larger inductor current ripple, which causes larger negative inductor current in forced PWM mode at low or no output current. For a higher or lower nominal switching frequency, the inductance must be changed accordingly. See the *Recommended Operating Conditions* for details.

The inductor selection is affected by several effects like the following:

- Inductor ripple current
- Output ripple voltage
- PWM-to-PFM transition point
- Efficiency

In addition, the inductor selected has to be rated for appropriate saturation current and DC resistance (DCR). 式 8 calculates the maximum inductor current.

$$I_{L(max)} = I_{OUT(max)} + \frac{\Delta I_{L(max)}}{2} \quad (8)$$

$$\Delta I_{L(max)} = \frac{V_{OUT} \cdot \left( 1 - \frac{V_{OUT}}{V_{IN}} \right)}{L \min} \cdot \frac{1}{f_{SW}} \quad (9)$$

where:

- I<sub>L(max)</sub> is the maximum inductor current.
- ΔI<sub>L(max)</sub> is the peak-to-peak inductor ripple current.
- L<sub>min</sub> is the minimum inductance at the operating point.

表 10-1. Typical Inductors

TYPE	INDUCTANCE [μH]	CURRENT [A] <sup>(1)</sup>	NOMINAL SWITCHING FREQUENCY	DIMENSIONS [L × W × H] mm	MANUFACTURER <sup>(2)</sup>
XEL4020-201ME	0.20 μH, ±20%	14	2.25 MHz	4 × 4 × 2.1	Coilcraft

**表 10-1. Typical Inductors (continued)**

TYPE	INDUCTANCE [μH]	CURRENT [A] <sup>(1)</sup>	NOMINAL SWITCHING FREQUENCY	DIMENSIONS [L × W × H] mm	MANUFACTURER <sup>(2)</sup>
XGL4020-251ME	0.25 μH, ±20%	12	2.25 MHz	4 × 4 × 2.1	Coilcraft
XEL4030-201ME	0.20 μH, ±20%	17	2.25 MHz	4 × 4 × 3.2	Coilcraft

(1) Lower of  $I_{RMS}$  at 20°C rise or  $I_{SAT}$  at 20% drop.

(2) See the [Third Party-Products Disclaimer](#).

Calculating the maximum inductor current using the actual operating conditions gives the minimum saturation current of the inductor needed. A margin of about 20% is recommended to add. A larger inductor value is also useful to get lower ripple current, but increases the transient response time and size as well.

### 10.1.2.2 Capacitor Selection

#### 10.1.2.2.1 Input Capacitor

For most applications, 22 μF nominal is sufficient and is recommended. The input capacitor buffers the input voltage for transient events and also decouples the converter from the supply. A low-ESR multilayer ceramic capacitor (MLCC) is recommended for the best filtering and must be placed between VIN and GND as close as possible to those pins.

#### 10.1.2.2.2 Output Capacitor

The architecture of the TPS62816-Q1 allows the use of tiny ceramic output capacitors with low equivalent series resistance (ESR). These capacitors provide low output voltage ripple and are recommended. To keep its low resistance up to high frequencies and to get narrow capacitance variation with temperature, it is recommended to use dielectric X7R, X7T, or equivalent. Using a higher value has advantages, like smaller voltage ripple and a tighter DC output accuracy in Power Save mode. The COMP/FSET pin allows the user to select two different compensation settings based on the minimum capacitance used on the output. The maximum capacitance is 470 μF in any of the compensation settings.

The minimum capacitance required on the output depends on the compensation setting and output voltage.

For output voltages below 1 V, the minimum increases linearly from 32 μF at 1 V to 53 μF at 0.6 V with the compensation setting for smallest output capacitance. Other compensation ranges are equivalent. See [表 9-1](#) for details.

## 10.2 Typical Application

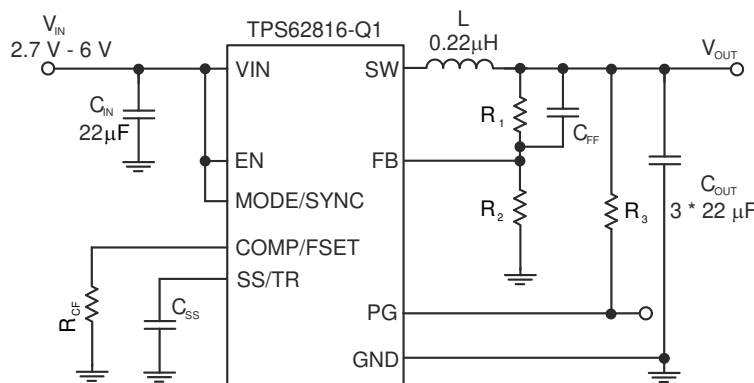

**图 10-1. Typical Application**

### 10.2.1 Design Requirements

The design guidelines provide a component selection to operate the device within the recommended operating conditions.

## 10.2.2 Detailed Design Procedure

$$R_1 = R_2 \cdot \left( \frac{V_{OUT}}{V_{FB}} - 1 \right) \quad (10)$$

With  $V_{FB} = 0.6 \text{ V}$ :

**表 10-2. Setting the Output Voltage**

NOMINAL OUTPUT VOLTAGE $V_{OUT}$	$R_1$	$R_2$	$C_{FF}$	EXACT OUTPUT VOLTAGE
0.8 V	16.9 k $\Omega$	51 k $\Omega$	15 pF	0.7988 V
1.0 V	20 k $\Omega$	30 k $\Omega$	13 pF	1.0 V
1.1 V	39.2 k $\Omega$	47 k $\Omega$	6.8 pF	1.101 V
1.2 V	68 k $\Omega$	68 k $\Omega$	3.9 pF	1.2 V
1.5 V	76.8 k $\Omega$	51 k $\Omega$	3.3 pF	1.5 V
1.8 V	80.6 k $\Omega$	40.2 k $\Omega$	3.3 pF	1.803 V
2.5 V	47.5 k $\Omega$	15 k $\Omega$	5.6 pF	2.5 V
3.3 V	88.7 k $\Omega$	19.6 k $\Omega$	3 pF	3.315 V

The maximum value for the feedforward capacitor  $C_{FF}$  at minimum output capacitance is determined by 式 11:

$$C_{FF,max}(F) = 2.661 \times 10^{-7} F \times \Omega / R_1 (\Omega) \quad (11)$$



### 10.2.3 Application Curves

All plots have been taken with a nominal switching frequency of 2.25 MHz when set to PWM mode, unless otherwise noted. The BOM is according to 表 8-1.

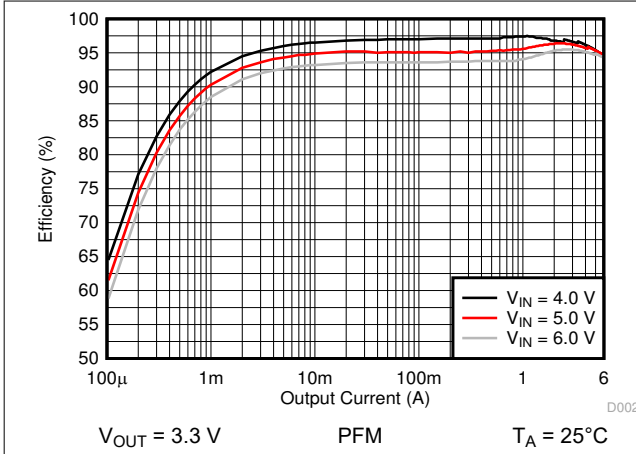

**10-2. Efficiency Versus Output Current**

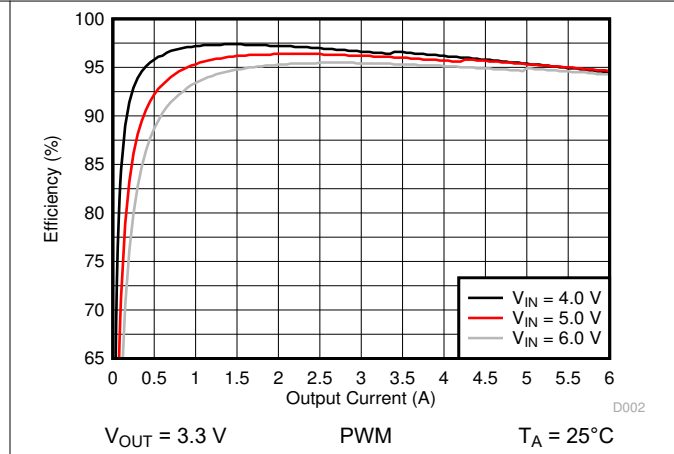

**10-3. Efficiency Versus Output Current**

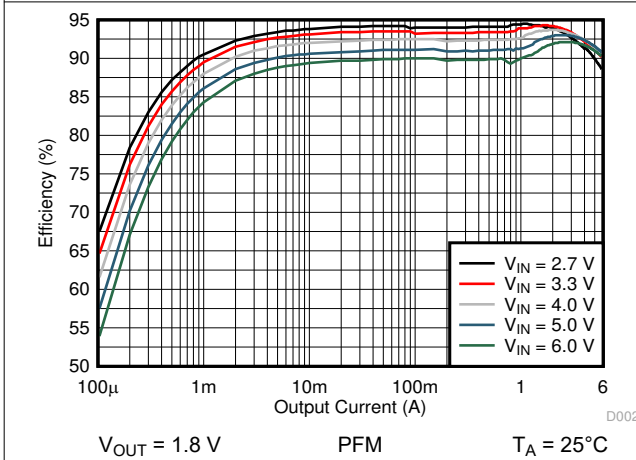

**10-4. Efficiency Versus Output Current**

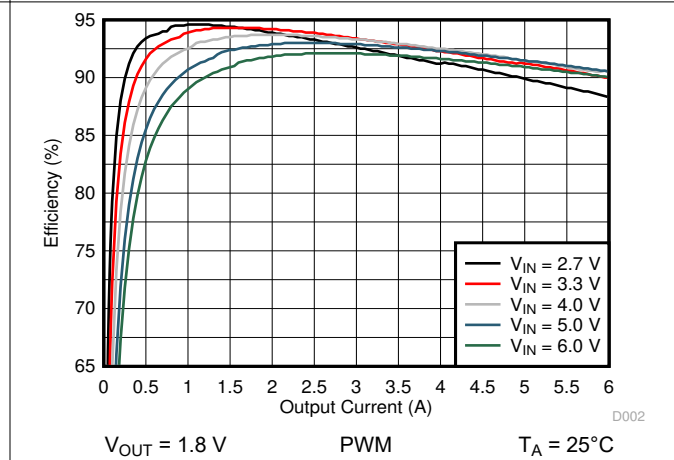

**10-5. Efficiency Versus Output Current**

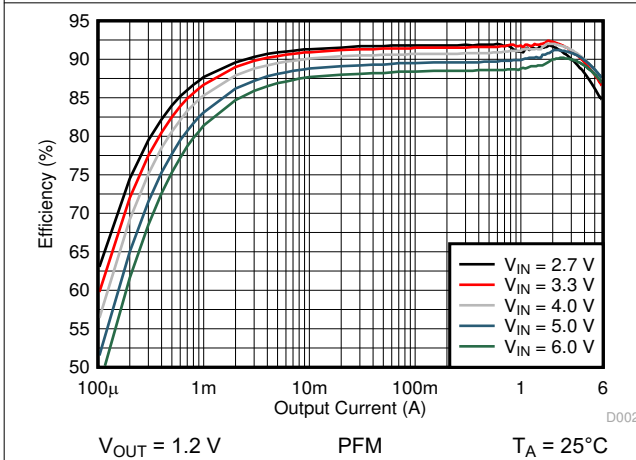

**10-6. Efficiency Versus Output Current**

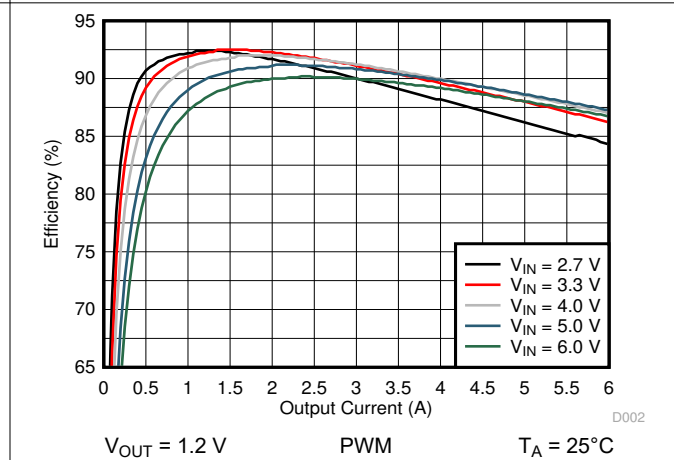

**10-7. Efficiency Versus Output Current**

**10.2.3 Application Curves (continued)**

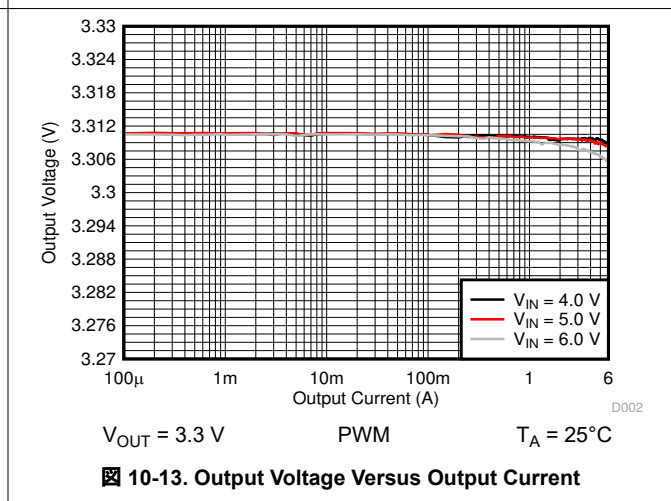
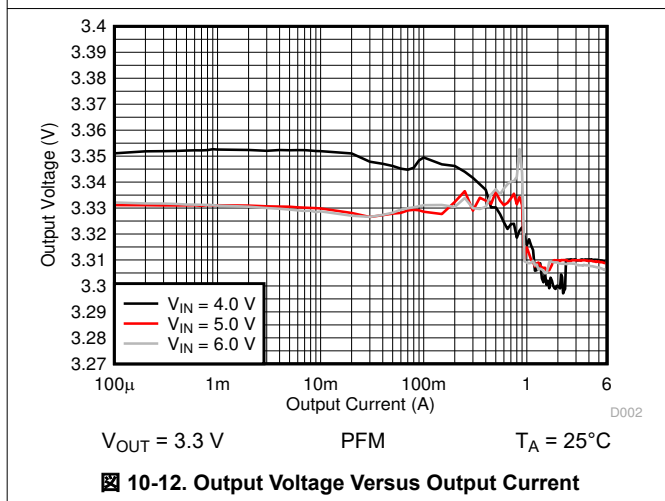
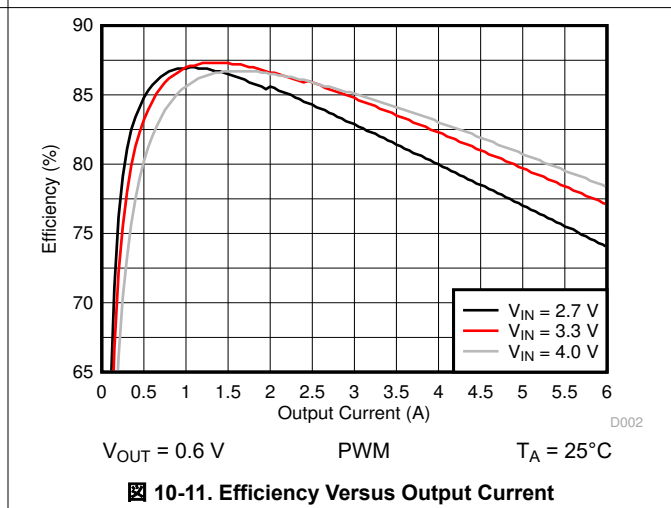
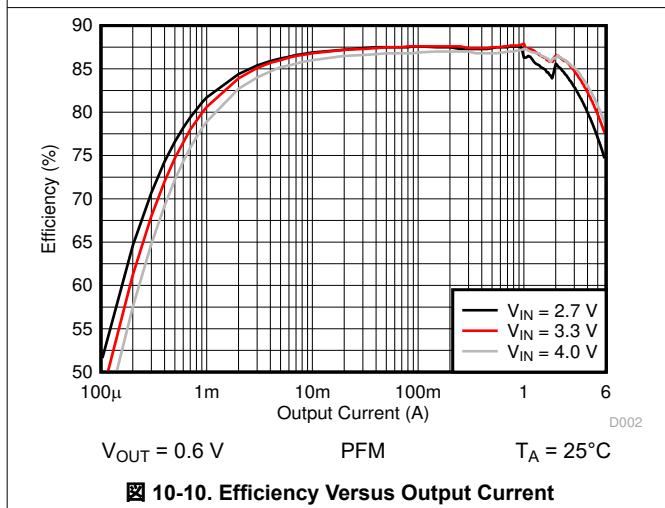
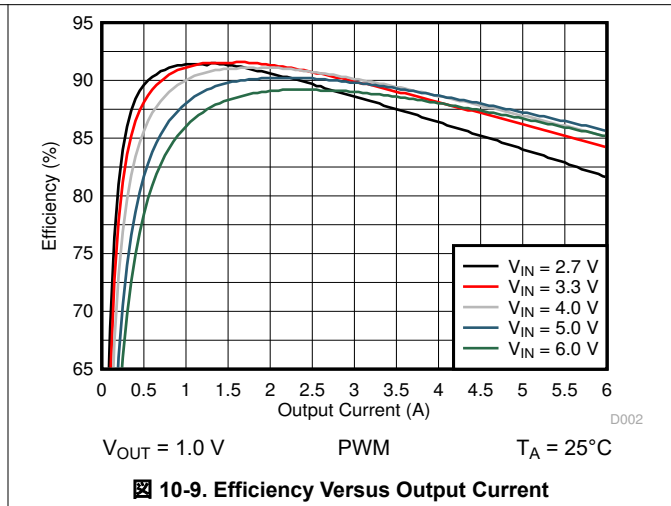
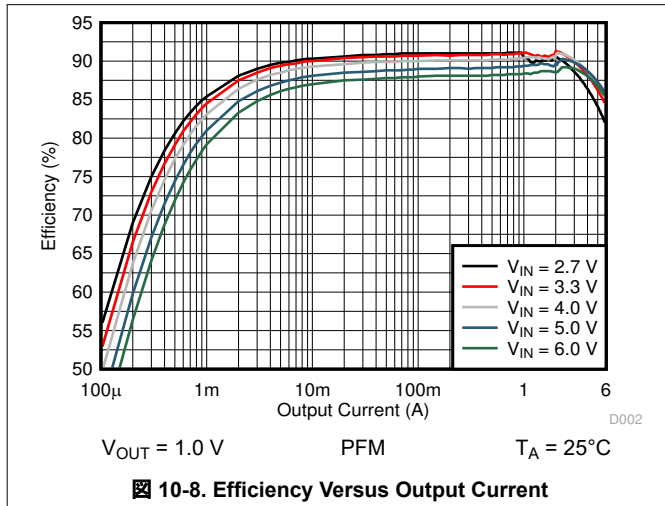

### 10.2.3 Application Curves (continued)

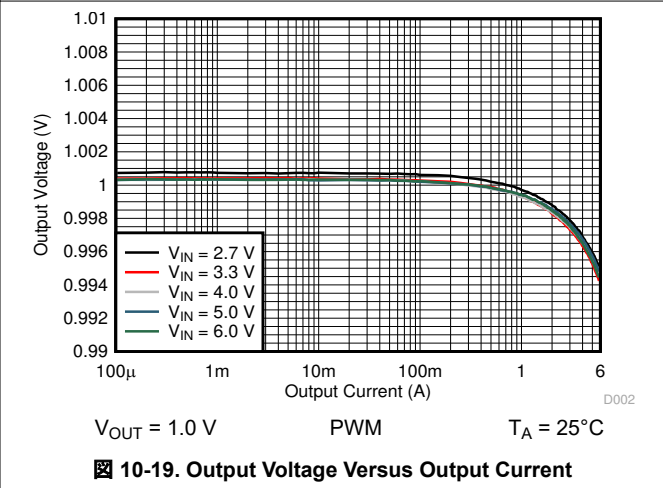
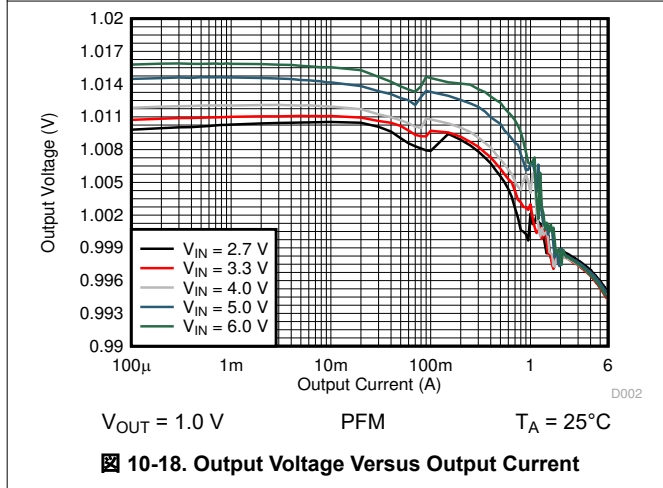
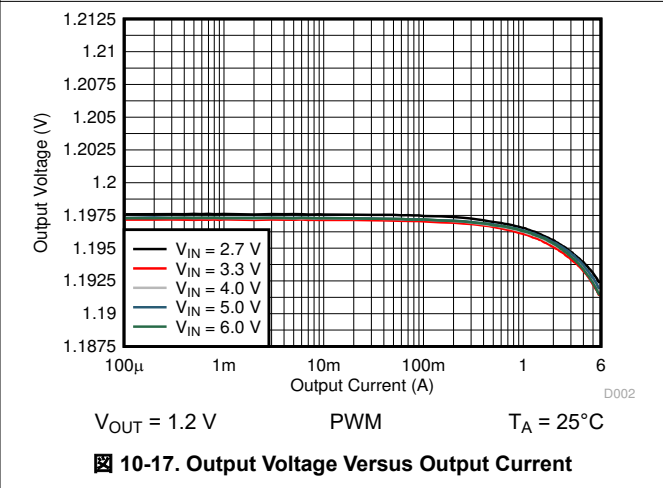
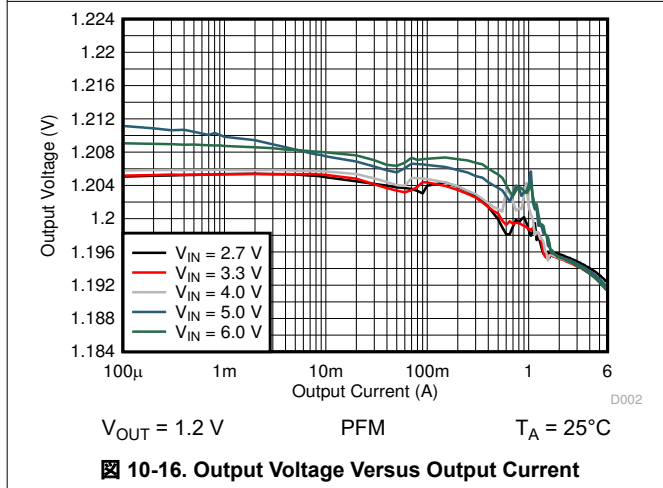
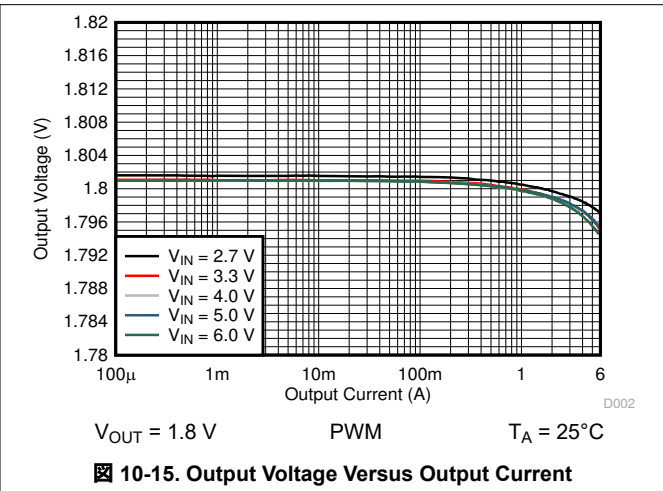
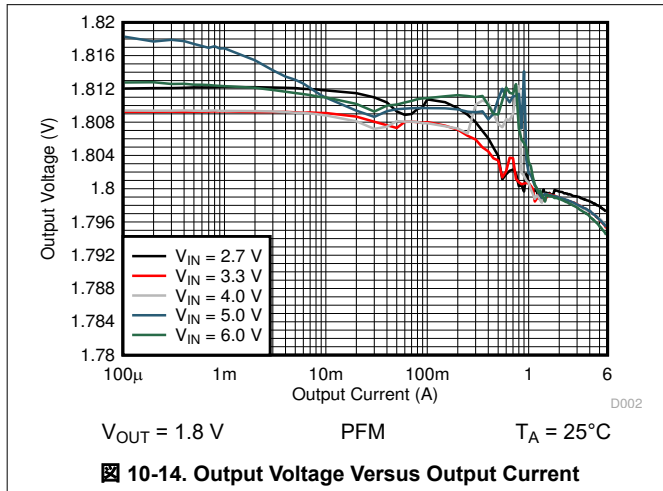

**10.2.3 Application Curves (continued)**

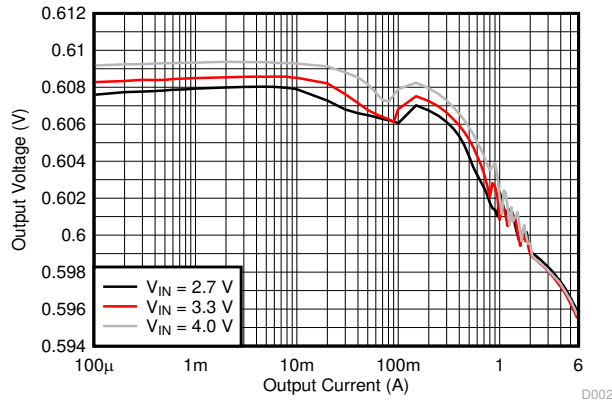

$V_{OUT} = 0.6\text{ V}$  PFM  $T_A = 25^\circ\text{C}$

**10-20. Output Voltage Versus Output Current**

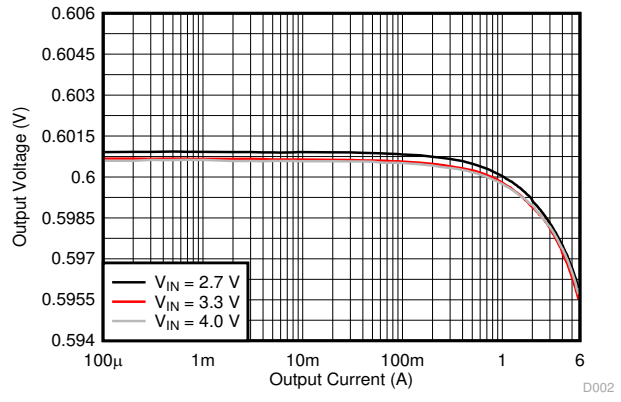

$V_{OUT} = 0.6\text{ V}$  PWM  $T_A = 25^\circ\text{C}$

**10-21. Output Voltage Versus Output Current**

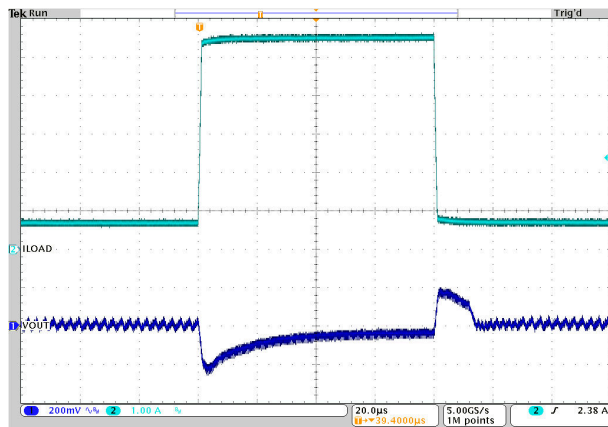

$V_{OUT} = 3.3\text{ V}$  PFM  $T_A = 25^\circ\text{C}$   
 $V_{IN} = 5.0\text{ V}$   $I_{OUT} = 0.6\text{ A to } 5.4\text{ A to } 0.6\text{ A}$

**10-22. Load Transient Response**

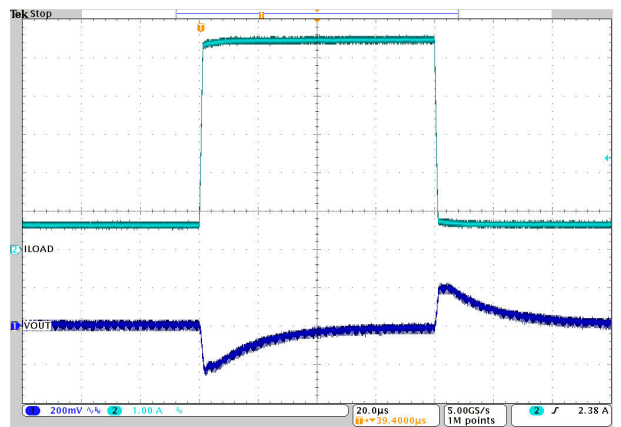

$V_{OUT} = 3.3\text{ V}$  PWM  $T_A = 25^\circ\text{C}$   
 $V_{IN} = 5.0\text{ V}$   $I_{OUT} = 0.6\text{ A to } 5.4\text{ A to } 0.6\text{ A}$

**10-23. Load Transient Response**

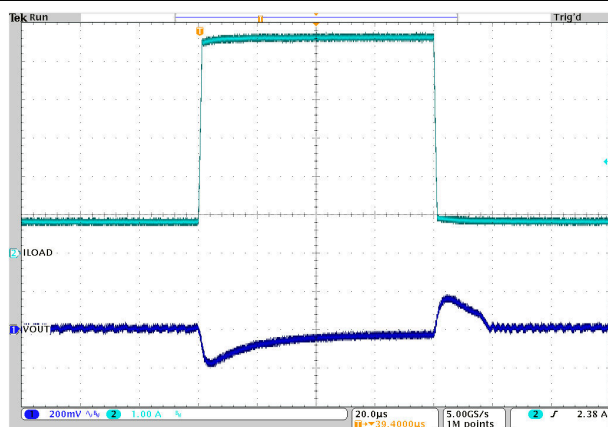

$V_{OUT} = 1.8\text{ V}$  PFM  $T_A = 25^\circ\text{C}$   
 $V_{IN} = 5.0\text{ V}$   $I_{OUT} = 0.6\text{ A to } 5.4\text{ A to } 0.6\text{ A}$

**10-24. Load Transient Response**

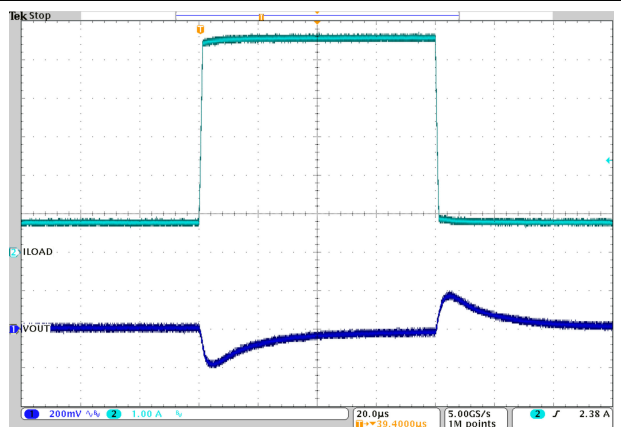

$V_{OUT} = 1.8\text{ V}$  PWM  $T_A = 25^\circ\text{C}$   
 $V_{IN} = 5.0\text{ V}$   $I_{OUT} = 0.6\text{ A to } 5.4\text{ A to } 0.6\text{ A}$

**10-25. Load Transient Response**

### 10.2.3 Application Curves (continued)

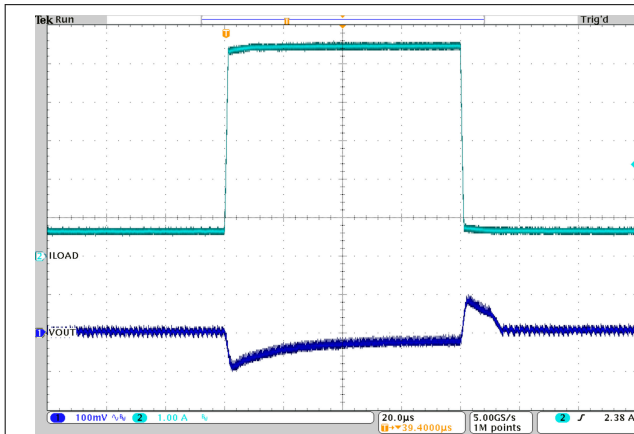

$V_{OUT} = 1.2\text{ V}$       PFM       $T_A = 25^\circ\text{C}$   
 $V_{IN} = 5.0\text{ V}$        $I_{OUT} = 0.6\text{ A to } 5.4\text{ A to } 0.6\text{ A}$

**10-26. Load Transient Response**

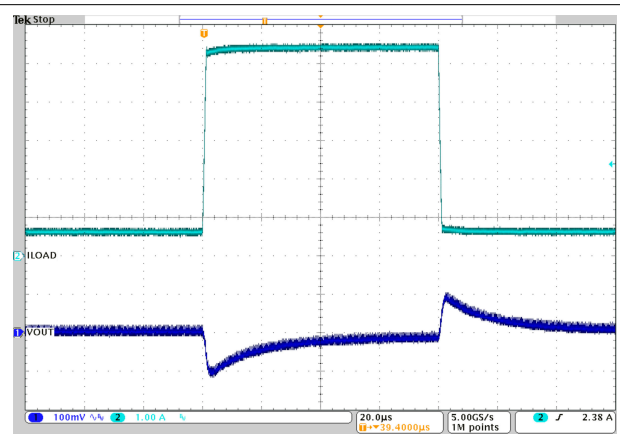

$V_{OUT} = 1.2\text{ V}$       PWM       $T_A = 25^\circ\text{C}$   
 $V_{IN} = 5.0\text{ V}$        $I_{OUT} = 0.6\text{ A to } 5.4\text{ A to } 0.6\text{ A}$

**10-27. Load Transient Response**

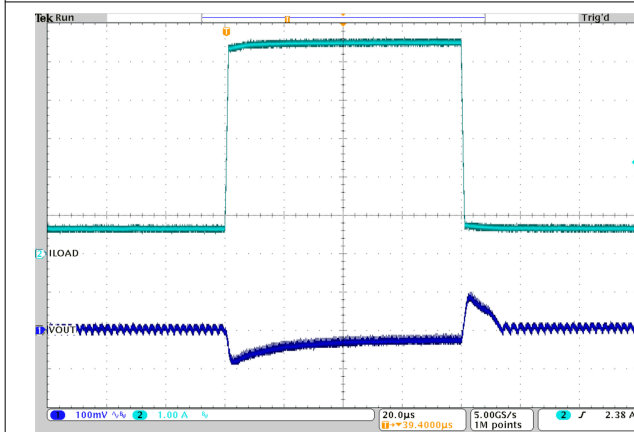

$V_{OUT} = 1.0\text{ V}$       PFM       $T_A = 25^\circ\text{C}$   
 $V_{IN} = 5.0\text{ V}$        $I_{OUT} = 0.6\text{ A to } 5.4\text{ A to } 0.6\text{ A}$

**10-28. Load Transient Response**

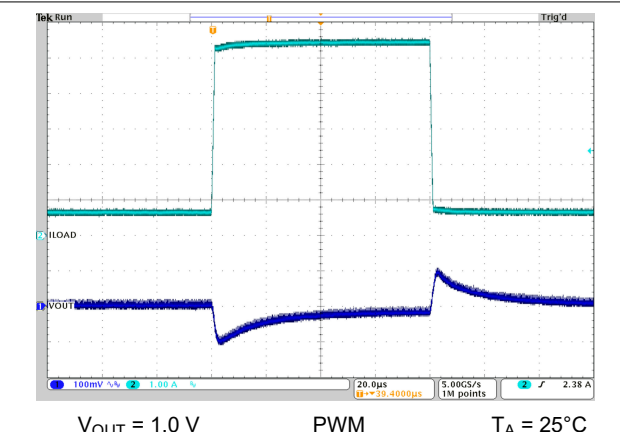

$V_{OUT} = 1.0\text{ V}$       PWM       $T_A = 25^\circ\text{C}$   
 $V_{IN} = 5.0\text{ V}$        $I_{OUT} = 0.6\text{ A to } 5.4\text{ A to } 0.6\text{ A}$

**10-29. Load Transient Response**

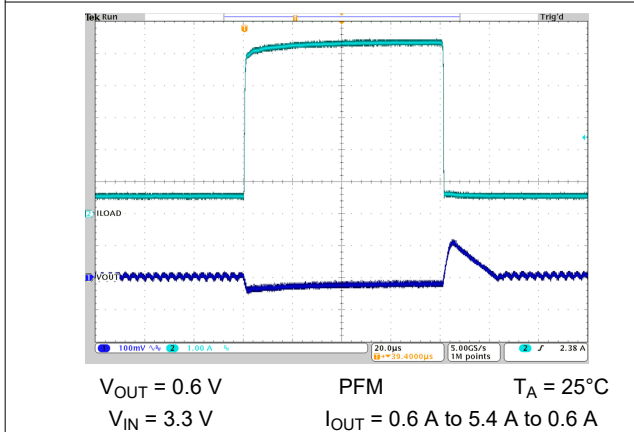

$V_{OUT} = 0.6\text{ V}$       PFM       $T_A = 25^\circ\text{C}$   
 $V_{IN} = 3.3\text{ V}$        $I_{OUT} = 0.6\text{ A to } 5.4\text{ A to } 0.6\text{ A}$

**10-30. Load Transient Response**

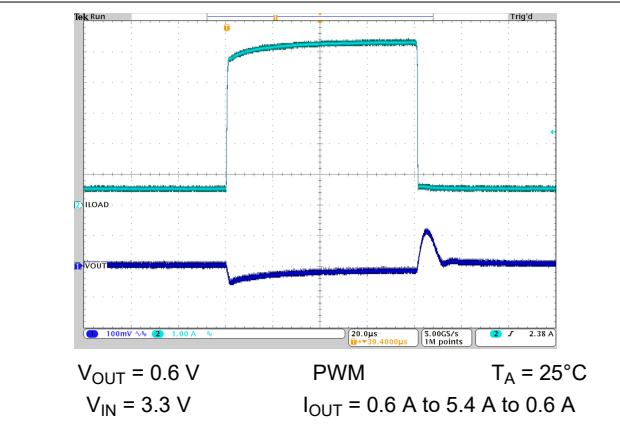

$V_{OUT} = 0.6\text{ V}$       PWM       $T_A = 25^\circ\text{C}$   
 $V_{IN} = 3.3\text{ V}$        $I_{OUT} = 0.6\text{ A to } 5.4\text{ A to } 0.6\text{ A}$

**10-31. Load Transient Response**

**10.2.3 Application Curves (continued)**

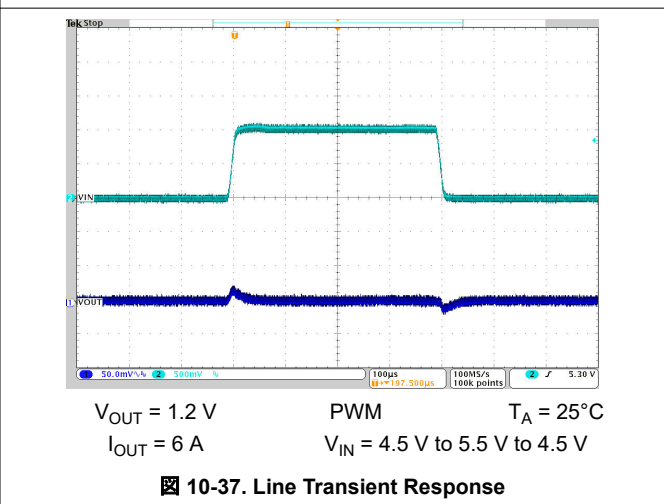
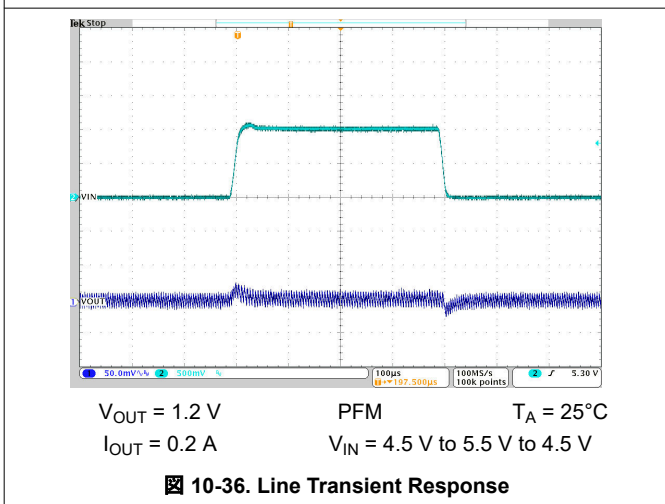
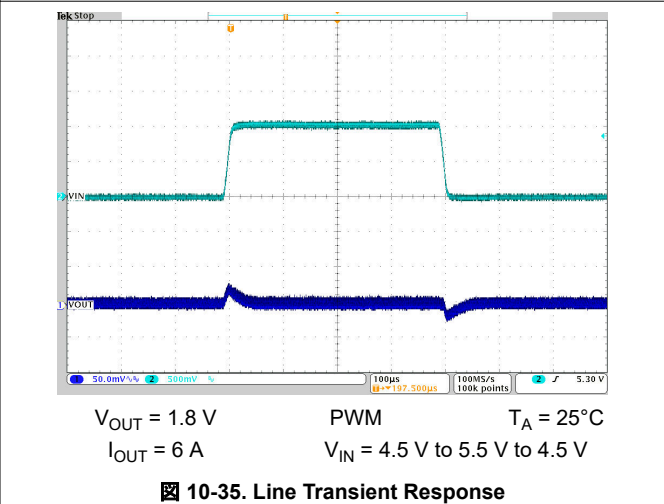
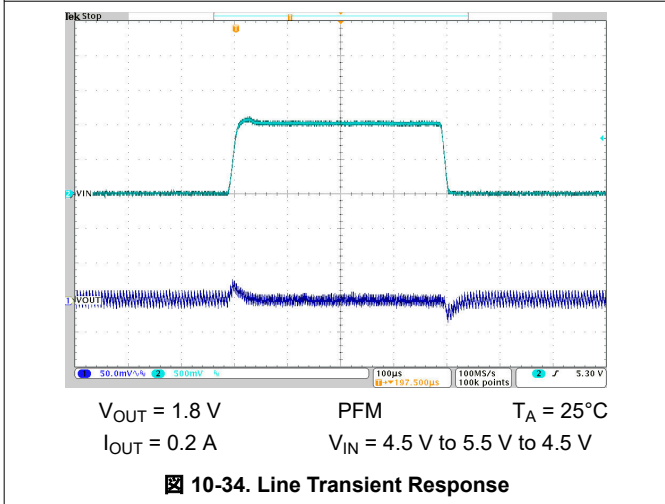
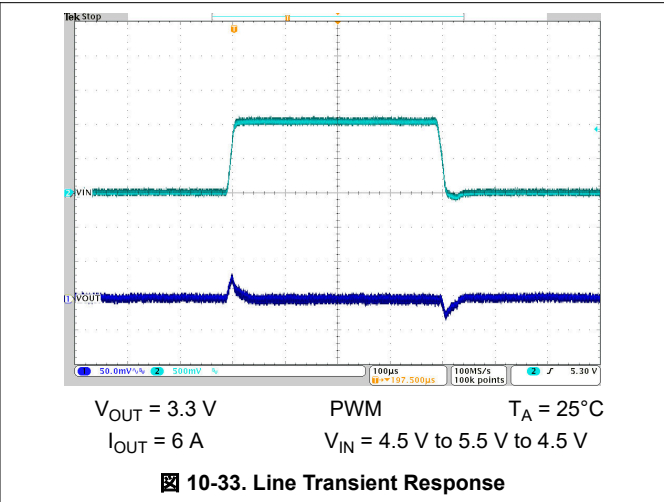
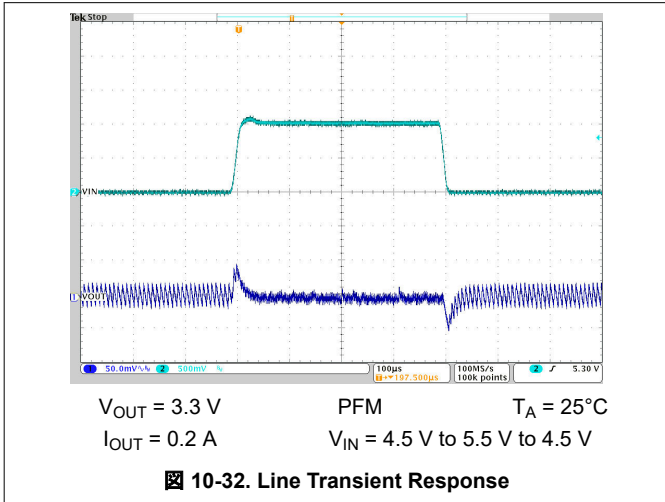

### 10.2.3 Application Curves (continued)

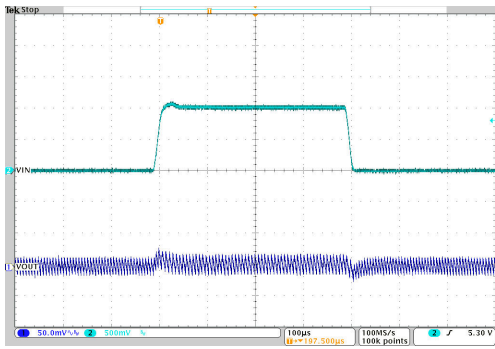

$V_{OUT} = 1.0\text{ V}$       PFM       $T_A = 25^\circ\text{C}$   
 $I_{OUT} = 0.2\text{ A}$        $V_{IN} = 4.5\text{ V to } 5.5\text{ V to } 4.5\text{ V}$

图 10-38. Line Transient Response

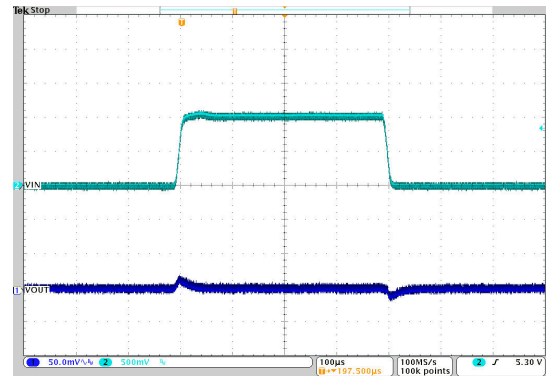

$V_{OUT} = 1.0\text{ V}$       PWM       $T_A = 25^\circ\text{C}$   
 $I_{OUT} = 6\text{ A}$        $V_{IN} = 4.5\text{ V to } 5.5\text{ V to } 4.5\text{ V}$

图 10-39. Line Transient Response

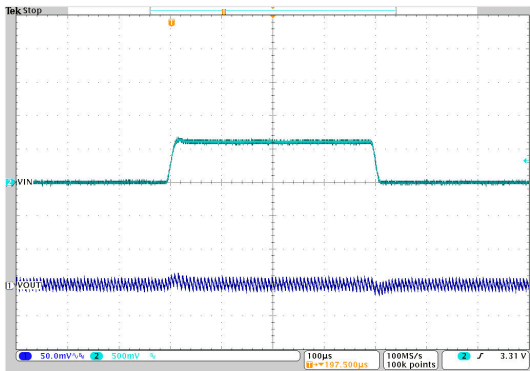

$V_{OUT} = 0.6\text{ V}$       PFM       $T_A = 25^\circ\text{C}$   
 $I_{OUT} = 0.2\text{ A}$        $V_{IN} = 3.0\text{ V to } 3.6\text{ V to } 3.0\text{ V}$

图 10-40. Line Transient Response

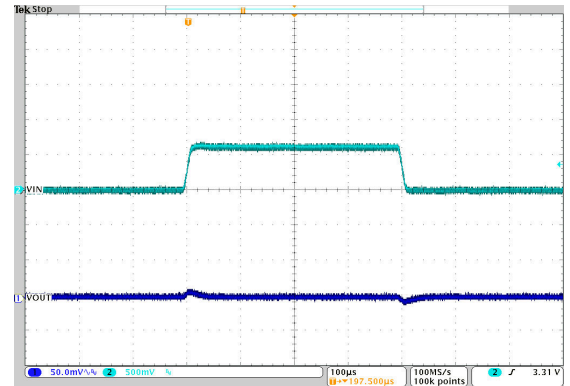

$V_{OUT} = 0.6\text{ V}$       PWM       $T_A = 25^\circ\text{C}$   
 $I_{OUT} = 6\text{ A}$        $V_{IN} = 3.0\text{ V to } 3.6\text{ V to } 3.0\text{ V}$

图 10-41. Line Transient Response

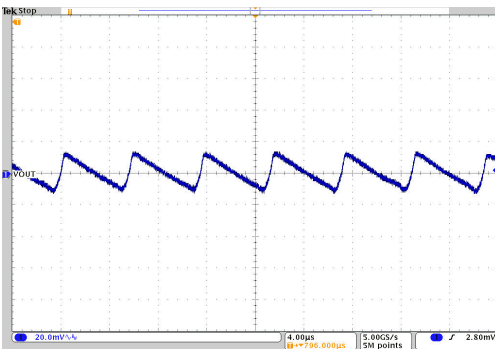

$V_{OUT} = 3.3\text{ V}$       PFM       $T_A = 25^\circ\text{C}$   
 $V_{IN} = 5\text{ V}$        $I_{OUT} = 0.2\text{ A}$

图 10-42. Output Voltage Ripple

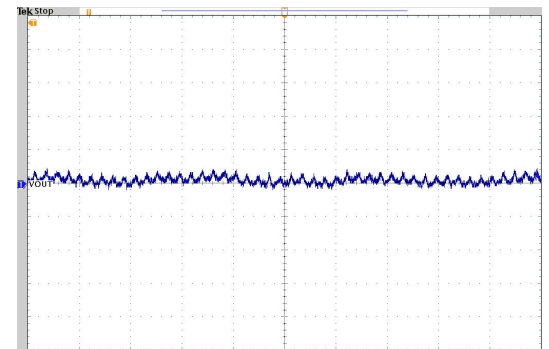

$V_{OUT} = 3.3\text{ V}$       PWM       $T_A = 25^\circ\text{C}$   
 $V_{IN} = 5\text{ V}$        $I_{OUT} = 6\text{ A}$

图 10-43. Output Voltage Ripple

10.2.3 Application Curves (continued)

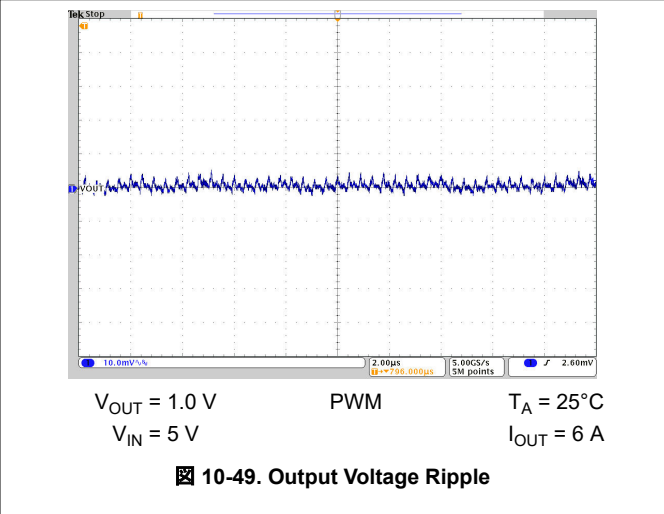
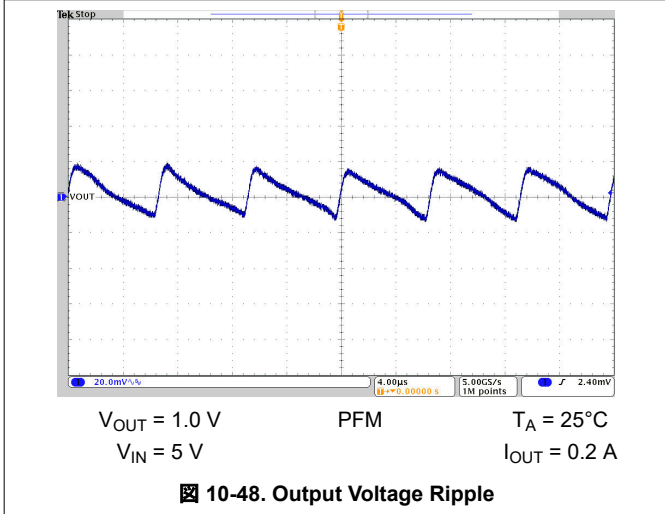
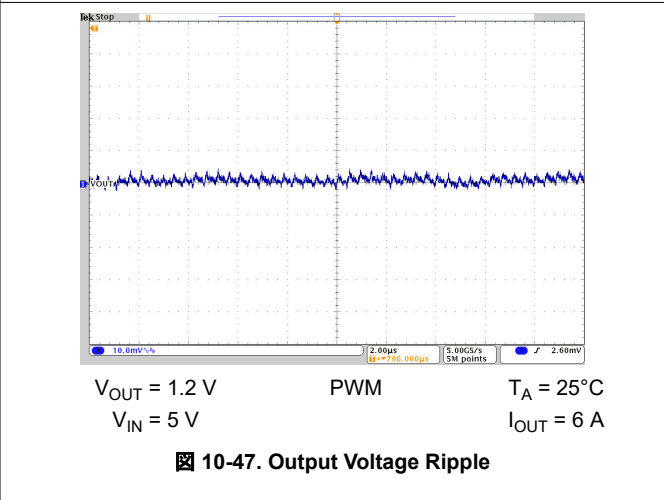
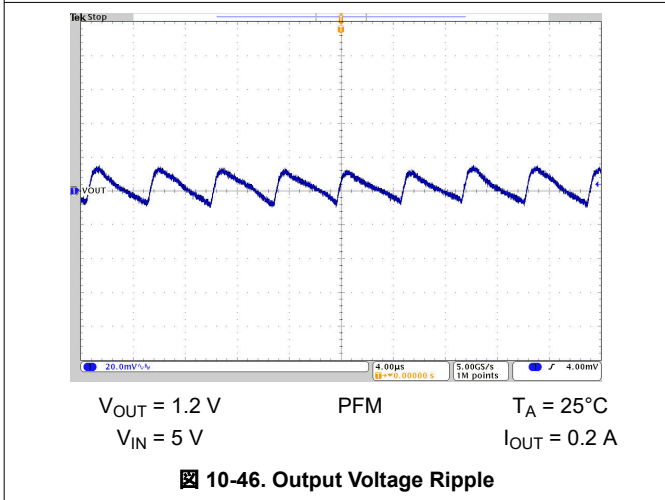
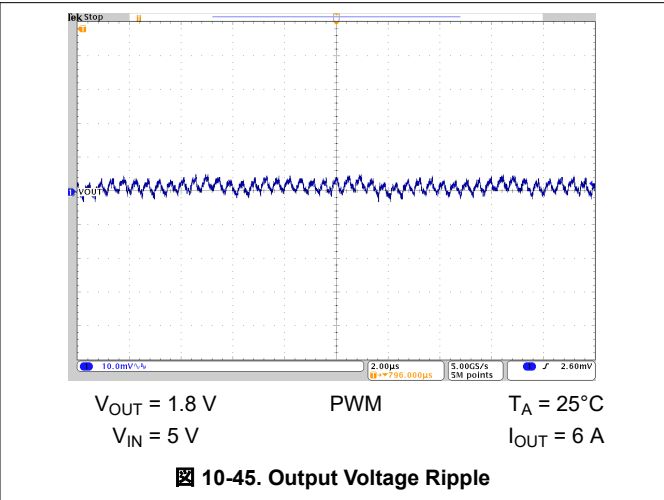
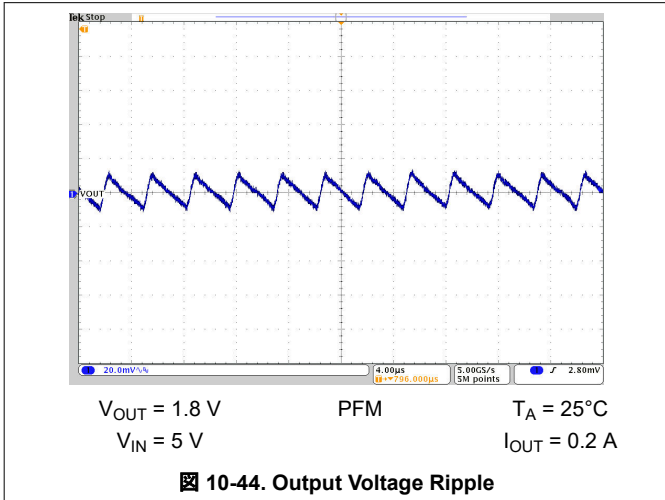



### 10.2.3 Application Curves (continued)

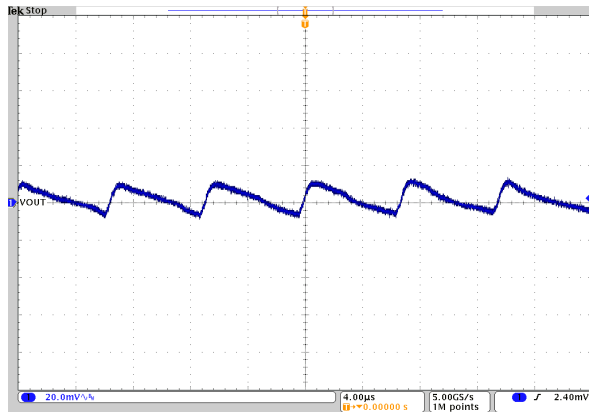

$V_{OUT} = 0.6\text{ V}$       PFM       $T_A = 25^\circ\text{C}$   
 $V_{IN} = 3.3\text{ V}$                        $I_{OUT} = 0.2\text{ A}$

10-50. Output Voltage Ripple

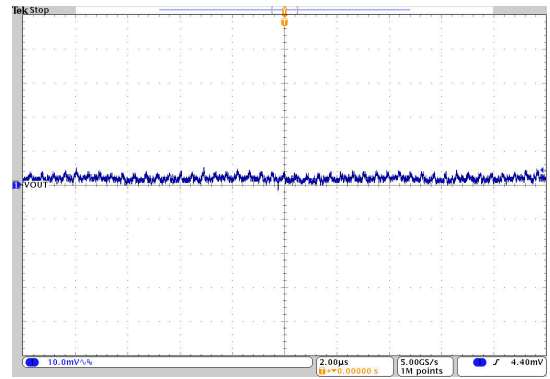

$V_{OUT} = 0.6\text{ V}$       PWM       $T_A = 25^\circ\text{C}$   
 $V_{IN} = 3.3\text{ V}$                        $I_{OUT} = 6\text{ A}$

10-51. Output Voltage Ripple

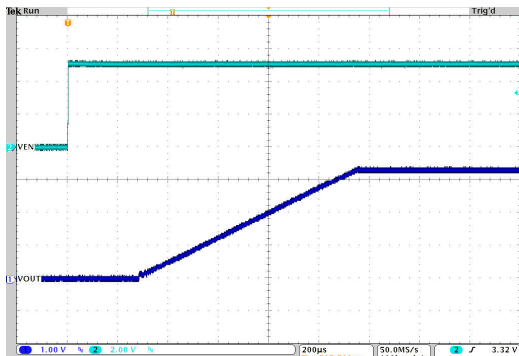

$V_{OUT} = 3.3\text{ V}$       PWM or PFM       $T_A = 25^\circ\text{C}$   
 $V_{IN} = 5\text{ V}$        $C_{SS} = 15\text{ nF}$                        $I_{OUT} = 6\text{ A}$

10-52. Start-Up Timing

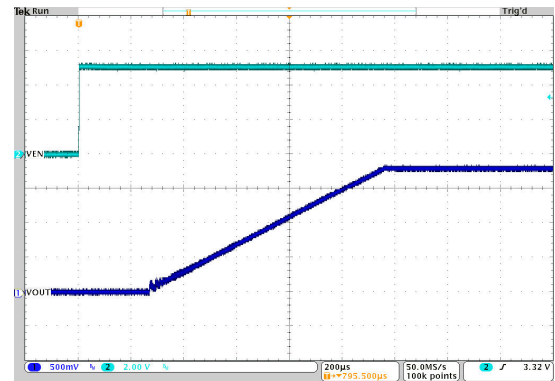

$V_{OUT} = 1.8\text{ V}$       PWM or PFM       $T_A = 25^\circ\text{C}$   
 $V_{IN} = 5\text{ V}$        $C_{SS} = 15\text{ nF}$                        $I_{OUT} = 6\text{ A}$

10-53. Start-Up Timing

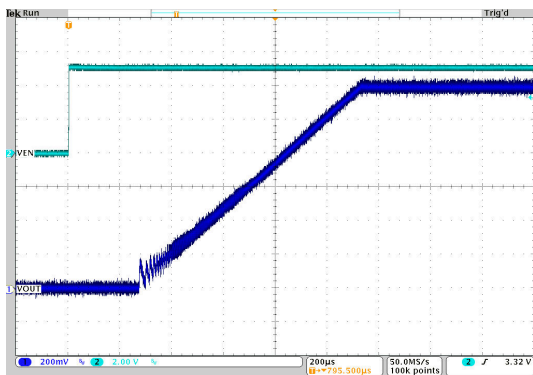

$V_{OUT} = 1.2\text{ V}$       PWM or PFM       $T_A = 25^\circ\text{C}$   
 $V_{IN} = 5\text{ V}$        $C_{SS} = 15\text{ nF}$                        $I_{OUT} = 6\text{ A}$

10-54. Start-Up Timing

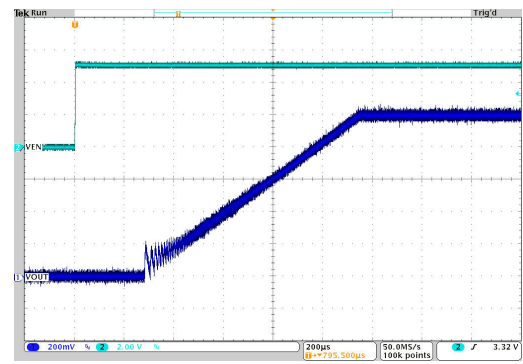

$V_{OUT} = 1.0\text{ V}$       PWM or PFM       $T_A = 25^\circ\text{C}$   
 $V_{IN} = 5\text{ V}$        $C_{SS} = 15\text{ nF}$                        $I_{OUT} = 6\text{ A}$

10-55. Start-Up Timing

### 10.2.3 Application Curves (continued)

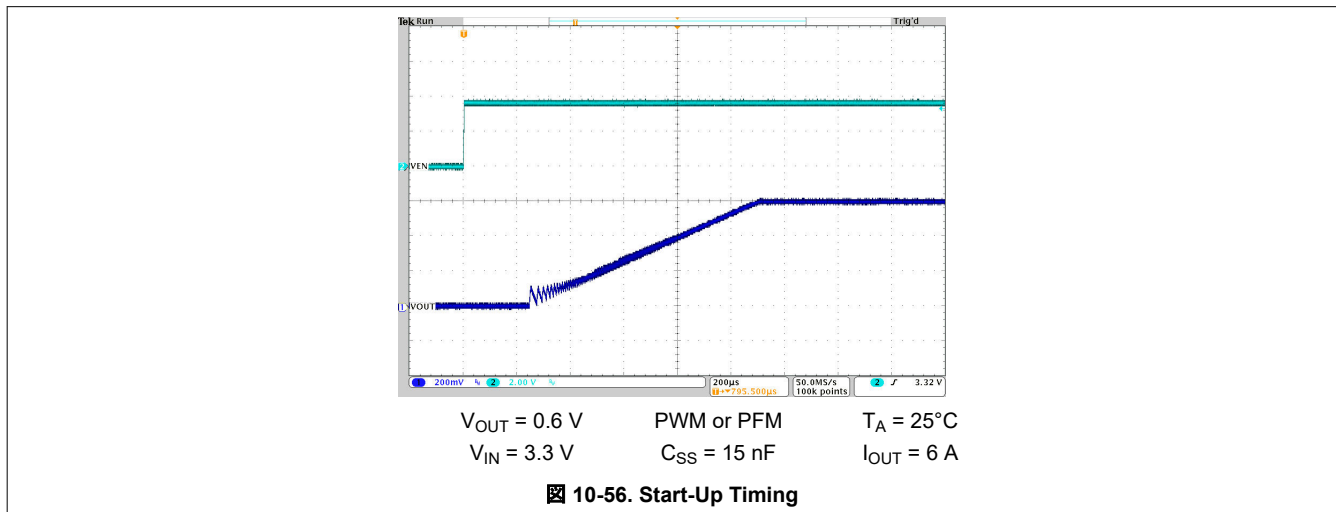

## 10.3 System Examples

### 10.3.1 Voltage Tracking

The TPS62816-Q1 follows the voltage applied to the SS/TR pin. A voltage ramp on SS/TR to 0.6 V ramps the output voltage according to the 0.6-V feedback voltage.

Tracking the 3.3 V of the primary device such that both rails reach their target voltage at the same time, requires a resistor divider on SS/TR of the secondary device equal to the output voltage divider of the primary device. The output current of 10  $\mu\text{A}$  on the SS/TR pin causes an offset voltage on the resistor divider formed by  $R_5$  and  $R_6$ . The equivalent resistance of  $R_5 // R_6$  must therefore be kept below 4 k $\Omega$ . The current from SS/TR causes a slightly higher voltage across  $R_6$  than 0.6 V, which is desired because the secondary device switches to its internal reference as soon as the voltage at SS/TR is higher than 0.6 V.

In case both devices need to run in forced PWM mode, it is recommended to tie the MODE pin of the secondary device to the output voltage or the power good signal of the primary device. The TPS62816-Q1 has a duty cycle limitation defined by the minimum on time. For tracking down to low output voltages, the secondary device cannot follow once the minimum duty cycle is reached. Enabling PFM mode while tracking is in progress allows the user to ramp down the output voltage close to 0 V.

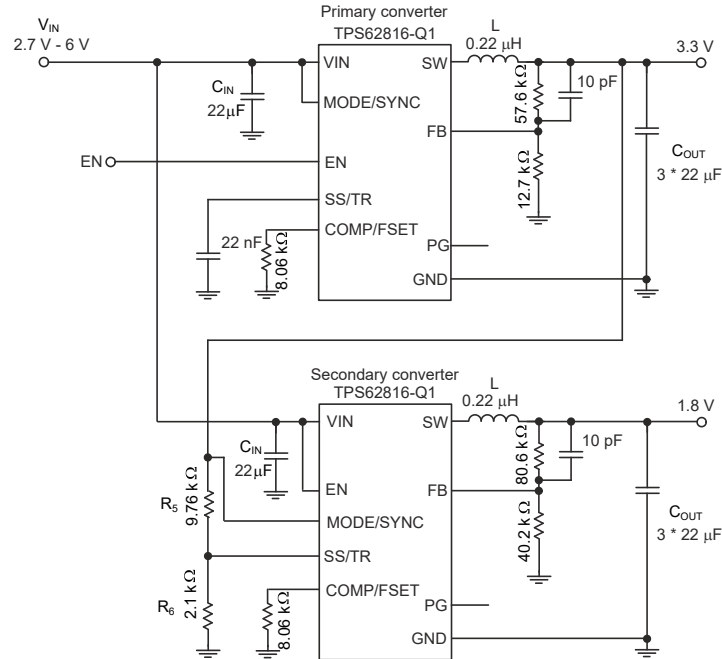

**10-57. Schematic for Output Voltage Tracking**

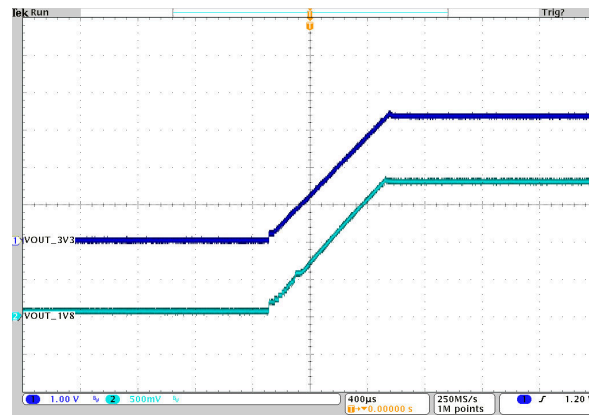

**10-58. Scope Plot for Output Voltage Tracking**

### 10.3.2 Synchronizing to an External Clock

The TPS62816-Q1 can be externally synchronized by applying an external clock on the MODE/SYNC pin. There is no need for any additional circuitry as long as the input signal meets the requirements given in the electrical specifications. The clock can be applied or removed during operation, allowing the user to switch from an externally defined fixed frequency to power save mode or to internal fixed-frequency operation. The value of the  $R_{CF}$  resistor must be chosen such that the internally defined frequency and the externally applied frequency are close to each other. This ensures a smooth transition from internal to external frequency and vice versa.

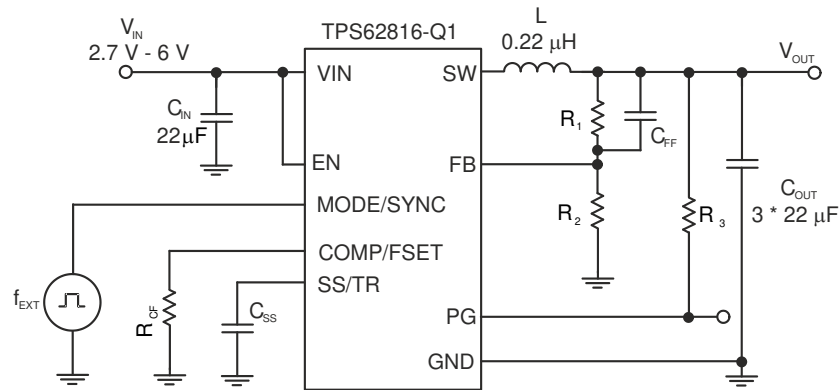

10-59. Schematic Using External Synchronization

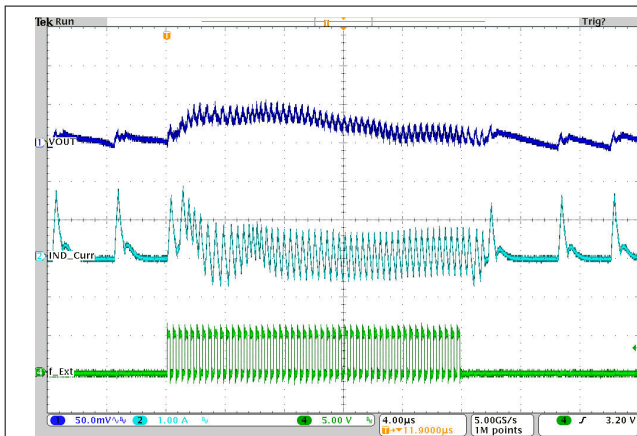

$V_{IN} = 5\text{ V}$        $R_{CF} = 8.06\text{ k}\Omega$        $I_{OUT} = 0.2\text{ A}$   
 $V_{OUT} = 1.8\text{ V}$        $f_{EXT} = 2.5\text{ MHz}$

10-60. Switching from External Synchronization to Power Save Mode (PFM)

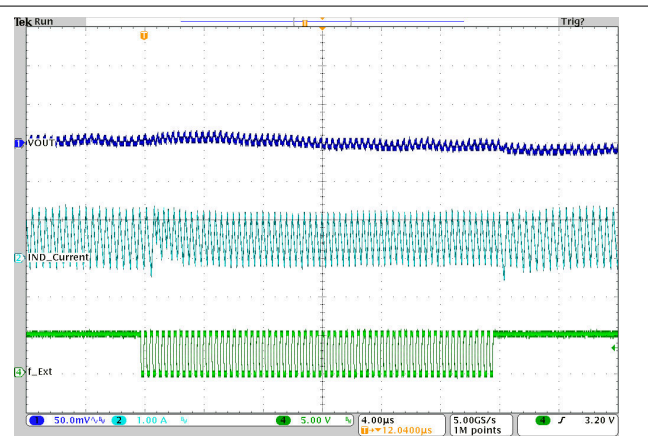

$V_{IN} = 5\text{ V}$        $R_{CF} = 8.06\text{ k}\Omega$        $I_{OUT} = 2\text{ A}$   
 $V_{OUT} = 1.8\text{ V}$        $f_{EXT} = 2.5\text{ MHz}$

10-61. Switching from External Synchronization to Internal Fixed Frequency

### 10.3.3 Compensation Settings

The TPS62816-Q1 offers two different compensation settings using the COMP/FSET pin. This allows the user to optimize the device regarding its transient response. For applications with no high requirements on transient response, a small output capacitance is desired for small size and low cost. In such cases, COMP1 must be used so the TPS62816-Q1 is stable with as low as 32 µF of output capacitance. When the load is very dynamic, adding output capacitance improves transient response, but its effect is limited since this also reduces the cross-over frequency of the control loop. For such cases, COMP2 must be used as it increases the bandwidth, but requires a larger output capacitance for stable operation. The following scope plots are taken for the same conditions, but differ in the compensation setting. Since COMP2 demands 72-µF minimum output capacitance for stability, both plots were both taken with 72 µF on the output to allow the user to compare the results. One plot was taken for the COMP1 ( $R_{CF} = 8.06\text{ k}\Omega$ ) and one for the COMP2 ( $R_{CF} = 80.6\text{ k}\Omega$ ) compensation setting. The scope plots show that for the same output capacitance of 72 µF, the transient response for COMP2 is improved over the COMP1 setting.

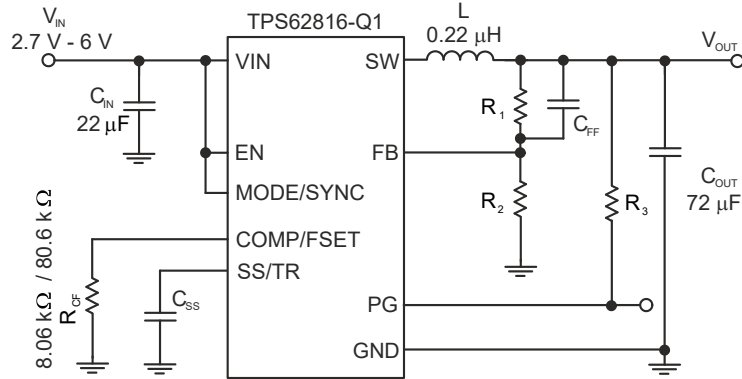

**10-62. Schematic**

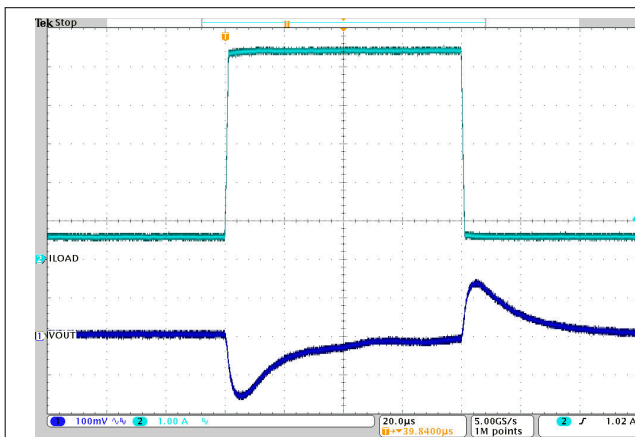

$V_{IN} = 5\text{ V}$        $R_{CF} = 8.06\text{ k}\Omega$        $C_{OUT} = 72\text{ }\mu\text{F}$   
 $V_{OUT} = 1.8\text{ V}$        $I_{OUT} = 0.6\text{ A to } 5.4\text{ A to } 0.6\text{ A}$

**10-63. Load Transient Response with Setting COMP1**

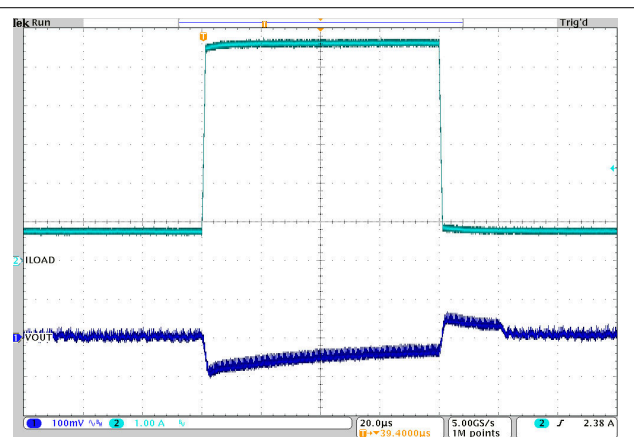

$V_{IN} = 5\text{ V}$        $R_{CF} = 80.6\text{ k}\Omega$        $C_{OUT} = 72\text{ }\mu\text{F}$   
 $V_{OUT} = 1.8\text{ V}$        $I_{OUT} = 0.6\text{ A to } 5.4\text{ A to } 0.6\text{ A}$

**10-64. Load Transient Response with Setting COMP2**

## 11 Power Supply Recommendations

The TPS62816-Q1 device family does not have special requirements for its input power supply. The output current of the input power supply needs to be rated according to the supply voltage, output voltage, and output current of the TPS62816-Q1.

## 12 Layout

### 12.1 Layout Guidelines

A proper layout is critical for the operation of a switched mode power supply, even more at high switching frequencies. Therefore, the PCB layout of the TPS62816-Q1 demands careful attention to ensure operation and to get the performance specified. A poor layout can lead to issues like the following:

- Poor regulation (both line and load)
- Stability and accuracy weaknesses
- Increased EMI radiation
- Noise sensitivity

See [セクション 12.2](#) for the recommended layout of the TPS62816-Q1, which is designed for common external ground connections. The input capacitor must be placed as close as possible between the VIN and GND pin.

Provide low inductive and resistive paths for loops with high di/dt. Therefore, paths conducting the switched load current must be as short and wide as possible. Provide low capacitive paths (with respect to all other nodes) for wires with high dv/dt. Therefore, the input and output capacitance must be placed as close as possible to the IC pins and parallel wiring over long distances and narrow traces must be avoided. Loops that conduct an alternating current must outline an area as small as possible, since this area is proportional to the energy radiated.

Sensitive nodes like FB need to be connected with short wires and not nearby high dv/dt signals (for example, SW). Since they carry information about the output voltage, they must be connected as close as possible to the actual output voltage (at the output capacitor). The capacitor on the SS/TR pin as well as the FB resistors, R<sub>1</sub> and R<sub>2</sub>, must be kept close to the IC and connect directly to those pins and the system ground plane.

The package uses the pins for power dissipation. Thermal vias on the VIN and GND pins help to spread the heat into the PCB.

The recommended layout is implemented on the EVM and shown in the [TPS62816EVM-140 Evaluation Module User's Guide](#).

### 12.2 Layout Example

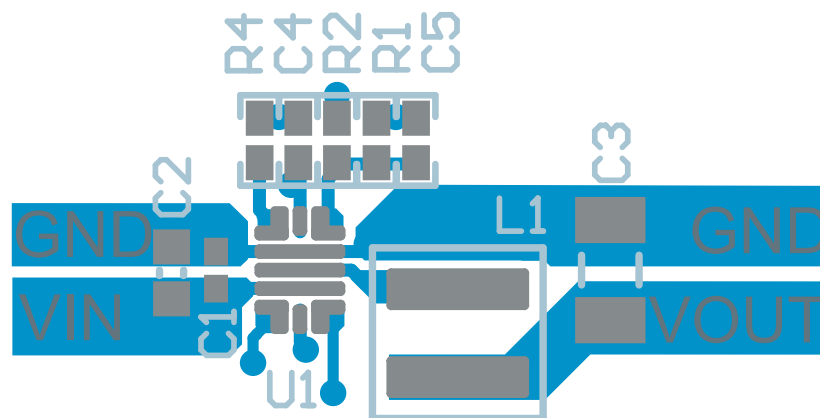

☒ 12-1. Layout Example

## 13 Device and Documentation Support

### 13.1 Device Support

#### 13.1.1 Third-Party Products Disclaimer

TI'S PUBLICATION OF INFORMATION REGARDING THIRD-PARTY PRODUCTS OR SERVICES DOES NOT CONSTITUTE AN ENDORSEMENT REGARDING THE SUITABILITY OF SUCH PRODUCTS OR SERVICES OR A WARRANTY, REPRESENTATION OR ENDORSEMENT OF SUCH PRODUCTS OR SERVICES, EITHER ALONE OR IN COMBINATION WITH ANY TI PRODUCT OR SERVICE.

### 13.2 Documentation Support

#### 13.2.1 Related Documentation

For related documentation, see the following:

Texas Instruments, [TPS62816EVM-140 Evaluation Module User's Guide](#)

### 13.3 Receiving Notification of Documentation Updates

To receive notification of documentation updates, navigate to the device product folder on [ti.com](#). Click on *Subscribe to updates* to register and receive a weekly digest of any product information that has changed. For change details, review the revision history included in any revised document.

### 13.4 サポート・リソース

TI E2E™ サポート・フォーラムは、エンジニアが検証済みの回答と設計に関するヒントをエキスパートから迅速かつ直接得ることができる場所です。既存の回答を検索したり、独自の質問をしたりすることで、設計に必要な支援を迅速に得ることができます。

リンクされているコンテンツは、該当する貢献者により、現状のまま提供されるものです。これらは TI の仕様を構成するものではなく、必ずしも TI の見解を反映したものではありません。TI の[使用条件](#)を参照してください。

### 13.5 Trademarks

TI E2E™ is a trademark of Texas Instruments.

すべての商標は、それぞれの所有者に帰属します。

### 13.6 Electrostatic Discharge Caution



This integrated circuit can be damaged by ESD. Texas Instruments recommends that all integrated circuits be handled with appropriate precautions. Failure to observe proper handling and installation procedures can cause damage.

ESD damage can range from subtle performance degradation to complete device failure. Precision integrated circuits may be more susceptible to damage because very small parametric changes could cause the device not to meet its published specifications.

### 13.7 Glossary

[TI Glossary](#) This glossary lists and explains terms, acronyms, and definitions.

## 14 Mechanical, Packaging, and Orderable Information

The following pages include mechanical, packaging, and orderable information. This information is the most current data available for the designated devices. This data is subject to change without notice and revision of this document. For browser-based versions of this data sheet, refer to the left-hand navigation.

**PACKAGING INFORMATION**

Orderable Device	Status (1)	Package Type	Package Drawing	Pins	Package Qty	Eco Plan (2)	Lead finish/ Ball material (6)	MSL Peak Temp (3)	Op Temp (°C)	Device Marking (4/5)	Samples
TPS62816QWRWYRQ1	ACTIVE	VQFN-HR	RWY	9	3000	RoHS & Green	NIPDAU   SN	Level-2-260C-1 YEAR	-40 to 125	816Q	Samples

(1) The marketing status values are defined as follows:

**ACTIVE:** Product device recommended for new designs.

**LIFEBUY:** TI has announced that the device will be discontinued, and a lifetime-buy period is in effect.

**NRND:** Not recommended for new designs. Device is in production to support existing customers, but TI does not recommend using this part in a new design.

**PREVIEW:** Device has been announced but is not in production. Samples may or may not be available.

**OBSELETE:** TI has discontinued the production of the device.

(2) **RoHS:** TI defines "RoHS" to mean semiconductor products that are compliant with the current EU RoHS requirements for all 10 RoHS substances, including the requirement that RoHS substance do not exceed 0.1% by weight in homogeneous materials. Where designed to be soldered at high temperatures, "RoHS" products are suitable for use in specified lead-free processes. TI may reference these types of products as "Pb-Free".

**RoHS Exempt:** TI defines "RoHS Exempt" to mean products that contain lead but are compliant with EU RoHS pursuant to a specific EU RoHS exemption.

**Green:** TI defines "Green" to mean the content of Chlorine (Cl) and Bromine (Br) based flame retardants meet JS709B low halogen requirements of <=1000ppm threshold. Antimony trioxide based flame retardants must also meet the <=1000ppm threshold requirement.

(3) MSL, Peak Temp. - The Moisture Sensitivity Level rating according to the JEDEC industry standard classifications, and peak solder temperature.

(4) There may be additional marking, which relates to the logo, the lot trace code information, or the environmental category on the device.

(5) Multiple Device Markings will be inside parentheses. Only one Device Marking contained in parentheses and separated by a "-" will appear on a device. If a line is indented then it is a continuation of the previous line and the two combined represent the entire Device Marking for that device.

(6) Lead finish/Ball material - Orderable Devices may have multiple material finish options. Finish options are separated by a vertical ruled line. Lead finish/Ball material values may wrap to two lines if the finish value exceeds the maximum column width.

**Important Information and Disclaimer:**The information provided on this page represents TI's knowledge and belief as of the date that it is provided. TI bases its knowledge and belief on information provided by third parties, and makes no representation or warranty as to the accuracy of such information. Efforts are underway to better integrate information from third parties. TI has taken and continues to take reasonable steps to provide representative and accurate information but may not have conducted destructive testing or chemical analysis on incoming materials and chemicals. TI and TI suppliers consider certain information to be proprietary, and thus CAS numbers and other limited information may not be available for release.

In no event shall TI's liability arising out of such information exceed the total purchase price of the TI part(s) at issue in this document sold by TI to Customer on an annual basis.



**TAPE AND REEL INFORMATION**

**QUADRANT ASSIGNMENTS FOR PIN 1 ORIENTATION IN TAPE**

\*All dimensions are nominal

Device	Package Type	Package Drawing	Pins	SPQ	Reel Diameter (mm)	Reel Width W1 (mm)	A0 (mm)	B0 (mm)	K0 (mm)	P1 (mm)	W (mm)	Pin1 Quadrant
TPS62816QWRWYRQ1	VQFN-HR	RWY	9	3000	180.0	8.4	2.25	3.25	1.05	4.0	8.0	Q1

**TAPE AND REEL BOX DIMENSIONS**

\*All dimensions are nominal

Device	Package Type	Package Drawing	Pins	SPQ	Length (mm)	Width (mm)	Height (mm)
TPS62816QWRWYRQ1	VQFN-HR	RWY	9	3000	210.0	185.0	35.0

## GENERIC PACKAGE VIEW

**RWY 9**

**VQFN-HR - 1 mm max height**

2 x 3, 0.5 mm pitch

PLASTIC QUAD FLATPACK - NO LEAD

This image is a representation of the package family, actual package may vary.  
Refer to the product data sheet for package details.

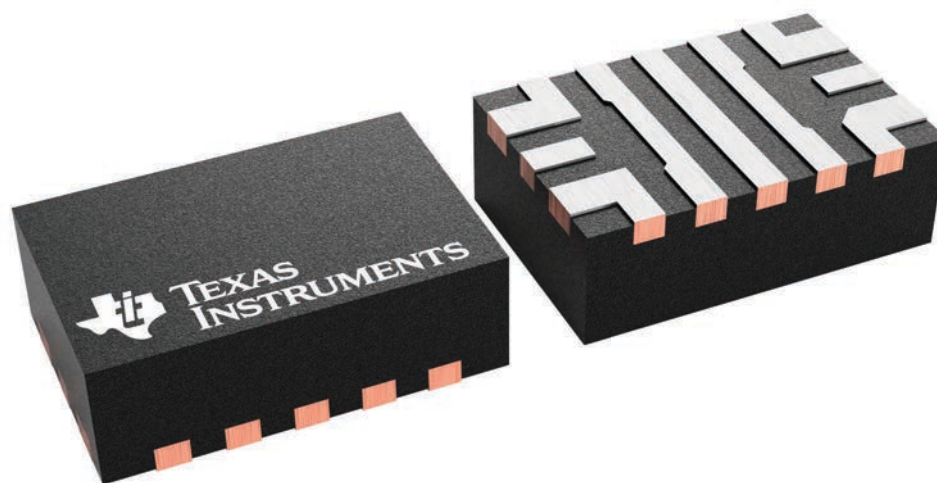

4226729/A

RWY0009A



**PACKAGE OUTLINE**  
**VQFN-HR - 1 mm max height**

PLASTIC QUAD FLATPACK - NO LEAD

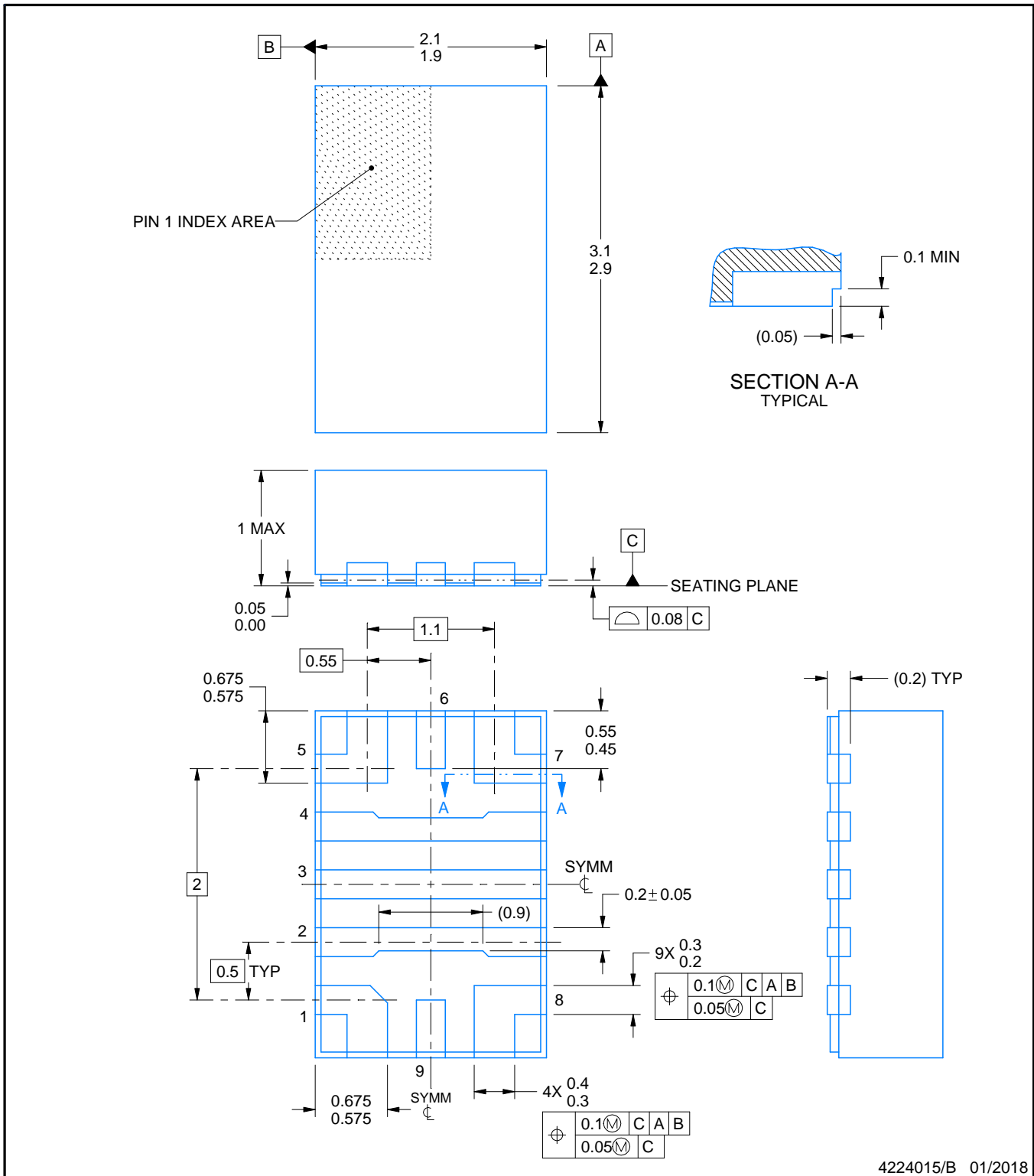

4224015/B 01/2018

**NOTES:**

1. All linear dimensions are in millimeters. Any dimensions in parenthesis are for reference only. Dimensioning and tolerancing per ASME Y14.5M.
2. This drawing is subject to change without notice.

# EXAMPLE BOARD LAYOUT

RWY0009A

VQFN-HR - 1 mm max height

PLASTIC QUAD FLATPACK - NO LEAD

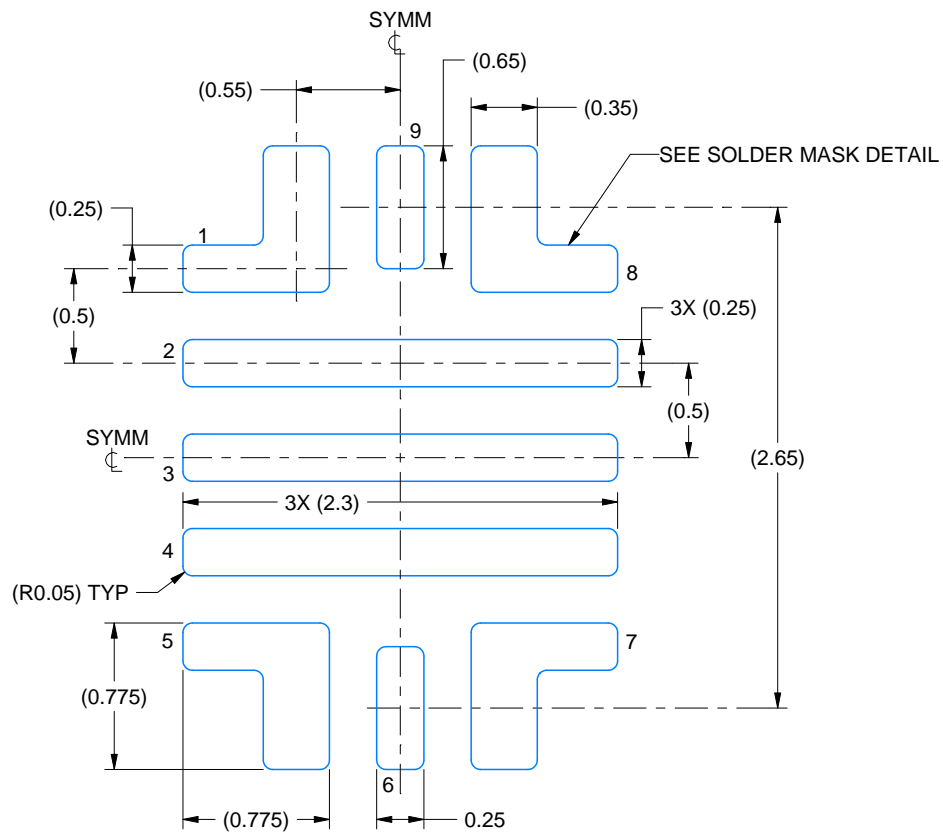

LAND PATTERN EXAMPLE  
EXPOSED METAL SHOWN  
SCALE: 25X

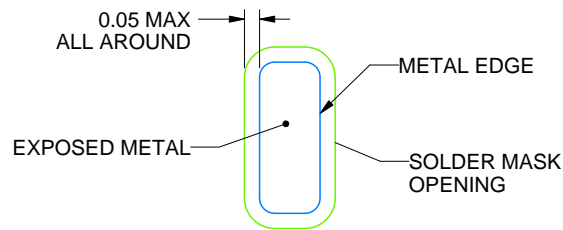

NON SOLDER MASK  
DEFINED

SOLDER MASK DETAIL

4224015/B 01/2018

NOTES: (continued)

- This package is designed to be soldered to thermal pads on the board. For more information, see Texas Instruments literature number SLUA271 ([www.ti.com/lit/slua271](http://www.ti.com/lit/slua271)).
- Vias are optional depending on application, refer to device data sheet. It is recommended that vias under paste be filled, plugged or tented.

# EXAMPLE STENCIL DESIGN

RWY0009A

VQFN-HR - 1 mm max height

PLASTIC QUAD FLATPACK - NO LEAD

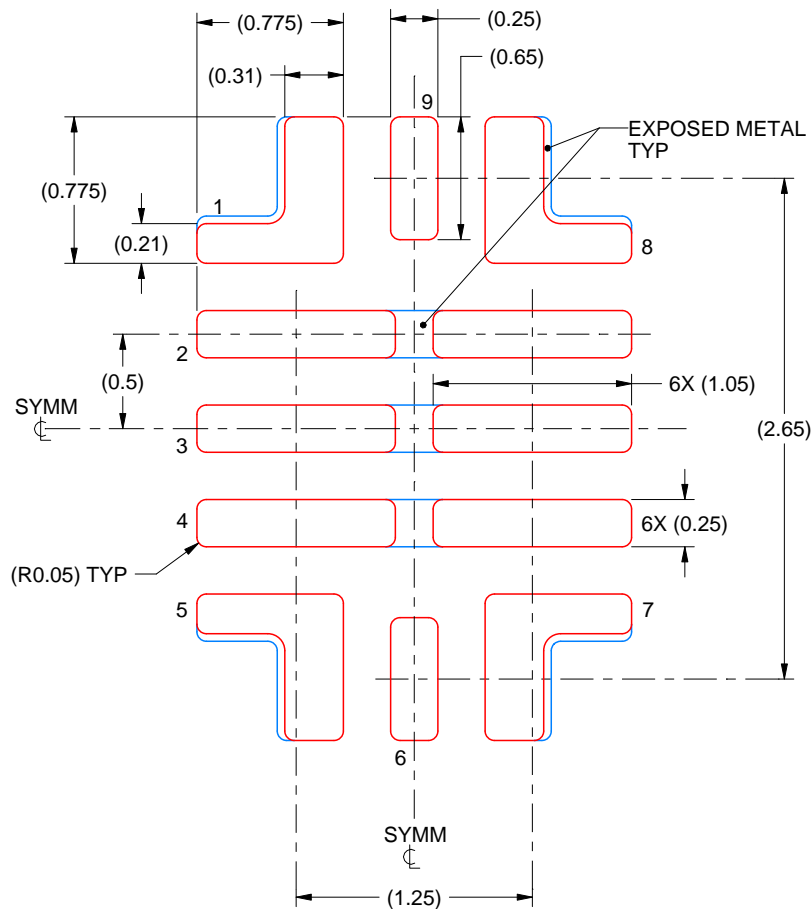

SOLDER PASTE EXAMPLE  
BASED ON 0.1 mm THICK STENCIL  
PADS 1, 5, 7 & 8:  
90% PRINTED SOLDER COVERAGE BY AREA UNDER PACKAGE  
SCALE: 25X

4224015/B 01/2018

NOTES: (continued)

5. Laser cutting apertures with trapezoidal walls and rounded corners may offer better paste release. IPC-7525 may have alternate design recommendations.

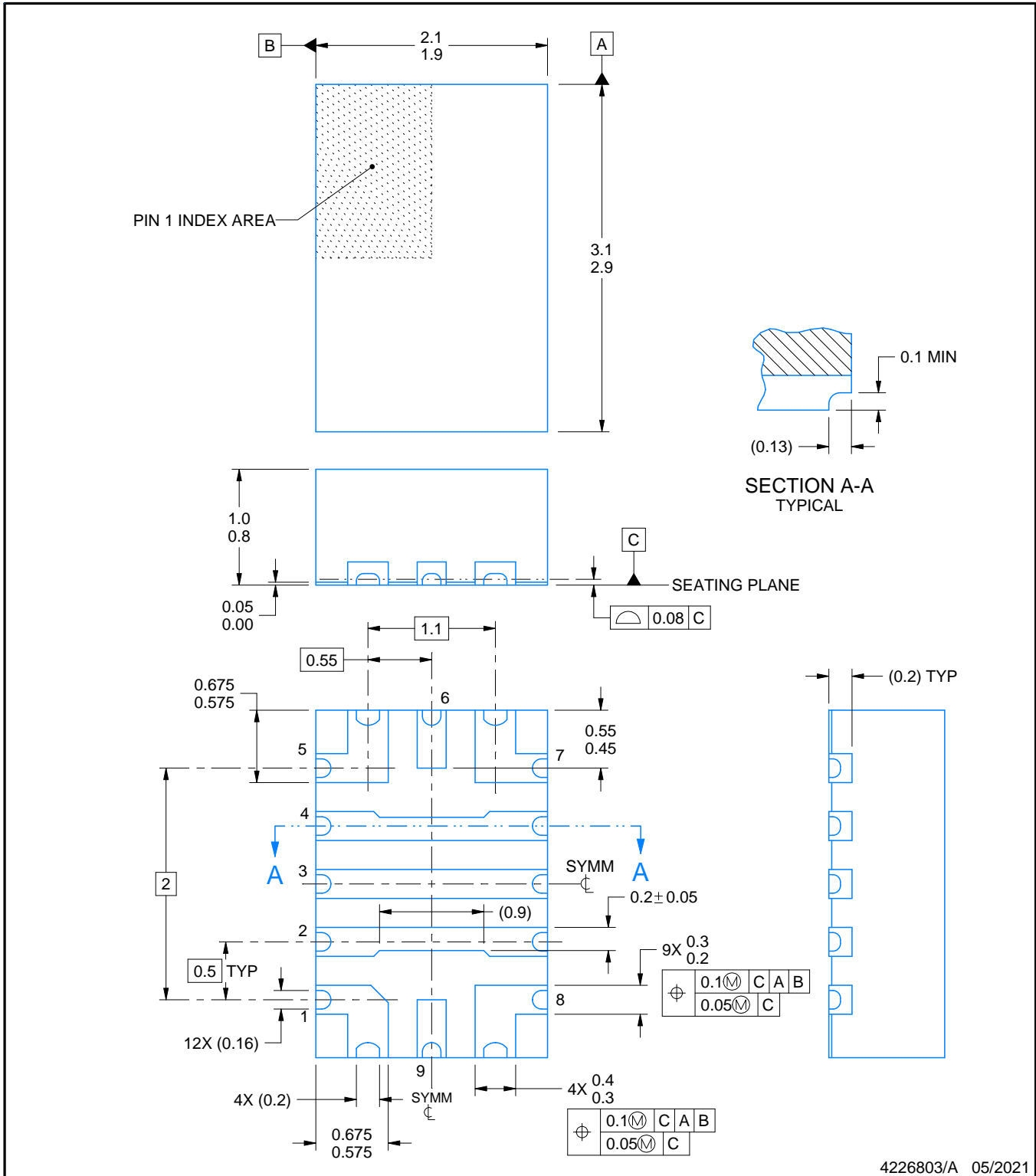

4226803/A 05/2021

NOTES:

1. All linear dimensions are in millimeters. Any dimensions in parenthesis are for reference only. Dimensioning and tolerancing per ASME Y14.5M.
2. This drawing is subject to change without notice.

# EXAMPLE BOARD LAYOUT

RWY0009C

VQFN-HR - 1 mm max height

PLASTIC QUAD FLATPACK - NO LEAD

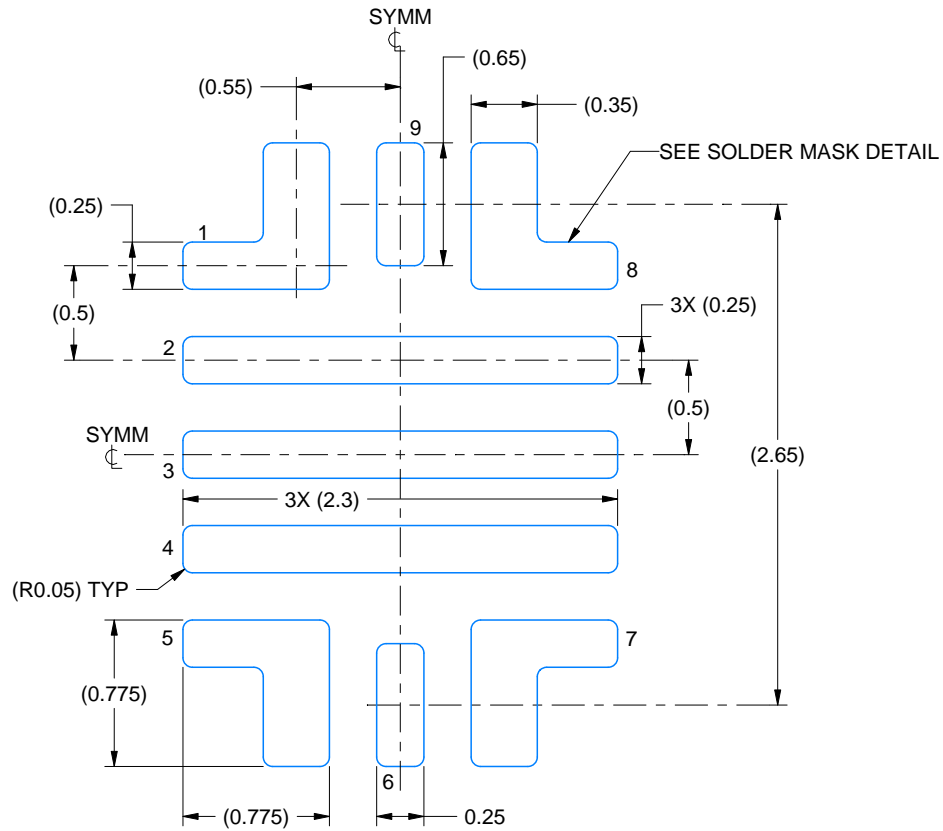

LAND PATTERN EXAMPLE  
EXPOSED METAL SHOWN  
SCALE: 25X

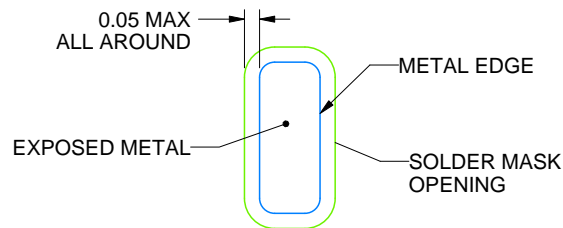

NON SOLDER MASK  
DEFINED

SOLDER MASK DETAIL

4226803/A 05/2021

NOTES: (continued)

3. This package is designed to be soldered to thermal pads on the board. For more information, see Texas Instruments literature number SLUA271 ([www.ti.com/lit/sluea271](http://www.ti.com/lit/sluea271)).
4. Vias are optional depending on application, refer to device data sheet. It is recommended that vias under paste be filled, plugged or tented.



# EXAMPLE STENCIL DESIGN

RWY0009C

VQFN-HR - 1 mm max height

PLASTIC QUAD FLATPACK - NO LEAD

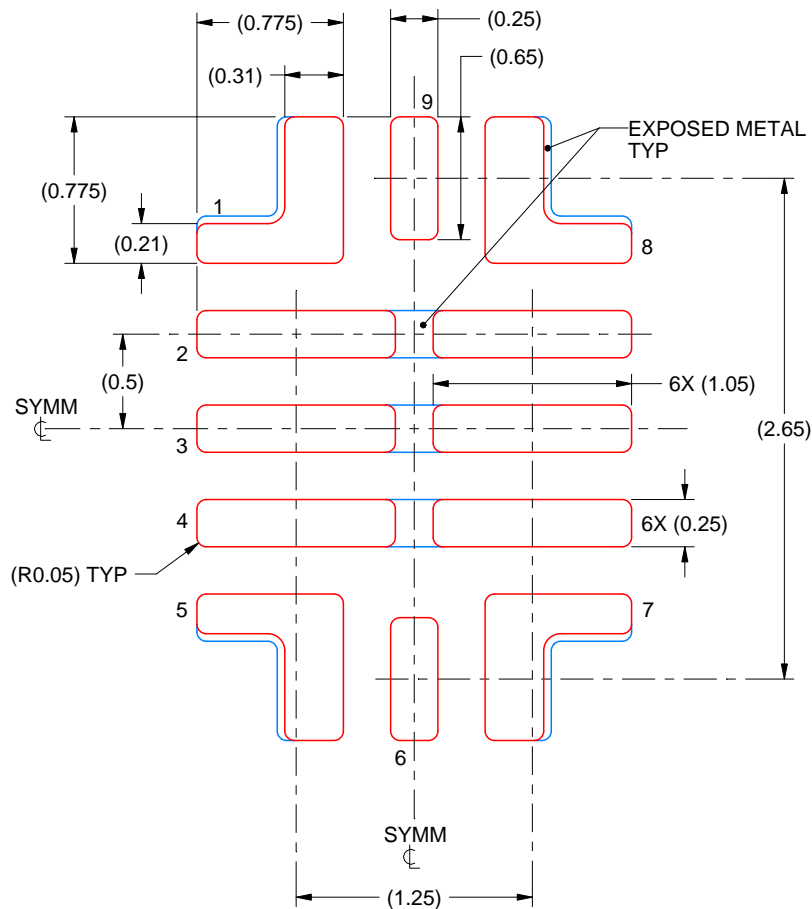

SOLDER PASTE EXAMPLE  
BASED ON 0.1 mm THICK STENCIL  
PADS 1, 5, 7 & 8:  
90% PRINTED SOLDER COVERAGE BY AREA UNDER PACKAGE  
SCALE: 25X

4226803/A 05/2021

NOTES: (continued)

5. Laser cutting apertures with trapezoidal walls and rounded corners may offer better paste release. IPC-7525 may have alternate design recommendations.

## 重要なお知らせと免責事項

TI は、技術データと信頼性データ (データシートを含みます)、設計リソース (リファレンス・デザインを含みます)、アプリケーションや設計に関する各種アドバイス、Web ツール、安全性情報、その他のリソースを、欠陥が存在する可能性のある「現状のまま」提供しており、商品性および特定目的に対する適合性の黙示保証、第三者の知的財産権の非侵害保証を含むいかなる保証も、明示的または黙示的にかかわらず拒否します。

これらのリソースは、TI 製品を使用する設計の経験を積んだ開発者への提供を意図したものです。(1) お客様のアプリケーションに適した TI 製品の選定、(2) お客様のアプリケーションの設計、検証、試験、(3) お客様のアプリケーションに該当する各種規格や、その他のあらゆる安全性、セキュリティ、規制、または他の要件への確実な適合に関する責任を、お客様のみが単独で負うものとし、

上記の各種リソースは、予告なく変更される可能性があります。これらのリソースは、リソースで説明されている TI 製品を使用するアプリケーションの開発の目的でのみ、TI はその使用をお客様に許諾します。これらのリソースに関して、他の目的で複製することや掲載することは禁止されています。TI や第三者の知的財産権のライセンスが付与されている訳ではありません。お客様は、これらのリソースを自身で使用した結果発生するあらゆる申し立て、損害、費用、損失、責任について、TI およびその代理人を完全に補償するものとし、TI は一切の責任を拒否します。

TI の製品は、[TI の販売条件](#)、または [ti.com](#) やかかる TI 製品の関連資料などのいずれかを通じて提供する適用可能な条項の下で提供されています。TI がこれらのリソースを提供することは、適用される TI の保証または他の保証の放棄の拡大や変更を意味するものではありません。

お客様がいかなる追加条項または代替条項を提案した場合でも、TI はそれらに異議を唱え、拒否します。

郵送先住所 : Texas Instruments, Post Office Box 655303, Dallas, Texas 75265  
Copyright © 2024, Texas Instruments Incorporated