

## TPS659128 PMU、プロセッサ電源用

### 1 特長

- 4 つの降圧コンバータ
  - 入力電圧 ( $V_{IN}$ ) 範囲: 2.7V~5.5V
  - 軽負荷電流時のパワー・セーブ・モード
  - PWM モード時の出力電圧精度:  $\pm 2\%$
  - コンバータごとの静止電流: 26 $\mu$ A (標準値)
  - ダイナミック電圧スケーリング
  - 100% デューティ・サイクル動作による最小のドロップアウト電圧
- 10 個の LDO
  - 8 つの汎用 LDO
  - 出力電圧範囲: 0.8V~3.3V
  - LDO ごとの静止電流: 32 $\mu$ A (標準値)
  - 2 つの低ノイズ RF-LDO
  - 出力電圧範囲: 1.6V~3.3V
  - 個別の電源入力によるプリレギュレーションのサポート
  - Eco-mode™ 制御方式
  - 以下の  $V_{IN}$  電圧範囲に対応する LDO
    - 1.8V~3.6V
    - 3V~5.5V
- 3 つの LED ドライバ
  - I<sup>2</sup>C を利用した内蔵調光機能
  - 電流シンクごとに最大 20mA
- 温度監視
  - 高温の警告
  - サーマル・シャットダウン
- バイパス・スイッチ
  - 無線周波数パワー・アンプ (RF-PA) に給電するアプリケーションで DCDC4 と組み合わせて使用
- インターフェイス
  - I<sup>2</sup>C インターフェイス
  - パワー I<sup>2</sup>C インターフェイスによる動的電圧スケーリング (DVS)
  - シリアル・ペリフェラル・インターフェイス (SPI)
- 32kHz RC 発振器
- 低電圧誤動作防止、バッテリー・フォルト・コンパレータ、ボタン長押し検出
- 3.6mm × 3.6mm の DSBGA パッケージ、0.4mm ピッチ

### 2 アプリケーション

- スマートフォン
- 無線ルータおよびスイッチ
- タブレット
- 産業用アプリケーション
- LTE モデム

- GPS

### 3 概要

TPS659128x デバイスは、最大出力電流 2.5A の構成可能な 4 つの降圧コンバータと、10 個の外部用 LDO レギュレータを備えています。これらの LDO には、バッテリーまたはプリレギュレーション済みの電源から給電が可能です。本デバイスには、部品番号ごとに異なる電源オンおよび電源オフ・シーケンスが工場出荷時にプログラムされています。

TPS659128x デバイスは、電源オンまたは電源オフ時にすべてのリソースのシーケンスを調整するため、32kHz の RC 発振器を内蔵しています。すべての LDO と DC/DC コンバータは、I<sup>2</sup>C/SPI インターフェイスまたは基本的なブート後のイネーブル・ピンで制御できます。また、電圧スケーリング・インターフェイスを使うことで、I<sup>2</sup>C または基本的なルーフ / フロア制御によって DC/DC コンバータを別の電圧に遷移させることができます。本デバイスは、先進の調光機能を備えた 3 つの LED ドライバを内蔵しています。汎用入出力 (GPIO) 機能は各種ピン (例: LED ピン、ENx ピン、SPI ピン) と多重化されています。各 GPIO は、電源オン・シーケンスの一部として外部リソースを制御するように設定できます。SLEEP ピン 1 本で、アクティブ・モードとあらかじめプログラムされたスリープ・モードを切り替えることで電力を最適化できます。TPS659128x デバイスは 9 ピン DSBGA パッケージ (3.6mm × 3.6mm、0.4mm ピッチ) で供給されます。

#### 製品情報<sup>(1)</sup>

部品番号	パッケージ	本体サイズ
TPS6591286	DSBGA (81)	3.60mm × 3.60mm
TPS6591287		

- (1) 利用可能なすべてのパッケージについては、このデータシートの末尾にある注文情報を参照してください。

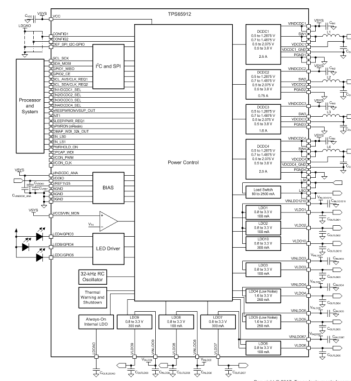

概略回路図



## Table of Contents

<b>1 特長</b> .....	<b>1</b>	<b>7 Parameter Measurement Information</b> .....	<b>24</b>
<b>2 アプリケーション</b> .....	<b>1</b>	7.1 I <sup>2</sup> C Timing Diagrams.....	24
<b>3 概要</b> .....	<b>1</b>	7.2 SPI Timing Diagram.....	25
<b>4 Revision History</b> .....	<b>2</b>	<b>8 Detailed Description</b> .....	<b>26</b>
<b>5 Pin Configuration and Functions</b> .....	<b>3</b>	8.1 Overview.....	26
<b>6 Specifications</b> .....	<b>7</b>	8.2 Functional Block Diagram.....	27
6.1 Absolute Maximum Ratings.....	7	8.3 Feature Description.....	28
6.2 ESD Ratings.....	7	8.4 Device Functional Modes.....	31
6.3 Recommended Operating Conditions.....	8	8.5 Register Maps.....	60
6.4 Thermal Characteristics.....	9	<b>9 Application and Implementation</b> .....	<b>145</b>
6.5 Electrical Characteristics – DCDC1, DCDC2, and DCDC3.....	9	9.1 Application Information.....	145
6.6 Electrical Characteristics – DCDC4.....	11	9.2 Typical Application.....	145
6.7 Electrical Characteristics – LDOs.....	12	<b>10 Layout</b> .....	<b>155</b>
6.8 Electrical Characteristics – Digital Inputs, Digital Outputs.....	15	10.1 Layout Guidelines.....	155
6.9 Electrical Characteristics – V <sub>MON</sub> Voltage Monitor, VDDIO, Undervoltage Lockout (UVLO), and LDOAO.....	15	10.2 Layout Example.....	156
6.10 Electrical Characteristics – Load Switch.....	16	<b>11 Power Supply Recommendations</b> .....	<b>157</b>
6.11 Electrical Characteristics – LED Drivers.....	16	<b>12 Device and Documentation Support</b> .....	<b>158</b>
6.12 Electrical Characteristics – Thermal Monitoring and Shutdown.....	16	12.1 Device Support.....	158
6.13 Electrical Characteristics – 32-kHz RC Clock.....	17	12.2 Documentation Support.....	158
6.14 SPI Timing Requirements.....	17	12.3 Receiving Notification of Documentation Updates.....	158
6.15 I <sup>2</sup> C Interface Timing Requirements.....	17	12.4 サポート・リソース.....	158
6.16 Typical Characteristics.....	19	12.5 Trademarks.....	158
		12.6 Electrostatic Discharge Caution.....	158
		12.7 Glossary.....	159
		<b>13 Mechanical, Packaging, and Orderable Information</b> .....	<b>160</b>

## 4 Revision History

資料番号末尾の英字は改訂を表しています。その改訂履歴は英語版に準じています。

Changes from Revision * (May 2021) to Revision A (June 2021)	Page
• TPS6591287 をプレビューからアクティブに変更.....	1

## 5 Pin Configuration and Functions

Figure 5-1 shows the 81-pin YFF Die-Size Ball-Grid Array pin assignments.

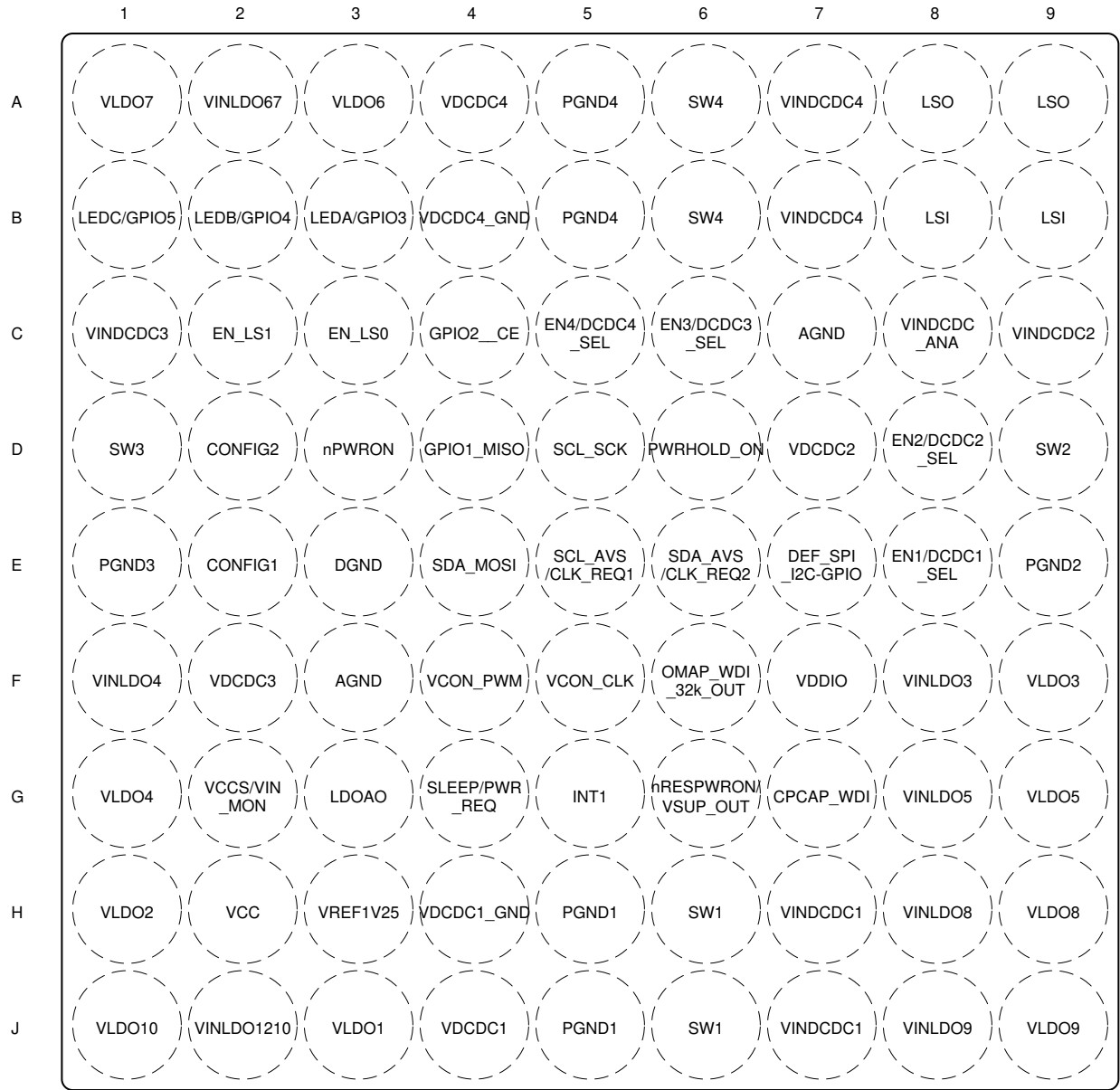

Not to scale

Figure 5-1. 81-Pin YFF DSBGA (Bottom View)

Table 5-1. Pin Functions

PIN			I/O	DESCRIPTION
NAME	ALT NAME	NO.		
<b>REFERENCE</b>				
VREF1V25	—	H3	O	Internal reference voltage. Connect a 100-nF capacitor from this pin to AGND. Do not load this pin externally.
AGND	—	F3, C7	—	Analog-ground (AGND) connection. Connect this pin to the power-ground (PGND) plane on the printed circuit board (PCB).
<b>DRIVERS AND LIGHTING</b>				
LEDA/GPIO3	—	B3	I/O	General-purpose I/O or LED driver output

表 5-1. Pin Functions (continued)

PIN			I/O	DESCRIPTION
NAME	ALT NAME	NO.		
LEDB/GPIO4	—	B2	I/O	General-purpose I/O or LED driver output
LEDC/GPIO5	—	B1	I/O	General-purpose I/O or LED driver output
<b>STEP-DOWN CONVERTERS</b>				
VINDCDC_ANA	—	C8	I	Analog supply input for the DC-DC converters. This pin must be connected to the VINDCDC1, VINDCDC2, VINDCDC3 and VINDCDC4 pins.
VINDCDC1	—	H7, J7	I	Power input to the DCDC1 converter. Connect this pin to the VINDCDC2, VINDCDC3, VINDCDC4, and VINDCDC_ANA pins.
VDCDC1	—	J4	I	Remote positive voltage sense (feedback) input for the DCDC1 converter
VDCDC1_GND	—	H4	I	Remote negative voltage sense (feedback) input for DCDC1. Tie this pin to the GND plane or to the AGND plane. Alternatively, tie this pin to the GND pad of the output capacitor.
SW1	—	H6, J6	O	Switch node of the DCDC1 converter. Connect this pin to the output inductor.
PGND1	—	H5, J5	—	Power GND connection for the DCDC1 converter
VCON_PWM	—	F4	I	Pulse-width modulation (PWM) period signal for dynamic voltage scaling on the DCDC1 converter if using VCON
VCON_CLK	—	F5	I	Clock signal for dynamic voltage scaling on the DCDC1 converter if using VCON
VINDCDC2	—	C9	I	Power input to the DCDC2 converter. Connect this pin to the VINDCDC1, VINDCDC3, VINDCDC4, and VINDCDC_ANA pins.
VDCDC2	—	D7	I	Remote voltage sense (feedback) input for the DCDC2 converter
SW2	—	D9	O	Switch node of the DCDC2 converter. Connect this pin to the output inductor.
PGND2	—	E9	—	Power GND connection for the DCDC2 converter
VINDCDC3	—	C1	I	Power input to the DCDC3 converter. Connect this pin to the VINDCDC1, VINDCDC2, VINDCDC4, and VINDCDC_ANA pins.
VDCDC3	—	F2	I	Remote voltage sense (feedback) input for the DCDC3 converter
SW3	—	D1	O	Switch node of the DCDC3 converter. Connect this pin to the output inductor.
PGND3	—	E1	—	Power GND connection for the DCDC3 converter
VINDCDC4	—	A7, B7	I	Power input to the DCDC4 converter. Connect this pin to the VINDCDC1, VINDCDC2, VINDCDC3, and VINDCDC_ANA pins.
VDCDC4	—	A4	I	Remote positive voltage sense (feedback) input for the DCDC4 converter
VDCDC4_GND	—	B4	I	Remote negative voltage sense (feedback) input the DCDC4 converter. Tie this pin to the GND plane or to the AGND plane. Alternatively, tie this pin to the GND-pad of the output capacitor.
SW4	—	A6, B6	O	Switch node of the DCDC4 converter. Connect this pin to the output inductor.
PGND4	—	A5, B5	—	Power GND connection for the DCDC4 converter
<b>LOAD SWITCH</b>				
LSI	—	B8, B9	I	Input of the load switch
LSO	—	A8, A9	O	Output of the load switch
EN_LS0	—	C3	I	Load switch enable pin. The status of this pin is copied to the ENABLE0 bit in the LOADSWITCH register in the CONFIG state.
EN_LS1	—	C2	I	Load switch enable pin. The status of this pin is copied to the ENABLE1 bit in the LOADSWITCH register in the CONFIG state.
<b>LOW-DROPOUT REGULATORS</b>				
VINLDO1210	—	J2	I	Power input for the LDO1, LDO2, and LDO10 regulators

**表 5-1. Pin Functions (continued)**

PIN			I/O	DESCRIPTION
NAME	ALT NAME	NO.		
VINLDO3	—	F8	I	Power input for the LDO3 regulator
VINLDO4	—	F1	I	Power input for the LDO4 regulator
VINLDO5	—	G8	I	Power input for the LDO5 regulator
VINLDO67	—	A2	I	Power input for the LDO6 and LDO7 regulators
VINLDO8	—	H8	I	Power input for the LDO8 regulator
VINLDO9	—	J8	I	Power input for the LDO9 regulator
LDOAO	—	G3	O	<i>LDO always on</i> internal supply. Connect this pin to the buffer capacitor.
VLDO1	—	J3	O	LDO1 output
VLDO2	—	H1	O	LDO2 output
VLDO3	—	F9	O	LDO3 output
VLDO4	—	G1	O	LDO4 output
VLDO5	—	G9	O	LDO5 output
VLDO6	—	A3	O	LDO6 output
VLDO7	—	A1	O	LDO7 output
VLDO8	—	H9	O	LDO8 output
VLDO9	—	J9	O	LDO9 output
VLDO10	—	J1	O	LDO10 output
<b>STANDARD INTERFACE</b>				
DEF_SPI_I2C-GPIO	—	E7	I	Digital input that defines whether SPI is available or I <sup>2</sup> C and GPIOs are available on the C4, D4, E4, D5 pins. Shorting this pin to GND selects SPI. Shorting this pin to LDOAO selects I <sup>2</sup> C, and GPIO1 and GPIO2
SCL_SCK	SCK	D5	I	I <sup>2</sup> C SCL or SPI SCK based on DEF_SPI_I2C-GPIO
SDA_MOSI	MOSI	E4	I/O	I <sup>2</sup> C SDA or SPI master-out slave-in device (MOSI) based on DEF_SPI_I2C-GPIO
GPIO1_MISO	MISO	D4	I/O	GPIO1 or SPI master-out slave-in device (MISO) based on DEF_SPI_I2C-GPIO
GPIO2_CE	CE	C4	I/O	GPIO2 or SPI chip enable (CE) active high based on DEF_SPI_I2C-GPIO
<b>ENABLE AND VOLTAGE SCALING</b>				
EN1/DCDC1_SEL <sup>(1)</sup>	DCDC1_SEL	E8	I	Enable pin for EN1_SETx assigned resources or voltage-scaling pin that changes the output of a converter or a group of converters between two predefined values
EN2/DCDC2_SEL <sup>(1)</sup>	DCDC2_SEL	D8	I	Enable pin for EN2_SETx assigned resources or voltage-scaling pin that changes the output of a converter or a group of converters between two predefined values
EN3/DCDC3_SEL <sup>(1)</sup>	DCDC3_SEL	C6	I	Enable pin for EN3_SETx assigned resources or voltage-scaling pin that changes the output of a converter or a group of converters between two predefined values
EN4/DCDC4_SEL <sup>(1)</sup>	DCDC4_SEL	C5	I	Enable pin for EN4_SETx assigned resources or voltage-scaling pin that changes the output of a converter or a group of converters between two predefined values
SCL_AVB/CLK_REQ1 <sup>(2)</sup>	CLK_REQ1	E5	I	Clock pin of power I <sup>2</sup> C for dynamic voltage scaling or clock request input signal 1 used to enable and disable power resources using EN2_SETx registers.
SDA_AVB/CLK_REQ2 <sup>(2)</sup>	CLK_REQ2	E6	I/O	Data pin of power I <sup>2</sup> C for dynamic voltage scaling or clock request input signal 2 used to enable and disable power resources using EN3_SETx registers.
SLEEP/PWR_REQ <sup>(2)</sup>	PWR_REQ	G4	I	SLEEP state request input or power request input signal used to enable and disable power resources using EN1_SETx registers.

表 5-1. Pin Functions (continued)

PIN			I/O	DESCRIPTION
NAME	ALT NAME	NO.		
nRESPWRON/VSUP_OUT	VSUP_OUT	G6	O	Active low reset output to disable processor until power-up sequence completes or the output of the input voltage monitor
VCCS/VIN_MON	VIN_MON	G2	I	Voltage sense for input voltage monitoring
PWRHOLD_ON	ON	D6	I	POWERHOLD or ON. This pin is an enable input.
INT1	—	G5	O	Interrupt output
nPWRON	nRESIN (OTP option)	D3	I	Active-low, debounced power-on input or power-request input to start the power-up sequencing. Alternatively, this pin is the active-low reset input to the PMIC that is debounced by 10 ms (OTP option). Tie this pin to the LDOAO pin for a logic high if not used.
OMAP_WDI_32k_OUT	32KCLKOUT	F6	O	Always used as 32KCLKOUT. Leave this pin floating if not using 32KCLKOUT.
CPCAP_WDI	—	G7	—	No connect, leave this pin floating.
CONFIG1	—	E2	I	Selects the predefined startup options and default voltages. Use this pin to choose from two internal OTP settings. Tie this pin to GND or the LDOAO pin.
CONFIG2	—	D2	I	Selects between two device modes. With the CONFIG2 tied to LDOAO, the primary functions of the pins (ENx, SCL_AVS, SDA_AVS, and SLEEP) and SLEEP state is usable. With the CONFIG2 tied to GND, the alternate functions of the pins are used (DCDCx_SEL, CLK_REQx, and PWR_REQ) and SLEEP state is not used.
VCC	—	H2	I	Digital supply input
VDDIO	—	F7	I	Supply voltage input for GPIOs and output stages that sets the high-level voltage (I/O voltage)
DGND	—	E3	–	Digital GND connection. Tie this pin to the AGND and PGNDx on the PCB.

- (1) The DCDCx\_SEL pin function is selected by pulling the CONFIG2 pin to GND which also selects the CLK\_REQx and PWR\_REQ pin functions as enable resources.
- (2) The CLK\_REQ1, CLK\_REQ2, and PWR\_REQ pin functions are selected by pulling the CONFIG2 pin to GND.

## 6 Specifications

### 6.1 Absolute Maximum Ratings

over operating free-air temperature range (unless otherwise noted)<sup>(1)</sup>

		MIN	MAX	UNIT
Voltage	All pins except AGND pins, PGND pins, and pins listed below with respect to AGND	-0.3	6	V
	VLDO1, VLDO2, VLDO3, VLDO4, VLDO5, VLDO6, VLDO7, VLDO8, VLDO9, VLDO10, VINLDO1210, VINLDO3, EN1/DCDC1_SEL, EN2/DCDC2_SEL, EN3/DCDC3_SEL, EN4/DCDC4_SEL, SLEEP/PWR_REQ, CLK_REQ1, CLK_REQ2, VDDIO, CONFIG1, CONFIG2, DEF_SPI_I2C-GPIO, EN_LS0, EN_LS1, OMAP_WDI, CPCAP_WDI, VCON_CLK with respect to AGND	-0.3	3.6	
	VDCDC1, VDCDC2, VDCDC3, VDCDC4 with respect to AGND	-0.3	3.8	
	SDA_SDI, SCL_CLK, GPIO1_MISO, GPIO1_CE, SDA_AVS, SCL_AVS, INT1, 32KCLKOUT, GPIO3 and GPIO4 and GPIO5 if defined as GPIOs with push-pull output (otherwise it is 6-V rated), nRESPWRON if nRESPWRON is push-pull output (otherwise it is 6-V rated) with respect to AGND	-0.3	VDDIO + 0.3	
	V <sub>CC</sub>	VDDIO	6	
Current	All non-power pins		5	mA
	Power pins (per pin)		2	A
Operating free-air temperature, T <sub>A</sub>		-40	85	°C
Maximum junction temperature, T <sub>J</sub>			125	°C
Storage temperature, T <sub>stg</sub>		-65	150	°C

- (1) Stresses beyond those listed under *Absolute Maximum Ratings* may cause permanent damage to the device. These are stress ratings only and functional operation of the device at these or any other conditions beyond those indicated under *Recommended Operating Conditions* (セクション 6.3) is not implied. Exposure to absolute-maximum-rated conditions for extended periods may affect device reliability.

### 6.2 ESD Ratings

		VALUE	UNIT	
V <sub>ESD</sub>	Electrostatic discharge	Human body model (HBM), per ANSI/ESDA/JEDEC JS001 <sup>(1)</sup>	1000	V
		Charged device model (CDM), per JESD22-C101 <sup>(2)</sup>	250	V

- (1) JEDEC document JEP155 states that 500-V HBM allows safe manufacturing with a standard ESD control process.  
 (2) JEDEC document JEP157 states that 250-V CDM allows safe manufacturing with a standard ESD control process.

### 6.3 Recommended Operating Conditions

over operating free-air temperature range (unless otherwise noted)

		MIN	NOM	MAX	UNIT
<b>DC-DC CONVERTERS</b>					
VIN1, VIN2, VIN3, VIN4	Input voltage for step-down converter DCDC1, DCDC2, DCDC3, DCDC4	2.7		5.5	V
	Output voltage for step-down converter DCDC1, DCDC2, DCDC3, DCDC4 <sup>(1)</sup>	0.5		3.8	V
	Inductance at L1, L2, L3, L4	0.5	1	1.3	μH
C <sub>IN1</sub> , C <sub>IN4</sub>	Input capacitance at VIN1 and VIN4 (on each pin)	10	22		μF
C <sub>IN2</sub> , C <sub>IN3</sub>	Input capacitance at VIN2 and VIN3 (on each pin)	4.7	10		μF
C <sub>OUTDCDC1,2,3</sub>	Output capacitance at DCDC1, DCDC2 and DCDC3	4.7	10	22	μF
C <sub>OUTDCDC4</sub>	Output capacitance at DCDC4	10	22	47	μF
<b>LDOs</b>					
VINLDO1210	Input voltage for LDO1, LDO2 and LDO10	1.7		3.6	V
VINLDO4	Input voltage for LDO4	1.9		5.5	V
VINLDO5	Input voltage for LDO5	1.9		5.5	V
V <sub>LDO1</sub> , V <sub>LDO2</sub> , V <sub>LDO3</sub> , V <sub>LDO6</sub> , V <sub>LDO7</sub> , V <sub>LDO8</sub> , V <sub>LDO9</sub> , V <sub>LDO10</sub>	Output voltage for general purpose (GP) LDOs <sup>(1)</sup>	0.8		3.3	V
V <sub>LDO4</sub> , V <sub>LDO5</sub>	Output voltage for RF-LDOs	1.6		3.3	V
C <sub>INLDO1210</sub> , C <sub>INLDO3</sub> , C <sub>INLDO4</sub> , C <sub>INLDO5</sub> , C <sub>INLDO67</sub> , C <sub>INLDO8</sub> , C <sub>INLDO8</sub>	Input capacitance on LDO supply pins	0.5			μF
C <sub>OUTDO4</sub> , C <sub>OUTDO5</sub>	Output capacitance on LDO4 and LDO5	2.2		10	μF
C <sub>OUTLDO1</sub> , C <sub>OUTLDO2</sub> , C <sub>OUTLDO3</sub> , C <sub>OUTLDO6</sub> , C <sub>OUTLDO7</sub> , C <sub>OUTLDO8</sub>	Output capacitance LDO1, LDO2, LDO3, LDO6, LDO7, LDO8 These LDOs are <i>capless</i> , the required capacitance can be placed at the load	0.5		10	μF
C <sub>OUTLDO9</sub> , C <sub>OUTLDO10</sub>	Output capacitance LDO9 and LDO10 These LDOs are <i>capless</i> , the required capacitance can be placed at the load	1		10	μF
C <sub>OUTLDOAO</sub>	Output capacitance on LDOAO	0.5		10	μF
C <sub>VINDCDC_ANA</sub>	Input capacitance on VINDCDC_ANA	100			nF
C <sub>VCC</sub>	Input capacitance on VCC	100			nF
C <sub>VDDIO</sub>	Input capacitance on VDDIO	100			nF
C <sub>VREF</sub>	Output capacitance on VREF1V25	100			nF
T <sub>A</sub>	Operating ambient temperature	-40		85	°C
T <sub>J</sub>	Operating junction temperature	-40		125	°C

- (1) The maximum output voltage of DCDC1 to DCDC4 and LDO1 to LDO4 can be reduced by an OTP setting to adopt the maximum voltage to the requirements (or maximum ratings) of the load powered. This setting helps protect the processor from exceeding the maximum ratings for the core voltage. The value is set in nonvolatile memory (OTP) by TI upon customer request with sufficient business case.



## 6.4 Thermal Characteristics

THERMAL METRIC <sup>(1)</sup>		TPS659128	
		YFF (DSBGA)	
		81 PINS	
			UNIT
R <sub>θJA</sub>	Junction-to-ambient thermal resistance	41.3	°C/W
R <sub>θJctop</sub>	Junction-to-case (top) thermal resistance	0.1	°C/W
R <sub>θJB</sub>	Junction-to-board thermal resistance	5.2	°C/W
ψ <sub>JT</sub>	Junction-to-top characterization parameter	0.7	°C/W
ψ <sub>JB</sub>	Junction-to-board characterization parameter	5.2	°C/W

(1) For more information about traditional and new thermal metrics, see [Semiconductor and IC Package Thermal Metrics application report](#).

## 6.5 Electrical Characteristics – DCDC1, DCDC2, and DCDC3

–40°C ≤ T<sub>A</sub> ≤ 85°C, typical values are at T<sub>A</sub> = 25°C (unless otherwise noted)

PARAMETER	TEST CONDITION	MIN	TYP	MAX	UNIT
V <sub>IN</sub>	Input voltage range	2.3		5.5	V
V <sub>DCDC1</sub> V <sub>DCDC2</sub> V <sub>DCDC3</sub>	Option1; in 12.5-mV steps; RANGE[1:0] = 00b	0.5		1.2875	V
	Option2; in 12.5-mV steps; RANGE[1:0] = 01b	0.7		1.4875	V
	Option3; in 25-mV steps; RANGE[1:0] = 10b	0.5		2.075	V
	Option4; in 50-mV steps; RANGE[1:0] = 11b	0.5		3.80	V
I <sub>OUT(DCDCx)</sub>	DCDC1 (VINDCDC1 ≥ 2.8 V)			2500	mA
	DCDC2 (VINDCDC2 ≥ 2.8 V)			750	
	DCDC3 (VINDCDC3 ≥ 2.8 V)			1200	
	DCDC3 for 2.8 V ≤ V <sub>IN</sub> ≤ 4.5 V; VDCDC3(max) = 1.4875 V			1600	
I <sub>Q</sub>	I <sub>LOAD</sub> = 0 mA, DCDCx_MODE = 0b, Device not switching, for DCDC1		26	55	μA
	I <sub>LOAD</sub> = 0 mA, DCDCx_MODE = 1b, Device switching, for DCDC1		8		mA
	I <sub>LOAD</sub> < 1 mA, Device not switching, ECO = 1b AND DCDCx_MODE = 0b, for DCDC1		9		μA
	I <sub>LOAD</sub> = 0 mA, DCDCx_MODE = 0b, Device not switching, for DCDC2 or DCDC3		26	40	μA
	I <sub>LOAD</sub> = 0 mA, DCDCx_MODE = 1b, Device switching, for DCDC2 or DCDC3		8		mA
	I <sub>LOAD</sub> < 1 mA, Device not switching; ECO = 1b AND DCDCx_MODE = 0b, for DCDC2 or DCDC3		3		μA

## 6.5 Electrical Characteristics – DCDC1, DCDC2, and DCDC3 (continued)

–40°C ≤ T<sub>A</sub> ≤ 85°C, typical values are at T<sub>A</sub> = 25°C (unless otherwise noted)

PARAMETER		TEST CONDITION	MIN	TYP	MAX	UNIT	
V <sub>DCDC1/2/3</sub>	Accuracy	DCDCx_MODE = 1b, VINDCDCx = 3.6 V, I <sub>LOAD</sub> = 0 mA, T <sub>A</sub> = 25°C, ECO = 0	–2%				
		DCDCx_MODE = 1b, VINDCDCx = 3.6 V, I <sub>LOAD</sub> = 0 mA, –40°C ≤ T <sub>A</sub> ≤ 85°C, ECO = 0	–2.5%				
		DCDCx_MODE = 0b, VINDCDCx = 3.6 V, I <sub>LOAD</sub> = 0 mA, T <sub>A</sub> = 25°C, ECO = 0	–3%				
	ECO mode accuracy	VINDCDCx = 3.6 V, I <sub>LOAD</sub> = 0 mA, –40°C ≤ T <sub>A</sub> ≤ 85°C; ECO = 1b AND DCDCx_MODE = 0b	–5%		5%		
	Load regulation	DCDCx_MODE = 1b, VINDCDCx = 3.6 V, 120 mA ≤ I <sub>LOAD</sub> ≤ 1080 mA, for DCDC1			0.01		%A
		DCDCx_MODE = 1b, VINDCDCx = 3.6 V, 120 mA ≤ I <sub>LOAD</sub> ≤ to 1080 mA, for DCDC3			0.01		
		DCDCx_MODE = 1b, VINDCDCx = 3.6 V, 50 mA ≤ I <sub>LOAD</sub> ≤ 450 mA, for DCDC2			0.01		
	Line regulation	DCDCx_MODE = 1b, 2.5 V ≤ VINDCDCx ≤ 5.5 V, I <sub>LOAD</sub> = 0 mA, for DCDC1			0.01		%V
DCDCx_MODE = 1b, 2.5 V ≤ VINDCDCx ≤ 5.5 V, I <sub>LOAD</sub> = 0 mA, for DCDC2 or DCDC3				0.01			
f <sub>sw</sub>	Switching frequency	DCDCx_MODE = 0b			3500	kHz	
		DCDCx_MODE = 1b, VINDCDCx = 3.6 V, VDCDCx = 1.8 V		2800		kHz	
R <sub>DS(ON)</sub>	High-side FET on-resistance	for DCDC1 with VINDCDCx = 3.6 V, D = 100%		60	100	mΩ	
		for DCDC2 and DCDC3 with VINDCDCx = 3.6 V, D = 100%		120	190	mΩ	
R <sub>DS(ON)</sub>	Low-side FET on-resistance	for DCDC1 with VINDCDCx = 3.6 V, D = 100%		60	100	mΩ	
		for DCDC2 and DCDC3 with VINDCDCx = 3.6 V, D = 100%		100	160	mΩ	
I <sub>LK_HS</sub>	High-side FET leakage current	T <sub>J</sub> = 85°C, DCDC1, VINDCDC1 = 4.2 V			20	μA	
		T <sub>J</sub> = 85°C, DCDC2 or DCDC3, VINDCDC2 = VINDCDC3 = 4.2 V			3		
I <sub>LK_LS</sub>	Low-side FET leakage current	T <sub>J</sub> = 85°C, DCDC1, VINDCDC1 = 4.2 V			20	μA	
		T <sub>J</sub> = 85°C, DCDC2 or DCDC3, VINDCDC2 = VINDCDC3 = 4.2 V			1		
I <sub>HS_LIMF</sub>	High-side forward current limit	VINDCDC1 = 3.6 V, DCDC1	3200	4280	5300	mA	
		VINDCDC2 = 3.6 V, DCDC2	1250	1667	2083		
		VINDCDC3 = 3.6 V, DCDC3	2100	2800	3500		
I <sub>LS_LIMF</sub>	Low-side forward current limit	VINDCDC1 = 3.6 V, DCDC1	3200	4280	5300	mA	
		VINDCDC2 = 3.6 V, DCDC2	1200	1600	2000		
		VINDCDC3 = 3.6 V, DCDC3	1875	2500	3125		
t <sub>OFF(MIN)</sub>	Minimum high-side FET off time	VINDCDCx = 3.6 V		30		ns	
V <sub>DCDCPG</sub>	Power-good threshold	VDCDCx falling	86%	90%	94%		
		VDCDCx rising			98%		
t <sub>DCDCPG</sub>	Power-good threshold deglitch time			1		ms	
t <sub>Start</sub>	Start-up time	Time to start switching, measured from end of I <sup>2</sup> C command enabling converter	32	55	100	μs	
t <sub>Ramp</sub>	V <sub>OUT</sub> ramp up time	Time to ramp from 5% to 95% of VDCDCx	100	160	250	μs	
R <sub>Discharge</sub>	Discharge resistor		250	400	500	Ω	

## 6.5 Electrical Characteristics – DCDC1, DCDC2, and DCDC3 (continued)

–40°C ≤ T<sub>A</sub> ≤ 85°C, typical values are at T<sub>A</sub> = 25°C (unless otherwise noted)

PARAMETER		TEST CONDITION	MIN	TYP	MAX	UNIT
T <sub>pwm</sub>	PWM clock period for VCON_CLK		30		300	ns
T <sub>su</sub>	VCON setup time	VCON_PWM to rising edge of VCON_CLK			7	ns
T <sub>hd</sub>	VCON hold time	VCON_PWM from rising edge of VCON_CLK			7	ns

## 6.6 Electrical Characteristics – DCDC4

–40°C ≤ T<sub>A</sub> ≤ 85°C, typical values are at T<sub>A</sub> = 25°C (unless otherwise noted)

PARAMETER		TEST CONDITIONS	MIN	TYP	MAX	UNIT
V <sub>IN</sub>	Input voltage range		2.3		5.5	V
V <sub>DCDC4</sub>	DCDC4 output voltage range	Option1, in 12.5-mV steps, RANGE[1:0] = 00b	0.5		1.2875	V
		Option2, in 12.5-mV steps, RANGE[1:0] = 01b	0.7		1.4875	
		Option3, in 25-mV steps, RANGE[1:0] = 10b	0.5		2.075	
		Option4, in 50-mV steps, RANGE[1:0] = 11b	0.5		3.80	
I <sub>OUT(DCDC4)</sub>	Continuous output current	DCDC4 (VINDCDC4 ≥ 2.8 V)			2500	mA
I <sub>Q</sub>	Quiescent current	I <sub>LOAD</sub> = 0 mA, DCDC4_MODE = 0b, Device not switching		26	55	μA
		I <sub>LOAD</sub> = 0 mA, DCDC4_MODE = 1b, Device switching, EN_LS[1:0] = 00 or 01		8		mA
		I <sub>LOAD</sub> < 1 mA, Device not switching, ECO = 1b AND DCDC4_MODE = 0b		9		μA
V <sub>DCDCx</sub>	Accuracy	DCDC4_MODE = 1b, VINDCDC4 = 3.6 V, I <sub>LOAD</sub> = 0 mA, T <sub>A</sub> = 25°C, EN_LS[1:0] = 00b or 01b	–2%		2%	
		DCDC4_MODE = 1b, VINDCDC4 = 3.6 V, I <sub>LOAD</sub> = 0 mA, –40°C ≤ T <sub>A</sub> ≤ 85°C, EN_LS[1:0] = 00b or 01b	–2.5%		2.5%	
		DCDC4_MODE = 0b, VINDCDC4 = 3.6 V, I <sub>LOAD</sub> = 0 mA, T <sub>A</sub> = 25°C	–3%		3%	
		DCDC4_MODE = 0b, VINDCDC4 = 3.6 V, I <sub>LOAD</sub> = 0 mA, –40°C ≤ T <sub>A</sub> ≤ 85°C	–3%		3%	
	ECO mode accuracy	ECO = 1b AND DCDCx_MODE = 0b, VINDCDC4 = 3.6 V, I <sub>LOAD</sub> = 0 mA, –40°C ≤ T <sub>A</sub> ≤ 85°C	–5%		5%	
	Line regulation	DCDC4_MODE = 1b, VINDCDC4 = 3.6 V, EN_LS[1:0] = 00b or 01b, 250 mA ≤ I <sub>LOAD</sub> ≤ 2250 mA		0.01		%/A
	Line regulation	DCDC4_MODE = 1b, 2.5 V ≤ VINDCDC4 ≤ 5.5 V, I <sub>LOAD</sub> = 0 mA, EN_LS[1:0] = 00b or 01b		0.01		%/V
f <sub>sw</sub>	Switching frequency	DCDC4_MODE = 0b			3500	kHz
		DCDC4_MODE = 1b, VINDCDC4 = 3.6 V, VDCDC4 = 1.8 V, EN_LS[1:0] = 00b or 01b		2800		kHz
R <sub>DS(ON)</sub>	High-side MOSFET on-resistance	VINDCDC4 = 3.6 V, 100% duty cycle		60	100	mΩ
	Low-side MOSFET on-resistance	VINDCDC4 = 3.6 V, 0% duty cycle		60	100	mΩ
I <sub>LK_HS</sub>	High-side leakage current	T <sub>J</sub> = 85°C, VINDCDC4 = 4.2 V			20	μA
I <sub>LK_LS</sub>	Low-side leakage current	T <sub>J</sub> = 85°C, VINDCDC4 = 4.2 V			20	μA
I <sub>LIM</sub>	High-side current limit	2.9 V ≤ VINDCDC4 ≤ 5.5 V	3000	4400	5000	mA
I <sub>LIM</sub>	Low-side current limit	2.9 V ≤ VINDCDC4 ≤ 5.5 V	3000	3700	4300	mA
t <sub>OFF(MIN)</sub>	Minimum high-side FET off time	VINDCDC4 = 3.6 V		30		ns
V <sub>DCDCPG</sub>	Power good threshold	VDCDC4 falling	86%	90%	94%	
		VDCDC4 rising			98%	

## 6.6 Electrical Characteristics – DCDC4 (continued)

–40°C ≤ T<sub>A</sub> ≤ 85°C, typical values are at T<sub>A</sub> = 25°C (unless otherwise noted)

PARAMETER		TEST CONDITIONS	MIN	TYP	MAX	UNIT
t <sub>DCDCPG</sub>	Power good deglitch time			1		ms
t <sub>Start</sub>	Start-up time	RAMP_TIME = 0b, Time to start switching, measured from end of I <sup>2</sup> C command enabling converter	32	55	100	μs
		RAMP_TIME = 1b, Time to start switching, measured from end of I <sup>2</sup> C command enabling converter	4	7	14	
t <sub>Ramp</sub>	V <sub>OUT</sub> ramp-up time	RAMP_TIME = 0b, Time to ramp from 5% to 95% of VDCDC4, VDCDC4 = 3.4 V	106	160	250	μs
		RAMP_TIME = 1b, Time to ramp from 5% to 95% of VDCDC4, VDCDC4 = 3.4 V	25	40	66	
R <sub>Discharge</sub>	Discharge resistor		250	400	500	Ω
V <sub>byp-on</sub>	Bypass mode turnon duty cycle	For ENABLE[1:0] = 10b, turnon is based on the duty cycle of the PWM signal of DCDC4	90%	97.5%	99.5%	
V <sub>byp-off</sub>	Bypass mode turnoff output voltage threshold	For ENABLE[1:0] = 10b, turnoff is based on output voltage above the nominal value	8%	12%	15%	

## 6.7 Electrical Characteristics – LDOs

–40°C ≤ T<sub>A</sub> ≤ 85°C, typical values are at T<sub>A</sub> = 25°C (unless otherwise noted)

PARAMETER		TEST CONDITION	MIN	TYP	MAX	UNIT
V <sub>IN</sub>	Input voltage	LDO1	1.7		3.6	V
		LDO2	1.7		3.6	
		LDO3	1.7		3.6	
		LDO4	1.9		5.5	
		LDO5	1.9		5.5	
		LDO6	1.8		5.5	
		LDO7	1.8		5.5	
		LDO8	1.8		5.5	
		LDO9	1.8		5.5	
		LDO10	1.7		3.6	
V <sub>LDOx</sub>	LDO output voltage for general-purpose LDOs <sup>(1)</sup>		0.8		3.3	V
	LDO output voltage for RF_LDOs		1.6		3.3	V
	LDO voltage accuracy	ECO = 0b	–2%		2.5%	
ECO = 1b		–5%		5%		
I <sub>OUT(LDOx)</sub>	LDO continuous output current	LDO1	100			mA
		LDO2	100			
		LDO3	100			
		LDO4	250			
		LDO5	250			
		LDO6	100			
		LDO7	300			
		LDO8	100			
		LDO9	300			
		LDO10	300			

## 6.7 Electrical Characteristics – LDOs (continued)

–40°C ≤ T<sub>A</sub> ≤ 85°C, typical values are at T<sub>A</sub> = 25°C (unless otherwise noted)

PARAMETER		TEST CONDITION	MIN	TYP	MAX	UNIT
I <sub>SHORT(LDOx)</sub> LDO current limit		LDO1, LDO2, LDO3, LDO6, LDO8	100		420	mA
		LDO4, LDO5	250		650	
		LDO7	300		750	
		LDO9, LDO10	300		750	
V <sub>DO(LDOx)</sub> Dropout voltage <sup>(2)</sup>		I <sub>OUT(LDO1)</sub> = 50 mA, VINLDO1 = 1.7 V			500	mV
		I <sub>OUT(LDO2)</sub> = 100 mA, VINLDO2 = 1.7 V			500	
		I <sub>OUT(LDO3)</sub> = 80 mA, VINLDO3 = 1.5 V			200	
		I <sub>OUT(LDO4)</sub> = 200 mA, VINLDO4 = 2.0 V			200	
		I <sub>OUT(LDO5)</sub> = 200 mA, VINLDO5 = 3.0 V			300	
		I <sub>OUT(LDO6)</sub> = 100 mA, VINLDO6 = 3.2 V			200	
		I <sub>OUT(LDO7)</sub> = 200 mA, VINLDO7 = 3.2 V			200	
		I <sub>OUT(LDO8)</sub> = 100 mA, VINLDO8 = 2.9 V			200	
		I <sub>OUT(LDO9)</sub> = 300 mA (LDO9), VINLDO9 = 3.1 V			200	
		I <sub>OUT(LDO10)</sub> = 300 mA (LDO10), VINLDO10 = 2 V			200	
Line regulation		V <sub>IN</sub> = V <sub>LDO</sub> + 0.5 V and I <sub>LOAD</sub> = 50 mA	–1%		1%	
Load regulation;		LDO1, LDO2, LDO3, LDO6, LDO8: ECO = 0b, 1 mA ≤ I <sub>LOAD</sub> ≤ 100 mA	–0.5%		0.5%	
		LDO5, LDO7: ECO = 0b, 1 mA ≤ I <sub>LOAD</sub> ≤ 200 mA	–1%		1%	
		LDO4, LDO9, LDO10: ECO = 0b, 1 mA ≤ I <sub>LOAD</sub> ≤ 300 mA	–1.5%		1.5%	
		LDO1 to LDO10: ECO = 1b, 0 mA ≤ I <sub>LOAD</sub> ≤ 1 mA	–5%		5%	
Line transient response		dV/dt = ±0.5 V/μs	–50		50	mV
Load transient response		dI/dt = 100 mA/μs, 10% to 90% load step	–110		110	mV
PSRR	Power supply rejection ratio	LDO1 to LDO3 and LDO6 to LDO10: 10 Hz ≤ f ≤ 1 kHz, VINLDOx – VLDOx ≥ 0.5 V, 10 mA ≤ I <sub>LOAD</sub> ≤ 0.75 × I <sub>LOAD(MAX)</sub>	47			dB
		LDO4 and LDO5: 10 Hz ≤ f ≤ 1 kHz, VINLDOx – VLDOx ≥ 0.5 V, 10 mA ≤ I <sub>LOAD</sub> ≤ 0.75 × I <sub>LOAD(MAX)</sub>	63			
Output voltage noise		LDO1 to LDO3 and LDO6 to LDO10: 10 Hz ≤ f ≤ 100 kHz, VINLDOx – VLDOx ≥ 0.5 V, I <sub>LOAD</sub> ≥ 10 mA		150		μVrms
		LDO1 to LDO3 and LDO6 to LDO10: 10 Hz ≤ f ≤ 10 kHz, VINLDOx – VLDOx ≥ 0.5 V, I <sub>LOAD</sub> ≥ 10 mA		50		
		LDO4 and LDO5: 10 Hz ≤ f ≤ 100 kHz, VINLDOx – VLDOx ≥ 0.5 V, I <sub>LOAD</sub> ≥ 10 mA		30		
		LDO4 and LDO5: 10 Hz ≤ f ≤ 10 kHz, VINLDOx – VLDOx ≥ 0.5 V, I <sub>LOAD</sub> ≥ 10 mA		15		
I <sub>q</sub>	Quiescent current	ECO = 1b, I <sub>LOAD</sub> ≤ 1 mA for LDO1, LDO2, LDO3, LDO6, LDO7, LDO8, LDO9, LDO10			8	μA
		ECO = 1b, I <sub>LOAD</sub> ≤ 1 mA for LDO4, LDO5			16	
		ECO = 0b, I <sub>LOAD</sub> ≤ 1 mA for LDO1, LDO2, LDO3, LDO6, LDO7, LDO8, LDO9, LDO10			32	
		ECO = 0b, I <sub>LOAD</sub> ≤ 1 mA for LDO4, LDO5			40	
ECO exit time		Minimum wait time before the full current can be drawn after ECO is set 0b			50	μs
t <sub>Ramp</sub>	V <sub>OUT</sub> ramp-up time	Time to ramp from 5% to 95% of VLDOx, I <sub>OUT</sub> = 100 mA			170	μs
V <sub>LDOPG</sub>	PG trigger	VLDOx ≤ V <sub>TARGET</sub> , VLDOx falling	87%	90.6%	94.5%	
		VLDOx rising			98%	
t <sub>LDOPG</sub>	Power good deglitch time			1		ms

## 6.7 Electrical Characteristics – LDOs (continued)

$-40^{\circ}\text{C} \leq T_A \leq 85^{\circ}\text{C}$ , typical values are at  $T_A = 25^{\circ}\text{C}$  (unless otherwise noted)

PARAMETER		TEST CONDITION	MIN	TYP	MAX	UNIT
$R_{\text{Discharge}}$	Discharge resistance at LDO output	LDO disabled	200	325	450	$\Omega$

- (1) LDO Output voltages are programmed separately
- (2)  $V_{\text{DO}} = V_{\text{IN}} - V_{\text{OUT}}$ , where  $V_{\text{OUT}} = V_{\text{OUT(NOM)}} - 2\%$

## 6.8 Electrical Characteristics – Digital Inputs, Digital Outputs

–40°C ≤ T<sub>A</sub> ≤ 85°C, typical values are at T<sub>A</sub> = 25°C (unless otherwise noted)

PARAMETER	TEST CONDITIONS	MIN	MAX	UNIT
V <sub>IL</sub>	Low-level input voltage	0	0.4	V
V <sub>IH</sub>	High-level input voltage	1.1	V <sub>CC</sub>	V
	All pins except digital interfaces and configuration pins listed below	1.1	V <sub>CC</sub>	
	For CONFIG1, CONFIG2, DEF_SPI_I2C-GPIO, EN_LS0, EN_LS1, EN1/DCDC1_SEL, EN2/DCDC2_SEL, EN3/DCDC3_SEL, EN4/DCDC4_SEL, SLEEP/PWR_REQ, CPCAP_WDI, VCON_CLK, CLK_REQ1, CLK_REQ2	1.1	3.3	
	For SDA, SCL, SDA_AVS, SCL_AVS	0.7 × VDDIO	VDDIO	
V <sub>OL</sub>	Low-level output voltage	0	0.2	V
	I <sub>OL</sub> = 1 mA, except SDA, SCL, SDA_AVS, SCL_AVS	0	0.2 × VDDIO	
	I <sub>OL</sub> = 3 mA, for SDA, SCL, SDA_AVS, SCL_AVS, for VDDIO = 1.8 V	0	0.4	
V <sub>OH</sub>	High-level output voltage	VDDIO – 0.2	VDDIO	V
	For pins configured as push-pull output to VDDIO, I <sub>OH</sub> = 1 mA		V <sub>CC</sub>	
I <sub>OL</sub>	Low-level output current		1	mA
	Except SCL, SDA, AVS_SCL, AVS_SDA		5	
I <sub>OH</sub>	High-level output current		1	mA
I <sub>LKG</sub>	Input-leakage current		0.5	µA
	Input pins tied to V <sub>IL</sub> or V <sub>IH</sub>			

## 6.9 Electrical Characteristics – VMON Voltage Monitor, VDDIO, Undervoltage Lockout (UVLO), and LDOAO

–40°C ≤ T<sub>A</sub> ≤ 85°C, typical values are at T<sub>A</sub> = 25°C (unless otherwise noted)

PARAMETER	TEST CONDITIONS	MIN	TYP	MAX	UNIT
VMON	Voltage monitor threshold for VMON_SEL[1:0] = 00b, rising voltage	–2%	3.1	2%	V
	Voltage monitor threshold for VMON_SEL[1:0] = 01b, rising voltage	–2%	2.9	2%	V
	Voltage monitor threshold for VMON_SEL[1:0] = 10b, rising voltage	–2%	2.8	2%	V
	Voltage monitor threshold for VMON_SEL[1:0] = 11b, rising voltage	–2%	2.7	2%	V
VMON hysteresis	For falling voltage		250		mV
VDDIO voltage range	Voltage applied to VDDIO pin to set the high level voltage of push-pull output stages	1.63		3.6	V
VDDIO undervoltage lockout (UVLO) threshold		1.4		1.625	V
UVLO	Internal undervoltage lockout threshold (supply voltage rising)		2.5		V
	Internal UVLO threshold hysteresis		200		mV
VLDOAO	Output voltage for LDOAO (LDO always on)		2.5		V

## 6.10 Electrical Characteristics – Load Switch

–40°C ≤ T<sub>A</sub> ≤ 85°C, typical values are at T<sub>A</sub> = 25°C (unless otherwise noted)

PARAMETER	TEST CONDITIONS	MIN	TYP	MAX	UNIT
Voltage between LSI and LSO				5.5	V
LSI input current limit	ILIM[1:0] = 00b, 2.7 V ≤ V <sub>(LSI)</sub> ≤ 5.5 V	75	90	115	mA
	ILIM[1:0] = 00b, 4.5 V ≤ V <sub>(LSI)</sub> ≤ 5.5 V, –10°C ≤ T <sub>A</sub> ≤ 85°C	85	90	100	mA
	ILIM[1:0] = 01b, 2.7 V ≤ V <sub>(LSI)</sub> ≤ 5.5 V	450	485	520	mA
	ILIM[1:0] = 01b, V(LSI) = 4.5 V ≤ V <sub>(LSI)</sub> ≤ 5.5 V, –10°C ≤ T <sub>A</sub> ≤ 85°C	460	485	500	mA
	ILIM[1:0] = 10b, 2.7 V ≤ V <sub>(LSI)</sub> ≤ 5.5 V	720	820	920	mA
	ILIM[1:0] = 10b, 2.7 V ≤ V <sub>(LSI)</sub> ≤ 5.5 V, –10°C ≤ T <sub>A</sub> ≤ 85°C	750	820	900	mA
	ILIM[1:0] = 11b, 2.7 V ≤ V <sub>(LSI)</sub> ≤ 5.5 V, not tested in production	2000	2500	3000	mA
Current-limit response time			10		μs
Resistance from LSI to LSO	When switch closed and operated as load switch with ILIM[1:0] = 11b		20	40	mΩ
Resistance from LSI to LSO	When switch closed and operated as load switch with ILIM[1:0] = 00b or 01b or 10b			200	mΩ
Leakage current from LSI to LSO	When load switch is open			20	μA
Load switch over-voltage protection on the output (sensed at VDCC4)	For EN_LS[1:0] = 10b or 11b, when load switch is used as BYPASS switch		4.18		V

## 6.11 Electrical Characteristics – LED Drivers

–40°C ≤ T<sub>A</sub> ≤ 85°C, typical values are at T<sub>A</sub> = 25°C (unless otherwise noted)

PARAMETER	TEST CONDITIONS	MIN	TYP	MAX	UNIT
I <sub>SINK(LEDx)</sub>	LEDx output sink current V <sub>(LEDA)</sub> = V <sub>(LEDB)</sub> = V <sub>(LEDC)</sub> = 0.25 V		2	20	mA
	Accuracy		–8%	9.5%	
V <sub>LO(LEDx)</sub>	Low-level output voltage Output low voltage at LEDx pins, 20 mA			0.25	V
I <sub>LKG(LEDx)</sub>	Output off leakage current Output voltage = 5 V, driver set to OFF			1	μA

## 6.12 Electrical Characteristics – Thermal Monitoring and Shutdown

–40°C ≤ T<sub>A</sub> ≤ 85°C, typical values are at T<sub>A</sub> = 25°C (unless otherwise noted)

PARAMETER	TEST CONDITIONS	MIN	TYP	MAX	UNIT
Hot-die temperature rising threshold	THERM_HDSEL[1:0] = 00b	113	117	136	°C
	THERM_HDSEL[1:0] = 01b	113	121		
	THERM_HDSEL[1:0] = 10b	113	125		
	THERM_HDSEL[1:0] = 11b	113	130	136	
Hot-die temperature hysteresis			10		°C
Thermal shutdown temperature rising threshold		136	148	160	°C
Thermal shutdown temperature hysteresis			10		°C
Ground current	Device in ACTIVE state, T <sub>A</sub> = 27°C, V <sub>CCS</sub> = 3.8 V		6		μA



### 6.13 Electrical Characteristics – 32-kHz RC Clock

–40°C ≤ T<sub>A</sub> ≤ 85°C, typical values are at T<sub>A</sub> = 25°C (unless otherwise noted)

PARAMETER	TEST CONDITIONS	MIN	TYP	MAX	UNIT
32KCLKOUT rise and fall time	C <sub>L</sub> = 35 pF			10	ns
Output-frequency low-level output voltage	32KCLKOUT output		32		kHz
Output-frequency accuracy	T <sub>A</sub> = 25°C	–20%	0%	15%	
Output duty cycle		40%	50%	60%	
Settling time				150	μs

### 6.14 SPI Timing Requirements

For the SPI timing diagram, see [Figure 7-3](#).

		MIN	MAX	UNIT
t <sub>cesu</sub>	Chip select setup time	30		ns
t <sub>cehld</sub>	Chip select hold time	30		ns
t <sub>ckper</sub>	Clock cycle time	65		ns
t <sub>ckhigh</sub>	Clock high typical pulse duration	20		ns
t <sub>cklow</sub>	Clock low typical pulse duration	20		ns
t <sub>sisu</sub>	Input data setup time, before clock active edge	5		ns
t <sub>sihld</sub>	Input data hold time, after clock active edge	5		ns
t <sub>dr</sub>	Data retention time		15	ns
t <sub>CE</sub>	Time from CE going low to CE going high	65		ns
	Capacitive load on pin GPIO1_MISO		30	pF

### 6.15 I<sup>2</sup>C Interface Timing Requirements

Specified by design. Not tested in production. For the high-speed mode timing diagram, see [Figure 7-2](#).

		MIN	MAX	UNIT
f <sub>(SCL)</sub>	SCL clock frequency	Standard mode	100	kHz
		Fast mode	400	kHz
		High-speed mode (write operation), C <sub>B</sub> – 100 pF maximum	3.4	MHz
		High-speed mode (read operation), C <sub>B</sub> – 100 pF maximum	3.4	MHz
		High-speed mode (write operation), C <sub>B</sub> – 400 pF maximum	1.7	MHz
		High-speed mode (read operation), C <sub>B</sub> – 400 pF maximum	1.7	MHz
t <sub>BUF</sub>	Bus free time between a STOP and START condition	Standard mode	4.7	μs
		Fast mode	1.3	μs
t <sub>HD</sub> , t <sub>STA</sub>	Hold time (repeated) START condition	Standard mode	4	μs
		Fast mode	600	ns
		High-speed mode	160	ns
t <sub>LOW</sub>	LOW period of the SCL clock	Standard mode	4.7	μs
		Fast mode	1.3	μs
		High-speed mode, C <sub>B</sub> – 100 pF maximum	160	ns
		High-speed mode, C <sub>B</sub> – 400 pF maximum	320	ns

## 6.15 I<sup>2</sup>C Interface Timing Requirements (continued)

Specified by design. Not tested in production. For the high-speed mode timing diagram, see [Figure 7-2](#).

		MIN	MAX	UNIT	
t <sub>HIGH</sub>	HIGH period of the SCL clock	Standard mode	4	μs	
		Fast mode	600	ns	
		High-speed mode, C <sub>B</sub> – 100 pF maximum	60	ns	
		High-speed mode, C <sub>B</sub> – 400 pF maximum	120	ns	
t <sub>SU</sub> , t <sub>STA</sub>	Setup time for a repeated START condition	Standard mode	4.7	μs	
		Fast mode	600	ns	
		High-speed mode	160	ns	
t <sub>SU</sub> , t <sub>DAT</sub>	Data setup time	Standard mode	250	ns	
		Fast mode	100	ns	
		High-speed mode	10	ns	
t <sub>HD</sub> , t <sub>DAT</sub>	Data hold time	Standard mode	0	3.45	μs
		Fast mode	0	0.9	μs
		High-speed mode, C <sub>B</sub> – 100 pF maximum	0	70	ns
		High-speed mode, C <sub>B</sub> – 400 pF maximum	0	150	ns
t <sub>RCL</sub>	Rise time of SCL signal	Standard mode	20 + 0.1 C <sub>B</sub>	1000	ns
		Fast mode	20 + 0.1 C <sub>B</sub>	300	ns
		High-speed mode, C <sub>B</sub> – 100 pF maximum	10	40	ns
		High-speed mode, C <sub>B</sub> – 400 pF maximum	20	80	ns
t <sub>RCL1</sub>	Rise time of SCL signal after a repeated START condition and after an acknowledge bit	Standard mode	20 + 0.1 C <sub>B</sub>	1000	ns
		Fast mode	20 + 0.1 C <sub>B</sub>	300	ns
		High-speed mode, C <sub>B</sub> – 100 pF maximum	10	80	ns
		High-speed mode, C <sub>B</sub> – 400 pF maximum	20	160	ns
t <sub>FCL</sub>	Fall time of SCL signal	Standard mode	20 + 0.1 C <sub>B</sub>	300	ns
		Fast mode	20 + 0.1 C <sub>B</sub>	300	ns
		High-speed mode, C <sub>B</sub> – 100 pF maximum	10	40	ns
		High-speed mode, C <sub>B</sub> – 400 pF maximum	20	80	ns
t <sub>RDA</sub>	Rise time of SDA signal	Standard mode	20 + 0.1 C <sub>B</sub>	1000	ns
		Fast mode	20 + 0.1 C <sub>B</sub>	300	ns
		High-speed mode, C <sub>B</sub> – 100 pF maximum	10	80	ns
		High-speed mode, C <sub>B</sub> – 400 pF maximum	20	160	ns
t <sub>FDA</sub>	Fall time of SDA signal	Standard mode	20 + 0.1 C <sub>B</sub>	300	ns
		Fast mode	20 + 0.1 C <sub>B</sub>	300	ns
		High-speed mode, C <sub>B</sub> – 100 pF maximum	10	80	ns
		High-speed mode, C <sub>B</sub> – 400 pF maximum	20	160	ns
t <sub>SU</sub> , t <sub>STO</sub>	Setup time for STOP condition	Standard mode	4	μs	
		Fast mode	600	ns	
		High-speed mode	160	ns	
C <sub>B</sub>	Capacitive load for SDA and SCL		400	pF	

## 6.16 Typical Characteristics

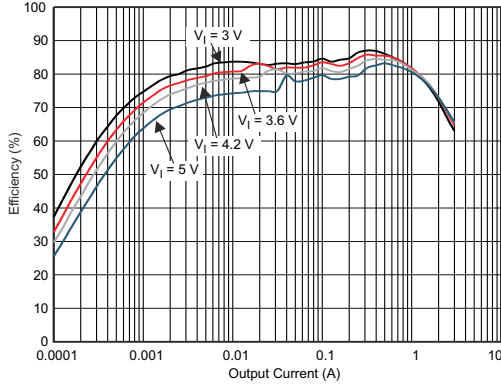

$V_{OUT} = 0.9\text{ V}$  PFM Mode  
DFE252012P-1R0  $T_A = 25^\circ\text{C}$

6-1. DCDC1 Efficiency vs Output Current

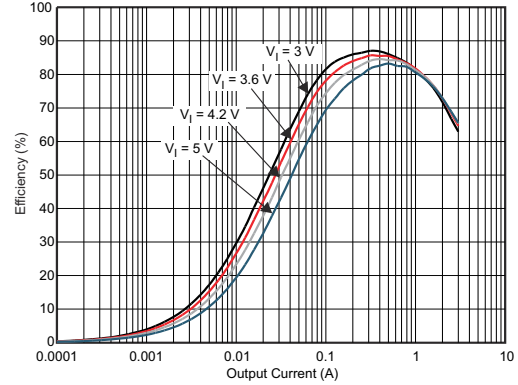

$V_{OUT} = 0.9\text{ V}$  PWM Mode  
DFE252012P-1R0  $T_A = 25^\circ\text{C}$

6-2. DCDC1 Efficiency vs Output Current

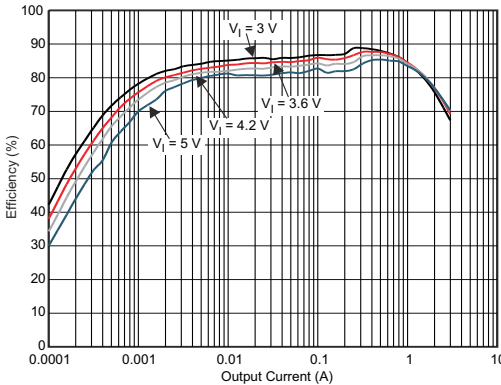

$V_{OUT} = 1.1375\text{ V}$  PFM Mode  
DFE252012P-1R0  $T_A = 25^\circ\text{C}$

6-3. DCDC1 Efficiency vs Output Current

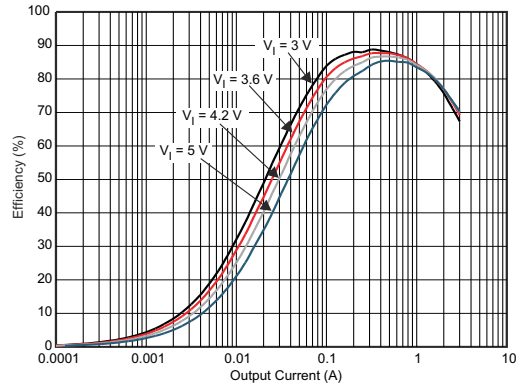

$V_{OUT} = 1.1375\text{ V}$  PWM Mode  
DFE252012P-1R0  $T_A = 25^\circ\text{C}$

6-4. DCDC1 Efficiency vs Output Current

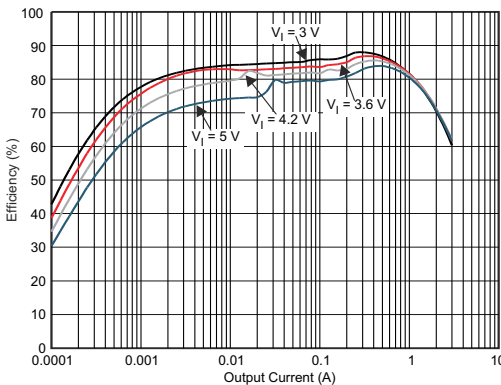

$V_{OUT} = 1.2\text{ V}$  PFM Mode  
LQM2MPN-1R0  $T_A = 25^\circ\text{C}$

6-5. DCDC1 Efficiency vs Output Current

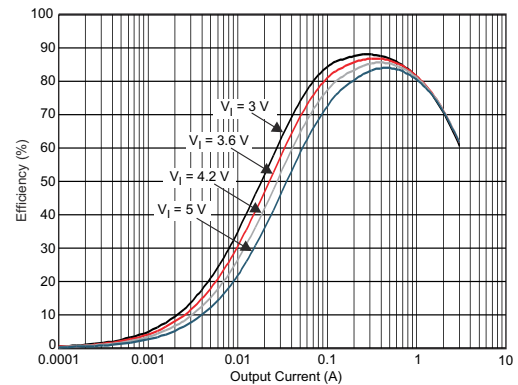

$V_{OUT} = 1.2\text{ V}$  PWM Mode  
LQM2MPN-1R0  $T_A = 25^\circ\text{C}$

6-6. DCDC1 Efficiency vs Output Current

### 6.16 Typical Characteristics (continued)

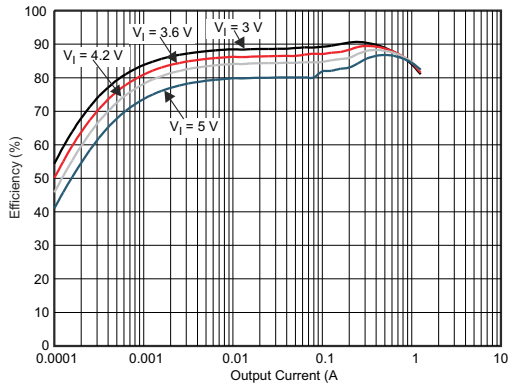

$V_{OUT} = 1.8\text{ V}$  PFM Mode  
LQM2MPN-1R0  $T_A = 25^\circ\text{C}$

**6-7. DCDC2 Efficiency vs Output Current**

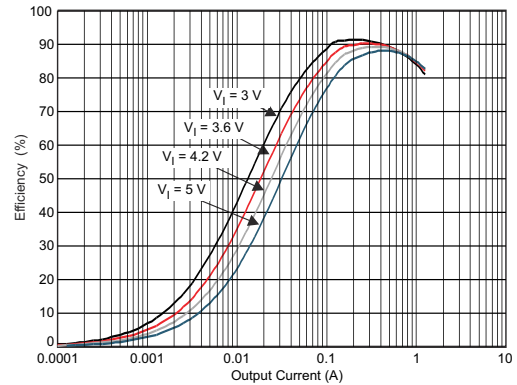

$V_{OUT} = 1.8\text{ V}$  PWM Mode  
LQM2MPN-1R0  $T_A = 25^\circ\text{C}$

**6-8. DCDC2 Efficiency vs Output Current**

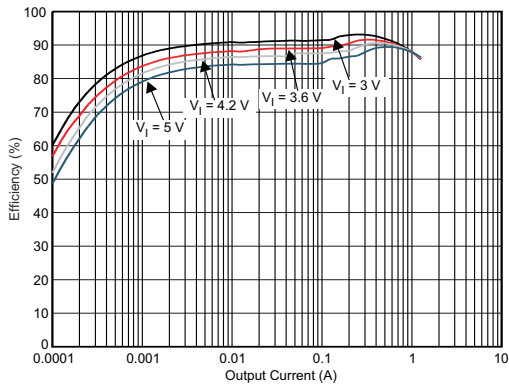

$V_{OUT} = 2.25\text{ V}$  PFM Mode  
VLS201612-1R0  $T_A = 25^\circ\text{C}$

**6-9. DCDC2 Efficiency vs Output Current**

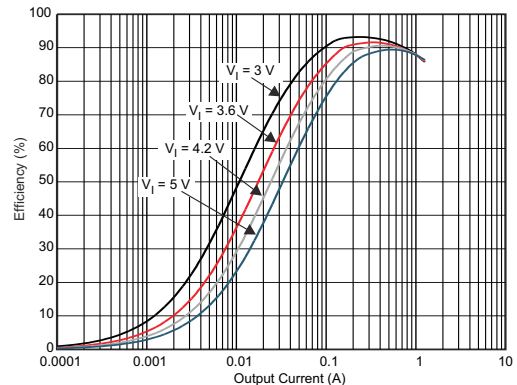

$V_{OUT} = 2.25\text{ V}$  PWM Mode  
VLS201612-1R0  $T_A = 25^\circ\text{C}$

**6-10. DCDC2 Efficiency vs Output Current**

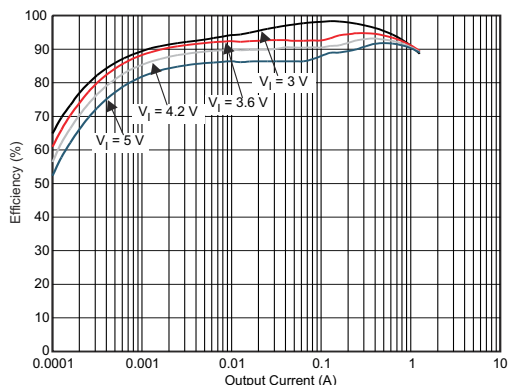

$V_{OUT} = 2.95\text{ V}$  PFM Mode  
VLS201612-1R0  $T_A = 25^\circ\text{C}$

**6-11. DCDC2 Efficiency vs Output Current**

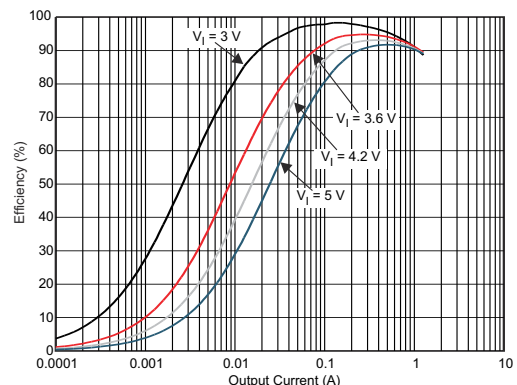

$V_{OUT} = 2.95\text{ V}$  PWM Mode  
VLS201612-1R0  $T_A = 25^\circ\text{C}$

**6-12. DCDC2 Efficiency vs Output Current**

### 6.16 Typical Characteristics (continued)

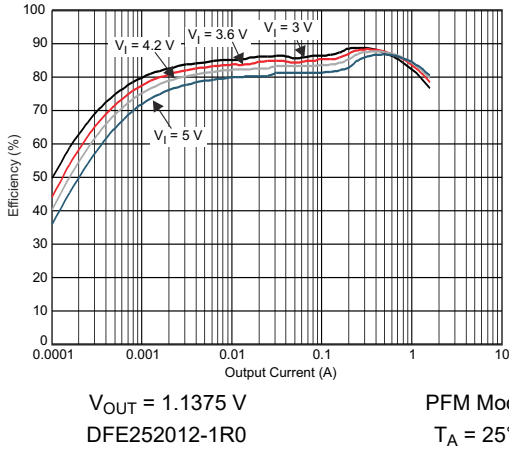

6-13. DCDC3 Efficiency vs Output Current

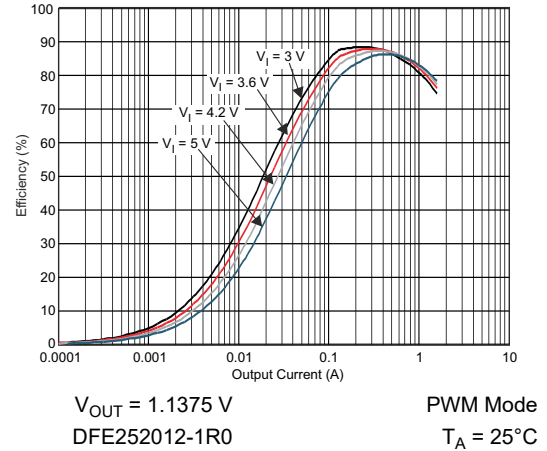

6-14. DCDC3 Efficiency vs Output Current

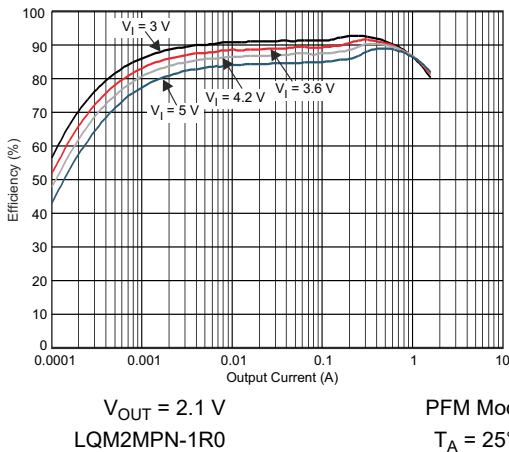

6-15. DCDC3 Efficiency vs Output Current

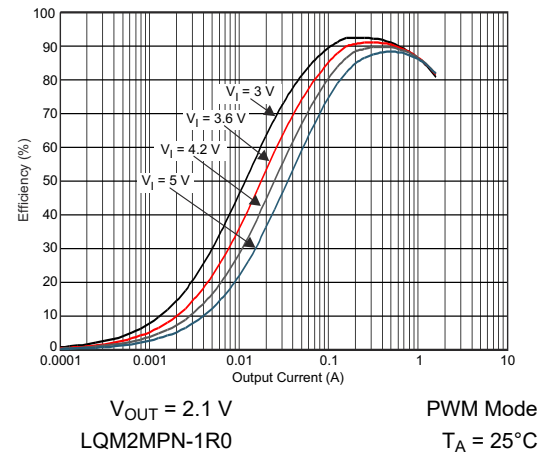

6-16. DCDC3 Efficiency vs Output Current

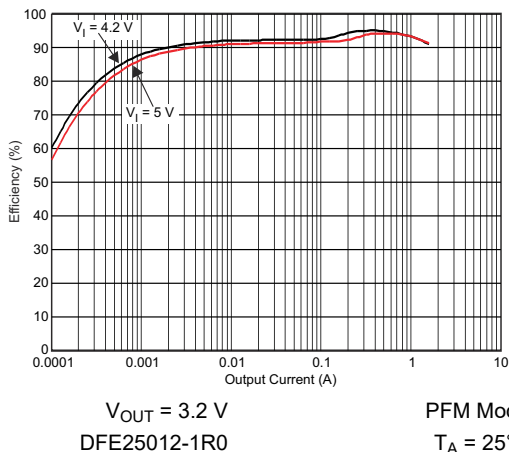

6-17. DCDC3 Efficiency vs Output Current

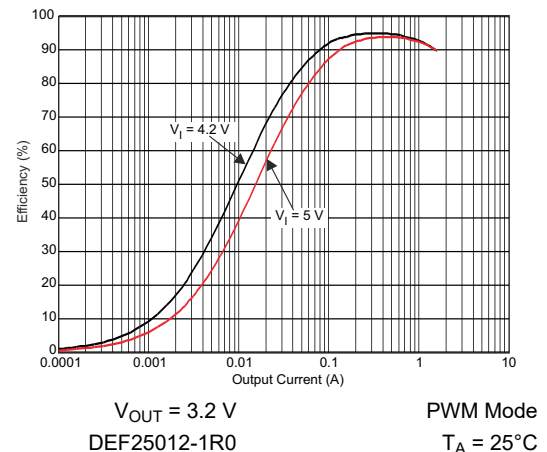

6-18. DCDC3 Efficiency vs Output Current

### 6.16 Typical Characteristics (continued)

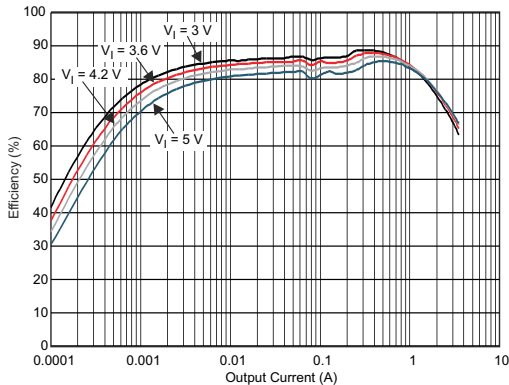

$V_{OUT} = 1.1375\text{ V}$  PFM Mode  
DEF25012-1R0  $T_A = 25^\circ\text{C}$

6-19. DCDC4 Efficiency vs Output Current

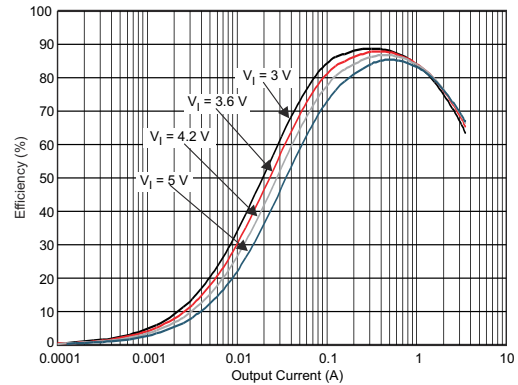

$V_{OUT} = 1.1375\text{ V}$  PWM Mode  
DEF322512-1R0  $T_A = 25^\circ\text{C}$

6-20. DCDC4 Efficiency vs Output Current

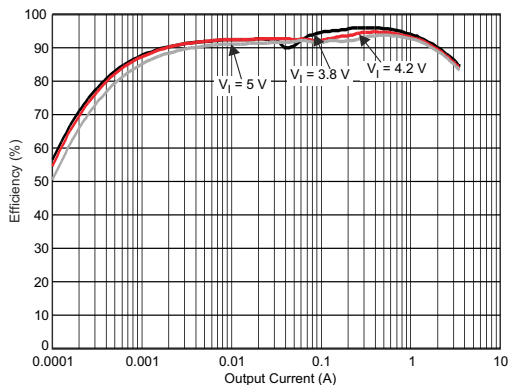

$V_{OUT} = 3.3\text{ V}$  PFM Mode  
DEF322512-1R0  $T_A = 25^\circ\text{C}$

6-21. DCDC4 Efficiency vs Output Current

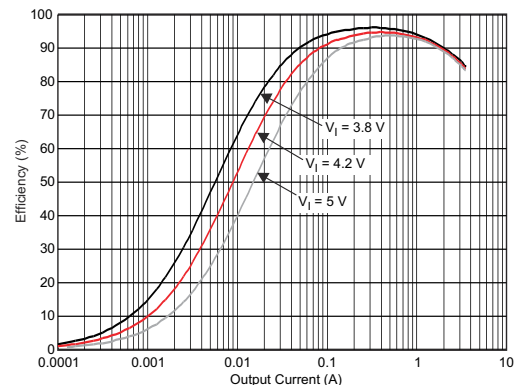

$V_{OUT} = 3.3\text{ V}$  PWM Mode  
DEF322512-1R0  $T_A = 25^\circ\text{C}$

6-22. DCDC4 Efficiency vs Output Current

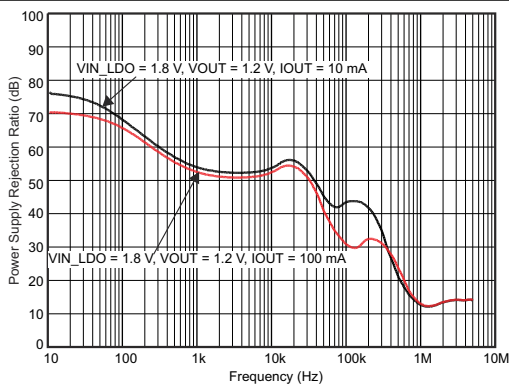

6-23. LDO1, LDO2, LDO3 PSRR vs Frequency

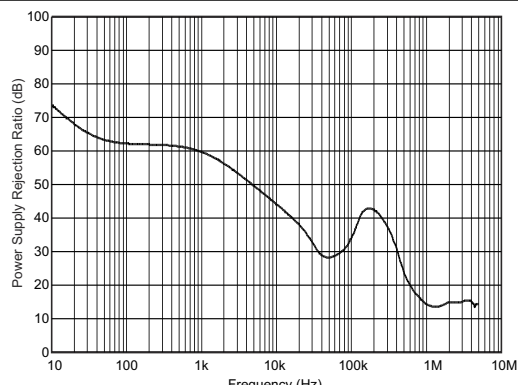

$V_{IN} = 3.2\text{ V}$   $V_{OUT} = 2.7\text{ V}$   
 $I_{OUT} = 225\text{ mA}$   
6-24. LDO4 and LDO5 PSRR vs Frequency

### 6.16 Typical Characteristics (continued)

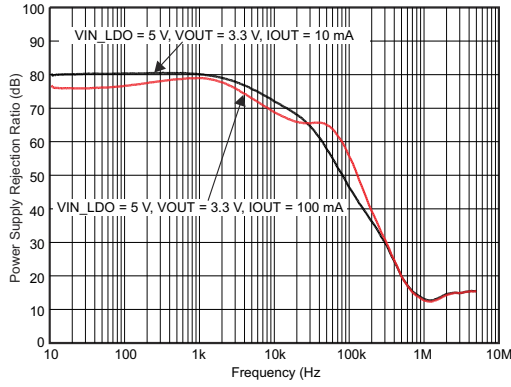

**6-25. LDO4 PSRR vs Frequency**

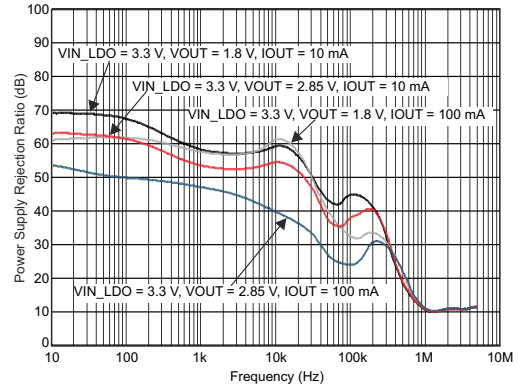

**6-26. LDO6 and LDO8 PSRR vs Frequency**

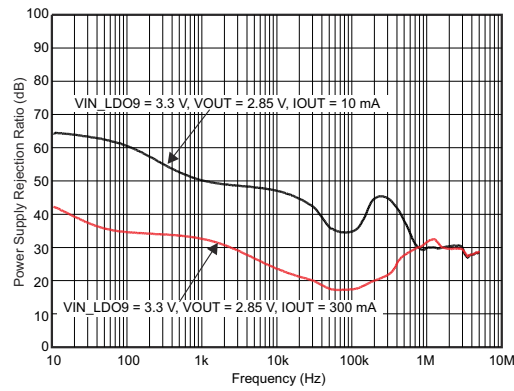

**6-27. LDO9 PSRR vs Frequency**

## 7 Parameter Measurement Information

### 7.1 I<sup>2</sup>C Timing Diagrams

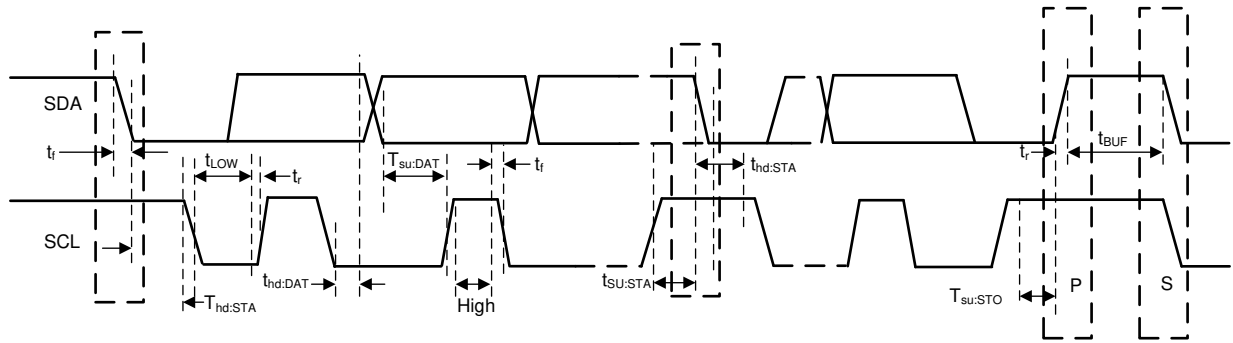

**7-1. Serial Interface Timing Diagram for FS-Mode**

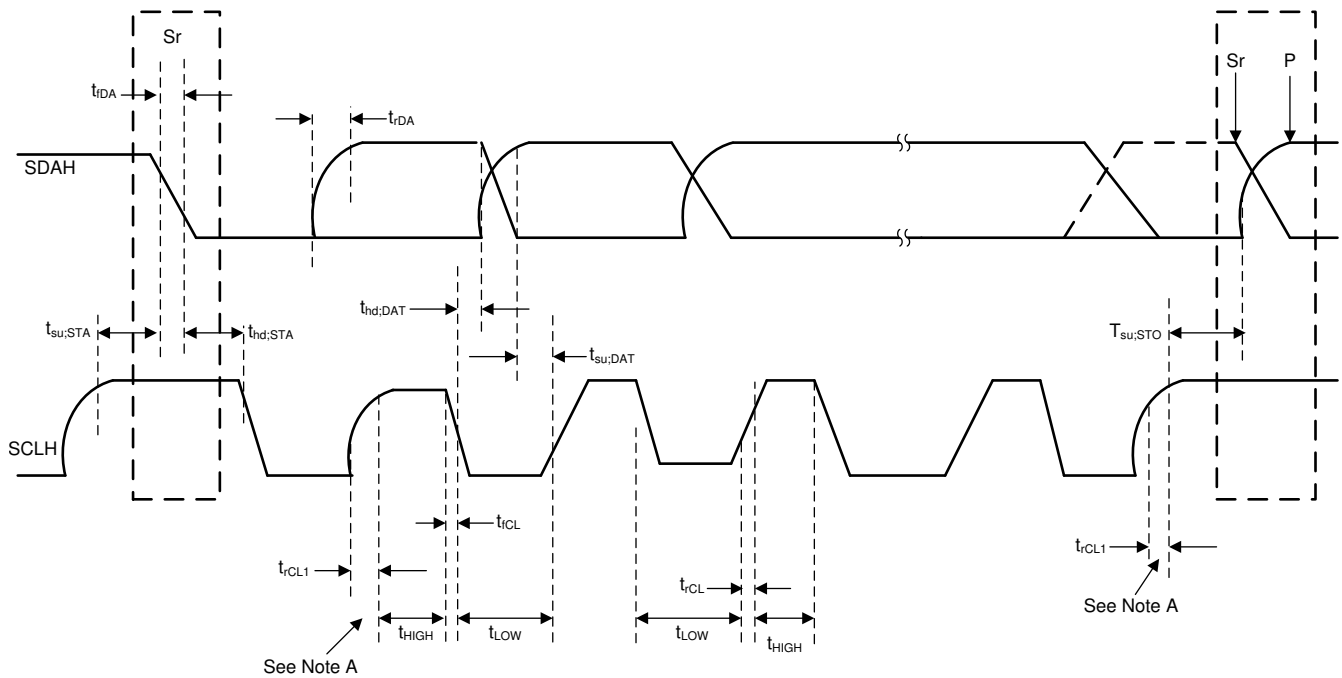

A. First rising edge of the SCLH signal after  $S_r$  and after each acknowledge bit.

**7-2. Serial Interface Timing Diagram for HS-Mode**



## 7.2 SPI Timing Diagram

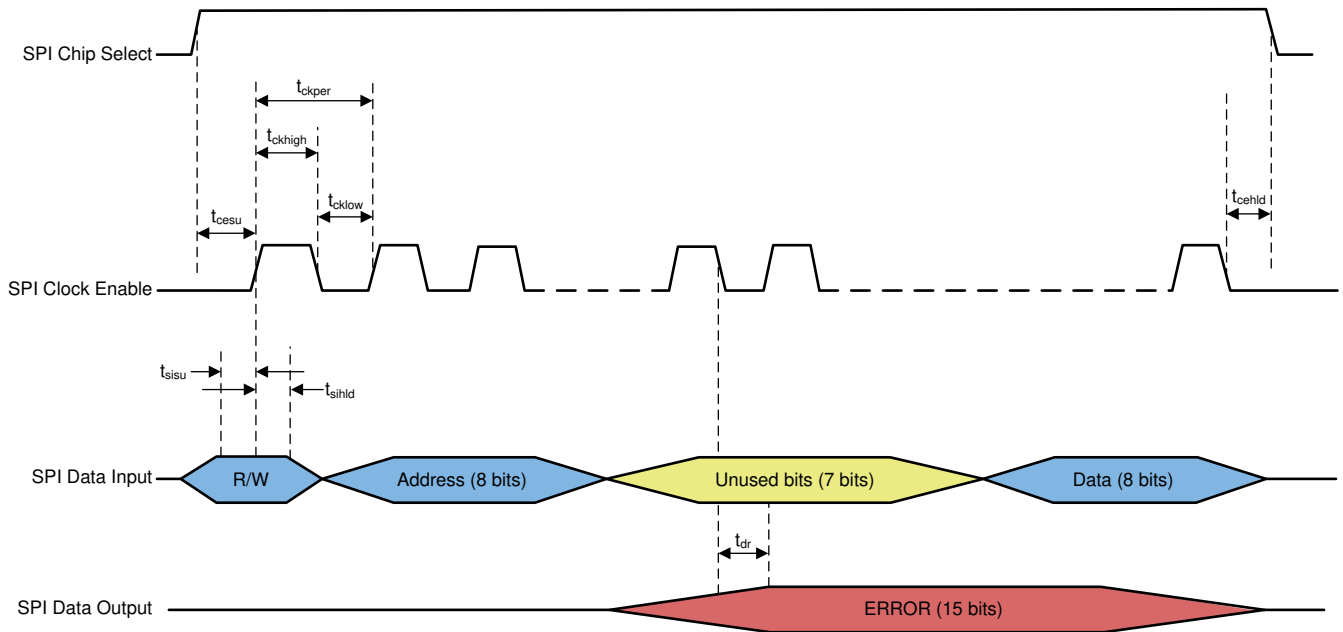

7-3. SPI Timing

## 8 Detailed Description

### 8.1 Overview

The TPS659128x device is an integrated power-management integrated circuit (PMIC), available in an 81-pin, 0.4-mm pitch, 3.6-mm × 3.6-mm DSBGA package. The device is designed for applications including data cards, smart phones, wireless routers and switchers, LTE modems, industrial applications, GPS, and tablets. The device provides four, configurable step-down converter rails with a power save mode for light loads. The TPS659128x device also provides ten external LDO rails. Eight are general purpose LDOs and two are low-noise RF-LDOs. The device also comes with two I<sup>2</sup>C interface channels or one SPI channel, five GPIOs, a 32-kHz RC oscillator, and a programmable power sequencer and control for supporting different processors and applications. The four, step-down converter rails are consisting of four, high-frequency switch-mode converters with integrated FETs. The rails are capable of synchronizing to an external clock input and supports a switching frequency from 2.8 MHz to 3.5 MHz. The DCDC4 rail also includes a bypass switch that can be used to turn on and turn off high current loads. In addition, the DCDC rails support dynamic voltage scaling with a dedicated I<sup>2</sup>C interface. The eight general LDOs support an output from 0.8 V to 3.3 V. The two low-noise LDOs support an output from 1.6 V to 3.3 V. All LDOs and step-down converters can be controlled by the SPI or I<sup>2</sup>C interface. The power-up and power-down controller is configurable and programmable through one-time programmable (OTP) memory. The TPS659128x device includes a 32-kHz RC oscillator to sequence all resources during power up and power down. Configurable GPIOs with a multiplexed feature are available on the TPS659128x device. The GPIOs can be configured and used as enable signals for external resources, which can be included in the power-up and power-down sequence. Lastly, the device includes a long button-press detection that allows startup of the device with the hold of a button.

## 8.2 Functional Block Diagram

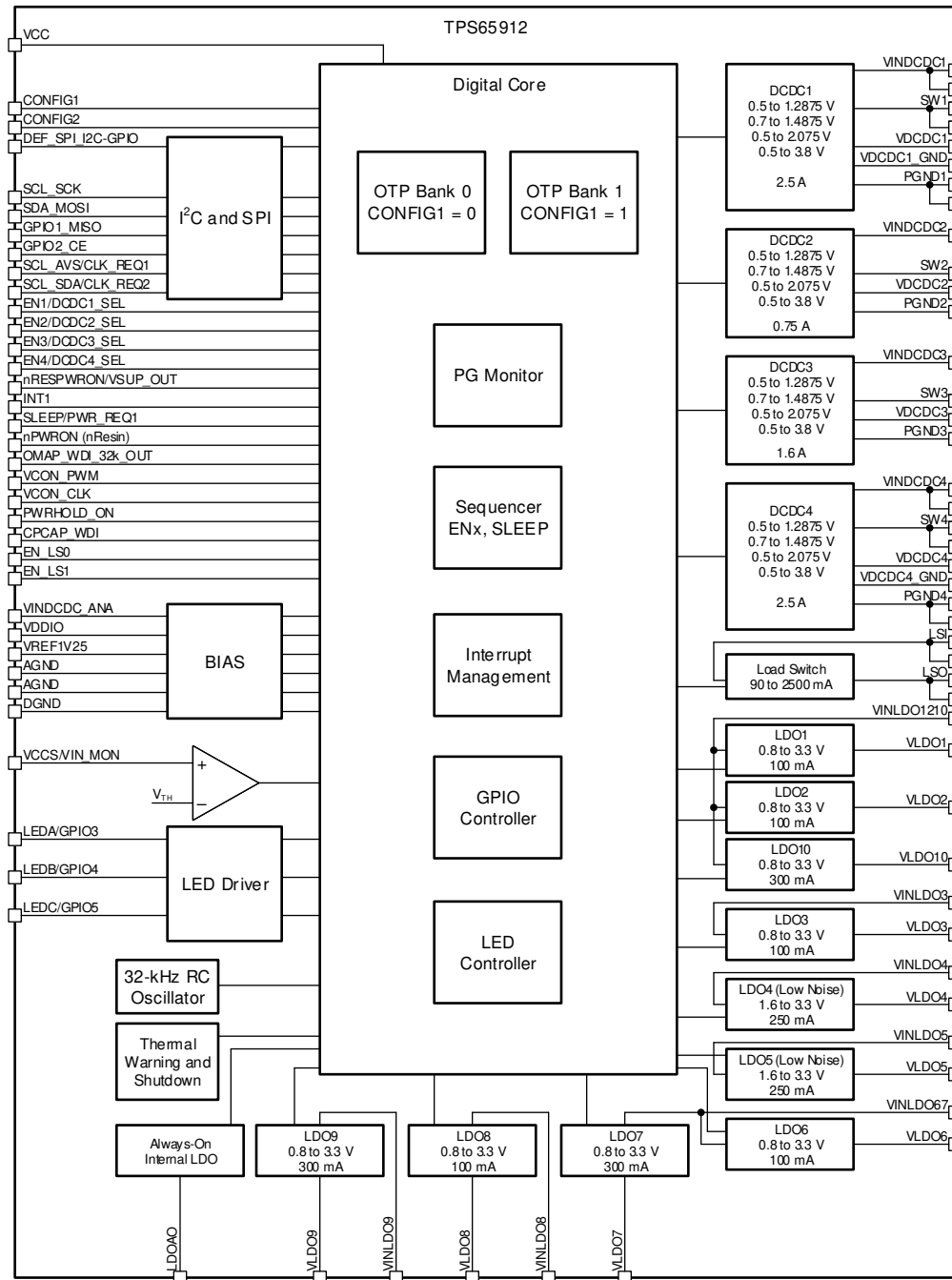

## 8.3 Feature Description

### 8.3.1 Linear Regulators

The power-management core has 10 low-dropout (LDO) regulators with various output voltage and current capabilities. Each LDO output voltage can be set independently through the communication bus (see [表 8-85](#)). The transition occurs immediately if the LDO regulator is enabled.

#### 8.3.1.1 Low Quiescent Current Mode (Eco-mode™)

Each LDO regulator is equipped with a low quiescent-current mode that can be enabled or disabled separately. When the ECO bit is set to 1b, the LDOx Eco-mode control scheme is enabled if the proper conditions are met.

#### 8.3.1.2 Output Discharge

Each LDO regulator is equipped with an output discharge bit located in the DISCHARGE<sub>x</sub> registers. When the LDO<sub>x</sub>\_DISCHARGE bit is set to 1b, the output of the LDO is discharged to ground with the equivalent of a 300-Ω resistor. If the LDO regulator is enabled, the discharge bit is ignored.

#### 8.3.1.3 Thermal Shutdown

Global thermal-shutdown protection is available for all step-down converters and LDO regulators. The thermal sensor generates an early warning depending on the setting of the THRM\_REG register. This can generate an interrupt on the INT pin if the HOTDIE interrupt is not masked in the INT\_MSK register. If the temperature rises above the thermal shutdown threshold, the device is powered down to the OFF state.

#### 8.3.1.4 LDO Enable

The LDO enable and disable is part of the flexible power-up and power-down state machine. Each LDO regulator can be factory programmed such that it is powered up automatically in one of the 15 time slots after a power-on condition occurs or is controlled by a dedicated pin. More details on the startup sequencing is available in [セクション 8.4.3](#). The EN1, EN2, EN3, EN4, CLK\_REQ1, CLK\_REQ2, and PWR\_REQ (SLEEP) pins can be mapped to any resource (LDO, DC-DC converter, 32-kHz clock output, or GPIO) to enable or disable the resource if the proper conditions are met.

#### 8.3.1.5 LDO Voltage Range

The output voltage range for the standard LDO regulators is 0.8 V to 3.3 V. For the RF-LDO regulators, LDO4 and LDO5, the output voltage range is 1.6 V to 3.3 V. The most significant bit for the voltage settings (the SEL[5] bit) on LDO4 and LDO5 is ignored and is internally set to 1b.

#### 8.3.1.6 LDO Power-Good Comparator

The output voltage of each LDO regulator is supervised by an internal power-good comparator. The output of the comparator is set and cleared by the power-good bits in the PGOOD and PGOOD2 registers. The power-good bits are not valid if the LDO regulator is enabled but the input voltage to the LDO is less than 1 V.

### 8.3.2 Step-Down Converters

The synchronous step-down converter used in the power-management core includes a unique, hysteric PWM-controller scheme which enables switch frequencies over 3 MHz, excellent transient and AC load regulation, and operation with tiny and cost-competitive external components.

The controller topology supports forced PWM mode as well as power save mode operation. Power save mode operation reduces the quiescent current consumption and ensures high conversion efficiency at light loads by skipping switch pulses.

A significant advantage of this architecture compared to other hysteretic PWM-controller topologies is its excellent DC and AC load regulation capability in combination with low output-voltage ripple over the entire load range which makes this device well suited for audio and RF applications.

When the output voltage falls below the threshold of the error comparator, a switch pulse is initiated and the high-side switch is turned on. The switch remains turned on until a minimum on time expires and the output voltage trips the threshold of the error comparator or the inductor current reaches the current limit of the high-side switch. When the high-side switch turns off, the low-side switch rectifier is turned on and the inductor current ramps down until the high-side switch turns on again or the inductor current reaches zero.

#### 8.3.2.1 PWM and PFM Mode

In forced PWM mode, the device avoids pulse skipping and allows easy filtering of the switch noise by external filter components. PWM mode is forced by setting the DCDCx\_MODE bit to 1b. If this bit is not set, the DCDCx outputs are in auto mode, which can switch to a low-current PFM mode when a light load occurs and sufficient headroom is present between the DCDCx input and output rails.

#### 8.3.2.2 Low Quiescent Current Mode

Each step-down converter can be individually controlled to enter a low quiescent-current mode. This mode can be entered when the ECO bit is set to 1b and the proper conditions are met. In Eco-mode, the quiescent current is reduced and the output voltage is supervised by a comparator while most parts of the control circuitry are disabled to save power. Eco-mode should only be enabled when a converter has less than 2 mA of load current. In addition, the Eco-mode should be disabled prior to a load transient step to allow the converter to respond in a timely manner to the excess current draw. Setting the step-down converter into PWM mode by setting the DCDCx\_MODE bit to 1b disables Eco-mode independently from the setting of the ECO bit.

#### 8.3.2.3 Output Voltage Monitoring

Internal power-good comparators monitor the switching regulator outputs and detect when the output voltage is less than 90% of the programmed value. This information is used by the power-management core to generate interrupts depending on specific I<sup>2</sup>C register settings. For more information, see [セクション 8.4.8](#). An individual power-good comparator of the switching regulator is blanked when the regulator is disabled or when the voltage of the regulator is transitioning from one set point to another.

#### 8.3.2.4 Output Discharge

Each switching regulator is equipped with an output discharge enable bit located in the DISCHARGE2 register. When the DCDCx\_DISCHARGE bit is set to 1b, the output of the regulator is discharged to ground with the equivalent of a 400-Ω resistor. If the enable bit of the regulator is set, the discharge bit is ignored.

#### 8.3.2.5 Thermal Shutdown

Global thermal-shutdown protection is available for all step-down converters and LDOs. The thermal sensor generates an early warning depending on the setting of the THRM\_REG register. If the temperature rises above the thermal shutdown threshold, the device is powered down to the OFF state.

#### 8.3.2.6 Step-Down Converter Enable

The step-down converter enable and disable is part of the flexible power-up and power-down state machine. Each converter can be factory programmed such that it is powered up automatically in one of the 15 time slots after a power-on condition occurs or is controlled by a dedicated pin. The EN1, EN2, EN3, EN4, CLK\_REQ1,

CLK\_REQ2, and PWR\_REQ (SLEEP) pins can be mapped to any resource (LDO, DC-DC converter, 32 kHz clock output, or GPIO) to enable or disable the resource.

### 8.3.2.7 Step-Down Converter Soft Start

The step-down converters in the TPS659128x device have an internal soft-start circuit that controls the ramp-up of the output voltage. The output voltage ramps up from 5% to 95% of its nominal value within a time defined in [セクション 6](#). This ramp time limits the inrush current in the converter during start-up and prevents possible input voltage drops when a battery or high-impedance power source is used. The soft-start circuit is enabled after the start-up time,  $t_{\text{start}}$ , has expired. The DCDC4 converter has an option to set two different values for the start-up and ramp time. For applications that require a fast response, set the DCDC4\_CTRL:RAMP\_TIME bit to 1b.

During soft start, the output voltage ramp up is controlled as shown in [図 8-1](#).

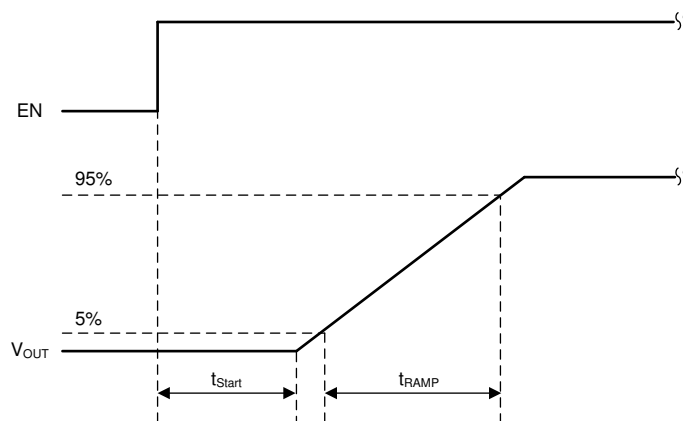

**図 8-1. Soft Start**

### 8.3.3 GPIOs

The TPS659128x device has five GPIOs. GPIO1 and GPIO2 are shared with the SPI and therefore they are not available if the SPI is used. GPIO3, GPIO4, and GPIO5 are for general-purpose use and are shared with the LED driver. The input and output stages of GPIO1 and GPIO2 are similar to GPIO3 however, they do not contain the LED current sink. If the output stage is programmed as a push-pull output, it pulls to the high-voltage set by the VDDIO pin. With the VDDIO supply voltage being less than the VDDIO UVLO threshold voltage, the high-side driver is disabled and the output is set to open drain.

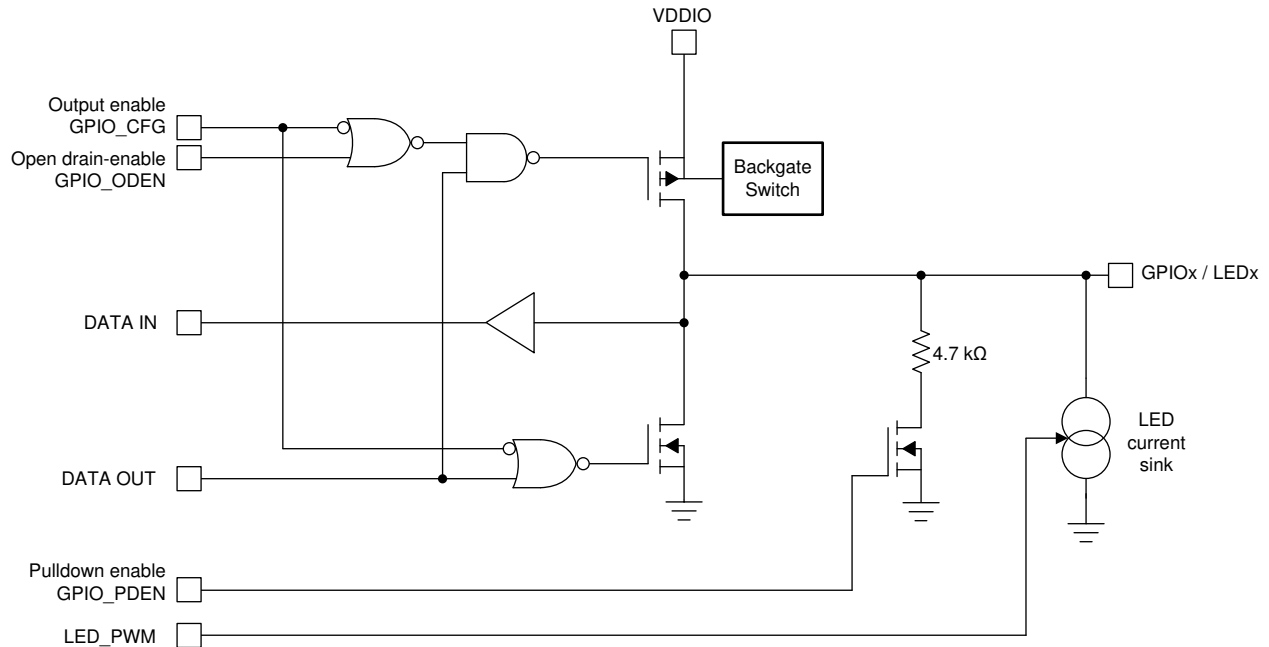

**FIG 8-2. GPIO Block for GPIO3, GPIO4, and GPIO5**

## 8.4 Device Functional Modes

### 8.4.1 Power State Machine

The embedded power controller (EPC) manages the state of the device and controls the power-up sequence.

The transitions for the state machine are shown in [FIG 8-3](#) through [FIG 8-8](#).

The EPC supports the following states:

- NO SUPPLY** The main battery-supply voltage is not high enough to power the LDOAO (LDO Always ON) regulator in this state. A global reset is asserted in this case. Everything on the device is off.
- CONFIG** This state is entered either from the NO SUPPLY state automatically or from the ACTIVE or SLEEP state when the TPS659128x device is configured accordingly by the LOAD-OTP bit (bit 6) in the DEVCTRL register. When the CONFIG state is entered, all registers are set to their default value and the nRESPWRON pin is asserted.
- OFF** The LDOAO regulator is on and internal logic is active in this state. All power supplies are off. The device can detect and execute a power-up sequence. The nRESPWRON pin is asserted.
- ACTIVE** Device POWER-ON enable conditions are met and regulated power supplies are ON or can be enabled with full current capability in this state. A reset is released and the interfaces are active.
- SLEEP** Device SLEEP enable conditions are met and selected regulated power supplies are in low-power or off mode in this state. Only used when CONFIG2 is shorted to GND.

## 8.4.2 Transition Conditions

The device transition conditions are:

- The device performs POWER ON transition when any of the following power on conditions are met:
  - nPWRON signal low level
  - PWRHOLD signal high level
  - PWRHLD bit in the DEVCTRL register set to 1b (OTP dependent default)
  - Interrupt flag active (default INT1 low) will generate a POWER ON enable condition for 5 seconds. During this time period, the processor or system is required to set PWRHOLD pin to high or set the PWRHLD bit in the DEVCTRL register to 1b to keep the device on. Interrupt sources generate POWER ON enable conditions only if they are not masked (OTP and register setting dependent).
- The device POWER ON transition will not occur if any of the following conditions are present:
  - nPWRON signal low level for more than the Long Press delay of 5 s. This can be disabled by setting the PWRON\_LP\_OFF and PWRON\_LP\_OFF\_RST bits in the DEVCTRL2 register to 0b. The interrupt corresponding to this condition is the PWRON\_LP\_IT in INT\_STS\_REG register. The interrupt is generated after 4 s to allow processor to mask PWRON\_LP\_OFF if desired.
  - Die temperature has reached the thermal shutdown threshold (THERM\_TS bit in THRM\_REG register is 1b)
- Device performs POWER OFF transition from ACTIVE state if none of the POWER ON conditions are met, if long key press takes priority, the DEV\_OFF bit is set to 1b, or die temperature reaches thermal shutdown threshold.
- Device performs ACTIVE to SLEEP transition when all of the following happen:
  - The interrupt flag is inactive, meaning there are no unmasked interrupts pending
  - The SLEEP\_ENABLE bit in the DEVCTRL2 register is set to 1b
  - The SLEEP pin is active (polarity depending on SLEEP\_POL bit in the DEVCTRL2 register)

Alternatively, as long as no interrupts are pending, the DEV\_SLP bit can also put the device into the SLEEP state with higher priority than the SLEEP pin. When the DEV\_SLP bit is used, there must be an unmasked interrupt to cause SLEEP to ACTIVE transition, otherwise device will remain in SLEEP until set to OFF state and the DEV\_SLP bit is cleared. It is not recommended to use the DEV\_SLP bit when the CONFIG2 pin is shorted to LDOAO.

- The device has two different reset scenarios:
  - Full reset: all digital of device is reset
    - This reset is caused by a power-on reset (POR) when VCCS < UVLO.
  - General reset, where only OTP backed register bits are reloaded:
    - This reset is caused by a turnoff event while the LOAD-OTP bit is set to 1b.
    - A turnoff event happens when the PWRON\_LP\_OFF\_RST bit is set to 1b.
    - The nPWRON pin can also be set in OTP to cause reset when pulled low longer than 100 ms.



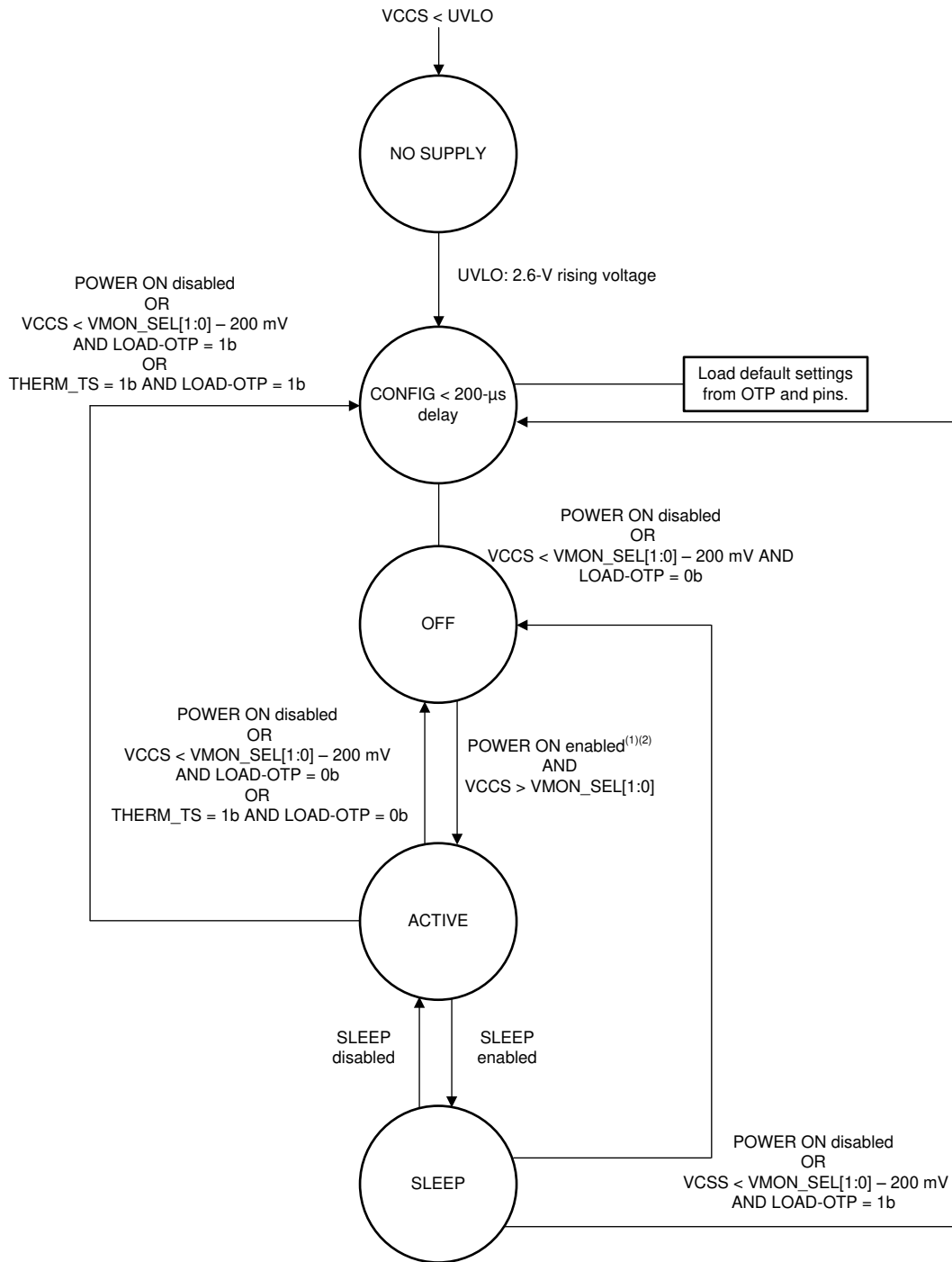

- A. Alternatively, the PWRHLD bit in the DEVCTRL register can be factory programmed to 1b in OTP, causing immediate power up. In this case, the bit must be set to 0b to allow normal device shutdown.
- B. SLEEP state only applies when CONFIG2 is shorted to GND.

**8-3. EPC State Machine**

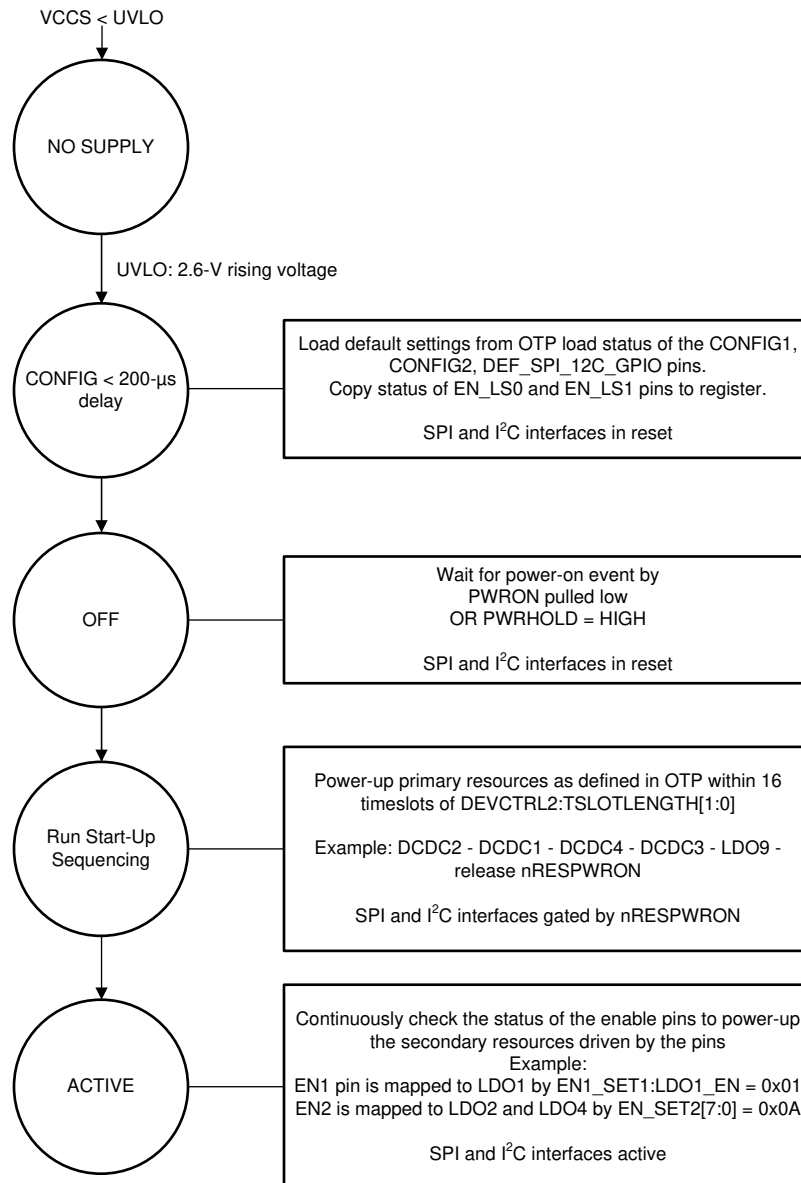

**8-4. STARTUP Flow for CONFIG2 Pin Shorted to LDOAO**

8-4 is valid when the CONFIG2 pin is shorted to LDOAO. The EN1, EN2, EN3, and EN4 pins are used as enable pins to enable one or several resources. The EN1\_SET1 and EN1\_SET2 registers define which converters or LDO regulators are controlled by the EN1 pin. The EN2, EN3, and EN4 are configured similarly.

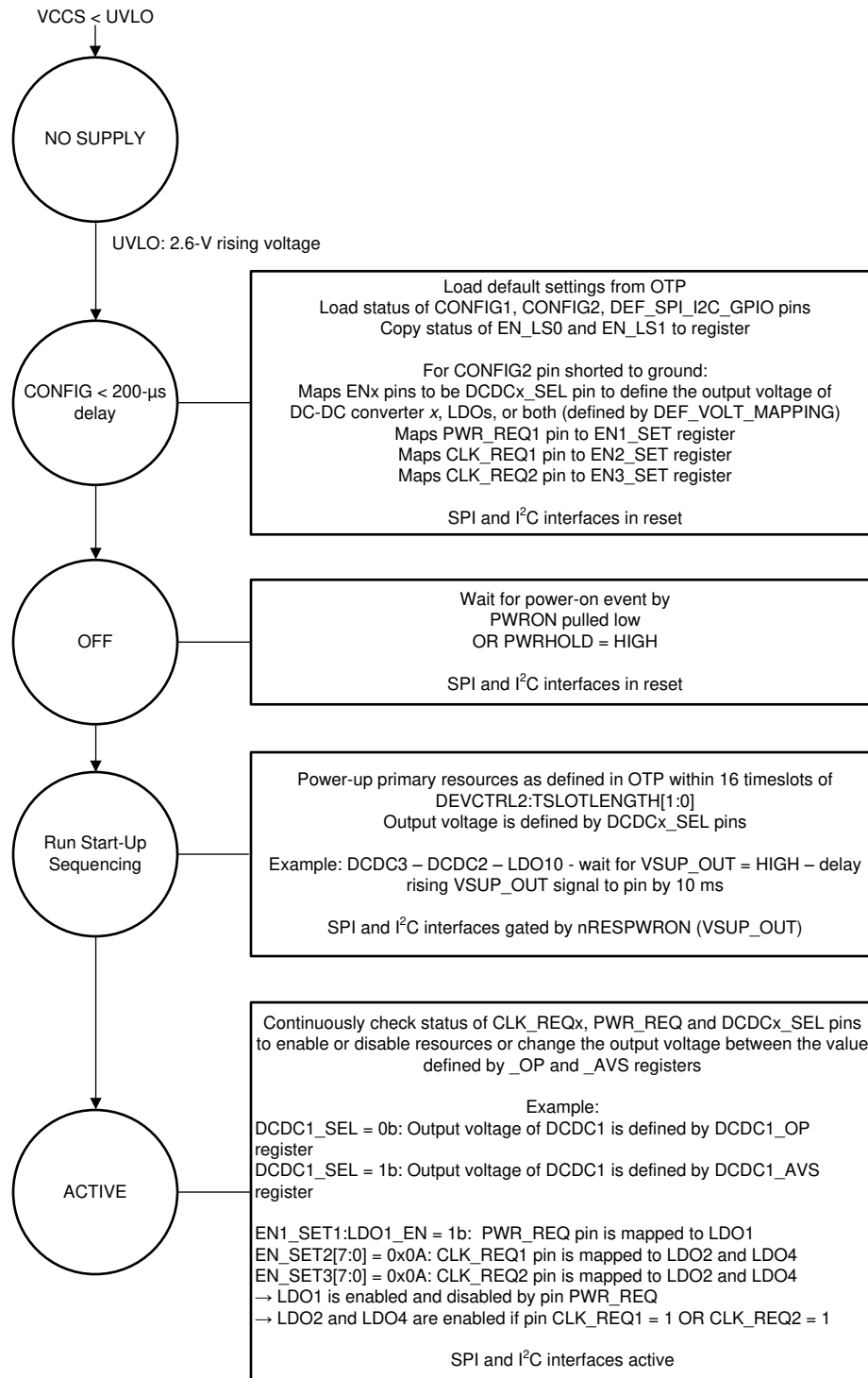

8-5. STARTUP Flow for CONFIG2 Pin Shorted to GND

8-5 is valid when the CONFIG2 pin is shorted to GND. The EN1, EN2, EN3, and EN4 pins are remapped as DCDCx\_SEL pins, defining which register is used to set the output voltage on a specific DC-DC converter. For example, connecting the DCDC1\_SEL pin to GND sets the output voltage of the DCDC1 converter to what is defined by the DCDC1\_OP register. Connecting the DCDC1\_SEL pin to a logic level high sets the output voltage to what is defined by the DCDC1\_AVS register. The DCDC2 voltage is defined by the DCDC2\_SEL pin and so forth.

The LDO1 to LDO4 regulators can be mapped to the DCDCx\_SEL pins. The DEF\_VOLT\_MAPPING register defines which LDO regulator is controlled by which DCDCx\_SEL pin.

Additionally, shorting the CONFIG2 pin to GND also remaps the SCL\_AV5, SDA\_AV5, and SLEEP pins as CLK\_REQ1, CLK\_REQ2, and PWR\_REQ pins. The functionality is similar to the ENx pins.

The EN1\_SET1 and EN1\_SET2 registers define which resource is controlled by the PWR\_REQ pins, the EN2\_SETx register defines the resource controlled by the CLK\_REQ1 pin, and the EN3\_SETx register defines the resources controlled by the CLK\_REQ2 pin.

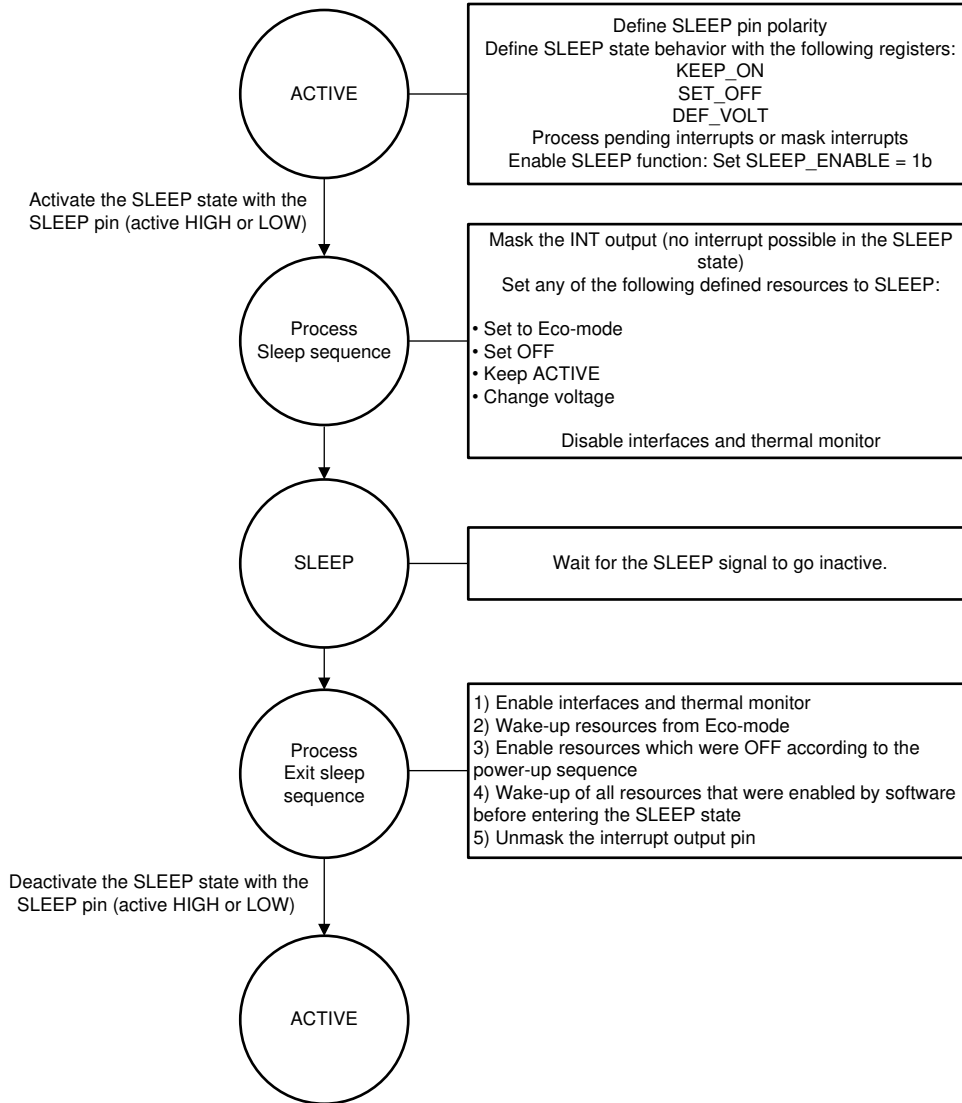

**8-6. SLEEP Flow for CONFIG2 Pin Shorted LDOAO**

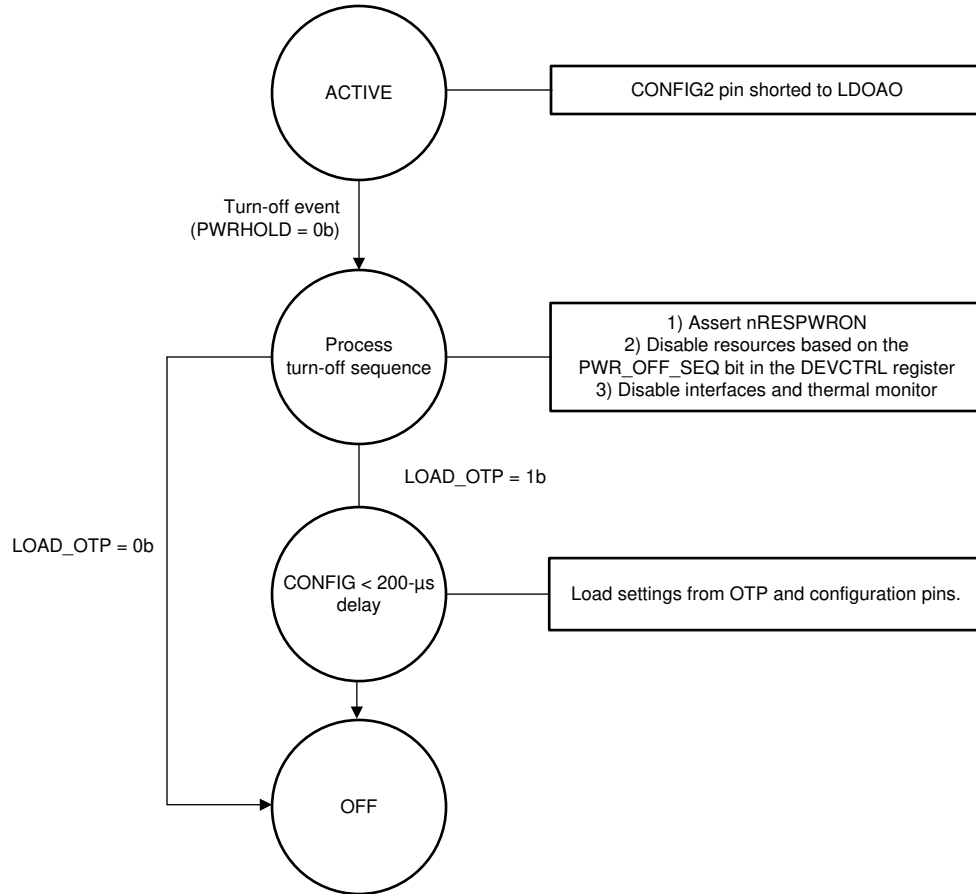

 **8-7. SHUTDOWN Flow for CONFIG2 Pin Shorted to LDOAO**

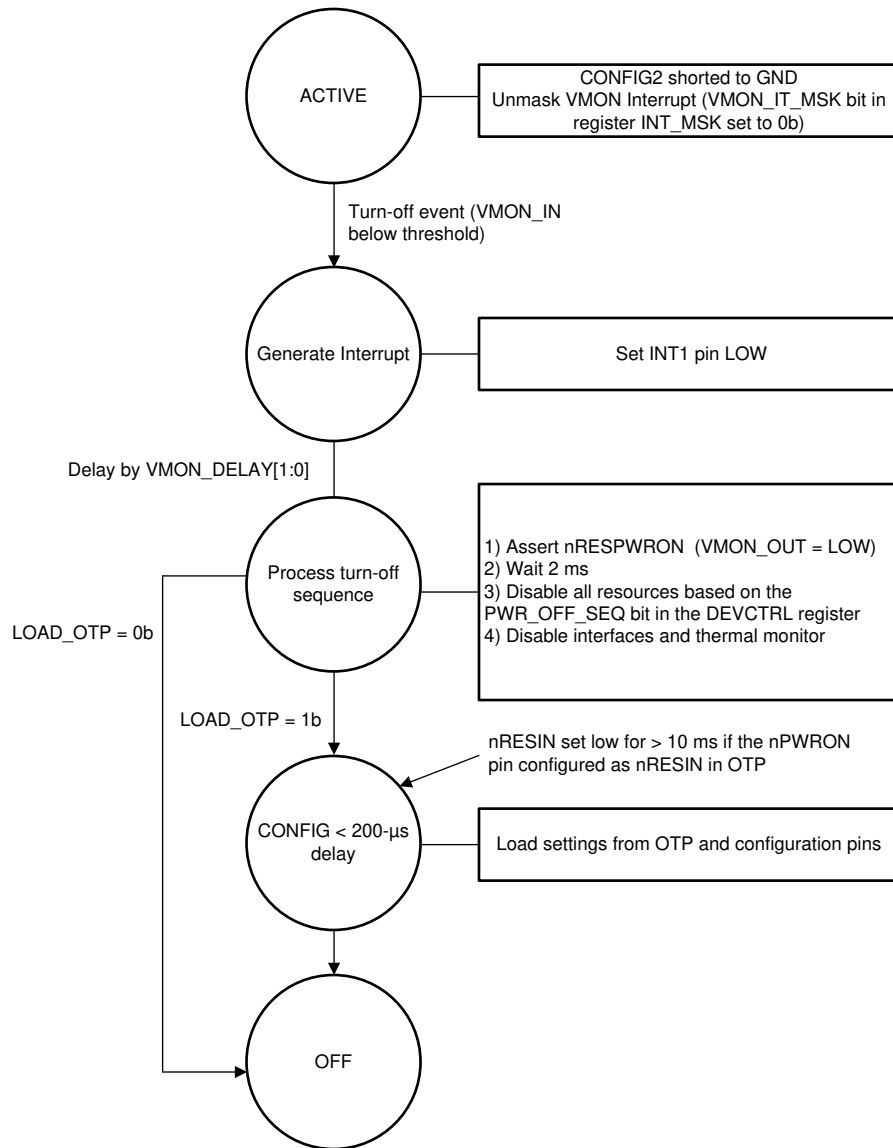

**8-8. SHUTDOWN Flow for CONFIG2 Pin Shorted to GND**

### 8.4.3 Implementation of Internal Power-Up and Power-Down Sequencing

The TPS659128x can internally enable resources during power up (going to the ON state) and power down (going to the OFF state), and for entering and exiting the SLEEP state. The internal power sequencing is defined in the factory programmed OTP memory. The sequencing can enable resources in 15 time slots during power up and power down. A resource can be associated to any of these 15 time slots that will be processed in the opposite direction during power down. Four settings are programmable for the delay and are effective for all 15 time slots:

**表 8-1. T SLOT\_LENGTH Delay Options**

Bits	Delay
00b	30 $\mu$ s
01b	200 $\mu$ s
10b	500 $\mu$ s
11b	2 ms

Resources can include:

- Step-down converters
- LDO regulators
- 32-kHz clock output
- nRESPWRON output

Resources that are not part of the automatic sequencing can be configured such that they are enabled by external pins or by their enable bit in the register set once the device is in the ACTIVE or SLEEP states. Resources that are enabled automatically should not be assigned to an external enable pin. A *break point* can be defined which stops power-up sequencing and allows power-up sequencing to resume once voltage monitoring conditions are met. This break point prevents power up until the voltage of the voltage monitors exceeds a certain limit.

As shown in [Figure 8-9](#), resources can be mapped to any of the time slots with none, one, or multiple resources for any time slot.

---

#### Note

[Figure 8-9](#) is an example of the programmability of the sequencing and does not match the settings for a particular OTP of the device. For individual part-number settings, refer to the application report specific for each orderable part number.

---

For entry to the SLEEP state and exit from the SLEEP state, only three time slots are used with a 120- $\mu$ s delay between time slots.



图 8-9. Internal Power-Up Example

8.4.4 Summary of CONFIG2, Device State, and Enable Pin Settings on Regulators

The behavior of the regulators is impacted by the state of various settings which can be modified by hardware, software, and part number specific settings. The LDOs are more simplistic and are shown first. The DCDCs are shown second and include an additional resource mode (force PWM). Both cases also indicate which voltage setting register (xxx\_OP or xxx\_AV5) is used. The following tables assume the LDOx\_ENABLE bit or DCDCx\_ENABLE bit is set to 1b. Setting this bit to 0b will cause the resource to be off in all cases.

8.4.4.1 LDO Mode Summary

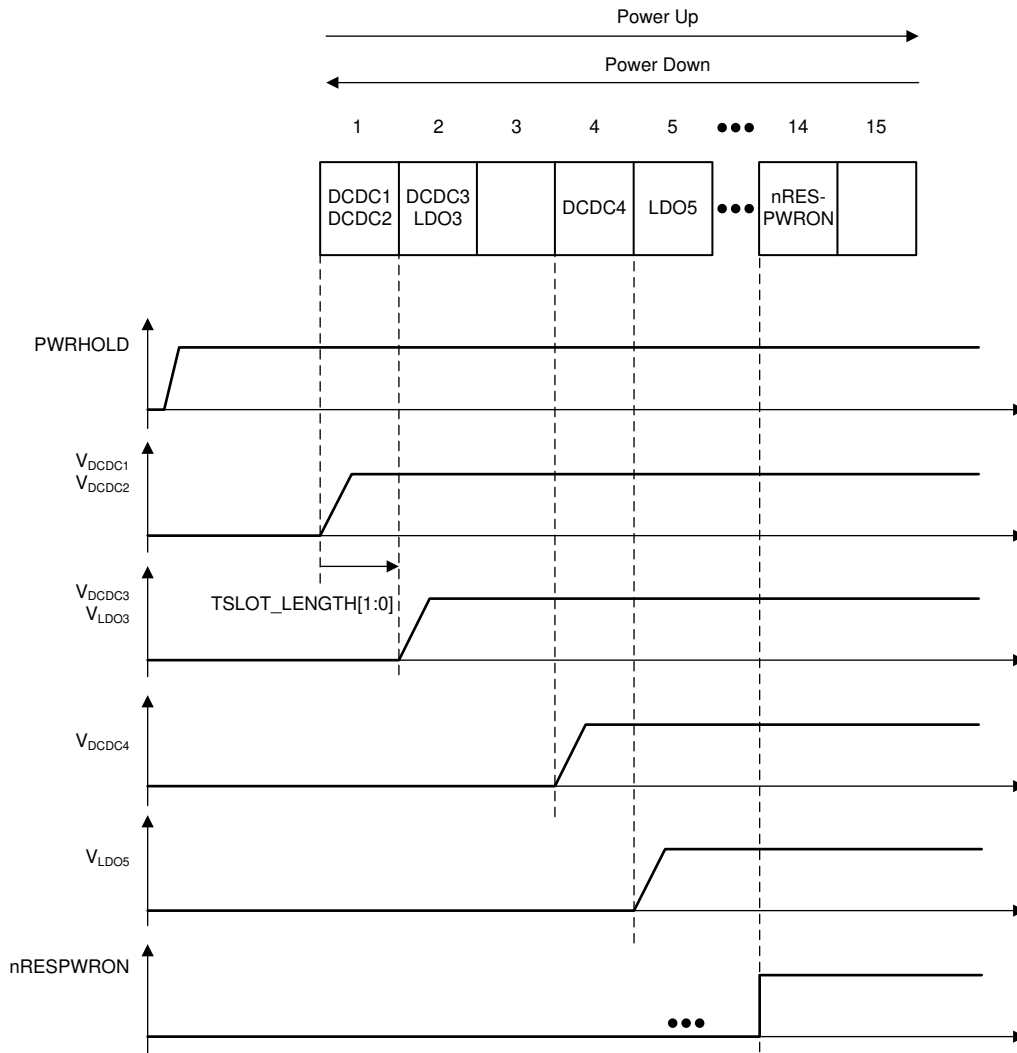
The LDO regulators can be off, on in normal-mode, or on in Eco-mode. Which mode the regulator is in depends on several variables which can be defined by the part-number specific settings, the host processor software, and the hardware configuration. The configurations are best broken into two categories. The first configuration applies when a regulator has been assigned to an external pin by the host processor or by OTP in any of the ENx\_SETx registers. This configuration has few dependencies. The second configuration applies to all other cases. A summary of these two can be found in the following tables.

表 8-2. LDO Mode Summary - Assigned LDO

Assigned Pin(s) State <sup>(1)</sup>	KEEP_ON Bit <sup>(2)</sup>	SET_OFF Bit <sup>(2)</sup>	Resource Mode
Low	0b	1b	Off



**表 8-2. LDO Mode Summary - Assigned LDO (continued)**

Assigned Pin(s) State <sup>(1)</sup>	KEEP_ON Bit <sup>(2)</sup>	SET_OFF Bit <sup>(2)</sup>	Resource Mode
Low	0b	0b	Eco
Low	1b	x	Normal
High	x	x	Normal

- (1) This is an OR of all assigned pins. If any of the assigned pins goes high, the pin state is considered high.  
(2) There is a separate bit for each regulator.

**表 8-3. LDO Mode Summary - Unassigned LDO**

CONFIG2	Device State	KEEP_ON Bit <sup>(1)</sup>	SET_OFF Bit <sup>(1)</sup>	ECO Bit <sup>(1)</sup>	Resource Mode
GND	—	x	x	0	Normal
GND	—	x	x	1	Eco
LDOAO	ACTIVE	x	x	0	Normal
LDOAO	ACTIVE	x	x	1	Eco
LDOAO	SLEEP	0	0	x	Eco
LDOAO	SLEEP	0	1	x	Off
LDOAO	SLEEP	1	x	0	Normal
LDOAO	SLEEP	1	x	1	Eco

- (1) There is a separate bit for each regulator.

#### 8.4.4.2 DCDC Mode Summary

The DCDC regulators are similar to the LDO regulators, but they have an additional on state option to choose between auto and force PWM modes.

**表 8-4. DCDC Mode Summary - Assigned DCDC**

Assigned Pin(s) State <sup>(1)</sup>	DCDCx_MODE Bit <sup>(2)</sup>	KEEP_ON Bit <sup>(2)</sup>	SET_OFF Bit <sup>(2)</sup>	Resource Mode
Low	x	0	1	Off
Low	0	0	0	Eco
Low	0	1	x	Auto
Low	1	0	0	PWM
Low	1	1	x	PWM
High	0	x	x	Auto
High	1	x	x	PWM

- (1) This is an OR of all assigned pins. If any of the assigned pins goes high, the pin state is considered high.  
(2) There is a separate bit for each regulator.

**表 8-5. DCDC Mode Summary - Unassigned DCDC**

CONFIG2	Device State	KEEP_ON Bit <sup>(1)</sup>	SET_OFF Bit <sup>(1)</sup>	DCDCx_MODE Bit <sup>(1)</sup>	ECO Bit <sup>(1)</sup>	Resource Mode
GND	—	x	x	0	0	Auto
GND	—	x	x	0	1	Eco
GND	—	x	x	1	x	PWM
LDOAO	ACTIVE	x	x	0	0	Auto
LDOAO	ACTIVE	x	x	0	1	Eco
LDOAO	ACTIVE	x	x	1	x	PWM
LDOAO	SLEEP	0	0	0	x	Eco
LDOAO	SLEEP	0	0	1	x	PWM
LDOAO	SLEEP	0	1	x	x	Off

**表 8-5. DCDC Mode Summary - Unassigned DCDC (continued)**

CONFIG2	Device State	KEEP_ON Bit <sup>(1)</sup>	SET_OFF Bit <sup>(1)</sup>	DCDCx_MODE Bit <sup>(1)</sup>	ECO Bit <sup>(1)</sup>	Resource Mode
LDOAO	SLEEP	1	x	0	0	Auto
LDOAO	SLEEP	1	x	0	1	Eco
LDOAO	SLEEP	1	x	1	x	PWM

(1) There is a separate bit for each regulator.

#### 8.4.4.3 Voltage Selection Summary

All four DCDC regulators have two voltage register options, one located in the DCDCx\_OP register and one in the DCDCx\_AVS register. The first four LDOs (LDO1, LDO2, LDO3, and LDO4) also have LDOx\_OP and LDOx\_AVS registers. The selection of which voltage is used can be summarized in the following table.

**表 8-6. Voltage Selection Summary**

CONFIG2	Assigned Pin(s) State or Device State <sup>(1)</sup>	SELREG Bit <sup>(2)</sup>	DEF_VOLT Bit <sup>(2)</sup>	DCDCx_SEL Pin <sup>(3)</sup>	Voltage
GND	—	x	x	1	_AVS
GND	—	x	x	0	_OP
LDOAO	High or ACTIVE	1	x	—	_AVS
LDOAO	High or ACTIVE	0	x	—	_OP
LDOAO	0 or SLEEP	1	x	—	_AVS
LDOAO	0 or SLEEP	0	1	—	_AVS
LDOAO	0 or SLEEP	0	0	—	_OP

(1) For any regulators which are set in an ENx\_SETx register, this is an OR of all assigned pins. If any of the assigned pins goes high, the pin state is considered high. For any regulators which are not set in an ENx\_SETx register, the device state is used.

(2) There is a separate bit for each regulator.

(3) For LDO1, LDO2, LDO3, and LDO4, this is based on the DEF\_VOLT\_MAPPING register.

#### 8.4.5 Details of CONFIG2, Device State, and Enable Pin Settings on Regulators

The full details of the behavior of the device based on the above signals and settings is outlined below.

##### 8.4.5.1 EN1, EN2, EN3, and EN4 Resources Control

The ENx control signals can turn resources on and off as well as setting them into Eco-mode or changing the output voltage register from \_AVS to \_OP. Assigning several resources to one ENx control signal is possible. Assigning a resource to several ENx control signals is also possible. The inputs are connected to an OR gate, so if any assigned ENx pin is high, the assigned resource is considered enabled. Default configuration of the ENx control signals is done in OTP memory; however, changing the ENx settings after power up is possible through the ENx\_SETx registers. The ENx control signals are effective only in the ACTIVE or SLEEP state. For more information on how the pin status on the ENx pin is interpreted, see [セクション 8.4.5.4](#).

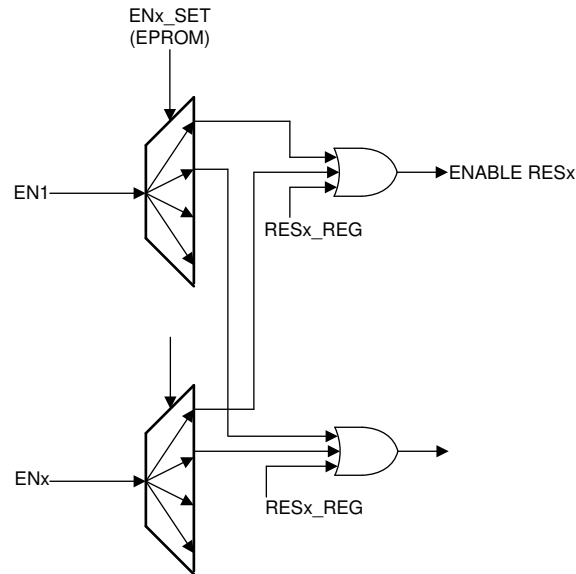

**8-10. ENx Architecture**

#### 8.4.5.2 Device SLEEP State Control

The sleep control input on the SLEEP pin is used to move the device into the SLEEP state where the resources behavior (DC-DC converters, LDO regulators, 32-kHz clock output, and thermal monitor) are defined by the SET\_OFF, KEEP\_ON, and DEF\_VOLT registers. The SLEEP pin is only active if the SLEEP\_ENABLE bit in the DEVCTRL2 register is set to 1b and all unmasked interrupts are cleared. Otherwise, the state of the SLEEP pin is ignored. Additionally, the polarity of the SLEEP pin is controlled by the SLEEP\_POL bit in the DEVCTRL2 register.

#### 8.4.5.3 SET\_OFF, KEEP\_ON, and DEF\_VOLT Registers Used in SLEEP State with CONFIG2 Pin Shorted to LDOAO

The DCDC1, DCDC2, DCDC3, and DCDC4 converters and LDO1, LDO2, LDO3, and LDO4 regulators allow changing the output voltage depending on the ACTIVE state versus SLEEP state. To program the SET\_OFF, KEEP\_ON, and DEF\_VOLT registers:

- Keep the resource enabled in the SLEEP state by setting the KEEP\_ON bit to 1b. The SET\_OFF bit is ignored in this case. The DEF\_VOLT bit will determine whether \_OP (0b) or \_AVS (1b) voltage is used in this case.
- Set the resource to Eco-mode in the SLEEP state by setting the SET\_OFF bit to 0b and the KEEP\_ON bit to 0b. The DEF\_VOLT bit will determine whether \_OP (0b) or \_AVS (1b) voltage is used in this case.
- Turn the resource off in the SLEEP state by setting the SET\_OFF bit to 1b and the KEEP\_ON bit to 0b.

#### 8.4.5.4 SET\_OFF, KEEP\_ON, and DEF\_VOLT Registers Used for Resources Assigned to an External Enable Pin with CONFIG2 Pin Shorted to LDOAO

As described in [セクション 8.4.3](#), a resource can be assigned to an enable pin. In this case, the SLEEP state of the device has no effect on an assigned resource. Instead, the behavior of the resource is defined by the state of the enable pin. The SET\_OFF, KEEP\_ON, and DEF\_VOLT registers are remapped and used to define how a resource functions when the enable pin is set low or is set high. When the resource's assigned ENx pin is high, the assigned resource behaves as if the device was in the ACTIVE state. When the resource's assigned ENx pin is low, the assigned resource behaves as if the device was in the SLEEP state. To control the resource:

- The resource is enabled when the ENx pin is set high. The SET\_OFF and KEEP\_OFF bits are ignored in this case.
- Enable the resource when the ENx pin is set low by setting the KEEP\_ON bit to 1b. The SET\_OFF bit is ignored in this case.

- Disable the resource when the ENx pin is set low by setting the SET\_OFF bit to 1b and the KEEP\_ON bit to 0b.
- Set the resource to Eco-mode when the ENx pin is set low by setting the SET\_OFF bit to 0b and the KEEP\_ON bit to 0b.
- Change the output voltage of a resource when the ENx pin is set low:
  - Set the DEF\_VOLT bit to 0b and the voltage will be defined by the \_OP register.
  - Set the DEF\_VOLT bit to 1b and the voltage will be defined by the \_AVS register.

#### 8.4.5.5 SET\_OFF, KEEP\_ON, and DEF\_VOLT Registers Used for Resources Assigned to Pins PWR\_REQ, CLK\_REQ1 and CLK\_REQ2 with CONFIG2 pin shorted to GND

With the CONFIG2 pin tied to GND, the ENx pins are used as the voltage-select pins (DCDCx\_SEL) for the DC-DC converters and LDO regulators assigned to these pins by the DEF\_VOLT\_MAPPING register. These pins are only used to switch the output voltage between two values as defined in the \_OP (DCDCx\_SEL pin set to 0) and \_AVS (DCDCx\_SEL pin set to 1) registers.

The basic function of enabling or disabling resources is remapped to the PWR\_REQ, CLK\_REQ1, and CLK\_REQ2 pins. The pin function is managed by the ENx\_SETx registers in the following list.

- PWR\_REQ: EN1\_SETx
- CLK\_REQ1: EN2\_SETx
- CLK\_REQ2: EN3\_SETx

The EN4\_SETx register is not used and should be set 0h.

#### 8.4.5.6 Configuration Pins CONFIG1, CONFIG2, and DEF\_SPI\_I2C-GPIO

The TPS659128x device contains two banks of OTP memory that define the programmed default settings. The CONFIG1 pin selects between these two banks of memory. The logic level at the CONFIG1 pin in the CONFIG state determines which of the OTP banks is used. The content of that OTP bank is then copied to the user registers to set all OTP configurable options, such as default voltages and power-up timing.

The CONFIG2 bit is used to remap functions to pins. When the CONFIG2 pin is shorted to LDOAO, the EN1, EN2, EN3, EN4, SCL\_AVS, SDA\_AVS, and SLEEP pins are active. When the CONFIG2 pin is shorted to GND, these pins are used as DCDCx\_SEL, CLK\_REQ1, CLK\_REQ2, and PWR\_REQ pins. 表 8-7 lists the default and alternative pin functions.

表 8-7. Pin Configuration Based on CONFIG2 Pin

CONFIG2 PIN SHORTED TO LDOAO; DEFAULT PIN USAGE	DEFAULT FUNCTION	CONFIG2 PINSHORTED TO GND; ALTERNATE PIN USAGE	ALTERNATE FUNCTION
EN1	Enable pin for a set of DC-DC converters and LDOs defined by register EN1_SET1 and EN1_SET2 for resources that are mapped to a pin, SET_OFFx, KEEP_ONx and DEF_VOLT define behavior for the case when EN1=0	DCDC1_SEL	DCDC1_SEL = 1b: output voltage is defined by DCDC1_AVS register DCDC1_SEL = 0b: output voltage is defined by DCDC1_OP register
EN2	Enable pin for a set of DC-DC converters and LDOs defined by register EN2_SET1 and EN2_SET2 for resources that are mapped to a pin, SET_OFFx, KEEP_ONx and DEF_VOLT define behavior for the case when EN2=0	DCDC2_SEL	DCDC2_SEL = 1b: output voltage is defined by DCDC2_AVS register DCDC2_SEL = 0b: output voltage is defined by DCDC2_OP register
EN3	Enable pin for a set of DC-DC converters and LDOs defined by register EN3_SET1 and EN3_SET2 for resources that are mapped to a pin, SET_OFFx, KEEP_ONx and DEF_VOLT define behavior for the case when EN3=0	DCDC3_SEL	DCDC3_SEL = 1b: output voltage is defined by DCDC3_AVS register DCDC3_SEL = 0b: output voltage is defined by DCDC3_OP register
EN4	Enable pin for a set of DC-DC converters and LDOs defined by register EN4_SET1 and EN4_SET2 for resources that are mapped to a pin, SET_OFFx, KEEP_ONx and DEF_VOLT define behavior for the case when EN4=0	DCDC4_SEL	DCDC4_SEL = 1b: output voltage is defined by DCDC4_AVS register DCDC4_SEL = 0b: output voltage is defined by DCDC4_OP register

**表 8-7. Pin Configuration Based on CONFIG2 Pin (continued)**

CONFIG2 PIN SHORTED TO LDOAO; DEFAULT PIN USAGE	DEFAULT FUNCTION	CONFIG2 PIN SHORTED TO GND; ALTERNATE PIN USAGE	ALTERNATE FUNCTION
SLEEP	Used to transition the device between the ACTIVE and SLEEP states when there are no pending interrupts and the SLEEP_ENABLE bit is set to 1b. Polarity controlled by the SLEEP_POL bit.	PWR_REQ	Enable pin for a set of DC-DC converters and LDOs Defined by register EN1_SET1 and EN1_SET2
SCL_AVS	Clock input of the voltage scaling (AVS) I <sup>2</sup> C interface	CLK_REQ1	Enable pin for a set of DC-DC converters and LDOs Defined by register EN2_SET1 and EN2_SET2
SDA_AVS	Data input/output of the voltage scaling (AVS) I <sup>2</sup> C interface	CLK_REQ2	Enable pin for a set of DC-DC converters and LDOs Defined by register EN3_SET1 and EN3_SET2

The DEF\_SPI\_I2C-GPIO pin defines whether the SPI or the I<sup>2</sup>C interface is used as the standard communication interface. Setting the DEF\_SPI\_I2C-GPIO to 0 defines SPI as the standard interface associated to the SCL\_SCK, SDA\_MOSI, GPIO1\_MISO, and GPIO2\_CE pins. The CONFIG1, CONFIG2, and DEF\_SPI\_I2C-GPIO pins should be tied to GND for a low level and to the LDOAO pin for a logic high level.

The CONFIG1, CONFIG2, and DEF\_SPI\_I2C-GPIO pins should not be switched in operation but hardwired to a logic-low level (GND) or a logic-high level by connecting the pins to the LDOAO voltage.

#### 8.4.6 Active Voltage Scaling Control

The output voltage of all the DCDC regulators, LDO1, LDO2, LDO3, and LDO4 can be changed during operation to match the system requirements. For example, this feature is useful for processors looking to minimize power loss or maximize performance. Alternatively, it can be used to select between different voltages based on the system configuration. For example, if different DDR options are available, then voltage can be selected to match the requirement of the DDR. The voltage can be changed in two different ways, outlined below.

##### 8.4.6.1 Voltage-Scaling Interface Control Using *\_OP* and *\_AVS* Registers With SPI or I<sup>2</sup>C Interface

Typically, the standard SPI or I<sup>2</sup>C interface is used to communicate with the part. If there is a potential that the added voltage scaling bus traffic would interfere with other operations, a dedicated I<sup>2</sup>C interface is available for voltage scaling functionality. Resources are assigned to this interface by setting the DCDCx\_AVS bits in the I2C\_SPI\_CFG register. The interface works in three different modes.

- With CONFIG2 shorted to LDOAO, the standard I<sup>2</sup>C or SPI voltage scaling interface can be used where output voltage is set in the resource's AVS and OP registers and the SELREG and DEF\_VOLT bits are used to switch between the two voltage values.
- With CONFIG2 shorted to LDOAO, the power-I<sup>2</sup>C voltage scaling interface can be used instead. It operates the same as standard I<sup>2</sup>C but access to the DCDCx\_OP and DCDCx\_AVS registers of the assigned regulators use an alternate I<sup>2</sup>C address and cannot be accessed through the standard I<sup>2</sup>C bus. This is enabled with the DCDCx\_AVS bits in the I2C\_SPI\_CFG register.
- With CONFIG2 shorted to GND, DCDCx\_SEL pins can be used as roof or floor configuration where the DC-DC voltage switches between the value defined in the DCDCx\_OP register and the DCDCx\_AVS register.

The voltage slew rate of the DCDCx regulators reaching a new programmed value is programmable through the TSTEP bits located in the DCDCx\_CTRL registers.

Both I<sup>2</sup>C interfaces are compliant with HS-I<sup>2</sup>C specification (100 kbits/s, 400 kbits/s, or 3.4 Mbits/s)

Shorting the CONFIG1 pin to GND selects OTP option A. Shorting the CONFIG1 pin to LDOAO selects the OTP option B. These values are loaded only during the device CONFIG state.

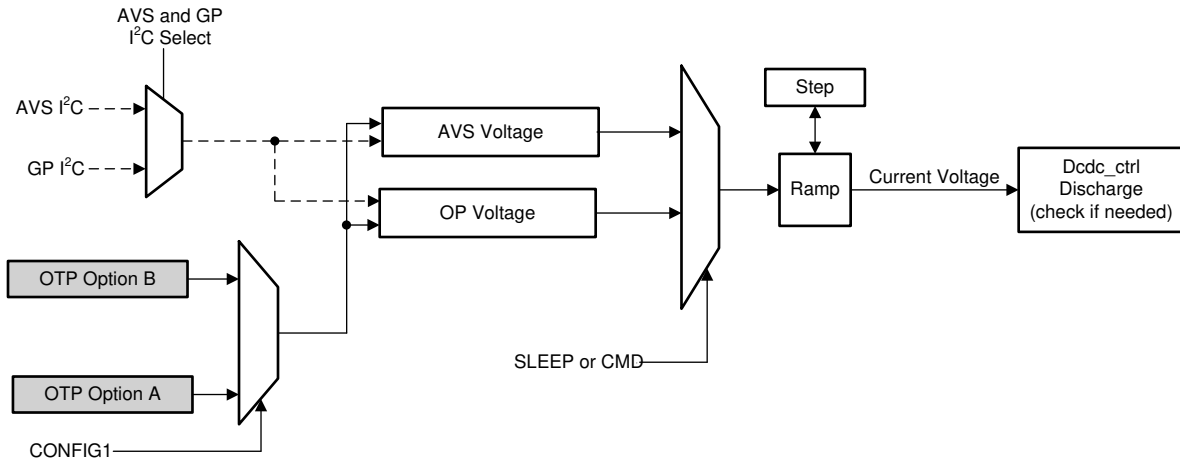

**图 8-11. DC-DC Voltage Scaling Architecture**

#### 8.4.6.2 Voltage Scaling Using the VCON Decoder on VCON\_PWM and VCON\_CLK Pins

For specific processors, there is an option to set the voltage using analog signals, rather than I<sup>2</sup>C or SPI. For such processors, the output voltage control for the DCDC1 converter can be controlled by the VCON pins when the VCON\_ENABLE bit in the DCDC1\_CTRL register is set to 1b.

When enabled, VCON sets the voltage based on the VCON\_PWM signal duration during 32 cycles of the VCON\_CLK signal. The VCON decoder validates that the generated output voltage does not exceed 1.1 V when a 25-mV step size is selected. For PWM ratios 0:32 to 7:32, the output voltage is fixed at 1.1 V. Four ranges can be selected by setting the VCON\_RANGE[1:0] bits in the DCDC1\_CTRL register.

The VCON\_CLK and VCON\_PWM signal must be active and one complete frame (32 clock cycles) must be received by the TPS659128x device before it is enabled with the VCON\_ENABLE bit. When the VCON\_ENABLE bit is set to 0b, the voltage setting is reverted back to the DCDC1\_AVS or DCDC1\_OP register depending on the pins summarized in 表 8-6 and the range bits also revert back to the value set in the DCDC1\_LIMIT register. For VCON mode, the RANGE bits and MAX\_SEL bits in the DCDC1\_LIMIT register are ignored.

The function calculates the desired converter voltage based on the incoming PWM information. The maximum CLK frequency is 30 MHz. The period of the PWM signal is 1/32 of VCON\_CLK. The decoding follows 式 1.

$$V_{OUT} = V_{RANGE\_MAX} - \text{Count} \times \text{Step Size} \quad (1)$$

where

- $V_{OUT}$  is the resulting converter voltage.
- $V_{RANGE\_MAX}$  is the maximum voltage from the voltage range selected in the VCON\_RANGE bits.
- Count is the number of VCON\_CLK cycles during which VCON\_PWM is high within 32 clock cycles of VCON\_CLK.
- Step Size is the step size from the voltage range selected in the VCON\_RANGE bits

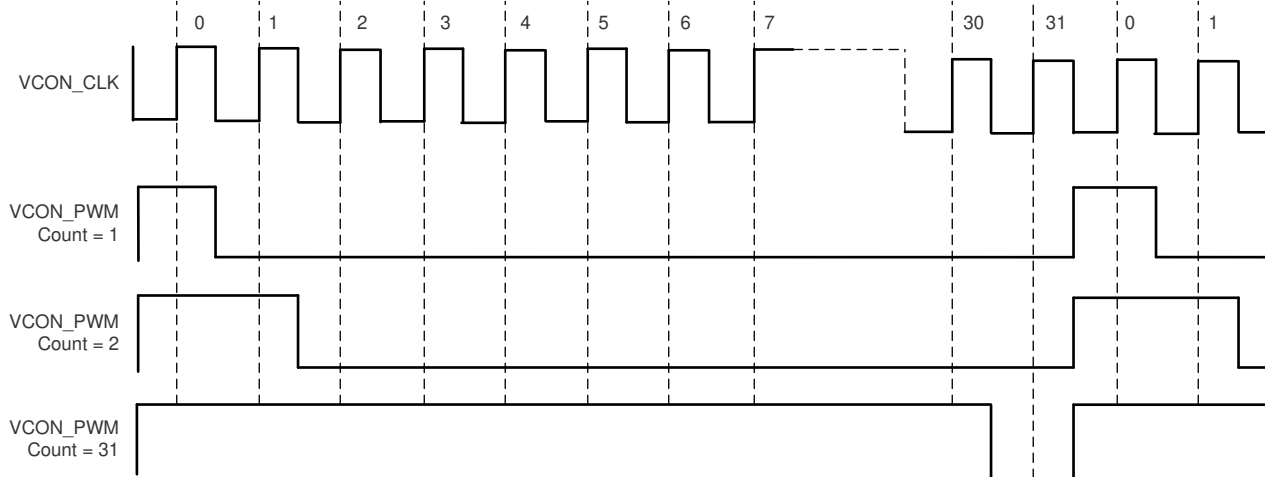

8-12. VCON Voltage Scaling Architecture

### 8.4.7 VDDIO Voltage for Push-Pull Output Stages

A number of outputs are available that are push-pull outputs or can be configured as push-pull outputs. Any pin with a push-pull output stage generates its output high level by the voltage applied to the VDDIO pin. The input voltage range on the VDDIO pin is 1.6 V to 3.3 V with an UVLO threshold below 1.6 V. With a VDDIO voltage below the UVLO threshold, the high-side driver of the push-pull output stages is disabled and the output default goes back to open drain. The affected pins include:

- nRESPWRON / VSUP\_OUT push-pull or open drain defined by the nRESPWRON\_OUTPUT bit in the DEVCTRL register
- INT1 push-pull or open drain defined by the INT\_OUTPUT bit in the DEVCTRL2 register
- GPIO1, GPIO2: push-pull only
- GPIO3, GPIO4, GPIO5: push-pull or open drain managed by the GPIOx registers
- OMAP\_WDI\_32k\_OUT

### 8.4.8 Digital Signal Summary

The digital signals are defined as:

#### SLEEP

When all SLEEP conditions are met (the CONFIG2 pin is shorted to LDOAO, no pending interrupts, and SLEEP\_ENABLE bit set to 1b), the SLEEP pin can be used to enter the SLEEP state which impacts LDO regulator and DC-DC converter behavior based on the settings defined in the SET\_OFF, KEEP\_ON, and DEF\_VOLT registers. An interrupt or a change in the SLEEP pin level causes a transition back to the ACTIVE state. This input signal is level sensitive and no debouncing is applied. The SLEEP pin is configurable and is disabled by default, so at power up, its status is ignored. The SLEEP\_ENABLE bit in the DEVCTRL2 register is used to make the SLEEP pin active and its active level is changed between active HIGH or active LOW using the SLEEP\_POL bits. The SLEEP state can also be entered using the DEV\_SLP bit in the DEVCTRL register as long as no interrupts are pending, however an interrupt must be unmasked to trigger a SLEEP-to-ACTIVE transition or else the device will stay in the SLEEP state until the device enters the OFF state.

#### PWRHOLD

The PWRHOLD pin can be used as ON/OFF signal input when the nPWRON pin and interrupt are not used or in parallel with these power-on conditions. The PWRHOLD pin can also be used as an acknowledge (maintain power) of a power-up sequence triggered by an interrupt or the falling edge of the nPWRON pin. The PWRHOLD input signal is level sensitive and no debouncing is applied. The rising edge, falling edge, or both edges of the PWRHOLD pin are highlighted through an associated interrupt if the interrupt is unmasked.



<b>NRESPWRON/ VSUP_OUT</b>	<p>The NRESPWRON signal is used as the reset to the processor and is in the VDDIO domain. The signal is held low until the ACTIVE state is reached. For detailed timing, see the relevant application note for the part number specific settings.</p> <p>The VSUP_OUT signal is the output of the voltage monitor that can alternatively be used as a reset to a processor. It can be included in the power sequencing such that the power-up sequence is delayed until its output is HIGH or the device powers down when the output is LOW.</p>
<b>32KCLKOUT</b>	<p>This signal is the output of the 32-kHz RC oscillator, which can be enabled during the power-on sequence. This signal can be enabled and disabled by setting the CLK32KOUT_EN bit in the CLK32KOUT register when the device is in the ACTIVE state.</p>
<b>nPWRON</b>	<p>The nPWRON input is generally connected to an external button. A debounced falling edge on this signal causes a transition from the OFF state to the ACTIVE state. If the device is in the ACTIVE or SLEEP state, then a low level on this signal can generate an interrupt. If the nPWRON signal is low for more than 5 seconds, one of the PWRON_LP_OFF bits are set to 1b, and the corresponding PWRON_LP_IT interrupt is not acknowledged by the external processor in 1 second, then the device goes to the OFF state. An OTP option is available to have falling edge of nPWRON pin cause device reset. When used this way, it is described as nRESIN.</p>
<b>INT1</b>	<p>The INT1 signal (active low) warns the host processor of any event that occurred on the TPS659128x device. The host processor can then poll the interrupt from the interrupt status register through I<sup>2</sup>C to identify the interrupt source. If the INT_POL bit is set to 0b, a low level indicates an active interrupt, highlighted in the INT_STSx registers. An active Interrupt flag generates a POWER ON enable condition pulse of 5 seconds only when the device is in the OFF state (when the NRESPWRON signal is low). The POWER ON enable condition pulse will occur only if the interrupt status bit is initially inactive (no previous interrupt pending in the status register). The interrupt status register must be cleared first to allow device to power off during the 5 second pulse duration. Any of the interrupt sources can be masked programming INT_MSKx registers. The default setting is masking all interrupts. When an interrupt is masked, its corresponding interrupt status bit is still updated, but the INT1 flag is not activated. Interrupt source masking can be used to mask a device switch-on event. The INT output can be programmed as push-pull or open drain output stage with either active LOW or active HIGH output defined by two OTP settings.</p>
<b>GPIO1, GPIO2, GPIO3, GPIO4, GPIO5</b>	<p>The GPIOx signals are muxed with the LED and SPI. The GPIOx signal can be used for event detection or control of external resources during power up.</p>
<b>VCCS/VIN_MON</b>	<p>This signal is the input for the internal UVLO monitor. The block provides a selectable low-battery warning as well as a undervoltage shutdown.</p>
<b>VCON_CLK, VCON_PWM</b>	<p>These signals are the clock and data inputs for voltage scaling of the DCDC1 converter using a custom PWM type voltage scaling. The feature is enabled by the VCON_ENABLE bit in the DCDC1_CTRL register. When enabled, voltage scaling through the DCDC1_OP and DCDC1_AVS registers is blocked.</p>
<b>CLK, MOSI, MISO, CE</b>	<p>These signals are the clock, chip enable (CE), master-in slave-out (MISO), and master-out slave-in (MOSI) pins for the SPI. The pins are shared with the standard I<sup>2</sup>C interface SCL and SDA and GPIO1 and GPIO2.</p>
<b>DEF_SPI_I2C- GPIO</b>	<p>This signal defines whether multifunction pins are used for the SPI or for the I<sup>2</sup>C interface and GPIOs. When the DEF_SPI_I2C-GPIO pin is set to low, the function is assigned to the SPI on the CLK, MOSI, MISO, and CE pins. When the DEF_SPI_I2C-GPIO pin is set to high, the function is assigned to the I<sup>2</sup>C interface and GPIOs on the SCL, SDA, GPIO1, and GPIO2 pins.</p>
<b>SCL_AVS, SDA_AVS</b>	<p>These signals are used in the power I<sup>2</sup>C interface, typically used for DVS on the step-down converters. Each step-down converter has a bit to switch the voltage scaling registers from</p>



the standard I<sup>2</sup>C interface or SPI to the power-I<sup>2</sup>C interface. When switched to the power-I<sup>2</sup>C, the register is blocked for access through the standard interface.

### 8.4.9 Load Switch

The load switch on the TPS659128x device can be used as the following:

- Bypass switch for the DCDC4 converter
- Current limited switch if the TPS659128x device is used in USB-powered applications
- A switch to turn on and off high current loads such as SD cards

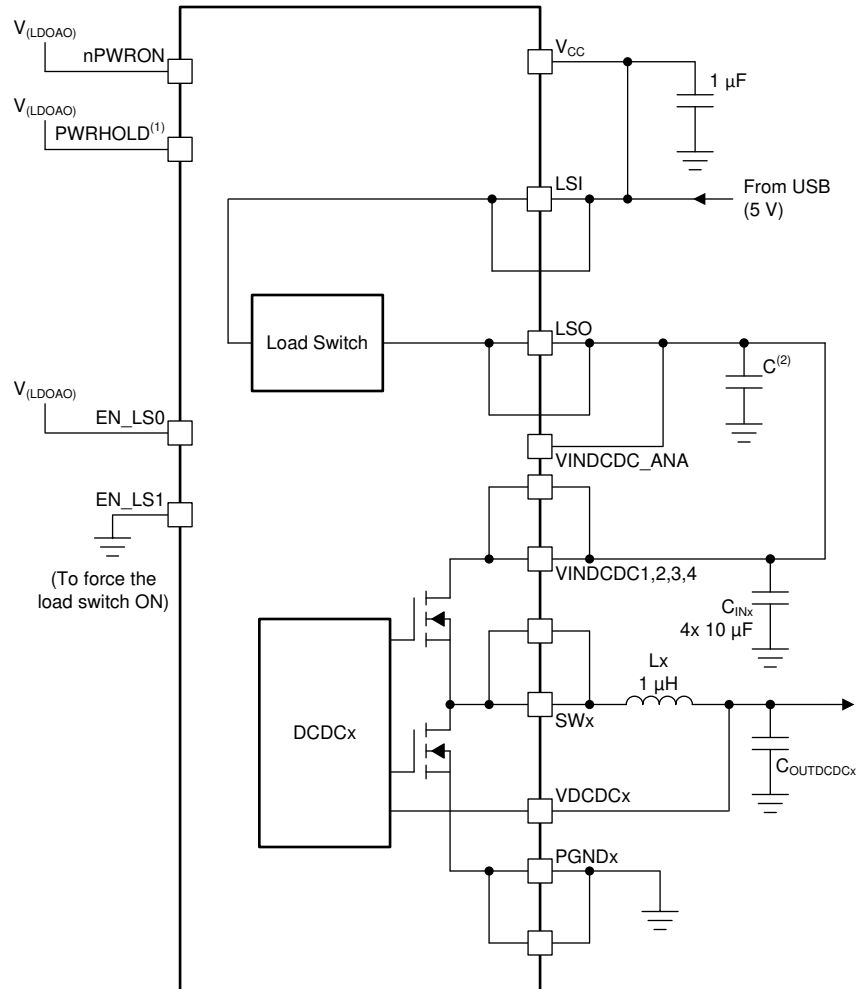

- Tie the PWRHOLD pin to LDOAO voltage to turn on automatically when 5 V is applied.
- The capacitor size is dependent on buffer requirements.

**8-13. Load Switch Connected as USB Input Current Limited Switch**

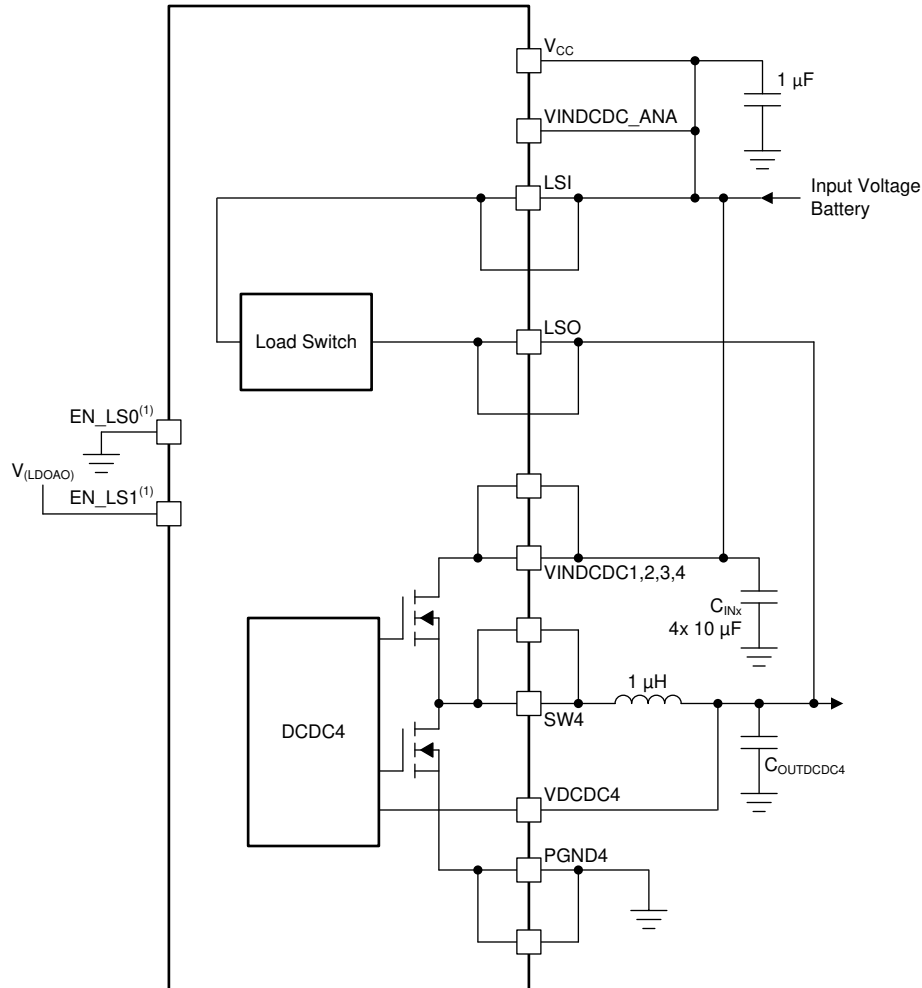

A. The EN\_LS1 pin must be high and the EN\_LS0 pin must be low to auto-enable the load switch based on the comparator in DCDC4.

#### 8-14. Load Switch Connected as BYPASS Switch for DCDC4

The LOADSWITCH register allows the load switch to be used as a bypass switch on the DCDC4 converter or as a current limited switch. Four programmable current limits are available from 90 mA (typical) to 2.5 A with the default current defined by an OTP setting. The enable bits are mapped to the external pins, EN\_LS0 and EN\_LS1. The status of the pins is copied to the register in the CONFIG state and therefore the usage of the load switch can be externally predefined. In the ACTIVE state (or SLEEP state) the functionality of the load switch is controlled by the ENABLE0 and ENABLE1 bits only to turn the load switch on, turn it off, or assign it to a comparator as a bypass switch for the DCDC4 converter. When the enable function is set to the comparator, it is auto-enabled based on the voltage differential of  $V_{IN}$  to  $V_{OUT}$  on the DCDC4 step-down converter.

Two additional features are available in case the load switch is used as a bypass switch for the DCDC4 converter. The following features are enabled with the LOADSWITCH:ENABLE[1:0] bit by setting it to either 10b or 11b:

- Forced PWM mode of the DCDC4 converter is blocked if the bypass switch is closed
- The bypass switch is opened automatically when an overvoltage condition happens. The LOADSWITCH:ENABLE[1:0] bit is automatically set 00b in an overvoltage event so the switch is opened.

In applications where the load switch is used as an USB-input current limited switch or as a load switch on the output of a DC-DC converter to LDO regulator, the previously listed features must be disabled. This case happens when the load switch is enabled by setting the LOADSWITCH:ENABLE[1:0] bit to 01b.

For more information, see the LOADSWITCH register in [Register Descriptions](#).

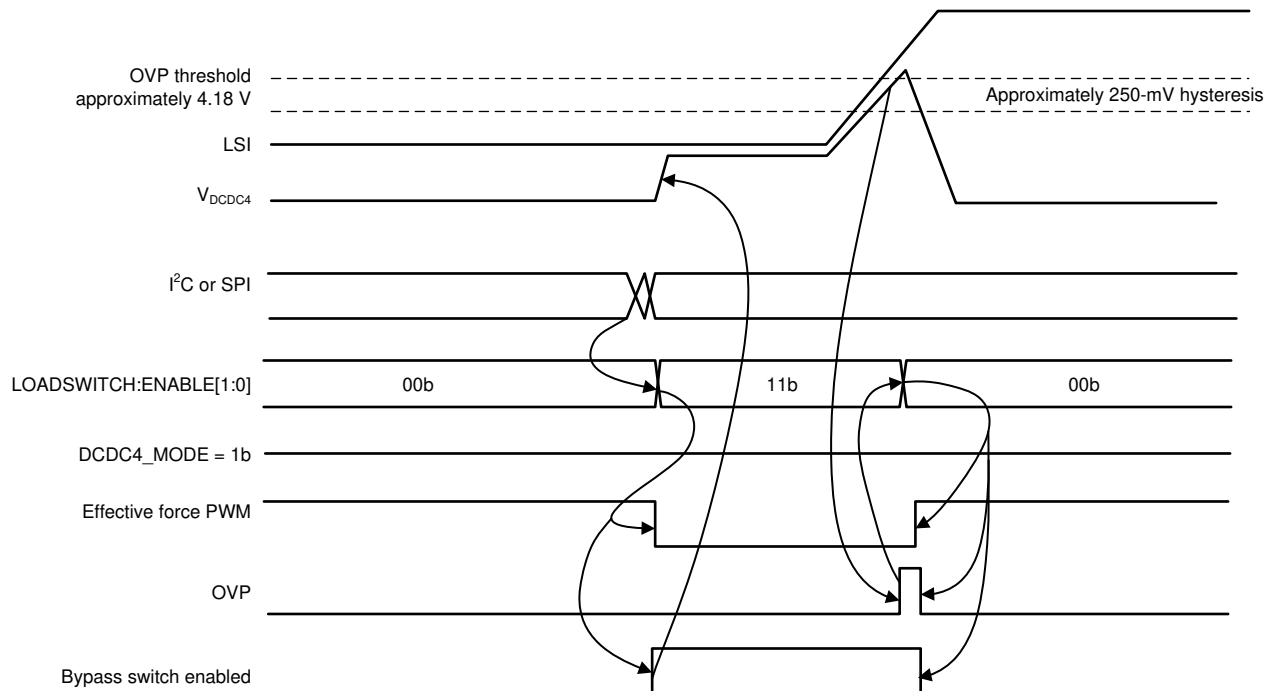

- A. OVP enable = LOADSWITCH:ENABLE[1:0] = 10b or 11b LOADSWITCH:ENABLE[1] = 0b → OVP enable = OVP = 0 If OVP hysteresis <  $V_{DCC4} < OVP$  when LOADSWITCH:ENABLE[1] goes high, OVP indicates  $V_{DCC4} < OVP$

**8-15. Load Switch Timing for LOADSWITCH:ENABLE[1:0] = 10b or 11b**

**8.4.10 LED Driver**

The GPIO3, GPIO4, and GPIO5 resources can alternatively be configured to drive the LEDs by setting the GPIO\_SEL bit to 1b in the GPIOx register. This setting switches the output stage to a current sink controlled by the LED control registers (LEDx\_CTRLx, LED\_RAMP\_UP\_TIME, LED\_RAMP\_DOWN\_TIME, and LED\_SEQ\_EN). The LEDs are enabled in the LED\_SEQ\_EN register. The LED current sink is pulse-width modulated with the duty cycle defined by the LEDx\_PWM[4:0] bit in the LEDx\_CTRL7 register. All three GPIOs should either be assigned as an LED driver or as a standard GPIO.

To turn on LEDA with a constant current of 10 mA:

- Set the GPIO as an LED current sink output by setting the GPIOA:GPIO\_SEL bit to 1.
- Set the constant current to 10 mA by setting the LEDA\_CTRL1:LEDA\_CURRENT[3:0] bit to 0100b.
- Set the PWM duty cycle to 100% by setting the LEDA\_CTRL7:LEDA\_PWM[4:0] bit to 11111b.
- Enable the LEDA current sink by setting the LED\_SEQ\_EN:LEDA\_EN bit to 1b.

In addition to turning on and turning off an LED, the LED driver allows the user to set LED sequence to perform a flash sequence in the hardware by enabling the flash sequencer. Setting the LEDx\_SEQ\_EN bit enables the flash sequencer for each of the three LEDs.

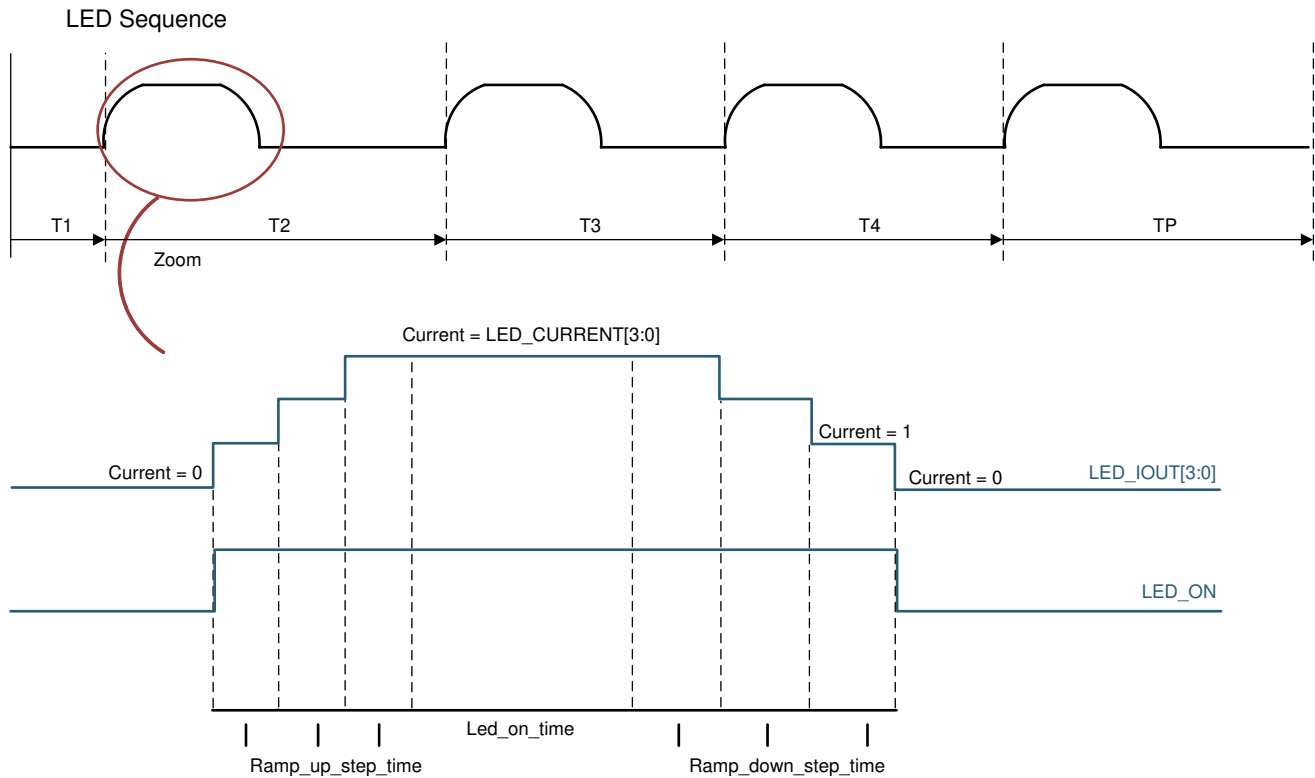

T1, T2, T3, T4 : 0, 1 ...127 × 64 ms → reg ledx\_t1, ledx\_t2 ....

Tp : 0, 1 ...127 × 64 ms → reg ledx\_tp

Ramp step time : 0, 1 ... 31 × 8 ms → reg led\_ramp\_up\_time, led\_ramp\_down\_time

### 8-16. LED Sequencer

The LED driver allows the user to set a DC current from 2 mA to 20 mA for each LED. In addition to this ability, an LED flash sequence is programmable and defined by the time slots T1, T2, T3, T4, and TP. Within these time slots, the LED can be turned on as defined by the LEDx\_ON\_TIME bit with a defined ramp-up slope set by the LED\_RAMP\_UP register and a defined ramp-down slope set by the LED\_RAMP\_DOWN register. The slopes are set to the same value for all three LEDs but other parameters are programmable independently. 8-16 shows an LED flash cycle. The ramp enable bits define whether the current immediately steps to its defined value (set by the LEDx\_CURRENT[3:0] bit) or ramps with a certain slope. If the LEDx\_RAMP\_EN bit is set to 0b during a sequence, the current immediately goes to the value defined by the LEDx\_I[3:0] bit. If the LEDx\_RAMP\_EN bit is set to 1b during a sequence, the current steps up and down to the value defined by the LEDx\_I[3:0] bit with a certain slope.

In addition, the LED current is pulse-width modulated with a duty cycle defined in the LEDx\_CTRL7 register.

For the LED driver to operate properly, the time for RAMP\_UP + LED\_ON + RAMP\_DOWN must be smaller than the sequence T<sub>n</sub> (with n = 1, 2, 3, 4, P).

### 8.4.11 Thermal Monitoring and Shutdown

Two thermal-protection modules monitor the junction temperature of the device against the respective thresholds:

- Hot-die temperature threshold
- Thermal shutdown temperature thresholds

When the hot-die temperature threshold is reached, an interrupt is sent to the software (SW) to close the noncritical running tasks.

The output of both thermal protection modules is logically ORed. When the thermal shutdown temperature threshold is reached, the TPS659128x device is set under reset and a transition to the OFF state is initiated. Then the POWER ON enable conditions of the device are not taken into consideration until the die temperature has decreased below the hot-die threshold. A hysteresis is applied to the hot-die and shutdown threshold when detecting a falling edge of temperature, and both detections are debounced to avoid any parasitic detection. The TPS659128x device allows the user to program four hot-die temperature thresholds to increase the flexibility of the system.

By default, the thermal protection is enabled in the ACTIVE state, but it can be disabled through programming the THRM\_REG register. The thermal protection is automatically enabled during a transition from the OFF state to the ACTIVE state and is kept enabled in the OFF state after a switch-off sequence caused by a thermal shutdown event. A transition to the OFF state sequence caused by a thermal shutdown event is highlighted in the INT\_STS\_REG status register. Recovery from this OFF state is initiated (switch-on sequence) when the die temperature falls below the hot-die temperature threshold.

The threshold detection state for the hot-die and thermal shutdown temperature can be monitored or masked by reading or programming the THRM\_REG register. A hot-die interrupt can be masked by programming the INT\_MSK\_REG register.

### 8.4.12 Interfaces

The TPS659128x device has three available interfaces which are a high-speed I<sup>2</sup>C interface that has access to all register, a SPI that can optionally be used to access all registers, and a high-speed power I<sup>2</sup>C interface that can be used to dynamically change the output voltage of the DC-DC converters. The power I<sup>2</sup>C interface only has access to the voltage scaling registers of the DC-DC converters. If it is activated by a selection bit, the registers it is using are blocked for the general-purpose I<sup>2</sup>C or SPI. All interfaces are active only in the ACTIVE state. In all other states, the interfaces are held in a reset and cannot be used to access the device.

### 8.4.12.1 Serial Peripheral Interface

The serial peripheral interface (SPI) uses four signals: a chip enable (SPI\_CE), the clock from the bus master (SPI\_CLK), an input port (SPI\_MOSI), and an output port (SPI\_MISO). The read-write (R/W) bit is followed by an 8-bit register address followed by 7 bits of unused bits followed by the data bits. The MISO output is set to high impedance when the TPS659128x device is not addressed by setting the CE pin LOW which allows multiple slaves on the SPI bus.

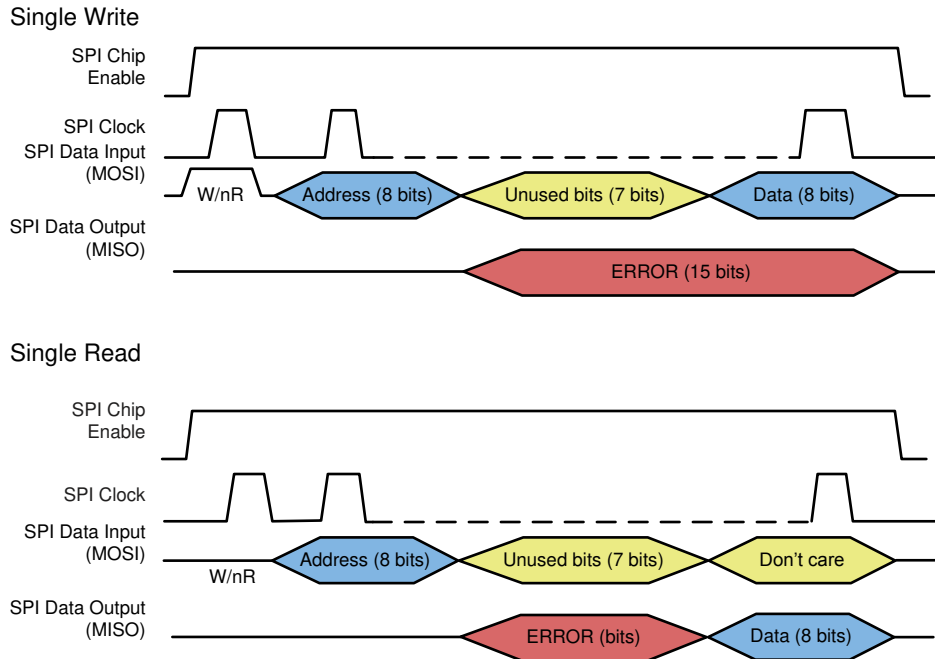

8-17. SPI READ and WRITE Protocol

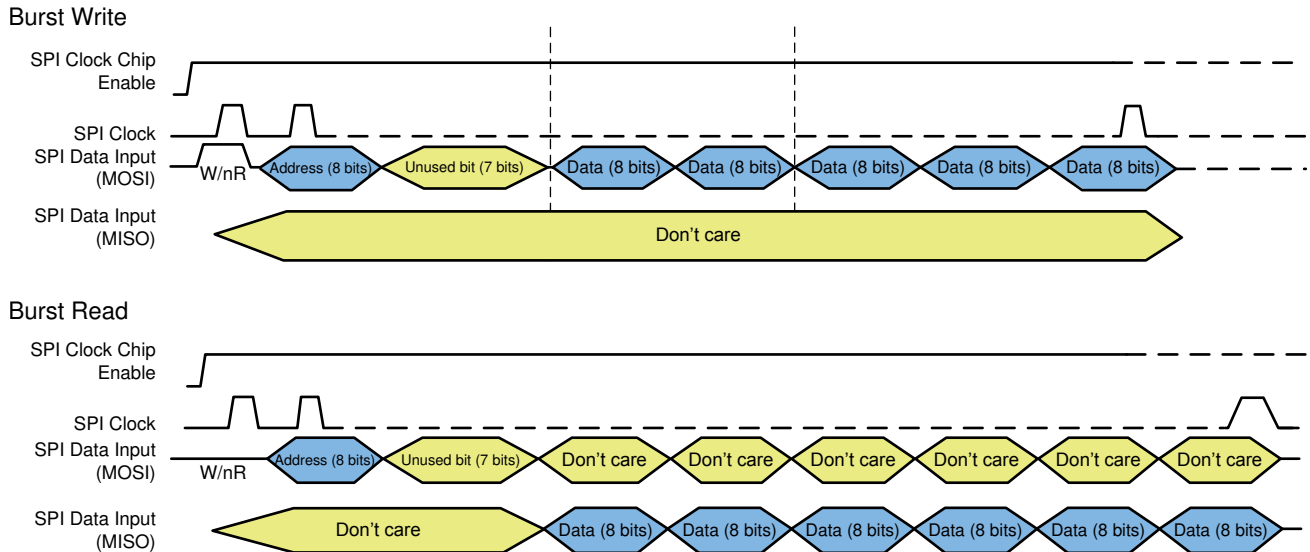

8-18. SPI BURST READ and BURST WRITE Protocol

### 8.4.12.2 I<sup>2</sup>C Interface

I<sup>2</sup>C is a 2-wire serial interface developed by NXP (formerly Philips Semiconductor) (see [I<sup>2</sup>C-Bus Specification and user manual](#)). The bus consists of a data line (SDA) and a clock line (SCL) with pullup structures. When the bus is idle, both the SDA and SCL lines are pulled high. All the I<sup>2</sup>C-compatible devices connect to the I<sup>2</sup>C bus through open-drain I/O pins, the SDA pin, and the SCL pin. A master device, usually a microcontroller or a digital signal processor, controls the bus. The master is responsible for generating the SCL signal and device addresses. The master also generates specific conditions that indicate the START and STOP of data transfer. A slave device receives, transmits data, or does both on the bus under control of the master device.

The TPS659128x device works as a slave and supports the following data transfer modes, as defined in the I<sup>2</sup>C-Bus Specification: standard mode (100 kbps), fast mode (400 kbps), and high-speed mode (up to 3.4 Mbps in write mode). The interface adds flexibility to the power-supply solution, enabling most functions to be programmed to new values depending on the instantaneous application requirements. Register contents are loaded when voltage is applied to the TPS659128x device that is higher than the UVLO level of 2.4 V. When the device is in the ACTIVE state and is turned off, the LOAD-OTP bit [bit 6 in the DEVCONTROL register] forces a reload of the registers when the LOAD-OTP bit is set to 1b (default). When the LOAD-OTP bit is set to 0b, register content is not changed unless the supply voltage drops below the UVLO threshold. The I<sup>2</sup>C interface runs off of an internal oscillator that is automatically enabled when an access to the interface happens.

The data transfer protocol for standard and fast modes is exactly the same, therefore, they are referred to as F/S-mode in this document. The protocol for high-speed mode is different from the F/S mode, and it is referred to as HS mode. The TPS659128x device supports 7-bit addressing; 10-bit addressing and general call address are not supported.

#### 8.4.12.2.1 I<sup>2</sup>C Implementation

Two I<sup>2</sup>C interfaces are available on the TPS659128x device. One interface is for general purpose use and is referred to as the general-purpose or standard I<sup>2</sup>C interface. The other interface is exclusively used for voltage scaling on the DC-DC converters and is referred to as AVS- or power-I<sup>2</sup>C interface.

The TPS659128x device has a 7-bit address with the LSB factory programmable.

The device address for the STANDARD-I<sup>2</sup>C interface is typically set to 0101101b.

The device address for the AVS-I<sup>2</sup>C interface is typically set to 0010011b.

Other default addresses can be factory programmed.

#### 8.4.12.2.2 F/S-Mode Protocol

The master device initiates data transfer by generating a start condition. The start condition is when a high-to-low transition occurs on the SDA line while the SCL pin is high (see [Figure 8-19](#)). All I<sup>2</sup>C-compatible devices should recognize a start condition.

The master device then generates the SCL pulses, and transmits the 7-bit address followed by the read-write direction (R/W bit) on the SDA line. During all transmissions, the master device ensures that data is valid. A valid data condition requires the SDA line to be stable during the entire high period of the clock pulse (see [Figure 8-20](#)). All devices recognize the address sent by the master and compare it to their internal fixed addresses. Only the slave device with a matching address generates an *acknowledge* (see [Figure 8-21](#)) by pulling the SDA line low during the entire high period of the ninth SCL cycle. This acknowledge confirms to the master that the communication link with the slave has been established.

The master device generates further SCL cycles to either transmit data to the slave device (R/W bit set to 0b) or receive data from the slave device (R/W bit set to 1b). In either case, the receiver must acknowledge the data sent by the transmitter. An acknowledge signal can either be generated by the master device or by the slave device, depending on which one is the receiver. Valid 9-bit data sequences consisting of 8-bit data and 1-bit acknowledge can continue for as long as necessary.

To signal the end of the data transfer, the master device generates a stop condition by pulling the SDA line from low to high while the SCL line is high (see [Figure 8-19](#)). This process releases the bus and stops the communication link with the addressed slave. All I<sup>2</sup>C-compatible devices must recognize the stop condition. Upon the receipt of



a stop condition, the bus is released, and all slave devices wait for a start condition followed by a matching address

Attempting to read data from register addresses not listed in [Register Descriptions](#) results in a readout of FFh.

#### 8.4.12.2.3 H/S-Mode Protocol

When the bus is idle, both the SDA and SCL lines are pulled high by the pullup devices.

The master device generates a start condition followed by a valid serial byte containing the HS master code 00001XXX. This transmission is made in F/S mode at no more than 400 Kbps. No device is allowed to acknowledge the HS master code, but all devices must recognize it and switch their internal setting to support 3.4-Mbps operation.

The master device then generates a repeated start condition (a repeated start condition has the same timing as the start condition). After this repeated start condition, the protocol is the same as F/S mode, except that transmission speeds up to 3.4 Mbps are allowed. A stop condition ends the HS mode and switches all the internal settings of the slave devices to support the F/S mode. Instead of using a stop condition, repeated start conditions are used to secure the bus in HS mode.

Attempting to read data from register addresses not listed in [Register Descriptions](#) results in a readout of FFh.

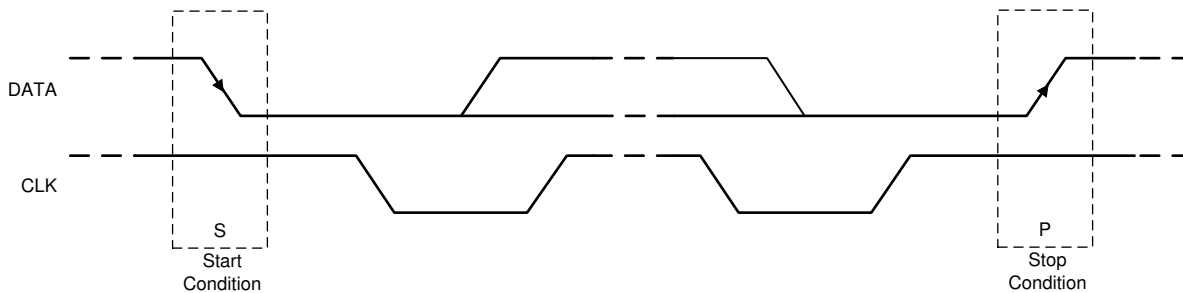

**8-19. START and STOP Conditions**

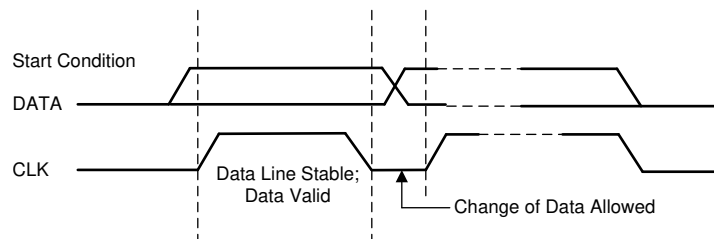

**8-20. Bit Transfer on the Serial Interface**

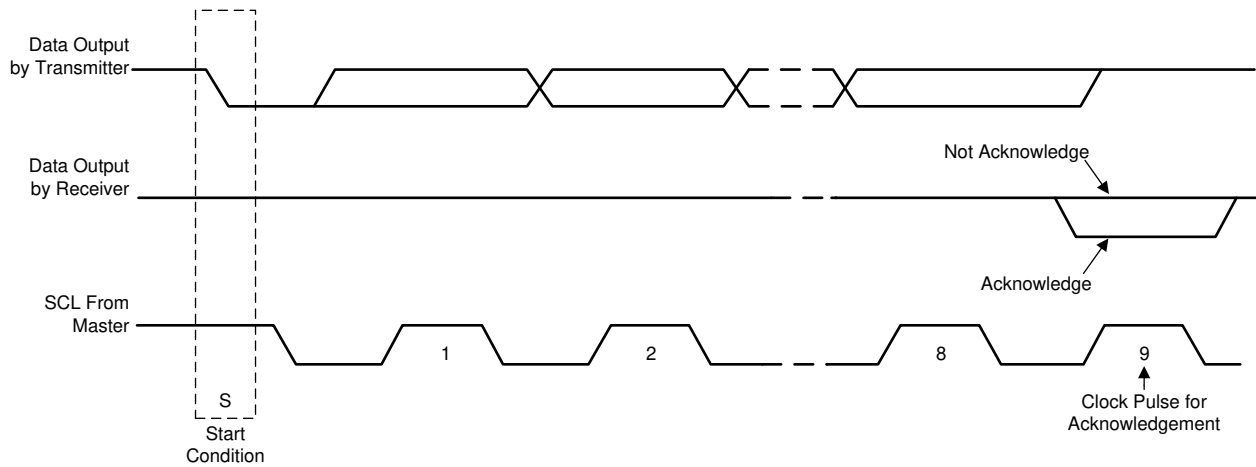

**图 8-21. Acknowledge on the I<sup>2</sup>C Bus**

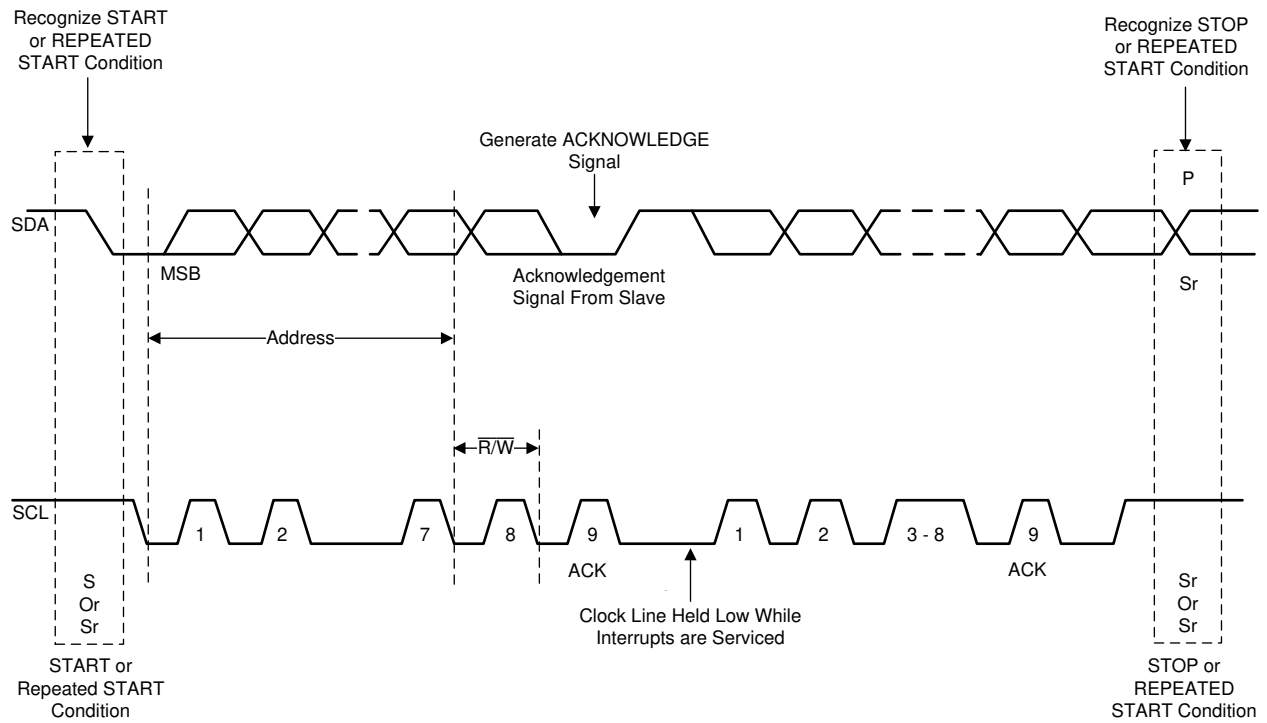

**图 8-22. Bus Protocol**

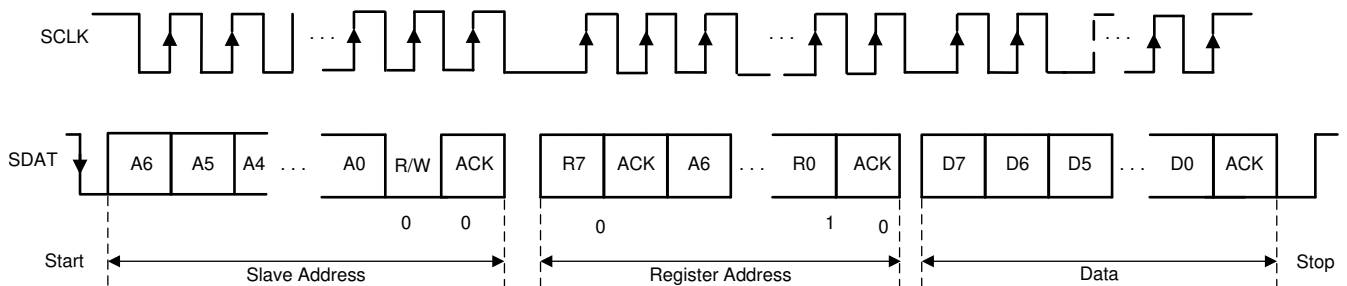

NOTE: SLAVE=TPS65912x

**图 8-23. I<sup>2</sup>C Interface WRITE to TPS659128x; F/S Mode**

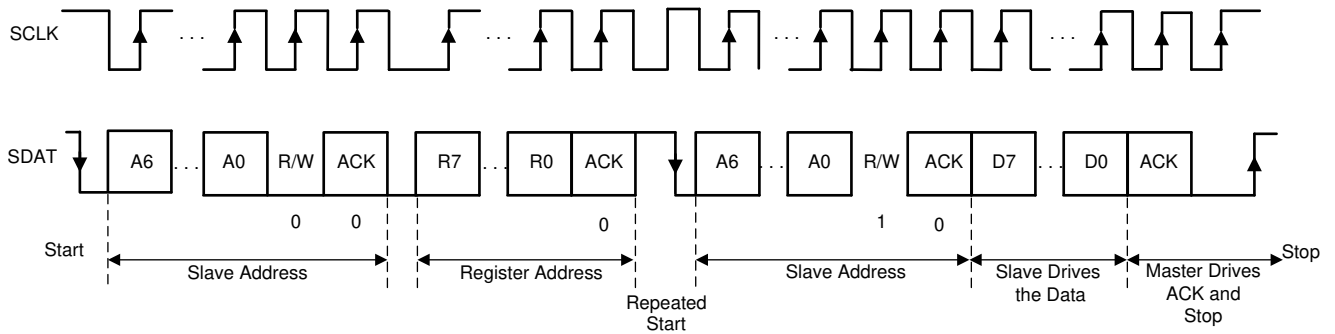

**8-24. I<sup>2</sup>C Interface READ from TPS659128x; F/S Mode**

## 8.5 Register Maps

### 8.5.1 Register Descriptions

#### 8.5.1.1 DCDC Registers (00h to 0Fh)

表 8-8 lists the memory-mapped registers for the DCDC registers. All register offset addresses not listed in 表 8-8 should be considered as reserved locations and the register contents should not be modified.

**表 8-8. DCDC Registers**

Offset	Acronym	Register Name	Section
00h	DCDC1_CTRL	DCDC1 Control Register	<a href="#">セクション 8.5.1.1.1</a>
01h	DCDC2_CTRL	DCDC2 Control Register	<a href="#">セクション 8.5.1.1.2</a>
02h	DCDC3_CTRL	DCDC3 Control Register	<a href="#">セクション 8.5.1.1.3</a>
03h	DCDC4_CTRL	DCDC4 Control Register	<a href="#">セクション 8.5.1.1.4</a>
04h	DCDC1_OP	DCDC1 OP Register	<a href="#">セクション 8.5.1.1.5</a>
05h	DCDC1_AVS	DCDC1 AVS Register	<a href="#">セクション 8.5.1.1.6</a>
06h	DCDC1_LIMIT	DCDC1 Limit Register	<a href="#">セクション 8.5.1.1.7</a>
07h	DCDC2_OP	DCDC2 OP Register	<a href="#">セクション 8.5.1.1.8</a>
08h	DCDC2_AVS	DCDC2 AVS Register	<a href="#">セクション 8.5.1.1.9</a>
09h	DCDC2_LIMIT	DCDC2 Limit Register	<a href="#">セクション 8.5.1.1.10</a>
0Ah	DCDC3_OP	DCDC3 OP Register	<a href="#">セクション 8.5.1.1.11</a>
0Bh	DCDC3_AVS	DCDC3 AVS Register	<a href="#">セクション 8.5.1.1.12</a>
0Ch	DCDC3_LIMIT	DCDC3 Limit Register	<a href="#">セクション 8.5.1.1.13</a>
0Dh	DCDC4_OP	DCDC4 OP Register	<a href="#">セクション 8.5.1.1.14</a>
0Eh	DCDC4_AVS	DCDC4 AVS Register	<a href="#">セクション 8.5.1.1.15</a>
0Fh	DCDC4_LIMIT	DCDC4 Limit Register	<a href="#">セクション 8.5.1.1.16</a>

Complex bit access types are encoded to fit into small table cells. 表 8-9 shows the codes that are used for access types in this section.

**表 8-9. DCDC Access Type Codes**

Access Type	Code	Description
Read Type		
R	R	Read
Write Type		
W	W	Write
Reset or Default Value		
-n		Value after reset or the default value
-OTP		Bit reset value is defined in the OTP memory
-X		Bit determined by external connection

### 8.5.1.1.1 DCDC1\_CTRL Register (Offset = 00h) [reset = OTP]

DCDC1\_CTRL is shown in [表 8-10](#) and described in [表 8-11](#).

Return to [Summary Table](#).

Register is reset on a POR event.

**表 8-10. DCDC1\_CTRL Register**

7	6	5	4	3	2	1	0
VCON_ENABLE	VCON_RANGE[1:0]		TSTEP[2]			DCDC1_MODE	RSVD
R/W-OTP	R/W-OTP		R/W-000b			R/W-OTP	R-0b

**表 8-11. DCDC1\_CTRL Register Field Descriptions**

Bit	Field	Type	Reset	Description
7	VCON_ENABLE	R/W	OTP	0b = Voltage scaling is done by the I <sup>2</sup> C registers or DCDC1_SEL pin 1b = Voltage scaling is done by the VCON pins, VCON_PWM and VCON_CLK; the voltage table is automatically forced to RANGE[1:0] = 00b; register contents in voltage scaling registers are ignored
6-5	VCON_RANGE[1:0]	R/W	OTP	00b = Sets output voltage range for VCON operation: 500 mV to 1100 mV with 25 mV steps; 24 steps 01b = Sets output voltage range for VCON operation: 700 mV to 1100 mV with 12.5 mV steps; 32 steps 10b = Sets output voltage range for VCON operation: 600 mV to 1000 mV with 12.5 mV steps; 32 steps 11b = Sets output voltage range for VCON operation: 500 mV to 900 mV with 12.5 mV steps; 32 steps
4-2	TSTEP[2:0]	R/W	000b	Time step: when changing the output voltage, the new value is reached through successive voltage steps (if not bypassed). <a href="#">表 8-18</a> shows the equivalent programmable slew rate of the output voltage.
1	DCDC1_MODE	R/W	OTP	0b = Auto mode or Eco mode 1b = Force PWM mode
0	RSVD	R	0b	Unused bit, should be written to 0b.

### 8.5.1.1.2 DCDC2\_CTRL (Offset = 01h) [reset = OTP]

DCDC2\_CTRL is shown in [表 8-12](#) and described in [表 8-13](#).

Return to [Summary Table](#).

Register is reset on a POR event.

**表 8-12. DCDC2\_CTRL Register**

7	6	5	4	3	2	1	0
RSVD			TSTEP[2:0]			DCDC2_MODE	RSVD
R-000b			R/W-000b			R/W-1b	R-0b

**表 8-13. DCDC2\_CTRL Register Field Descriptions**

Bit	Field	Type	Reset	Description
7-5	RSVD	R	000b	Unused bit, should be written to 0b.
4-2	TSTEP[2:0]	R/W	000b	Time step: when changing the output voltage, the new value is reached through successive voltage steps (if not bypassed). <a href="#">表 8-18</a> shows the equivalent programmable slew rate of the output voltage.
1	DCDC2_MODE	R/W	OTP	0b = Auto mode or Eco mode 1b = Force PWM
0	RSVD	R	0b	Unused bit, should be written to 0b.

### 8.5.1.1.3 DCDC3\_CTRL Register (Offset = 02h) [reset = OTP]

DCDC3\_CTRL is shown in [表 8-14](#) and described in [表 8-15](#).

Return to [Summary Table](#).

Register is reset on a POR event.

**表 8-14. DCDC3\_CTRL Register**

7	6	5	4	3	2	1	0
RSVD			TSTEP[2:0]			DCDC3_MODE	RSVD
R/W-000b			R/W-000b			R/W-OTP	R-0b

**表 8-15. DCDC3\_CTRL Register Field Descriptions**

Bit	Field	Type	Reset	Description
7-5	RSVD	R/W	000b	Unused bit, should be written to 0b.
4-2	TSTEP[2:0]	R/W	000b	Time step: when changing the output voltage, the new value is reached through successive voltage steps (if not bypassed). <a href="#">表 8-18</a> shows the equivalent programmable slew rate of the output voltage.
1	DCDC3_MODE	R/W	OTP	0b = Auto mode or Eco mode 1b = Force PWM
0	RSVD	R	0b	Unused bit, should be written to 0b.

### 8.5.1.1.4 DCDC4\_CTRL Register (Offset = 03h) [reset = OTP]

DCDC4\_CTRL is shown in [表 8-16](#) and described in [表 8-17](#).

Return to [Summary Table](#).

Register is reset on a POR event.

**表 8-16. DCDC4\_CTRL Register**

7	6	5	4	3	2	1	0
RSVD			TSTEP[2:0]			DCDC4_MODE	RAMP_TIME
R-000b			R/W-000b			R/W-OTP	R/W-OTP

**表 8-17. DCDC4\_CTRL Register Field Descriptions**

Bit	Field	Type	Reset	Description
7-5	RSVD	R	000b	Unused bit, should be written to 0b.
4-2	TSTEP[2:0]	R/W	000b	Time step: when changing the output voltage, the new value is reached through successive voltage steps (if not bypassed). <a href="#">表 8-18</a> shows the equivalent programmable slew rate of the output voltage.
1	DCDC4_MODE	R/W	OTP	0b = Auto mode or Eco mode 1b = Force PWM
0	RAMP_TIME	R/W	OTP	For additional options for DCDC4, see the SPARE register (address 63h). 0b = Ramp time for initial start up is 200- $\mu$ s minimum 1b = Ramp time for initial start up is 60- $\mu$ s maximum

表 8-18. DCDCx TSTEP Settings

TSTEP[2:0]	Slew Rate (mV/ $\mu$ s)
000b	30
001b	12.5
010b	9.4
011b	7.5
100b	6.25
101b	4.7
110b	3.12
111b	2.5



#### 8.5.1.1.5 DCDC1\_OP Register (Offset = 04h) [reset = OTP]

DCDC1\_OP is shown in [表 8-19](#) and described in [表 8-20](#).

Return to [Summary Table](#).

Register is reset on a POR event.

**表 8-19. DCDC1\_OP Register**

7	6	5	4	3	2	1	0	
RSVD	SELREG	SEL[5:0]						
R-0b	R/W-0b	R/W-OTP						

**表 8-20. DCDC1\_OP Register Field Descriptions**

Bit	Field	Type	Reset	Description
7	RSVD	R	0b	Unused bit, should be written to 0b.
6	SELREG	R/W	0b	See <a href="#">表 8-6</a>
5-0	SEL[5:0]	R/W	OTP	DCDC1 output voltage selection based on the RANGE[1:0] bit in the DCDC1 register selections shown in <a href="#">表 8-44</a> through <a href="#">表 8-47</a> .

#### 8.5.1.1.6 DCDC1\_AVS Register (Offset = 05h) [reset = OTP]

DCDC1\_AVS is shown in [表 8-21](#) and described in [表 8-22](#).

Return to [Summary Table](#).

Register is reset on a POR event.

**表 8-21. DCDC1\_AVS Register**

7	6	5	4	3	2	1	0	
ENABLE	ECO	SEL[5:0]						
R/W-OTP	R/W-0b	R/W-OTP						

**表 8-22. DCDC1\_AVS Register Field Descriptions**

Bit	Field	Type	Reset	Description
7	ENABLE	R/W	OTP	0b = DCDC1 disabled 1b = DCDC1 enabled unless it is being disabled by SET_OFF mode
6	ECO	R/W	0b	See <a href="#">セクション 8.4.4.2</a>
5-0	SEL[5:0]	R/W	OTP	DCDC1 output voltage selection based on the RANGE[1:0] bit in the DCDC1 register selections shown in <a href="#">表 8-44</a> through <a href="#">表 8-47</a> .

### 8.5.1.1.7 DCDC1\_LIMIT Register (Offset = 06h) [reset = OTP]

DCDC1\_LIMIT is shown in [表 8-23](#) and described in [表 8-24](#).

Return to [Summary Table](#).

Register is reset on a POR event.

**表 8-23. DCDC1\_LIMIT Register**

7	6	5	4	3	2	1	0
RANGE[1:0]		MAX_SEL[5:0]					
R/W-OTP		R/W-OTP					

**表 8-24. DCDC1\_LIMIT Register Field Descriptions**

Bit	Field	Type	Reset	Description
7	RANGE[1:0]	R/W	OTP	Selects the output range. For more information, see <a href="#">表 8-43</a> .
5-0	MAX_SEL[5:0]	R/W	OTP	This bit defines the maximum value the output voltage in the DCDC1_AVS or DCDC1_OP register can be programmed to; values exceeding MAX_SEL will be replaced by the value defined in MAX_SEL. If the MAX_SEL bit is set by I <sup>2</sup> C or default OTP setting to any value other than 0x3F or 0x00, the RANGE bits and the MAX_SEL bits are locked until OTP is reloaded.

### 8.5.1.1.8 DCDC2\_OP Register (Offset = 07h) [reset = OTP]

DCDC2\_OP is shown in [表 8-25](#) and described in [表 8-26](#).

Return to [Summary Table](#).

Register is reset on a POR event.

**表 8-25. DCDC2\_OP Register**

7	6	5	4	3	2	1	0
RSVD	SELREG	SEL[5:0]					
R-0b	R/W-0b	R/W-OTP					

**表 8-26. DCDC2\_OP Register Field Descriptions**

Bit	Field	Type	Reset	Description
7	RSVD	R	0b	Unused bit, should be written to 0b.
6	SELREG	R/W	0b	See <a href="#">表 8-6</a>
5-0	SEL[5:0]	R/W	OTP	DCDC2 output voltage selection based on the RANGE[1:0] bit in the DCDC2 register selections shown in <a href="#">表 8-44</a> through <a href="#">表 8-47</a> .

### 8.5.1.1.9 DCDC2\_AVS Register (Offset = 08h) [reset = OTP]

DCDC2\_AVS is shown in [表 8-27](#) and described in [表 8-28](#).

Return to [Summary Table](#).

Register is reset on a POR event.

**表 8-27. DCDC2\_AVS Register**

7	6	5	4	3	2	1	0	
ENABLE	ECO	SEL[5:0]						
R/W-OTP	R/W-0b	R/W-OTP						

**表 8-28. DCDC2\_AVS Register Field Descriptions**

Bit	Field	Type	Reset	Description
7	ENABLE	R/W	OTP	0b = DCDC2 disabled 1b = DCDC2 enabled unless it is being disabled by SET_OFF mode
6	ECO	R/W	0b	See <a href="#">セクション 8.4.4.2</a>
5-0	SEL[5:0]	R/W	OTP	DCDC2 output voltage selection based on the RANGE[1:0] bit in the DCDC2 register selections shown in <a href="#">表 8-44</a> through <a href="#">表 8-47</a> .

### 8.5.1.1.10 DCDC2\_LIMIT Register (Offset = 09h) [reset = OTP]

DCDC2\_LIMIT is shown in [表 8-29](#) and described in [表 8-30](#).

Return to [Summary Table](#).

Register is reset on a POR event.

**表 8-29. DCDC2\_LIMIT Register**

7	6	5	4	3	2	1	0	
RANGE[1:0]		MAX_SEL[5:0]						
R/W-OTP		R/W-OTP						

**表 8-30. DCDC2\_LIMIT Register Field Descriptions**

Bit	Field	Type	Reset	Description
7-6	RANGE[1:0]	R/W	OTP	Selects the output range. For more information, see <a href="#">表 8-43</a> .
5-0	MAX_SEL[5:0]	R/W	OTP	This bit defines the maximum value the output voltage in the DCDC2_AVS or DCDC2_OP register can be programmed to; values exceeding MAX_SEL will be replaced by the value defined in MAX_SEL. If the MAX_SEL bit is set by I <sup>2</sup> C or default OTP setting to any value other than 0x3F or 0x00, the RANGE bits and the MAX_SEL bits are locked until OTP is reloaded.

**8.5.1.1.11 DCDC3\_OP Register (Offset = 0Ah) [reset = OTP]**

DCDC3\_OP is shown in [表 8-31](#) and described in [表 8-32](#).

Return to [Summary Table](#).

Register is reset on a POR event.

**表 8-31. DCDC3\_OP Register**

7	6	5	4	3	2	1	0	
RSVD	SELREG	SEL[5:0]						
R-0b	R/W-0b	R/W-OTP						

**表 8-32. DCDC3\_OP Register Field Descriptions**

Bit	Field	Type	Reset	Description
7	RSVD	R	0b	Unused bit, should be written to 0b.
6	SELREG	R/W	0b	See <a href="#">表 8-6</a>
5-0	SEL[5:0]	R/W	OTP	DCDC3 output voltage selection based on the RANGE[1:0] bit in the DCDC3 register selections shown in <a href="#">表 8-44</a> through <a href="#">表 8-47</a> .

**8.5.1.1.12 DCDC3\_AVS Register (Offset = 0Bh) [reset = OTP]**

DCDC3\_AVS is shown in [表 8-33](#) and described in [表 8-34](#).

Return to [Summary Table](#).

Register is reset on a POR event.

**表 8-33. DCDC3\_AVS Register**

7	6	5	4	3	2	1	0	
ENABLE	ECO	SEL[5:0]						
R/W-OTP	R/W-0b	R/W-OTP						

**表 8-34. DCDC3\_AVS Register Field Descriptions**

Bit	Field	Type	Reset	Description
7	ENABLE	R/W	OTP	0b = DCDC3 disabled 1b = DCDC3 enabled unless it is being disabled by SET_OFF mode
6	ECO	R/W	0b	See <a href="#">セクション 8.4.4.2</a>
5-0	SEL[5:0]	R/W	OTP	DCDC3 output voltage selection based on the RANGE[1:0] bit in the DCDC3 register selections shown in <a href="#">表 8-44</a> through <a href="#">表 8-47</a> .

#### 8.5.1.1.13 DCDC3\_LIMIT Register (Offset = 0Ch) [reset = OTP]

DCDC3\_LIMIT is shown in [表 8-35](#) and described in [表 8-36](#).

Return to [Summary Table](#).

Register is reset on a POR event.

**表 8-35. DCDC3\_LIMIT Register**

7	6	5	4	3	2	1	0
RANGE[1:0]		MAX_SEL[5:0]					
R/W-OTP		R/W-OTP					

**表 8-36. DCDC3\_LIMIT Register Field Descriptions**

Bit	Field	Type	Reset	Description
7-6	RANGE[1:0]	R/W	OTP	Selects the output range. For more information, see <a href="#">表 8-43</a> .
5-0	MAX_SEL[5:0]	R/W	OTP	This bit defines the maximum value the output voltage in the DCDC3_AVS or DCDC3_OP register can be programmed to; values exceeding MAX_SEL will be replaced by the value defined in MAX_SEL. If the MAX_SEL bit is set by I <sup>2</sup> C or default OTP setting to any value other than 0x3F or 0x00, the RANGE bits and the MAX_SEL bits are locked until OTP is reloaded.

#### 8.5.1.1.14 DCDC4\_OP Register (Offset = 0Dh) [reset = OTP]

DCDC4\_OP is shown in [表 8-37](#) and described in [表 8-38](#).

Return to [Summary Table](#).

Register is reset on a POR event.

**表 8-37. DCDC4\_OP Register**

7	6	5	4	3	2	1	0
RSVD	SELREG	SEL[5:0]					
R-0b	R/W-0b	R/W-OTP					

**表 8-38. DCDC4\_OP Register Field Descriptions**

Bit	Field	Type	Reset	Description
7	RSVD	R	0b	Unused bit, should be written to 0b.
6	SELREG	R/W	0b	See <a href="#">表 8-6</a>
5-0	SEL[5:0]	R/W	OTP	This bit is for the DCDC4 output voltage selection based on the RANGE[1:0] bit in the DCDC4 register selections shown in <a href="#">表 8-44</a> through <a href="#">表 8-47</a> .

### 8.5.1.1.15 DCDC4\_AVS Register (Offset = 0Eh) [reset = OTP]

DCDC4\_AVS is shown in [表 8-39](#) and described in [表 8-40](#).

Return to [Summary Table](#).

Register is reset on a POR event.

**表 8-39. DCDC4\_AVS Register**

7	6	5	4	3	2	1	0	
ENABLE	ECO	SEL[5:0]						
R/W-OTP	R/W-0b	R/W-OTP						

**表 8-40. DCDC4\_AVS Register Field Descriptions**

Bit	Field	Type	Reset	Description
7	ENABLE	R/W	OTP	0b = DCDC4 disabled 1b = DCDC4 enabled unless it is being disabled by SET_OFF mode
6	ECO	R/W	0b	See <a href="#">セクション 8.4.4.2</a>
5-0	SEL[5:0]	R/W	OTP	This bit is for the DCDC4 output voltage selection based on the RANGE[1:0] bit in the DCDC4 register selections shown in <a href="#">表 8-44</a> through <a href="#">表 8-47</a> .

### 8.5.1.1.16 DCDC4\_LIMIT Register (Offset = 0Fh) [reset = OTP]

DCDC4\_LIMIT is shown in [表 8-41](#) and described in [表 8-42](#).

Return to [Summary Table](#).

Register is reset on a POR event.

**表 8-41. DCDC4\_LIMIT Register**

7	6	5	4	3	2	1	0	
RANGE[1:0]		MAX_SEL[5:0]						
R/W-OTP		R/W-OTP						

**表 8-42. DCDC4\_LIMIT Register Field Descriptions**

Bit	Field	Type	Reset	Description
7-6	RANGE[1:0]	R/W	OTP	Selects the output range. For more information, see <a href="#">表 8-43</a> .
5-0	MAX_SEL[5:0]	R/W	OTP	This bit defines the maximum value the output voltage in the DCDC4_AVS or DCDC4_OP register can be programmed to; values exceeding MAX_SEL will be replaced by the value defined in MAX_SEL. If the MAX_SEL bit is set by I <sup>2</sup> C or default OTP setting to any value other than 0x3F or 0x00, the RANGE bits and the MAX_SEL bits are locked until OTP is reloaded.

### 8.5.1.1.17 V<sub>DCDCx</sub> Range Settings

**表 8-43. V<sub>DCDCx</sub> Range Settings**

RANGE[1:0]	Output Voltage Range
00b	0.5 V to 1.2875 V in 12.5 mV steps (See 表 8-44)
01b	0.7 V to 1.4875 V in 12.5 mV steps (See 表 8-45)
10b	0.5 V to 2.075 V in 25 mV steps (See 表 8-46)
11b	0.5 V to 3.8 V in 50 mV steps (See 表 8-47)

## 8.5.1.1.18 DCDCx Voltage Settings

表 8-44. DCDCx Voltage Settings (RANGE[1:0] = 00b)

SEL(DCDCx)[5:0]	VDCDCx (V)	SEL(DCDCx)[5:0]	VDCDCx (V)
00000b	0.5000	10000b	0.9000
000001b	0.5125	100001b	0.9125
000010b	0.5250	100010b	0.9250
000011b	0.5375	100011b	0.9375
000100b	0.5500	100100b	0.9500
000101b	0.5625	100101b	0.9625
000110bb	0.5750	100110b	0.9750
000111b	0.5875	100111b	0.9875
001000b	0.6000	101000b	1.0000
001001b	0.6125	101001b	1.0125
001010b	0.6250	101010b	1.025
001011b	0.6375	101011b	1.0375
001100b	0.6500	101100b	1.0500
001101b	0.6625	101101b	1.0625
001110b	0.6750	101110b	1.0750
001111b	0.6875	101111b	1.0875
010000b	0.7000	110000b	1.1000
010001b	0.7125	110001b	1.1125
010010b	0.725	110010b	1.1250
010011b	0.7375	110011b	1.1375
010100b	0.7500	110100b	1.1500
010101b	0.7625	110101b	1.1625
010110b	0.7750	110110b	1.1750
010111b	0.7875	110111b	1.1875
011000b	0.8000	111000b	1.2000
011001b	0.8125	111001b	1.2125
011010b	0.8250	111010b	1.2250
011011b	0.8375	111011b	1.2375
011100b	0.8500	111100b	1.2500
011101b	0.8625	111101b	1.2625
011110b	0.8750	111110b	1.2750
011111b	0.8875	111111b	1.2875



**表 8-45. DCDCx Voltage Settings (RANGE[1:0] = 01b)**

SEL(DCDCx)[5:0]	VDCDCx (V)	SEL(DCDCx)[5:0]	VDCDCx (V)
00000b	0.7000	10000b	1.1000
00001b	0.7125	10001b	1.1125
00010b	0.7250	10010b	1.1250
00011b	0.7375	10011b	1.1375
00100b	0.7500	100100b	1.1500
00101b	0.7625	100101b	1.1625
00110b	0.7750	100110b	1.1750
00111b	0.7875	100111b	1.1875
001000b	0.8000	101000b	1.2000
001001b	0.8125	101001b	1.2125
001010b	0.8250	101010b	1.225
001011b	0.8375	101011b	1.2375
001100b	0.8500	101100b	1.2500
001101b	0.8625	101101b	1.2625
001110b	0.8750	101110b	1.2750
001111b	0.8875	101111b	1.2875
01000b	0.9000	11000b	1.3000
010001b	0.9125	110001b	1.3125
010010b	0.925	110010b	1.3250
010011b	0.9375	110011b	1.3375
010100b	0.9500	110100b	1.3500
010101b	0.9625	110101b	1.3625
010110b	0.9750	110110b	1.3750
010111b	0.9875	110111b	1.3875
01100b	1.0000	11100b	1.4000
011001b	1.0125	111001b	1.4125
011010b	1.0250	111010b	1.4250
011011b	1.0375	111011b	1.4375
011100b	1.0500	111100b	1.4500
011101b	1.0625	111101b	1.4625
011110b	1.0750	111110b	1.4750
011111b	1.0875	111111b	1.4875

**表 8-46. DCDCx Voltage Settings (RANGE[1:0] = 10b)**

SEL(DCDCx)[5:0]	VDCDCx (V)	SEL(DCDCx)[5:0]	VDCDCx (V)
00000b	0.500	10000b	1.300
00001b	0.525	10001b	1.325
00010b	0.550	10010b	1.350
00011b	0.575	10011b	1.375
00100b	0.600	100100b	1.400
00101b	0.625	100101b	1.425
00110b	0.650	100110b	1.450
00111b	0.675	100111b	1.475
001000b	0.700	101000b	1.500
001001b	0.725	101001b	1.525
001010b	0.750	101010b	1.550
001011b	0.775	101011b	1.575
001100b	0.800	101100b	1.600
001101b	0.825	101101b	1.625
001110b	0.850	101110b	1.650
001111b	0.875	101111b	1.675
010000b	0.900	110000b	1.700
010001b	0.925	110001b	1.725
010010b	0.950	110010b	1.750
010011b	0.975	110011b	1.775
010100b	1.000	110100b	1.800
010101b	1.025	110101b	1.825
010110b	1.050	110110b	1.850
010111b	1.075	110111b	1.875
011000b	1.100	111000b	1.900
011001b	1.125	111001b	1.925
011010b	1.150	111010b	1.950
011011b	1.175	111011b	1.975
011100b	1.200	111100b	2.000
011101b	1.225	111101b	2.025
011110b	1.250	111110b	2.050
011111b	1.275	111111b	2.075

**表 8-47. DCDCx Voltage Settings (RANGE[1:0] = 11b)**

SEL(DCDCx)[5:0]	VDCDCx (V)	SEL(DCDCx)[5:0]	VDCDCx (V)
00000b	0.50	10000b	2.10
00001b	0.55	10001b	2.15
00010b	0.60	10010b	2.20
00011b	0.65	10011b	2.25
00100b	0.70	100100b	2.30
00101b	0.75	100101b	2.35
00110b	0.80	100110b	2.40
00111b	0.85	100111b	2.45
001000b	0.90	101000b	2.50
001001b	0.95	101001b	2.55
001010b	1.00	101010b	2.60
001011b	1.05	101011b	2.65
001100b	1.10	101100b	2.70
001101b	1.15	101101b	2.75
001110b	1.20	101110b	2.80
001111b	1.25	101111b	2.85
010000b	1.30	110000b	2.90
010001b	1.35	110001b	2.95
010010b	1.40	110010b	3.00
010011b	1.45	110011b	3.05
010100b	1.50	110100b	3.10
010101b	1.55	110101b	3.15
010110b	1.60	110110b	3.20
010111b	1.65	110111b	3.25
011000b	1.70	111000b	3.30
011001b	1.75	111001b	3.35
011010b	1.80	111010b	3.40
011011b	1.85	111011b	3.45
011100b	1.90	111100b	3.50
011101b	1.95	111101b	3.55
011110b	2.00	111110b	3.60
011111b	2.05	111111b	3.80

### 8.5.1.2 LDO Registers (10h to 21h)

表 8-48 lists the memory-mapped registers for the LDO registers. All register offset addresses not listed in 表 8-48 should be considered as reserved locations and the register contents should not be modified.

**表 8-48. LDO Register Memory Map**

Offset	Acronym	Register Name	Section
10h	LDO1_OP	LDO1 OP Register	<a href="#">セクション 8.5.1.2.1</a>
11h	LDO1_AVS	LDO1 AVS Register	<a href="#">セクション 8.5.1.2.2</a>
12h	LDO1_LIMIT	LDO1 Limit Register	<a href="#">セクション 8.5.1.2.3</a>
13h	LDO2_OP	LDO2 OP Register	<a href="#">セクション 8.5.1.2.4</a>
14h	LDO2_AVS	LDO2 AVS Register	<a href="#">セクション 8.5.1.2.5</a>
15h	LDO2_LIMIT	LDO2 Limit Register	<a href="#">セクション 8.5.1.2.6</a>
16h	LDO3_OP	LDO3 OP Register	<a href="#">セクション 8.5.1.2.7</a>
17h	LDO3_AVS	LDO3 AVS Register	<a href="#">セクション 8.5.1.2.8</a>
18h	LDO3_LIMIT	LDO3 Limit Register	<a href="#">セクション 8.5.1.2.9</a>
19h	LDO4_OP	LDO4 OP Register	<a href="#">セクション 8.5.1.2.10</a>
1Ah	LDO4_AVS	LDO4 AVS Register	<a href="#">セクション 8.5.1.2.11</a>
1Bh	LDO4_LIMIT	LDO4 Limit Register	<a href="#">セクション 8.5.1.2.12</a>
1Ch	LDO5	LDO5 Register	<a href="#">セクション 8.5.1.2.13</a>
1Dh	LDO6	LDO6 Register	<a href="#">セクション 8.5.1.2.14</a>
1Eh	LDO7	LDO7 Register	<a href="#">セクション 8.5.1.2.15</a>
1Fh	LDO8	LDO8 Register	<a href="#">セクション 8.5.1.2.16</a>
20h	LDO9	LDO9 Register	<a href="#">セクション 8.5.1.2.17</a>
21h	LDO10	LDO10 Register	<a href="#">セクション 8.5.1.2.18</a>

Complex bit access types are encoded to fit into small table cells. 表 8-49 shows the codes that are used for access types in this section.

**表 8-49. LDO Access Type Codes**

Access Type	Code	Description
Read Type		
R	R	Read
Write Type		
W	W	Write
Reset or Default Value		
-n		Value after reset or the default value
-OTP		Bit reset value is defined in the OTP memory
-X		Bit determined by external connection

### 8.5.1.2.1 LDO1\_OP Register (Offset = 10h) [reset = OTP]

LDO1\_OP is shown in [表 8-50](#) and described in [表 8-51](#).

Return to [Summary Table](#).

Register is reset on a POR event.

**表 8-50. LDO1\_OP Register**

7	6	5	4	3	2	1	0	
RSVD	SELREG	SEL[5:0]						
R-0b	R/W-0b	R/W-OTP						

**表 8-51. LDO1\_OP Register Field Descriptions**

Bit	Field	Type	Reset	Description
7	RSVD	R	0b	Unused bit, should be written to 0b
6	SELREG	R/W	0b	See <a href="#">表 8-6</a>
5-0	SEL[5:0]	R/W	OTP	<a href="#">表 8-85</a> shows the supply-voltage settings.

### 8.5.1.2.2 LDO1\_AVS Register (Offset = 11h) [reset = OTP]

LDO1\_AVS is shown in [表 8-52](#) and described in [表 8-53](#).

Return to [Summary Table](#).

Register is reset on a POR event.

**表 8-52. LDO1\_AVS Register**

7	6	5	4	3	2	1	0	
ENABLE	ECO	SEL[5:0]						
R/W-OTP	R/W-0b	R/W-OTP						

**表 8-53. LDO1\_AVS Register Field Descriptions**

Bit	Field	Type	Reset	Description
7	ENABLE	R/W	OTP	0b = LDO1 disabled 1b = LDO1 enabled unless it is being disabled by SET_OFF mode
6	ECO	R/W	0b	See <a href="#">セクション 8.3.1.1</a>
5-0	SEL[5:0]	R/W	OTP	<a href="#">表 8-85</a> shows the supply-voltage setting.

### 8.5.1.2.3 LDO1\_LIMIT Register (Offset = 12h) [reset = OTP]

LDO1\_LIMIT is shown in [图 8-25](#) and described in [表 8-54](#).

Return to [Summary Table](#).

Register is reset on a POR event.

**图 8-25. LDO1\_LIMIT Register**

7	6	5	4	3	2	1	0
RSVD		MAX_SEL[5:0]					
R-00b		R/W-OTP					

**表 8-54. LDO1\_LIMIT Register Field Descriptions**

Bit	Field	Type	Reset	Description
7-6	RSVD	R	00b	Unused bit, should be written to 0b
5-0	MAX_SEL[5:0]	R/W	OTP	This bit defines the maximum value the output voltage in the LDO1_AVS or LDO1_OP register can be programmed to; values exceeding MAX_SEL will be replaced by the value defined in MAX_SEL. If the MAX_SEL bit is set by I <sup>2</sup> C or default OTP setting to any value other than 0x3F or 0x00, the RANGE bits and the MAX_SEL bits are locked until OTP is reloaded.

### 8.5.1.2.4 LDO2\_OP Register (Offset = 13h) [reset = OTP]

LDO2\_OP is shown in [表 8-55](#) and described in [表 8-56](#).

Return to [Summary Table](#).

Register is reset on a POR event.

**表 8-55. LDO2\_OP Register**

7	6	5	4	3	2	1	0
RSVD	SELREG	SEL[5:0]					
R-0b	R/W-0b	R/W-OTP					

**表 8-56. LDO2\_OP Register Field Descriptions**

Bit	Field	Type	Reset	Description
7	RSVD	R	0b	Unused bit, should be written to 0b
6	SELREG	R/W	0b	See <a href="#">表 8-6</a>
5-0	SEL[5:0]	R/W	OTP	<a href="#">表 8-85</a> shows the supply-voltage setting.

#### 8.5.1.2.5 LDO2\_AVS Register (Offset = 14h) [reset = OTP]

LDO2\_AVS is shown in [表 8-57](#) and described in [表 8-58](#).

Return to [Summary Table](#).

Register is reset on a POR event.

**表 8-57. LDO2\_AVS Register**

7	6	5	4	3	2	1	0	
ENABLE	ECO	SEL[5:0]						
R/W-OTP	R/W-0b	R/W-OTP						

**表 8-58. LDO2\_AVS Register Field Descriptions**

Bit	Field	Type	Reset	Description
7	ENABLE	R/W	OTP	0b = LDO2 disabled 1b = LDO2 enabled unless it is being disabled by SET_OFF mode
6	ECO	R/W	0b	See <a href="#">セクション 8.3.1.1</a>
5-0	SEL[5:0]	R/W	OTP	<a href="#">表 8-85</a> shows the supply-voltage setting.

#### 8.5.1.2.6 LDO2\_LIMIT Register (Offset = 15h) [reset = OTP]

LDO2\_LIMIT is shown in [表 8-59](#) and described in [表 8-60](#).

Return to [Summary Table](#).

Register is reset on a POR event.

**表 8-59. LDO2\_LIMIT Register**

7	6	5	4	3	2	1	0
RSVD	MAX_SEL[5:0]						
R-00b	R/W-OTP						

**表 8-60. LDO2\_LIMIT Register Field Descriptions**

Bit	Field	Type	Reset	Description
7-6	RSVD	R	00b	Unused bit, should be written to 0b
5-0	MAX_SEL[5:0]	R/W	OTP	This bit defines the maximum value the output voltage in the LDO2_AVS or LDO2_OP register can be programmed to; values exceeding MAX_SEL will be replaced by the value defined in MAX_SEL. If the MAX_SEL bit is set by I <sup>2</sup> C or default OTP setting to any value other than 0x3F or 0x00, the RANGE bits and the MAX_SEL bits are locked until OTP is reloaded.

**8.5.1.2.7 LDO3\_OP Register (Offset = 16h) [reset = OTP]**

LDO3\_OP is shown in [表 8-61](#) and described in [表 8-62](#).

Return to [Summary Table](#).

Register is reset on a POR event.

**表 8-61. LDO3\_OP Register**

7	6	5	4	3	2	1	0	
RSVD	SELREG	SEL[5:0]						
R-0b	R/W-0b	R/W-OTP						

**表 8-62. LDO3\_OP Register Field Descriptions**

Bit	Field	Type	Reset	Description
7	RSVD	R	0b	Unused bit, should be written to 0b
6	SELREG	R/W	0b	See <a href="#">表 8-6</a>
5-0	SEL[5:0]	R/W	OTP	<a href="#">表 8-85</a> shows the supply-voltage setting.

**8.5.1.2.8 LDO3\_AVS Register (Offset = 17h) [reset = OTP]**

LDO3\_AVS is shown in [表 8-63](#) and described in [表 8-64](#).

Return to [Summary Table](#).

Register is reset on a POR event.

**表 8-63. LDO3\_AVS Register**

7	6	5	4	3	2	1	0	
ENABLE	ECO	SEL[5:0]						
R/W-OTP	R/W-0b	R/W-OTP						

**表 8-64. LDO3\_AVS Register Field Descriptions**

Bit	Field	Type	Reset	Description
7	ENABLE	R/W	OTP	0b = LDO3 disabled 1b = LDO3 enabled unless it is being disabled by SET_OFF mode
6	ECO	R/W	0b	See <a href="#">セクション 8.3.1.1</a>
5-0	SEL[5:0]	R/W	OTP	<a href="#">表 8-85</a> shows the supply-voltage setting.



### 8.5.1.2.9 LDO3\_LIMIT Register (Offset = 18h) [reset = OTP]

LDO3\_LIMIT is shown in [表 8-65](#) and described in [表 8-66](#).

Return to [Summary Table](#).

Register is reset on a POR event.

**表 8-65. LDO3\_LIMIT Register**

7	6	5	4	3	2	1	0
RSVD		MAX_SEL[5:0]					
R-00b		R/W-OTP					

**表 8-66. LDO3\_LIMIT Register Field Descriptions**

Bit	Field	Type	Reset	Description
7-6	RSVD	R	00b	Unused bit, should be written to 0b
5-0	MAX_SEL[5:0]	R/W	OTP	This bit defines the maximum value the output voltage in the LDO3_AVS or LDO3_OP register can be programmed to; values exceeding MAX_SEL will be replaced by the value defined in MAX_SEL. If the MAX_SEL bit is set by I <sup>2</sup> C or default OTP setting to any value other than 0x3F or 0x00, the RANGE bits and the MAX_SEL bits are locked until OTP is reloaded.

### 8.5.1.2.10 LDO4\_OP Register (Offset = 19h) [reset = OTP]

LDO4\_OP is shown in [表 8-67](#) and described in [表 8-68](#).

Return to [Summary Table](#).

Register is reset on a POR event.

**表 8-67. LDO4\_OP Register**

7	6	5	4	3	2	1	0
RSVD	SELREG	SEL[5:0]					
R-0b	R/W-0b	R/W-OTP					

**表 8-68. LDO4\_OP Register Field Descriptions**

Bit	Field	Type	Reset	Description
7	RSVD	R	0b	Unused bit, should be written to 0b
6	SELREG	R/W	0b	See <a href="#">表 8-6</a>
5-0	SEL[5:0]	R/W	OTP	<a href="#">表 8-86</a> shows the supply-voltage setting. The SEL[5] bit is internally set to 1b on LDO4 to reflect the programmable output voltage range from 1.6 V to 3.3 V.

**8.5.1.2.11 LDO4\_AVS Register (Offset = 1Ah) [reset = OTP]**

 LDO4\_AVS is shown in [表 8-69](#) and described in [表 8-70](#).

 Return to [Summary Table](#).

Register is reset on a POR event.

**表 8-69. LDO4\_AVS Register**

7	6	5	4	3	2	1	0	
ENABLE	ECO	SEL[5:0]						
R/W-OTP	R/W-0b	R/W-OTP						

**表 8-70. LDO4\_AVS Register Field Descriptions**

Bit	Field	Type	Reset	Description
7	ENABLE	R/W	OTP	0b = LDO4 disabled 1b = LDO4 enabled unless it is being disabled by SET_OFF mode
6	ECO	R/W	0b	See <a href="#">セクション 8.3.1.1</a>
5-0	SEL[5:0]	R/W	OTP	<a href="#">表 8-86</a> shows the supply-voltage setting. The SEL[5] bit is internally set to 1b on LDO4 to reflect the programmable output voltage range from 1.6 V to 3.3 V.

**8.5.1.2.12 LDO4\_LIMIT Register (Offset = 1Bh) [reset = OTP]**

 LDO4\_LIMIT is shown in [表 8-71](#) and described in [表 8-72](#).

 Return to [Summary Table](#).

Register is reset on a POR event.

**表 8-71. LDO4\_LIMIT Register**

7	6	5	4	3	2	1	0
RSVD	MAX_SEL[5:0]						
R-00b	R/W-OTP						

**表 8-72. LDO4\_LIMIT Register Field Descriptions**

Bit	Field	Type	Reset	Description
7-6	RSVD	R	00b	Unused bit, should be written to 0b
5-0	MAX_SEL[5:0]	R/W	OTP	This bit defines the maximum value the output voltage in the LDO4_AVS or LDO4_OP register can be programmed to; values exceeding MAX_SEL will be replaced by the value defined in MAX_SEL. If the MAX_SEL bit is set by I <sup>2</sup> C or default OTP setting to any value other than 0x3F or 0x00, the RANGE bits and the MAX_SEL bits are locked until OTP is reloaded.

### 8.5.1.2.13 LDO5 Register (Offset = 1Ch) [reset = OTP]

LDO5 is shown in [表 8-73](#) and described in [表 8-74](#).

Return to [Summary Table](#).

Register is reset on a POR event.

**表 8-73. LDO5 Register**

7	6	5	4	3	2	1	0
ENABLE	ECO	SEL[5:0]					
R/W-OTP	R/W-0b	R/W-OTP					

**表 8-74. LDO5 Register Field Descriptions**

Bit	Field	Type	Reset	Description
7	ENABLE	R/W	OTP	0b = LDO5 disabled 1b = LDO5 enabled unless it is being disabled by SET_OFF mode
6	ECO	R/W	0b	See <a href="#">セクション 8.3.1.1</a>
5-0	SEL[5:0]	R/W	OTP	<a href="#">表 8-86</a> shows the supply-voltage setting. The SEL[5] bit is internally set to 1b on LDO5 to reflect the programmable output voltage range from 1.6 V to 3.3 V.

### 8.5.1.2.14 LDO6 Register (Offset = 1Dh) [reset = OTP]

LDO6 is shown in [表 8-75](#) and described in [表 8-76](#).

Return to [Summary Table](#).

Register is reset on a POR event.

**表 8-75. LDO6 Register**

7	6	5	4	3	2	1	0
ENABLE	ECO	SEL[5:0]					
R/W-OTP	R/W-0b	R/W-OTP					

**表 8-76. LDO6 Register Field Descriptions**

Bit	Field	Type	Reset	Description
7	ENABLE	R/W	OTP	0b = LDO6 disabled 1b = LDO6 enabled unless it is being disabled by SET_OFF mode
6	ECO	R/W	0b	See <a href="#">セクション 8.3.1.1</a>
5-0	SEL[5:0]	R/W	OTP	<a href="#">表 8-85</a> shows the supply-voltage setting.

**8.5.1.2.15 LDO7 Register (Offset = 1Eh) [reset = OTP]**

 LDO7 is shown in [表 8-77](#) and described in [表 8-78](#).

 Return to [Summary Table](#).

Register is reset on a POR event.

**表 8-77. LDO7 Register**

7	6	5	4	3	2	1	0	
ENABLE	ECO	SEL[5:0]						
R/W-OTP	R/W-0b	R/W-OTP						

**表 8-78. LDO7 Register Field Descriptions**

Bit	Field	Type	Reset	Description
7	ENABLE	R/W	OTP	0b = LDO7 disabled 1b = LDO7 enabled unless it is being disabled by SET_OFF mode
6	ECO	R/W	0b	See <a href="#">セクション 8.3.1.1</a>
5-0	SEL[5:0]	R/W	OTP	<a href="#">表 8-85</a> shows the supply-voltage setting.

**8.5.1.2.16 LDO8 Register (Offset = 1Fh) [reset = OTP]**

 LDO8 is shown in [表 8-79](#) and described in [表 8-80](#).

 Return to [Summary Table](#).

Register is reset on a POR event.

**表 8-79. LDO8 Register**

7	6	5	4	3	2	1	0	
ENABLE	ECO	SEL[5:0]						
R/W-OTP	R/W-0b	R/W-OTP						

**表 8-80. LDO8 Register Field Descriptions**

Bit	Field	Type	Reset	Description
7	ENABLE	R/W	OTP	0b = LDO8 disabled 1b = LDO8 enabled unless it is being disabled by SET_OFF mode
6	ECO	R/W	0b	See <a href="#">セクション 8.3.1.1</a>
5-0	SEL[5:0]	R/W	OTP	<a href="#">表 8-85</a> shows the supply-voltage setting.

### 8.5.1.2.17 LDO9 Register (Offset = 20h) [reset = OTP]

LDO9 is shown in [表 8-81](#) and described in [表 8-82](#).

Return to [Summary Table](#).

Register is reset on a POR event.

**表 8-81. LDO9 Register**

7	6	5	4	3	2	1	0
ENABLE	ECO	SEL[5:0]					
R/W-OTP	R/W-0b	R/W-OTP					

**表 8-82. LDO9 Register Field Descriptions**

Bit	Field	Type	Reset	Description
7	ENABLE	R/W	OTP	0b = LDO9 disabled 1b = LDO9 enabled unless it is being disabled by SET_OFF mode
6	ECO	R/W	0b	See <a href="#">セクション 8.3.1.1</a>
5-0	SEL[5:0]	R/W	OTP	<a href="#">表 8-85</a> shows the supply-voltage setting.

### 8.5.1.2.18 LDO10 Register (Offset = 21h) [reset = OTP]

LDO10 is shown in [表 8-83](#) and described in [表 8-84](#).

Return to [Summary Table](#).

Register is reset on a POR event.

**表 8-83. LDO10 Register**

7	6	5	4	3	2	1	0
ENABLE	ECO	SEL[5:0]					
R/W-OTP	R/W-0b	R/W-OTP					

**表 8-84. LDO10 Register Field Descriptions**

Bit	Field	Type	Reset	Description
7	ENABLE	R/W	OTP	0b = LDO10 disabled 1b = LDO10 enabled unless it is being disabled by SET_OFF mode
6	ECO	R/W	0b	See <a href="#">セクション 8.3.1.1</a>
5-0	SEL[5:0]	R/W	OTP	<a href="#">表 8-85</a> shows the supply-voltage setting.

## 8.5.1.2.19 LDO Voltage Settings

表 8-85. LDO Voltage Settings; Except LDO4 and LDO5

SEL[5:0]	LDOx Output (V)	SEL[5:0]	LDOx Output (V)
00000b	0.800	10000b	1.600
00001b	0.825	10001b	1.650
00010b	0.850	10010b	1.700
00011b	0.875	10011b	1.750
00100b	0.900	100100b	1.800
00101b	0.925	100101b	1.850
00110b	0.950	100110b	1.900
00111b	0.975	100111b	1.950
001000b	1.000	101000b	2.000
001001b	1.025	101001b	2.050
001010b	1.050	101010b	2.100
001011b	1.075	101011b	2.150
001100b	1.100	101100b	2.200
001101b	1.125	101101b	2.250
001110b	1.150	101110b	2.300
001111b	1.175	101111b	2.350
010000b	1.200	110000b	2.400
010001b	1.225	110001b	2.450
010010b	1.250	110010b	2.500
010011b	1.275	110011b	2.550
010100b	1.300	110100b	2.600
010101b	1.325	110101b	2.650
010110b	1.350	110110b	2.700
010111b	1.375	110111b	2.750
011000b	1.400	111000b	2.800
011001b	1.425	111001b	2.850
011010b	1.450	111010b	2.900
011011b	1.475	111011b	2.950
011100b	1.500	111100b	3.000
011101b	1.525	111101b	3.100
011110b	1.550	111110b	3.200
011111b	1.575	111111b	3.300

**表 8-86. LDO Voltage Settings for LDO4 and LDO5**

SEL[5:0]	LDOx Output (V)
100000b	1.600
100001b	1.650
100010b	1.700
100011b	1.750
100100b	1.800
100101b	1.850
100110b	1.900
100111b	1.950
101000b	2.000
101001b	2.050
101010b	2.100
101011b	2.150
101100b	2.200
101101b	2.250
101110b	2.300
101111b	2.350
110000b	2.400
110001b	2.450
110010b	2.500
110011b	2.550
110100b	2.600
110101b	2.650
110110b	2.700
110111b	2.750
111000b	2.800
111001b	2.850
111010b	2.900
111011b	2.950
111100b	3.000
111101b	3.100
111110b	3.200
111111b	3.300

### 8.5.1.3 DEVCTRL Registers (22h to 64h)

表 8-87 lists the memory-mapped registers for the DEVCTRL registers. All register offset addresses not listed in 表 8-87 should be considered as reserved locations and the register contents should not be modified.

**表 8-87. DEVCTRL Register Memory Map**

Offset	Acronym	Register Name	Section
22h	THRM_REG	Thermal Register	<a href="#">セクション 8.5.1.3.1</a>
23h	CLK32KOUT	32-kHz Clock Output Register	<a href="#">セクション 8.5.1.3.2</a>
24h	DEVCTRL	Device Control Register	<a href="#">セクション 8.5.1.3.3</a>
25h	DEVCTRL2	Device Control 2 Register	<a href="#">セクション 8.5.1.3.4</a>
26h	I2C_SPI_CFG	I <sup>2</sup> C-SPI Configuration Register	<a href="#">セクション 8.5.1.3.5</a>
27h	KEEP_ON1	LDO Keep-On Register	<a href="#">セクション 8.5.1.3.6</a>
28h	KEEP_ON2	DCDC Keep-On Register	<a href="#">セクション 8.5.1.3.7</a>
29h	SET_OFF1	LDO Set Off Register	<a href="#">セクション 8.5.1.3.8</a>
2Ah	SET_OFF2	DCDC Set Off Register	<a href="#">セクション 8.5.1.3.9</a>
(2Bh)	DEF_VOLT	Default Voltage Register	<a href="#">セクション 8.5.1.3.10</a>
2Ch	DEF_VOLT_MAPPING	Default Voltage Mapping Register	<a href="#">セクション 8.5.1.3.12</a>
2Dh	DISCHARGE1	LDO Discharge Register	<a href="#">セクション 8.5.1.3.13</a>
2Eh	DISCHARGE2	DCDC Discharge Register	<a href="#">セクション 8.5.1.3.14</a>
2Fh	EN1_SET1	LDO EN1 Pin Setting Register	<a href="#">セクション 8.5.1.3.15</a>
30h	EN1_SET2	DCDC EN1 Pin Setting Register	<a href="#">セクション 8.5.1.3.16</a>
31h	EN2_SET1	LDO EN2 Pin Setting Register	<a href="#">セクション 8.5.1.3.17</a>
32h	EN2_SET2	DCDC EN2 Pin Setting Register	<a href="#">セクション 8.5.1.3.18</a>
33h	EN3_SET1	LDO EN3 Pin Setting Register	<a href="#">セクション 8.5.1.3.19</a>
34h	EN3_SET2	DCDC EN3 Pin Setting Register	<a href="#">セクション 8.5.1.3.20</a>
35h	EN4_SET1	LDO EN4 Pin Setting Register	<a href="#">セクション 8.5.1.3.21</a>
36h	EN4_SET2	DCDC EN4 Pin Setting Register	<a href="#">セクション 8.5.1.3.22</a>
37h	PGOOD	Power Good Register	<a href="#">セクション 8.5.1.3.23</a>
38h	PGOOD2	Power Good 2 Register	<a href="#">セクション 8.5.1.3.24</a>
39h	INT_STS	Interrupt Mask Register	<a href="#">セクション 8.5.1.3.25</a>
3Ah	INT_MSK	Interrupt Status Register	<a href="#">セクション 8.5.1.3.26</a>
3Bh	INT_STS2	Interrupt Status 2 Register	<a href="#">セクション 8.5.1.3.27</a>
3Ch	INT_MSK2	Interrupt Mask 2 Register	<a href="#">セクション 8.5.1.3.28</a>
3Dh	INT_STS3	Interrupt Status 3 Register	<a href="#">セクション 8.5.1.3.29</a>
3Eh	INT_MSK3	Interrupt Mask 3 Register	<a href="#">セクション 8.5.1.3.30</a>
3Fh	INT_STS4	Interrupt Status 4 Register	<a href="#">セクション 8.5.1.3.31</a>
40h	INT_MSK4	Interrupt Mask 4 Register	<a href="#">セクション 8.5.1.3.32</a>
41h	GPIO1	GPIO1 Register	<a href="#">セクション 8.5.1.3.33</a>
42h	GPIO2	GPIO2 Register	<a href="#">セクション 8.5.1.3.34</a>
43h	GPIO3	GPIO3 Register	<a href="#">セクション 8.5.1.3.35</a>
44h	GPIO4	GPIO4 Register	<a href="#">セクション 8.5.1.3.36</a>
45h	GPIO5	GPIO5 Register	<a href="#">セクション 8.5.1.3.37</a>
46h	VMON	Voltage Monitor Register	<a href="#">セクション 8.5.1.3.38</a>
47h	LEDA_CTRL1	LEDA Control 1 Register	<a href="#">セクション 8.5.1.3.39</a>
48h	LEDA_CTRL2	LEDA Control 2 Register	<a href="#">セクション 8.5.1.3.40</a>



**表 8-87. DEVCTRL Register Memory Map (continued)**

Offset	Acronym	Register Name	Section
49h	LEDA_CTRL3	LEDA Control 3 Register	<a href="#">セクション 8.5.1.3.41</a>
4Ah	LEDA_CTRL4	LEDA Control 4 Register	<a href="#">セクション 8.5.1.3.42</a>
4Bh	LEDA_CTRL5	LEDA Control 5 Register	<a href="#">セクション 8.5.1.3.43</a>
4Ch	LEDA_CTRL6	LEDA Control 6 Register	<a href="#">セクション 8.5.1.3.44</a>
4Dh	LEDA_CTRL7	LEDA Control 7 Register	<a href="#">セクション 8.5.1.3.45</a>
4Eh	LEDA_CTRL8	LEDA Control 8 Register	<a href="#">セクション 8.5.1.3.46</a>
4Fh	LEDB_CTRL1	LEDB Control 1 Register	<a href="#">セクション 8.5.1.3.47</a>
50h	LEDB_CTRL2	LEDB Control 2 Register	<a href="#">セクション 8.5.1.3.48</a>
51h	LEDB_CTRL3	LEDB Control 3 Register	<a href="#">セクション 8.5.1.3.49</a>
52h	LEDB_CTRL4	LEDB Control 4 Register	<a href="#">セクション 8.5.1.3.50</a>
53h	LEDB_CTRL5	LEDB Control 5 Register	<a href="#">セクション 8.5.1.3.51</a>
54h	LEDB_CTRL6	LEDB Control 6 Register	<a href="#">セクション 8.5.1.3.52</a>
55h	LEDB_CTRL7	LEDB Control 7 Register	<a href="#">セクション 8.5.1.3.53</a>
56h	LEDB_CTRL8	LEDB Control 8 Register	<a href="#">セクション 8.5.1.3.54</a>
57h	LEDC_CTRL1	LEDC Control 1 Register	<a href="#">セクション 8.5.1.3.55</a>
58h	LEDC_CTRL2	LEDC Control 2 Register	<a href="#">セクション 8.5.1.3.56</a>
59h	LEDC_CTRL3	LEDC Control 3 Register	<a href="#">セクション 8.5.1.3.57</a>
5Ah	LEDC_CTRL4	LEDC Control 4 Register	<a href="#">セクション 8.5.1.3.58</a>
5Bh	LEDC_CTRL5	LEDC Control 5 Register	<a href="#">セクション 8.5.1.3.59</a>
5Ch	LEDC_CTRL6	LEDC Control 6 Register	<a href="#">セクション 8.5.1.3.60</a>
5Dh	LEDC_CTRL7	LEDC Control 7 Register	<a href="#">セクション 8.5.1.3.61</a>
5Eh	LEDC_CTRL8	LEDC Control 8 Register	<a href="#">セクション 8.5.1.3.62</a>
5Fh	LED_RAMP_UP_TIME	LED Ramp-Up Time Register	<a href="#">セクション 8.5.1.3.63</a>
60h	LED_RAMP_DOWN_TIME	LED Ramp-Down Time Register	<a href="#">セクション 8.5.1.3.64</a>
61h	LED_SEQ_EN	LED Sequence Enable Register	<a href="#">セクション 8.5.1.3.65</a>
62h	LOADSWITCH	Load Switch Register	<a href="#">セクション 8.5.1.3.67</a>
63h	SPARE	Spare Register	<a href="#">セクション 8.5.1.3.68</a>
64h	VERNUM	Version Number Register	<a href="#">セクション 8.5.1.3.69</a>

Complex bit access types are encoded to fit into small table cells. 表 8-88 shows the codes that are used for access types in this section.

**表 8-88. DEVCTRL Access Type Codes**

Access Type	Code	Description
Read Type		
R	R	Read
Write Type		
W	W	Write
Reset or Default Value		
-n		Value after reset or the default value
-OTP		Bit reset value is defined in the OTP memory
-X		Bit determined by external connection

### 8.5.1.3.1 THRM\_REG Register (Offset = 22h) [reset = 0Dh]

THRM\_REG is shown in [表 8-89](#) and described in [表 8-90](#).

Return to [Summary Table](#).

Register is reset on a POR event.

**表 8-89. THRM\_REG Register**

7	6	5	4	3	2	1	0
RSVD		THERM_HD	THERM_TS	THERM_HDSEL[1:0]		RSVD	THERM_EN
R-00b		R-0b	R-0b	R/W-11b		R-0b	R/W-1b

**表 8-90. THRM\_REG Register Field Descriptions**

Bit	Field	Type	Reset	Description
7-6	RSVD	R	00b	Unused bit read returns 0b.
5	THERM_HD	R	0b	0b = Hot die threshold is not reached 1b = Hot die threshold is reached
4	THERM_TS	R	0b	Thermal shutdown detector output 0b = Indicates thermal shutdown not reached (typically 150°C) 1b = Indicates thermal shutdown reached
3-2	THERM_HDSEL	R/W	11b	Temperature selection for hot die detector 00b = T = 117°C 01b = T = 121°C 10b = T = 125°C 11b = T = 130°C
1	RSVD	R	0b	Unused bit
0	THERM_EN	R/W	1b	Thermal shutdown module 0b = Disabled 1b = Enabled

### 8.5.1.3.2 CLK32KOUT Register (Offset = 23h) [reset = OTP]

CLK32KOUT is shown in [表 8-91](#) and described in [表 8-92](#).

Return to [Summary Table](#).

Register is reset on a POR event.

**表 8-91. CLK32KOUT Register**

7	6	5	4	3	2	1	0
RSVD							CLK32KOUT_EN
R-0000000b							R/W-OTP

**表 8-92. CLK32KOUT Register Field Descriptions**

Bit	Field	Type	Reset	Description
7-1	RSVD	R	0000000b	Unused bit read returns 0b.
0	CLK32KOUT_EN	R/W	OTP	0b = 32KCLKOUT disabled 1b = 32KCLKOUT enabled

### 8.5.1.3.3 DEVCTRL Register (Offset = 24h) [reset = OTP]

DEVCTRL is shown in [表 8-93](#) and described in [表 8-94](#).

Return to [Summary Table](#).

Register is reset on a POR event.

**表 8-93. DEVCTRL Register**

7	6	5	4	3	2	1	0
PWR_OFF_SEQ	LOAD-OTP	LOCK_LDO9	RSVD	nRESPWRON_OUTPUT	PWRHLD	DEV_SLP	DEV_OFF
R/W-OTP	R/W-OTP	R-OTP	R-0b	R/W-OTP	R/W-OTP	R/W-0b	R/W-0b

**表 8-94. DEVCTRL Register Field Descriptions**

Bit	Field	Type	Reset	Description
7	PWR_OFF_SEQ	R/W	OTP	0b = All resources disabled at the same time 1b = Power-off will be sequential, reverse of power-on sequence (first resource to power on will be the last to power off)
6	LOAD-OTP	R/W	OTP	0b = Register contents are kept in the OFF state 1b = Register default values are reloaded from OTP when in the OFF state
5	LOCK_LDO9	R	OTP	0b = LDO9 bits are allowed to be changed 1b = LDO9 bits are locked; LDO9 is enabled in the startup sequence and disabled in the OFF state; no further control allowed
4	RSVD	R	0b	Unused bit read returns 0b.
3	nRESPWRON_OUTPUT	R/W	OTP	0b = NRESPWRON output is open drain 1b = NRESPWRON output is push-pull to VDDIO
2	PWRHLD	R/W	OTP	0b = Cleared in the OFF state. 1b = Writing 1b will maintain the device on (ACTIVE or SLEEP device state) unless one of the power off events occur (DEV_OFF, long key press if not masked, or thermal shutdown).
1	DEV_SLP	R/W	0b	0b = This bit is cleared in the OFF state. 1b = Writing 1b will starts an ACTIVE-to-SLEEP transition as long as no unmasked interrupts are pending. If set to 1b, the device will require an unmasked interrupt to occur to perform SLEEP-to-ACTIVE transition or will need to transition to OFF to clear this bit.
0	DEV_OFF	R/W	0b	0b = This bit is cleared in the OFF state. 1b = Writing 1b will start an ACTIVE-to-OFF or SLEEP-to-OFF device state transition (switch-off event). This event has priority over PWRHLD bit and PWRHOLD pin. Device will restart if either is high once transition to OFF state is complete.

### 8.5.1.3.4 DEVCTRL2 Register (Offset = 25h) [reset = OTP]

DEVCTRL2 is shown in [表 8-95](#) and described in [表 8-96](#).

Return to [Summary Table](#).

Register is reset on a POR event.

**表 8-95. DEVCTRL2 Register**

7	6	5	4	3	2	1	0
SLEEP_ENAB E	INT_OUTPUT	TSLOT_LENGTH[1:0]		SLEEP_POL	PWRON_LP_ OFF	PWRON_LP_ OFF_RST	INT_POL
R/W-0b	R/W-OTP	R/W-OTP		R/W-0b	R/W-OTP	R/W-OTP	R/W-OTP

**表 8-96. DEVCTRL2 Register Field Descriptions**

Bit	Field	Type	Reset	Description
7	SLEEP_ENABLE	R/W	0b	0b = SLEEP signal is ignored; default for power-up and should remain this way for CONFIG2 shorted to GND. 1b = SLEEP signal is unmasked and the device can enter SLEEP state if there are no pending interrupts and the SLEEP pin (CONFIG2 tied to LDOAO) is active as defined by the SLEEP_POL bit
6	INT_OUTPUT	R/W	OTP	0b = Interrupt output is open drain 1b = Interrupt output is push-pull to VDDIO
5-4	TSLOT_LENGTH[1:0]	R/W	OTP	Time slot duration programming; selects length of the timeslots for startup or shutdown timing 00b = 30 $\mu$ s 01b = 200 $\mu$ s 10b = 500 $\mu$ s 11b = 2 ms
3	SLEEP_POL	R/W	0b	0b = SLEEP signal active high 1b = SLEEP signal active low
2	PWRON_LP_OFF	R/W	OTP	0b = No effect 1b = Allows device turnoff after an nPWRON long press (signal low). After the nPWRON pin is low for 4 s, an interrupt is generated. After 1 additional second, the device performs the power-off sequence.
1	PWRON_LP_OFF_RST	R/W	OTP	0b = No effect 1b = Allows device turnoff after an nPWRON long press (signal low). After the nPWRON pin is low for 4 s, an interrupt is generated. After 1 additional second, the device performs the power-off sequence and registers are loaded with their default values, regardless of LOAD-OTP bit value. This bit has priority over the PWRON_LP_OFF bit and the LOAD-OTP bit.
0	INT_POL	R/W	OTP	0b = INT1 interrupt pad-polarity control signal is active low 1b = INT1 interrupt pad-polarity control signal is active high

### 8.5.1.3.5 I2C\_SPI\_CFG Register (Offset = 26h) [reset = OTP]

I2C\_SPI\_CFG is shown in [表 8-97](#) and described in [表 8-98](#).

Return to [Summary Table](#).

Register is reset on a POR event.

**表 8-97. I2C\_SPI\_CFG Register**

7	6	5	4	3	2	1	0
I2CAVS_ID_SEL[1:0]	I2CGP_ID_SEL[1:0]			DCDC4_AVS	DCDC3_AVS	DCDC2_AVS	DCDC1_AVS
R-OTP	R-OTP			R/W-OTP	R/W-OTP	R/W-OTP	R/W-OTP

**表 8-98. I2C\_SPI\_CFG Register Field Descriptions**

Bit	Field	Type	Reset	Description
7-6	I2CAVS_ID_SEL[1:0]	R	OTP	Device address for the AVS-I2C interface 00b = 12h 01b = 13h 10b = 14h 11b = 15h
5-4	I2CGP_ID_SEL1[1:0]	R	OTP	Device address for the standard-I2C interface 00b = 2Dh 01b = 2Eh 10b = 2Fh 11b = 30h
3	DCDC4_AVS	R/W	OTP	Interface assignment for the DCDC4_OP and DCDC4_AVS registers 0b = Standard interface 1b = AVS- interface
2	DCDC3_AVS	R/W	OTP	Interface assignment for the DCDC3_OP and DCDC3_AVS registers 0b = Standard interface 1b = AVS- interface
1	DCDC2_AVS	R/W	OTP	Interface assignment for the DCDC2_OP and DCDC2_AVS registers 0b = Standard interface 1b = AVS- interface
0	DCDC1_AVS	R/W	OTP	Interface assignment for the DCDC1_OP and DCDC1_AVS registers 0b = Standard interface 1b = AVS- interface

### 8.5.1.3.6 KEEP\_ON1 Register (Offset = 27h) [reset = OTP]

KEEP\_ON1 is shown in [表 8-99](#) and described in [表 8-100](#).

Return to [Summary Table](#).

Register is reset on a POR event.

Settings shown in [表 8-109](#)

**表 8-99. KEEP\_ON1 Register**

7	6	5	4	3	2	1	0
LDO8_KEEPO N	LDO7_KEEPO N	LDO6_KEEPO N	LDO5_KEEPO N	LDO4_KEEPO N	LDO3_KEEPO N	LDO2_KEEPO N	LDO1_KEEPO N
R/W-OTP	R/W-OTP	R/W-OTP	R/W-OTP	R/W-OTP	R/W-OTP	R/W-OTP	R/W-OTP

**表 8-100. KEEP\_ON1 Register Field Descriptions**

Bit	Field	Type	Reset	Description
7	LDO8_KEEPO	R/W	OTP	0b = Set in Eco-mode in the SLEEP state 1b = Keep active in the SLEEP state
6	LDO7_KEEPO	R/W	OTP	0b = Set in Eco-mode in the SLEEP state 1b = Keep active in the SLEEP state
5	LDO6_KEEPO	R/W	OTP	0b = Set in Eco-mode in the SLEEP state 1b = Keep active in the SLEEP state
4	LDO5_KEEPO	R/W	OTP	0b = Set in Eco-mode in the SLEEP state 1b = Keep active in the SLEEP state
3	LDO4_KEEPO	R/W	OTP	0b = Set in Eco-mode in the SLEEP state 1b = Keep active in the SLEEP state
2	LDO3_KEEPO	R/W	OTP	0b = Set in Eco-mode in the SLEEP state 1b = Keep active in the SLEEP state
1	LDO2_KEEPO	R/W	OTP	0b = Set in Eco-mode in the SLEEP state 1b = Keep active in the SLEEP state
0	LDO1_KEEPO	R/W	OTP	0b = Set in Eco-mode in the SLEEP state 1b = Keep active in the SLEEP state

### 8.5.1.3.7 KEEP\_ON2 Register (Offset = 28h) [reset = OTP]

KEEP\_ON2 is shown in [表 8-101](#) and described in [表 8-102](#).

Return to [Summary Table](#).

Register is reset on a POR event.

Settings shown in [表 8-109](#)

**表 8-101. KEEP\_ON2 Register**

7	6	5	4	3	2	1	0
RSVD		DCDC4_KEEPPON	DCDC3_KEEPPON	DCDC2_KEEPPON	DCDC1_KEEPPON	LDO10_KEEPPON	LDO9_KEEPPON
R-00b		R/W-OTP	R/W-OTP	R/W-OTP	R/W-OTP	R/W-OTP	R/W-OTP

**表 8-102. KEEP\_ON2 Register Field Descriptions**

Bit	Field	Type	Reset	Description
7-6	RSVD	R	00b	Unused bits
5	DCDC4_KEEPPON	R/W	OTP	0b = Set in Eco-mode in the SLEEP state, unless DCDC4_MODE = 1b 1b = Keep active in the SLEEP state
4	DCDC3_KEEPPON	R/W	OTP	0b = Set in Eco-mode in the SLEEP state, unless DCDC3_MODE = 1b 1b = Keep active in the SLEEP state
3	DCDC2_KEEPPON	R/W	OTP	0b = Set in Eco-mode in the SLEEP state, unless DCDC2_MODE = 1b 1b = Keep active in the SLEEP state
2	DCDC1_KEEPPON	R/W	OTP	0b = Set in Eco-mode in the SLEEP state, unless DCDC1_MODE = 1b 1b = Keep active in the SLEEP state
1	LDO10_KEEPPON	R/W	OTP	0b = Set in Eco-mode in the SLEEP state 1b = Keep active in the SLEEP state
0	LDO9_KEEPPON	R/W	OTP	0b = Set in Eco-mode in the SLEEP state 1b = Keep active in the SLEEP state

### 8.5.1.3.8 SET\_OFF1 Register (Offset = 29h) [reset = OTP]

SET\_OFF1 is shown in 表 8-103 and described in 表 8-104.

Return to [Summary Table](#).

Register is reset on a POR event.

Settings shown in 表 8-109

**表 8-103. SET\_OFF1 Register**

7	6	5	4	3	2	1	0
LDO8_SET_OFF F	LDO7_SET_OFF F	LDO6_SET_OFF F	LDO5_SET_OFF F	LDO4_SET_OFF F	LDO3_SET_OFF F	LDO2_SET_OFF F	LDO1_SET_OFF F
R/W-OTP	R/W-OTP	R/W-OTP	R/W-OTP	R/W-OTP	R/W-OTP	R/W-OTP	R/W-OTP

**表 8-104. SET\_OFF1 Register Field Descriptions**

Bit	Field	Type	Reset	Description
7	LDO8_SET_OFF	R/W	OTP	0b = Defined by the KEEP_ON register 1b = Set off in the SLEEP state if the KEEP_ON bit set to 0b
6	LDO7_SET_OFF	R/W	OTP	0b = Defined by the KEEP_ON register 1b = Set off in the SLEEP state if the KEEP_ON bit set to 0b
5	LDO6_SET_OFF	R/W	OTP	0b = Defined by the KEEP_ON register 1b = Set off in the SLEEP state if the KEEP_ON bit set to 0b
4	LDO5_SET_OFF	R/W	OTP	0b = Defined by the KEEP_ON register 1b = Set off in the SLEEP state if the KEEP_ON bit set to 0b
3	LDO4_SET_OFF	R/W	OTP	0b = Defined by the KEEP_ON register 1b = Set off in the SLEEP state if the KEEP_ON bit set to 0b
2	LDO3_SET_OFF	R/W	OTP	0b = Defined by the KEEP_ON register 1b = Set off in the SLEEP state if the KEEP_ON bit set to 0b
1	LDO2_SET_OFF	R/W	OTP	0b = Defined by the KEEP_ON register 1b = Set off in the SLEEP state if the KEEP_ON bit set to 0b
0	LDO1_SET_OFF	R/W	OTP	0b = Defined by the KEEP_ON register 1b = Set off in the SLEEP state if the KEEP_ON bit set to 0b



### 8.5.1.3.9 SET\_OFF2 Register (Offset = 2Ah) [reset = OTP]

SET\_OFF2 is shown in 表 8-105 and described in 表 8-106.

Return to [Summary Table](#).

Register is reset on a POR event.

Settings shown in [セクション 8.5.1.3.11](#).

**表 8-105. SET\_OFF2 Register**

7	6	5	4	3	2	1	0
THERM_KEEP_ON	CLK32KOUT_KEEPON	DCDC4_SET_OFF	DCDC3_SET_OFF	DCDC2_SET_OFF	DCDC1_SET_OFF	LDO10_SET_OFF	LDO9_SET_OFF
R/W-OTP	R/W-OTP	R/W-OTP	R/W-OTP	R/W-OTP	R/W-OTP	R/W-OTP	R/W-OTP

**表 8-106. SET\_OFF2 Register Field Descriptions**

Bit	Field	Type	Reset	Description
7	THERM_KEEP_ON	R/W	OTP	0b = Enabled in the SLEEP state 1b = Set off in the SLEEP state
6	CLK32KOUT_KEEPON	R/W	OTP	0b = Enabled in the SLEEP state 1b = Set off in the SLEEP state
5	DCDC4_SET_OFF	R/W	OTP	0b = Defined by the KEEP_ON register 1b = Set off in the SLEEP state if the KEEP_ON bit set to 0b
4	DCDC3_SET_OFF	R/W	OTP	0b = Defined by the KEEP_ON register 1b = Set off in the SLEEP state if the KEEP_ON bit set to 0b
3	DCDC2_SET_OFF	R/W	OTP	0b = Defined by the KEEP_ON register 1b = Set off in the SLEEP state if the KEEP_ON bit set to 0b
2	DCDC1_SET_OFF	R/W	OTP	0b = Defined by the KEEP_ON register 1b = Set off in the SLEEP state if the KEEP_ON bit set to 0b
1	LDO10_SET_OFF	R/W	OTP	0b = Defined by the KEEP_ON register 1b = Set off in the SLEEP state if the KEEP_ON bit set to 0b
0	LDO9_SET_OFF	R/W	OTP	0b = Defined by the KEEP_ON register 1b = Set off in the SLEEP state if the KEEP_ON bit set to 0b

### 8.5.1.3.10 DEF\_VOLT Register (Offset = 2Bh) [reset = OTP]

DEF\_VOLT is shown in 表 8-107 and described in 表 8-108.

Return to [Summary Table](#).

Register is reset on a POR event.

Settings shown in 表 8-109

**表 8-107. DEF\_VOLT Register**

7	6	5	4	3	2	1	0
LDO4_DEF_VOLT	LDO3_DEF_VOLT	LDO2_DEF_VOLT	LDO1_DEF_VOLT	DCDC4_DEF_VOLT	DCDC3_DEF_VOLT	DCDC2_DEF_VOLT	DCDC1_DEF_VOLT
R/W-OTP	R/W-OTP	R/W-OTP	R/W-OTP	R/W-OTP	R/W-OTP	R/W-OTP	R/W-OTP

**表 8-108. DEF\_VOLT Register Field Descriptions**

Bit	Field	Type	Reset	Description
7	LDO4_DEF_VOLT	R/W	OTP	See 表 8-6
6	LDO3_DEF_VOLT	R/W	OTP	See 表 8-6
5	LDO2_DEF_VOLT	R/W	OTP	See 表 8-6
4	LDO1_DEF_VOLT	R/W	OTP	See 表 8-6
3	DCDC4_DEF_VOLT	R/W	OTP	See 表 8-6

**表 8-108. DEF\_VOLT Register Field Descriptions (continued)**

Bit	Field	Type	Reset	Description
2	DCDC3_DEF_VOLT	R/W	OTP	See <a href="#">表 8-6</a>
1	DCDC2_DEF_VOLT	R/W	OTP	See <a href="#">表 8-6</a>
0	DCDC1_DEF_VOLT	R/W	OTP	See <a href="#">表 8-6</a>

### 8.5.1.3.11 LDO Sleep Mode Behavior

**表 8-109. LDO SLEEP MODE BEHAVIOR**

CONFIG BITS	LDO IS SET TO Eco-mode	LDO STAYS ACTIVE	LDO IS SET TO OFF
DEF_VOLT	0b = Voltage defined by the _OP register	0b = Voltage defined by the _OP register	0b = Voltage defined by the _OP register
	1b = Voltage defined by the _AVS register	1b = Voltage defined by the _AVS register	1b = Voltage defined by the _AVS register
KEEP ON	0b	1b	0b
SET OFF	0b	x	1b

### 8.5.1.3.12 DEF\_VOLT\_MAPPING Register (Offset = 2Ch) [reset = OTP]

DEF\_VOLT\_MAPPING is shown in 表 8-110 and described in 表 8-111.

Return to [Summary Table](#).

Register is reset on a POR event.

**表 8-110. DEF\_VOLT\_MAPPING Register**

7	6	5	4	3	2	1	0
LDO4_VOLT_MAPPING[1:0]	LDO3_VOLT_MAPPING[1:0]	LDO2_VOLT_MAPPING[1:0]	LDO1_VOLT_MAPPING[1:0]				
R/W-OTP	R/W-OTP	R/W-OTP	R/W-OTP				

**表 8-111. DEF\_VOLT\_MAPPING Register Field Descriptions**

Bit	Field	Type	Reset	Description
7-6	LDO4_VOLT_MAPPING[1:0]	R/W	OTP	Maps a DCDCx_SEL pin to the voltage scaling function to select either LDO4_OP or LDO4_AVS as the register defining the output voltage for LDO4 for when CONFIG2 is tied to GND. DEF_VOLT bit set and cleared by the status of the: 00b = DCDC1_SEL pin 01b = DCDC2_SEL pin 10b = DCDC3_SEL pin 11b = DCDC4_SEL pin
5-4	LDO3_VOLT_MAPPING[1:0]	R/W	OTP	Maps a DCDCx_SEL pin to the voltage scaling function to select either LDO3_OP or LDO3_AVS as the register defining the output voltage for LDO3. DEF_VOLT bit set and cleared by the status of the: 00b = DCDC1_SEL pin 01b = DCDC2_SEL pin 10b = DCDC3_SEL pin 11b = DCDC4_SEL pin
3-2	LDO2_VOLT_MAPPING[1:0]	R/W	OTP	Maps a DCDCx_SEL pin to the voltage scaling function to select either LDO2_OP or LDO2_AVS as the register defining the output voltage for LDO2. DEF_VOLT bit set and cleared by the status of the: 00b = DCDC1_SEL pin 01b = DCDC2_SEL pin 10b = DCDC3_SEL pin 11b = DCDC4_SEL pin

表 8-111. DEF\_VOLT\_MAPPING Register Field Descriptions (continued)

Bit	Field	Type	Reset	Description
1-0	LDO1_VOLT_MAPPING[1:0]	R/W	OTP	<p>Maps a DCDCx_SEL pin to the voltage scaling function to select either LDO1_OP or LDO1_AVS as the register defining the output voltage for LDO1.</p> <p>DEF_VOLT bit set and cleared by the status of the:</p> <p>00b = DCDC1_SEL pin            01b = DCDC2_SEL pin            10b = DCDC3_SEL pin            11b = DCDC4_SEL pin</p>

### 8.5.1.3.13 DISCHARGE1 Register (Offset = 2Dh) [reset = OTP]

DISCHARGE1 is shown in [表 8-112](#) and described in [表 8-113](#).

Return to [Summary Table](#).

Register is reset on a POR event.

**表 8-112. DISCHARGE1 Register**

7	6	5	4	3	2	1	0
LDO8_ DISCHARGE	LDO7_ DISCHARGE	LDO6_ DISCHARGE	LDO5_ DISCHARGE	LDO4_ DISCHARGE	LDO3_ DISCHARGE	LDO2_ DISCHARGE	LDO1_ DISCHARGE
R/W-OTP	R/W-OTP	R/W-OTP	R/W-OTP	R/W-OTP	R/W-OTP	R/W-OTP	R/W-OTP

**表 8-113. DISCHARGE1 Register Field Descriptions**

Bit	Field	Type	Reset	Description
7	LDO8_DISCHARGE	R/W	OTP	0b = LDO8 output is not discharged when disabled 1b = LDO8 output is discharged when disabled
6	LDO7_DISCHARGE	R/W	OTP	0b = LDO7 output is not discharged when disabled 1b = LDO7 output is discharged when disabled
5	LDO6_DISCHARGE	R/W	OTP	0b = LDO6 output is not discharged when disabled 1b = LDO6 output is discharged when disabled
4	LDO5_DISCHARGE	R/W	OTP	0b = LDO5 output is not discharged when disabled 1b = LDO5 output is discharged when disabled
3	LDO4_DISCHARGE	R/W	OTP	0b = LDO4 output is not discharged when disabled 1b = LDO4 output is discharged when disabled
2	LDO3_DISCHARGE	R/W	OTP	0b = LDO3 output is not discharged when disabled 1b = LDO3 output is discharged when disabled
1	LDO2_DISCHARGE	R/W	OTP	0b = LDO2 output is not discharged when disabled 1b = LDO2 output is discharged when disabled
0	LDO1_DISCHARGE	R/W	OTP	0b = LDO1 output is not discharged when disabled 1b = LDO1 output is discharged when disabled

### 8.5.1.3.14 DISCHARGE2 Register (Offset = 2Eh) [reset = OTP]

DISCHARGE2 is shown in [表 8-114](#) and described in [表 8-115](#).

Return to [Summary Table](#).

Register is reset on a POR event.

**表 8-114. DISCHARGE2 Register**

7	6	5	4	3	2	1	0
RSVD		DCDC4_ DISCHARGE	DCDC3_ DISCHARGE	DCDC2_ DISCHARGE	DCDC1_ DISCHARGE	LDO10_ DISCHARGE	LDO9_ DISCHARGE
R-00b		R/W-OTP	R/W-OTP	R/W-OTP	R/W-OTP	R/W-OTP	R/W-OTP

**表 8-115. DISCHARGE2 Register Field Descriptions**

Bit	Field	Type	Reset	Description
7-6	RSVD	R	00b	Unused bit read returns 0b.
5	DCDC4_DISCHARGE	R/W	OTP	0b = DCDC4 output is not discharged when disabled 1b = DCDC4 output is discharged when disabled
4	DCDC3_DISCHARGE	R/W	OTP	0b = DCDC3 output is not discharged when disabled 1b = DCDC3 output is discharged when disabled
3	DCDC2_DISCHARGE	R/W	OTP	0b = DCDC2 output is not discharged when disabled 1b = DCDC2 output is discharged when disabled
2	DCDC1_DISCHARGE	R/W	OTP	0b = DCDC1 output is not discharged when disabled 1b = DCDC1 output is discharged when disabled
1	LDO10_DISCHARGE	R/W	OTP	0b = LDO10 output is not discharged when disabled 1b = LDO10 output is discharged when disabled
0	LDO9_DISCHARGE	R/W	OTP	0b = LDO9 output is not discharged when disabled 1b = LDO9 output is discharged when disabled

### 8.5.1.3.15 EN1\_SET1 Register (Offset = 2Fh) [reset = OTP]

EN1\_SET1 is shown in 表 8-116 and described in 表 8-117.

Return to [Summary Table](#).

Register is reset on a POR event.

**表 8-116. EN1\_SET1 Register**

7	6	5	4	3	2	1	0
LDO8_EN1	LDO7_EN1	LDO6_EN1	LDO5_EN1	LDO4_EN1	LDO3_EN1	LDO2_EN1	LDO1_EN1
R/W-OTP	R/W-OTP	R/W-OTP	R/W-OTP	R/W-OTP	R/W-OTP	R/W-OTP	R/W-OTP

**表 8-117. EN1\_SET1 Register Field Descriptions**

Bit	Field	Type	Reset	Description
7	LDO8_EN1	R/W	OTP	0b = EN1 pin has no effect on LDO8 enable 1b = EN1 pin is controlling LDO8
6	LDO7_EN1	R/W	OTP	0b = EN1 pin has no effect on LDO7 enable 1b = EN1 pin is controlling LDO7
5	LDO6_EN1	R/W	OTP	0b = EN1 pin has no effect on LDO6 enable 1b = EN1 pin is controlling LDO6
4	LDO5_EN1	R/W	OTP	0b = EN1 pin has no effect on LDO5 enable 1b = EN1 pin is controlling LDO5
3	LDO4_EN1	R/W	OTP	0b = EN1 pin has no effect on LDO4 enable 1b = EN1 pin is controlling LDO4
2	LDO3_EN1	R/W	OTP	0b = EN1 pin has no effect on LDO3 enable 1b = EN1 pin is controlling LDO3
1	LDO2_EN1	R/W	OTP	0b = EN1 pin has no effect on LDO2 enable 1b = EN1 pin is controlling LDO2
0	LDO1_EN1	R/W	OTP	0b = EN1 pin has no effect on LDO1 enable 1b = EN1 pin is controlling LDO1

### 8.5.1.3.16 EN1\_SET2 Register (Offset = 30h) [reset = OTP]

EN1\_SET2 is shown in 表 8-118 and described in 表 8-119.

Return to [Summary Table](#).

Register is reset on a POR event.

**表 8-118. EN1\_SET2 Register**

7	6	5	4	3	2	1	0
RSVD		DCDC4_EN1	DCDC3_EN1	DCDC2_EN1	DCDC1_EN1	LDO10_EN1	LDO9_EN1
R-00b		R/W-OTP	R/W-OTP	R/W-OTP	R/W-OTP	R/W-OTP	R/W-OTP

**表 8-119. EN1\_SET2 Register Field Descriptions**

Bit	Field	Type	Reset	Description
7-6	RSVD	R	00b	Unused bit read returns 0b.
5	DCDC4_EN1	R/W	OTP	0b = EN1 pin has no effect on DCDC4 enable 1b = EN1 pin is controlling DCDC4
4	DCDC3_EN1	R/W	OTP	0b = EN1 pin has no effect on DCDC3 enable 1b = EN1 pin is controlling DCDC3

**表 8-119. EN1\_SET2 Register Field Descriptions (continued)**

Bit	Field	Type	Reset	Description
3	DCDC2_EN1	R/W	OTP	0b = EN1 pin has no effect on DCDC2 enable 1b = EN1 pin is controlling DCDC2
2	DCDC1_EN1	R/W	OTP	0b = EN1 pin has no effect on DCDC1 enable 1b = EN1 pin is controlling DCDC1
1	LDO10_EN1	R/W	OTP	0b = EN1 pin has no effect on LDO10 enable 1b = EN1 pin is controlling LDO10
0	LDO9_EN1	R/W	OTP	0b = EN1 pin has no effect on LDO9 enable 1b = EN1 pin is controlling LDO9



### 8.5.1.3.17 EN2\_SET1 Register (Offset = 31h) [reset = OTP]

EN2\_SET1 is shown in [表 8-120](#) and described in [表 8-121](#).

Return to [Summary Table](#).

Register is reset on a POR event.

**表 8-120. EN2\_SET1 Register**

7	6	5	4	3	2	1	0
LDO8_EN2	LDO7_EN2	LDO6_EN2	LDO5_EN2	LDO4_EN2	LDO3_EN2	LDO2_EN2	LDO1_EN2
R/W-OTP	R/W-OTP	R/W-OTP	R/W-OTP	R/W-OTP	R/W-OTP	R/W-OTP	R/W-OTP

**表 8-121. EN2\_SET1 Register Field Descriptions**

Bit	Field	Type	Reset	Description
7	LDO8_EN2	R/W	OTP	0b = EN2 pin has no effect on LDO8 enable 1b = EN2 pin is controlling LDO8
6	LDO7_EN2	R/W	OTP	0b = EN2 pin has no effect on LDO7 enable 1b = EN2 pin is controlling LDO7
5	LDO6_EN2	R/W	OTP	0b = EN2 pin has no effect on LDO6 enable 1b = EN2 pin is controlling LDO6
4	LDO5_EN2	R/W	OTP	0b = EN2 pin has no effect on LDO5 enable 1b = EN2 pin is controlling LDO5
3	LDO4_EN2	R/W	OTP	0b = EN2 pin has no effect on LDO4 enable 1b = EN2 pin is controlling LDO4
2	LDO3_EN2	R/W	OTP	0b = EN2 pin has no effect on LDO3 enable 1b = EN2 pin is controlling LDO3
1	LDO2_EN2	R/W	OTP	0b = EN2 pin has no effect on LDO2 enable 1b = EN2 pin is controlling LDO2
0	LDO1_EN2	R/W	OTP	0b = EN2 pin has no effect on LDO1 enable 1b = EN2 pin is controlling LDO1

### 8.5.1.3.18 EN2\_SET2 Register (Offset = 32h) [reset = OTP]

EN2\_SET2 is shown in [表 8-122](#) and described in [表 8-123](#).

Return to [Summary Table](#).

Register is reset on a POR event.

**表 8-122. EN2\_SET2 Register**

7	6	5	4	3	2	1	0
RSVD		DCDC4_EN2	DCDC3_EN2	DCDC2_EN2	DCDC1_EN2	LDO10_EN2	LDO9_EN2
R-00b		R/W-OTP	R/W-OTP	R/W-OTP	R/W-OTP	R/W-OTP	R/W-OTP

**表 8-123. EN2\_SET2 Register Field Descriptions**

Bit	Field	Type	Reset	Description
7-6	RSVD	R	00b	Unused bit read returns 0b.
5	DCDC4_EN2	R/W	OTP	0b = EN2 pin has no effect on DCDC4 enable 1b = EN2 pin is controlling DCDC4
4	DCDC3_EN2	R/W	OTP	0b = EN2 pin has no effect on DCDC3 enable 1b = EN2 pin is controlling DCDC3

**表 8-123. EN2\_SET2 Register Field Descriptions (continued)**

Bit	Field	Type	Reset	Description
3	DCDC2_EN2	R/W	OTP	0b = EN2 pin has no effect on DCDC2 enable 1b = EN2 pin is controlling DCDC2
2	DCDC1_EN2	R/W	OTP	0b = EN2 pin has no effect on DCDC1 enable 1b = EN2 pin is controlling DCDC1
1	LDO10_EN2	R/W	OTP	0b = EN2 pin has no effect on LDO10 enable 1b = EN2 pin is controlling LDO10
0	LDO9_EN2	R/W	OTP	0b = EN2 pin has no effect on LDO9 enable 1b = EN2 pin is controlling LDO9

### 8.5.1.3.19 EN3\_SET1 Register (Offset = 33h) [reset = OTP]

EN3\_SET1 is shown in 表 8-124 and described in 表 8-125.

Return to [Summary Table](#).

Register is reset on a POR event.

表 8-124. EN3\_SET1 Register

7	6	5	4	3	2	1	0
LDO8_EN3	LDO7_EN3	LDO6_EN3	LDO5_EN3	LDO4_EN3	LDO3_EN3	LDO2_EN3	LDO1_EN3
R/W-OTP	R/W-OTP	R/W-OTP	R/W-OTP	R/W-OTP	R/W-OTP	R/W-OTP	R/W-OTP

表 8-125. EN3\_SET1 Register Field Descriptions

Bit	Field	Type	Reset	Description
7	LDO8_EN3	R/W	OTP	0b = EN3 pin has no effect on LDO8 enable 1b = EN3 pin is controlling LDO8
6	LDO7_EN3	R/W	OTP	0b = EN3 pin has no effect on LDO7 enable 1b = EN3 pin is controlling LDO7
5	LDO6_EN3	R/W	OTP	0b = EN3 pin has no effect on LDO6 enable 1b = EN3 pin is controlling LDO6
4	LDO5_EN3	R/W	OTP	0b = EN3 pin has no effect on LDO5 enable 1b = EN3 pin is controlling LDO5
3	LDO4_EN3	R/W	OTP	0b = EN3 pin has no effect on LDO4 enable 1b = EN3 pin is controlling LDO4
2	LDO3_EN3	R/W	OTP	0b = EN3 pin has no effect on LDO3 enable 1b = EN3 pin is controlling LDO3
1	LDO2_EN3	R/W	OTP	0b = EN3 pin has no effect on LDO2 enable 1b = EN3 pin is controlling LDO2
0	LDO1_EN3	R/W	OTP	0b = EN3 pin has no effect on LDO1 enable 1b = EN3 pin is controlling LDO1

### 8.5.1.3.20 EN3\_SET2 Register (Offset = 34h) [reset = OTP]

EN3\_SET2 is shown in 表 8-126 and described in 表 8-127.

Return to [Summary Table](#).

Register is reset on a POR event.

表 8-126. EN3\_SET2 Register

7	6	5	4	3	2	1	0
RSVD	DCDC4_EN3	DCDC3_EN3	DCDC2_EN3	DCDC1_EN3	LDO10_EN3	LDO9_EN3	
R-00b	R/W-OTP	R/W-OTP	R/W-OTP	R/W-OTP	R/W-OTP	R/W-OTP	R/W-OTP

表 8-127. EN3\_SET2 Register Field Descriptions

Bit	Field	Type	Reset	Description
7-6	RSVD	R	00b	Unused bit read returns 0b.
5	DCDC4_EN3	R/W	OTP	0b = EN3 pin has no effect on DCDC4 enable 1b = EN3 pin is controlling DCDC4
4	DCDC3_EN3	R/W	OTP	0b = EN3 pin has no effect on DCDC3 enable 1b = EN3 pin is controlling DCDC3

**表 8-127. EN3\_SET2 Register Field Descriptions (continued)**

Bit	Field	Type	Reset	Description
3	DCDC2_EN3	R/W	OTP	0b = EN3 pin has no effect on DCDC2 enable 1b = EN3 pin is controlling DCDC2
2	DCDC1_EN3	R/W	OTP	0b = EN3 pin has no effect on DCDC1 enable 1b = EN3 pin is controlling DCDC1
1	LDO10_EN3	R/W	OTP	0b = EN3 pin has no effect on LDO10 enable 1b = EN3 pin is controlling LDO10
0	LDO9_EN3	R/W	OTP	0b = EN3 pin has no effect on LDO9 enable 1b = EN3 pin is controlling LDO9

### 8.5.1.3.21 EN4\_SET1 Register (Offset = 35h) [reset = OTP]

EN4\_SET1 is shown in 表 8-128 and described in 表 8-129.

Return to [Summary Table](#).

Register is reset on a POR event.

表 8-128. EN4\_SET1 Register

7	6	5	4	3	2	1	0
LDO8_EN4	LDO7_EN4	LDO6_EN4	LDO5_EN4	LDO4_EN4	LDO3_EN4	LDO2_EN4	LDO1_EN4
R/W-OTP	R/W-OTP	R/W-OTP	R/W-OTP	R/W-OTP	R/W-OTP	R/W-OTP	R/W-OTP

表 8-129. EN4\_SET1 Register Field Descriptions

Bit	Field	Type	Reset	Description
7	LDO8_EN4	R/W	OTP	0b = EN4 pin has no effect on LDO8 enable 1b = EN4 pin is controlling LDO8
6	LDO7_EN4	R/W	OTP	0b = EN4 pin has no effect on LDO7 enable 1b = EN4 pin is controlling LDO7
5	LDO6_EN4	R/W	OTP	0b = EN4 pin has no effect on LDO6 enable 1b = EN4 pin is controlling LDO6
4	LDO5_EN4	R/W	OTP	0b = EN4 pin has no effect on LDO5 enable 1b = EN4 pin is controlling LDO5
3	LDO4_EN4	R/W	OTP	0b = EN4 pin has no effect on LDO4 enable 1b = EN4 pin is controlling LDO4
2	LDO3_EN4	R/W	OTP	0b = EN4 pin has no effect on LDO3 enable 1b = EN4 pin is controlling LDO3
1	LDO2_EN4	R/W	OTP	0b = EN4 pin has no effect on LDO2 enable 1b = EN4 pin is controlling LDO2
0	LDO1_EN4	R/W	OTP	0b = EN4 pin has no effect on LDO1 enable 1b = EN4 pin is controlling LDO1

### 8.5.1.3.22 EN4\_SET2 Register (Offset = 36h) [reset = OTP]

EN4\_SET2 is shown in 表 8-130 and described in 表 8-131.

Return to [Summary Table](#).

Register is reset on a POR event.

表 8-130. EN4\_SET2 Register

7	6	5	4	3	2	1	0
RSVD		DCDC4_EN4	DCDC3_EN4	DCDC2_EN4	DCDC1_EN4	LDO10_EN4	LDO9_EN4
R-00b		R/W-OTP	R/W-OTP	R/W-OTP	R/W-OTP	R/W-OTP	R/W-OTP

表 8-131. EN4\_SET2 Register Field Descriptions

Bit	Field	Type	Reset	Description
7-6	RSVD	R	00b	Unused bit read returns 0b.
5	DCDC4_EN4	R/W	OTP	0b = EN4 pin has no effect on DCDC4 enable 1b = EN4 pin is controlling DCDC4
4	DCDC3_EN4	R/W	OTP	0b = EN4 pin has no effect on DCDC3 enable 1b = EN4 pin is controlling DCDC3

**表 8-131. EN4\_SET2 Register Field Descriptions (continued)**

Bit	Field	Type	Reset	Description
3	DCDC2_EN4	R/W	OTP	0b = EN4 pin has no effect on DCDC2 enable 1b = EN4 pin is controlling DCDC2
2	DCDC1_EN4	R/W	OTP	0b = EN4 pin has no effect on DCDC1 enable 1b = EN4 pin is controlling DCDC1
1	LDO10_EN4	R/W	OTP	0b = EN4 pin has no effect on LDO10 enable 1b = EN4 pin is controlling LDO10
0	LDO9_EN4	R/W	OTP	0b = EN4 pin has no effect on LDO9 enable 1b = EN4 pin is controlling LDO9

### 8.5.1.3.23 PGOOD Register (Offset = 37h) [reset = OTP]

PGOOD is shown in [表 8-132](#) and described in [表 8-133](#).

Return to [Summary Table](#).

Register is reset on a POR event.

**表 8-132. PGOOD Register**

7	6	5	4	3	2	1	0
PGOOD_LDO4	PGOOD_LDO3	PGOOD_LDO2	PGOOD_LDO1	PGOOD_DCDC 4	PGOOD_DCDC 3	PGOOD_DCDC 2	PGOOD_DCDC 1
R-0b	R-0b	R-0b	R-0b	R-0b	R-0b	R-0b	R-0b

**表 8-133. PGOOD Register Field Descriptions**

Bit	Field	Type	Reset	Description
7	PGOOD_LDO4	R	0b	The bit is set or cleared by the power-good comparator in the LDO converter block 0b = LDO4 output voltage is below its target regulation voltage or disabled 1b = LDO4 output voltage is in regulation
6	PGOOD_LDO3	R	0b	The bit is set or cleared by the power-good comparator in the LDO converter block 0b = LDO3 output voltage is below its target regulation voltage or disabled 1b = LDO3 output voltage is in regulation
5	PGOOD_LDO2	R	0b	The bit is set or cleared by the power-good comparator in the LDO converter block 0b = LDO2 output voltage is below its target regulation voltage or disabled 1b = LDO2 output voltage is in regulation
4	PGOOD_LDO1	R	0b	The bit is set or cleared by the power-good comparator in the LDO converter block 0b = LDO1 output voltage is below its target regulation voltage or disabled 1b = LDO1 output voltage is in regulation
3	PGOOD_DCDC4	R	0b	The bit is set or cleared by the power-good comparator in the DC-DC converter block The PGOOD_LDO4 bit is not valid if the LDO is enabled but the supply voltage to the LDO is below 1 V. 0b = DCDC4 output voltage is below its target regulation voltage or disabled 1b = DCDC4 output voltage is in regulation
2	PGOOD_DCDC3	R	0b	The bit is set or cleared by the power-good comparator in the DC-DC converter block The PGOOD_LDO3 bit is not valid if the LDO is enabled but the supply voltage to the LDO is below 1 V. 0b = DCDC3 output voltage is below its target regulation voltage or disabled 1b = DCDC3 output voltage is in regulation

**表 8-133. PGOOD Register Field Descriptions (continued)**

Bit	Field	Type	Reset	Description
1	PGOOD_DCDC2	R	0b	The bit is set or cleared by the power-good comparator in the DC-DC converter block The PGOOD_LDO2 bit is not valid if the LDO is enabled but the supply voltage to the LDO is below 1 V. 0b = DCDC2 output voltage is below its target regulation voltage or disabled 1b = DCDC2 output voltage is in regulation
0	PGOOD_DCDC1	R	0b	The bit is set or cleared by the power-good comparator in the DC-DC converter block The PGOOD_LDO1 bit is not valid if the LDO is enabled but the supply voltage to the LDO is below 1 V. 0b = DCDC1 output voltage is below its target regulation voltage or disabled 1b = DCDC1 output voltage is in regulation

**8.5.1.3.24 PGOOD2 Register (Offset = 38h) [reset = OTP]**

PGOOD2 is shown in [表 8-134](#) and described in [表 8-135](#).

Return to [Summary Table](#).

Register is reset on a POR event.

**表 8-134. PGOOD2 Register**

7	6	5	4	3	2	1	0
RSVD		PGOOD_LDO10	PGOOD_LDO9	PGOOD_LDO8	PGOOD_LDO7	PGOOD_LDO6	PGOOD_LDO5
R-00b		R-0b	R-0b	R-0b	R-0b	R-0b	R-0b

**表 8-135. PGOOD2 Register Field Descriptions**

Bit	Field	Type	Reset	Description
7-6	RSVD	R	00b	Unused bit read returns 0b.
5	PGOOD_LDO10	R	0b	The bit is set or cleared by the power-good comparator in the LDO converter block The PGOOD_LDO10 bit is not valid if the LDO is enabled but the supply voltage to the LDO is below 1 V. 0b = LDO10 output voltage is below its target regulation voltage or disabled 1b = LDO10 output voltage is in regulation
4	PGOOD_LDO9	R	0b	The bit is set or cleared by the power-good comparator in the LDO converter block The PGOOD_LDO9 bit is not valid if the LDO is enabled but the supply voltage to the LDO is below 1 V. 0b = LDO9 output voltage is below its target regulation voltage or disabled 1b = LDO9 output voltage is in regulation



**表 8-135. PGOOD2 Register Field Descriptions (continued)**

Bit	Field	Type	Reset	Description
3	PGOOD_LDO8	R	0b	<p>The bit is set or cleared by the power-good comparator in the LDO converter block</p> <p>The PGOOD_LDO8 bit is not valid if the LDO is enabled but the supply voltage to the LDO is below 1 V.</p> <p>0b = LDO8 output voltage is below its target regulation voltage or disabled</p> <p>1b = LDO8 output voltage is in regulation</p>
2	PGOOD_LDO7	R	0b	<p>The bit is set or cleared by the power-good comparator in the LDO converter block</p> <p>The PGOOD_LDO7 bit is not valid if the LDO is enabled but the supply voltage to the LDO is below 1 V.</p> <p>0b = LDO7 output voltage is below its target regulation voltage or disabled</p> <p>1b = LDO7 output voltage is in regulation</p>
1	PGOOD_LDO6	R	0b	<p>The bit is set or cleared by the power-good comparator in the LDO converter block</p> <p>The PGOOD_LDO6 bit is not valid if the LDO is enabled but the supply voltage to the LDO is below 1 V.</p> <p>0b = LDO6 output voltage is below its target regulation voltage or disabled</p> <p>1b = LDO6 output voltage is in regulation</p>
0	PGOOD_LDO5	R	0b	<p>The bit is set or cleared by the power-good comparator in the LDO converter block</p> <p>The PGOOD_LDO5 bit is not valid if the LDO is enabled but the supply voltage to the LDO is below 1 V.</p> <p>0b = LDO5 output voltage is below its target regulation voltage or disabled</p> <p>1b = LDO5 output voltage is in regulation</p>

### 8.5.1.3.25 INT\_STS Register (Offset = 39h) [reset = 00h]

INT\_STS is shown in [表 8-136](#) and described in [表 8-137](#).

Return to [Summary Table](#).

Register is reset on a POR event.

**表 8-136. INT\_STS Register**

7	6	5	4	3	2	1	0
GPIO1_F_IT	GPIO1_R_IT	HOTDIE_IT	PWRHOLD_R_I T	PWRON_LP_IT	PWRON_IT	VMON_IT	PWRHOLD_F_I T
R/W-0b	R/W-0b	R/W-0b	R/W-0b	R/W-0b	R/W-0b	R/W-0b	R/W-0b

**表 8-137. INT\_STS Register Field Descriptions**

Bit	Field	Type	Reset	Description
7	GPIO1_F_IT	R/W	0b	0b = No falling edge occurred 1b = GPIO1 falling edge detection interrupt status; write 1b to clear the interrupt flag
6	GPIO1_R_IT	R/W	0b	0b = No rising edge occurred 1b = GPIO1 rising edge detection interrupt status; write 1b to clear the interrupt flag
5	HOTDIE_IT	R/W	0b	0b = No hot die event occurred 1b = Hot die event interrupt status; write 1b to clear the interrupt flag
4	PWRHOLD_R_IT	R/W	0b	0b = No rising edge on the PWRHOLD pin is detected 1b = Rising PWRHOLD event interrupt status; write 1b to clear the interrupt flag
3	PWRON_LP_IT	R/W	0b	0b = No nPWRON long press key detected 1b = nPWRON long press event interrupt status; write 1b to clear the interrupt flag
2	PWRON_IT	R/W	0b	0b = No nPWRON event detected 1b = nPWRON event interrupt status; write 1b to clear the interrupt flag
1	VMON_IT	R/W	0b	0b = No VMON event detected 1b = falling edge detection for VMON; voltage at VMON is below the VMON_SEL[1:0] threshold; no delay; write 1b to clear the interrupt flag
0	PWRHOLD_F_IT	R/W	0b	0b = No PWRHOLD event detected 1b = Falling PWRHOLD event interrupt status; write 1b to clear the interrupt flag

### 8.5.1.3.26 INT\_MSK Register (Offset = 3Ah) [reset = FFh]

INT\_MSK is shown in [表 8-138](#) and described in [表 8-139](#).

Return to [Summary Table](#).

Register is reset on a POR event.

**表 8-138. INT\_MSK Register**

7	6	5	4	3	2	1	0
GPIO1_F_ IT_MSK	GPIO1_R_ IT_MSK	HOTDIE_ IT_MSK	PWRHOLD_R_ IT_MSK	PWRON_LP_ IT_MSK	PWRON_ IT_MSK	VMON_ IT_MSK	PWRHOLD_F_ IT_MSK
R/W-OTP	R/W-OTP	R/W-OTP	R/W-OTP	R/W-OTP	R/W-OTP	R/W-OTP	R/W-OTP

**表 8-139. INT\_MSK Register Field Descriptions**

Bit	Field	Type	Reset	Description
7	GPIO1_F_IT_MSK	R/W	OTP	0b = Interrupt not masked OTP = GPIO1 falling edge detection interrupt masked
6	GPIO1_R_IT_MSK	R/W	OTP	0b = Interrupt not masked OTP = GPIO1 rising edge detection interrupt masked
5	HOTDIE_IT_MSK	R/W	OTP	0b = Interrupt not masked OTP = Hot die event interrupt masked
4	PWRHOLD_R_IT_MSK	R/W	OTP	0b = Interrupt not masked OTP = Rising PWRHOLD event interrupt masked
3	PWRON_LP_IT_MSK	R/W	OTP	0b = Interrupt not masked OTP = nPWRON Long Press event interrupt masked
2	PWRON_IT_MSK	R/W	OTP	0b = Interrupt not masked OTP = nPWRON event interrupt masked
1	VMON_IT_MSK	R/W	OTP	0b = Interrupt not masked OTP = VMON event interrupt masked.
0	PWRHOLD_F_IT_MSK	R/W	OTP	0b = Interrupt not masked OTP = PWRHOLD falling edge event interrupt masked

### 8.5.1.3.27 INT\_STS2 Register (Offset = 3Bh) [reset = 00h]

INT\_STS2 is shown in [表 8-140](#) and described in [表 8-141](#).

Return to [Summary Table](#).

Register is reset on a POR event.

**表 8-140. INT\_STS2 Register**

7	6	5	4	3	2	1	0
GPIO5_F_IT	GPIO5_R_IT	GPIO4_F_IT	GPIO4_R_IT	GPIO3_F_IT	GPIO3_R_IT	GPIO2_F_IT	GPIO2_R_IT
R/W-0b	R/W-0b	R/W-0b	R/W-0b	R/W-0b	R/W-0b	R/W-0b	R/W-0b

**表 8-141. INT\_STS2 Register Field Descriptions**

Bit	Field	Type	Reset	Description
7	GPIO5_F_IT	R/W	0b	0b = No falling edge occurred 1b = GPIO5 falling edge detection interrupt status; write 1b to clear the interrupt flag
6	GPIO5_R_IT	R/W	0b	0b = No rising edge occurred 1b = GPIO5 rising edge detection interrupt status; write 1b to clear the interrupt flag
5	GPIO4_F_IT	R/W	0b	0b = No falling edge occurred 1b = GPIO4 falling edge detection interrupt status; write 1b to clear the interrupt flag
4	GPIO4_R_IT	R/W	0b	0b = No rising edge occurred 1b = GPIO4 rising edge detection interrupt status; write 1b to clear the interrupt flag
3	GPIO3_F_IT	R/W	0b	0b = No falling edge occurred 1b = GPIO3 falling edge detection interrupt status; write 1b to clear the interrupt flag
2	GPIO3_R_IT	R/W	0b	0b = No rising edge occurred 1b = GPIO3 rising edge detection interrupt status; write 1b to clear the interrupt flag
1	GPIO2_F_IT	R/W	0b	0b = No falling edge occurred 1b = GPIO2 falling edge detection interrupt status; write 1b to clear the interrupt flag
0	GPIO2_R_IT	R/W	0b	0b = No rising edge occurred 1b = GPIO2 rising edge detection interrupt status; write 1b to clear the interrupt flag

**8.5.1.3.28 INT\_MSK2 Register (Offset = 3Ch) [reset = OTP]**

INT\_MSK2 is shown in 表 8-142 and described in 表 8-143.

Return to [Summary Table](#).

Register is reset on a POR event.

**表 8-142. INT\_MSK2 Register**

7	6	5	4	3	2	1	0
GPIO5_F_IT_MSK	GPIO5_R_IT_MSK	GPIO4_F_IT_MSK	GPIO4_R_IT_MSK	GPIO3_F_IT_MSK	GPIO3_R_IT_MSK	GPIO2_F_IT_MSK	GPIO2_R_IT_MSK
R/W-OTP	R/W-OTP	R/W-OTP	R/W-OTP	R/W-OTP	R/W-OTP	R/W-OTP	R/W-OTP

**表 8-143. INT\_MSK2 Register Field Descriptions**

Bit	Field	Type	Reset	Description
7	GPIO5_F_IT_MSK	R/W	OTP	0b = Interrupt not masked 1b = GPIO5 falling edge detection interrupt masked
6	GPIO5_R_IT_MSK	R/W	OTP	0b = Interrupt not masked 1b = GPIO5 rising edge detection interrupt masked
5	GPIO4_F_IT_MSK	R/W	OTP	0b = Interrupt not masked 1b = GPIO4 falling edge detection interrupt masked
4	GPIO4_R_IT_MSK	R/W	OTP	0b = Interrupt not masked 1b = GPIO4 rising edge detection interrupt masked
3	GPIO3_F_IT_MSK	R/W	OTP	0b = Interrupt not masked 1b = GPIO3 falling edge detection interrupt masked
2	GPIO3_R_IT_MSK	R/W	OTP	0b = Interrupt not masked 1b = GPIO3 rising edge detection interrupt masked
1	GPIO2_F_IT_MSK	R/W	OTP	0b = Interrupt not masked 1b = GPIO2 falling edge detection interrupt masked
0	GPIO2_R_IT_MSK	R/W	OTP	0b = Interrupt not masked 1b = GPIO2 rising edge detection interrupt masked

### 8.5.1.3.29 INT\_STS3 Register (Offset = 3Dh) [reset = OTP]

INT\_STS3 is shown in [表 8-144](#) and described in [表 8-145](#).

Return to [Summary Table](#).

Register is reset on a POR event.

**表 8-144. INT\_STS3 Register**

7	6	5	4	3	2	1	0
PGOOD_LDO4_IT	PGOOD_LDO3_IT	PGOOD_LDO2_IT	PGOOD_LDO1_IT	PGOOD_DCDC4_IT	PGOOD_DCDC3_IT	PGOOD_DCDC2_IT	PGOOD_DCDC1_IT
R/W-0b	R/W-0b	R/W-0b	R/W-0b	R/W-0b	R/W-0b	R/W-0b	R/W-0b

**表 8-145. INT\_STS3 Register Field Descriptions**

Bit	Field	Type	Reset	Description
7	PGOOD_LDO4_IT	R/W	0b	0b = No status change occurred 1b = PGOOD_LDO4 falling edge detection interrupt status; masked by the ENABLE bit, therefore not triggered if the output voltage drops when the LDO is disabled; write 1b to clear the interrupt flag
6	PGOOD_LDO3_IT	R/W	0b	0b = No status change occurred 1b = PGOOD_LDO3 falling edge detection interrupt status; masked by the ENABLE bit, therefore not triggered if the output voltage drops when the LDO is disabled; write 1b to clear the interrupt flag
5	PGOOD_LDO2_IT	R/W	0b	0b = No status change occurred 1b = PGOOD_LDO2 falling edge detection interrupt status; masked by the ENABLE bit, therefore not triggered if the output voltage drops when the LDO is disabled; write 1b to clear the interrupt flag
4	PGOOD_LDO1_IT	R/W	0b	0b = No status change occurred 1b = PGOOD_LDO1 falling edge detection interrupt status; masked by the ENABLE bit, therefore not triggered if the output voltage drops when the LDO is disabled; write 1b to clear the interrupt flag
3	PGOOD_DCDC4_IT	R/W	0b	0b = No status change occurred 1b = PGOOD_DCDC4 falling edge detection interrupt status; masked by the ENABLE bit, therefore not triggered if the output voltage drops when the converter is disabled; write 1b to clear the interrupt flag
2	PGOOD_DCDC3_IT	R/W	0b	0b = No status change occurred 1b = PGOOD_DCDC3 falling edge detection interrupt status; masked by the ENABLE bit, therefore not triggered if the output voltage drops when the converter is disabled; write 1b to clear the interrupt flag
1	PGOOD_DCDC2_IT	R/W	0b	0b = No status change occurred 1b = PGOOD_DCDC2 falling edge detection interrupt status; masked by the ENABLE bit, therefore not triggered if the output voltage drops when the converter is disabled; write 1b to clear the interrupt flag
0	PGOOD_DCDC1_IT	R/W	0b	0b = No status change occurred 1b = PGOOD_DCDC1 falling edge detection interrupt status; masked by the ENABLE bit, therefore not triggered if the output voltage drops when the converter is disabled; write 1b to clear the interrupt flag

### 8.5.1.3.30 INT\_MSK3 Register (Offset = 3Eh) [reset = FFh]

INT\_MSK3 is shown in 表 8-146 and described in 表 8-147.

Return to [Summary Table](#).

Register is reset on a POR event.

**表 8-146. INT\_MSK3 Register**

7	6	5	4	3	2	1	0
PGOOD_LDO4	PGOOD_LDO3	PGOOD_LDO2	PGOOD_LDO1	PGOOD_DCDC 4	PGOOD_DCDC 3	PGOOD_DCDC 2	PGOOD_DCDC 1
IT_MSK	IT_MSK	IT_MSK	IT_MSK	IT_MSK	IT_MSK	IT_MSK	IT_MSK
R/W-1b	R/W-1b	R/W-1b	R/W-1b	R/W-1b	R/W-1b	R/W-1b	R/W-1b

**表 8-147. INT\_MSK3 Register Field Descriptions**

Bit	Field	Type	Reset	Description
7	PGOOD_LDO4_IT_MSK	R/W	1b	0b = Interrupt not masked 1b = PGOOD_LDO4 falling edge detection interrupt status; masked by the ENABLE bit, therefore not triggered if the output voltage drops when the LDO is disabled
6	PGOOD_LDO3_IT_MSK	R/W	1b	0b = Interrupt not masked 1b = PGOOD_LDO3 falling edge detection interrupt status; masked by the ENABLE bit, therefore not triggered if the output voltage drops when the LDO is disabled
5	PGOOD_LDO2_IT_MSK	R/W	1b	0b = Interrupt not masked 1b = PGOOD_LDO2 falling edge detection interrupt status; masked by the ENABLE bit, therefore not triggered if the output voltage drops when the LDO is disabled
4	PGOOD_LDO1_IT_MSK	R/W	1b	0b = Interrupt not masked 1b = PGOOD_LDO1 falling edge detection interrupt status; masked by the ENABLE bit, therefore not triggered if the output voltage drops when the LDO is disabled
3	PGOOD_DCDC4_IT_MSK	R/W	1b	0b = Interrupt not masked 1b = PGOOD_DCDC4 falling edge detection interrupt status; masked by the ENABLE bit, therefore not triggered if the output voltage drops when the LDO is disabled
2	PGOOD_DCDC3_IT_MSK	R/W	1b	0b = Interrupt not masked 1b = PGOOD_DCDC3 falling edge detection interrupt status; masked by the ENABLE bit, therefore not triggered if the output voltage drops when the LDO is disabled
1	PGOOD_DCDC2_IT_MSK	R/W	1b	0b = Interrupt not masked 1b = PGOOD_DCDC2 falling edge detection interrupt status; masked by the ENABLE bit, therefore not triggered if the output voltage drops when the LDO is disabled
0	PGOOD_DCDC1_IT_MSK	R/W	1b	0b = Interrupt not masked 1b = PGOOD_DCDC1 falling edge detection interrupt status; masked by the ENABLE bit, therefore not triggered if the output voltage drops when the LDO is disabled

### 8.5.1.3.31 INT\_STS4 Register (Offset = 3Fh) [reset = 00h]

INT\_STS4 is shown in [表 8-148](#) and described in [表 8-149](#).

Return to [Summary Table](#).

Register is reset on a POR event.

**表 8-148. INT\_STS4 Register**

7	6	5	4	3	2	1	0
RSVD		PGOOD_LDO10_IT	PGOOD_LDO9_IT	PGOOD_LDO8_IT	PGOOD_LDO7_IT	PGOOD_LDO6_IT	PGOOD_LDO5_IT
R/W-00b		R/W-0b	R/W-0b	R/W-0b	R/W-0b	R/W-0b	R/W-0b

**表 8-149. INT\_STS4 Register Field Descriptions**

Bit	Field	Type	Reset	Description
7-6	RSVD	R/W	00b	Unused bit read returns 0b.
5	PGOOD_LDO10_IT	R/W	0b	0b = No status change occurred 1b = PGOOD_LDO10 falling or rising edge detection interrupt status; write 1b to clear the interrupt flag
4	PGOOD_LDO9_IT	R/W	0b	0b = No status change occurred 1b = PGOOD_LDO9 falling or rising edge detection interrupt status; write 1b to clear the interrupt flag
3	PGOOD_LDO8_IT	R/W	0b	0b = No status change occurred 1b = PGOOD_LDO8 falling or rising edge detection interrupt status; write 1b to clear the interrupt flag
2	PGOOD_LDO7_IT	R/W	0b	0b = No status change occurred 1b = PGOOD_LDO7 falling or rising edge detection interrupt status; write 1b to clear the interrupt flag
1	PGOOD_LDO6_IT	R/W	0b	0b = No status change occurred 1b = PGOOD_LDO6 falling or rising edge detection interrupt status; write 1b to clear the interrupt flag
0	PGOOD_LDO5_IT	R/W	0b	0b = No status change occurred 1b = PGOOD_LDO5 falling or rising edge detection interrupt status; write 1b to clear the interrupt flag

### 8.5.1.3.32 INT\_MSK4 Register (Offset = 40h) [reset = FFh]

INT\_MSK4 is shown in [表 8-150](#) and described in [表 8-151](#).

Return to [Summary Table](#).

Register is reset on a POR event.

**表 8-150. INT\_MSK4 Register**

7	6	5	4	3	2	1	0
RSVD		PGOOD_LDO10_MSK	PGOOD_LDO9_MSK	PGOOD_LDO8_MSK	PGOOD_LDO7_MSK	PGOOD_LDO6_MSK	PGOOD_LDO5_MSK
R/W-11b		R/W-1b	R/W-1b	R/W-1b	R/W-1b	R/W-1b	R/W-1b

**表 8-151. INT\_MSK4 Register Field Descriptions**

Bit	Field	Type	Reset	Description
7-6	RSVD	R/W	11b	Unused bit read returns 0b.



**表 8-151. INT\_MSK4 Register Field Descriptions (continued)**

Bit	Field	Type	Reset	Description
5	PGOOD_LDO10_IT_MSK	R/W	1b	0b = Interrupt not masked 1b = PGOOD_LDO10 falling or rising edge detection interrupt masked
4	PGOOD_LDO9_IT_MSK	R/W	1b	0b = Interrupt not masked 1b = PGOOD_LDO9 falling or rising edge detection interrupt masked
3	PGOOD_LDO8_IT_MSK	R/W	1b	0b = Interrupt not masked 1b = PGOOD_LDO8 falling or rising edge detection interrupt masked
2	PGOOD_LDO7_IT_MSK	R/W	1b	0b = Interrupt not masked 1b = PGOOD_LDO7 falling or rising edge detection interrupt masked
1	PGOOD_LDO6_IT_MSK	R/W	1b	0b = Interrupt not masked 1b = PGOOD_LDO6 falling or rising edge detection interrupt masked
0	PGOOD_LDO5_IT_MSK	R/W	1b	0b = Interrupt not masked 1b = PGOOD_LDO5 falling or rising edge detection interrupt masked

### 8.5.1.3.33 GPIO1 Register (Offset = 41h) [reset = OTP]

GPIO1 is shown in [表 8-152](#) and described in [表 8-153](#).

Return to [Summary Table](#).

Register is reset on a POR event.

**表 8-152. GPIO1 Register**

7	6	5	4	3	2	1	0
GPIO_SLEEP	RSVD		GPIO_DEB	RSVD	GPIO_CFG	GPIO_STS	GPIO_SET
R/W-OTP	R-00b		R/W-OTP	R-0b	R/W-OTP	R-x	R/W-OTP

**表 8-153. GPIO1 Register Field Descriptions**

Bit	Field	Type	Reset	Description
7	GPIO_SLEEP	R/W	OTP	0b = No impact, keep as in ACTIVE state 1b = When in the SLEEP state and GPIO in output mode, force output low
6-5	RSVD	R	00b	Unused bit read returns 0b.
4	GPIO_DEB	R/W	OTP	GPIO input debouncing time 0b = 94 $\mu$ s 1b = 156 $\mu$ s
3	RSVD	R	0b	Unused bit
2	GPIO_CFG	R/W	OTP	Configuration of the GPIO pad direction 0b = The GPIO pad is configured as an input 1b = The GPIO pad is configured as an output, GPIO assigned to power-up sequence
1	GPIO_STS	R	x	This bit has no reset value, it is generated based on GPIO pad voltage in real-time 0b = Voltage on GPIO pad is greater than $V_{IH}$ if configured as an input, $V_{OH}$ if configured as an output 1b = Voltage on GPIO pad is greater than $V_{IH}$ if configured as an input, $V_{OH}$ if configured as an output
0	GPIO_SET	R/W	OTP	0b = Value set to logic 0b on the GPIO output when configured in output mode 1b = Value set to logic 1b on the GPIO output when configured in output mode

### 8.5.1.3.34 GPIO2 Register (Offset = 42h) [reset = OTP]

GPIO2 is shown in [表 8-154](#) and described in [表 8-155](#).

Return to [Summary Table](#).

Register is reset on a POR event.

**表 8-154. GPIO2 Register**

7	6	5	4	3	2	1	0
GPIO_SLEEP	RSVD		GPIO_DEB	RSVD	GPIO_CFG	GPIO_STS	GPIO_SET
R/W-OTP	R-00b		R/W-OTP	R-0b	R/W-OTP	R-x	R/W-OTP

**表 8-155. GPIO2 Register Field Descriptions**

Bit	Field	Type	Reset	Description
7	GPIO_SLEEP	R/W	OTP	0b = No impact, keep as in ACTIVE state 1b = When in the SLEEP state and GPIO in output mode, force output low
6-5	RSVD	R	00b	Unused bit read returns 0b.
4	GPIO_DEB	R/W		GPIO input debouncing time 0b = 94 $\mu$ s 1b = 156 $\mu$ s
3	RSVD	R	0b	Unused bit
2	GPIO_CFG	R/W	OTP	Configuration of the GPIO pad direction 0b = The GPIO pad is configured as an input 1b = The GPIO pad is configured as an output, GPIO assigned to power-up sequence
1	GPIO_STS	R	x	This bit has no reset value, it is generated based on GPIO pad voltage in real-time 0b = Voltage on GPIO pad is greater than $V_{IH}$ if configured as an input, $V_{OH}$ if configured as an output 1b = Voltage on GPIO pad is greater than $V_{IH}$ if configured as an input, $V_{OH}$ if configured as an output
0	GPIO_SET	R/W	OTP	0b = Value set to logic 0b on the GPIO output when configured in output mode 1b = Value set to logic 1b on the GPIO output when configured in output mode

### 8.5.1.3.35 GPIO3 Register (Offset = 43h) [reset = OTP]

GPIO3 is shown in [表 8-156](#) and described in [表 8-157](#).

Return to [Summary Table](#).

Register is reset on a POR event.

**表 8-156. GPIO3 Register**

7	6	5	4	3	2	1	0
GPIO_SLEEP	GPIO_SEL	GPIO_ODEN	GPIO_DEB	GPIO_PDEN	GPIO_CFG	GPIO_STS	GPIO_SET
R/W-OTP	R/W-OTP	R/W-OTP	R/W-OTP	R/W-OTP	R/W-OTP	R-x	R/W-OTP

**表 8-157. GPIO3 Register Field Descriptions**

Bit	Field	Type	Reset	Description
7	GPIO_SLEEP	R/W	OTP	0b = No impact, keep as in ACTIVE state 1b = When in the SLEEP state and GPIO in output mode, force output low
6	GPIO_SEL	R/W	OTP	0b = GPIO_SET to be available at the GPIO pin when configured as output 1b = LEDA out to be available at the GPIO pin when configured as output
5	GPIO_ODEN	R/W	OTP	0b = Push-pull output mode, GPIO assigned to power-up sequence 1b = Open drain output mode
4	GPIO_DEB	R/W	OTP	GPIO input debouncing time 0b = 94 $\mu$ s 1b = 156 $\mu$ s
3	GPIO_PDEN	R/W	OTP	GPIO pad pulldown control 0b = Pulldown is disabled 1b = Pulldown is enabled
2	GPIO_CFG	R/W	OTP	Configuration of the GPIO pad direction 0b = The GPIO pad is configured as an input 1b = The GPIO pad is configured as an output, GPIO assigned to power-up sequence
1	GPIO_STS	R	x	This bit has no reset value, it is generated based on GPIO pad voltage in real-time 0b = Voltage on GPIO pad is greater than $V_{IH}$ if configured as an input, $V_{OH}$ if configured as an output 1b = Voltage on GPIO pad is greater than $V_{IH}$ if configured as an input, $V_{OH}$ if configured as an output
0	GPIO_SET	R/W	OTP	0b = Value set to logic 0b on the GPIO output when configured in output mode 1b = Value set to logic 1b on the GPIO output when configured in output mode

### 8.5.1.3.36 GPIO4 Register (Offset = 44h) [reset = OTP]

GPIO4 is shown in [表 8-158](#) and described in [表 8-159](#).

Return to [Summary Table](#).

Register is reset on a POR event.

**表 8-158. GPIO4 Register**

7	6	5	4	3	2	1	0
GPIO_SLEEP	GPIO_SEL	GPIO_ODEN	GPIO_DEB	GPIO_PDEN	GPIO_CFG	GPIO_STS	GPIO_SET
R/W-OTP	R/W-OTP	R/W-OTP	R/W-OTP	R/W-OTP	R/W-OTP	R-x	R/W-OTP

**表 8-159. GPIO4 Register Field Descriptions**

Bit	Field	Type	Reset	Description
7	GPIO_SLEEP	R/W	OTP	0b = No impact, keep as in ACTIVE state 1b = When in the SLEEP state and GPIO in output mode, force output low
6	GPIO_SEL	R/W	OTP	0b = GPIO_SET to be available at the GPIO pin when configured as output 1b = LEDB out to be available at the GPIO pin when configured as output
5	GPIO_ODEN	R/W	OTP	0b = Push-pull output mode, GPIO assigned to power-up sequence 1b = Open drain output mode
4	GPIO_DEB	R/W	OTP	GPIO input debouncing time 0b = 94 $\mu$ s 1b = 156 $\mu$ s
3	GPIO_PDEN	R/W	OTP	GPIO pad pulldown control 0b = Pulldown is disabled 1b = Pulldown is enabled
2	GPIO_CFG	R/W	OTP	Configuration of the GPIO pad direction 0b = The pad is configured as an input 1b = The GPIO pad is configured as an output, GPIO assigned to power-up sequence
1	GPIO_STS	R	x	This bit has no reset value, it is generated based on GPIO pad voltage in real-time 0b = Voltage on GPIO pad is greater than $V_{IH}$ if configured as an input, $V_{OH}$ if configured as an output 1b = Voltage on GPIO pad is greater than $V_{IH}$ if configured as an input, $V_{OH}$ if configured as an output
0	GPIO_SET	R/W	OTP	0b = Value set to logic 0b on the GPIO output when configured in output mode 1b = Value set to logic 1b on the GPIO output when configured in output mode

### 8.5.1.3.37 GPIO5 Register (Offset = 45h) [reset = OTP]

GPIO5 is shown in [表 8-160](#) and described in [表 8-161](#).

Return to [Summary Table](#).

Register is reset on a POR event.

**表 8-160. GPIO5 Register**

7	6	5	4	3	2	1	0
GPIO_SLEEP	GPIO_SEL	GPIO_ODEN	GPIO_DEB	GPIO_PDEN	GPIO_CFG	GPIO_STS	GPIO_SET
R/W-OTP	R/W-OTP	R/W-OTP	R/W-OTP	R/W-OTP	R/W-OTP	R-x	R/W-OTP

**表 8-161. GPIO5 Register Field Descriptions**

Bit	Field	Type	Reset	Description
7	GPIO_SLEEP	R/W	OTP	0b = No impact, keep as in ACTIVE state 1b = When in the SLEEP state and GPIO in output mode, force output low
6	GPIO_SEL	R/W	OTP	0b = GPIO_SET to be available at the GPIO pin when configured as output 1b = LEDC out to be available at the GPIO pin when configured as output
5	GPIO_ODEN	R/W	OTP	0b = Push-pull output mode, GPIO assigned to power-up sequence 1b = Open drain output mode
4	GPIO_DEB	R/W	OTP	GPIO input debouncing time 0b = 94 $\mu$ s 1b = 156 $\mu$ s
3	GPIO_PDEN	R/W	OTP	GPIO pad pulldown control 0b = Pulldown is disabled 1b = Pulldown is enabled
2	GPIO_CFG	R/W	OTP	Configuration of the GPIO pad direction 0b = The pad is configured as an input 1b = The GPIO pad is configured as an output, GPIO assigned to power-up sequence
1	GPIO_STS	R	x	This bit has no reset value, it is generated based on GPIO pad voltage in real-time 0b = Voltage on GPIO pad is greater than $V_{IH}$ if configured as an input, $V_{OH}$ if configured as an output 1b = Voltage on GPIO pad is greater than $V_{IH}$ if configured as an input, $V_{OH}$ if configured as an output
0	GPIO_SET	R/W	OTP	0b = Value set to logic 0b on the GPIO output when configured in output mode 1b = Value set to logic 1b on the GPIO output when configured in output mode

### 8.5.1.3.38 VMON Register (Offset = 46h) [reset = OTP]

VMON is shown in [表 8-162](#) and described in [表 8-163](#).

Return to [Summary Table](#).

Register is reset on a POR event.

**表 8-162. VMON Register**

7	6	5	4	3	2	1	0
RSVD	VMON_DELAY[1:0]	VSUP_MASK	RSVD	VSUP_OUT	VMON_SEL[1:0]		
R-0b	R/W-OTP	R/W-OTP	R-0b	R-x	R/W-OTP		

**表 8-163. VMON Register Field Descriptions**

Bit	Field	Type	Reset	Description
7	RSVD	R	0b	Unused bit read returns 0b.
6	VMON_DELAY[1:0]	R/W	OTP	Delays the output signal at the VSUP_OUT pin for a falling input voltage on the VMON_IN pin to allow an interrupt to be generated before the VSUP_OUT pin goes low 00b = No falling edge delay 01b = 50- $\mu$ s falling edge delay 10b = 100- $\mu$ s falling edge delay 11b = 250- $\mu$ s falling edge delay
5	VSUP_MASK	R/W	OTP	0b = The output of the voltage monitor is not used as a switch-off event 1b = The output of the voltage monitor is used as a switch-off event
4	RSVD	R	0b	Unused bit
3	VSUP_OUT	R	x	This bit has no reset value, it is generated based on the status output of the voltage monitor: 0b = The voltage at the VCCS/VIN_MON pin is below the VMON threshold 1b = The voltage at the VCCS/VIN_MON pin is above the VMON threshold
2	VMON_SEL[1:0]	R/W	OTP	Battery voltage comparator threshold: 00b = VMON threshold is 3.1 V (rising voltage) 01b = VMON threshold is 2.9 V (rising voltage) 10b = VMON threshold is 2.8 V (rising voltage) 11b = VMON threshold is 2.7 V (rising voltage)

### 8.5.1.3.39 LEDA\_CTRL1 Register (Offset = 47h) [reset = 00h]

LEDA\_CTRL1 is shown in [表 8-164](#) and described in [表 8-165](#).

Return to [Summary Table](#).

Register is reset on a POR event.

**表 8-164. LEDA\_CTRL1 Register**

7	6	5	4	3	2	1	0
RSVD		LEDA_RAMP_ENABLE	RSVD	LEDA_CURRENT[3:0]			
R-00b		R/W-0b	R-0b	R/W-0000b			

**表 8-165. LEDA\_CTRL1 Register Field Descriptions**

Bit	Field	Type	Reset	Description
7-6	RSVD	R	00b	Unused bit read returns 0b.
5	LEDA_RAMP_ENABLE	R/W	0b	0b = No ramp 1b = Ramp enabled
4	RSVD	R	0b	Unused bit
3-0	LEDA_CURRENT[3:0]	R/W	0000b	LEDA DC current. See <a href="#">表 8-218</a>

### 8.5.1.3.40 LEDA\_CTRL2 Register (Offset = 48h) [reset = 00h]

LEDA\_CTRL2 is shown in [表 8-166](#) and described in [表 8-167](#).

Return to [Summary Table](#).

Register is reset on a POR event.

**表 8-166. LEDA\_CTRL2 Register**

7	6	5	4	3	2	1	0
RSVD	LEDA_T1[6:0]						
R-0b	R/W-0000000b						

**表 8-167. LEDA\_CTRL2 Register Field Descriptions**

Bit	Field	Type	Reset	Description
7	RSVD	R	0b	Unused bit read returns 0b.
6-0	LEDA_T1[6:0]	R/W	0000000b	LEDA T1 sequence length = LEDA_T1[6:0] × 64 ms 0000000b = 0 × 64 ms 1111111b = 127 × 64 ms



#### 8.5.1.3.41 LEDA\_CTRL3 Register (Offset = 49h) [reset = 00h]

LEDA\_CTRL3 is shown in [表 8-168](#) and described in [表 8-169](#).

Return to [Summary Table](#).

Register is reset on a POR event.

**表 8-168. LEDA\_CTRL3 Register**

7	6	5	4	3	2	1	0
RSVD							LEDA_T2[6:0]
R-0b							R/W-0000000b

**表 8-169. LEDA\_CTRL3 Register Field Descriptions**

Bit	Field	Type	Reset	Description
7	RSVD	R	0b	Unused bit read returns 0b.
6-0	LEDA_T2[6:0]	R/W	0000000b	LEDA T2 sequence length = LEDA_T2[6:0] × 64 ms 0000000b = 0 × 64 ms 1111111b = 127 × 64 ms

#### 8.5.1.3.42 LEDA\_CTRL4 Register (Offset = 4Ah) [reset = 00h]

LEDA\_CTRL4 is shown in [表 8-170](#) and described in [表 8-171](#).

Return to [Summary Table](#).

Register is reset on a POR event.

**表 8-170. LEDA\_CTRL4 Register**

7	6	5	4	3	2	1	0
RSVD							LEDA_T3[6:0]
R-0b							R/W-0000000b

**表 8-171. LEDA\_CTRL4 Register Field Descriptions**

Bit	Field	Type	Reset	Description
7	RSVD	R	0b	Unused bit read returns 0b.
6-0	LEDA_T3[6:0]	R/W	0000000b	LEDA T3 sequence length = LEDA_T3[6:0] × 64 ms 0000000b = 0 × 64 ms 1111111b = 127 × 64 ms

**8.5.1.3.43 LEDA\_CTRL5 Register (Offset = 4Bh) [reset = 00h]**

 LEDA\_CTRL5 is shown in [表 8-172](#) and described in [表 8-173](#).

 Return to [Summary Table](#).

Register is reset on a POR event.

**表 8-172. LEDA\_CTRL5 Register**

7	6	5	4	3	2	1	0
RSVD							LEDA_T4[6:0]
R-0b							R/W-0000000b

**表 8-173. LEDA\_CTRL5 Register Field Descriptions**

Bit	Field	Type	Reset	Description
7	RSVD	R	0b	Unused bit read returns 0b.
6-0	LEDA_T4[6:0]	R/W	0000000b	LEDA T4 sequence length = LEDA_T4[6:0] × 64 ms 0000000b = 0 × 64 ms 1111111b = 127 × 64 ms

**8.5.1.3.44 LEDA\_CTRL6 Register (Offset = 4Ch) [reset = 00h]**

 LEDA\_CTRL6 is shown in [表 8-174](#) and described in [表 8-175](#).

 Return to [Summary Table](#).

Register is reset on a POR event.

**表 8-174. LEDA\_CTRL6 Register**

7	6	5	4	3	2	1	0
RSVD							LEDA_TP[6:0]
R-0b							R/W-0000000b

**表 8-175. LEDA\_CTRL6 Register Field Descriptions**

Bit	Field	Type	Reset	Description
7	RSVD	R	0b	Unused bit read returns 0b.
6-0	LEDA_TP[6:0]	R/W	0000000b	LEDA TP sequence length = LEDA_TP[6:0] × 64 ms 0000000b = 0 × 64 ms 1111111b = 127 × 64 ms

#### 8.5.1.3.45 LEDA\_CTRL7 Register (Offset = 4Dh) [reset = 00h]

LEDA\_CTRL7 is shown in [表 8-176](#) and described in [表 8-177](#).

Return to [Summary Table](#).

Register is reset on a POR event.

**表 8-176. LEDA\_CTRL7 Register**

7	6	5	4	3	2	1	0
RSVD			LEDA_PWM[4:0]				
R-000b			R/W-00000b				

**表 8-177. LEDA\_CTRL7 Register Field Descriptions**

Bit	Field	Type	Reset	Description
7-5	RSVD	R	000b	Unused bit read returns 0b.
4-0	LEDA_PWM[4:0]	R/W	00000b	LEDA_ON duty-cycle: $([LEDA\_PWM] + 1) \times 1 / 32 \times 8\text{-ms period}$ 00000b = $1 / 2 \times 8\text{ ms}$ (LEDA_ON is high for 250 $\mu\text{s}$ , low for 7.75 ms) 11111b = $32 / 32 \times 8\text{ ms}$ (LEDA_ON is always high)

#### 8.5.1.3.46 LEDA\_CTRL8 Register (Offset = 4Eh) [reset = 00h]

LEDA\_CTRL8 is shown in [表 8-178](#) and described in [表 8-179](#).

Return to [Summary Table](#).

Register is reset on a POR event.

**表 8-178. LEDA\_CTRL8 Register**

7	6	5	4	3	2	1	0
RSVD			LEDA_ON_TIME[4:0]				
R-000b			R/W-00000b				

**表 8-179. LEDA\_CTRL8 Register Field Descriptions**

Bit	Field	Type	Reset	Description
7-5	RSVD	R	000b	Unused bit read returns 0b.
4-0	LEDA_ON_TIME[4:0]	R/W	00000b	LEDA ON-TIME: LEDA_ON_TME[4:0] $\times$ 64 ms 00000b = $0 \times 64\text{ ms}$ 11111b = $31 \times 64\text{ ms}$

### 8.5.1.3.47 LEDB\_CTRL1 Register (Offset = 4Fh) [reset = 00h]

LEDB\_CTRL1 is shown in [表 8-180](#) and described in [表 8-181](#).

Return to [Summary Table](#).

Register is reset on a POR event.

**表 8-180. LEDB\_CTRL1 Register**

7	6	5	4	3	2	1	0
RSVD		LEDB_RAMP_ENABLE	RSVD	LEDB_CURRENT[3:0]			
R-00b		R/W-0b	R-0b	R/W-0000b			

**表 8-181. LEDB\_CTRL1 Register Field Descriptions**

Bit	Field	Type	Reset	Description
7-6	RSVD	R	00b	Unused bit read returns 0b.
5	LEDB_RAMP_ENABLE	R/W	0b	0b = No ramp 1b = Ramp enabled
4	RSVD	R	0b	Unused bit
3-0	LEDBA_CURRENT[3:0]	R/W	0000b	LEDB DC current. See <a href="#">表 8-218</a>

### 8.5.1.3.48 LEDB\_CTRL2 Register (Offset = 50h) [reset = 00h]

LEDB\_CTRL2 is shown in [表 8-182](#) and described in [表 8-183](#).

Return to [Summary Table](#).

Register is reset on a POR event.

**表 8-182. LEDB\_CTRL2 Register**

7	6	5	4	3	2	1	0
RSVD	LEDB_T1[6:0]						
R-0b	R/W-0000000b						

**表 8-183. LEDB\_CTRL2 Register Field Descriptions**

Bit	Field	Type	Reset	Description
7	RSVD	R	0b	Unused bit read returns 0b.
6-0	LEDB_T1[6:0]	R/W	0000000b	LEDB T1 sequence length = LEDB_T1[6:0] × 64 ms 0000000b = 0 × 64 ms 1111111b = 127 × 64 ms

#### 8.5.1.3.49 LEDB\_CTRL3 Register (Offset = 51h) [reset = 00h]

LEDB\_CTRL3 is shown in [表 8-184](#) and described in [表 8-185](#).

Return to [Summary Table](#).

Register is reset on a POR event.

**表 8-184. LEDB\_CTRL3 Register**

7	6	5	4	3	2	1	0
RSVD	LEDB_T2[6:0]						
R-0b							R/W-0000000b

**表 8-185. LEDB\_CTRL3 Register Field Descriptions**

Bit	Field	Type	Reset	Description
7	RSVD	R	000b	Unused bit read returns 0b.
6-0	LEDB_T2[6:0]	R/W	0000000b	LEDB T2 sequence length = LEDB_T2[6:0] × 64 ms 0000000b = 0 × 64 ms 1111111b = 127 × 64 ms

#### 8.5.1.3.50 LEDB\_CTRL4 Register (Offset = 52h) [reset = 00h]

LEDB\_CTRL4 is shown in [表 8-186](#) and described in [表 8-187](#).

Return to [Summary Table](#).

Register is reset on a POR event.

**表 8-186. LEDB\_CTRL4 Register**

7	6	5	4	3	2	1	0
RSVD	LEDB_T3[6:0]						
R-0b							R/W-0000000b

**表 8-187. LEDB\_CTRL4 Register Field Descriptions**

Bit	Field	Type	Reset	Description
7	RSVD	R	0b	Unused bit read returns 0b.
6-0	LEDB_T3[6:0]	R/W	0000000b	LEDB T3 sequence length = LEDB_T3[6:0] × 64 ms 0000000b = 0 × 64 ms 1111111b = 127 × 64 ms

**8.5.1.3.51 LEDB\_CTRL5 Register (Offset = 53h) [reset = 00h]**

 LEDB\_CTRL5 is shown in [表 8-188](#) and described in [表 8-189](#).

 Return to [Summary Table](#).

Register is reset on a POR event.

**表 8-188. LEDB\_CTRL5 Register**

7	6	5	4	3	2	1	0
RSVD	LEDB_T4[6:0]						
R-0b							
R/W-0000000b							

**表 8-189. LEDB\_CTRL5 Register Field Descriptions**

Bit	Field	Type	Reset	Description
7	RSVD	R	000b	Unused bit read returns 0b.
6-0	LEDB_T4[6:0]	R/W	0000000b	LEDB T4 sequence length = LEDB_T4[6:0] × 64 ms 0000000b = 0 × 64 ms 1111111b = 127 × 64 ms

**8.5.1.3.52 LEDB\_CTRL6 Register (Offset = 54h) [reset = 00h]**

 LEDB\_CTRL6 is shown in [表 8-190](#) and described in [表 8-191](#).

 Return to [Summary Table](#).

Register is reset on a POR event.

**表 8-190. LEDB\_CTRL6 Register**

7	6	5	4	3	2	1	0
RSVD	LEDB_TP[6:0]						
R-0b							
R/W-0000000b							

**表 8-191. LEDB\_CTRL6 Register Field Descriptions**

Bit	Field	Type	Reset	Description
7	RSVD	R	0b	Unused bit read returns 0b.
6-0	LEDB_TP[6:0]	R/W	0000000b	LEDB TP sequence length = LEDB_TP[6:0] × 64 ms 0000000b = 0 × 64 ms 1111111b = 127 × 64 ms

### 8.5.1.3.53 LEDB\_CTRL7 Register (Offset = 55h) [reset = 00h]

LEDB\_CTRL7 is shown in [表 8-192](#) and described in [表 8-193](#).

Return to [Summary Table](#).

Register is reset on a POR event.

**表 8-192. LEDB\_CTRL7 Register**

7	6	5	4	3	2	1	0
RSVD			LEDB_PWM[4:0]				
R-000b			R/W-00000b				

**表 8-193. LEDB\_CTRL7 Register Field Descriptions**

Bit	Field	Type	Reset	Description
7-5	RSVD	R	000b	Unused bit read returns 0b.
4-0	LEDB_PWM[4:0]	R/W	00000b	LEDB_ON duty-cycle: $([LEDB\_PWM] + 1) \times 1 / 32 \times 8\text{-ms period}$ 00000b = $1 / 32 \times 8\text{ ms}$ (LEDB_ON is high for 250 $\mu\text{s}$ , low for 7.75 ms) 11111b = $32 / 32 \times 8\text{ ms}$ (LEDB_ON is always high)

### 8.5.1.3.54 LEDB\_CTRL8 Register (Offset = 56h) [reset = 00h]

LEDB\_CTRL8 is shown in [表 8-194](#) and described in [表 8-195](#).

Return to [Summary Table](#).

Register is reset on a POR event.

**表 8-194. LEDB\_CTRL8 Register**

7	6	5	4	3	2	1	0
RSVD			LEDB_ON_TIME[4:0]				
R-000b			R/W-00000b				

**表 8-195. LEDB\_CTRL8 Register Field Descriptions**

Bit	Field	Type	Reset	Description
7-5	RSVD	R	000b	Unused bit read returns 0b.
4-0	LEDB_ON_TIME[4:0]	R/W	00000b	LEDB ON-TIME: $LEDB\_ON\_TME[4:0] \times 64\text{ ms}$ 00000b = $0 \times 64\text{ ms}$ 11111b = $31 \times 64\text{ ms}$

### 8.5.1.3.55 LEDC\_CTRL1 Register (Offset = 57h) [reset = 00h]

LEDC\_CTRL1 is shown in [表 8-196](#) and described in [表 8-197](#).

Return to [Summary Table](#).

Register is reset on a POR event.

**表 8-196. LEDC\_CTRL1 Register**

7	6	5	4	3	2	1	0
RSVD		LEDC_RAMP_ENABLE	RSVD	LEDC_CURRENT[3:0]			
R-00b		R/W-0b	R-0b	R/W-0000b			

**表 8-197. LEDC\_CTRL1 Register Field Descriptions**

Bit	Field	Type	Reset	Description
7-6	RSVD	R	00b	Unused bit read returns 0b.
5	LEDC_RAMP_ENABLE	R/W	0b	0b = No ramp 1b = Ramp enabled
4	RSVD	R	0b	Unused bit
3-0	LEDC_CURRENT[3:0]	R/W	0000b	LEDC DC current. See <a href="#">表 8-218</a>

### 8.5.1.3.56 LEDC\_CTRL2 Register (Offset = 58h) [reset = 00h]

LEDC\_CTRL2 is shown in [表 8-198](#) and described in [表 8-199](#).

Return to [Summary Table](#).

Register is reset on a POR event.

**表 8-198. LEDC\_CTRL2 Register**

7	6	5	4	3	2	1	0
RSVD	LEDC_T1[6:0]						
R-0b	R/W-0000000b						

**表 8-199. LEDC\_CTRL2 Register Field Descriptions**

Bit	Field	Type	Reset	Description
7	RSVD	R	0b	Unused bit read returns 0b.
6-0	LEDC_T1[6:0]	R/W	0000000b	LEDC T1 sequence length = LEDC_T1[6:0] × 64 ms 0000000b = 0 × 64 ms 1111111b = 127 × 64 ms



### 8.5.1.3.57 LEDC\_CTRL3 Register (Offset = 59h) [reset = 00h]

LEDC\_CTRL3 is shown in [表 8-200](#) and described in [表 8-201](#).

Return to [Summary Table](#).

Register is reset on a POR event.

**表 8-200. LEDC\_CTRL3 Register**

7	6	5	4	3	2	1	0
RSVD	LEDC_T2[6:0]						
R-0b							R/W-0000000b

**表 8-201. LEDC\_CTRL3 Register Field Descriptions**

Bit	Field	Type	Reset	Description
7	RSVD	R	0b	Unused bit read returns 0b.
6-0	LEDC_T2[6:0]	R/W	0000000b	LEDC T2 sequence length = LEDC_T2[6:0] × 64 ms 0000000b = 0 × 64 ms 1111111b = 127 × 64 ms

### 8.5.1.3.58 LEDC\_CTRL4 Register (Offset = 5Ah) [reset = 00h]

LEDC\_CTRL4 is shown in [表 8-202](#) and described in [表 8-203](#).

Return to [Summary Table](#).

Register is reset on a POR event.

**表 8-202. LEDC\_CTRL4 Register**

7	6	5	4	3	2	1	0
RSVD	LEDC_T3[6:0]						
R-0b							R/W-0000000b

**表 8-203. LEDC\_CTRL4 Register Field Descriptions**

Bit	Field	Type	Reset	Description
7	RSVD	R	0b	Unused bit read returns 0b.
6-0	LEDC_T3[6:0]	R/W	0000000b	LEDC T3 sequence length = LEDC_T3[6:0] × 64 ms 0000000b = 0 × 64 ms 1111111b = 127 × 64 ms

**8.5.1.3.59 LEDC\_CTRL5 Register (Offset = 5Bh) [reset = 00h]**

 LEDC\_CTRL5 is shown in [表 8-204](#) and described in [表 8-205](#).

 Return to [Summary Table](#).

Register is reset on a POR event.

**表 8-204. LEDC\_CTRL5 Register**

7	6	5	4	3	2	1	0
RSVD	LEDC_T4[6:0]						
R-0b							R/W-0000000b

**表 8-205. LEDC\_CTRL5 Register Field Descriptions**

Bit	Field	Type	Reset	Description
7	RSVD	R	0b	Unused bit read returns 0b.
6-0	LEDC_T4[6:0]	R/W	0000000b	LEDC T4 sequence length = LEDC_T4[6:0] × 64 ms 0000000b = 0 × 64 ms 1111111b = 127 × 64 ms

**8.5.1.3.60 LEDC\_CTRL6 Register (Offset = 5Ch) [reset = 00h]**

 LEDC\_CTRL6 is shown in [表 8-206](#) and described in [表 8-207](#).

 Return to [Summary Table](#).

Register is reset on a POR event.

**表 8-206. LEDC\_CTRL6 Register**

7	6	5	4	3	2	1	0
RSVD	LEDC_TP[6:0]						
R-0b							R/W-0000000b

**表 8-207. LEDC\_CTRL6 Register Field Descriptions**

Bit	Field	Type	Reset	Description
7	RSVD	R	0b	Unused bit read returns 0b.
6-0	LEDC_TP[6:0]	R/W	0000000b	LEDC TP sequence length = LEDC_TP[6:0] × 64 ms 0000000b = 0 × 64 ms 1111111b = 127 × 64 ms

### 8.5.1.3.61 LEDC\_CTRL7 Register (Offset = 5Dh) [reset = 00h]

LEDC\_CTRL7 is shown in [表 8-208](#) and described in [表 8-209](#).

Return to [Summary Table](#).

Register is reset on a POR event.

**表 8-208. LEDC\_CTRL7 Register**

7	6	5	4	3	2	1	0
RSVD			LEDC_PWM[4:0]				
R-000b			R/W-00000b				

**表 8-209. LEDC\_CTRL7 Register Field Descriptions**

Bit	Field	Type	Reset	Description
7-5	RSVD	R	000b	Unused bit read returns 0b.
4-0	LEDC_PWM[4:0]	R/W	00000b	LEDC_ON duty-cycle: $([LEDC\_PWM] + 1) \times 1 / 32 \times 8\text{-ms period}$ 00000b = $1 / 32 \times 8\text{ ms}$ (LEDC_ON is high for 250 $\mu\text{s}$ , low for 7.75 ms) 11111b = $32 / 32 \times 8\text{ ms}$ (LEDC_ON is always high)

### 8.5.1.3.62 LEDC\_CTRL8 Register (Offset = 5Eh) [reset = 00h]

LEDC\_CTRL8 is shown in [表 8-210](#) and described in [表 8-211](#).

Return to [Summary Table](#).

Register is reset on a POR event.

**表 8-210. LEDC\_CTRL8 Register**

7	6	5	4	3	2	1	0
RSVD			LEDC_ON_TIME[4:0]				
R-000b			R/W-00000b				

**表 8-211. LEDC\_CTRL8 Register Field Descriptions**

Bit	Field	Type	Reset	Description
7-5	RSVD	R	000b	Unused bit read returns 0b.
4-0	LEDC_ON_TIME[4:0]	R/W	00000b	LEDC ON-TIME: $LEDC\_ON\_TME[4:0] \times 64\text{ ms}$ 00000b = $0 \times 64\text{ ms}$ 11111b = $31 \times 64\text{ ms}$

### 8.5.1.3.63 LED\_RAMP\_UP\_TIME Register (Offset = 5Fh) [reset = 00h]

LED\_RAMP\_UP\_TIME is shown in [表 8-212](#) and described in [表 8-213](#).

Return to [Summary Table](#).

Register is reset on a POR event.

**表 8-212. LED\_RAMP\_UP\_TIME Register**

7	6	5	4	3	2	1	0
RSVD			LED_RAMP_UP[4:0]				
R-000b			R/W-00000b				

**表 8-213. LED\_RAMP\_UP\_TIME Register Field Descriptions**

Bit	Field	Type	Reset	Description
7-5	RSVD	R	000b	Unused bit read returns 0b.
4-0	LED_RAMP_UP[4:0]	R/W	00000b	LED ramp up time for LEDA, LEDB and LEDC: LED_RAMP_UP[4:0] × 8 ms 00000b = 0 × 8 ms 11111b = 31 × 8 ms

### 8.5.1.3.64 LED\_RAMP\_DOWN\_TIME Register (Offset = 60h) [reset = 00h]

LED\_RAMP\_DOWN\_TIME is shown in [表 8-214](#) and described in [表 8-215](#).

Return to [Summary Table](#).

Register is reset on a POR event.

**表 8-214. LED\_RAMP\_DOWN\_TIME Register**

7	6	5	4	3	2	1	0
RSVD			LED_RAMP_DOWN[4:0]				
R-000b			R/W-00000b				

**表 8-215. LED\_RAMP\_DOWN\_TIME Register Field Descriptions**

Bit	Field	Type	Reset	Description
7-5	RSVD	R	000b	Unused bit read returns 0b.
4-0	LED_RAMP_DOWN[4:0]	R/W	00000b	LED ramp-down time for LEDA, LEDB and LEDC: LED_RAMP_DOWN[4:0] × 8 ms 00000b = 0 × 8 ms 11111b = 31 × 8 ms

**8.5.1.3.65 LED\_SEQ\_EN Register (Offset = 61h) [reset = 00h]**

LED\_SEQ\_EN is shown in [表 8-216](#) and described in [表 8-217](#).

Return to [Summary Table](#).

Register is reset on a POR event.

**表 8-216. LED\_SEQ\_EN Register**

7	6	5	4	3	2	1	0
RSVD	LEDA_EN	LEDB_EN	LEDC_EN	RSVD	LEDA_SEQ_EN	LEDB_SEQ_EN	LEDC_SEQ_EN
R-0b	R/W-0b	R/W-0b	R/W-0b	R-0b	R/W-0b	R/W-0b	R/W-0b

**表 8-217. LED\_SEQ\_EN Register Field Descriptions**

Bit	Field	Type	Reset	Description
7	RSVD	R	0b	Unused bit read returns 0b.
6	LEDA_EN	R/W	0b	0b = LEDA is disabled 1b = LEDA is enabled
5	LEDB_EN	R/W	0b	0b = LEDB is disabled 1b = LEDB is enabled
4	LEDC_EN	R/W	0b	0b = LEDC is disabled 1b = LEDC is enabled
3	RSVD	R	0b	Unused bit
2	LEDA_SEQ_EN	R/W	0b	0b = LEDA sequencer is disabled 1b = LEDA sequencer is enabled
1	LEDB_SEQ_EN	R/W	0b	0b = LEDB sequencer is disabled 1b = LEDB sequencer is enabled
0	LEDC_SEQ_EN	R/W	0b	0b = LEDC sequencer is disabled 1b = LEDC sequencer is enabled

## 8.5.1.3.66 LEDx DC current

表 8-218. LEDx DC current

LEDx_CURRENT[3:0]	LED CURRENT (mA)
0000b	2
0001b	4
0010b	6
0011b	8
0100b	10
0101b	12
0110b	14
0111b	16
1000b	18
1001b	20
1010b to 1111b	20

## 8.5.1.3.67 LOADSWITCH (Offset = 62h) [reset = OTP]

LOADSWITCH is shown in 表 8-219 and described in 表 8-220.

Return to [Summary Table](#).

Register is reset on a POR event.

表 8-219. LOADSWITCH Register

7	6	5	4	3	2	1	0
RSVD				ILIM[1:0]		ENABLE[1:0]	
R-0000b				R/W-OTP		R/W-X	

表 8-220. LOADSWITCH Register Field Descriptions

Bit	Field	Type	Reset	Description
7-4	RSVD	R	0000b	Unused bit read returns 0b.
3-2	ENABLE[1:0]	R/W	OTP	00b = Load switch is OFF 01b = Load switch is forced ON 10b = Load switch in bypass switch operation: It is automatically enabled by comparators in DCDC4; forced PWM mode of DCDC4 is blocked and the bypass switch is disabled (ENABLE[1:0] is set to 00b) if the voltage on the VDCDC4 pin exceeds typically 4.18 V 11b = Load switch in bypass switch operation: Switch is forced ON; forced PWM mode of DCDC4 is blocked and the bypass switch is disabled (ENABLE[1:0] is set to 00b) if the voltage on the VDCDC4 pin exceeds typically 4.18 V
1-0	ILIM[1:0]	R/W	X	ENABLE[1] reset value is set by the EN_LS1 pin. ENABLE[0] reset value is set by the EN_LS0 pin. 00b = Current limit is 100 mA maximum 01b = Current limit is 500 mA maximum 10b = Current limit is 750 mA $\pm$ 10% 11b = Current limit is 2.5 A $\pm$ 20%

### 8.5.1.3.68 SPARE Register (Offset = 63h) [reset = OTP]

SPARE is shown in [表 8-221](#) and described in [表 8-222](#).

Return to [Summary Table](#).

Register is reset on a POR event.

**表 8-221. SPARE Register**

7	6	5	4	3	2	1	0
SPARE[3:0]				9MHZ OSC OFF	DCDC4_SEL DELAY	DCDC4_IMMEDIATE	CLK32k_OD_EN
R/W-OTP				R/W-OTP	R/W-OTP	R/W-OTP	R/W-OTP

**表 8-222. SPARE Register Field Descriptions**

Bit	Field	Type	Reset	Description
7-4	SPARE[3:0]	R/W	OTP	Unused bit read returns 0b.
3	9 MHz OSC OFF	R/W	OTP	0b = 9-MHz oscillator enabled in ON state 1b = 9-MHz oscillator is disabled based on the PWR_REQ and CLK_REQ1 pins as listed below: PWR_REQ = 0b and CLK_REQ1 = 0b: oscillator OFF PWR_REQ = 0b and CLK_REQ1 = 1b: oscillator ON PWR_REQ = 1b and CLK_REQ1 = 0b: oscillator ON PWR_REQ = 1b and CLK_REQ1 = 1b: oscillator ON
2	DCDC4_SEL DELAY	R/W	OTP	0b = DELAY is $(0.5 \text{ to } 1.5) \times (1 / 32 \text{ kHz})$ for a falling output voltage 1b = NO DELAY on the DCDC4_SELbit
1	DCDC4_IMMEDIATE	R/W	OTP	0b = A voltage change in registers DCDC4_OP or DCDC4_AVS is done with the slew rate defined in DCDC4_CTRL:TSTEP[2:0] 1b = A voltage change in registers DCDC4_OP or DCDC4_AVS is done immediately without limiting it by the slew rate control
0	CLK32K_OD_EN	R/W	OTP	0b = 32KCLKOUT is configured as a push-pull output to VDDIO 1b = 32KCLKOUT is configured as an open drain output

### 8.5.1.3.69 VERNUM (Offset = 64h) [reset = OTP]

VERNUM is shown in [表 8-223](#) and described in [表 8-224](#).

Return to [Summary Table](#).

Register is reset on a POR event.

**表 8-223. VERNUM Register**

7	6	5	4	3	2	1	0
OTP_VERSION[7:4]				VERNUM[3:0]			
R-OTP				R-OTP			

**表 8-224. VERNUM Register Field Descriptions**

Bit	Field	Type	Reset	Description
7-4	OTP_VERSION[7:4]	R	OTP	Value varies based on OTP.

**表 8-224. VERNUM Register Field Descriptions (continued)**

Bit	Field	Type	Reset	Description
3-0	VERNUM[3:0]	R	OTP	Value depending on silicon revision 00000000b = Revision 1.0 00000001b = Revision 1.1 00000010b = Revision 1.2 00000011b = Revision 1.3 00000100b = Revision 1.4 00000101b = Revision 1.5



## 9 Application and Implementation

---

### Note

Information in the following applications sections is not part of the TI component specification, and TI does not warrant its accuracy or completeness. TI's customers are responsible for determining suitability of components for their purposes, as well as validating and testing their design implementation to confirm system functionality.

---

### 9.1 Application Information

The TPS659128x device is an integrated power-management integrated circuit (PMIC) that comes in an 81-pin, 0.4-mm pitch, DSBGA package. This device was designed for personal electronics, industrial, and communication applications and is typically powered from a 5-V input supply. The device provides four step-down converters along with an interface to control ten external LDO regulators. The device can support a variety of different processors and applications. The step-down converters can also support dynamic voltage scaling (DVS) through a dedicated I<sup>2</sup>C interface to provide optimum power savings. In addition to the power resources, the device contains an embedded power controller (EPC) to manage the power sequencing requirements of systems. The power sequencing is programmable through OTP memory. The device also contains five configurable GPIOs and three LED drivers. The following sections provide the typical application use-case with the recommended external components and layout guidelines.

### 9.2 Typical Application

The first item to evaluate is the use of the CONFIG1 and CONFIG2 pins. For more information on implementing a device in a given system, refer to the application report for a specific orderable part number.

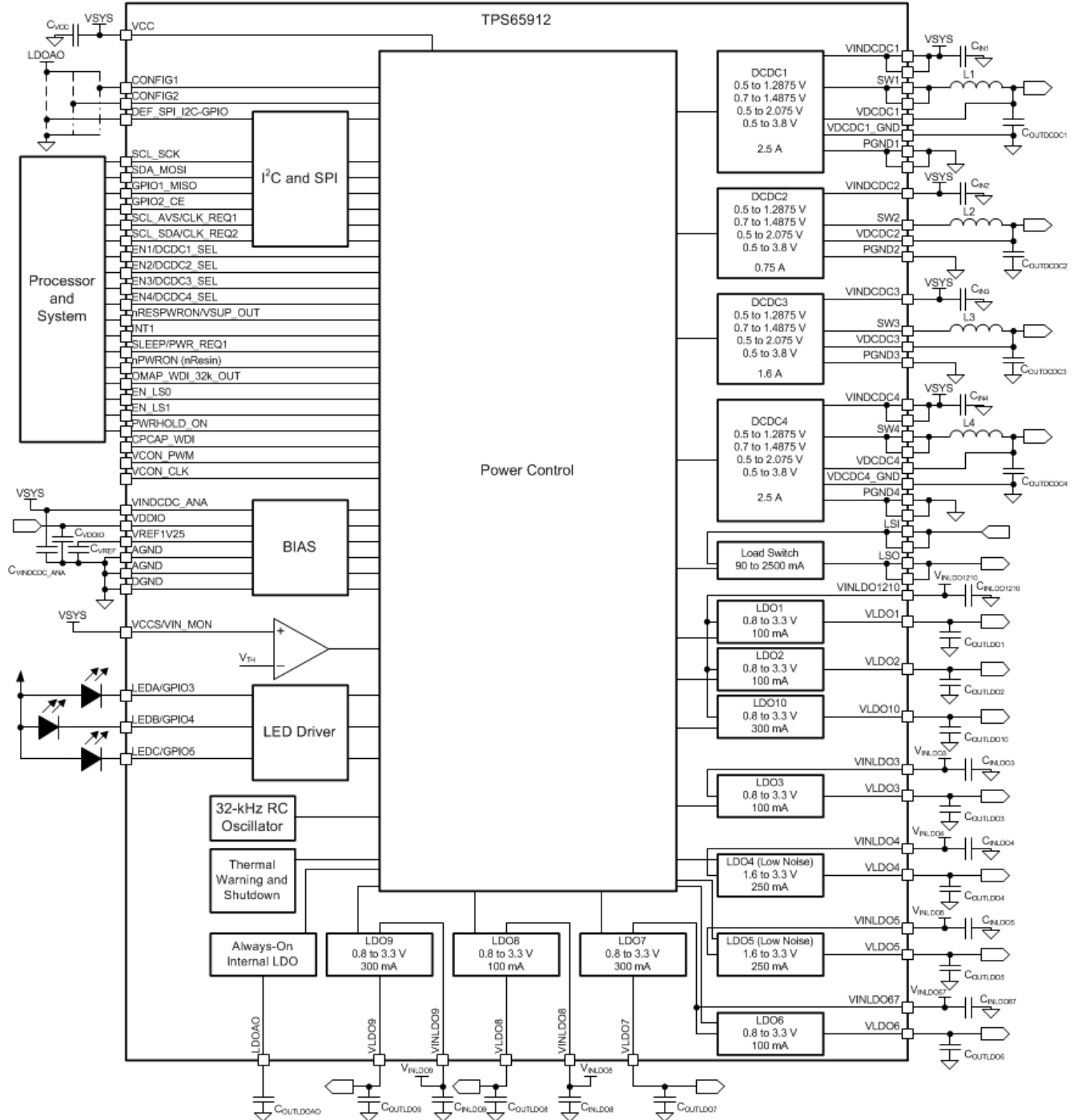

Copyright © 2017, Texas Instruments Incorporated

**9-1. Typical Application Schematic**

## 9.2.1 Design Requirements

For a typical application shown in [图 9-1](#), [表 9-1](#) lists sample key design parameters of the power resources. Voltages and currents will vary based on the application use case, the provided values are just an example.

**表 9-1. Design Parameters**

DESIGN PARAMETER	VALUE
Supply voltage	2.7 V to 5.5 V
Switching frequency	Up to 3.5 MHz
DCDC1 voltage	1.1 V
DCDC1 current	Up to 2.5 A
DCDC2 voltage	2.0 V
DCDC2 current	Up to 0.75 A
DCDC3 voltage	3.2 V
DCDC3 current	Up to 1.6 A
DCDC4 voltage	3.6 V
DCDC4 current	Up to 2.5 A
LDO1 voltage	850 mV or 900 mV
LDO1 current	Up to 100 mA
LDO2 voltage	850 mV or 900 mV
LDO2 current	Up to 100 mA
LDO3 voltage	1.2 V
LDO3 current	Up to 100 mA
LDO4 voltage	1.7 V or 1.8 V
LDO4 current	Up to 250 mA
LDO5 voltage	2.7 V
LDO5 current	Up to 250 mA
LDO6 voltage	1.8 V or 3.0 V
LDO6 current	Up to 100 mA
LDO7 voltage	3.0 V
LDO7 current	Up to 300 mA
LDO8 voltage	3.1 V
LDO8 current	Up to 100 mA
LDO9 voltage	3.0 V
LDO9 current	Up to 300 mA
LDO10 voltage	1.8 V
LDO10 current	Up to 300 mA

## 9.2.2 Detailed Design Procedure

[表 9-2](#) lists the recommended external components.

**表 9-2. Recommended External Components**

REFERENCE COMPONENTS	COMPONENT <sup>(1)</sup>	MANUFACTURER	PART NUMBER	VALUE	EIA SIZE CODE <sup>(4)</sup>	SIZE (mm)	MASS PRODUCTION <sup>(2)</sup>
<b>INPUT POWER SUPPLIES EXTERNAL COMPONENTS</b>							
C <sub>VCC</sub> , C <sub>VINDCDC_ANA</sub>	Power input capacitors	Murata	GRM188R71A225KE15	2.2 μF, 10 V	0603	1.6 × 0.8 × 0.8	Available <sup>(3)</sup>
C <sub>VDDIO</sub>	I/O input capacitor	Murata	GRM188R60J475KE19	4.7 μF, 6.3 V	0603	1.6 × 0.8 × 0.8	Available <sup>(3)</sup>
<b>RGB LED EXTERNAL COMPONENTS</b>							

表 9-2. Recommended External Components (continued)

REFERENCE COMPONENTS	COMPONENT <sup>(1)</sup>	MANUFACTURER	PART NUMBER	VALUE	EIA SIZE CODE <sup>(4)</sup>	SIZE (mm)	MASS PRODUCTION <sup>(2)</sup>
LEDA	Yellow LED	Lite On	LTST-C190YKT	20mA, 2.1 V	0603	1.6 × 0.8 × 0.8	Available <sup>(3)</sup>
LEDB	Green LED	Lite On	LTST-C190GKT	20mA, 2.1 V	0603	1.6 × 0.8 × 0.8	Available <sup>(3)</sup>
LEDC	Red LED	Lite On	LTST-C190CKT	20mA, 2.1 V	0603	1.6 × 0.8 × 0.8	Available <sup>(3)</sup>
<b>DCDC EXTERNAL COMPONENTS</b>							
C <sub>IN1</sub> , C <sub>IN2</sub> , C <sub>IN3</sub> , C <sub>IN4</sub>	Input capacitor	Murata	GRM188R60J106ME47	10 μF, 6.3 V	0603	1.6 × 0.8 × 0.8	Available <sup>(3)</sup>
C <sub>OUTDCDC1</sub> , C <sub>OUTDCDC4</sub>	Output capacitor	Murata	GCM32ER70J476KE19 (Two capacitors per rail)	10 μF, 6.3 V	0603	1.6 × 0.8 × 0.8	Available <sup>(3)</sup>
C <sub>OUTDCDC2</sub> , C <sub>OUTDCDC3</sub>	Output capacitor	Murata	GRM188R60J106ME47	10 μF, 6.3 V	0603	1.6 × 0.8 × 0.8	Available <sup>(3)</sup>
L1, L2, L3, L4	Inductor	Toko	1239AS-H-1R0N=P2	1 μH		2 × 2.5	Available <sup>(3)</sup>
<b>LDO EXTERNAL COMPONENTS</b>							
C <sub>INLDO1210</sub> , C <sub>INLDO3</sub> , C <sub>INLDO67</sub> , C <sub>INLDO8</sub> , C <sub>INLDO9</sub>	Input capacitor	Murata	GRM188R71A225KE15	2.2 μF, 10 V	0603	1.6 × 0.8 × 0.8	Available <sup>(3)</sup>
C <sub>INLDO4</sub> , C <sub>INLDO5</sub>	Input capacitor	Murata	GRM188R60J475KE19	4.7 μF, 6.3 V	0603	1.6 × 0.8 × 0.8	Available <sup>(3)</sup>
C <sub>OUTLDO3</sub> , C <sub>OUTLDO1</sub> , C <sub>OUTLDO2</sub> , C <sub>OUTLDO6</sub> , C <sub>OUTLDO7</sub> , C <sub>OUTLDO8</sub> , C <sub>OUTLDO9</sub> , C <sub>OUTLDO10</sub> , C <sub>OUTLDOAO</sub>	Output capacitor	Murata	GRM188R71A225KE15	2.2 μF, 10 V	0603	1.6 × 0.8 × 0.8	Available <sup>(3)</sup>
C <sub>OUTLDO4</sub> , C <sub>OUTLDO5</sub>	Output capacitor	Murata	GRM188R60J475KE19	4.7 μF, 6.3 V	0603	1.6 × 0.8 × 0.8	Available <sup>(3)</sup>
C <sub>VREF</sub>	Output capacitor	Murata	GRM033R60J224ME15D	220 nF, 6.3 V	0201	0.6 × 0.3 × 0.33	Available

(1) Component minimum and maximum tolerance values are specified in the electrical parameters section of each IP.

(2) This column refers to the criteria.

(3) Component used on the validation boards.

(4) The PACK column describes the external component package type.

### 9.2.2.1 Output Filter Design (Inductor and Output Capacitor)

#### 9.2.2.1.1 Inductor Selection

The step-down converters are designed to operate with small external components such as 1-μH output inductors. The values given in the *Recommended Operating Conditions* (see [セクション 6.3](#)) include tolerances and saturation effects and must not be violated for stable operation. The selected inductor must be rated for its DC resistance and saturation current. The DC resistance of the inductor will directly influence the efficiency of the converter. Therefore an inductor with lowest DC resistance should be selected for highest efficiency.

Use [式 3](#) to calculate the maximum inductor current under static load conditions. The saturation current of the inductor should be rated higher than the maximum inductor current as calculated with [式 3](#). This recommendation is because during heavy load transients, the inductor current rises above the calculated value.

$$\Delta I_L = V_{OUT} \times \frac{1 - \frac{V_{OUT}}{V_{IN}}}{L \times f} \quad (2)$$

where

- $\Delta I_L$  is the peak-to-peak inductor ripple current.
- L is the inductor value.
- f is the switching frequency.

$$I_{L_{\max}} = I_{\text{OUT}_{\max}} \times \frac{\Delta I_L}{2} \quad (3)$$

where

- $I_{L_{\max}}$  is the maximum inductor current.

The highest inductor current will occur at the maximum input voltage,  $V_{\text{IN}}$ .

Open-core inductors have a soft saturation characteristic and they can usually support higher inductor currents versus a comparable shielded inductor.

A more conservative approach is to select the inductor-current rating just for the maximum switch current of the corresponding converter. The core material from inductor to inductor differs and will have an impact on the efficiency especially at high switching frequencies, and therefore the core material must be considered when selecting an inductor.

For possible inductors, refer to [表 9-3](#) and [表 9-2](#).

**表 9-3. Tested Inductors**

INDUCTOR TYPE	NOMINAL INDUCTANCE	SUPPLIER
DFE252012	1 $\mu\text{H}$	Toko
DFE322510	1 $\mu\text{H}$	Toko
DFE322512	1 $\mu\text{H}$	Toko
VLS201612ET-1R0	1 $\mu\text{H}$	TDK
SPM3012T-1R0	1 $\mu\text{H}$	TDK

#### 9.2.2.1.2 Output Capacitor Selection

The control scheme of the DC-DC converters allow the use of small ceramic capacitors with a typical value as given in the *Recommended Operating Conditions* (see [セクション 6.3](#)), without having a large output voltage under and overshoots during heavy load transients. Ceramic capacitors having low ESR values which result in the lowest output voltage ripple and are therefore recommended.

If ceramic output capacitors are used, the RMS ripple-current rating of the capacitor ( $I_{\text{RMS}_{\text{COUT}}}$ ) always meets the application requirements. Use [式 4](#) to calculate the RMS ripple current.

$$I_{\text{RMS}_{\text{Cout}}} = V_{\text{OUT}} \times \frac{1 - \frac{V_{\text{OUT}}}{V_{\text{IN}}}}{L \times f} \times \frac{1}{2 \times \sqrt{3}} \quad (4)$$

At the nominal load current, the inductive converters operate in PWM mode and the overall output-voltage ripple is the sum of the voltage spike caused by the ESR of the output capacitor plus the voltage ripple caused by charging and discharging the output capacitor. Use [式 5](#) to calculate the output-voltage ripple ( $\Delta V_{\text{OUT}}$ ).

$$\Delta V_{\text{OUT}} = V_{\text{OUT}} \times \frac{1 - \frac{V_{\text{OUT}}}{V_{\text{IN}}}}{L \times f} \times \left( \frac{1}{8 \times C_{\text{OUT}} \times f} + \text{ESR} \right) \quad (5)$$

The highest output voltage ripple occurs at the highest input voltage,  $V_{\text{IN}}$ .

At light load currents, the converters operate in power save mode and the output-voltage ripple is dependent on the value of the output capacitor. The output-voltage ripple is set by the internal comparator delay and the external capacitor. The typical output-voltage ripple is less than 1% of the nominal output voltage.

#### 9.2.2.1.3 Input Capacitor Selection and Input Voltage

Because of the nature of the step-down converter having a pulsating input current, a low-ESR input capacitor is required for best input voltage filtering and minimizing the interference with other circuits caused by high input-voltage spikes. The converters require a ceramic input capacitor of 10  $\mu\text{F}$ . The value of the input capacitor can be increased without any limit for better input voltage filtering. Ceramic capacitors suffer from the so-called *DC bias effect*. A DC voltage applied at a ceramic capacitor will change the effective capacitance to a value lower than the nominal value. Curves about that behavior are available from the capacitor manufacturers and must be considered when using the capacitors in applications where a DC voltage is applied and a minimum capacitance must be maintained for proper functionality of the circuit. The values given in the *Recommended Operating Conditions* for the TPS659128x device are for the capacitance; however, the actual capacitor used may have a larger nominal value that drops with the voltage applied to what is recommended. The capacitance drop depends on the voltage applied, therefore, higher voltages, such as the output voltage of a DC-DC converter or LDO, must be considered when choosing a proper capacitor.

The input voltage for the step-down converters must be connected to the VINDCDC1, VINDCDC2, VINDCDC3, and VINDCDC4 pins. These pins must be tied together with the VINDCDC\_ANA pin to the power source. The VCC pin must be tied to the highest voltage in the system. If the load switch is used as a switch on the output, the VCC pin must be tied to the input voltage of the VINDCDCx and VINDCDC\_ANA pins. If the load switch is used as a current limited switch on the input, the VCC pin must be connected to the LSI pin while the LSO pin is connected to the VINDCDCx and VINDCDC\_ANA pins. The four step-down converters must not be supplied from different input voltages.

#### 9.2.2.1.4 Output Capacitor Table

The DC-DC converters are designed for an output capacitance as given in the *Recommended Operating Conditions* (see [セクション 6.3](#)). A ceramic capacitor, such as a X5R or X7R type, is required at the output. [表 9-4](#) lists capacitors used for the TPS659128x device.

**表 9-4. Example Capacitors**

VALUE	SIZE	SUPPLIER	MATERIAL AND RATING
47 $\mu\text{F}$ / 6.3 V	0805	Murata GRM21BR60J476ME15	Ceramic X5R
22 $\mu\text{F}$ / 6.3 V	0805	Murata GRM21BR60J226M	Ceramic X5R
10 $\mu\text{F}$ / 10 V	0603	Murata GRM188R61A106ME69	Ceramic X5R
4.7 $\mu\text{F}$ / 6.3 V	0603	Murata GRM188R60J475KE19	Ceramic X5R
4.7 $\mu\text{F}$ / 6.3 V	0402	Murata GRM155R60J475ME87	Ceramic X5R

#### 9.2.2.1.5 Voltage Change on DCDC1 to DCDC4

The output voltage of the DC-DC converters can be changed during operation by either the digital interfaces, by toggling the DCDCx\_SEL pin, or by entering SLEEP state if the resources are configured to change voltage based on the device state.

### 9.2.3 Application Curves

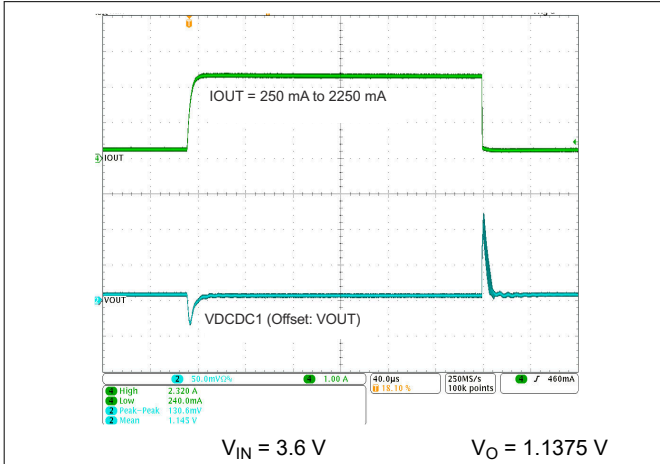

9-2. DCDC1 Load Transient Response

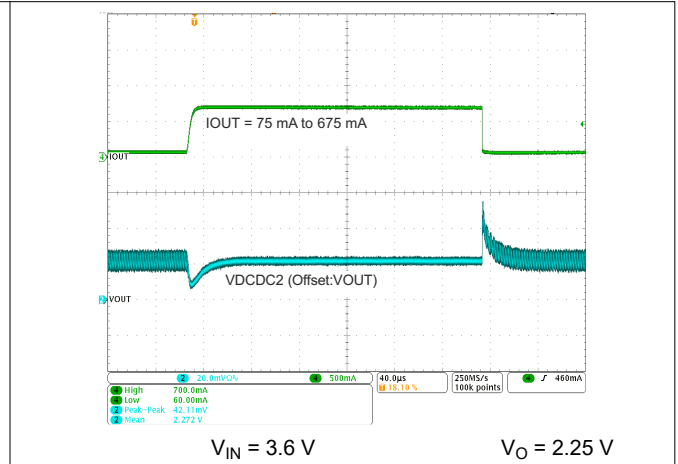

9-3. DCDC2 Load Transient Response

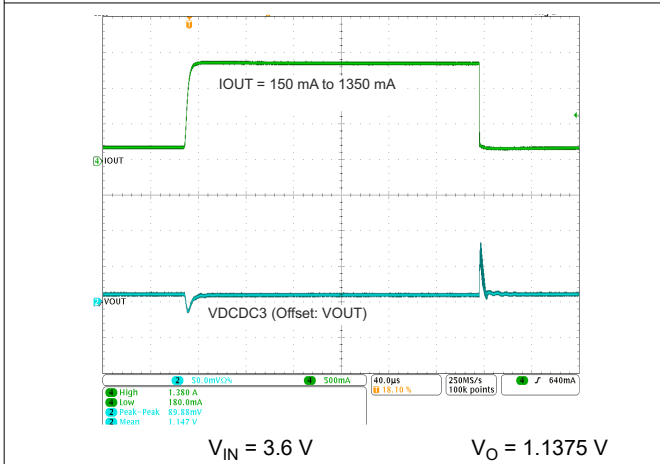

9-4. DCDC3 Load Transient Response

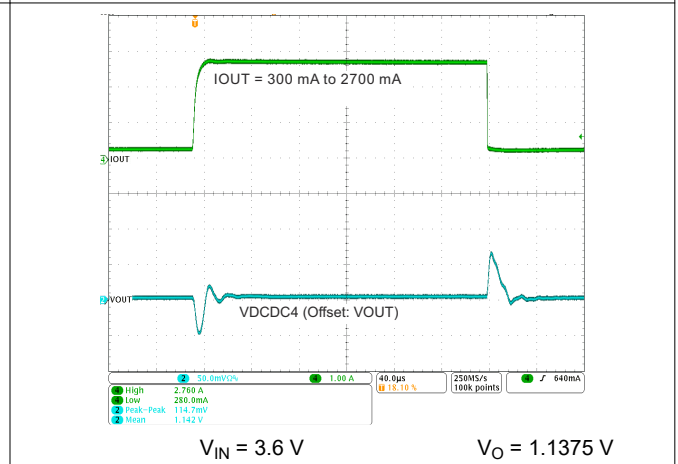

9-5. DCDC4 Load Transient Response

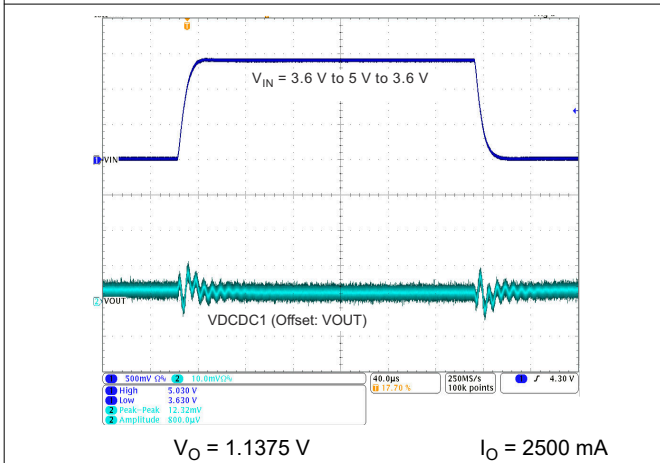

9-6. DCDC1 Line Transient Response

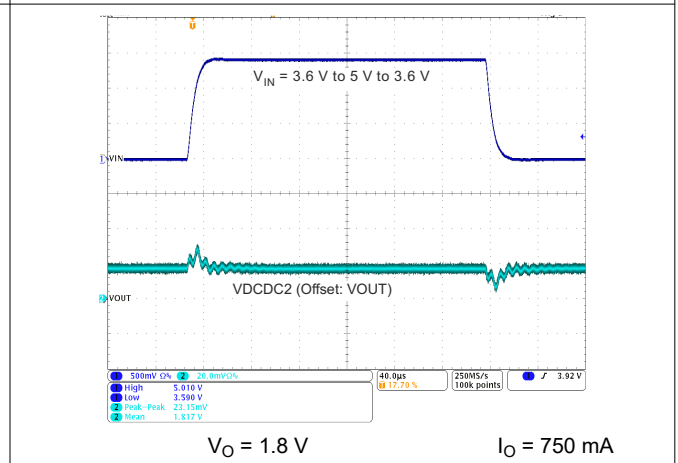

9-7. DCDC2 Line Transient Response

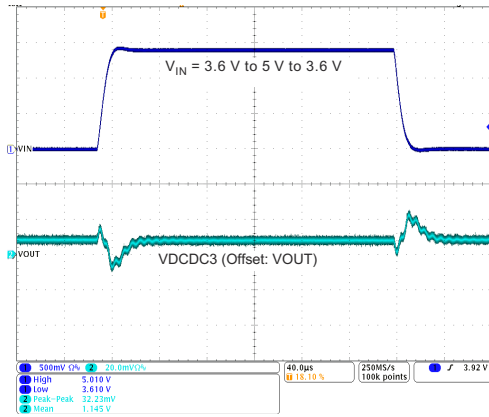

$V_O = 1.1375\text{ V}$   $I_O = 1500\text{ mA}$

9-8. DCDC3 Line Transient Response

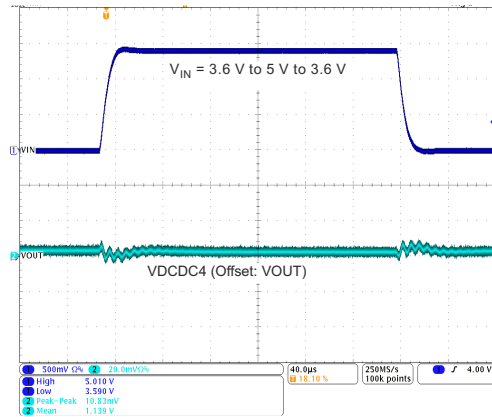

$V_O = 1.1375\text{ V}$   $I_O = 3000\text{ mA}$

9-9. DCDC4 Line Transient Response

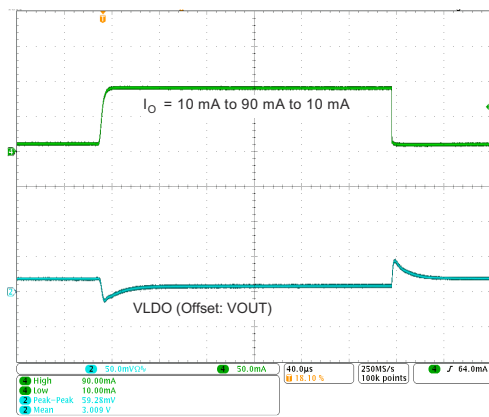

$V_{IN} = 3.3\text{ V}$   $V_O = 3\text{ V}$

9-10. LDO1, LDO2, LDO3 Load Transient Response

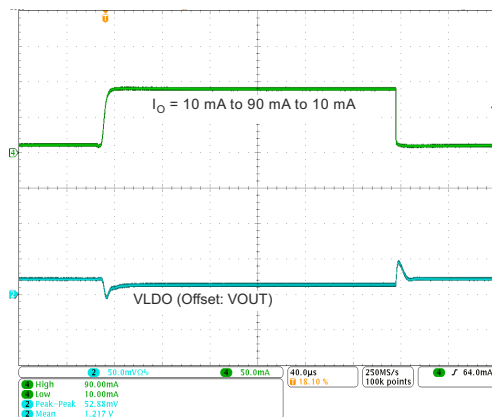

$V_{IN} = 1.8\text{ V}$   $V_O = 1.2\text{ V}$

9-11. LDO1, LDO2, LDO3 Load Transient Response

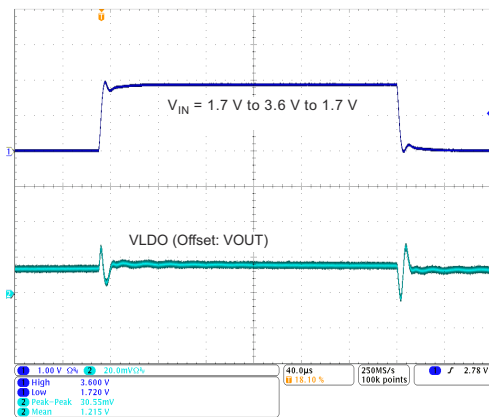

$I_O = 100\text{ mA}$   $V_O = 1.2\text{ V}$

9-12. LDO1, LDO2, LDO3 Line Transient Response

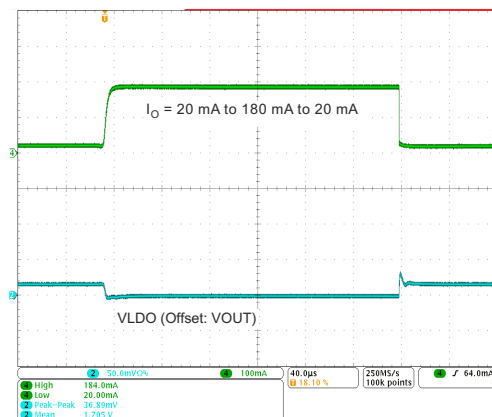

$V_{IN} = 2\text{ V}$   $V_O = 1.7\text{ V}$

9-13. LDO4, LDO5 Load Transient Response



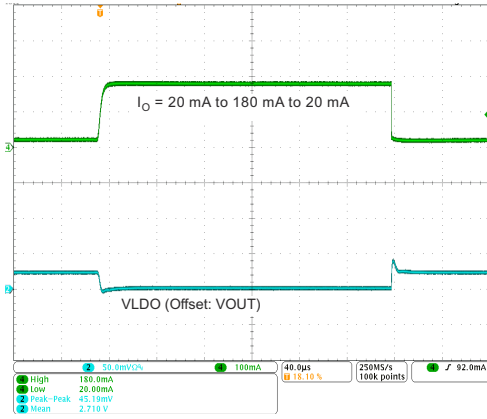

$V_{IN} = 3.2\text{ V}$        $V_O = 2.7\text{ V}$

**9-14. LDO4, LDO5 Load Transient Response**

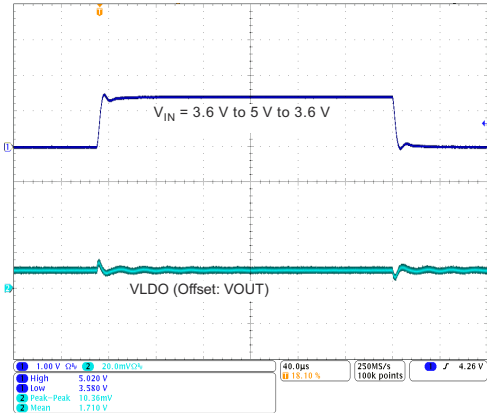

$I_O = 100\text{ mA}$        $V_O = 1.7\text{ V}$

**9-15. LDO4, LDO5 Line Transient Response**

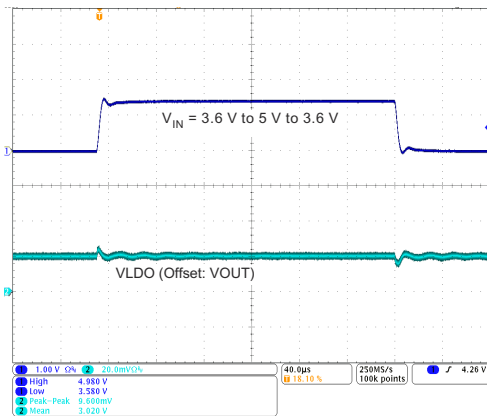

$I_O = 100\text{ mA}$        $V_O = 3\text{ V}$

**9-16. LDO4, LDO5 Line Transient Response**

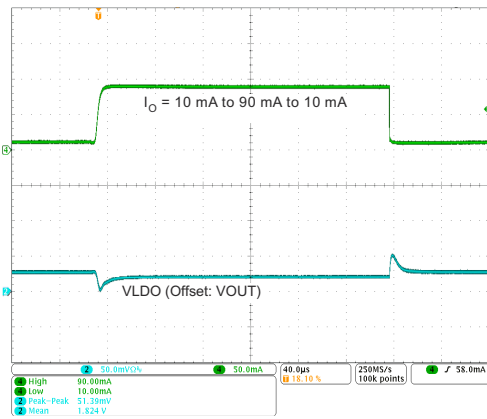

$V_{IN} = 3.3\text{ V}$        $V_O = 1.8\text{ V}$

**9-17. LDO6, LDO8 Load Transient Response**

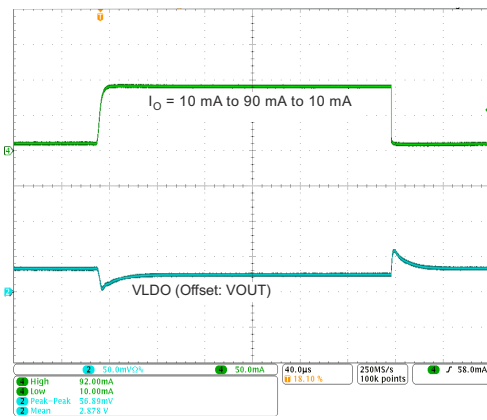

$V_{IN} = 3.3\text{ V}$        $V_O = 2.85\text{ V}$

**9-18. LDO6, LDO8 Load Transient Response**

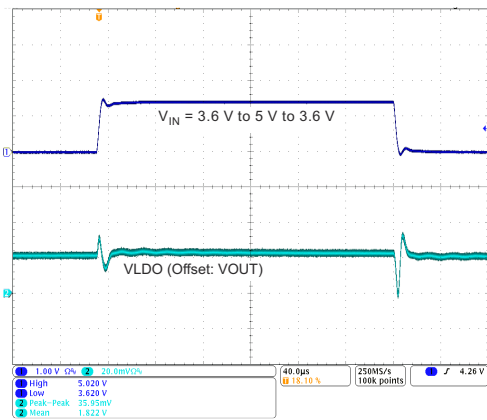

$I_O = 100\text{ mA}$        $V_O = 1.8\text{ V}$

**9-19. LDO6, LDO8 Line Transient Response**

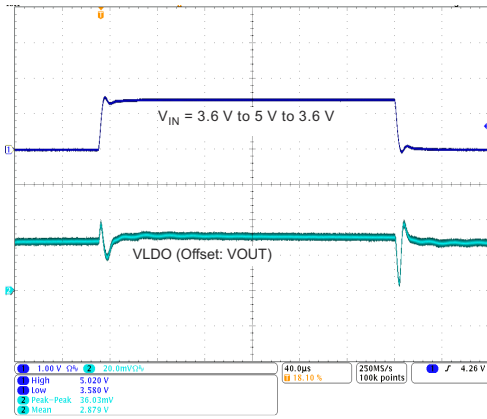

$I_O = 100 \text{ mA}$        $V_O = 2.85 \text{ V}$

**9-20. LDO6, LDO8 Line Transient Response**

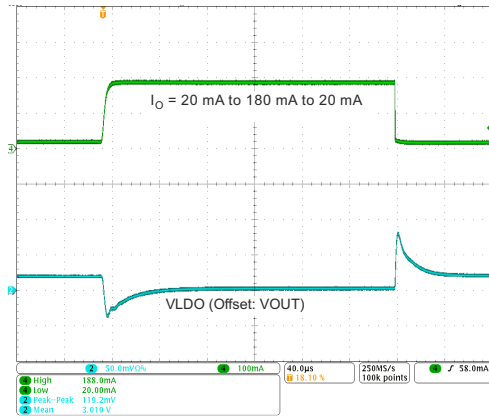

$V_{IN} = 3.2 \text{ V}$        $V_O = 3 \text{ V}$

**9-21. LDO7 Load Transient Response**

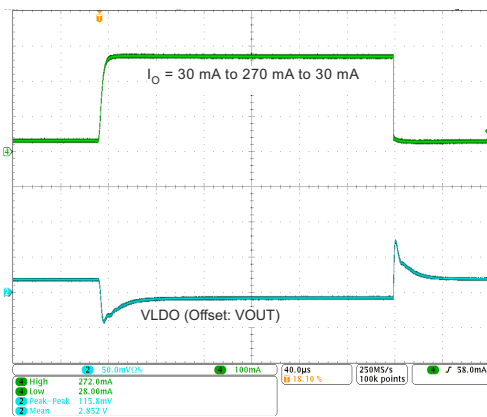

$V_{IN} = 3.3 \text{ V}$        $V_O = 2.85 \text{ V}$

**9-22. LDO9 Load Transient Response**

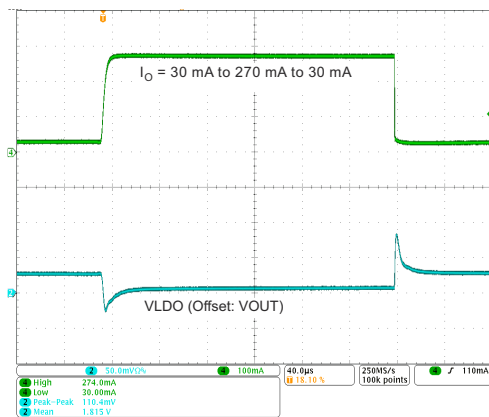

$V_{IN} = 3.3 \text{ V}$        $V_O = 1.8 \text{ V}$

**9-23. LDO10 Load Transient Response**

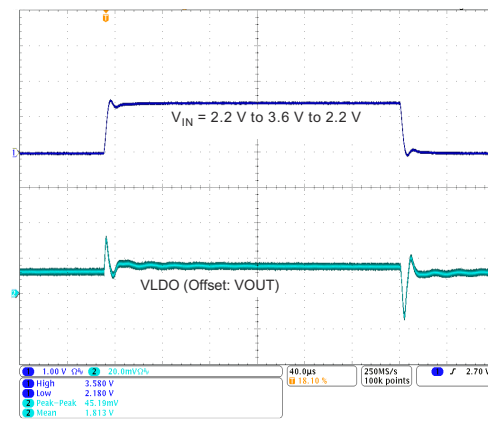

$I_O = 300 \text{ mA}$

$V_O = 1.8 \text{ V}$

**9-24. LDO10 Line Transient Response**

## 10 Layout

### 10.1 Layout Guidelines

As for all switching power supplies, the layout is an important step in the design. Proper functionality of the device demands careful attention to PCB layout. Care must be taken in board layout to get the specified performance. If the layout is not carefully done, the regulators may show poor line regulation, load regulation, or both and stability issues, as well as EMI problems. Providing a low-impedance ground path is critical. Therefore, use wide and short traces for the main current paths. The input capacitors must be placed as close as possible to the device pins as well as the inductor and output capacitor.

Keep the common path to the GND pins, which returns the small signal components, and the high current of the output capacitors as short as possible to avoid ground noise. The VDCDCx trace should be connected directly to the output capacitor and routed away from noisy components and traces (for example, the L1, L2, L3, and L4 traces).

The most critical connections are:

- PGNDx
- VDCDCx (positive output-voltage sense connection)
- VDCDCx\_GND (ground-sense connection)
- AGND
- VINDCDCx, VINDCDC\_ANA, VCC

The PGNDx pins are the ground connections of the power stages, so they will carry high DC-peak and AC-peak currents. A low impedance connection to the GND plane is required, which must be independent from other pins to not couple noise into other pins. Other pins must not be connected to PGNDx pins.

The VDCDCx pins are the positive-sense connections for the feedback loop. The connection must be made directly to the positive terminal pad of the output capacitor. Do not tie the pin to the pad of the output inductor or anywhere in between the inductor and capacitor. Shielding the connection by GND traces or a GND plane is a best practice.

The VDCDCx\_GND pin is a sense connection for GND and is only available for the DCDC1 and DCDC4 converters. The connection can be made either to the GND pad of the output capacitor (preferred) or to the GND plane directly if a solid connection of the GND-plane to the output capacitor exists. The pin must not be connected to the PGNDx pins as this will couple switching noise into the feedback loop.

The AGND (analog ground) pin is the main GND connection for internal analog circuitry. A proper connection must be made to a GND plane directly by a via. The AGND and DGND pins (located next to each other) can be connected and a via each be used to the GND plane.

The VINDCDCx, VINDCDC\_ANA, and VCC pins are supply-voltage-input terminals and must be properly bypassed by their input capacitors. The required capacitance is given in the *Recommended Operating Conditions* (see [セクション 6.3](#)). As ceramic capacitors will change their capacitance based on the voltage applied, temperature and age, the influence of these parameters must be considered when choosing the value of a capacitor. The input capacitors are ideally placed on the same layer as the device, so the connection can be made short and directly on the same layer with multiple vias used from the GND terminal to the GND-plane.

For more information about the layout for the TPS659128x device, refer to the [TPS65912xEVM-081 User's Guide](#).

## 10.2 Layout Example

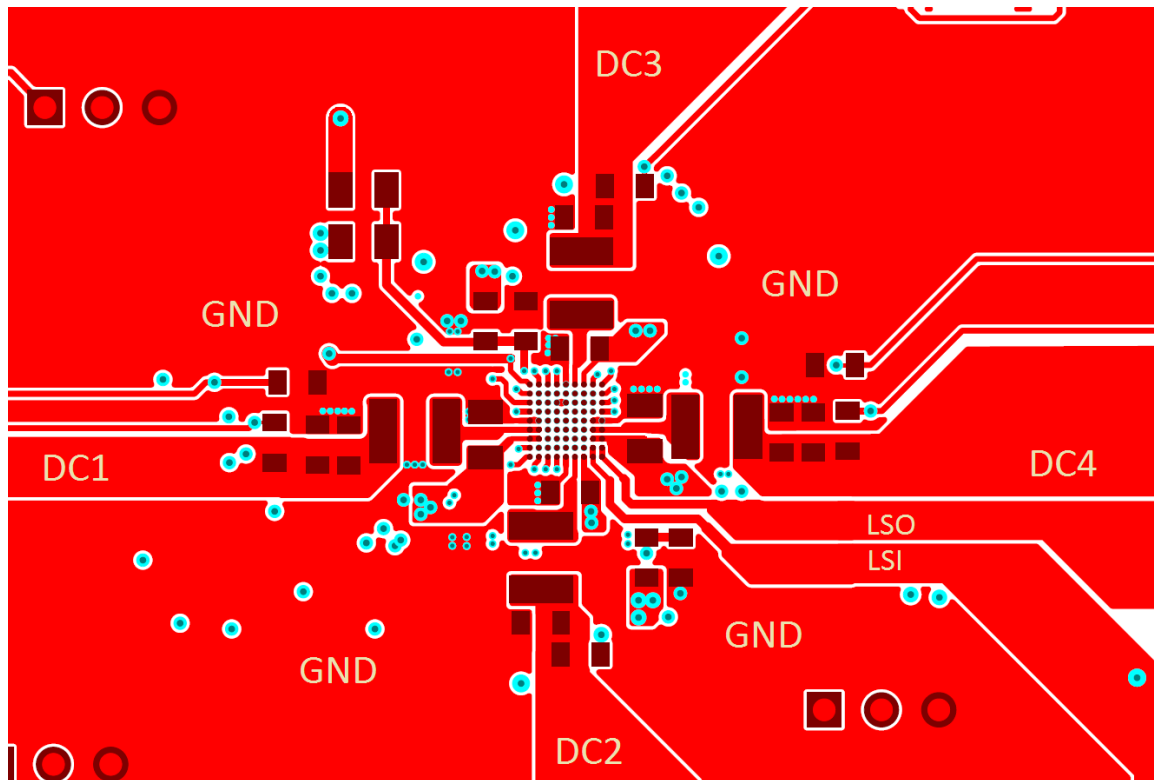

10-1. Layout Example

## 11 Power Supply Recommendations

The TPS659128x device is designed to work with an analog supply voltage range from 2.7 V to 5.5 V. The input supply should be well regulated and connected to the VCC pin, as well as the DCDC and LDO input pins. If the input supply is located more than a few inches from the device, additional capacitance may be required in addition to the recommended input capacitors at the VCC pin and the DCDC and LDO input pins.

## 12 Device and Documentation Support

### 12.1 Device Support

#### 12.1.1 Development Support

TI offers an extensive line of development tools, including tools to evaluate the performance of the processors, generate code, develop algorithm implementations, and fully integrate and debug software and hardware modules. The tool's support documentation is electronically available within the Code Composer Studio™ Integrated Development Environment (IDE).

The following products support development of the TPS659128x device applications:

**Software Development Tools:** Code Composer Studio™ Integrated Development Environment (IDE): including Editor C/C++/Assembly Code Generation, and Debug plus additional development tools Scalable, Real-Time Foundation Software ( DSP/BIOS™), which provides the basic run-time target software needed to support any TPS659128x device application.

**Hardware Development Tools:** Extended Development System ( XDS™) Emulator

For a complete listing of development-support tools for the TPS659128x platform, visit the Texas Instruments website at [www.ti.com](http://www.ti.com). For information on pricing and availability, contact the nearest TI field sales office or authorized distributor.

### 12.2 Documentation Support

#### 12.2.1 Related Documentation

For related documentation see the following:

- Texas Instruments, [Basic Calculation of a Buck Converter's Power Stage](#)
- Texas Instruments, [Empowering Designs With Power Management IC \(PMIC\) for Processor Applications application report](#)
- Texas Instruments, [TPS65912xEVM-081 User's Guide](#)

### 12.3 Receiving Notification of Documentation Updates

To receive notification of documentation updates, navigate to the device product folder on [ti.com](http://ti.com). Click on *Subscribe to updates* to register and receive a weekly digest of any product information that has changed. For change details, review the revision history included in any revised document.

### 12.4 サポート・リソース

TI E2E™ サポート・フォーラムは、エンジニアが検証済みの回答と設計に関するヒントをエキスパートから迅速かつ直接得ることができる場所です。既存の回答を検索したり、独自の質問をしたりすることで、設計に必要な支援を迅速に得ることができます。

リンクされているコンテンツは、該当する貢献者により、現状のまま提供されるものです。これらは TI の仕様を構成するものではなく、必ずしも TI の見解を反映したものではありません。TI の[使用条件](#)を参照してください。

### 12.5 Trademarks

Eco-mode™, Code Composer Studio™, DSP/BIOS™, and XDS™ are trademarks of Texas Instruments.

TI E2E™ is a trademark of Texas Instruments.

すべての商標は、それぞれの所有者に帰属します。

### 12.6 Electrostatic Discharge Caution



This integrated circuit can be damaged by ESD. Texas Instruments recommends that all integrated circuits be handled with appropriate precautions. Failure to observe proper handling and installation procedures can cause damage.

ESD damage can range from subtle performance degradation to complete device failure. Precision integrated circuits may be more susceptible to damage because very small parametric changes could cause the device not to meet its published specifications.

## 12.7 Glossary

[TI Glossary](#) This glossary lists and explains terms, acronyms, and definitions.

## 13 Mechanical, Packaging, and Orderable Information

The following pages include mechanical, packaging, and orderable information. This information is the most current data available for the designated devices. This data is subject to change without notice and revision of this document. For browser-based versions of this data sheet, refer to the left-hand navigation.



**PACKAGING INFORMATION**

Orderable Device	Status (1)	Package Type	Package Drawing	Pins	Package Qty	Eco Plan (2)	Lead finish/ Ball material (6)	MSL Peak Temp (3)	Op Temp (°C)	Device Marking (4/5)	Samples
TPS6591286YFFR	ACTIVE	DSBGA	YFF	81	3000	RoHS & Green	SNAGCU	Level-1-260C-UNLIM	-40 to 105	659128-6	<a href="#">Samples</a>
TPS6591287YFFR	ACTIVE	DSBGA	YFF	81	3000	RoHS & Green	SNAGCU	Level-1-260C-UNLIM	-40 to 105	659128-7	<a href="#">Samples</a>

(1) The marketing status values are defined as follows:

**ACTIVE:** Product device recommended for new designs.

**LIFEBUY:** TI has announced that the device will be discontinued, and a lifetime-buy period is in effect.

**NRND:** Not recommended for new designs. Device is in production to support existing customers, but TI does not recommend using this part in a new design.

**PREVIEW:** Device has been announced but is not in production. Samples may or may not be available.

**OBSELETE:** TI has discontinued the production of the device.

(2) **RoHS:** TI defines "RoHS" to mean semiconductor products that are compliant with the current EU RoHS requirements for all 10 RoHS substances, including the requirement that RoHS substance do not exceed 0.1% by weight in homogeneous materials. Where designed to be soldered at high temperatures, "RoHS" products are suitable for use in specified lead-free processes. TI may reference these types of products as "Pb-Free".

**RoHS Exempt:** TI defines "RoHS Exempt" to mean products that contain lead but are compliant with EU RoHS pursuant to a specific EU RoHS exemption.

**Green:** TI defines "Green" to mean the content of Chlorine (Cl) and Bromine (Br) based flame retardants meet JS709B low halogen requirements of <=1000ppm threshold. Antimony trioxide based flame retardants must also meet the <=1000ppm threshold requirement.

(3) MSL, Peak Temp. - The Moisture Sensitivity Level rating according to the JEDEC industry standard classifications, and peak solder temperature.

(4) There may be additional marking, which relates to the logo, the lot trace code information, or the environmental category on the device.

(5) Multiple Device Markings will be inside parentheses. Only one Device Marking contained in parentheses and separated by a "~" will appear on a device. If a line is indented then it is a continuation of the previous line and the two combined represent the entire Device Marking for that device.

(6) Lead finish/Ball material - Orderable Devices may have multiple material finish options. Finish options are separated by a vertical ruled line. Lead finish/Ball material values may wrap to two lines if the finish value exceeds the maximum column width.

**Important Information and Disclaimer:**The information provided on this page represents TI's knowledge and belief as of the date that it is provided. TI bases its knowledge and belief on information provided by third parties, and makes no representation or warranty as to the accuracy of such information. Efforts are underway to better integrate information from third parties. TI has taken and continues to take reasonable steps to provide representative and accurate information but may not have conducted destructive testing or chemical analysis on incoming materials and chemicals. TI and TI suppliers consider certain information to be proprietary, and thus CAS numbers and other limited information may not be available for release.

In no event shall TI's liability arising out of such information exceed the total purchase price of the TI part(s) at issue in this document sold by TI to Customer on an annual basis.



**TAPE AND REEL INFORMATION**

**QUADRANT ASSIGNMENTS FOR PIN 1 ORIENTATION IN TAPE**

\*All dimensions are nominal

Device	Package Type	Package Drawing	Pins	SPQ	Reel Diameter (mm)	Reel Width W1 (mm)	A0 (mm)	B0 (mm)	K0 (mm)	P1 (mm)	W (mm)	Pin1 Quadrant
TPS6591286YFFR	DSBGA	YFF	81	3000	330.0	12.4	3.79	3.79	0.71	8.0	12.0	Q1
TPS6591287YFFR	DSBGA	YFF	81	3000	330.0	12.4	3.79	3.79	0.71	8.0	12.0	Q1

**TAPE AND REEL BOX DIMENSIONS**

\*All dimensions are nominal

Device	Package Type	Package Drawing	Pins	SPQ	Length (mm)	Width (mm)	Height (mm)
TPS6591286YFFR	DSBGA	YFF	81	3000	335.0	335.0	25.0
TPS6591287YFFR	DSBGA	YFF	81	3000	335.0	335.0	25.0

YFF (R-XBGA-N81)

DIE-SIZE BALL GRID ARRAY

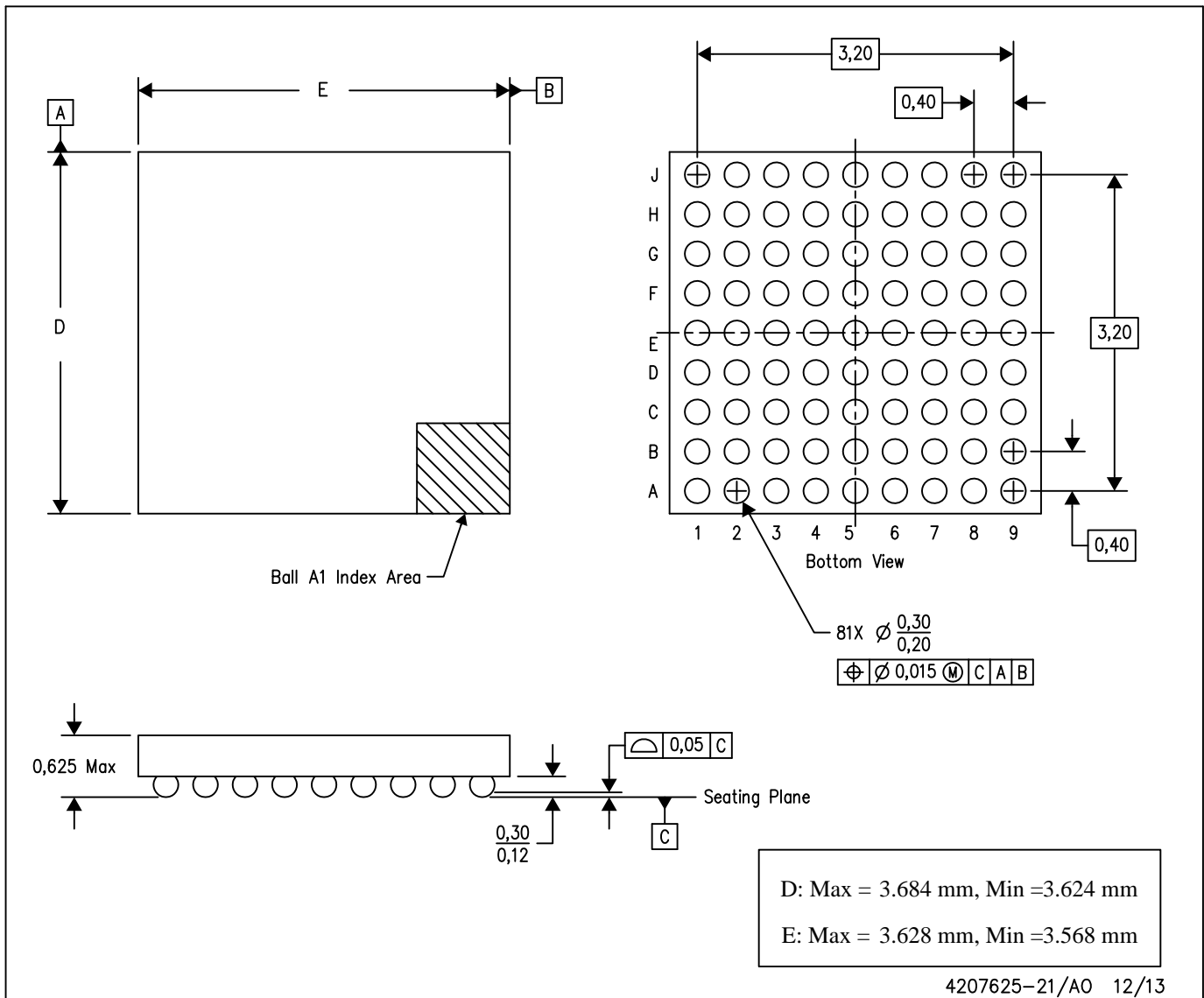

- NOTES:
- A. All linear dimensions are in millimeters. Dimensioning and tolerancing per ASME Y14.5M-1994.
  - B. This drawing is subject to change without notice.
  - C. NanoFree™ package configuration.

NanoFree is a trademark of Texas Instruments.

## 重要なお知らせと免責事項

TI は、技術データと信頼性データ (データシートを含みます)、設計リソース (リファレンス・デザインを含みます)、アプリケーションや設計に関する各種アドバイス、Web ツール、安全性情報、その他のリソースを、欠陥が存在する可能性のある「現状のまま」提供しており、商品性および特定目的に対する適合性の黙示保証、第三者の知的財産権の非侵害保証を含むいかなる保証も、明示的または黙示的にかかわらず拒否します。

これらのリソースは、TI 製品を使用する設計の経験を積んだ開発者への提供を意図したものです。(1) お客様のアプリケーションに適した TI 製品の選定、(2) お客様のアプリケーションの設計、検証、試験、(3) お客様のアプリケーションに該当する各種規格や、その他のあらゆる安全性、セキュリティ、規制、または他の要件への確実な適合に関する責任を、お客様のみが単独で負うものとし、

上記の各種リソースは、予告なく変更される可能性があります。これらのリソースは、リソースで説明されている TI 製品を使用するアプリケーションの開発の目的でのみ、TI はその使用をお客様に許諾します。これらのリソースに関して、他の目的で複製することや掲載することは禁止されています。TI や第三者の知的財産権のライセンスが付与されている訳ではありません。お客様は、これらのリソースを自身で使用した結果発生するあらゆる申し立て、損害、費用、損失、責任について、TI およびその代理人を完全に補償するものとし、TI は一切の責任を拒否します。

TI の製品は、[TI の販売条件](#)、または [ti.com](https://www.ti.com) やかかる TI 製品の関連資料などのいずれかを通じて提供する適用可能な条項の下で提供されています。TI がこれらのリソースを提供することは、適用される TI の保証または他の保証の放棄の拡大や変更を意味するものではありません。

お客様がいかなる追加条項または代替条項を提案した場合でも、TI はそれらに異議を唱え、拒否します。

郵送先住所 : Texas Instruments, Post Office Box 655303, Dallas, Texas 75265  
Copyright © 2023, Texas Instruments Incorporated