

TPS7A39 150mA、広い V_{IN} 、正負デュアルLDO電圧レギュレータ

1 特長

- 単一パッケージで正負LDOを実現
- 広い入力電圧範囲: $\pm 3.3V \sim \pm 33V$
- 広い出力電圧範囲:
 - 正範囲: $1.2V \sim 30V$
 - 負範囲: $-30V \sim 0V$
- 出力電流: チャンネルごとに150mA
- 単調な起動時間のトラッキング
- 高い電源除去率(PSRR)
 - 69dB (120Hz)
 - $\geq 50dB$ (10Hz \sim 2MHz)
- 出力電圧ノイズ: $21\mu V_{RMS}$ (10Hz \sim 100kHz)
- バッファリングされた1.2V基準電圧出力
- 10 μF 以上の出力コンデンサで安定
- 単一の正論理イネーブル
- 可変のソフトスタート突入電流制御
- 3mm \times 3mmの10ピンWSOONパッケージ
- 低い熱抵抗: $R_{\theta JA} = 44.4^{\circ}C/W$
- 動作温度範囲: $-40^{\circ}C \sim +125^{\circ}C$

2 アプリケーション

- オペアンプ、ADC、DAC、その他の高精度アナログ回路向け電源レール
- ポストDC/DCレギュレーションおよびフィルタリング
- アナログI/Oモジュール
- 試験および測定機器
- Rx、Tx、PA回路
- 産業用計測機器
- 医療用画像処理

3 概要

TPS7A39デバイスは、デュアル、モノリシックの、高PSRR、低ドロップアウト(LDO)正負電圧レギュレータで、最大150mAの電流をソース(およびシンク)できます。レギュレートされた出力は、個別かつ外部的に対称電圧または非対称電圧に調整できるので、シグナル・コンディショニング向けのデュアル・バイポーラ電源として最適です。

TPS7A39の正および負の出力は、起動中、レシオメトリックに相互トラッキングすることで、フローティング状態や、デュアルレール・システムによくあるその他の電源シーケンシングの問題を軽減します。負の出力を最大0Vまでレギュレートできるので、単電源アンプの同相電圧範囲が広がります。また、TPS7A39は高いPSRR能力を備えており、シグナル・インテグリティを損なうおそれのあるスイッチング・ノイズなどの電源ノイズを排除します。

両方のレギュレータが単一の正論理イネーブル・ピンで制御され、標準デジタル・ロジックとインターフェイスできます。コンデンサ・プログラマブルなソフトスタート機能により、突入電流と起動時間を制御します。高精度出力および出力電圧マーキングの実現や、その他の電源のトラッキングのために、TPS7A39の内部基準電圧を外部基準電圧でオーバーライドできます。また、TPS7A39では基準電圧出力がバッファリングされているので、システム内のその他のコンポーネントの基準電圧として使用できます。

これらの機能により、TPS7A39はオペアンプ、D/Aコンバータ(DAC)、その他の高精度アナログ回路に電源供給するための堅牢でありながら簡易なソリューションを提供します。

製品情報⁽¹⁾

型番	パッケージ	本体サイズ(公称)
TPS7A39	WSOON (10)	3.00mm \times 3.00mm

(1) 提供されているすべてのパッケージについては、データシートの末尾にある注文情報を参照してください。

シグナル・チェーンへの電源供給

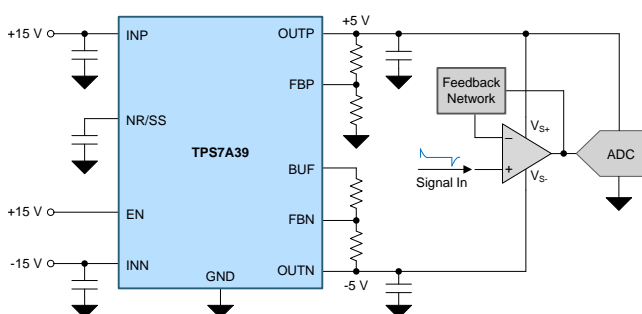

単調な起動時のトラッキング

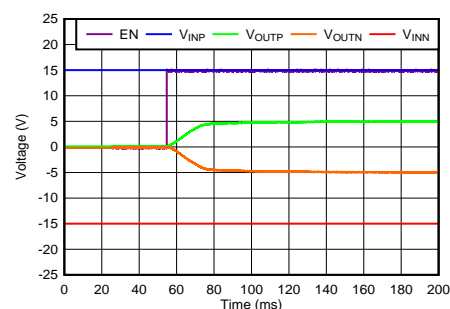

目次

1	特長	1	8	Application and Implementation	25
2	アプリケーション	1	8.1	Application Information.....	25
3	概要	1	8.2	Typical Applications	34
4	改訂履歴	2	9	Power-Supply Recommendations	39
5	Pin Configuration and Functions	3	10	Layout	39
6	Specifications	4	10.1	Layout Guidelines	39
6.1	Absolute Maximum Ratings	4	10.2	Layout Example	40
6.2	ESD Ratings.....	4	10.3	Package Mounting	40
6.3	Recommended Operating Conditions.....	5	11	デバイスおよびドキュメントのサポート	41
6.4	Thermal Information	5	11.1	デバイス・サポート.....	41
6.5	Electrical Characteristics.....	6	11.2	ドキュメントのサポート.....	41
6.6	Startup Characteristics.....	7	11.3	ドキュメントの更新通知を受け取る方法.....	41
6.7	Typical Characteristics.....	9	11.4	コミュニティ・リソース	41
7	Detailed Description	19	11.5	商標	41
7.1	Overview	19	11.6	静電気放電に関する注意事項	41
7.2	Functional Block Diagram	19	11.7	Glossary	42
7.3	Feature Description.....	20	12	メカニカル、パッケージ、および注文情報	42
7.4	Device Functional Modes.....	24			

4 改訂履歴

2017年7月発行のものから更新

Page

• 製造用にリリース.....	1
-----------------	----------

5 Pin Configuration and Functions

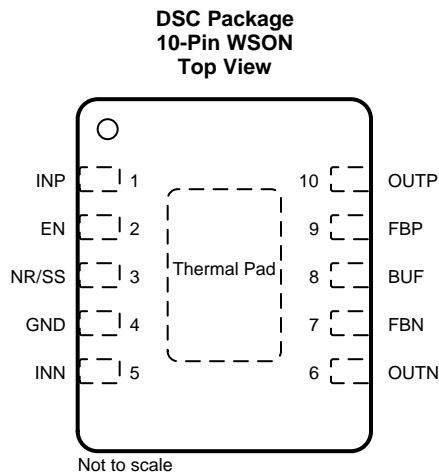

Pin Functions

PIN		I/O	DESCRIPTION
NO.	NAME		
1	INP	I	Positive input. A 10- $\mu\text{F}^{(1)}$ or larger capacitor must be tied from this pin to ground to ensure stability. Place the input capacitor as close to the input as possible; see the Capacitor Recommendations section for more information.
2	EN	I	Enable pin. Driving this pin to logic high ($V_{\text{EN}} \geq V_{\text{IH(EN)}}$) enables the device; driving this pin to logic low ($V_{\text{EN}} \leq V_{\text{IL(EN)}}$) disables the device. If enable functionality is not required, this pin must be connected to INP; see the Application and Implementation section for more detail. The enable voltage cannot exceed the input voltage ($V_{\text{EN}} \leq V_{\text{INP}}$).
3	NR/SS	—	Noise-reduction, soft-start pin. Connecting an external capacitor between this pin and ground reduces reference voltage noise and enables soft-start and start-up tracking. A 10-nF or larger capacitor ($C_{\text{NR/SS}}$) is recommended to be connected from NR/SS to GND to maximize or optimize ac performance and to ensure start-up tracking. This pin can also be driven externally to provide greater output voltage accuracy and lower noise, see the User-Settable Buffered Reference section for more information.
4	GND	—	Ground pin. This pin must be connected to ground and the thermal pad with a low-impedance connection.
5	INN	I	Negative input. A 10- $\mu\text{F}^{(1)}$ or larger capacitor must be tied from this pin to ground to ensure stability. Place the input capacitor as close to the input as possible; see the Capacitor Recommendations section for more information.
6	OUTN	O	Negative output. A 10- $\mu\text{F}^{(1)}$ or larger capacitor must be tied from this pin to ground to ensure stability. Place the output capacitor as close to the output as possible; see the Capacitor Recommendations section for more information.
7	FBN	I	Negative output feedback pin. This pin is used to set the negative output voltage. Although not required, a 10-nF feed-forward capacitor from FBN to OUTN (as close to the device as possible) is recommended to maximize ac performance. Nominally this pin is regulated to V_{FBN} . Do not connect to ground.
8	BUF	O	Buffered reference output. This pin is connected to FBN through R_2 and the voltage at this node is inverted and scaled up by the negative feedback network to provide the desired output voltage. The buffered reference can be used to drive external circuits, and has a 1-mA maximum load.
9	FBP	I	Positive output feedback pin. This pin is used to set the positive output voltage. Although not required, a 10-nF feed-forward capacitor from FBP to OUTP (as close to the device as possible) is recommended to maximize ac performance. Nominally this pin is regulated to V_{FBP} . Do not connect this pin directly to ground.
10	OUTP	O	Positive output. A 10- $\mu\text{F}^{(1)}$ or larger capacitor must be tied from this pin to ground to ensure stability. Place the output capacitor as close to the output as possible; see the Capacitor Recommendations section for more information.
Pad	Thermal Pad	—	Connect the thermal pad to a large-area ground plane. The thermal pad is internally connected to GND.

(1) The nominal input and output capacitance must be greater than 2.2 μF ; throughout this document the nominal derating on these capacitors is 80%. Take care to ensure that the effective capacitance at the pin is greater than 2.2 μF .

6 Specifications

6.1 Absolute Maximum Ratings

 over operating junction temperature range (unless otherwise noted)⁽¹⁾⁽²⁾

		MIN	MAX	UNIT
Voltage	INP	-0.3	36	V
	INN	-36	0.3	
	OUTP	-0.3	$V_{INP} + 0.3^{(3)}$	
	OUTN	$V_{INN} - 0.3^{(4)}$	0.3	
	FBP	-0.3	$V_{INP} + 0.3^{(5)}$	
	BUF	-1	$V_{INP} + 0.3^{(5)}$	
	NR/SS	-0.3	$V_{INP} + 0.3^{(6)}$	
	FBN	$V_{INN} - 0.3^{(7)}$	0.3	
	EN	-0.3	$V_{INP} + 0.3^{(8)}$	
Current	Output current	Internally limited		
	Buffer current		2	mA
Temperature	Operating junction temperature, T_J	-55	150	°C
	Storage, T_{stg}	-65	150	

- (1) Stresses beyond those listed under *Absolute Maximum Ratings* may cause permanent damage to the device. These are stress ratings only, which do not imply functional operation of the device at these or any other conditions beyond those indicated under *Recommended Operating Conditions*. Exposure to absolute-maximum-rated conditions for extended periods may affect device reliability.
- (2) All voltages with respect to the ground pin, unless otherwise noted.
- (3) The absolute maximum rating is $V_{INP} + 0.3$ V or 33 V, whichever is smaller.
- (4) The absolute maximum rating is $V_{INN} - 0.3$ V or -33 V, whichever is greater.
- (5) The absolute maximum rating is $V_{INP} + 0.3$ V or 3 V, whichever is smaller.
- (6) The absolute maximum rating is $V_{INP} + 0.3$ V or 2 V, whichever is smaller.
- (7) The absolute maximum rating is $V_{INN} - 0.3$ V or -3 V, whichever is greater.
- (8) The absolute maximum rating is $V_{INP} + 0.3$ V or 36 V, whichever is smaller.

6.2 ESD Ratings

		VALUE	UNIT
V_{ESD}	Electrostatic discharge	Human-body model (HBM), per ANSI/ESDA/JEDEC JS-001 ⁽¹⁾	±1000
		Charged-device model (CDM), per JEDEC specification JESD22-C101 ⁽²⁾	±500

- (1) JEDEC document JEP155 states that 500-V HBM allows safe manufacturing with a standard ESD control process.
- (2) JEDEC document JEP157 states that 250-V CDM allows safe manufacturing with a standard ESD control process.

6.3 Recommended Operating Conditions

over operating free-air temperature range (unless otherwise noted)

		MIN	NOM	MAX	UNIT
V _{INX}	Supply voltage magnitude for either regulator	3.3		33	V
V _{EN}	Enable supply voltage	0		V _{INP}	V
V _{OUTP}	Positive regulated output voltage range	V _{FBP}		30	V
V _{OUTN}	Negative regulated output voltage range	–30		V _{FBN}	V
I _{OUTX}	Output current for either regulator	0.005 ⁽¹⁾		150	mA
I _{BUF}	Output current from the BUF pin	0	120	1000	μA
C _{INX}	Input capacitor for either regulator	4.7	10 ⁽²⁾		μF
C _{OUTX}	Output capacitor for either regulator	4.7	10 ⁽²⁾		μF
C _{NR/SS}	Noise-reduction and soft-start capacitor	0 ⁽³⁾	10	1000	nF
C _{FFP}	Positive channel feed-forward capacitor; connect from V _{OUTP} to FBP	0	10	100	nF
C _{FFN}	Negative channel feed-forward capacitor; connect from V _{OUTN} to FBN	0	10	100	nF
R _{2P}	Lower positive feedback resistor		10	240	kΩ
R _{2N}	Lower negative feedback resistor (from FBN to BUF)		10	240	kΩ
T _J	Operating junction temperature	–40		125	°C

- (1) Minimum load required when feedback resistors are not used. If feedback resistors are used, keeping R_{2x} below 240 kΩ satisfies this requirement.
- (2) The nominal input and output capacitor value of 10-μF accounts for the derating factors that apply to X5R and X7R ceramic capacitors. The assumed overall derating is 80%.
- (3) For startup tracking to function correctly a minimum 4.7-nF C_{NR/SS} capacitor must be used.

6.4 Thermal Information

THERMAL METRIC ⁽¹⁾	TPS7A39		UNIT
	DSC (WSON)		
	10 PINS		
R _{θJA}	Junction-to-ambient thermal resistance	44.4	°C/W
R _{θJC(top)}	Junction-to-case(top) thermal resistance	33.7	°C/W
R _{θJB}	Junction-to-board thermal resistance	19.4	°C/W
ψ _{JT}	Junction-to-top characterization parameter	0.4	°C/W
ψ _{JB}	Junction-to-board characterization parameter	19.5	°C/W
R _{θJC(bot)}	Junction-to-case(bottom) thermal resistance	2.9	°C/W

- (1) For more information about traditional and new thermal metrics, see the [Semiconductor and IC Package Thermal Metrics](#) application report.

6.5 Electrical Characteristics

at $T_J = -40^\circ\text{C}$ to $+125^\circ\text{C}$, $V_{INP(nom)} = V_{OUTP(nom)} + 1\text{ V}$ or $V_{IN(nom)} = 3.3\text{ V}$ (whichever is greater), $V_{INN(nom)} = V_{OUTN(nom)} - 1\text{ V}$ or $V_{INN(nom)} = -3.3\text{ V}$ (whichever is less), $V_{EN} = V_{INP}$, $I_{OUT} = 1\text{ mA}$, $C_{INX} = 2.2\text{ }\mu\text{F}$, $C_{OUTX} = 10\text{ }\mu\text{F}$, $C_{FFX} = C_{NR/SS} = \text{open}$, $R_{1N} = R_{2N} = 10\text{ k}\Omega$, and FBP tied to OOTP (unless otherwise noted); typical values are at $T_J = 25^\circ\text{C}$

PARAMETER		TEST CONDITIONS	MIN	TYP	MAX	UNIT	
V_{INP}	Input voltage range, positive channel		3.3		33	V	
V_{INN}	Input voltage range, negative channel		-33		-3.3	V	
$V_{UVLOP(rising)}$	Undervoltage lockout threshold, positive channel	V_{INP} rising, $V_{INN} = -3.3\text{ V}$	1.4		3.1	V	
$V_{UVLOP(hys)}$	Undervoltage lockout threshold, positive channel hysteresis	V_{INP} falling, $V_{INN} = -3.3\text{ V}$		120		mV	
$V_{UVLON(falling)}$	Undervoltage lockout threshold, negative channel	V_{INN} falling, $V_{INP} = 3.3\text{ V}$	-3.1		-1.4	V	
$V_{UVLON(hys)}$	Undervoltage lockout threshold, negative channel, hysteresis	V_{INN} rising, $V_{INP} = 3.3\text{ V}$		70		mV	
$V_{NR/SS}$	Internal reference voltage		1.172	1.19	1.208	V	
V_{FBP}	Positive feedback voltage		1.170	1.188	1.206	V	
V_{FBN}	Negative feedback voltage		-10	3.7	10	mV	
V_{OUT}	Output voltage range ⁽¹⁾	Positive channel	V_{FBP}		30	V	
		Negative channel	-30		V_{FBN} ⁽²⁾		
	V_{OUTP} accuracy	$V_{INP(nom)} \leq V_{INP} \leq 33\text{ V}$, $1\text{ mA} \leq I_{OUTP} \leq 150\text{ mA}$, $1.2\text{ V} \leq V_{OUTP(nom)} \leq 30\text{ V}$	-1.5		1.5	% V_{OUT}	
	V_{OUTN} accuracy ⁽³⁾	$-33\text{ V} \leq V_{INN} \leq V_{INN(nom)}$, $-150\text{ mA} \leq I_{OUTN} \leq -1\text{ mA}$, $-30\text{ V} \leq V_{OUTN(nom)} \leq -1.2\text{ V}$	-3		3	% V_{OUT}	
Negative V_{OUT} channel accuracy		$-33\text{ V} \leq V_{INN} \leq V_{INN(nom)}$, $-150\text{ mA} \leq I_{OUTN} \leq 1\text{ mA}$, $-1.2\text{ V} < V_{OUTN(nom)} < 0\text{ V}$	-36		36	mV	
		$-33\text{ V} \leq V_{INN} \leq V_{INN(nom)}$, $-150\text{ mA} \leq I_{OUTN} \leq 1\text{ mA}$, $V_{OUTN(nom)} = 0\text{ V}$	-12		12		
$\Delta V_{OUT}(\Delta V_{IN}) / V_{OUT(NOM)}$	Line regulation, positive channel	$V_{INP(nom)} \leq V_{INP} \leq 33\text{ V}$		0.035		% V_{OUT}	
	Line regulation, negative channel	$-33\text{ V} \leq V_{INN} \leq V_{OUT(nom)} + 1\text{ V}$		0.125			
$\Delta V_{OUT}(\Delta I_{OUT}) / V_{OUT(NOM)}$	Load regulation, positive channel	$1\text{ mA} \leq I_{OUTP} \leq 150\text{ mA}$		-0.09		% V_{OUT}	
	Load regulation, negative channel	$-150\text{ mA} \leq I_{OUTN} \leq -1\text{ mA}$		0.715			
V_{DO}	Dropout voltage	Positive channel	$I_{OUTP} = 50\text{ mA}$, $3.3\text{ V} \leq V_{INP(nom)} \leq 33.0\text{ V}$, $V_{FBP} = 1.070\text{ V}$	175	300	mV	
			$I_{OUTP} = 150\text{ mA}$, $3.3\text{ V} \leq V_{INP(nom)} \leq 33.0\text{ V}$, $V_{FBP} = 1.070\text{ V}$	300	500		
		Negative channel	$I_{OUTN} = -50\text{ mA}$, $-3.3\text{ V} \leq V_{INN(nom)} \leq -33.0\text{ V}$, $V_{FBN} = 0.0695\text{ V}$	-250	-145		
			$I_{OUTN} = -150\text{ mA}$, $-3.3\text{ V} \leq V_{INN(nom)} \leq -33.0\text{ V}$, $V_{FBN} = 0.0695\text{ V}$	-400	-275		
V_{BUF}	Buffered reference output voltage			$V_{NR/SS}$		V	
V_{BUF}/I_{BUF}	Buffered reference load regulation	$I_{BUF} = 100\text{ }\mu\text{A}$ to 1 mA		1		mV/mA	
$V_{BUF} - V_{NR/SS}$	Output buffer offset voltage	$V_{NR/SS} = 0.25\text{ V}$ to 1.2 V	-4	3	8	mV	
$V_{OUTP} - V_{OUTN}$	DC output voltage difference with a forced REF voltage	$V_{NR/SS} = 0.25\text{ V}$ to 1.2 V	-10		10	% $V_{NR/SS}$	
I_{LIM}	Current limit	Positive channel	$V_{OUTP} = 90\% V_{OUTP(nom)}$	200	330	500	mA
		Negative channel	$V_{OUTN} = 90\% V_{OUTN(nom)}$	-500	-300	-200	
I_{SUPPLY}	Supply current	Positive channel	$I_{OUTP} = 0\text{ mA}$, $R_{2N} = \text{open}$, $V_{INP} = 33\text{ V}$	75	150	μA	
			$I_{OUTP} = 150\text{ mA}$, $R_{2N} = \text{open}$, $V_{INP} = 33\text{ V}$	904			
		Negative channel	$I_{OUTN} = 0\text{ mA}$, $V_{OUTN(nom)} = 0\text{ V}$, $R_{2N} = \text{open}$, $V_{INN} = -33\text{ V}$	-150	-60		
			$I_{OUTN} = 150\text{ mA}$, $R_{2N} = \text{open}$, $V_{INN} = -33\text{ V}$	-1053			
I_{SHDN}	Shutdown supply current	Positive channel	$V_{EN} = 0.4\text{ V}$, $V_{INP} = 33\text{ V}$	3.75	6.5	μA	
		Negative channel	$V_{EN} = 0.4\text{ V}$, $V_{INN} = -33\text{ V}$	-4.5	-2.25		

- (1) To ensure V_{OUT} does not drift up while the device is disabled, a minimum load current of $5\text{ }\mu\text{A}$ is required.
- (2) $V_{OUT(target)} = 0\text{ V}$, $R_{1N} = 10\text{ k}\Omega$, $R_{2N} = \text{open}$.
- (3) The device is not tested under conditions where the power dissipated across the device, P_D , exceeds 2 W .

Electrical Characteristics (continued)

at $T_J = -40^\circ\text{C}$ to $+125^\circ\text{C}$, $V_{\text{INP(nom)}} = V_{\text{OUTP(nom)}} + 1\text{ V}$ or $V_{\text{IN(nom)}} = 3.3\text{ V}$ (whichever is greater), $V_{\text{INN(nom)}} = V_{\text{OUTN(nom)}} - 1\text{ V}$ or $V_{\text{INN(nom)}} = -3.3\text{ V}$ (whichever is less), $V_{\text{EN}} = V_{\text{INP}}$, $I_{\text{OUT}} = 1\text{ mA}$, $C_{\text{INx}} = 2.2\text{ }\mu\text{F}$, $C_{\text{OUTx}} = 10\text{ }\mu\text{F}$, $C_{\text{FFx}} = C_{\text{NR/SS}} = \text{open}$, $R_{1\text{N}} = R_{2\text{N}} = 10\text{ k}\Omega$, and FBP tied to OOTP (unless otherwise noted); typical values are at $T_J = 25^\circ\text{C}$

PARAMETER		TEST CONDITIONS	MIN	TYP	MAX	UNIT
I_{FBx}	Feedback pin leakage current	Positive channel		5.5	100	nA
		Negative channel	-100	-9.7		
$I_{\text{NR/SS}}$	Soft-start charging current	$V_{\text{NR/SS}} = 0.9\text{ V}$	3	5.1	6.7	μA
I_{EN}	Enable pin leakage current	$V_{\text{EN}} = V_{\text{INP}} = 33\text{ V}$		0.02	1	μA
$V_{\text{IH(EN)}}$	Enable high-level voltage		2.2		V_{INP}	V
$V_{\text{IL(EN)}}$	Enable low-level voltage		0		0.4	V
PSRR	Power-supply rejection ratio	$ V_{\text{IN}} = 6\text{ V}$, $ V_{\text{OUT(nom)}} = 5\text{ V}$, $C_{\text{OUT}} = 10\text{ }\mu\text{F}$, $C_{\text{NR/SS}} = C_{\text{FF}} = 10\text{ nF}$, $f = 120\text{ Hz}$		69		dB
V_n	Output noise voltage	Positive channel	$V_{\text{INP}} = 3.3\text{ V}$, $V_{\text{OUTP(nom)}} = V_{\text{NR/SS}}$, $C_{\text{OUTP}} = 10\text{ }\mu\text{F}$, $C_{\text{NR/SS}} = 10\text{ nF}$, $\text{BW} = 10\text{ Hz to }100\text{ kHz}$		20.63	μV_{RMS}
			$V_{\text{INP}} = 6\text{ V}$, $V_{\text{OUTP(nom)}} = 5\text{ V}$, $C_{\text{OUTP}} = 10\text{ }\mu\text{F}$, $C_{\text{NR/SS}} = C_{\text{FF}} = 10\text{ nF}$, $\text{BW} = 10\text{ Hz to }100\text{ kHz}$		26.86	
		Negative channel	$V_{\text{INN}} = -3\text{ V}$, $V_{\text{OUTN(nom)}} = -V_{\text{NR/SS}}$, $C_{\text{OUTN}} = 10\text{ }\mu\text{F}$, $C_{\text{NR/SS}} = 10\text{ nF}$, $\text{BW} = 10\text{ Hz to }100\text{ kHz}$		22.13	
			$V_{\text{INN}} = -6\text{ V}$, $V_{\text{OUTN(nom)}} = -5\text{ V}$, $C_{\text{OUTN}} = 10\text{ }\mu\text{F}$, $C_{\text{NR/SS}} = C_{\text{FF}} = 10\text{ nF}$, $\text{BW} = 10\text{ Hz to }100\text{ kHz}$		28.68	
$R_{\text{NR/SS}}$	Filter resistor from band gap to NR pin			350		k Ω
T_{sd}	Thermal shutdown temperature	Shutdown, temperature increasing		175		$^\circ\text{C}$
		Reset, temperature decreasing		160		

6.6 Startup Characteristics

at $T_J = -40^\circ\text{C}$ to $+125^\circ\text{C}$, $V_{\text{INP(nom)}} = V_{\text{OUTP(nom)}} + 1\text{ V}$ or $V_{\text{IN(nom)}} = 3.3\text{ V}$ (whichever is greater), $V_{\text{INN(nom)}} = V_{\text{OUTN(nom)}} - 1\text{ V}$ or $V_{\text{INN(nom)}} = -3.3\text{ V}$ (whichever is less), $V_{\text{EN}} = V_{\text{INP}}$, $I_{\text{OUT}} = 1\text{ mA}$, $C_{\text{INx}} = 2.2\text{ }\mu\text{F}$, $C_{\text{OUTx}} = 10\text{ }\mu\text{F}$, $C_{\text{FFx}} = C_{\text{NR/SS}} = 4.7\text{ nF}$, $R_{1\text{N}} = R_{2\text{N}} = 10\text{ k}\Omega$, and FBP tied to OOTP (unless otherwise noted); typical values are at $T_J = 25^\circ\text{C}$

PARAMETER		TEST CONDITIONS	MIN	TYP	MAX	UNIT
$t_{\text{EN(delay)}}$	Delay time from EN low-to-high transition to 2.5% V_{OUTP}	From EN low-to-high transition to $V_{\text{OUTP}} = 2.5\% \times V_{\text{OUTP(nom)}}$		300		μs
$t_{\text{start-up}}$	Delay time from EN low-to-high transition to both outputs reaching 95% of final value	From EN low-to-high transition to $V_{\text{OUTP}} = V_{\text{OUTP(nom)}} \times 95\%$ and $V_{\text{OUTN}} = V_{\text{OUTN(nom)}} \times 95\%$		1.1		ms
$t_{\text{Pstart-Nstart}}$	Delay time from V_{OUTP} leaving a high-impedance state to V_{OUTN} leaving a high-impedance state	From $V_{\text{OUTP}} = V_{\text{OUTP(nom)}} \times 2.5\%$ to $V_{\text{OUTN}} = V_{\text{OUTN(nom)}} \times 2.5\%$	-40	-17	40	μs
$\Delta V_{\text{OUTP}} - V_{\text{OUTN}} $	Voltage difference between the positive and negative output	During $t_{\text{Pstart-Nstart}}$		75	300	mV

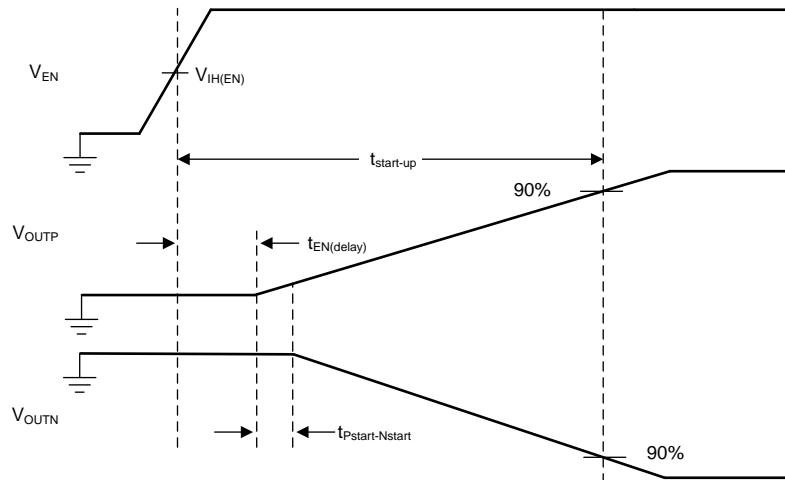

NOTE: Slow ramps ($t_{rise(V_{INX})} > 10$ ms typically) on V_{INX} with EN tied to V_{INP} does not meet the tracking specification. Use a resistor divider from V_{INP} to EN for these applications.

1. Start-Up Characteristics

6.7 Typical Characteristics

at $T_J = 25^\circ\text{C}$, $V_{INP} = V_{OUTP(nom)} + 1.0\text{ V}$ or $V_{IN} = 3.3\text{ V}$ (whichever is greater), $V_{INN} = V_{OUTN(nom)} - 1\text{ V}$ or -3.3 V (whichever is less), $V_{EN} = V_{IN}$, $I_{OUT} = 1\text{ mA}$, $C_{IN} = 10\text{-}\mu\text{F}$ ceramic, $C_{OUT} = 10\text{-}\mu\text{F}$ ceramic, and $C_{FFP} = C_{FFN} = C_{NR/SS} = 10\text{ nF}$ (unless otherwise noted)

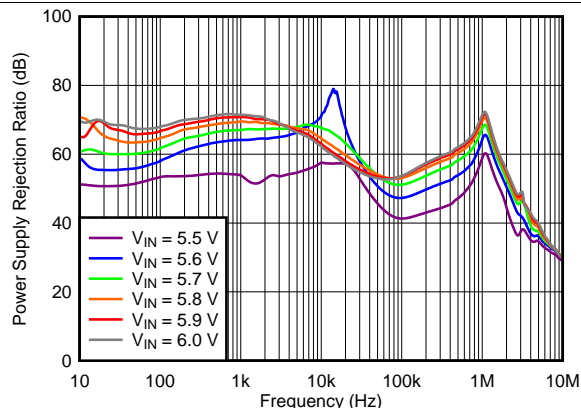

$V_{OUTP} = 5\text{ V}$, $I_{OUTP} = 150\text{ mA}$, $V_{OUTN} = -5\text{ V}$, $I_{OUTN} = 0\text{ mA}$,
 $C_{NR/SS} = C_{FFx} = 10\text{ nF}$

图 2. Positive PSRR vs Frequency and V_{INP}

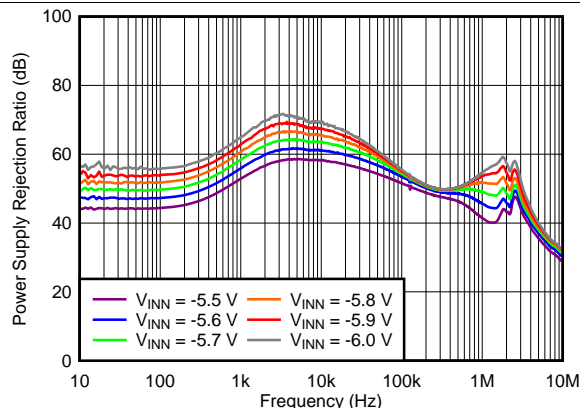

$V_{OUTP} = 5\text{ V}$, $I_{OUTP} = 0\text{ mA}$, $V_{OUTN} = -5\text{ V}$, $I_{OUTN} = 150\text{ mA}$,
 $C_{NR/SS} = C_{FFx} = 10\text{ nF}$

图 3. Negative PSRR vs Frequency and V_{INN}

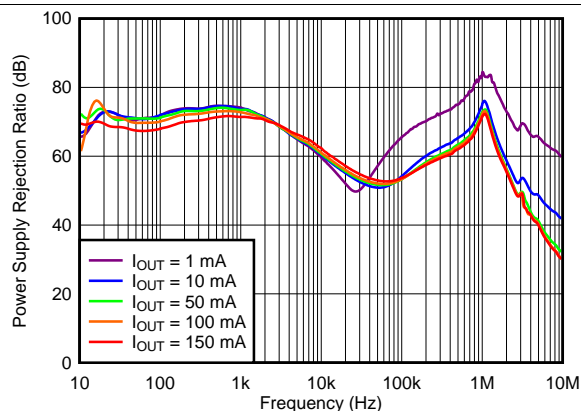

$V_{OUTP} = 5\text{ V}$, $V_{INP} = V_{EN} = 6\text{ V}$, $V_{OUTN} = -5\text{ V}$, $I_{OUTN} = 0\text{ mA}$,
 $C_{NR/SS} = C_{FFx} = 10\text{ nF}$

图 4. Positive PSRR vs Frequency and I_{OUTP}

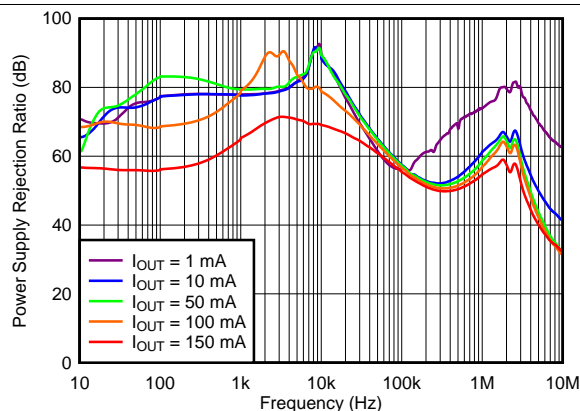

$V_{OUTP} = 5\text{ V}$, $I_{OUTP} = 0\text{ mA}$, $V_{INN} = -6\text{ V}$, $V_{OUTN} = -5\text{ V}$,
 $C_{NR/SS} = C_{FFx} = 10\text{ nF}$

图 5. Negative PSRR vs Frequency and I_{OUTN}

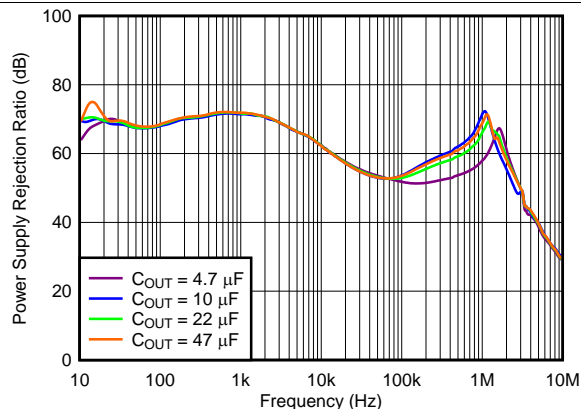

$V_{OUTP} = 5\text{ V}$, $V_{INP} = V_{EN} = 6\text{ V}$, $V_{OUTN} = -5\text{ V}$, $I_{OUTN} = 0\text{ mA}$,
 $C_{NR/SS} = C_{FFx} = 10\text{ nF}$

图 6. Positive PSRR vs Frequency and C_{OUTP}

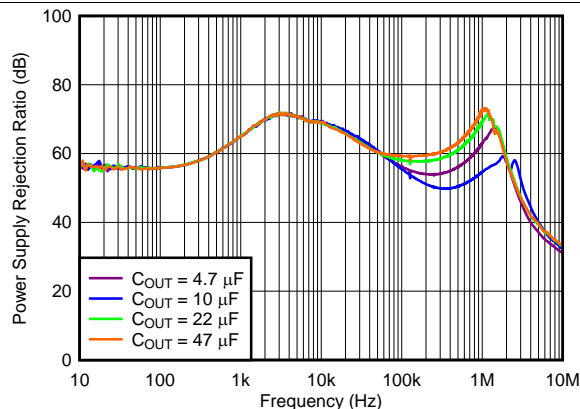

$V_{OUTP} = 5\text{ V}$, $I_{OUTP} = 0\text{ mA}$, $V_{INN} = -6\text{ V}$, $V_{OUTN} = -5\text{ V}$,
 $C_{NR/SS} = C_{FFx} = 10\text{ nF}$, $C_{OUTP} = 10\text{ }\mu\text{F}$

图 7. Negative PSRR vs Frequency and C_{OUTN}

Typical Characteristics (continued)

at $T_J = 25^\circ\text{C}$, $V_{INP} = V_{OUTP(nom)} + 1.0\text{ V}$ or $V_{IN} = 3.3\text{ V}$ (whichever is greater), $V_{INN} = V_{OUTN(nom)} - 1\text{ V}$ or -3.3 V (whichever is less), $V_{EN} = V_{IN}$, $I_{OUT} = 1\text{ mA}$, $C_{IN} = 10\text{-}\mu\text{F}$ ceramic, $C_{OUT} = 10\text{-}\mu\text{F}$ ceramic, and $C_{FFP} = C_{FFN} = C_{NR/SS} = 10\text{ nF}$ (unless otherwise noted)

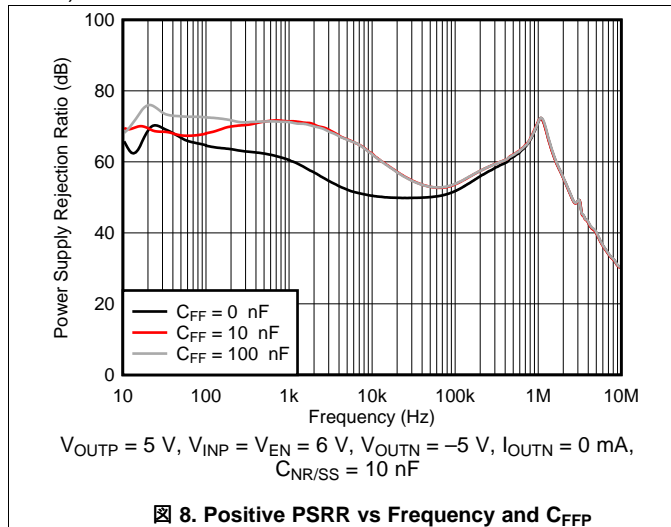

8. Positive PSRR vs Frequency and C_{FFP}

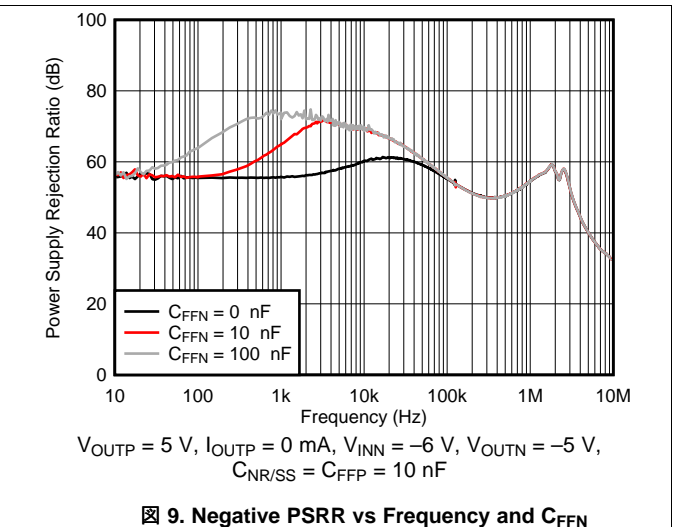

9. Negative PSRR vs Frequency and C_{FFN}

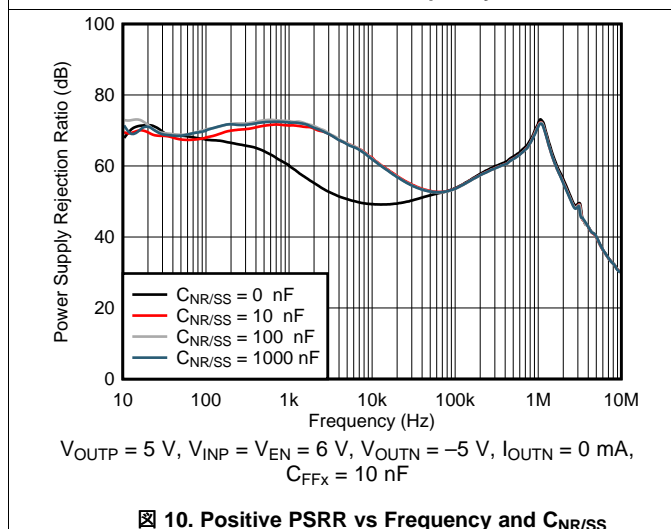

10. Positive PSRR vs Frequency and $C_{NR/SS}$

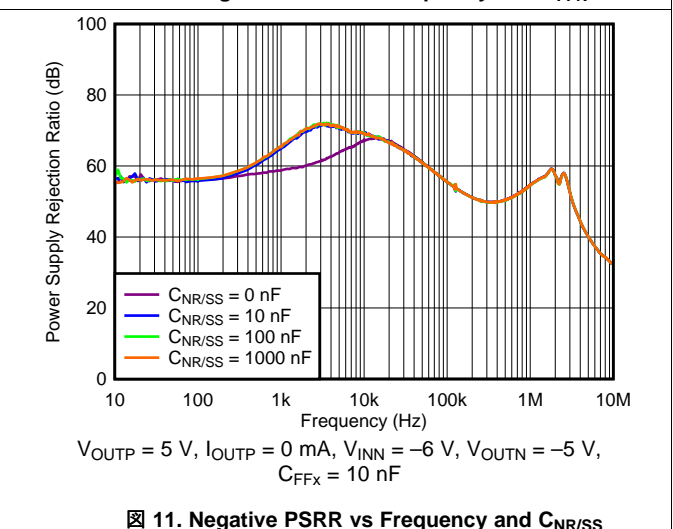

11. Negative PSRR vs Frequency and $C_{NR/SS}$

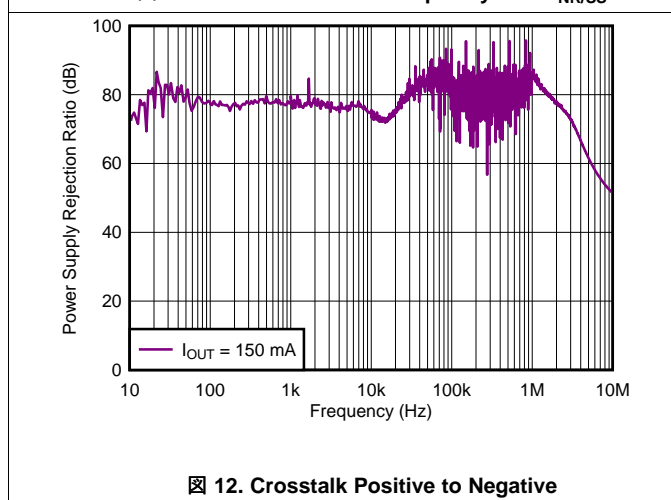

12. Crosstalk Positive to Negative

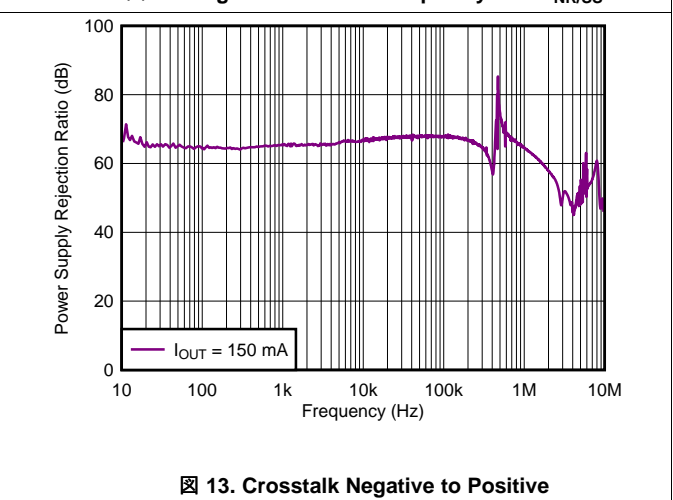

13. Crosstalk Negative to Positive

Typical Characteristics (continued)

at $T_J = 25^\circ\text{C}$, $V_{INP} = V_{OUTP(nom)} + 1.0\text{ V}$ or $V_{IN} = 3.3\text{ V}$ (whichever is greater), $V_{INN} = V_{OUTN(nom)} - 1\text{ V}$ or -3.3 V (whichever is less), $V_{EN} = V_{IN}$, $I_{OUT} = 1\text{ mA}$, $C_{IN} = 10\text{-}\mu\text{F}$ ceramic, $C_{OUT} = 10\text{-}\mu\text{F}$ ceramic, and $C_{FFP} = C_{FFN} = C_{NR/SS} = 10\text{ nF}$ (unless otherwise noted)

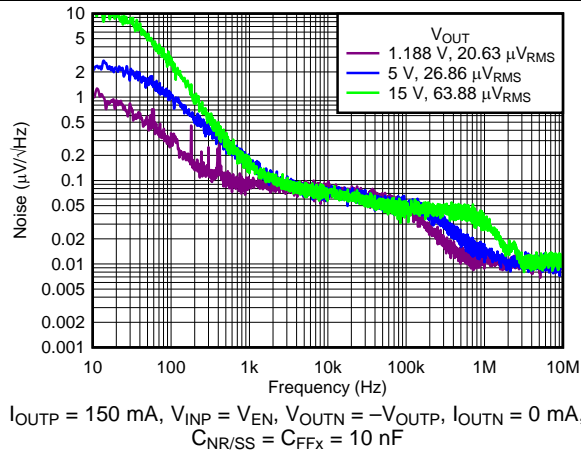

Fig 14. Positive Spectral Noise Density vs Frequency and V_{OUTP}

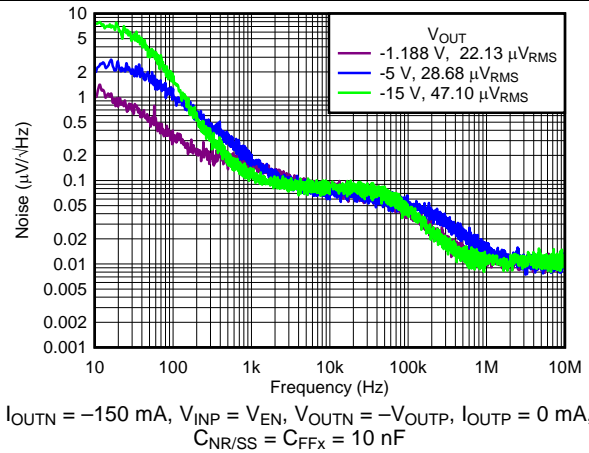

Fig 15. Negative Spectral Noise Density vs Frequency and V_{OUTN}

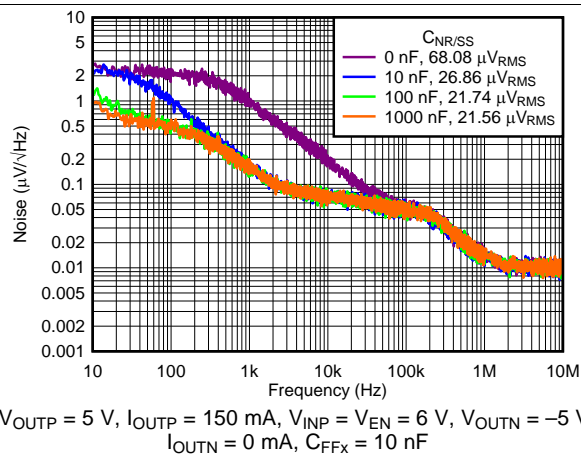

Fig 16. Positive Spectral Noise Density vs Frequency and $C_{NR/SS}$

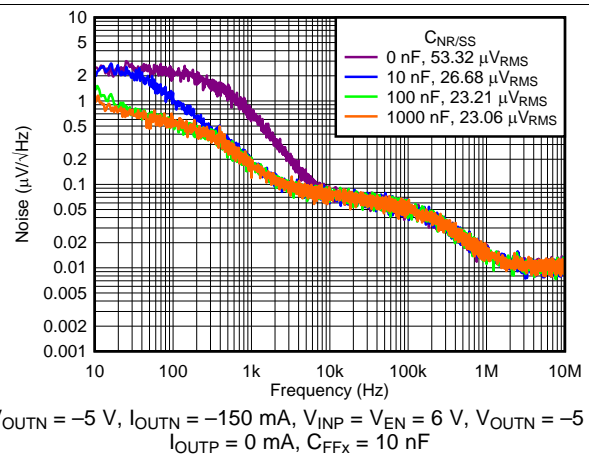

Fig 17. Negative Spectral Noise Density vs Frequency and $C_{NR/SS}$

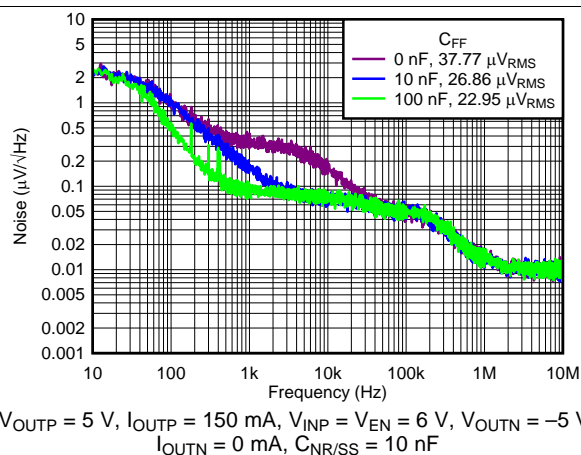

Fig 18. Positive Spectral Noise Density vs Frequency and C_{FFP}

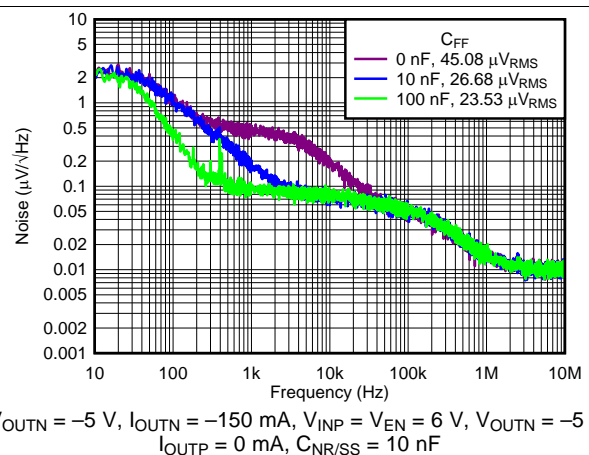
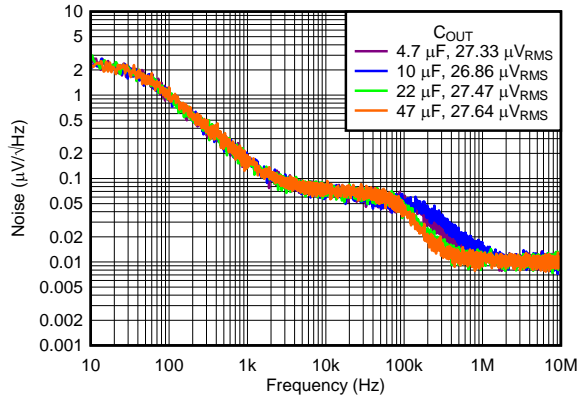

Fig 19. Negative Spectral Noise Density vs Frequency and C_{FFN}

Typical Characteristics (continued)

at $T_J = 25^\circ\text{C}$, $V_{INP} = V_{OUTP(nom)} + 1.0\text{ V}$ or $V_{IN} = 3.3\text{ V}$ (whichever is greater), $V_{INN} = V_{OUTN(nom)} - 1\text{ V}$ or -3.3 V (whichever is less), $V_{EN} = V_{IN}$, $I_{OUT} = 1\text{ mA}$, $C_{IN} = 10\text{-}\mu\text{F}$ ceramic, $C_{OUT} = 10\text{-}\mu\text{F}$ ceramic, and $C_{FFP} = C_{FFN} = C_{NR/SS} = 10\text{ nF}$ (unless otherwise noted)



$V_{OUTP} = 5\text{ V}$, $I_{OUTP} = 150\text{ mA}$, $V_{INP} = V_{EN} = 6\text{ V}$, $V_{OUTN} = -5\text{ V}$, $I_{OUTN} = 0\text{ mA}$, $C_{NR/SS} = C_{FFX} = 10\text{ nF}$

Figure 20. Positive Spectral Noise Density vs Frequency and C_{OUT}

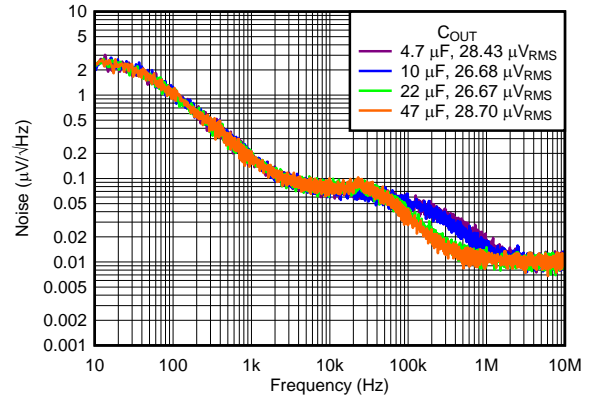

$V_{OUTN} = -5\text{ V}$, $I_{OUTN} = -150\text{ mA}$, $V_{INP} = V_{EN} = 6\text{ V}$, $V_{OUTN} = -5\text{ V}$, $I_{OUTP} = 0\text{ mA}$, $C_{NR/SS} = C_{FFX} = 10\text{ nF}$

Figure 21. Negative Spectral Noise Density vs Frequency and C_{OUT}

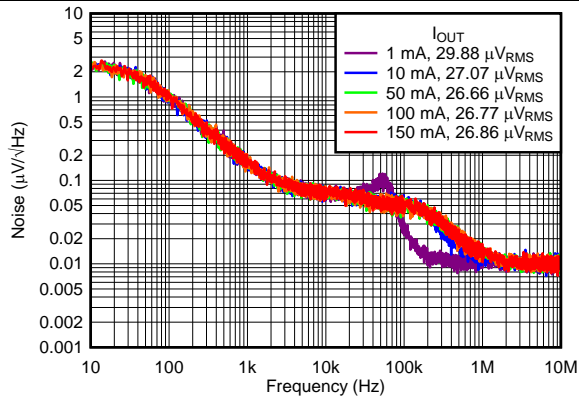

$V_{OUTP} = 5\text{ V}$, $V_{INP} = V_{EN} = 6\text{ V}$, $V_{OUTN} = -5\text{ V}$, $I_{OUTN} = 0\text{ mA}$, $C_{NR/SS} = C_{FFX} = 10\text{ nF}$

Figure 22. Positive Spectral Noise Density vs Frequency and I_{OUT}

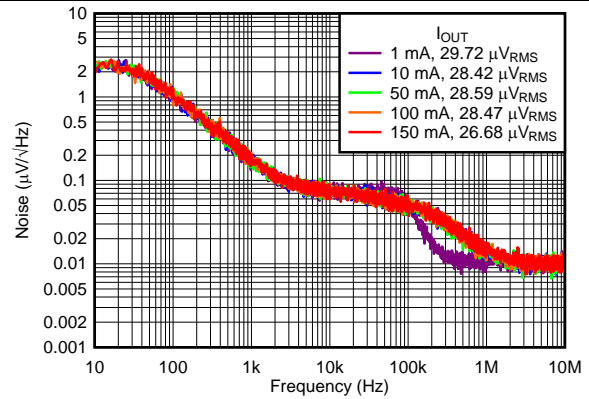

$V_{OUTN} = -5\text{ V}$, $V_{INP} = V_{EN} = 6\text{ V}$, $V_{OUTN} = -5\text{ V}$, $I_{OUTP} = 0\text{ mA}$, $C_{NR/SS} = C_{FFX} = 10\text{ nF}$

Figure 23. Negative Spectral Noise Density vs Frequency and I_{OUT}

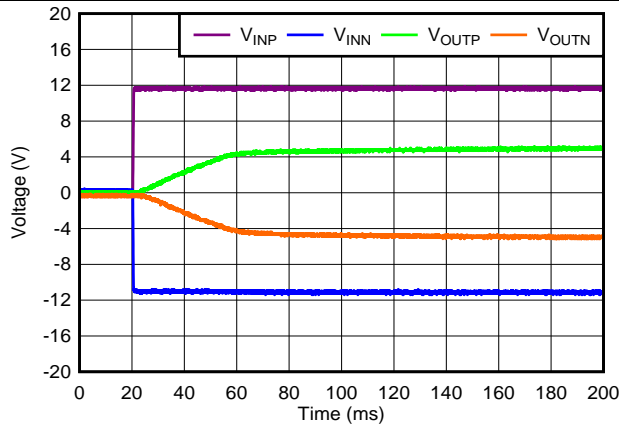

$V_{OUTP} = -V_{OUTN} = 5\text{ V}$, $V_{INP} = -V_{INN} = 12\text{ V}$

Figure 24. Startup ($V_{INP} = V_{EN}$)

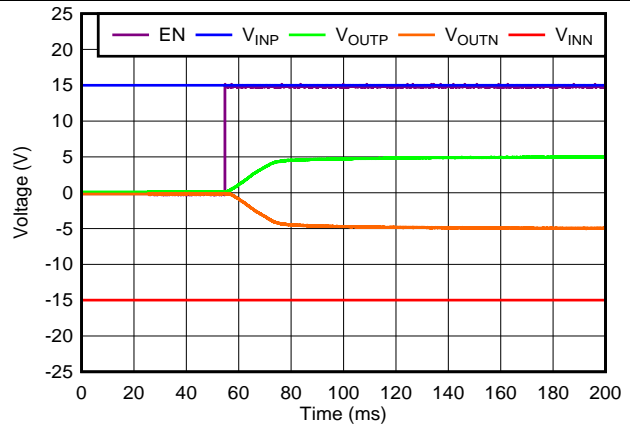

$V_{OUTP} = -V_{OUTN} = 5\text{ V}$, $V_{INP} = -V_{INN} = 15\text{ V}$

Figure 25. Startup With EN

Typical Characteristics (continued)

at $T_J = 25^\circ\text{C}$, $V_{INP} = V_{OUTP(nom)} + 1.0\text{ V}$ or $V_{IN} = 3.3\text{ V}$ (whichever is greater), $V_{INN} = V_{OUTN(nom)} - 1\text{ V}$ or -3.3 V (whichever is less), $V_{EN} = V_{IN}$, $I_{OUT} = 1\text{ mA}$, $C_{IN} = 10\text{-}\mu\text{F}$ ceramic, $C_{OUT} = 10\text{-}\mu\text{F}$ ceramic, and $C_{FFP} = C_{FFN} = C_{NR/SS} = 10\text{ nF}$ (unless otherwise noted)

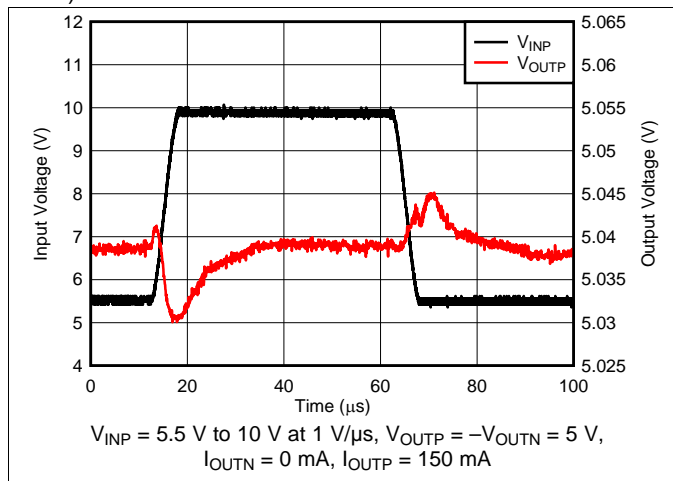

Figure 26. Line Transient Positive Regulator

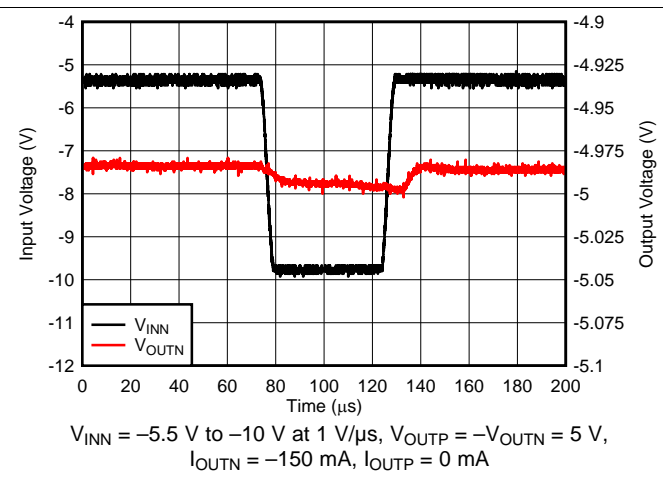

Figure 27. Line Transient Negative Regulator

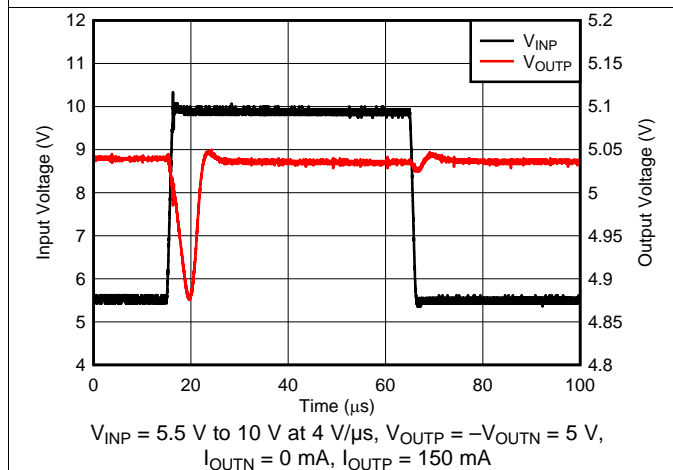

Figure 28. Line Transient Positive Regulator

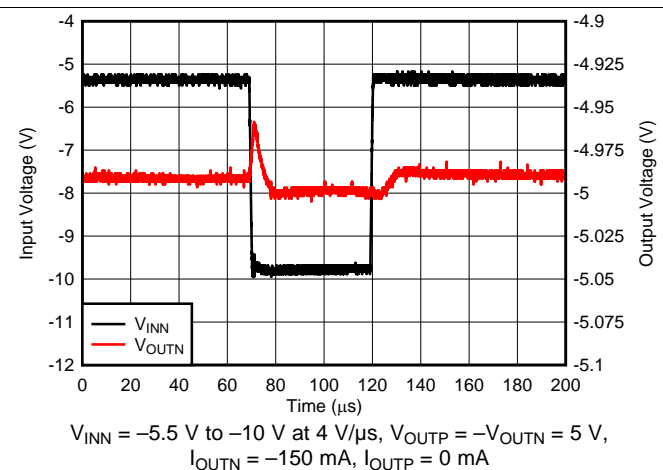

Figure 29. Line Transient Negative Regulator

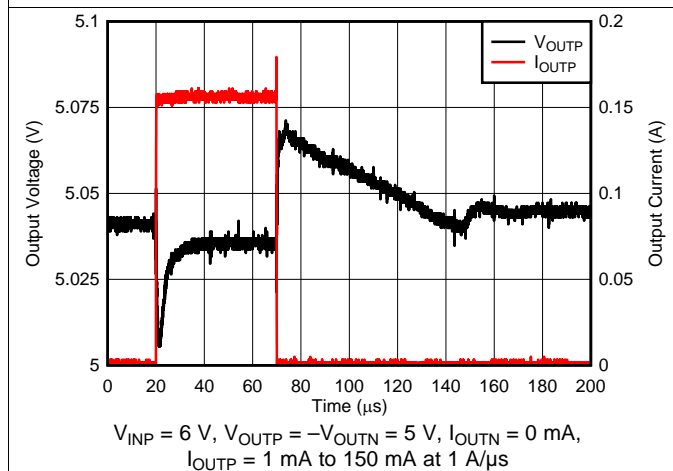

Figure 30. Load Transient Positive Regulator

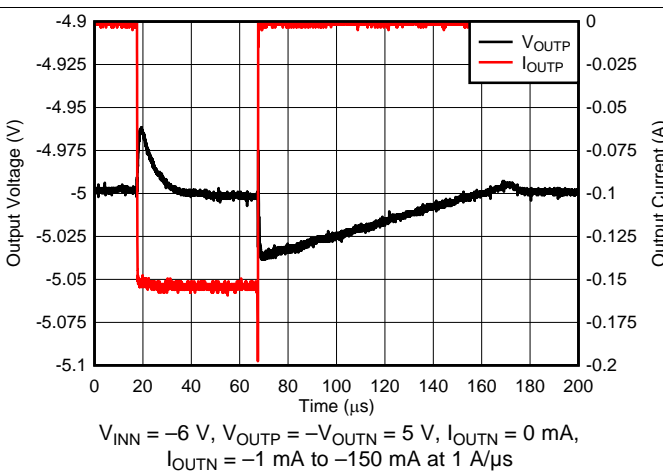
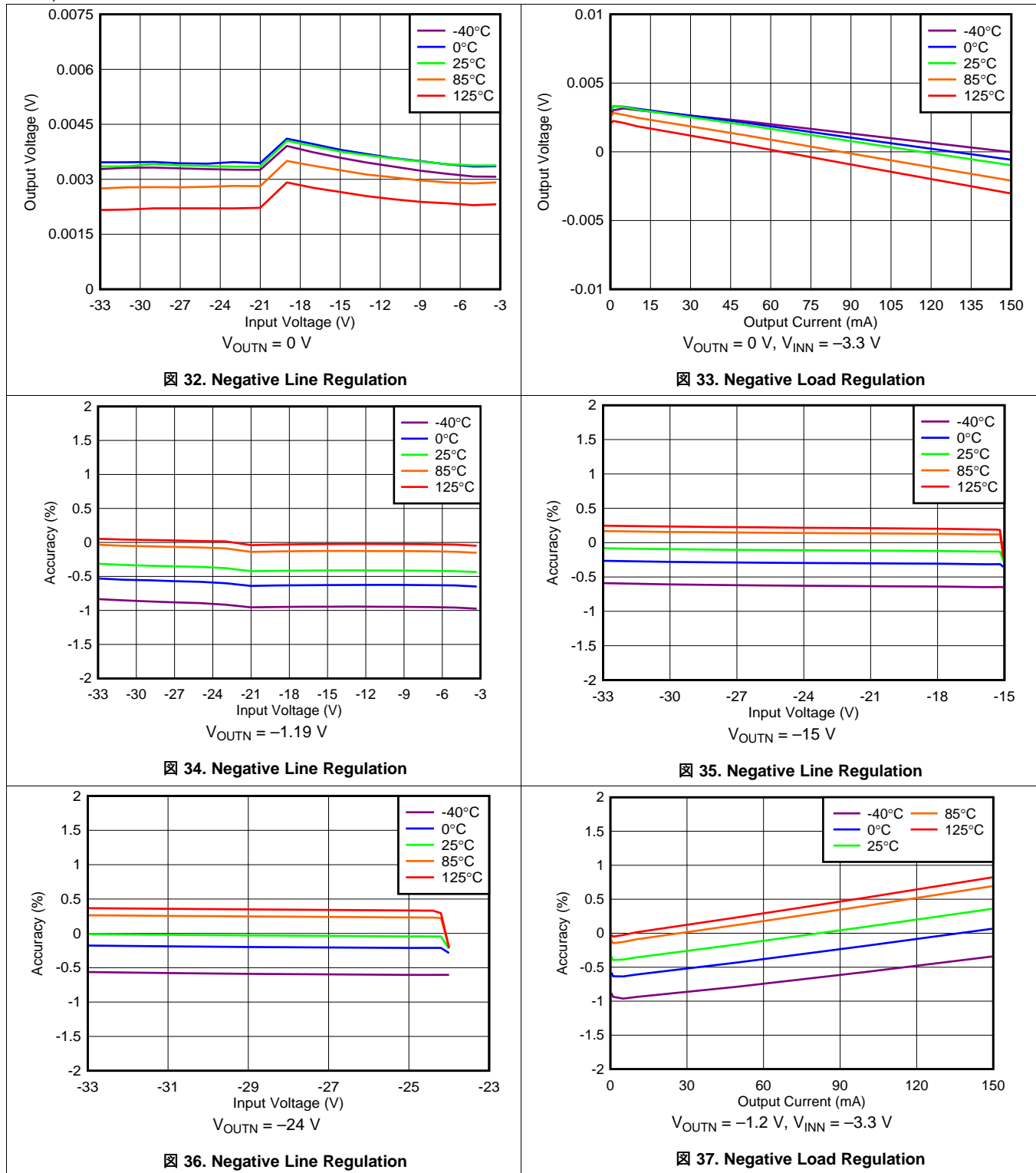

Figure 31. Load Transient Negative Regulator

Typical Characteristics (continued)

at $T_J = 25^\circ\text{C}$, $V_{INP} = V_{OUTP(nom)} + 1.0\text{ V}$ or $V_{IN} = 3.3\text{ V}$ (whichever is greater), $V_{INN} = V_{OUTN(nom)} - 1\text{ V}$ or -3.3 V (whichever is less), $V_{EN} = V_{IN}$, $I_{OUT} = 1\text{ mA}$, $C_{IN} = 10\text{-}\mu\text{F}$ ceramic, $C_{OUT} = 10\text{-}\mu\text{F}$ ceramic, and $C_{FFP} = C_{FFN} = C_{NR/SS} = 10\text{ nF}$ (unless otherwise noted)



Typical Characteristics (continued)

at $T_J = 25^\circ\text{C}$, $V_{INP} = V_{OUTP(nom)} + 1.0\text{ V}$ or $V_{IN} = 3.3\text{ V}$ (whichever is greater), $V_{INN} = V_{OUTN(nom)} - 1\text{ V}$ or -3.3 V (whichever is less), $V_{EN} = V_{IN}$, $I_{OUT} = 1\text{ mA}$, $C_{IN} = 10\text{-}\mu\text{F}$ ceramic, $C_{OUT} = 10\text{-}\mu\text{F}$ ceramic, and $C_{FFP} = C_{FFN} = C_{NR/SS} = 10\text{ nF}$ (unless otherwise noted)



图 38. Negative Load Regulation



图 39. Negative Load Regulation

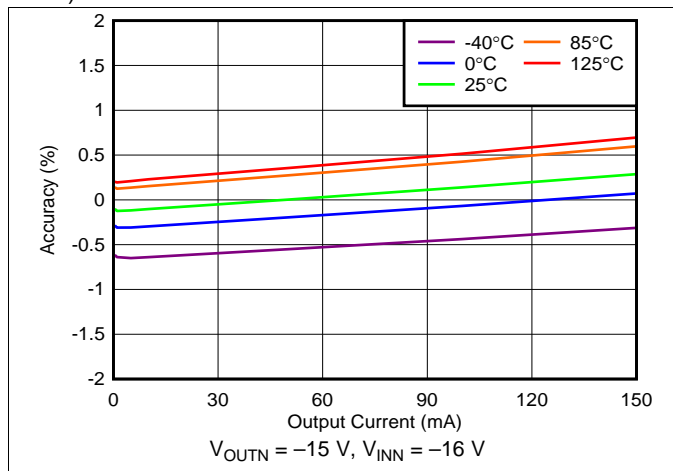

图 40. Positive Load Regulation

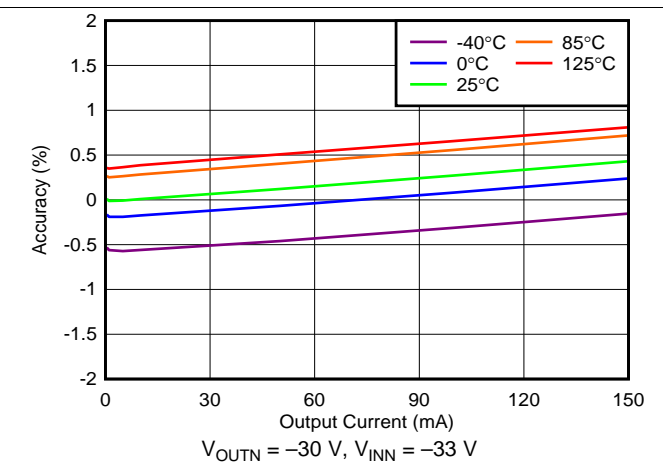

图 41. Positive Load Regulation

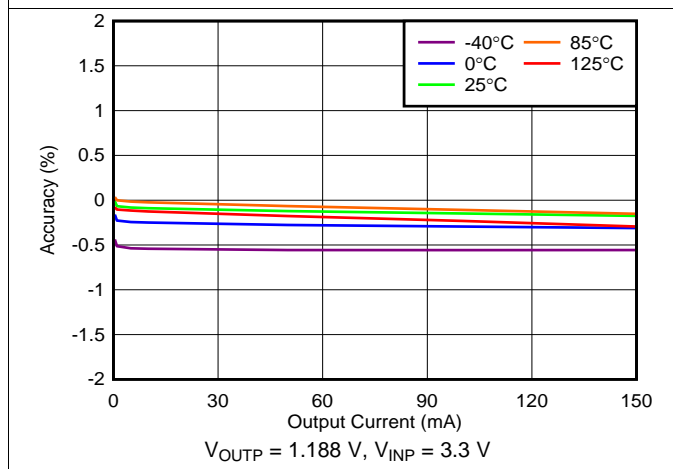

图 42. Positive Load Regulation

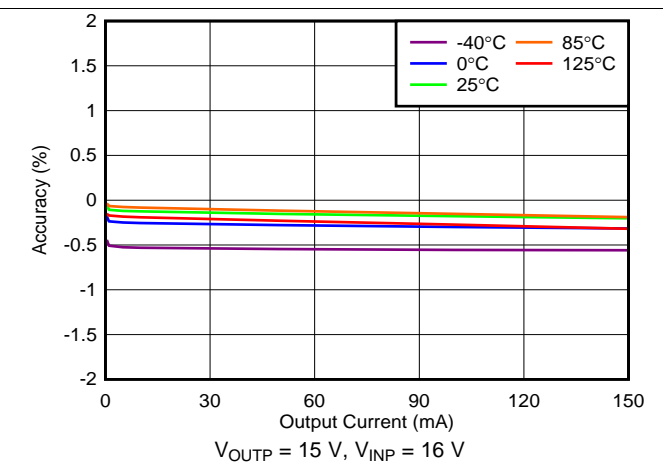

图 43. Positive Line Regulation

Typical Characteristics (continued)

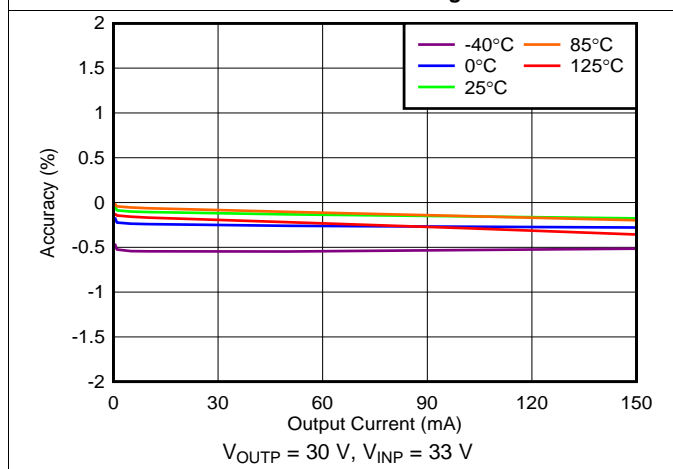
at $T_J = 25^\circ\text{C}$, $V_{INP} = V_{OUTP(nom)} + 1.0\text{ V}$ or $V_{IN} = 3.3\text{ V}$ (whichever is greater), $V_{INN} = V_{OUTN(nom)} - 1\text{ V}$ or -3.3 V (whichever is less), $V_{EN} = V_{IN}$, $I_{OUT} = 1\text{ mA}$, $C_{IN} = 10\text{-}\mu\text{F}$ ceramic, $C_{OUT} = 10\text{-}\mu\text{F}$ ceramic, and $C_{FFP} = C_{FFN} = C_{NR/SS} = 10\text{ nF}$ (unless otherwise noted)

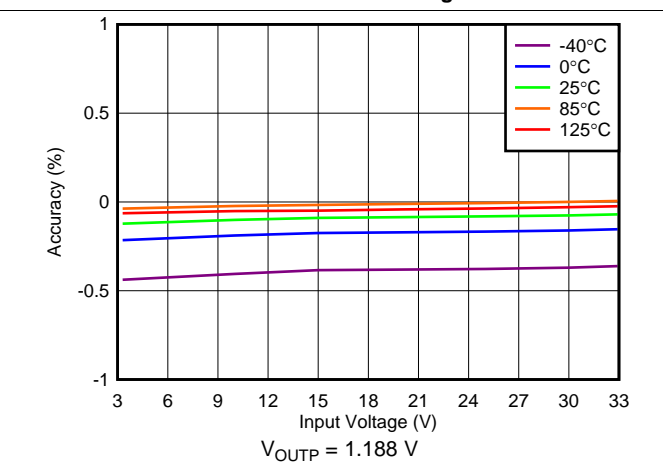
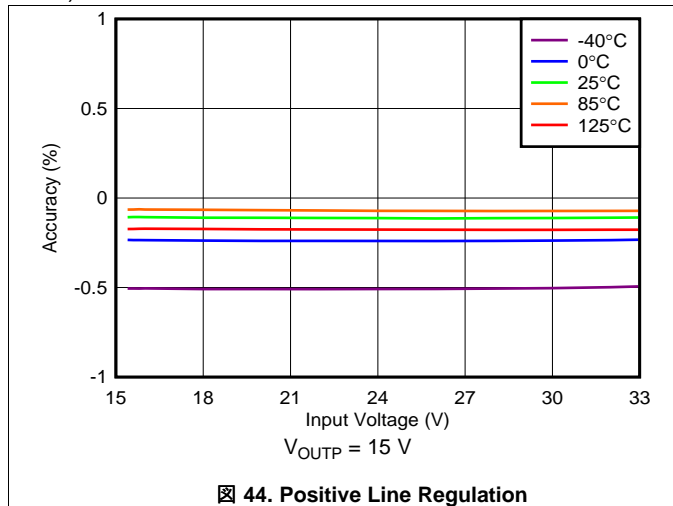

Figure 44. Positive Line Regulation

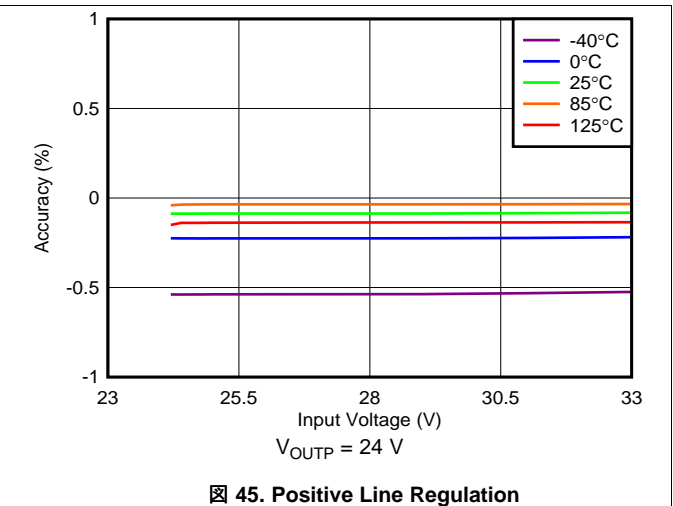

Figure 45. Positive Line Regulation

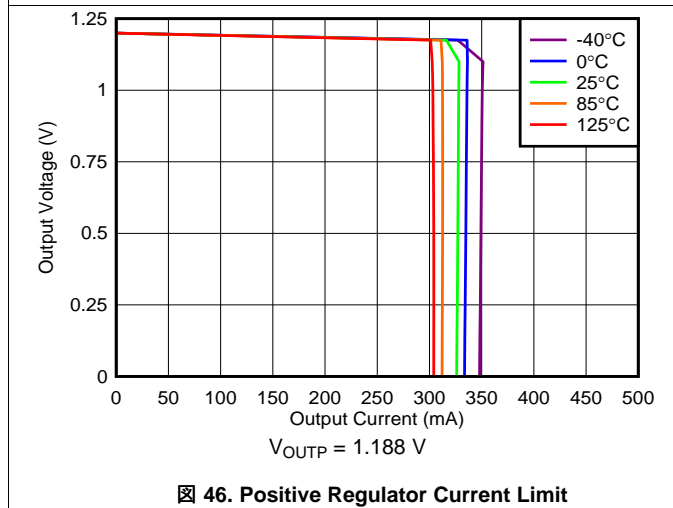

Figure 46. Positive Regulator Current Limit

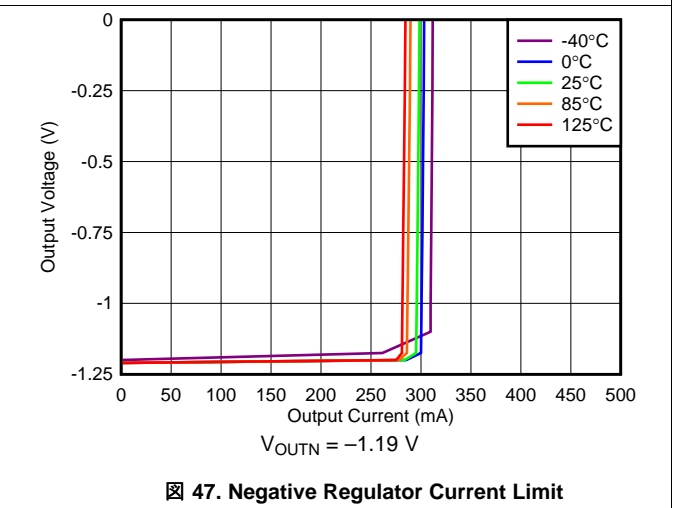

Figure 47. Negative Regulator Current Limit

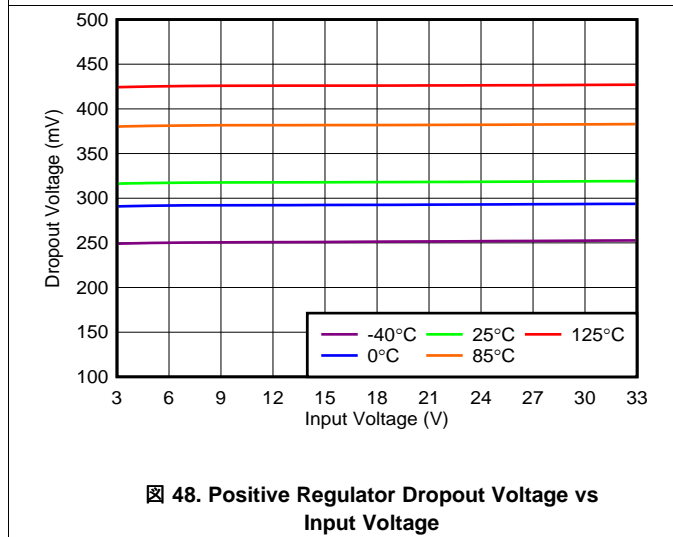

Figure 48. Positive Regulator Dropout Voltage vs Input Voltage

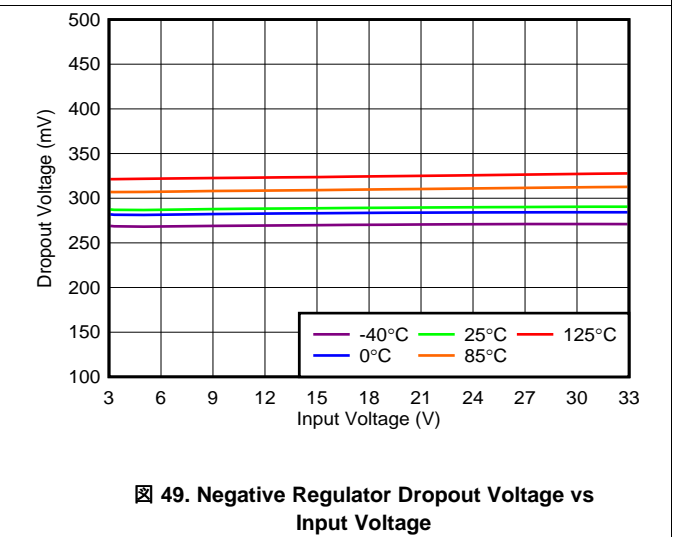

Figure 49. Negative Regulator Dropout Voltage vs Input Voltage

Typical Characteristics (continued)

at $T_J = 25^\circ\text{C}$, $V_{INP} = V_{OUTP(nom)} + 1.0\text{ V}$ or $V_{IN} = 3.3\text{ V}$ (whichever is greater), $V_{INN} = V_{OUTN(nom)} - 1\text{ V}$ or -3.3 V (whichever is less), $V_{EN} = V_{IN}$, $I_{OUT} = 1\text{ mA}$, $C_{IN} = 10\text{-}\mu\text{F}$ ceramic, $C_{OUT} = 10\text{-}\mu\text{F}$ ceramic, and $C_{FFP} = C_{FFN} = C_{NR/SS} = 10\text{ nF}$ (unless otherwise noted)



图 50. Positive Regulator Dropout Voltage vs Output Current



图 51. Negative Regulator Dropout Voltage vs Output Current

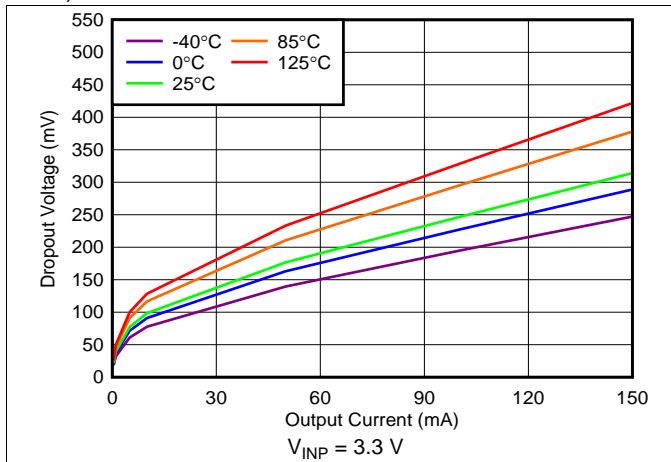

图 52. Enable Threshold vs Temperature

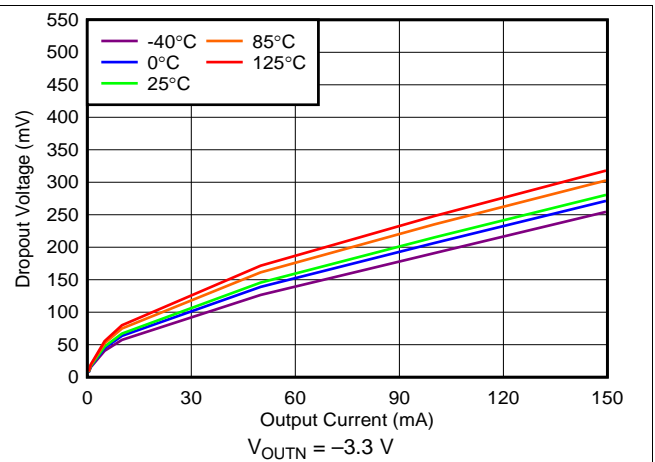

图 53. $I_{NR/SS}$ vs $V_{NR/SS}$

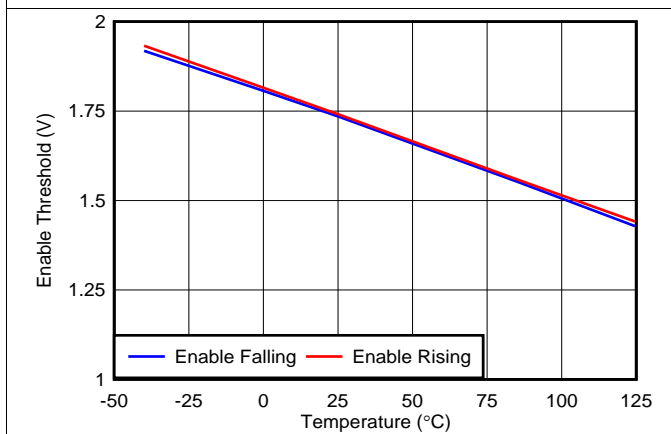

图 54. Positive Output Discharge Current vs Output Voltage

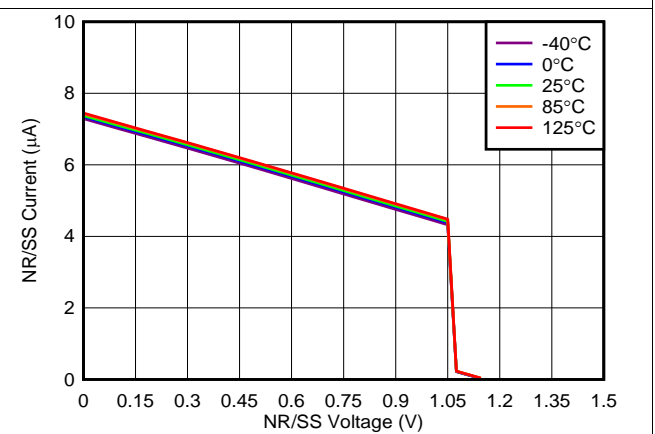

图 55. Negative Output Discharge Current vs Output Voltage

Typical Characteristics (continued)

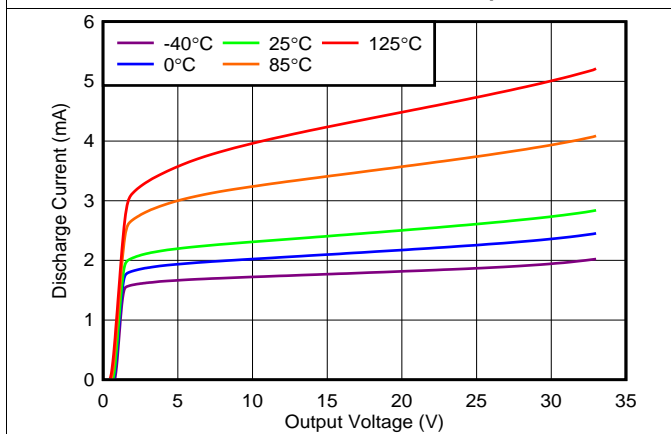
at $T_J = 25^\circ\text{C}$, $V_{INP} = V_{OUTP(nom)} + 1.0\text{ V}$ or $V_{IN} = 3.3\text{ V}$ (whichever is greater), $V_{INN} = V_{OUTN(nom)} - 1\text{ V}$ or -3.3 V (whichever is less), $V_{EN} = V_{IN}$, $I_{OUT} = 1\text{ mA}$, $C_{IN} = 10\text{-}\mu\text{F}$ ceramic, $C_{OUT} = 10\text{-}\mu\text{F}$ ceramic, and $C_{FFP} = C_{FFN} = C_{NR/SS} = 10\text{ nF}$ (unless otherwise noted)

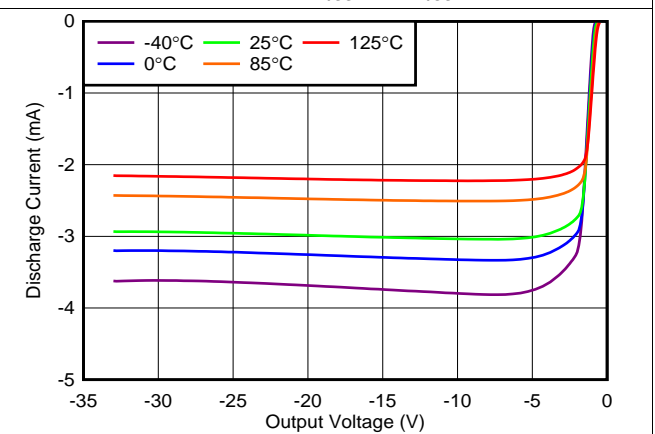
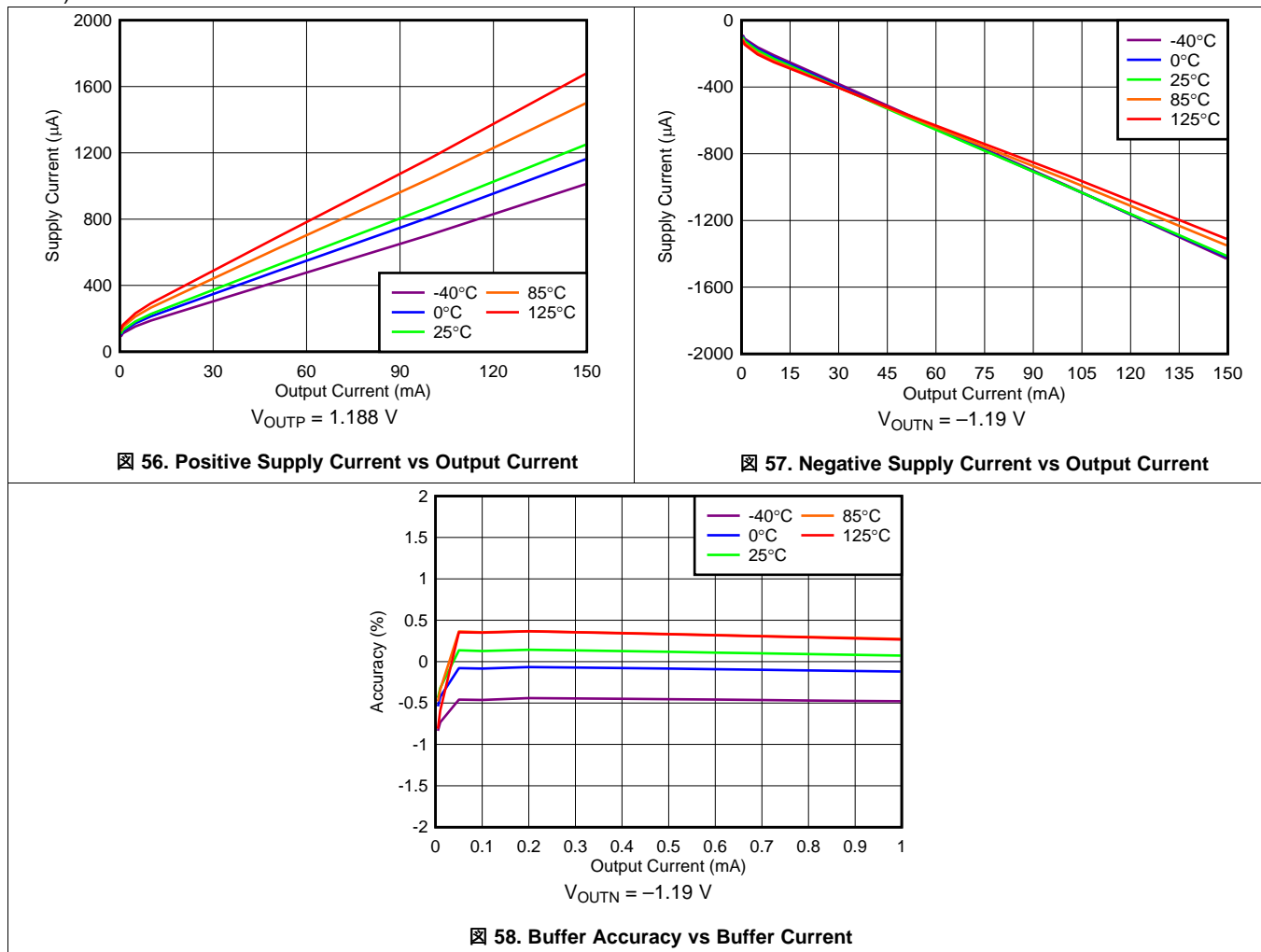

7 Detailed Description

7.1 Overview

The TPS7A39 is an innovative linear regulator (LDO) targeted at powering the signal chain, capable of up to ± 33 V on the inputs and regulating up to ± 30 V on the outputs at up to 150 mA of load current. The device uses an LDO topology that, by design, delivers ratiometric start-up tracking in most applications. The TPS7A39 has several other features, as listed in 表 1, that simplify using the device in a variety of applications.

注

Throughout this document, x is used to designate that the condition or component applies to both the positive and negative regulators (for example, C_{FFx} means C_{FFP} and C_{FFN}).

表 1. TPS7A39 Features

VOLTAGE REGULATION	SYSTEM START-UP	INTERNAL PROTECTION
Reference input/output	Ratiometric start-up tracking	Current limit
High-PSRR output	Programmable soft-start	Thermal shutdown
Fast transient response	Sequencing controls	

7.2 Functional Block Diagram

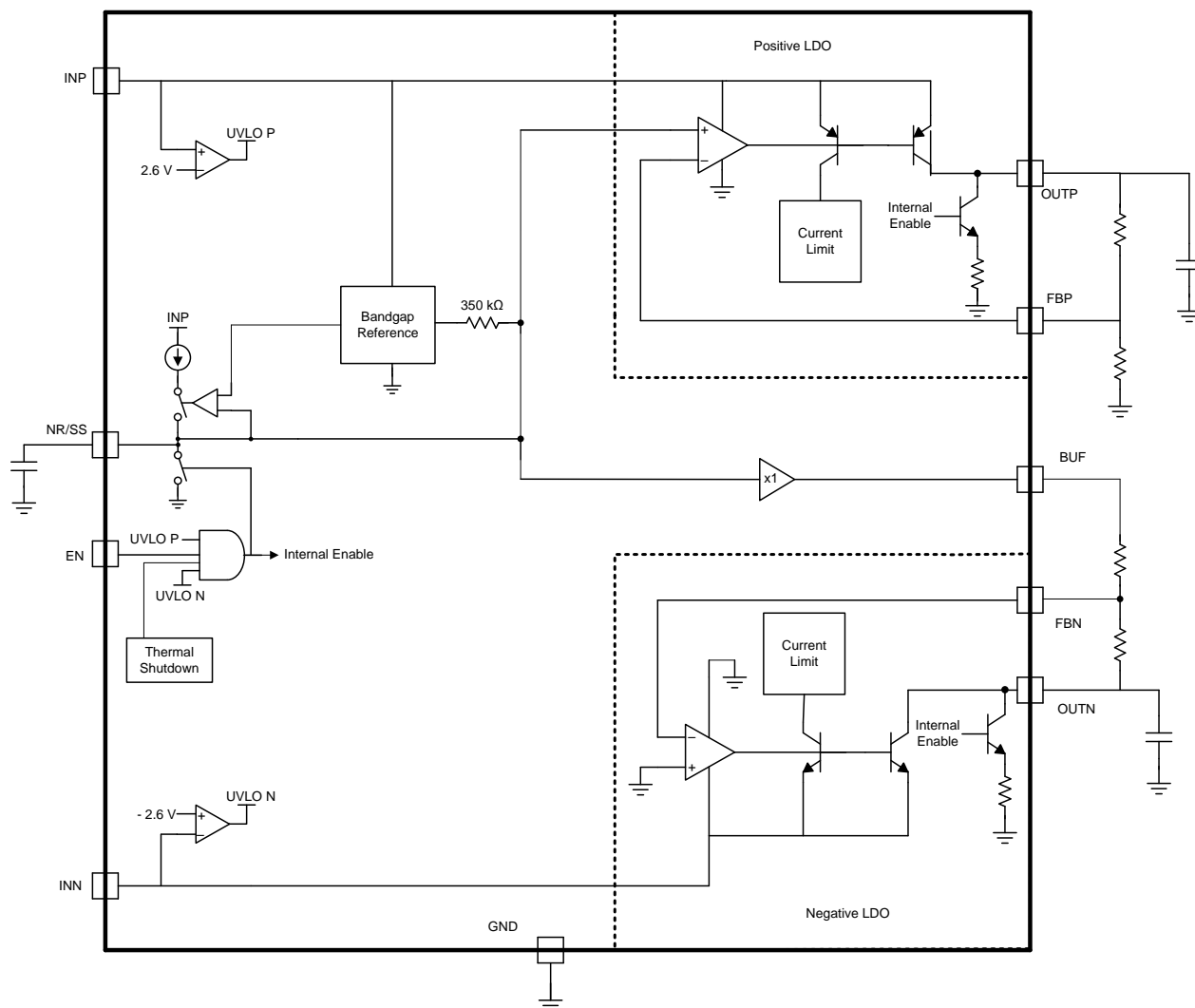

7.3 Feature Description

7.3.1 Voltage Regulation

7.3.1.1 DC Regulation

An LDO functions as a buffered op-amp in which the input signal is the internal reference voltage ($V_{NR/SS}$), as shown in [Figure 59](#), and in normal regulation $V_{FBP} = V_{NR/SS}$. Sharing a single reference ensures that both channels track each other during start-up.

$V_{NR/SS}$ is designed to have a very low-bandwidth at the input to the error amplifier through the use of a low-pass filter. As such, the reference can be considered as a pure dc input signal.

As [Figure 60](#) shows, the negative LDO on the device regulates with a $V_{FBN} = 0\text{ V}$ and inverts the positive reference (V_{BUF}). This topology allows the negative regulator to regulate down to 0 V.

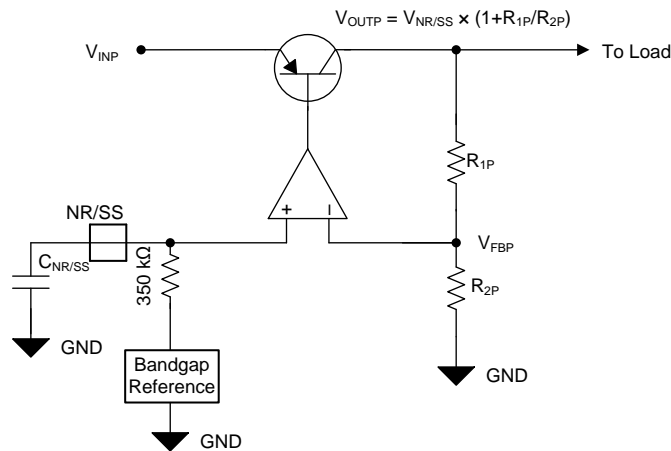

Figure 59. Simplified Positive Regulation Circuit

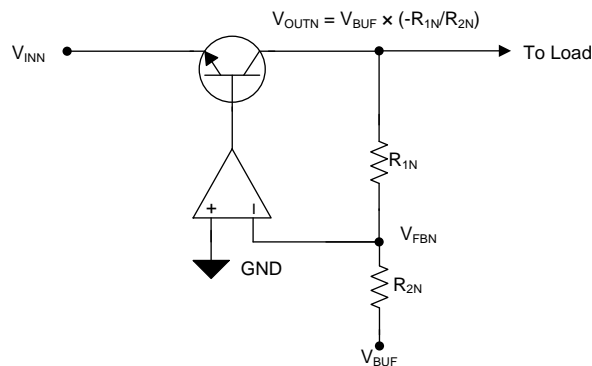

Figure 60. Simplified Negative Regulation Circuit

7.3.1.2 AC and Transient Response

Each LDO responds quickly to a transient on the input supply (line transient) or the output current (load transient). This LDO has a high power-supply rejection ratio (PSRR) and, when coupled with a low internal noise-floor (V_n), the LDO approximates an ideal power supply in ac and large-signal conditions.

The performance and internal layout of the device minimizes the coupling of noise from one channel to the other channel (crosstalk). Good printed circuit board (PCB) layout minimizes the crosstalk.

The noise-reduction and soft-start capacitor ($C_{NR/SS}$) and feed-forward capacitor (C_{FFX}) easily reduce the device noise floor and improve PSRR; see the [Optimizing Noise and PSRR](#) section for more information on optimizing the noise and PSRR performance.

Feature Description (continued)

7.3.2 User-Settable Buffered Reference

As [Figure 61](#) shows, the device internally generated band-gap voltage outputs at the NR/SS pin. An internal resistor (R_{NR}) and an external capacitor ($C_{NR/SS}$) control the rise time of the voltage at the $V_{NR/SS}$ pin, setting the soft-start time. This network also filters out noise from the band gap, reducing the overall noise floor of the device.

Driving the NR/SS pin with an external source can improve the device accuracy and can reduce the device noise floor, along with enabling the device to regulate the positive channel to voltages below the device internal reference.

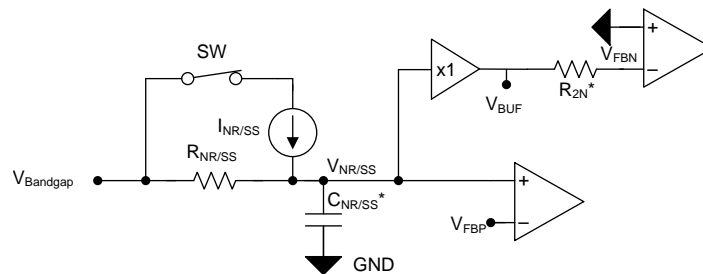

Note: * Denotes external components

NOTE: * denotes external components.

Figure 61. Simplified Reference Circuit

7.3.3 Active Discharge

When either EN or UVLOx are low, the device connects a resistance from V_{OUTx} to GND, discharging the output capacitance. The active discharge circuit requires $|V_{OUTx}| \geq 0.6$ V (typ) to discharge the output because the NPN pulldown has a minimum V_{CE} requirement.

Do not rely on the active discharge circuit for discharging large output capacitors when the input voltage drops below the targeted output voltage. The TPS7A39 is a bipolar device, and as such, reverse voltage conditions ($|V_{OUTx}| \geq |V_{INx}| + 0.3$ V) can breakdown the emitter to base diode and also cause a breakdown of the parasitic bipolar formed in the substrate; see the [Reverse Current](#) section for more details.

When either EN or UVLOx are low, the device outputs a small amount of leakage current. The leakage current is typically handled by the maximum R_{2x} resistor value of 240 k Ω . However, if the device is placed in unity gain (no R_{2x} resistor) this leakage current causes the output to slowly rise until the discharge circuit (as shown in [Figure 62](#)) has enough headroom to clamp the output voltage (typically ± 0.6 V).

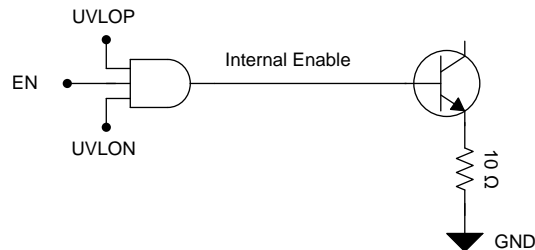

Figure 62. Simplified Active Discharge Circuit

7.3.4 System Start-Up Controls

In many different applications, the power-supply output must turn-on within a specific window of time because of sequencing requirements, ensuring proper operation of the load, or to minimize the loading on the input supply.

Both LDOs start-up are well-controlled and user-adjustable through the $C_{NR/SS}$ capacitor, solving the demanding requirements faced by many power-supply design engineers in a simple fashion. For start-up tracking to work correctly, a minimum 4.7-nF $C_{NR/SS}$ capacitor is required. For more information on startup tracking, see the [Noise-Reduction and Soft-Start Capacitor \(\$C_{NR/SS}\$ \)](#) section.

Feature Description (continued)

7.3.4.1 Start-Up Tracking

Figure 63 shows how both regulators use a common reference, which enables start-up tracking. Using the same reference voltage for both the positive and negative regulators ensures that the regulators start-up together in a controlled fashion; see Figure 24 and Figure 25.

Ramps on V_{INx} with $EN = V_{INP}$ that are slower than the soft-start time do not have start-up tracking. If ramps slower than the soft-start time are used then enable should be used to start the device to ensure start-up tracking. A small mismatch between the positive and negative internal enable thresholds means that one channel turns on at a slightly lower input voltage than the other channel. This mismatch is typically not a problem in most applications and is easily solved by controlling the start-up with enable. The external signal can come from the input power supply power-good indicator, a voltage supervisor output such as the [TPS3701](#), or from another source.

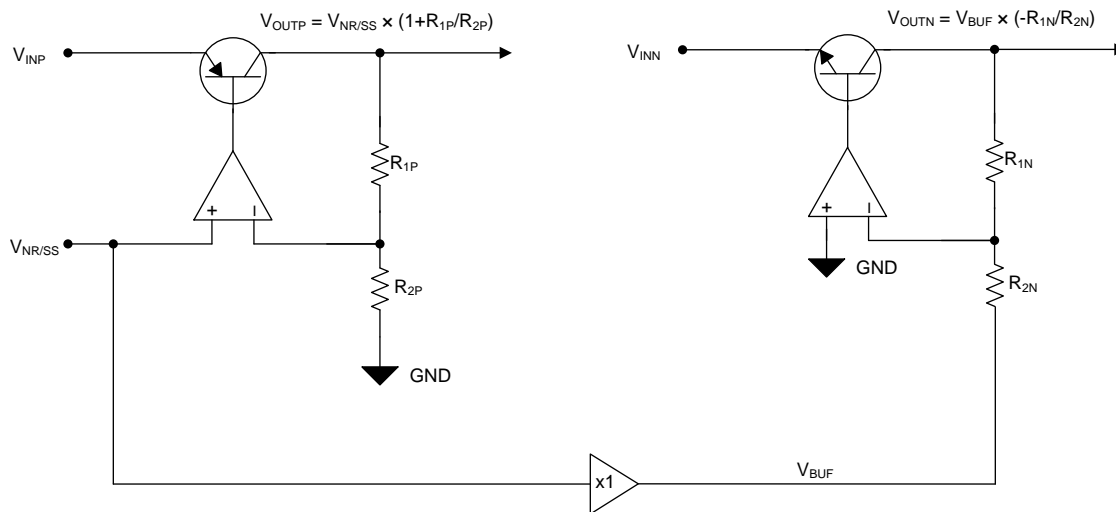

Figure 63. Simplified Regulation Circuit

7.3.4.2 Sequencing

Figure 64 and Table 2 describe how the turn-on and turn-off times of both LDOs (respectively) is controlled by setting the enable circuit (EN) and undervoltage lockout circuit (UVLOP and UVLON).

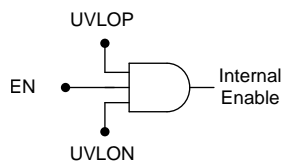

Figure 64. Simplified Turn-On Control

Table 2. Sequencing Functionality Table

POSITIVE INPUT VOLTAGE (V_{INP})	NEGATIVE INPUT VOLTAGE (V_{INN})	ENABLE STATUS	LDO STATUS	ACTIVE DISCHARGE
$V_{INP} \geq V_{UVLOP}$	$V_{INN} \leq V_{UVLON}$	EN = 1	On	Off
		EN = 0	Off	On ⁽¹⁾
$V_{INP} \geq V_{UVLOP}$	$V_{INN} > V_{UVLON}$	EN = don't care	Off	On ⁽¹⁾
$V_{INP} < V_{UVLOP}$	$V_{INN} \leq V_{UVLON}$	EN = don't care	Off	On ⁽¹⁾
$V_{INP} < V_{UVLOP} - V_{HYSP}$	$V_{INN} > V_{UVLON} - V_{HYSN}$	EN = don't care	Off	On ⁽¹⁾

(1) The active discharge remains on as long as V_{INx} and V_{OUTx} provide enough headroom for the discharge circuit to function.

7.3.4.2.1 Enable (EN)

The enable signal (V_{EN}) is an active-high digital control that enables the LDO when the enable voltage is past the rising threshold ($V_{EN} \geq V_{IH(EN)}$) and disables the LDO when the enable voltage is below the falling threshold ($V_{EN} \leq V_{IL(EN)}$). The exact enable threshold is between $V_{IH(EN)}$ and $V_{IL(EN)}$ because EN is a digital control. In applications that do not use the enable control, connect EN to V_{INP} .

A slow V_{INX} ramp directly connecting EN to V_{INP} can cause the start-up tracking to move out of specification. Under slow ramp conditions, use a resistor divider from V_{INP} to ensure start-up tracking.

7.3.4.2.2 Undervoltage Lockout (UVLO) Control

The UVLO circuit responds quickly to glitches on the input supplies and attempts to disable the output of the device if either of these rails collapse.

As a result of the fast response time of the input supply UVLO circuit, fast and short line transients well below the input supply UVLO falling threshold (brownouts) can cause momentary glitches during the edges of the transient. These glitches are typical in most LDOs. The local input capacitance prevents severe brown-outs in most applications; see the [Undervoltage Lockout \(UVLOx\) Control](#) section for more details. Fast line transients can cause the outputs to momentarily shut off, and can be mitigated through using the recommended 10- μ F input capacitor. If this becomes a problem in the system, increasing the input capacitance prevents these glitches from occurring.

7.4 Device Functional Modes

7.4.1 Normal Operation

The device regulates to the nominal output voltage under the following conditions:

- The input voltage is at least as high as $|V_{INx(min)}|$
- The input voltage is greater than the nominal output voltage added to the dropout voltage
- The enable voltage has previously exceeded the enable rising threshold voltage and has not decreased below the enable falling threshold
- The output current is less than the current limit
- The device junction temperature is less than T_{SD}

7.4.2 Dropout Operation

If the input voltage is lower than the nominal output voltage plus the specified dropout voltage, but all other conditions are met for normal operation, the device operates in dropout mode. In this mode of operation, the output voltage is the same as the input voltage minus the dropout voltage. The transient performance of the device is significantly degraded because the pass device (as a bipolar junction transistor, or BJT) is in saturation and no longer controls the current through the LDO. Line or load transients in dropout can result in large output voltage deviations.

7.4.3 Disabled

The device is disabled under the following conditions:

- The enable voltage is less than the enable falling threshold voltage or has not yet exceeded the enable rising threshold
- The device junction temperature is greater than the thermal shutdown temperature

表 3 shows the conditions that lead to the different modes of operation.

表 3. Device Functional Mode Comparison

OPERATING MODE	PARAMETER			
	V_{IN}	V_{EN}	I_{OUT}	T_J
Normal mode	$ V_{INx} > V_{OUT(nom)} + V_{DOx} $ and $ V_{INx} > V_{INx(min)} $	$V_{EN} > V_{IH}$	$ I_{OUTx} < I_{LIMx} $	$T_J < 125^\circ\text{C}$
Dropout mode	$ V_{INx(min)} < V_{INx} < V_{OUTx(nom)} + V_{DOx} $	$V_{EN} > V_{IH}$	—	$T_J < 125^\circ\text{C}$
Disabled mode (any true condition disables the device)	—	$V_{EN} < V_{IL}$	—	$T_J > T_{SD}$

8 Application and Implementation

注

Information in the following applications sections is not part of the TI component specification, and TI does not warrant its accuracy or completeness. TI's customers are responsible for determining suitability of components for their purposes. Customers should validate and test their design implementation to confirm system functionality.

8.1 Application Information

Successfully implementing an LDO in an application depends on the application requirements. This section discusses key device features and how to best implement the LDO to achieve a reliable design.

8.1.1 Setting the Output Voltages on Adjustable Devices

Figure 65 shows that each LDO resistor feedback network sets its output voltage. The positive LDO output voltage range is $V_{NR/SS}$ to 30 V and the negative LDO output voltage range is 0 V to –30 V.

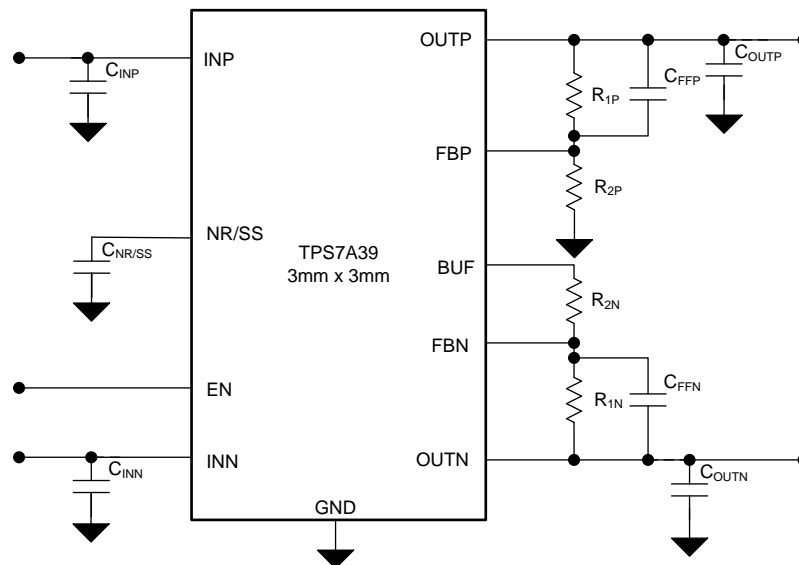

Figure 65. Adjustable Operation

Equation 1 relates the values of R_{1P} and R_{2P} to $V_{OUTP(NOM)}$ and $V_{NR/SS}$ to set the positive output voltage. Equation 2 relates the values of R_{1N} and R_{2N} to $V_{OUTN(NOM)}$ and $V_{NR/SS}$ to set the negative output voltage.

The positive LDO is configured as a noninverting op amp, whereas the negative LDO is an inverting op amp.

$$V_{OUTP} = V_{NR/SS} \times (1 + R_{1P} / R_{2P}) \quad (1)$$

$$V_{OUTN} = V_{NR/SS} \times (-R_{1N} / R_{2N}) \quad (2)$$

Substituting $V_{NR/SS}$ with V_{FBP} on the positive channel and $V_{NR/SS}$ with V_{BUF} on the negative channel gives a more accurate relationship.

Equation 3 and Equation 2 are rearranged versions of Equation 1 and Equation 2, with the above substitutions made.

$$R_{1P} = (V_{OUTP} / V_{FBP} - 1) \times R_{2P} \quad (3)$$

$$R_{1N} = -(V_{OUTN} \times R_{2P}) / V_{BUF} \quad (4)$$

The minimum bias current through both feedback networks is 5 μ A to ensure accuracy.

For even tighter accuracy, take into account the input bias current into the error amplifiers (I_{FBP} and I_{FBN}) and use 0.1% resistors. Overriding the internal reference with a high accuracy external reference can also improve the accuracy of the device.

Application Information (continued)

表 4 和 表 5 show the resistor combinations for several common output voltages using commercially available, 1% tolerance resistors.

表 4. Recommended Feedback-Resistor Values for the Positive LDO

TARGETED OUTPUT VOLTAGE (V)	FEEDBACK RESISTOR VALUES ⁽¹⁾		CALCULATED OUTPUT VOLTAGE (V)
	R _{1P} (kΩ)	R _{2P} (kΩ)	
1.5	2.67	10.0	1.50
1.8	5.23	10.0	1.80
2.5	11.0	10.0	2.49
3.0	15.4	10.0	3.00
3.3	17.8	10.0	3.29
5.0	32.4	10.0	5.02
9.0	66.5	10.0	9.07
12.0	90.9	10.0	12.0
15.0	115	10.0	14.8
24.0	191	10.0	23.8
30.0	243	10.0	29.8

(1) R_{1P} is connected from OUPP to FBP, R_{2P} is connected from FBP to GND; see the [Setting the Output Voltages on Adjustable Devices](#) section.

表 5. Recommended Feedback-Resistor Values for the Negative LDO

TARGETED OUTPUT VOLTAGE (V)	FEEDBACK RESISTOR VALUES ⁽¹⁾		CALCULATED OUTPUT VOLTAGE (V)
	R _{1N} (kΩ)	R _{2N} (kΩ)	
-0.3	2.55	10.0	-0.303
-1.5	12.7	10.0	-1.51
-1.8	15.0	10.0	-1.78
-2.5	21.0	10.0	-2.49
-3.0	25.5	10.0	-3.03
-3.3	28.0	10.0	-3.33
-5.0	42.2	10.0	-5.04
-9.0	75.0	10.0	-8.91
-12.0	100	10.0	-11.9
-15.0	127	10.0	-15.1
-24.0	200	10.0	-23.8
-30.0	255	10.0	-30.3

(1) R_{1N} is connected from OUTN to FBN, R_{2N} is connected from FBN to BUF; see the [Setting the Output Voltages on Adjustable Devices](#) section.

8.1.2 Capacitor Recommendations

The device is designed to be stable using low equivalent series resistance (ESR) ceramic capacitors at the input and output pins. The device is also designed to be stable with aluminum polymer and tantalum polymer capacitors with ESR < 75 mΩ.

Electrolytic capacitors (along with higher ESR polymer capacitors) can also be used if capacitors (meeting the minimum capacitance and ESR requirements) are used in parallel.

Take the effective ESR for stability when the impedance of the capacitor is at its minimum. At the minimum level, the capacitance and parasitic inductance cancel each other and provides the DC ESR.

Ceramic capacitors that employ X7R-, X5R-, and COG-rated dielectric materials provide relatively good capacitive stability across temperature, whereas the use of Y5V-rated capacitors is discouraged because of large variations in capacitance.

Regardless of the ceramic capacitor type selected, ceramic capacitance varies with operating voltage and temperature. As a rule of thumb, derate ceramic capacitors by at least 50%. The input and output capacitors recommended herein account for an effective capacitance derating of approximately 50%, but at higher V_{IN} and V_{OUT} conditions (that is, $V_{IN} = 5.5\text{ V}$ to $V_{OUT} = 5.0\text{ V}$) the derating can be greater than 50% and must be taken into consideration.

For high performance applications polymer capacitors are ideal as they do not experience the large deratings of ceramic capacitors.

8.1.3 Input and Output Capacitor (C_{INx} and C_{OUTx})

The device is designed and characterized for operation with ceramic capacitors of 10 μF or greater (2.2 μF or greater of effective capacitance) at each input and output.

Locate the input and output capacitors as near as practical to the respective input and output pins to minimize the trace inductance from the capacitor to the device. If the LDO is used to produce low output voltages (below 5 V), a 4.7- μF output capacitor can be used. If a 4.7- μF output capacitor is used, be sure to account for the derating of the capacitors during design.

Large, fast line transients on the input supplies can cause the device output to momentarily turn off. Typically these transients do not occur in most applications, but when these transients do occur use a larger input capacitor to slow down the line transient. If the system has input line transients that are faster than 0.5 V/ μs , increase the input capacitance.

8.1.4 Feed-Forward Capacitor (C_{FFx})

Although a feed-forward capacitor (C_{FFx}) from the FBx pin to the OUTx pin is not required to achieve stability, a 10-nF external C_{FFx} capacitor optimizes the transient, noise, and PSRR performance. The maximum recommended value for C_{FFx} is 100 nF.

A larger C_{FFx} can dominate the start-up time set by $C_{NR/SS}$, for more information see the [Pros and Cons of Using a Feed-Forward Capacitor with a Low Dropout Regulator](#) application report.

8.1.5 Noise-Reduction and Soft-Start Capacitor ($C_{NR/SS}$)

Although a noise-reduction and soft-start capacitor ($C_{NR/SS}$) from the NR/SS pin to GND is not required, $C_{NR/SS}$ is highly recommended to control the start-up time and reduce the noise-floor of the device. For start-up tracking to function correctly, a minimum 4.7-nF capacitor is required. As the time constant formed by the feedback resistors and feed-forward capacitors increases, the value of the $C_{NR/SS}$ capacitor must also be increased for startup tracking to work correctly. To figure out how to calculate the time constant of the feedback network see the [Pros and Cons of Using a Feed-Forward Capacitor with a Low Dropout Regulator](#) application report.

8.1.6 Buffered Reference Voltage

The voltage at the NR/SS pin, whether driven internally or externally, is buffered with a high-bandwidth, low-noise op amp. The BUF pin can be used as a voltage reference in many signal chain applications.

8.1.7 Overriding Internal Reference

The internal reference of the LDO can be overridden using an external source to increase the accuracy of the LDO and lower the output noise. To override the internal reference connect the external source to the NR/SS pin of the LDO. In order to overdrive the internal reference the external source must be able to source or sink 100 μA or greater.

The internal reference achieves a 2% accuracy from -40°C to $+125^{\circ}\text{C}$; using an external reference can help achieve better accuracy over temperature.

8.1.8 Start-Up

8.1.8.1 Soft-Start Control (NR/SS)

Each output of the device features a user-adjustable, monotonic, voltage-controlled soft-start that is set with an external capacitor ($C_{NR/SS}$). This soft-start eliminates power-up initialization problems.

The output voltage (V_{OUTx}) rises proportionally to $V_{NR/SS}$ during start-up. As such, the time required for $V_{NR/SS}$ to reach its nominal value determines the rise time of V_{OUTx} (start-up time).

The soft-start ramp time depends on the soft-start charging current ($I_{NR/SS}$), the soft-start capacitance ($C_{NR/SS}$), and the internal reference ($V_{NR/SS}$). 式 5 calculates the approximate soft-start ramp time (t_{SS}):

$$t_{SS} = R_{NR/SS} \times C_{NR/SS} \times \ln [(V_{NR/SS} + I_{NR/SS} \times R_{NR/SS}) / (I_{NR/SS} \times R_{NR/SS})] \quad (5)$$

Values for the soft-start charging currents, $R_{NR/SS}$, and the device internal $C_{NR/SS}$ are provided in the table.

8.1.8.1.1 In-Rush Current

In-rush current is defined as the current into the LDO at the INx pin during start-up. In-rush current then consists primarily of the sum of load current and the current used to charge the output capacitor. This current is difficult to measure because the input capacitor must be removed, which is not recommended. However, the in-rush current can be estimated by 式 6:

$$I_{OUTx}(t) = \left[\frac{C_{OUTx} \times dV_{OUTx}(t)}{dt} \right] + \left[\frac{V_{OUTx}(t)}{R_{LOAD}} \right]$$

where:

- $V_{OUTx}(t)$ is the instantaneous output voltage of the turn-on ramp
- $dV_{OUTx}(t) / dt$ is the slope of the V_{OUTx} ramp
- R_{LOAD} is the resistive load impedance

(6)

8.1.8.2 Undervoltage Lockout (UVLOx) Control

The UVLOx circuit ensures that the device stays disabled before its input or bias supplies reach the minimum operational voltage range, and ensures that the device properly shuts down when the input supply collapses.

图 66 and 表 6 explain the UVLOx circuit response to various input voltage events, assuming $V_{EN} \geq V_{IH(EN)}$.

The positive and negative UVLO circuits are internally ANDed together. As such, if either supply collapses, both outputs turn-off and $V_{NR/SS}$ is pulled low internally.



图 66. Typical UVLOx Operation

表 6. Typical UVLOx Operation Description

REGION	EVENT	V _{OUTx} STATUS	COMMENT
A	Turn-on, $ V_{INx} \leq V_{UVLOx} $	0	Start-up
B	Regulation	1	Regulates to target V _{OUTx}
C	Brownout, $ V_{INx} \geq V_{UVLOx} - V_{HYSx} $	1	The output can fall out of regulation but the device is still enabled
D	Regulation	1	Regulates to target V _{OUTx}
E	Brownout, $ V_{INx} < V_{UVLOx} - V_{HYSx} $	0	The device is disabled and the output falls because of the load and active discharge circuit. The device is reenabled when the UVLOx rising threshold is reached by the input voltage and a normal start-up then follows.
F	Regulation	1	Regulates to target V _{OUTx}
G	Turn-off, $ V_{INx} < V_{UVLOx} - V_{HYSx} $	0	The output falls because of the load and active discharge circuit

Similar to many other LDOs with this feature, the UVLOx circuit takes a few microseconds to fully assert. During this time, a downward line transient below approximately 0.8 V causes the UVLOx to assert for a short time; however, the UVLOx circuit does not have enough stored energy to fully discharge the internal circuits inside of the device. When the UVLOx circuit is not given enough time to fully discharge the internal nodes, the outputs are not fully disabled.

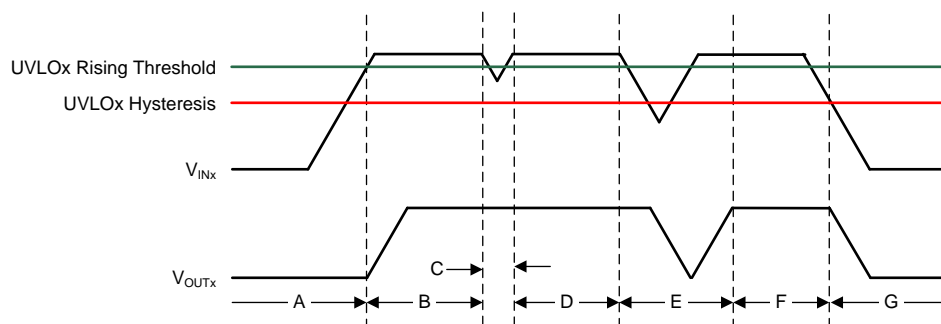
The effect of the downward line transient can be mitigated by using a larger input capacitor to increase the fall time of the input supply when operating near the minimum V_{INx}.

8.1.9 AC and Transient Performance

LDO ac performance for a dual-channel device includes power-supply rejection ratio, channel-to-channel output isolation, output current transient response, and output noise. These metrics are primarily a function of open-loop gain, bandwidth, and phase margin that control the closed-loop input and output impedance of the LDO. The output noise is primarily a result of the band-gap reference and error amplifier noise.

8.1.9.1 Power-Supply Rejection Ratio (PSRR)

PSRR is a measure of how well the LDO control-loop rejects signals from V_{INx} to V_{OUTx} across the frequency spectrum (usually 10 Hz to 10 MHz). 式 7 gives the PSRR calculation as a function of frequency for the input signal [V_{INx}(f)] and output signal [V_{OUTx}(f)].

$$PSRR \text{ (dB)} = 20 \text{ Log}_{10} \left(\frac{V_{INx}(f)}{V_{OUTx}(f)} \right) \quad (7)$$

Even though PSRR is a loss in signal amplitude, PSRR is shown as positive values in decibels (dB) for convenience.

Figure 67 shows a simplified diagram of PSRR versus frequency.

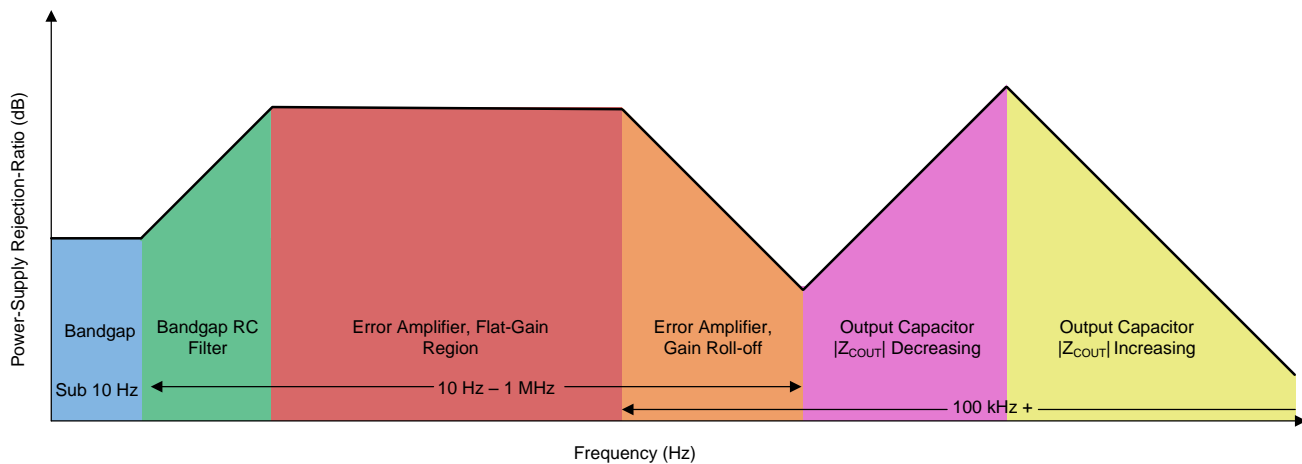

Figure 67. Power-Supply Rejection Ratio Diagram

An LDO is often employed not only as a dc-dc regulator, but also to provide exceptionally clean power-supply voltages that exhibit ultra-low noise and ripple to sensitive system components.

8.1.9.2 Channel-to-Channel Output Isolation and Crosstalk

Output isolation is a measure of how well the device prevents voltage disturbances on one output from affecting the other output. This attenuation appears in load transient tests on the other output; however, to numerically quantify the rejection, the output channel isolation is expressed in decibels (dB).

Output isolation performance is a strong function of the PCB layout. See the [Layout Guidelines](#) section on how to best optimize the isolation performance.

8.1.9.3 Output Voltage Noise

The TPS7A39 is designed for system applications where minimizing noise on the power-supply rail is critical to system performance. For example, the TPS7A39 can be used in a phase-locked loop (PLL)-based clocking circuit that can be used for minimum phase noise, or in test and measurement systems where even small power-supply noise fluctuations reduce system dynamic range.

LDO noise is defined as the internally-generated intrinsic noise created by the semiconductor circuits alone. This noise is the sum of various types of noise (such as shot noise associated with current-through-pin junctions, thermal noise caused by thermal agitation of charge carriers, flicker noise, or 1/f noise and dominates at lower frequencies as a function of 1/f). Figure 68 shows a simplified output voltage noise density plot versus frequency.

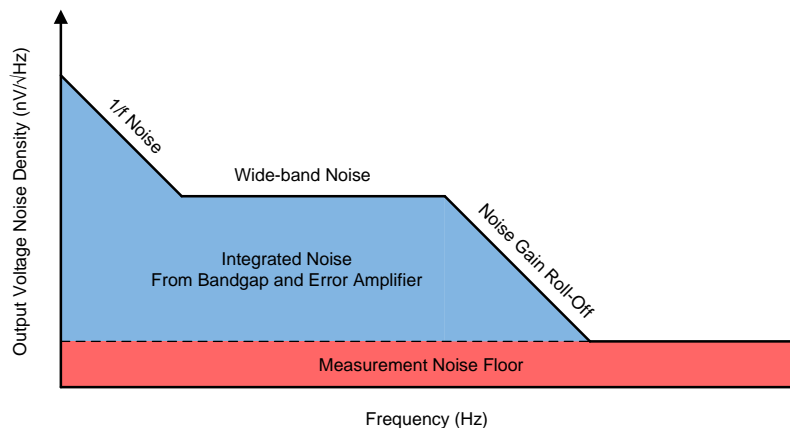

Figure 68. Output Voltage Noise Diagram

For further details, see the [How to Measure LDO Noise](#) white paper.

8.1.9.4 Optimizing Noise and PSRR

表 7 describes how the ultra-low noise floor and PSRR of the device can be improved in several ways.

表 7. Effect of Various Parameters on AC Performance⁽¹⁾⁽²⁾

PARAMETER	NOISE			PSRR		
	LOW-FREQUENCY	MID-FREQUENCY	HIGH-FREQUENCY	LOW-FREQUENCY	MID-FREQUENCY	HIGH-FREQUENCY
$C_{NR/SS}$	+++	No effect	No effect	+++	+	No effect
C_{FFx}	++	+++	+	++	+++	+
C_{OUTx}	No effect	+	+++	No effect	+	+++
$ V_{INx} - V_{OUTx} $	+	+	+	+++	+++	++
PCB layout	++	++	+	+	+++	+++

(1) The number of +s indicates the improvement in noise or PSRR performance by increasing the parameter value.

(2) Shaded cells indicate the easiest improvement to noise or PSRR performance.

The noise-reduction capacitor, in conjunction with the noise-reduction resistor, forms a low-pass filter (LPF) that filters out the noise from the reference before being gained up with the error amplifier, thereby minimizing the output voltage noise floor. The LPF is a single-pole filter and the cutoff frequency can be calculated with 式 8. The effect of the $C_{NR/SS}$ capacitor increases when $V_{OUTx(NOM)}$ increases because the noise from the reference is gained up when the output voltage increases. For low-noise applications, a 10-nF to 1- μ F $C_{NR/SS}$ is recommended.

$$f_{cutoff} = 1 / (2 \times \pi \times R_{NR/SS} \times C_{NR/SS}) \quad (8)$$

The feed-forward capacitor reduces output voltage noise by filtering out the mid-band frequency noise. The feed-forward capacitor can be optimized by placing a pole-zero pair near the edge of the loop bandwidth and pushing out the loop bandwidth, thus improving mid-band PSRR.

A larger C_{OUTx} or multiple output capacitors reduces high-frequency output voltage noise and PSRR by reducing the high-frequency output impedance of the power supply.

Additionally, a higher input voltage improves the noise and PSRR because greater headroom is provided for the internal circuits. However, a high power dissipation across the die increases the output noise because of the increase in junction temperature.

Good PCB layout improves the PSRR and noise performance by providing heatsinking at low frequencies and isolating V_{OUTx} at high frequencies.

8.1.9.5 Load Transient Response

The load-step transient response is the output voltage response by the LDO to a step in load current, whereby output voltage regulation is maintained. There are two key transitions during a load transient response: the transition from a light to a heavy load and the transition from a heavy to a light load. The regions illustrated in 图 69 are broken down in this section and are described in 表 8. Regions A, E, and H are where the output voltage is in steady-state. Increasing the output capacitance improves the transient response (less dip); however, the transient takes longer to recover when using a large output capacitor.



图 69. Load Transient Waveform

表 8. Load Transient Waveform Description

REGION	DESCRIPTION	COMMENT
A	Regulation	Regulation
B	Output current ramping	Initial voltage dip is a result of the depletion of the output capacitor charge.
C	LDO responding to transient	Recovery from the dip results from the LDO increasing its sourcing current, and leads to output voltage regulation.
D	Reaching thermal equilibrium	At high load currents the LDO takes some time to heat up. During this time the output voltage changes slightly.
E	Regulation	Regulation
F	Output current ramping	Initial voltage rise results from the LDO sourcing a large current, and leads to the output capacitor charge to increase.
G	LDO responding to transient	Recovery from the rise results from the LDO decreasing its sourcing current in combination with the load discharging the output capacitor.
H	Regulation	Regulation

8.1.10 DC Performance

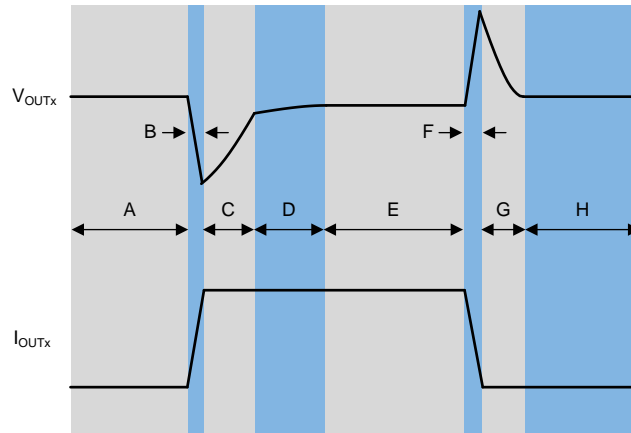
8.1.10.1 Output Voltage Accuracy (V_{OUTx})

The device features an output voltage accuracy that includes the errors introduced by the internal reference, load regulation, line regulation, process variation, and operating temperature as specified by the table. Output voltage accuracy specifies minimum and maximum output voltage error, relative to the expected nominal output voltage stated as a percent (for very low output voltages this specification is in mV).

8.1.10.2 Dropout Voltage (V_{DO})

Generally speaking, the dropout voltage often refers to the minimum voltage difference between the input and output voltage ($|V_{DO}| = |V_{INx}| - |V_{OUTx}|$) that is required for regulation. When V_{INx} drops below the required V_{DOx} for the given load current, the device functions as a resistive switch and does not regulate output voltage. Dropout voltage is proportional to the output current because the device is operating as a resistive switch.

8.1.11 Reverse Current

As with most LDOs, this device can be damaged by excessive reverse current.

Reverse current is current that flows through the substrate of the device instead of the normal conducting channel of the pass element. This current flow, at high enough magnitudes, degrades long-term reliability of the device resulting from risks of electromigration and excess heat being dissipated across the device.

Conditions where excessive reverse current can occur are outlined in this section, all of which can exceed the absolute maximum rating of $V_{OUTP} > V_{INP} + 0.3\text{ V}$ and $V_{OUTN} < V_{INN} - 0.3\text{ V}$:

- If the device has a large C_{OUTX} and the input supply collapses quickly with little or no load current
- The output is biased when the input supply is not established
- The output is biased above the input supply

If excessive reverse current flow is expected in the application, then external protection must be used to protect the device. [Figure 70](#) shows one approach of protecting the device.

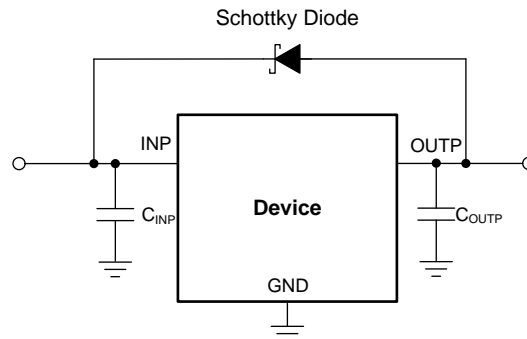

Figure 70. Example Circuit for Reverse Current Protection Using a Schottky Diode On Positive Rail

8.1.12 Power Dissipation (P_D)

Circuit reliability demands that proper consideration is given to device power dissipation, location of the circuit on the printed circuit board (PCB), and correct sizing of the thermal plane. The PCB area around the regulator must be as free as possible of other heat-generating devices that cause added thermal stresses.

As a first-order approximation, power dissipation in the regulator depends on the input-to-output voltage difference and load conditions. Use [Equation 9](#) to approximate P_D :

$$P_D = (V_{INP} - V_{OUTP}) \times I_{OUTP} + (|V_{INN} - V_{OUTN}|) \times |I_{OUTN}| \quad (9)$$

Careful selection of the system voltage rails minimizes power dissipation and improves system efficiency. Proper selection allows the minimum input-to-output voltage differential to be obtained. The low dropout of the device allows for maximum efficiency across a wide range of output voltages.

The main heat conduction path for the device is through the thermal pad on the package. As such, the thermal pad must be soldered to a copper pad area under the device. This pad area contains an array of plated vias that conduct heat to any inner plane areas or to a bottom-side copper plane.

The maximum power dissipation determines the maximum allowable junction temperature (T_J) for the device. According to [Equation 10](#), power dissipation and junction temperature are most often related by the junction-to-ambient thermal resistance (θ_{JA}) of the combined PCB, device package, and the temperature of the ambient air (T_A).

$$T_J = T_A + \theta_{JA} \times P_D \quad (10)$$

Unfortunately, this thermal resistance (θ_{JA}) is highly dependent on the heat-spreading capability built into the particular PCB design, and therefore varies according to the total copper area, copper weight, and location of the planes. The θ_{JA} recorded in the [Electrical Characteristics](#) table is determined by the JEDEC standard, PCB, and copper-spreading area, and is only used as a relative measure of package thermal performance. For a well-designed thermal layout, θ_{JA} is actually the sum of the WSON package junction-to-case (bottom) thermal resistance (θ_{Jcbot}) plus the thermal resistance contribution by the PCB copper.

8.1.12.1 Estimating Junction Temperature

The JEDEC standard recommends the use of psi (Ψ) thermal metrics to estimate the junction temperatures of the LDO when in-circuit on a typical PCB board application. These metrics are not strictly speaking thermal resistances, but rather offer practical and relative means of estimating junction temperatures. These psi metrics are determined to be significantly independent of the copper-spreading area. The key thermal metrics (Ψ_{JT} and Ψ_{JB}) are given in the [Electrical Characteristics](#) table and are used in accordance with 式 11.

$$\Psi_{JT}: T_J = T_T + \Psi_{JT} \times P_D$$

$$\Psi_{JB}: T_J = T_B + \Psi_{JB} \times P_D$$

where:

- P_D is the power dissipated as explained in 式 9
 - T_T is the temperature at the center-top of the device package
 - T_B is the PCB surface temperature measured 1 mm from the device package and centered on the package edge
- (11)

8.2 Typical Applications

8.2.1 Design 1: Single-Ended to Differential Isolated Supply



图 71. Single-Ended to Differential Isolated Supply Schematic

8.2.1.1 Design Requirements

表 9. Design Requirements

PARAMETER	DESIGN REQUIREMENT	DESIGN RESULT
Input supply	Must operate off of 5-V input	5-V input supply
Output supply	Must have a 5-V and -5-V output	±5-V output, ±2% accuracy
Positive output current	Capable of sourcing 50 mA on positive output	50 mA (sourcing)
Negative output current	Capable of sinking 50 mA on negative output	50 mA (sinking)
Isolation from 5-V supply	Must be isolated from input supply	Isolated through center tapped transformer
Efficiency	Must have > 80% efficiency at 100 mA ⁽¹⁾	85% efficiency when $I_{OUTN} = -50$ mA and $I_{OUTP} = 50$ mA

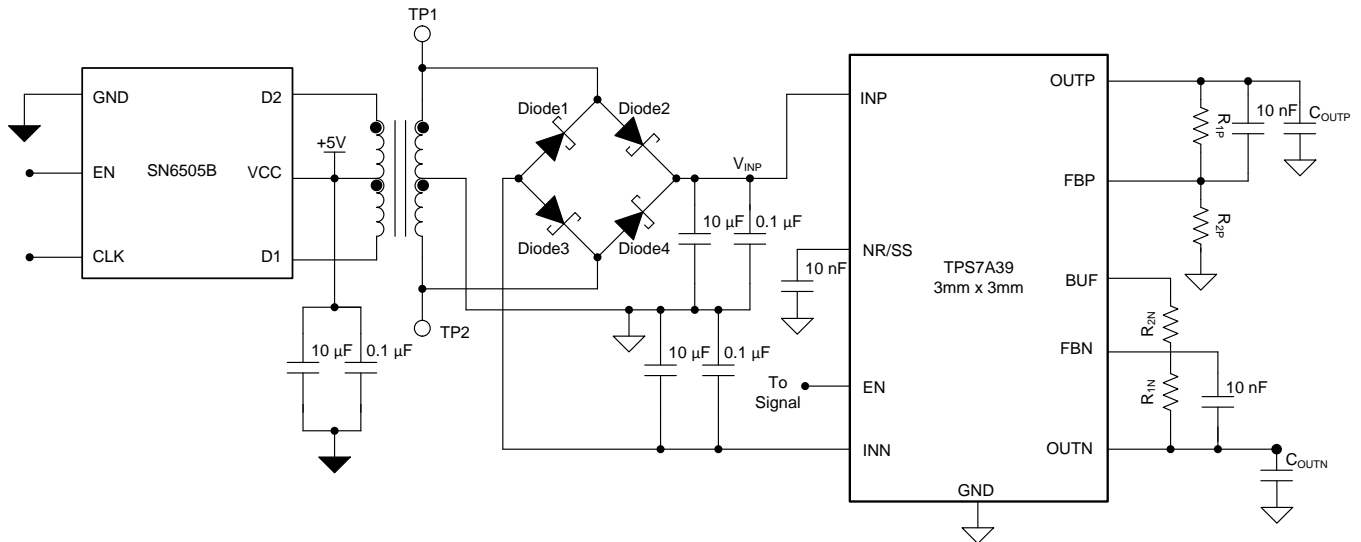
(1) $|I_{OUTN}| = I_{OUTP} = 50$ mA.

8.2.1.2 Detailed Design Procedure

8.2.1.2.1 Switcher Choice

This design incorporates a push-pull driver for center-tapped transformers that takes a single-ended supply and converts the supply to an isolated split rail design. The SN6505B provides a simple small-form factor isolated supply. The input voltage of the SN6505B can vary from 2.25 V to 5 V, which allows for use with a wide range of input supplies. The output voltage can be adjusted through the turns ratio of the transformer. Based on the choice of the transformer this design can be used to create output voltages from ± 3.3 V to ± 15 V. In this design the SN6505B was paired with the 750315371 center-tapped transformer from Wurth Electronics™. This transformer has a turns ratio of 1:1.1 and an isolation rating of 2500 V_{RMS} (the total system isolation was never tested).

8.2.1.2.2 Full Bridge Rectifier With Center-Tapped Transformer

To create the isolated supply, the SN6505B uses a center-tapped transformer. A full bridge rectifier and capacitors are required to regulate the signal before reaching the LDO because of the alternating nature of the input signal. TI recommends having a fast switching and low forward voltage diode to improve efficiency because of how fast the SN6505 switches; Schottky diodes work well. Figure 73 shows the switching nodes of the SN6505 D1 and D2 and also shows where the transformer connects to the full bridge rectifier TP1 and TP2. Figure 73 shows the switching waveforms across the rectifier diodes.

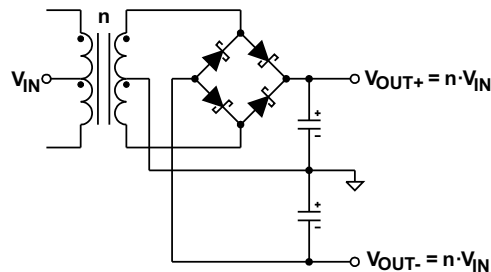

Figure 72. Bridge Rectifier With Center-Tapped Secondary Enables Bipolar Outputs

8.2.1.2.3 Total Solution Efficiency

Equation 12 shows how the efficiency of the system can be measured by taking the output power and dividing by the input power. $I_{OUTP} = |I_{OUTN}| = I_{OUT} / 2$ because this system has two output rails to simplify the efficiency measurement. When the necessary parameters are measured, and by using Equation 12, the overall system efficiency can be plotted as in Figure 74. Figure 74 shows the overall system efficiency for this design, at the maximum output current of 100 mA ($I_{OUTP} = 50$ mA, $I_{OUTN} = -50$ mA) the efficiency of the system is 85%.

$$\eta = (I_{OUTP} \times V_{OUTP} + I_{OUTN} \times V_{OUTN}) / (I_{IN} \times V_{IN}) \quad (12)$$

8.2.1.2.4 Feedback Resistor Selection

Equation 13 and Equation 14 calculate the values of the feedback resistors.

$$V_{OUTP} = V_{FBP} \times (1 + R_{1P} / R_{2P}) \quad (13)$$

$$V_{OUTN} = V_{BFN} \times (-R_{1N} / R_{2N}) \quad (14)$$

For this design the recommended 10-k Ω resistors are used for R_{2P} and R_{2N} . R_{1P} and R_{1N} can be calculated by substituting R_{2P} and R_{2N} into Equation 15 and Equation 16 because R_{2P} and R_{2N} are already selected

$$R_{1P} = [(V_{OUTP} / V_{FBP}) - 1] \times R_{2P} = [(5 \text{ V} / 1.188 \text{ V}) - 1] \times 10 \text{ k}\Omega = 32.2 \text{ k}\Omega \quad (15)$$

$$R_{1N} = -V_{OUTN} \times R_{2N} / V_{BFN} = -(-5 \text{ V}) \times 10 \text{ k}\Omega / 1.19 \text{ V} = 42 \text{ k}\Omega \quad (16)$$

After solving for Equation 15 and Equation 16, the closest one percent resistors are selected, $R_{1N} = 42.2$ k Ω and $R_{1P} = 32.4$ k Ω .

8.2.1.3 Application Curves

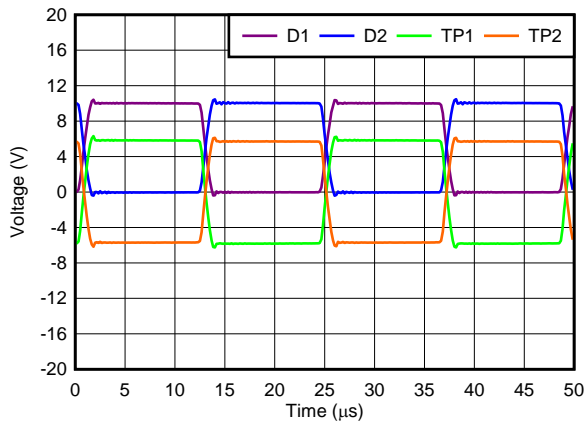

Figure 73. Switching Node of the SN6505B

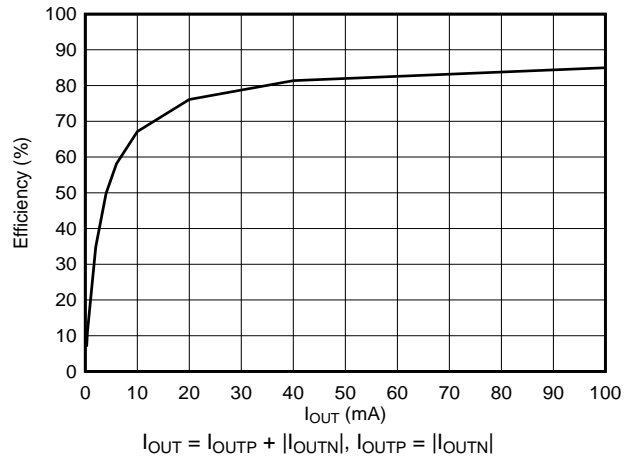

Figure 74. Efficiency vs Output Current

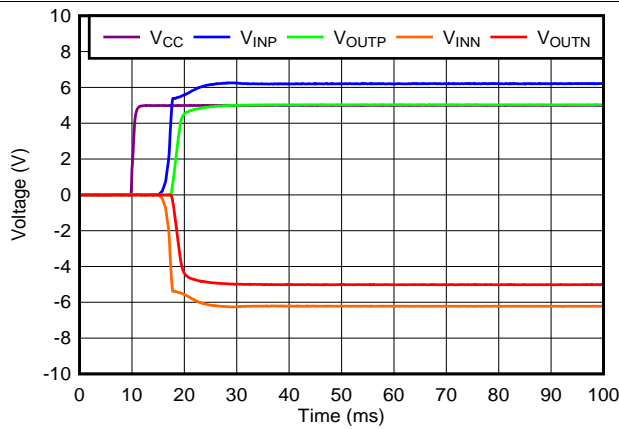

Figure 75. System Startup

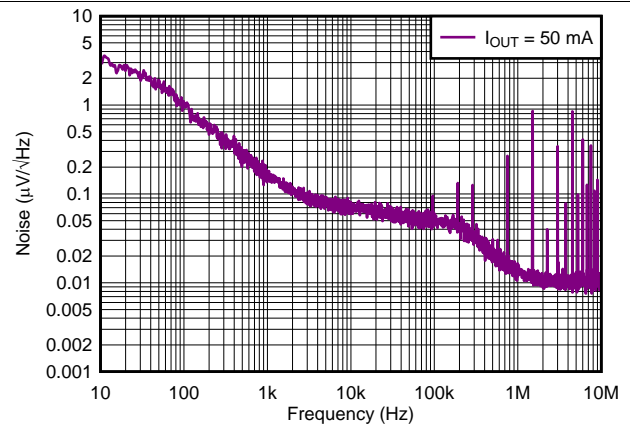

Figure 76. OUTP Noise

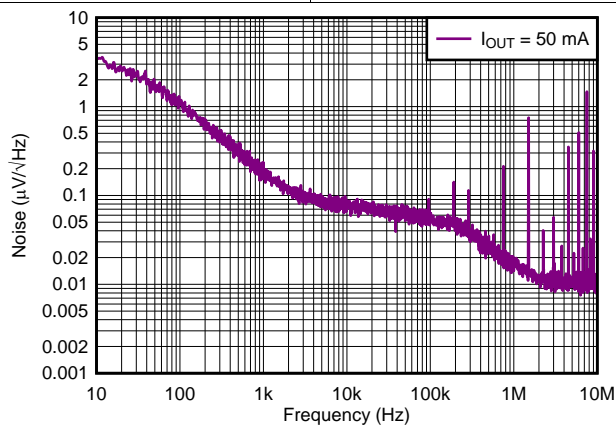
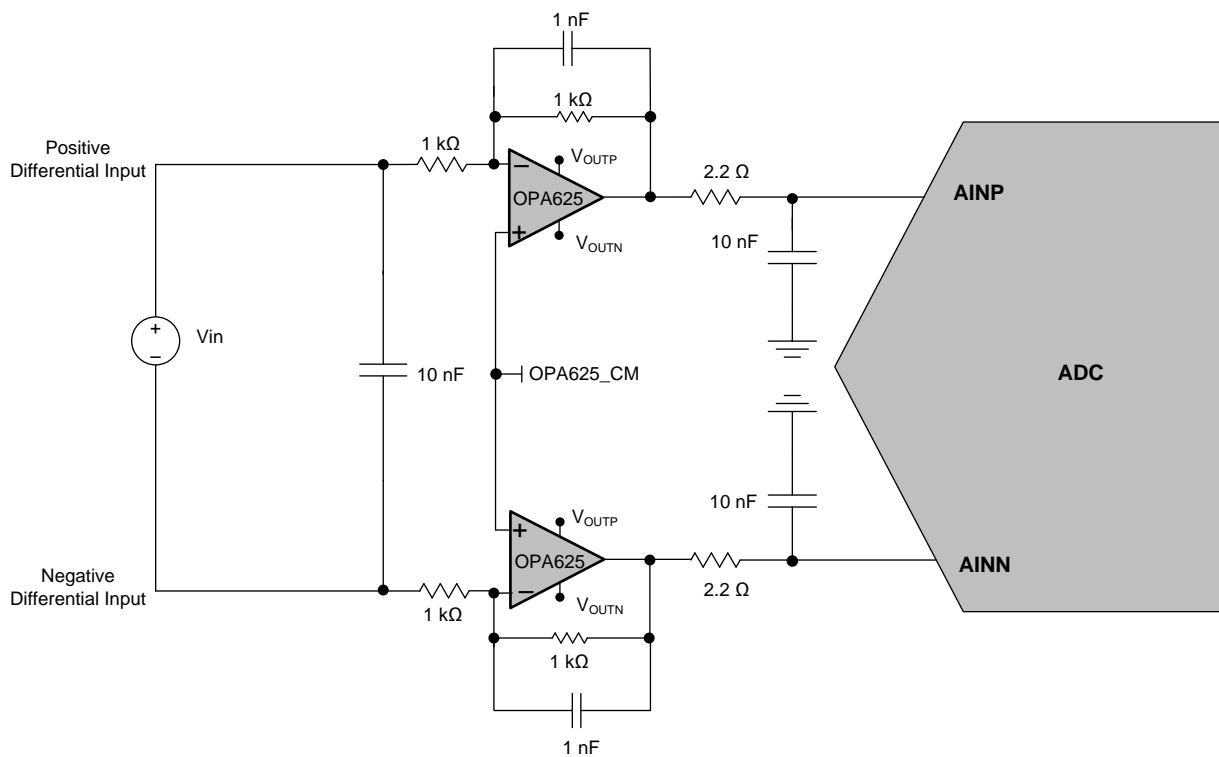
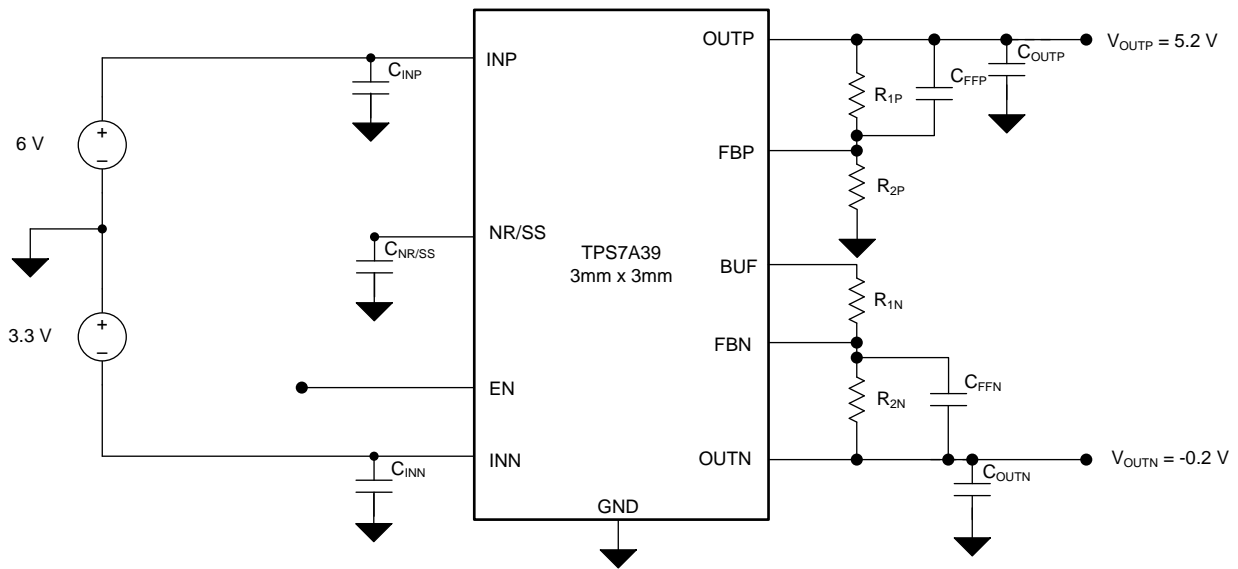

Figure 77. OUTN Noise

8.2.2 Design 2: Getting the Full Range of a SAR ADC



☒ 78. Creating Power Rails for an Analog Front-End of an ADC

8.2.2.1 Design Requirements

A common problem in analog-to-digital converters (ADCs) is that as the input signal approaches the edge of the range of the ADC, the signal begins to become distorted. Often times this is not because of a limitation of the ADC, but is a result of the analog front-end (AFE). In the AFE, the signal begins to approach the rails of the op amp and the signal begins to lose linearity and becomes distorted. This distortion is because when the rail-to-rail op amp begins to enter the nonlinear region of operation within 100 mV of the rail, the signal-to-noise ratio (SNR) starts to degrade and the total harmonic distortion (THD) of the ADC increases. To prevent the op amp from exiting the linear region of operation, the design must use a power supply that can generate rails 200 mV above and below the input range of the ADC.

8.2.2.2 Detailed Design Procedure

In this design, the [ADS8900B](#) is used as the ADC. This ADC features a differential input, so from a 5-V reference the ADC is able to encode values between ± 5 V. In many applications, single-supply op amps are powered with rails from 0 V to 5 V, which causes the input signal to become distorted when the full range signal is applied. The FFT of a 10- V_{PP} (peak-to-peak) sine wave using a single 5-V rail to bias the amplifiers is illustrated in [Figure 79](#). In this test the SNR was calculated to be 54.89 dB and the THD was calculated to be -40.68 dB.

There is a simple solution to improve the SNR and THD of the ADC: bias the amplifiers in the analog front end with a 5.2-V rail and a -0.2 -V rail. Using these rails allows the amplifier to operate in the linear region in the 0-V to 5-V range needed by the ADC. The FFT of a 10- V_{PP} sine wave using a 5.2-V rail and a -0.2 -V rail is illustrated in [Figure 80](#). In this test the SNR was calculated to be 102.535 dB and the THD was calculated to be -121.66 dB. Using -0.2 -V and 5.2-V rail voltages still allows for common 5-V (5.5 V max) op amps to be used in the design.

8.2.2.3 Detailed Design Description

8.2.2.3.1 Regulation of -0.2 V

The TPS7A39 has an innovative feature of regulating the negative rail down to zero volts. This regulation is achieved by using an inverting amplifier and using the positive-buffered reference as the input signal to the amplifier. Regulating to -0.2 V eliminates the nonlinearity and distortion present when using the full rail range of the amplifiers.

8.2.2.3.2 Feedback Resistor Selection

Use [Equation 17](#) and [Equation 18](#) to calculate the values of the feedback resistors:

$$V_{OUTP} = V_{FBP} \times (1 + R_{1P} / R_{2P}) \quad (17)$$

$$V_{OUTN} = V_{BUF} \times (-R_{1N} / R_{2N}) \quad (18)$$

For this design the recommended 10-k Ω resistors are used for R_{2P} and R_{2N} . R_{1P} and R_{1N} can be calculated by substituting R_{2P} and R_{2N} into [Equation 19](#) and [Equation 20](#) because R_{2P} and R_{2N} are already selected.

$$R_{1P} = [(V_{OUTP} / V_{FBP}) - 1] \times R_{2P} = [(5.2 \text{ V} / 1.188 \text{ V}) - 1] \times 10 \text{ k}\Omega = 33.8 \text{ k}\Omega \quad (19)$$

$$R_{1N} = -V_{OUTN} \times R_{2N} / V_{BUF} = -(-5 \text{ V}) \times 10 \text{ k}\Omega / 1.19 \text{ V} = 1.68 \text{ k}\Omega \quad (20)$$

After solving for [Equation 19](#) and [Equation 20](#), the closest one percent resistors are selected, $R_{1N} = 1.69 \text{ k}\Omega$ and $R_{1P} = 34 \text{ k}\Omega$.

8.2.2.4 Application Curves

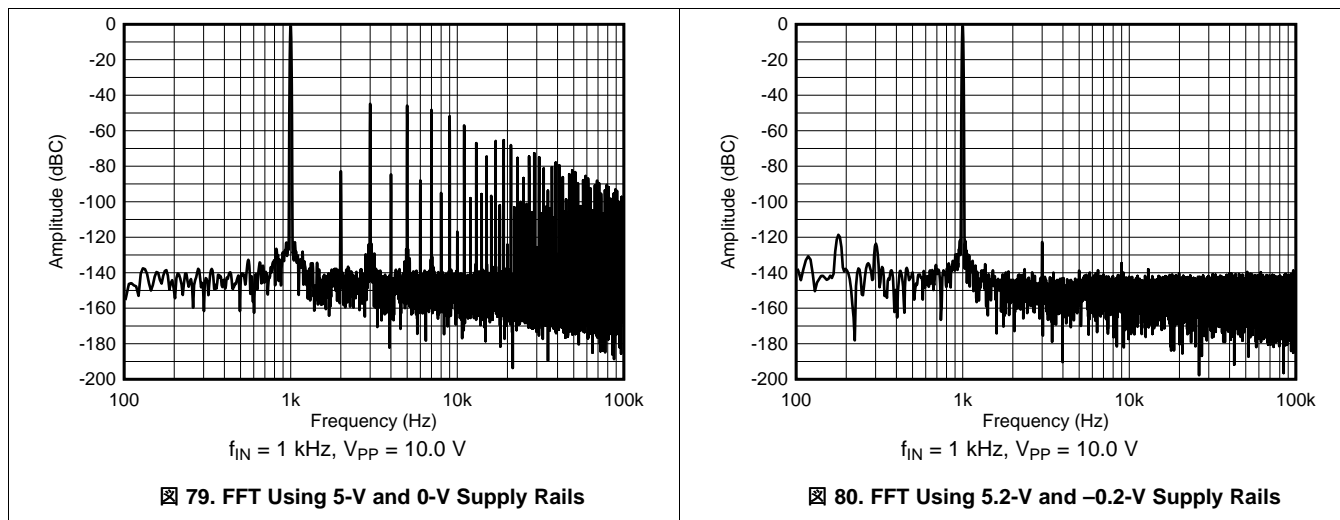

9 Power-Supply Recommendations

The input supply for the LDO must be within the recommended operating conditions. The input voltage must provide adequate headroom in order for the device to have a regulated output. Place the 10- μ F input capacitors as close to the device as possible. If the input supply is noisy, additional input capacitors can help improve the output noise performance.

10 Layout

10.1 Layout Guidelines

Layout is a critical part of good power-supply design. There are several signal paths that conduct fast-changing currents or voltages that can interact with stray inductance or parasitic capacitance to generate noise or degrade the power-supply performance. To help eliminate these problems, bypass the IN pin to ground with capacitors.

Tie the GND pin directly to the thermal pad under the device. The thermal pad must be connected to any internal PCB ground planes using multiple vias directly under the device.

Every capacitor must be placed as close as possible to the device and on the same side of the PCB as the regulator itself.

Do not place any of the capacitors on the opposite side of the PCB from where the regulator is installed. The use of vias and long traces is strongly discouraged because these circuits can impact system performance negatively, and even cause instability.

10.1.1 Board Layout Recommendations to Improve PSRR and Noise Performance

To improve ac performance (such as PSRR, output noise, and transient response), TI recommends that the board be designed with separate ground planes for V_{IN} and V_{OUT} , with each ground plane star connected only at the GND pin of the device. In addition, the ground connection for the bypass capacitor must connect directly to the GND pin of the device.

TPS7A39

JAJSR0A –JULY 2017–REVISED SEPTEMBER 2017

www.tij.co.jp

10.2 Layout Example

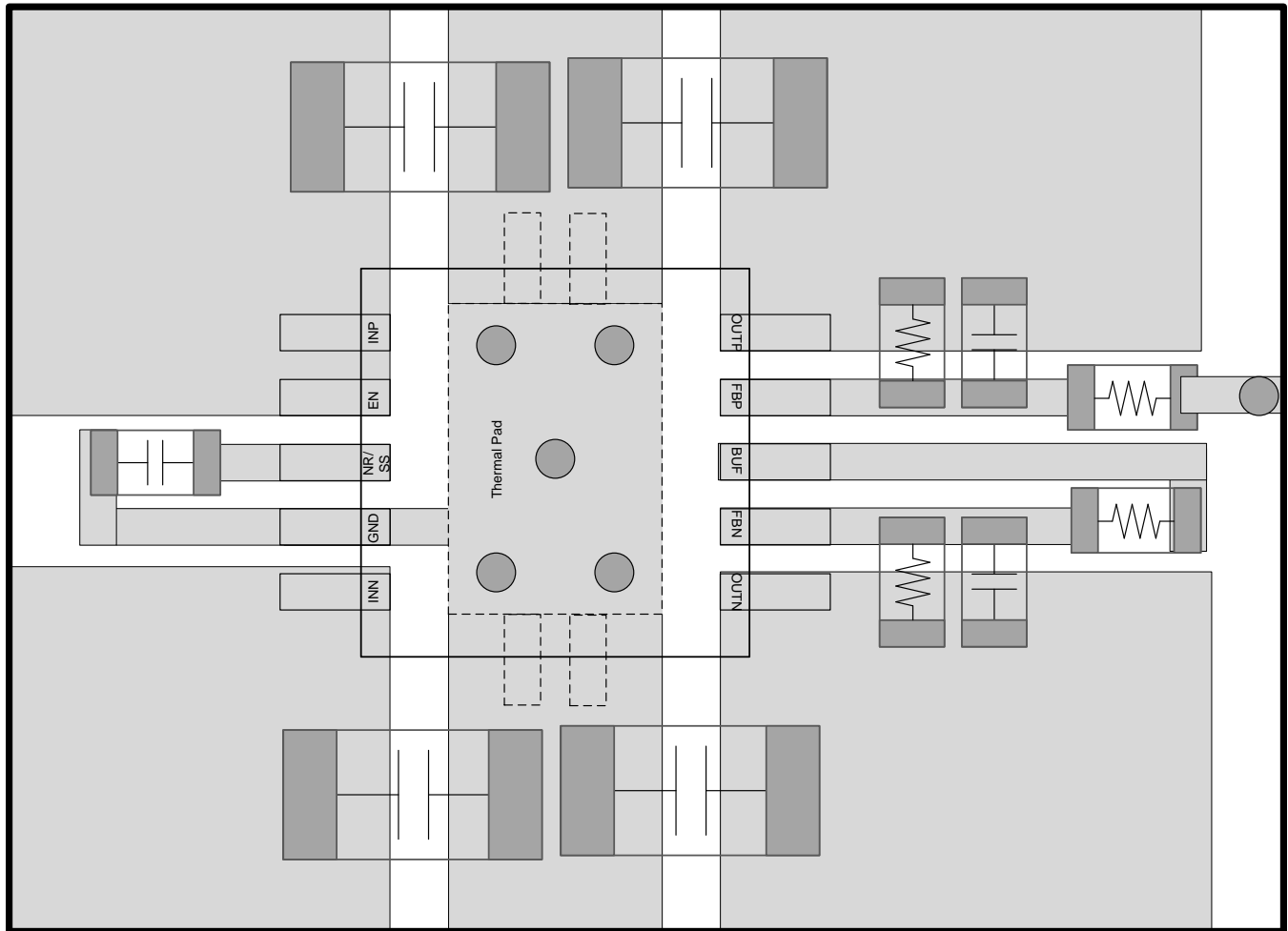

☒ 81. Layout Example for Adjustable Option

10.3 Package Mounting

Solder pad footprint recommendations for the TPS7A39 are available at the end of this document and at www.ti.com.

11 デバイスおよびドキュメントのサポート

11.1 デバイス・サポート

11.1.1 開発サポート

11.1.1.1 評価モジュール

TPS7A39を使用する回路の性能の初期評価に役立てるため、評価モジュール(EVM)を利用可能です。[TPS7A39EVM-865評価モジュール](#)(および[関連するユーザー・ガイド](#))は、テキサス・インスツルメンツのWebサイトの製品フォルダから請求するか、[TI eStore](#)から直接お求めになれます。

11.1.1.2 SPICEモデル

SPICEを使用した回路パフォーマンスのコンピュータによるシミュレーションは、アナログ回路やシステムのパフォーマンスを分析するため多くの場合に有用です。TPS7A39用のSPICEモデルは、製品フォルダの「ツールとソフトウェア」から入手できます。

11.2 ドキュメントのサポート

11.2.1 関連資料

関連資料については、以下を参照してください。

- 『[TPS3701 36V内部基準電圧搭載ウィンドウ・コンパレータ、過電圧および低電圧検出付き](#)』
- 『[SN6505 絶縁電源用の低ノイズ1A変圧器ドライバ](#)』
- 『[ADS890xB 20ビット、リファレンス・バッファ内蔵、拡張性能機能搭載、高速SAR ADC](#)』
- 『[低ドロップアウト・レギュレータでフィードフォワード・コンデンサを使用することの長所と短所](#)』
- 『[新しい温度指標の使用](#)』
- 『[TPS7A39EVM-865ユーザー・ガイド](#)』

11.3 ドキュメントの更新通知を受け取る方法

ドキュメントの更新についての通知を受け取るには、[ti.com](#)のデバイス製品フォルダを開いてください。右上の隅にある「通知を受け取る」をクリックして登録すると、変更されたすべての製品情報に関するダイジェストを毎週受け取れます。変更の詳細については、修正されたドキュメントに含まれている改訂履歴をご覧ください。

11.4 コミュニティ・リソース

The following links connect to TI community resources. Linked contents are provided "AS IS" by the respective contributors. They do not constitute TI specifications and do not necessarily reflect TI's views; see TI's [Terms of Use](#).

TI E2E™オンライン・コミュニティ *TIのE2E (Engineer-to-Engineer) コミュニティ*。エンジニア間の共同作業を促進するために開設されたものです。e2e.ti.comでは、他のエンジニアに質問し、知識を共有し、アイデアを検討して、問題解決に役立てることができます。

設計サポート *TIの設計サポート* 役に立つE2Eフォーラムや、設計サポート・ツールをすばやく見つけることができます。技術サポート用の連絡先情報も参照できます。

11.5 商標

E2E is a trademark of Texas Instruments.

Würth Electronics is a trademark of Würth Elektronik GmbH and Co.

All other trademarks are the property of their respective owners.

11.6 静電気放電に関する注意事項



すべての集積回路は、適切なESD保護方法を用いて、取扱いと保存を行うようにして下さい。

静電気放電はわずかな性能の低下から完全なデバイスの故障に至るまで、様々な損傷を与えます。高精度の集積回路は、損傷に対して敏感であり、極めてわずかなパラメータの変化により、デバイスに規定された仕様に適合しなくなる場合があります。

11.7 Glossary

[SLYZ022](#) — *TI Glossary*.

This glossary lists and explains terms, acronyms, and definitions.

12 メカニカル、パッケージ、および注文情報

以降のページには、メカニカル、パッケージ、および注文に関する情報が記載されています。この情報は、そのデバイスについて利用可能な最新のデータです。このデータは予告なく変更されることがあり、ドキュメントが改訂される場合もあります。本データシートのブラウザ版を使用されている場合は、画面左側の説明をご覧ください。

PACKAGING INFORMATION

Orderable Device	Status (1)	Package Type	Package Drawing	Pins	Package Qty	Eco Plan (2)	Lead finish/ Ball material (6)	MSL Peak Temp (3)	Op Temp (°C)	Device Marking (4/5)	Samples
TPS7A3901DSCR	ACTIVE	WSON	DSC	10	3000	RoHS & Green	NIPDAU	Level-2-260C-1 YEAR	-40 to 125	A3901	Samples
TPS7A3901DSCT	ACTIVE	WSON	DSC	10	250	RoHS & Green	NIPDAU	Level-2-260C-1 YEAR	-40 to 125	A3901	Samples

(1) The marketing status values are defined as follows:

ACTIVE: Product device recommended for new designs.

LIFEBUY: TI has announced that the device will be discontinued, and a lifetime-buy period is in effect.

NRND: Not recommended for new designs. Device is in production to support existing customers, but TI does not recommend using this part in a new design.

PREVIEW: Device has been announced but is not in production. Samples may or may not be available.

OBsolete: TI has discontinued the production of the device.

(2) **RoHS:** TI defines "RoHS" to mean semiconductor products that are compliant with the current EU RoHS requirements for all 10 RoHS substances, including the requirement that RoHS substance do not exceed 0.1% by weight in homogeneous materials. Where designed to be soldered at high temperatures, "RoHS" products are suitable for use in specified lead-free processes. TI may reference these types of products as "Pb-Free".

RoHS Exempt: TI defines "RoHS Exempt" to mean products that contain lead but are compliant with EU RoHS pursuant to a specific EU RoHS exemption.

Green: TI defines "Green" to mean the content of Chlorine (Cl) and Bromine (Br) based flame retardants meet JS709B low halogen requirements of <=1000ppm threshold. Antimony trioxide based flame retardants must also meet the <=1000ppm threshold requirement.

(3) MSL, Peak Temp. - The Moisture Sensitivity Level rating according to the JEDEC industry standard classifications, and peak solder temperature.

(4) There may be additional marking, which relates to the logo, the lot trace code information, or the environmental category on the device.

(5) Multiple Device Markings will be inside parentheses. Only one Device Marking contained in parentheses and separated by a "~" will appear on a device. If a line is indented then it is a continuation of the previous line and the two combined represent the entire Device Marking for that device.

(6) Lead finish/Ball material - Orderable Devices may have multiple material finish options. Finish options are separated by a vertical ruled line. Lead finish/Ball material values may wrap to two lines if the finish value exceeds the maximum column width.

Important Information and Disclaimer:The information provided on this page represents TI's knowledge and belief as of the date that it is provided. TI bases its knowledge and belief on information provided by third parties, and makes no representation or warranty as to the accuracy of such information. Efforts are underway to better integrate information from third parties. TI has taken and continues to take reasonable steps to provide representative and accurate information but may not have conducted destructive testing or chemical analysis on incoming materials and chemicals. TI and TI suppliers consider certain information to be proprietary, and thus CAS numbers and other limited information may not be available for release.

In no event shall TI's liability arising out of such information exceed the total purchase price of the TI part(s) at issue in this document sold by TI to Customer on an annual basis.

TAPE AND REEL INFORMATION

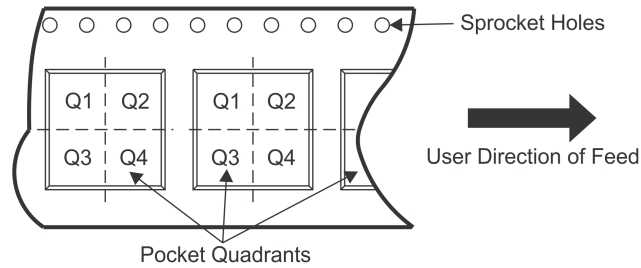
QUADRANT ASSIGNMENTS FOR PIN 1 ORIENTATION IN TAPE

*All dimensions are nominal

Device	Package Type	Package Drawing	Pins	SPQ	Reel Diameter (mm)	Reel Width W1 (mm)	A0 (mm)	B0 (mm)	K0 (mm)	P1 (mm)	W (mm)	Pin1 Quadrant
TPS7A3901DSCR	WSON	DSC	10	3000	330.0	12.4	3.3	3.3	1.0	8.0	12.0	Q1
TPS7A3901D SCT	WSON	DSC	10	250	180.0	12.4	3.3	3.3	1.0	8.0	12.0	Q1

TAPE AND REEL BOX DIMENSIONS

*All dimensions are nominal

Device	Package Type	Package Drawing	Pins	SPQ	Length (mm)	Width (mm)	Height (mm)
TPS7A3901DSCR	WSON	DSC	10	3000	370.0	355.0	55.0
TPS7A3901DST	WSON	DSC	10	250	213.0	191.0	35.0

GENERIC PACKAGE VIEW

DSC 10

WSON - 0.8 mm max height

PLASTIC SMALL OUTLINE - NO LEAD

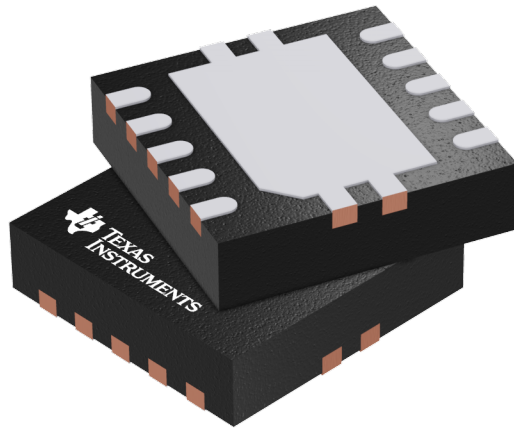

Images above are just a representation of the package family, actual package may vary.
Refer to the product data sheet for package details.

4207383/F

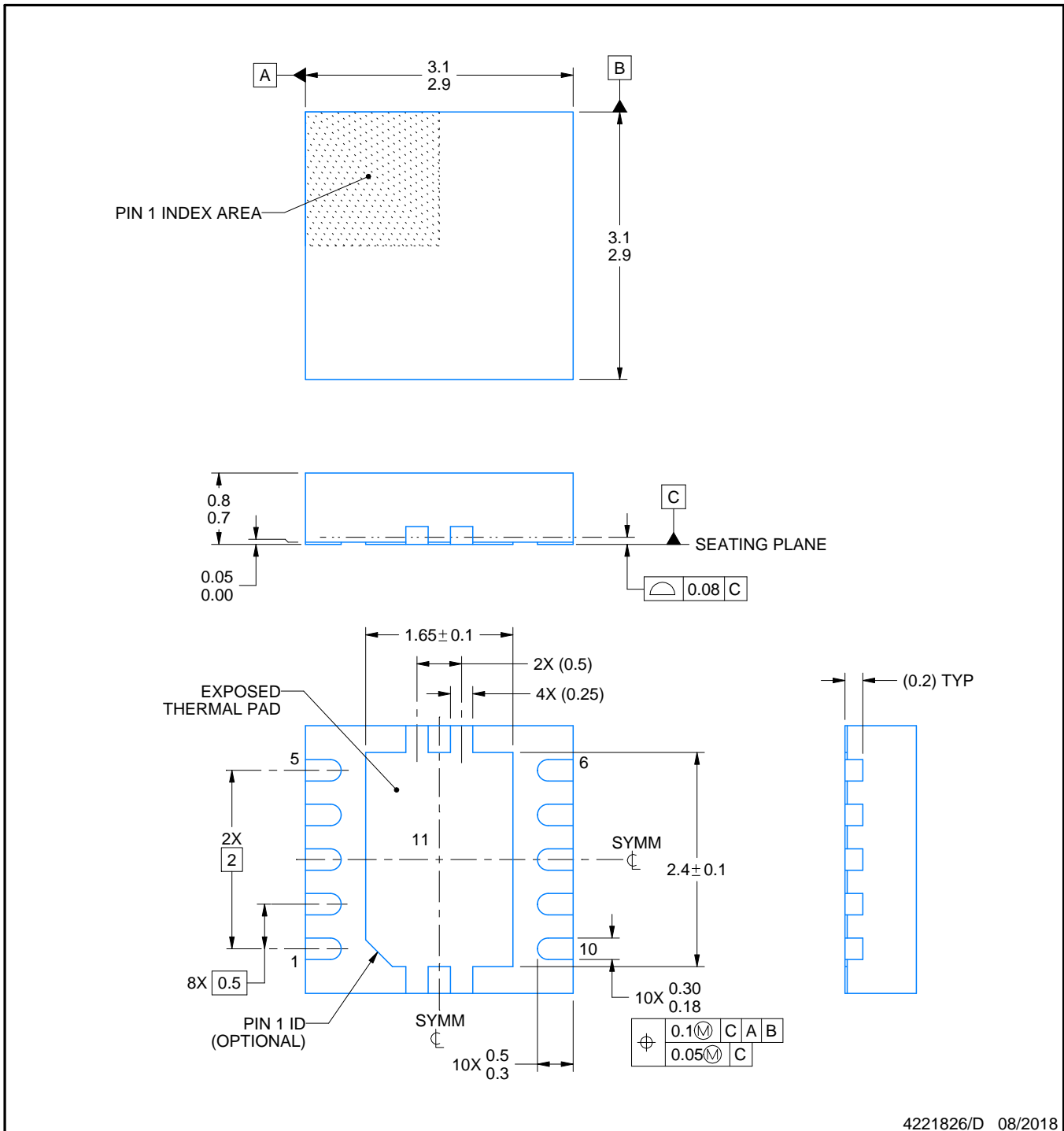
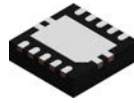

4221826/D 08/2018

NOTES:

1. All linear dimensions are in millimeters. Any dimensions in parenthesis are for reference only. Dimensioning and tolerancing per ASME Y14.5M.
2. This drawing is subject to change without notice.
3. The package thermal pad must be soldered to the printed circuit board for optimal thermal and mechanical performance.

EXAMPLE BOARD LAYOUT

DSC0010J

WSON - 0.8 mm max height

PLASTIC SMALL OUTLINE - NO LEAD



LAND PATTERN EXAMPLE
EXPOSED METAL SHOWN
SCALE:20X

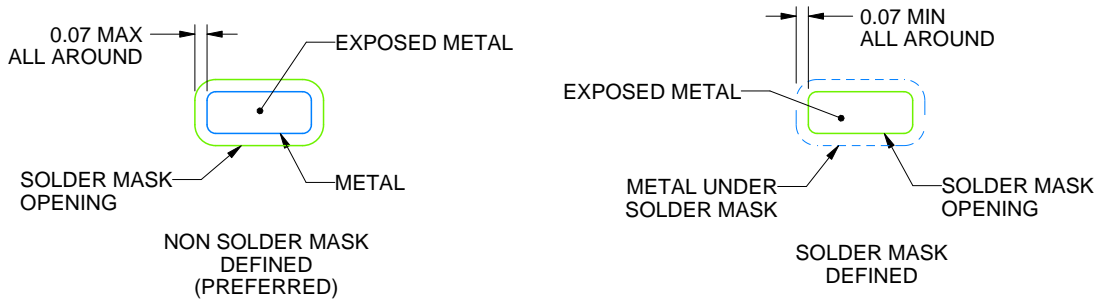

SOLDER MASK DETAILS

4221826/D 08/2018

NOTES: (continued)

4. This package is designed to be soldered to a thermal pad on the board. For more information, see Texas Instruments literature number SLUA271 (www.ti.com/lit/sluea271).
5. Vias are optional depending on application, refer to device data sheet. If any vias are implemented, refer to their locations shown on this view. It is recommended that vias under paste be filled, plugged or tented.

EXAMPLE STENCIL DESIGN

DSC0010J

WSON - 0.8 mm max height

PLASTIC SMALL OUTLINE - NO LEAD



SOLDER PASTE EXAMPLE
BASED ON 0.125 mm THICK STENCIL

EXPOSED PAD 11:
80% PRINTED SOLDER COVERAGE BY AREA
SCALE:25X

4221826/D 08/2018

NOTES: (continued)

6. Laser cutting apertures with trapezoidal walls and rounded corners may offer better paste release. IPC-7525 may have alternate design recommendations.

重要なお知らせと免責事項

TI は、技術データと信頼性データ(データシートを含みます)、設計リソース(リファレンス・デザインを含みます)、アプリケーションや設計に関する各種アドバイス、Web ツール、安全性情報、その他のリソースを、欠陥が存在する可能性のある「現状のまま」提供しており、商品性および特定目的に対する適合性の黙示保証、第三者の知的財産権の非侵害保証を含むいかなる保証も、明示的または黙示的にかかわらず拒否します。

これらのリソースは、TI 製品を使用する設計の経験を積んだ開発者への提供を意図したものです。(1) お客様のアプリケーションに適した TI 製品の選定、(2) お客様のアプリケーションの設計、検証、試験、(3) お客様のアプリケーションが適用される各種規格や、その他のあらゆる安全性、セキュリティ、またはその他の要件を満たしていることを確実にする責任を、お客様のみが単独で負うものとします。上記の各種リソースは、予告なく変更される可能性があります。これらのリソースは、リソースで説明されている TI 製品を使用するアプリケーションの開発の目的でのみ、TI はその使用をお客様に許諾します。これらのリソースに関して、他の目的で複製することや掲載することは禁止されています。TI や第三者の知的財産権のライセンスが付与されている訳ではありません。お客様は、これらのリソースを自身で使用した結果発生するあらゆる申し立て、損害、費用、損失、責任について、TI およびその代理人を完全に補償するものとし、TI は一切の責任を拒否します。

TI の製品は、TI の販売条件 (www.tij.co.jp/ja-jp/legal/termsofsale.html)、または ti.com やかかる TI 製品の関連資料などのいずれかを通じて提供する適用可能な条項の下で提供されています。TI がこれらのリソースを提供することは、適用される TI の保証または他の保証の放棄の拡大や変更を意味するものではありません。

Copyright © 2020, Texas Instruments Incorporated

日本語版 日本テキサス・インスツルメンツ株式会社