

TPS7B84-Q1 150mA、40V、可変、低ドロップアウト・レギュレータ

1 特長

- 車載アプリケーション用に AEC-Q100 認定取得済み
 - 温度グレード 1: -40°C ~ +125°C, T_A
 - 接合部温度: -40°C ~ +150°C, T_J
- 入力電圧範囲: 3V ~ 40V (最大 42V)
- 出力電圧範囲:
 - 調整可能な出力: 1.2V ~ 18V
 - 固定出力: 3.3V, 5V
- 出力電流: 最大 150mA
- 出力電圧精度: $\pm 0.75\%$ 以下
- 低いドロップアウト電圧:
 - 150mA で 225mV 以下 ($V_{OUT} \geq 3.3V$)
- 低い静止電流:
 - 18 μA (標準値)
 - ディセーブル時: 4 μA 以下
- 優れたライン過渡応答:
 - V_{OUT} の $\pm 2\%$ の偏差 (コールド・クラック時)
 - V_{OUT} の $\pm 2\%$ の偏差 (1V/ μs の V_{IN} スルーレート)
- 2.2 μF 以上のコンデンサで安定
- 機能安全対応
 - 機能安全システムの設計に役立つ資料を利用可能
- パッケージ・オプション:
 - DRB (8 ピン VSON)、 $R_{\theta JA}$: 50.8°C/W
 - DCY (4 ピン SOT-223)、 $R_{\theta JA}$: 85.5°C/W

2 アプリケーション

- 再構成可能インストルメント・クラスタ
- 車体制御モジュール (BCM)
- 常時オンのバッテリー接続アプリケーション:
 - 車載ゲートウェイ
 - リモート・キーレス・エントリ (RKE)

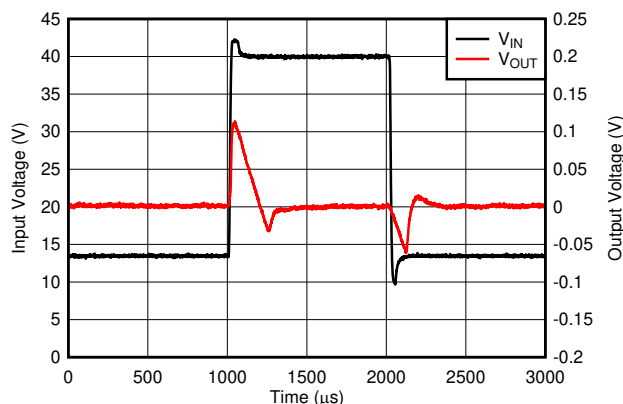

ライン過渡応答 (3V/ μs の V_{IN} スルーレート)

3 概要

TPS7B84-Q1 は、車載用アプリケーションのバッテリーに接続するように設計された低ドロップアウト・リニア・レギュレータです。このデバイスの入力電圧範囲は 40V まで拡張されているため、車載用システムで予測される過渡事象 (負荷ダンプなど) にも耐えられます。このデバイスは静止電流がわずか 18 μA であることから、スタンバイ・システムのマイクロコントローラや CAN (コントローラ・エリア・ネットワーク) トランシーバなどの常時オンのコンポーネントへの電力供給に最適なソリューションです。

TPS7B84-Q1 には、固定と可変の出力タイプがあります。出力電圧範囲が広いこと、MCU やプロセッサに電力を供給するだけでなく、シリコン・カーバイド (SiC) ゲートドライバやマイクのバイアス電圧を生成することもできます。

このデバイスは、負荷やラインの変動 (例: コールド・クラック条件時) に出力が素早く応答できる最先端の過渡応答性能を備えています。またこのデバイスは、ドロップアウトからの回復時に出力オーバーシュートを最小限に抑える革新的なアーキテクチャを採用しています。通常動作時は、ライン、負荷、温度の全範囲にわたって誤差 $\pm 0.75\%$ 以下の高い DC 精度を維持します。

このデバイスは、SOT223 パッケージとコンパクトな PCB (プリント基板) 設計に適したウェットプル・フランク付き小型 VSON パッケージで供給されます。熱抵抗が低いこと、デバイス全体で大きな発熱があっても持続して動作できます。

製品情報(1)

部品番号	パッケージ	本体サイズ (公称)
TPS7B84-Q1	VSON (8)	3.00mm × 3.00mm
	SOT-223 (4)	6.50mm × 3.50mm

(1) 利用可能なすべてのパッケージについては、このデータシートの末尾にある注文情報を参照してください。

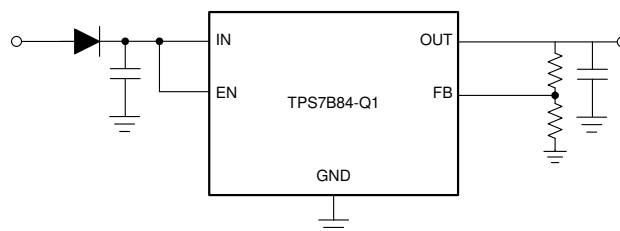

代表的なアプリケーション回路図



Table of Contents

1 特長	1	7.4 Device Functional Modes.....	16
2 アプリケーション	1	8 Application and Implementation	17
3 概要	1	8.1 Application Information.....	17
4 Revision History	2	8.2 Typical Application.....	22
5 Pin Configuration and Functions	3	9 Power Supply Recommendations	23
6 Specifications	4	10 Layout	24
6.1 Absolute Maximum Ratings	4	10.1 Layout Guidelines.....	24
6.2 ESD Ratings	4	10.2 Layout Examples	25
6.3 Recommended Operating Conditions	4	11 Device and Documentation Support	26
6.4 Thermal Information	5	11.1 Device Support.....	26
6.5 Electrical Characteristics	5	11.2 ドキュメントの更新通知を受け取る方法.....	26
6.6 Typical Characteristics.....	7	11.3 サポート・リソース.....	26
7 Detailed Description	13	11.4 Trademarks.....	26
7.1 Overview.....	13	11.5 静電気放電に関する注意事項.....	26
7.2 Functional Block Diagrams	13	11.6 用語集.....	26
7.3 Feature Description.....	14		

4 Revision History

資料番号末尾の英字は改訂を表しています。その改訂履歴は英語版に準じています。

Changes from Revision * (April 2020) to Revision A (November 2020)

	Page
• ドキュメントのステータスを事前情報から量産データに変更.....	1

5 Pin Configuration and Functions



图 5-1. DCY Package, 4-Pin SOT-223, Top View



图 5-2. DRB Package, 8-Pin VSON, Top View

表 5-1. Pin Functions

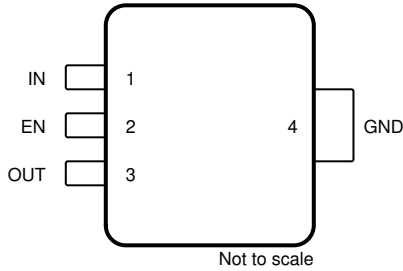
NAME	PIN		TYPE ⁽¹⁾	DESCRIPTION
	DCY	DRB		
EN	2	7	I	Enable pin. The device is disabled when the enable pin becomes lower than the enable logic input low level (V_{IL}). To ensure the device is enabled, the EN pin must be driven above the logic high level (V_{IH}). This pin should not be left floating as this pin is high impedance if it is left floating the part may enable or disable.
GND	4	5	G	Ground pin. Connect this pin to the thermal pad with a low-impedance connection.
FB/NC	—	2	I	Feedback pin when using an external resistor divider or an NC pin when using the device with a fixed output voltage. When using the adjustable device this pin must be connected through a resistor divider to the output for the device to function.
NC	—	3, 4, 6	—	No internal connection. Connect these pins to GND for the best thermal performance.
IN	1	8	I	Input power-supply voltage pin. For best transient response and to minimize input impedance, use the recommended value or larger ceramic capacitor from IN to ground as listed in the <i>Recommended Operating Conditions</i> table and the <i>Input Capacitor</i> section. Place the input capacitor as close to the input of the device as possible.
OUT	3	1	O	Regulated output voltage pin. A capacitor is required from OUT to ground for stability. For best transient response, use the nominal recommended value or larger ceramic capacitor from OUT to ground; see the <i>Recommended Operating Conditions</i> table and the <i>Output Capacitor</i> section. Place the output capacitor as close to output of the device as possible. If using a high ESR capacitor, decouple the output with a 100-nF ceramic capacitor.
Thermal pad	—	Pad	—	Thermal pad. Connect the pad to GND for the best possible thermal performance. See the <i>Layout</i> section for more information.

(1) I = input; O = output; G = ground.

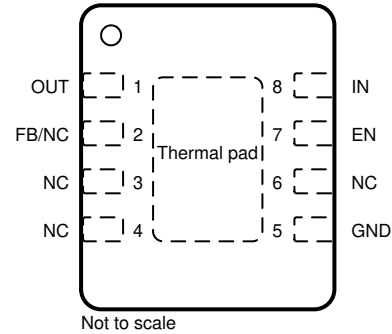
6 Specifications

6.1 Absolute Maximum Ratings

over operating free-air temperature range (unless otherwise noted)⁽¹⁾

		MIN	MAX	UNIT
IN	Unregulated input	-0.3	42	V
EN	Enable input	-0.3	42	V
OUT	Regulated output	-0.3	$V_{IN} + 0.3^{(2)}$	V
FB	Feedback	-0.3	20	V
T _A	Operating ambient temperature	-40	125	°C
T _J	Operating junction temperature	-40	150	°C
T _{stg}	Storage temperature	-65	150	°C

- Stresses beyond those listed under *absolute maximum ratings* may cause permanent damage to the device. These are stress ratings only and functional operation of the device at these or any other conditions beyond those indicated under *recommended operating conditions* is not implied. Exposure to absolute-maximum-rated conditions for extended periods may affect device reliability.
- The absolute maximum rating is $V_{IN} + 0.3$ V or 20 V, whichever is smaller.

6.2 ESD Ratings

			VALUE	UNIT	
V _(ESD)	Electrostatic discharge	Human-body model (HBM), per AEC Q100-002 ⁽¹⁾	±2000	V	
		Charged-device model (CDM), per AEC Q100-011	All pins		±500
			Corner pins		±750

- AEC Q100-002 indicates that HBM stressing shall be in accordance with the ANSI/ESDA/JEDEC JS-001 specification.

6.3 Recommended Operating Conditions

over operating free-air temperature range (unless otherwise noted)

		MIN	TYP	MAX	UNIT
V _{IN}	Input voltage	3		40	V
V _{OUT}	Output voltage	1.2		18	V
I _{OUT}	Output current	0		150	mA
F _{EN}	Enable pin frequency ⁽¹⁾			5	kHz
V _{EN}	High voltage (I/O)	0		40	V
C _{OUT}	Output capacitor ⁽³⁾	2.2		220	μF
ESR	Output capacitor ESR requirements ⁽⁴⁾	0.001		2	Ω
C _{IN}	Input capacitor ⁽²⁾	0.1	1		μF
T _J	Operating junction temperature	-40		150	°C

- Minimum pulse time on the EN pin is 100 μs.
- For robust EMI performance the minimum input capacitance is 500 nF.
- Effective output capacitance of 1 μF minimum required for stability.
- If using a large ESR capacitor it is recommended to decouple this with a 100-nF ceramic capacitor to improve transient performance.

6.4 Thermal Information

THERMAL METRIC ^{(1) (2)}		TPS7B84-Q1		Unit
		DRB (VSON)	DCY	
		8 PINS	4 PINS	
R _{θJA}	Junction-to-ambient thermal resistance ⁽³⁾	50.8	85.5	°C/W
R _{θJC(top)}	Junction-to-case (top) thermal resistance	55.6	46.6	°C/W
R _{θJB}	Junction-to-board thermal resistance	22.9	11.3	°C/W
ψ _{JT}	Junction-to-top characterization parameter	1.2	4.9	°C/W
ψ _{JB}	Junction-to-board characterization parameter	22.9	11	°C/W
R _{θJC(bot)}	Junction-to-case (bottom) thermal resistance	7.5	11	°C/W

- (1) The thermal data is based on the JEDEC standard high K profile, JESD 51-7. Two-signal, two-plane, four-layer board with 2-oz. copper. The copper pad is soldered to the thermal land pattern. Also, correct attachment procedure must be incorporated.
- (2) For more information about traditional and new thermal metrics, see the [Semiconductor and IC Package Thermal Metrics](#) application report.
- (3) The 1s0p R_{θJA} is 212.7°C/W for the DRB package and 168.8°C/W for the DCY package.

6.5 Electrical Characteristics

specified at T_J = -40°C to +150°C, V_{IN} = 13.5 V, I_{OUT} = 0 mA, C_{OUT} = 2.2 μF, 1 mΩ < C_{OUT} ESR < 2 Ω, C_{IN} = 1 μF, and V_{EN} = 2 V (unless otherwise noted); typical values are at T_J = 25°C

PARAMETER		TEST CONDITIONS		MIN	TYP	MAX	UNIT
V _{OUT}	Regulated output accuracy	V _{IN} = V _{OUT} + 500 mV to 40 V, I _{OUT} = 100 μA to 150 mA ⁽²⁾ ⁽¹⁾	T _J = 25°C	-0.5		0.5	%
			T _J = -40°C to +150°C	-0.75		0.75	
V _{OUT}	Regulated output accuracy DCY	V _{IN} = V _{OUT} + 500 mV to 40 V, I _{OUT} = 100 μA to 150 mA ⁽²⁾ ⁽¹⁾	T _J = 25°C	-0.75		0.75	%
			T _J = -40°C to +150°C	-1		1	
ΔV _{OUT(ΔVIN)}	Line regulation	Change in percent of output voltage	V _{IN} = V _{OUT} + 500 mV to 40 V, I _{OUT} = 100 μA			0.2	%
ΔV _{OUT(ΔIOUT)}	Load regulation	Change in percent of output voltage	V _{IN} = V _{OUT} + 500 mV, I _{OUT} = 100 μA to 150 mA, V _{OUT} ≥ 3.3 V			0.2	
ΔV _{OUT(ΔIOUT)}	Load regulation (Adjustable output only)	Change in percent of output voltage	V _{IN} = V _{OUT} + 500 mV, I _{OUT} = 100 μA to 150 mA, V _{OUT} < 3.3 V			0.3	%
ΔV _{OUT}	Load transient response settling time ^{(4) (5)}	C _{OUT} = 10 μF	C _{OUT} = 10 μF			100	μs
	Load transient response overshoot, undershoot ⁽⁵⁾		I _{OUT} = 45 mA to 105 mA	-2%		10%	
			I _{OUT} = 0 mA to 150 mA	-10%			
I _Q	Quiescent current	V _{IN} = V _{OUT} + 500 mV to 40 V, I _{OUT} = 0 mA ⁽²⁾	T _J = 25°C		18	21	μA
			T _J = -40°C to +150°C			26	
			I _{OUT} = 500 μA ⁽²⁾	T _J = -40°C to +150°C			
I _{SHUTDOWN}	Shutdown supply current (I _{GND})	V _{EN} = 0 V	T _J = 25°C			2.5	μA
			T _J = -40°C to +150°C			4	
V _{DO}	Dropout voltage (DCY package)	I _{OUT} ≤ 1 mA, V _{OUT} ≥ 3.3 V, V _{IN} = V _{OUT(NOM)} × 0.95				47	mV
			I _{OUT} = 105 mA, V _{OUT} ≥ 3.3 V, V _{IN} = V _{OUT(NOM)}		130	180	
			I _{OUT} = 150 mA, V _{OUT} ≥ 3.3 V, V _{IN} = V _{OUT(NOM)}		160	230	

6.5 Electrical Characteristics (continued)

specified at $T_J = -40^\circ\text{C}$ to $+150^\circ\text{C}$, $V_{IN} = 13.5\text{ V}$, $I_{OUT} = 0\text{ mA}$, $C_{OUT} = 2.2\ \mu\text{F}$, $1\text{ m}\Omega < C_{OUT}\text{ ESR} < 2\ \Omega$, $C_{IN} = 1\ \mu\text{F}$, and $V_{EN} = 2\text{ V}$ (unless otherwise noted); typical values are at $T_J = 25^\circ\text{C}$

PARAMETER		TEST CONDITIONS	MIN	TYP	MAX	UNIT
V_{DO}	Dropout voltage (fixed output DRB package)	$I_{OUT} \leq 1\text{ mA}$, $V_{OUT} \geq 3.3\text{ V}$, $V_{IN} = V_{OUT(NOM)} \times 0.95$			43	mV
		$I_{OUT} = 105\text{ mA}$, $V_{OUT} \geq 3.3\text{ V}$, $V_{IN} = V_{OUT(NOM)}$		125	175	
		$I_{OUT} = 150\text{ mA}$, $V_{OUT} \geq 3.3\text{ V}$, $V_{IN} = V_{OUT(NOM)}$		155	225	
V_{DO}	Dropout voltage adjustable output DRB package	$I_{OUT} \leq 1\text{ mA}$, $V_{IN} = 3\text{ V}$, $V_{FB} = 0.61\text{ V}^{(3)}$			43	mV
		$I_{OUT} = 105\text{ mA}$, $V_{IN} = 3\text{ V}$, $V_{FB} = 0.61\text{ V}^{(3)}$		140	195	
	Dropout voltage adjustable output	$I_{OUT} = 150\text{ mA}$, $V_{IN} = 3\text{ V}$, $V_{FB} = 0.61\text{ V}^{(3)}$		175	245	
V_{FB}	Feedback voltage	Reference voltage for FB	0.645	0.65	0.655	V
I_{FB}	Feedback current		-10		10	nA
$V_{UVLO(RISING)}$	Rising input supply UVLO	V_{IN} rising	2.6	2.7	2.82	V
$V_{UVLO(FALLING)}$	Falling input supply UVLO	V_{IN} falling	2.38	2.5	2.6	V
$V_{UVLO(HYST)}$	V_{UVLO} hysteresis			230		mV
V_{IL}	Enable logic input low level				0.7	V
V_{IH}	Enable logic input high level		2			V
I_{EN}	EN pin current	$V_{EN} = V_{IN} = 13.5\text{ V}$			50	nA
I_{CL}	Output current limit	$V_{IN} = V_{OUT(nom)} + 1\text{ V}$, V_{OUT} short to $90\% \times V_{OUT(NOM)}$	180	220	260	mA
PSRR	Power-supply ripple rejection	$V_{IN} - V_{OUT} = 500\text{ mV}$, frequency = 1 kHz, $I_{OUT} = 150\text{ mA}$		55		dB
V_n	Output noise voltage	$V_{OUT} = 3.3\text{ V}$, BW = 10 Hz to 100 kHz		280		μV_{RMS}
$T_{SD(SHUTDOWN)}$	Junction shutdown temperature			175		$^\circ\text{C}$
$T_{SD(HYST)}$	Hysteresis of thermal shutdown			20		$^\circ\text{C}$

- (1) Power dissipation is limited to 2W for IC production testing purposes. The power dissipation can be higher during normal operation. Please see the thermal dissipation section for more information on how much power the device can dissipate while maintaining a junction temperature below 150°C .
- (2) For adjustable devices this parameter is tested in unity gain, so resistor divider tolerances and current is not included.
- (3) Dropout is not measured for $V_{IN} \leq 3\text{ V}$.
- (4) The settling time is measured from when I_{OUT} is stepped from 45mA to 105 mA to when the output voltage recovers to $V_{OUT} = V_{OUT(nom)} - 5\text{ mV}$.
- (5) This specification is specified by design.

6.6 Typical Characteristics

specified at $T_J = -40^{\circ}\text{C}$ to $+150^{\circ}\text{C}$, $V_{IN} = 13.5\text{ V}$, $I_{OUT} = 100\ \mu\text{A}$, $C_{OUT} = 2.2\ \mu\text{F}$, $1\ \text{m}\Omega < C_{OUT}\ \text{ESR} < 2\ \Omega$, $C_{IN} = 1\ \mu\text{F}$, and $V_{EN} = 2\ \text{V}$ (unless otherwise noted)

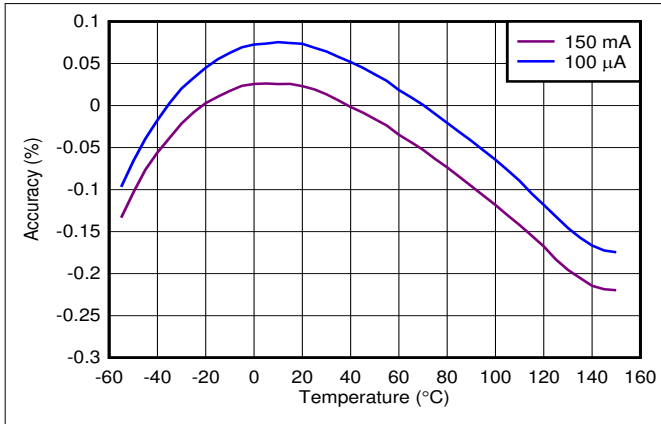
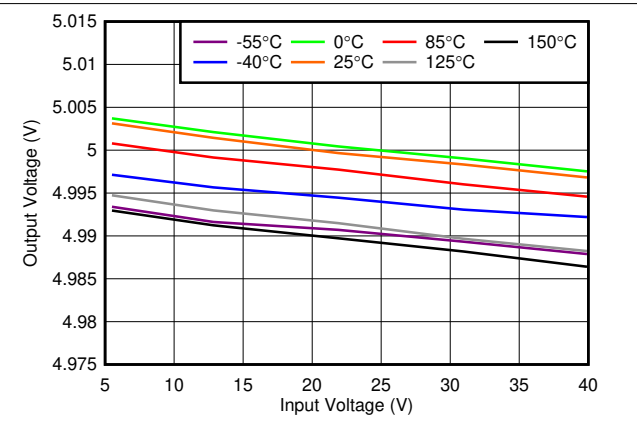
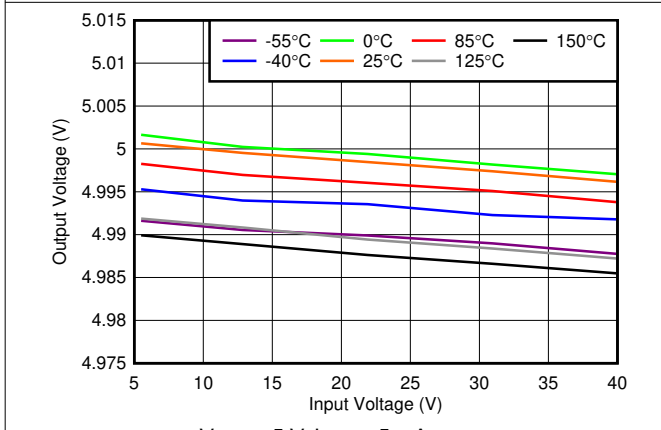

Figure 6-1. Accuracy vs Temperature



$V_{OUT} = 5\ \text{V}$, $I_{OUT} = 150\ \text{mA}$

Figure 6-2. Line Regulation vs V_{IN}



$V_{OUT} = 5\ \text{V}$, $I_{OUT} = 5\ \text{mA}$

Figure 6-3. Line Regulation vs V_{IN}

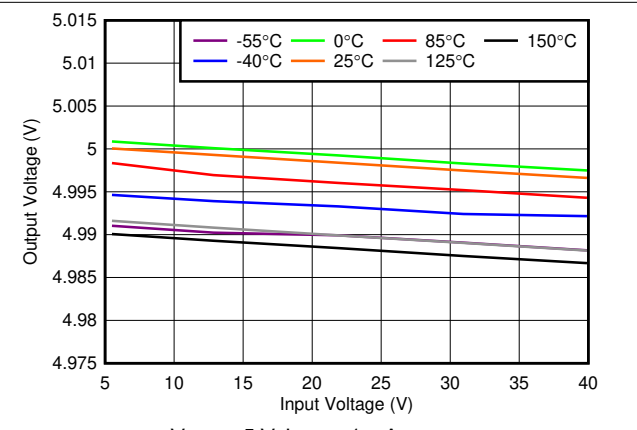

$V_{OUT} = 5\ \text{V}$, $I_{OUT} = 1\ \text{mA}$

Figure 6-4. Line Regulation vs V_{IN}

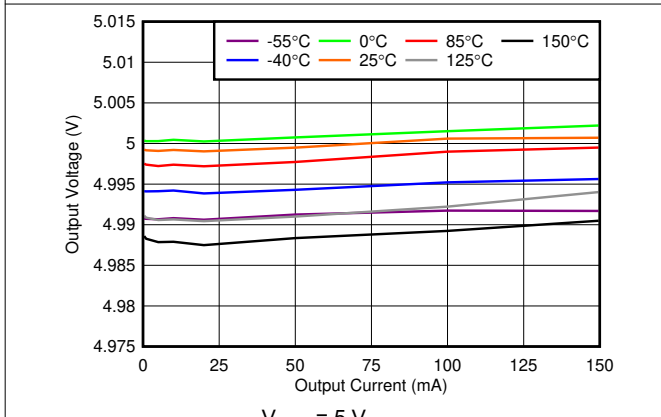

$V_{OUT} = 5\ \text{V}$

Figure 6-5. Load Regulation vs I_{OUT}

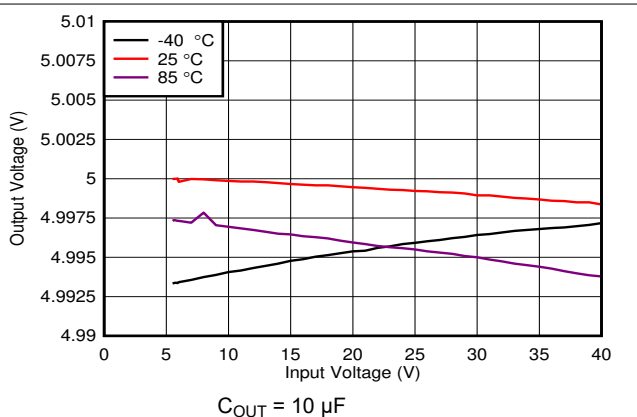

$C_{OUT} = 10\ \mu\text{F}$

Figure 6-6. Line Regulation at 50 mA

6.6 Typical Characteristics (continued)

specified at $T_J = -40^{\circ}\text{C}$ to $+150^{\circ}\text{C}$, $V_{IN} = 13.5\text{ V}$, $I_{OUT} = 100\ \mu\text{A}$, $C_{OUT} = 2.2\ \mu\text{F}$, $1\ \text{m}\Omega < C_{OUT}\ \text{ESR} < 2\ \Omega$, $C_{IN} = 1\ \mu\text{F}$, and $V_{EN} = 2\ \text{V}$ (unless otherwise noted)

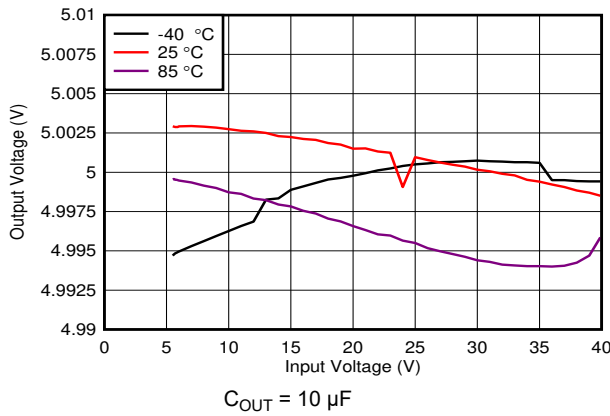

6-7. Line Regulation at 100 mA

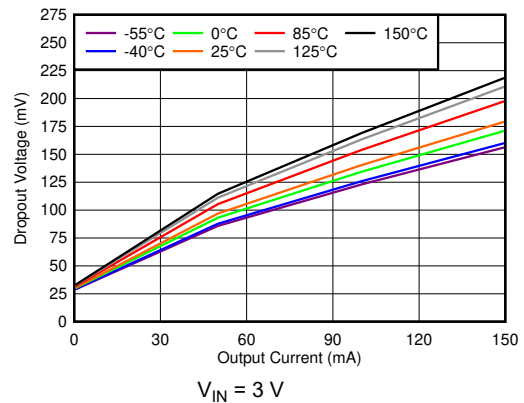

6-8. Dropout Voltage (V_{DO}) vs I_{OUT}

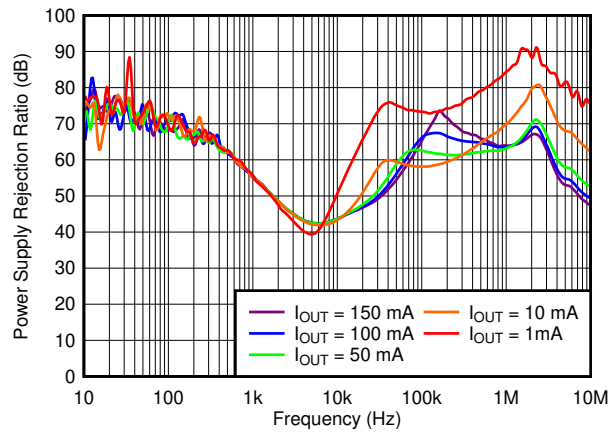

6-9. PSRR vs Frequency and I_{OUT}

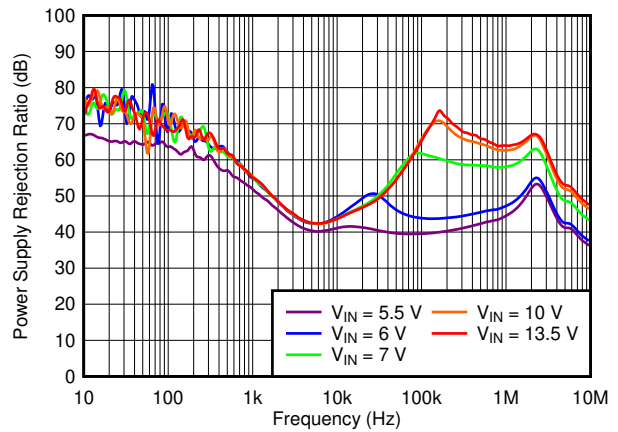

6-10. PSRR vs Frequency and V_{IN}

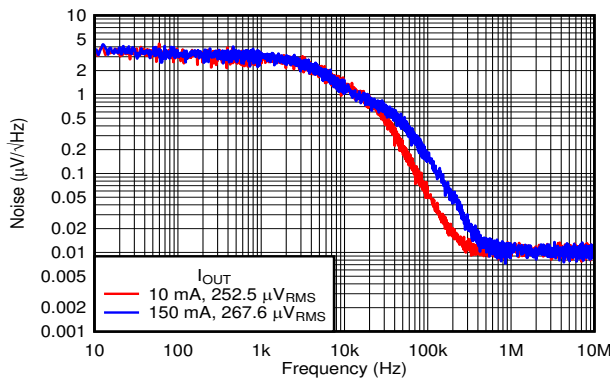

6-11. Noise vs Frequency at 3.3 V

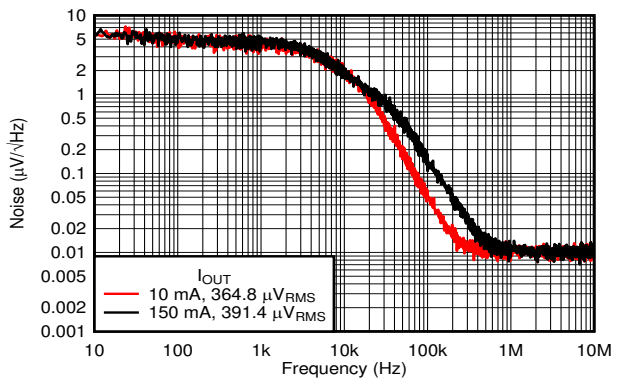

6-12. Noise vs Frequency at 5.0 V

6.6 Typical Characteristics (continued)

specified at $T_J = -40^\circ\text{C}$ to $+150^\circ\text{C}$, $V_{IN} = 13.5\text{ V}$, $I_{OUT} = 100\ \mu\text{A}$, $C_{OUT} = 2.2\ \mu\text{F}$, $1\ \text{m}\Omega < C_{OUT}\ \text{ESR} < 2\ \Omega$, $C_{IN} = 1\ \mu\text{F}$, and $V_{EN} = 2\ \text{V}$ (unless otherwise noted)

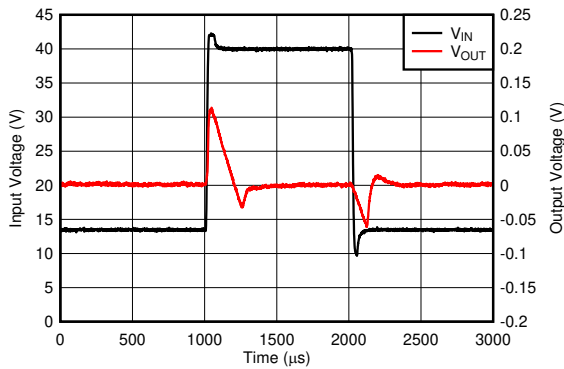

$V_{OUT} = 5\ \text{V}$, $I_{OUT} = 1\ \text{mA}$, $V_{IN} = 13.5\ \text{V}$ to $40\ \text{V}$,
slew rate = $2.7\ \text{V}/\mu\text{s}$, $V_{EN} = 3.3\ \text{V}$, $C_{OUT} = 10\ \mu\text{F}$

6-13. Line Transients at 13.5 V to 40 V

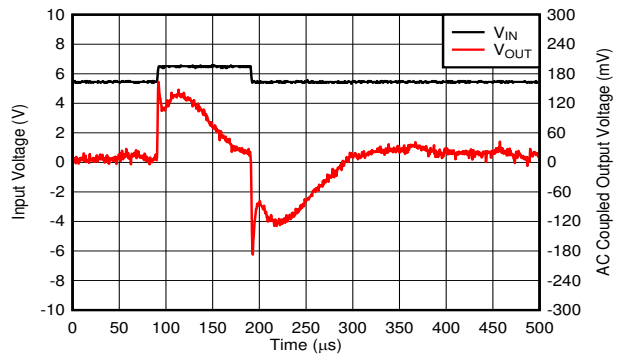

$V_{OUT} = 5\ \text{V}$, $V_{IN} = 5.5\ \text{V}$ to $6.5\ \text{V}$, $t_{\text{rise}} = 1\ \mu\text{s}$, $C_{OUT} = 10\ \mu\text{F}$

6-14. Line Transients at 5.5 V to 6.5 V

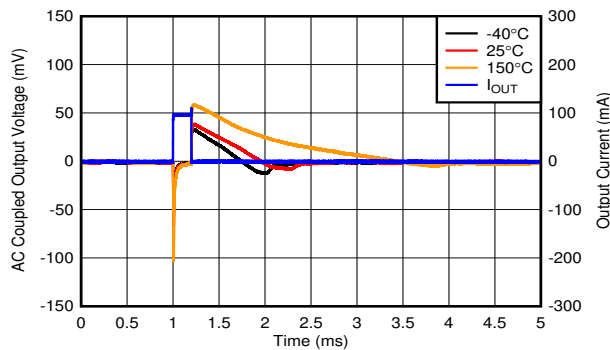

$V_{OUT} = 5\ \text{V}$, $I_{OUT} = 0\ \text{mA}$ to $100\ \text{mA}$, slew rate = $1\ \text{A}/\mu\text{s}$,
 $V_{EN} = 3.3\ \text{V}$, $C_{OUT} = 10\ \mu\text{F}$

6-15. Load Transient, No Load to 100 mA

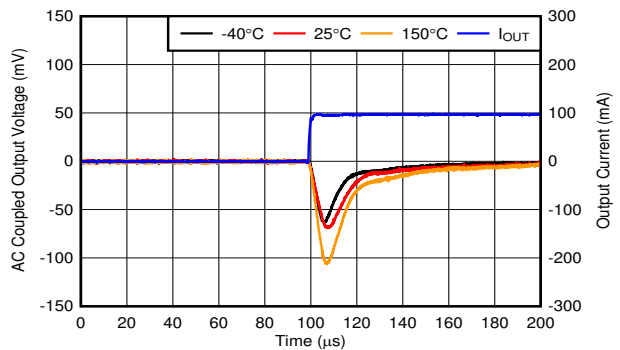

$V_{OUT} = 5\ \text{V}$, $I_{OUT} = 0\ \text{mA}$ to $100\ \text{mA}$, slew rate = $1\ \text{A}/\mu\text{s}$,
 $V_{EN} = 3.3\ \text{V}$, $C_{OUT} = 10\ \mu\text{F}$

6-16. Load Transient, No Load to 100-mA Rising Edge

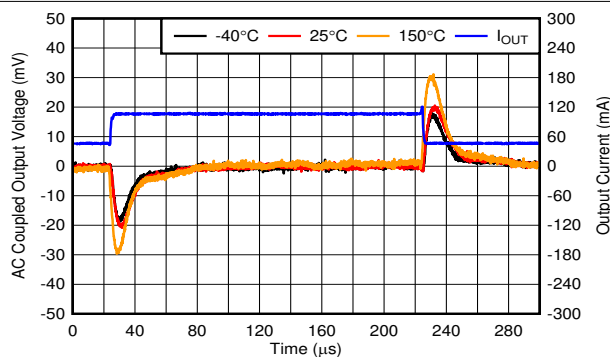

$V_{OUT} = 5\ \text{V}$, $I_{OUT} = 45\ \text{mA}$ to $105\ \text{mA}$, slew rate = $0.1\ \text{A}/\mu\text{s}$,
 $V_{EN} = 3.3\ \text{V}$, $C_{OUT} = 10\ \mu\text{F}$

6-17. Load Transient, 45 mA to 105 mA

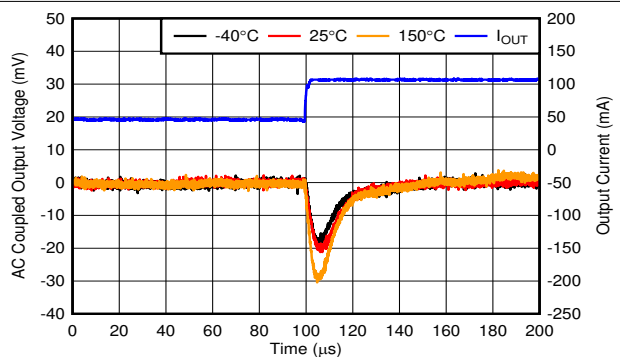

$V_{OUT} = 5\ \text{V}$, $I_{OUT} = 45\ \text{mA}$ to $105\ \text{mA}$, slew rate = $0.1\ \text{A}/\mu\text{s}$,
 $V_{EN} = 3.3\ \text{V}$, $C_{OUT} = 10\ \mu\text{F}$

6-18. Load Transient, 45-mA to 105-mA Rising Edge

6.6 Typical Characteristics (continued)

specified at $T_J = -40^\circ\text{C}$ to $+150^\circ\text{C}$, $V_{IN} = 13.5\text{ V}$, $I_{OUT} = 100\ \mu\text{A}$, $C_{OUT} = 2.2\ \mu\text{F}$, $1\ \text{m}\Omega < C_{OUT}\ \text{ESR} < 2\ \Omega$, $C_{IN} = 1\ \mu\text{F}$, and $V_{EN} = 2\ \text{V}$ (unless otherwise noted)

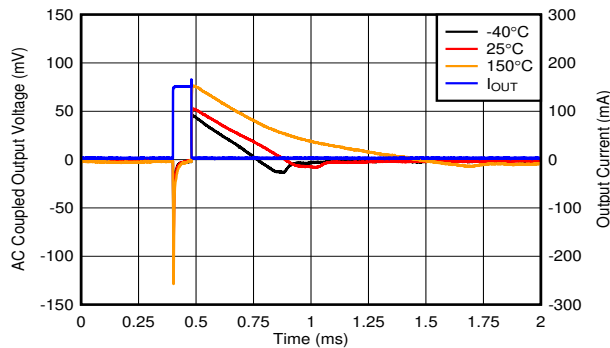

$V_{OUT} = 5\ \text{V}$, $I_{OUT} = 0\ \text{mA}$ to $150\ \text{mA}$, slew rate = $1\ \text{A}/\mu\text{s}$, $V_{EN} = 3.3\ \text{V}$, $C_{OUT} = 10\ \mu\text{F}$

6-19. Load Transient, No Load to 150 mA

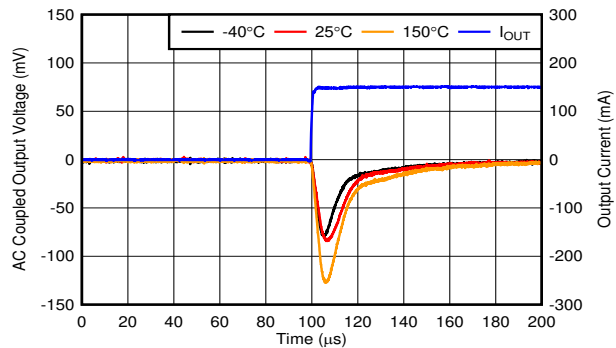

$V_{OUT} = 5\ \text{V}$, $I_{OUT} = 0\ \text{mA}$ to $150\ \text{mA}$, slew rate = $1\ \text{A}/\mu\text{s}$, $V_{EN} = 3.3\ \text{V}$, $C_{OUT} = 10\ \mu\text{F}$

6-20. Load Transient, No Load to 150-mA Rising Edge

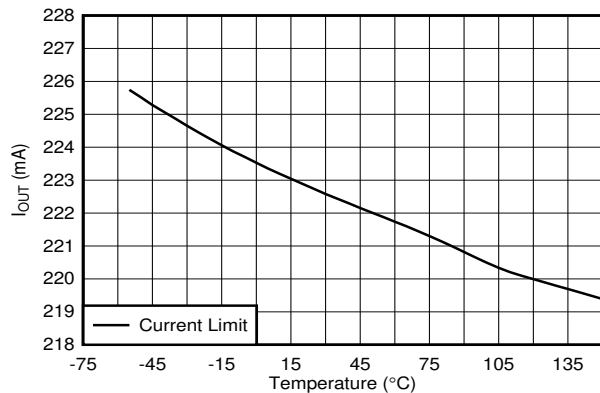

$V_{IN} = V_{OUT} + 1\ \text{V}$, $V_{OUT} = 90\% \times V_{OUT(NOM)}$

6-21. Output Current Limit vs Temperature

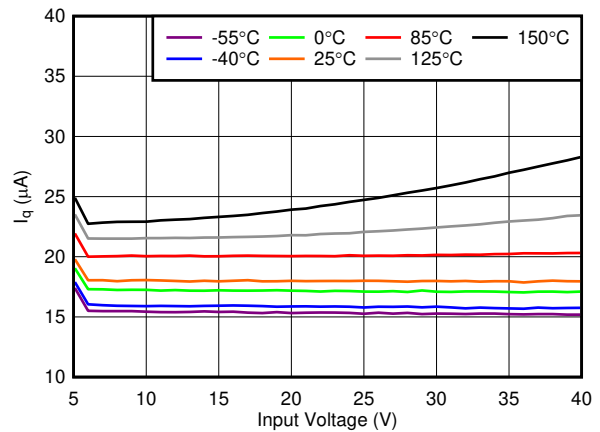

$V_{OUT} = 5\ \text{V}$

6-22. Quiescent Current (I_Q) vs V_{IN}

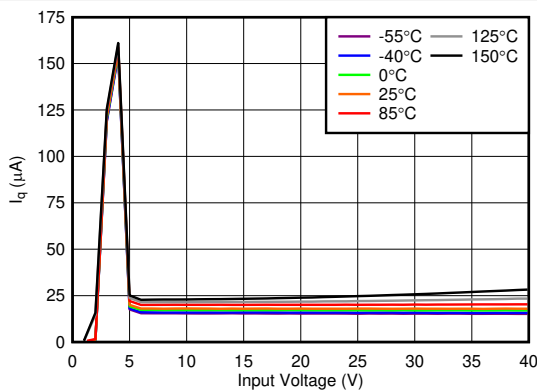

$V_{OUT} = 5\ \text{V}$

6-23. Quiescent Current (I_Q) vs V_{IN}

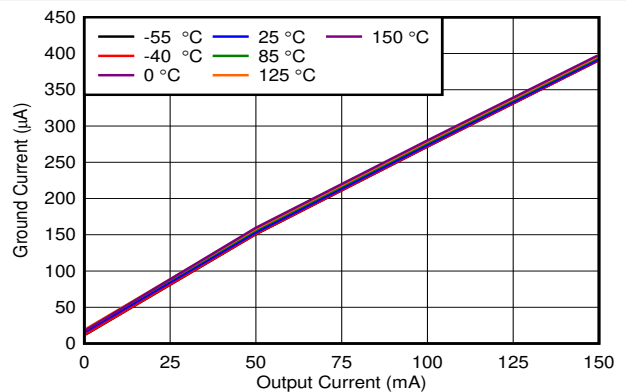

6-24. Ground Current (I_{GND}) vs I_{OUT}

6.6 Typical Characteristics (continued)

specified at $T_J = -40^{\circ}\text{C}$ to $+150^{\circ}\text{C}$, $V_{IN} = 13.5\text{ V}$, $I_{OUT} = 100\ \mu\text{A}$, $C_{OUT} = 2.2\ \mu\text{F}$, $1\ \text{m}\Omega < C_{OUT}\ \text{ESR} < 2\ \Omega$, $C_{IN} = 1\ \mu\text{F}$, and $V_{EN} = 2\ \text{V}$ (unless otherwise noted)

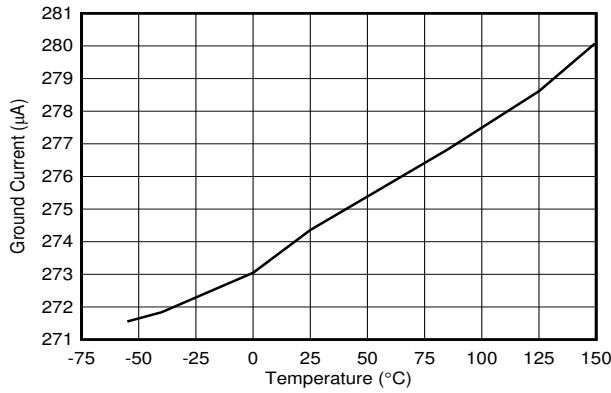

$I_{OUT} = 100\ \text{mA}$
6-25. Ground Current

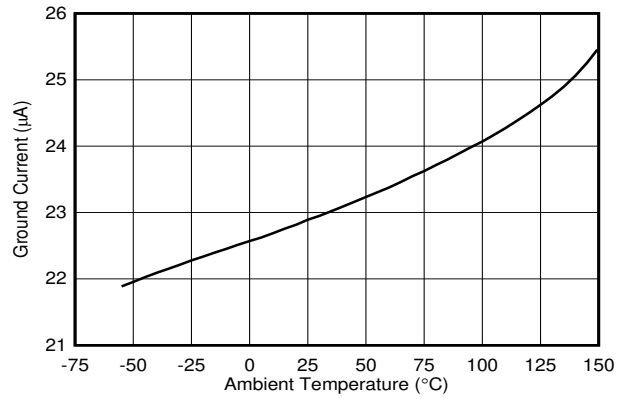

$I_{OUT} = 500\ \mu\text{A}$
6-26. Ground Current

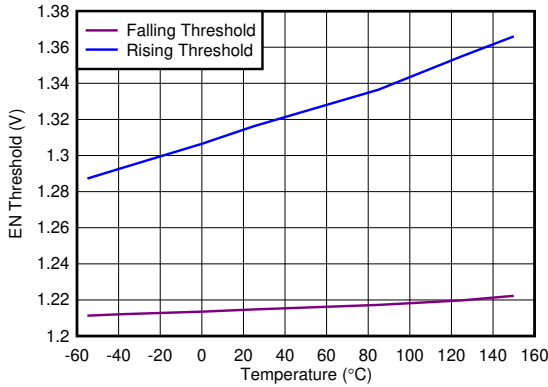

6-27. EN Threshold vs Temperature

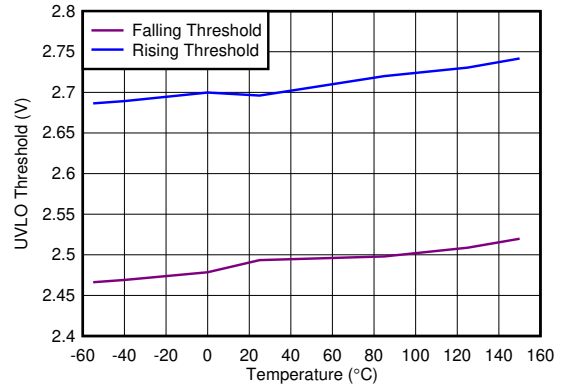

6-28. Undervoltage Lockout (UVLO) Threshold vs Temperature

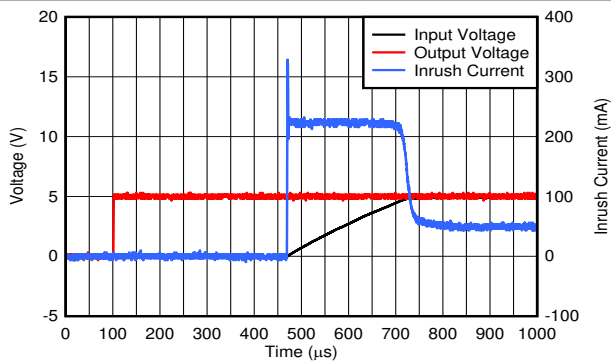

$V_{IN} = 13.5\ \text{V}$, $C_{OUT} = 10\ \mu\text{F}$
6-29. Startup Plot With EN

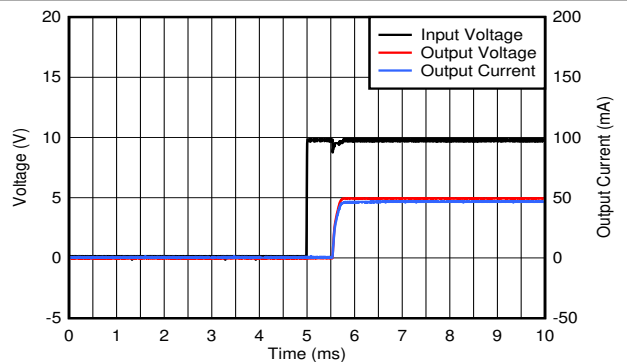

$C_{OUT} = 10\ \mu\text{F}$
6-30. Startup Plot

6.6 Typical Characteristics (continued)

specified at $T_J = -40^\circ\text{C}$ to $+150^\circ\text{C}$, $V_{IN} = 13.5\text{ V}$, $I_{OUT} = 100\ \mu\text{A}$, $C_{OUT} = 2.2\ \mu\text{F}$, $1\ \text{m}\Omega < C_{OUT}\ \text{ESR} < 2\ \Omega$, $C_{IN} = 1\ \mu\text{F}$, and $V_{EN} = 2\ \text{V}$ (unless otherwise noted)

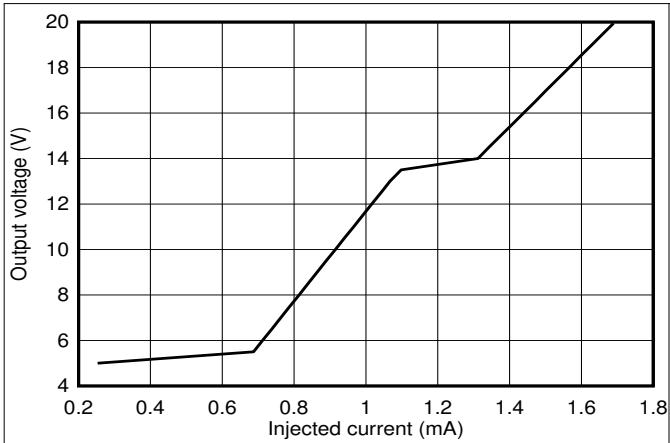

6-31. Output Voltage vs Injected Current

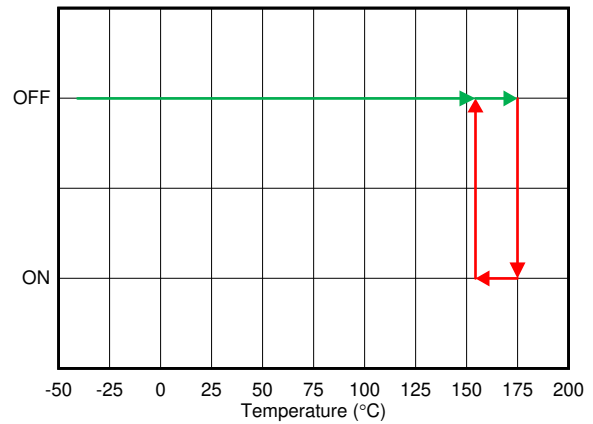

6-32. Thermal Shutdown

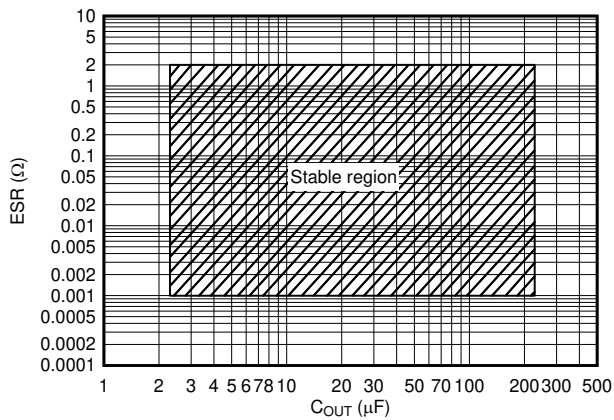

6-33. Stability ESR vs C_{OUT}

7 Detailed Description

7.1 Overview

The TPS7B84-Q1 is a low-dropout linear regulator (LDO) designed to connect to the battery in automotive applications. The device has an input voltage range extending to 40 V, which allows the device to withstand transients (such as load dumps) that are anticipated in automotive systems. With only a 18- μ A quiescent current at light loads, the device is an optimal solution for powering always-on components.

The device has a state-of-the-art transient response that allows the output to quickly react to changes in the load or line (for example, during cold-crank conditions). Additionally, the device has a novel architecture that minimizes output overshoot when recovering from dropout. During normal operation, the device has a tight DC accuracy of $\pm 0.75\%$ over line, load, and temperature.

7.2 Functional Block Diagrams

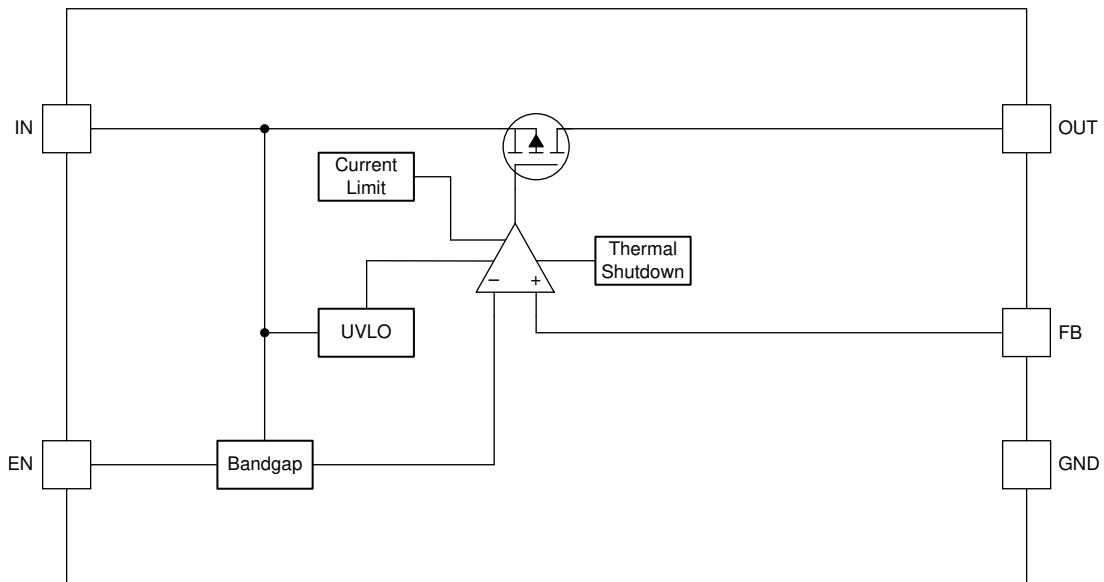

7-1. Adjustable Output Block Diagram

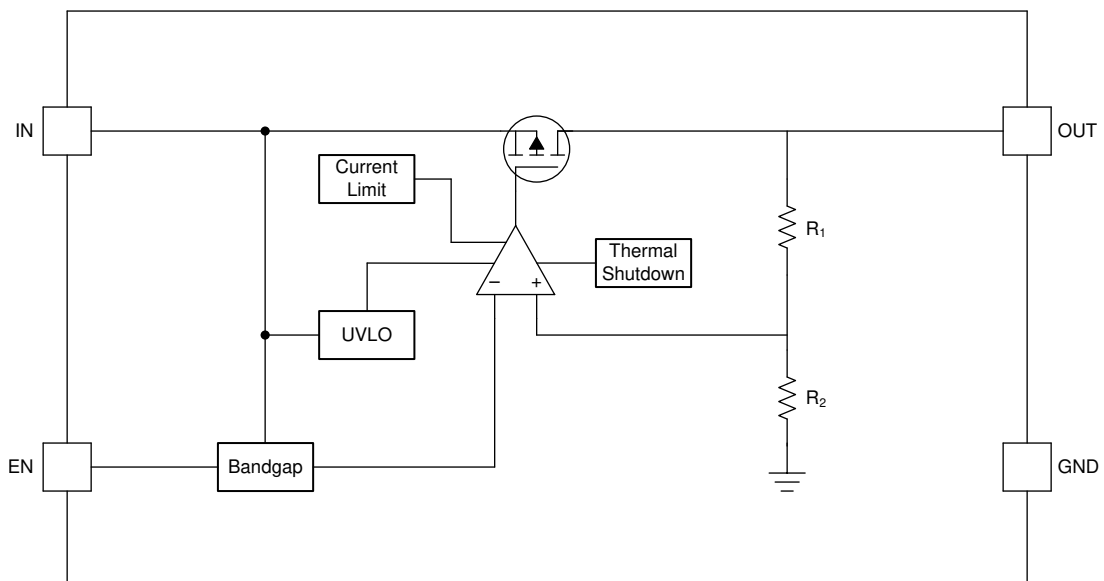

7-2. Fixed Output Block Diagram

7.3 Feature Description

7.3.1 Enable (EN)

The enable pin for the device is an active-high pin. The output voltage is enabled when the voltage of the enable pin is greater than the high-level input voltage of the EN pin and disabled with the enable pin voltage is less than the low-level input voltage of the EN pin. If independent control of the output voltage is not needed, connect the enable pin to the input of the device.

7.3.2 Undervoltage Lockout

The device has an independent undervoltage lockout (UVLO) circuit that monitors the input voltage, allowing a controlled and consistent turn on and off of the output voltage. To prevent the device from turning off if the input drops during turn on, the UVLO has hysteresis as specified in the *Electrical Characteristics* table.

7.3.3 Thermal Shutdown

The device contains a thermal shutdown protection circuit to disable the device when the junction temperature (T_J) of the pass transistor rises to $T_{SD(\text{shutdown})}$ (typical). Thermal shutdown hysteresis assures that the device resets (turns on) when the temperature falls to $T_{SD(\text{reset})}$ (typical).

The thermal time-constant of the semiconductor die is fairly short, thus the device may cycle on and off when thermal shutdown is reached until power dissipation is reduced. Power dissipation during startup can be high from large $V_{IN} - V_{OUT}$ voltage drops across the device or from high inrush currents charging large output capacitors. Under some conditions, the thermal shutdown protection disables the device before startup completes.

For reliable operation, limit the junction temperature to the maximum listed in the *Recommended Operating Conditions* table. Operation above this maximum temperature causes the device to exceed its operational specifications. Although the internal protection circuitry of the device is designed to protect against thermal overall conditions, this circuitry is not intended to replace proper heat sinking. Continuously running the device into thermal shutdown or above the maximum recommended junction temperature reduces long-term reliability.

7.3.4 Current Limit

The device has an internal current limit circuit that protects the regulator during transient high-load current faults or shorting events. The current limit is a brickwall scheme. In a high-load current fault, the brickwall scheme limits the output current to the current limit (I_{CL}). I_{CL} is listed in the *Electrical Characteristics* table.

The output voltage is not regulated when the device is in current limit. When a current limit event occurs, the device begins to heat up because of the increase in power dissipation. When the device is in brickwall current limit, the pass transistor dissipates power $[(V_{IN} - V_{OUT}) \times I_{CL}]$. If thermal shutdown is triggered, the device turns off. After the device cools down, the internal thermal shutdown circuit turns the device back on. If the output current fault condition continues, the device cycles between current limit and thermal shutdown. For more information on current limits, see the [Know Your Limits application report](#).

Figure 7-3 shows a diagram of the current limit.

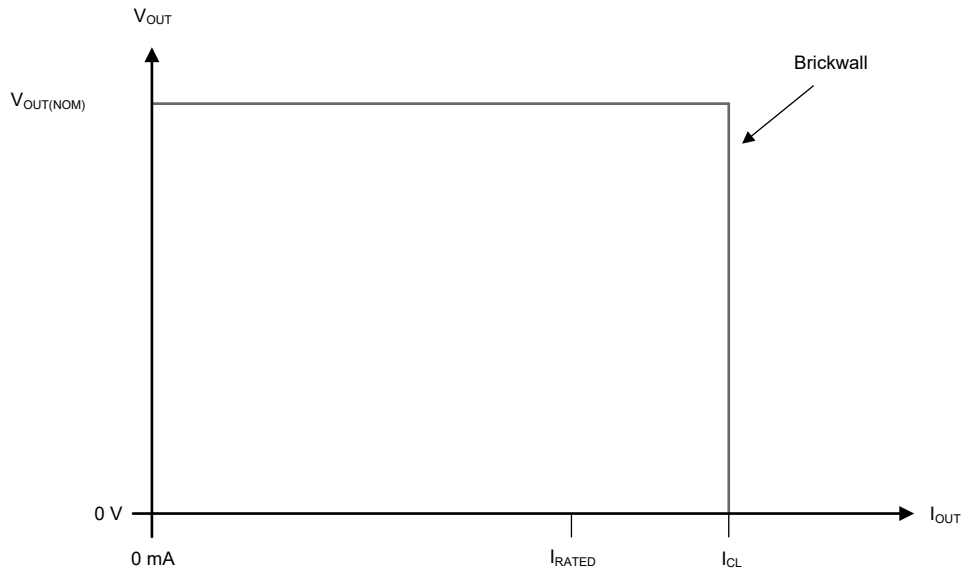

Figure 7-3. Current Limit

7.4 Device Functional Modes

7.4.1 Device Functional Mode Comparison

The *Device Functional Mode Comparison* table shows the conditions that lead to the different modes of operation. See the *Electrical Characteristics* table for parameter values.

表 7-1. Device Functional Mode Comparison

OPERATING MODE	PARAMETER			
	V_{IN}	V_{EN}	I_{OUT}	T_J
Normal operation	$V_{IN} > V_{OUT(nom)} + V_{DO}$ and $V_{IN} > V_{IN(min)}$	$V_{EN} > V_{EN(HI)}$	$I_{OUT} < I_{OUT(max)}$	$T_J < T_{SD(shutdown)}$
Dropout operation	$V_{IN(min)} < V_{IN} < V_{OUT(nom)} + V_{DO}$	$V_{EN} > V_{EN(HI)}$	$I_{OUT} < I_{OUT(max)}$	$T_J < T_{SD(shutdown)}$
Disabled (any true condition disables the device)	$V_{IN} < V_{UVLO}$	$V_{EN} < V_{EN(LOW)}$	Not applicable	$T_J > T_{SD(shutdown)}$

7.4.2 Normal Operation

The device regulates to the nominal output voltage when the following conditions are met:

- The input voltage is greater than the nominal output voltage plus the dropout voltage ($V_{OUT(nom)} + V_{DO}$)
- The output current is less than the current limit ($I_{OUT} < I_{CL}$)
- The device junction temperature is less than the thermal shutdown temperature ($T_J < T_{SD}$)
- The enable voltage has previously exceeded the enable rising threshold voltage and has not yet decreased to less than the enable falling threshold

7.4.3 Dropout Operation

If the input voltage is lower than the nominal output voltage plus the specified dropout voltage, but all other conditions are met for normal operation, the device operates in dropout mode. In this mode, the output voltage tracks the input voltage. During this mode, the transient performance of the device becomes significantly degraded because the pass transistor is in the ohmic or triode region, and acts as a switch. Line or load transients in dropout can result in large output-voltage deviations.

When the device is in a steady dropout state (defined as when the device is in dropout, $V_{IN} < V_{OUT(NOM)} + V_{DO}$, directly after being in a normal regulation state, but *not* during startup), the pass transistor is driven into the ohmic or triode region. When the input voltage returns to a value greater than or equal to the nominal output voltage plus the dropout voltage ($V_{OUT(NOM)} + V_{DO}$), the output voltage can overshoot for a short period of time while the device pulls the pass transistor back into the linear region.

7.4.4 Disabled

The output of the device can be shutdown by forcing the voltage of the enable pin to less than the maximum EN pin low-level input voltage (see the *Electrical Characteristics* table). When disabled, the pass transistor is turned off, internal circuits are shutdown, and the output voltage is actively discharged to ground by an internal discharge circuit from the output to ground.

8 Application and Implementation

Note

以下のアプリケーション情報は、TI の製品仕様に含まれるものではなく、TI ではその正確性または完全性を保証いたしません。個々の目的に対する製品の適合性については、お客様の責任で判断していただくこととなります。お客様は自身の設計実装を検証しテストすることで、システムの機能を確認する必要があります。

8.1 Application Information

8.1.1 Input and Output Capacitor Selection

The TPS7B84-Q1 requires an output capacitor of 2.2 μF or larger (1 μF or larger capacitance) for stability and an equivalent series resistance (ESR) between 0.001 Ω and 2 Ω . For the best transient performance, use X5R- and X7R-type ceramic capacitors because these capacitors have minimal variation in value and ESR over temperature. When choosing a capacitor for a specific application, be mindful of the DC bias characteristics for the capacitor. Higher output voltages cause a significant derating of the capacitor. For best performance, the maximum recommended output capacitance is 220 μF .

Although an input capacitor is not required for stability, good analog design practice is to connect a capacitor from IN to GND. Some input supplies have a high impedance, thus placing the input capacitor on the input supply helps reduce the input impedance. This capacitor counteracts reactive input sources and improves transient response, input ripple, and PSRR. If the input supply has a high impedance over a large range of frequencies, several input capacitors can be used in parallel to lower the impedance over frequency. Use a higher-value capacitor if large, fast, rise-time load transients are anticipated, or if the device is located several inches from the input power source.

8.1.2 Adjustable Device Feedback Resistor Selection

The adjustable-version device requires external feedback divider resistors to set the output voltage. V_{OUT} is set using the feedback divider resistors, R_1 and R_2 , according to the following equation:

$$V_{\text{OUT}} = V_{\text{FB}} \times (1 + R_1 / R_2) \quad (1)$$

To ignore the FB pin current error term in the V_{OUT} equation, set the feedback divider current to 100x the FB pin current listed in the *Electrical Characteristics* table. This setting provides the maximum feedback divider series resistance, as shown in the following equation:

$$R_1 + R_2 \leq V_{\text{OUT}} / (I_{\text{FB}} \times 100) \quad (2)$$

8.1.3 Feed-Forward Capacitor (C_{FF})

For the adjustable-voltage version device, a feed-forward capacitor (C_{FF}) can be connected from the OUT pin to the FB pin. C_{FF} improves transient, noise, and PSRR performance, but is not required for regulator stability. Recommended C_{FF} values are listed in the *Recommended Operating Conditions* table. A higher capacitance C_{FF} can be used; however, the startup time increases. For a detailed description of C_{FF} tradeoffs, see the [Pros and Cons of Using a Feedforward Capacitor with a Low-Dropout Regulator application report](#).

C_{FF} and R_1 form a zero in the loop gain at frequency f_z , while C_{FF} , R_1 , and R_2 form a pole in the loop gain at frequency f_p . C_{FF} zero and pole frequencies can be calculated from the following equations:

$$f_z = 1 / (2 \times \pi \times C_{\text{FF}} \times R_1) \quad (3)$$

$$f_p = 1 / (2 \times \pi \times C_{\text{FF}} \times (R_1 \parallel R_2)) \quad (4)$$

8.1.4 Dropout Voltage

Dropout voltage (V_{DO}) is defined as the input voltage minus the output voltage ($V_{IN} - V_{OUT}$) at the rated output current (I_{RATED}), where the pass transistor is fully on. I_{RATED} is the maximum I_{OUT} listed in the *Recommended Operating Conditions* table. The pass transistor is in the ohmic or triode region of operation, and acts as a switch. The dropout voltage indirectly specifies a minimum input voltage greater than the nominal programmed output voltage at which the output voltage is expected to stay in regulation. If the input voltage falls to less than the nominal output regulation, then the output voltage falls as well.

For a CMOS regulator, the dropout voltage is determined by the drain-source on-state resistance ($R_{DS(ON)}$) of the pass transistor. Therefore, if the linear regulator operates at less than the rated current, the dropout voltage for that current scales accordingly. The following equation calculates the $R_{DS(ON)}$ of the device.

$$R_{DS(ON)} = \frac{V_{DO}}{I_{RATED}} \quad (5)$$

8.1.5 Reverse Current

Excessive reverse current can damage this device. Reverse current flows through the intrinsic body diode of the pass transistor instead of the normal conducting channel. At high magnitudes, this current flow degrades the long-term reliability of the device.

Conditions where reverse current can occur are outlined in this section, all of which can exceed the absolute maximum rating of $V_{OUT} \leq V_{IN} + 0.3 \text{ V}$.

- If the device has a large C_{OUT} and the input supply collapses with little or no load current
- The output is biased when the input supply is not established
- The output is biased above the input supply

If reverse current flow is expected in the application, external protection is recommended to protect the device. Reverse current is not limited in the device, so external limiting is required if extended reverse voltage operation is anticipated.

8.1.6 Power Dissipation (P_D)

Circuit reliability requires consideration of the device power dissipation, location of the circuit on the printed circuit board (PCB), and correct sizing of the thermal plane. The PCB area around the regulator must have few or no other heat-generating devices that cause added thermal stress.

To first-order approximation, power dissipation in the regulator depends on the input-to-output voltage difference and load conditions. The following equation calculates power dissipation (P_D).

$$P_D = (V_{IN} - V_{OUT}) \times I_{OUT} \quad (6)$$

Note

Power dissipation can be minimized, and therefore greater efficiency can be achieved, by correct selection of the system voltage rails. For the lowest power dissipation use the minimum input voltage required for correct output regulation.

For devices with a thermal pad, the primary heat conduction path for the device package is through the thermal pad to the PCB. Solder the thermal pad to a copper pad area under the device. This pad area must contain an array of plated vias that conduct heat to additional copper planes for increased heat dissipation.

The maximum power dissipation determines the maximum allowable ambient temperature (T_A) for the device. According to the following equation, power dissipation and junction temperature are most often related by the junction-to-ambient thermal resistance ($R_{\theta JA}$) of the combined PCB and device package and the temperature of the ambient air (T_A).

$$T_J = T_A + (R_{\theta JA} \times P_D) \quad (7)$$

Thermal resistance ($R_{\theta JA}$) is highly dependent on the heat-spreading capability built into the particular PCB design, and therefore varies according to the total copper area, copper weight, and location of the planes. The junction-to-ambient thermal resistance listed in the *Thermal Information* table is determined by the JEDEC standard PCB and copper-spreading area, and is used as a relative measure of package thermal performance.

8.1.6.1 Thermal Performance Versus Copper Area

The most used thermal resistance parameter, $R_{\theta JA}$, is highly dependent on the heat-spreading capability built into the particular PCB design, and therefore varies according to the total copper area, copper weight, and location of the planes. The $R_{\theta JA}$ recorded in the *Thermal Information* table in the *Specifications* section is determined by the JEDEC standard (see [Figure 8-1](#)), PCB, and copper-spreading area, and is only used as a relative measure of package thermal performance. For a well-designed thermal layout, $R_{\theta JA}$ is actually the sum of the package junction-to-case (bottom) thermal resistance ($R_{\theta JCBot}$) plus the thermal resistance contribution by the PCB copper.

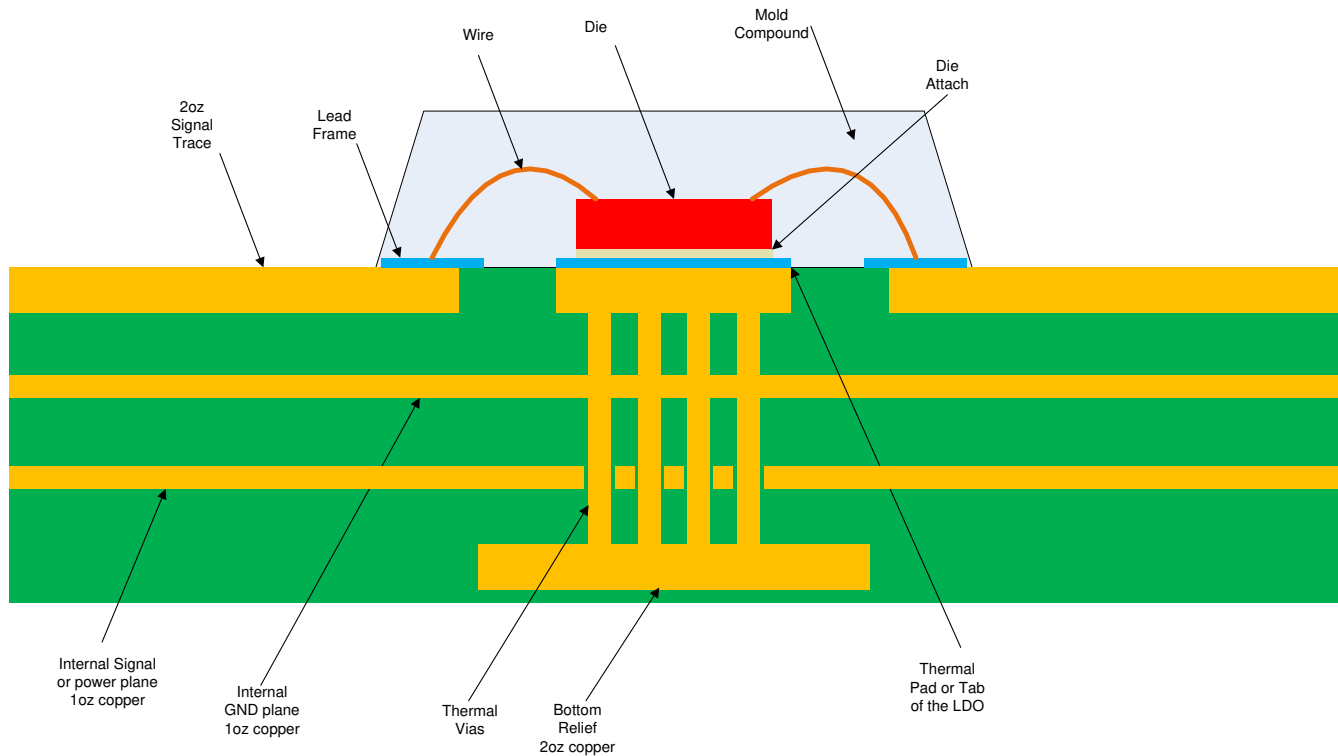
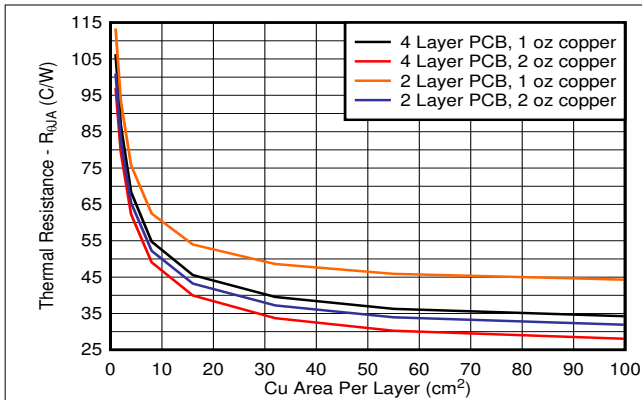
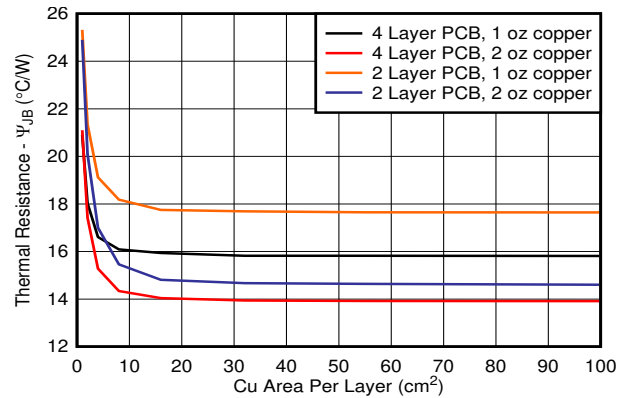

Figure 8-1. JEDEC Standard 2s2p PCB

[Figure 8-2](#) through [Figure 8-4](#) depict the functions of $R_{\theta JA}$ and ψ_{JB} versus copper area and thickness. These plots are generated with a 101.6-mm x 101.6-mm x 1.6-mm PCB of two and four layers. For the four-layer board, the inner planes use a 1-oz copper thickness. Outer layers are simulated with both a 1-oz and 2-oz copper thickness. A 4 x 4 array of thermal vias of 300- μ m drill diameter and 25- μ m Cu plating is located beneath the thermal pad of the device. The thermal vias connect the top layer, the bottom layer and, in the case of the 4-layer board, the first inner GND plane. Each of the layers has a copper plane of equal area.



8-2. $R_{\theta JA}$ vs Copper Area 2s2p DRB Package



8-3. ψ_{JB} vs Copper Area 2s2p DRB Package

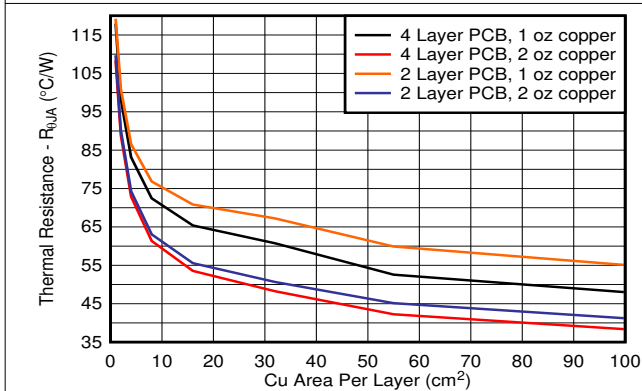

8-4. $R_{\theta JA}$ vs Copper Area 2s2p DCY Package

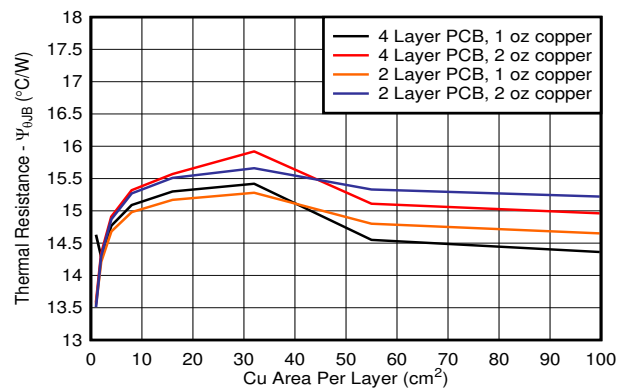

8-5. ψ_{JB} vs Copper Area 2s2p DCY Package

8.1.6.2 Power Dissipation vs Ambient Temperature

8-6 is based off of a JESD51-7 4 layer high-K board. The allowable power dissipation was estimated using the following equation. As discussed in the *An empirical analysis of the impact of board layout on LDO thermal performance application report*, thermal dissipation can be improved in the JEDEC high-K layout by adding top layer copper and increasing the number of thermal vias. If a good thermal layout is used, the allowable thermal dissipation can be improved by up to 50%.

$$T_A + R_{\theta JA} \times P_D \leq 150 \text{ }^\circ\text{C} \tag{8}$$

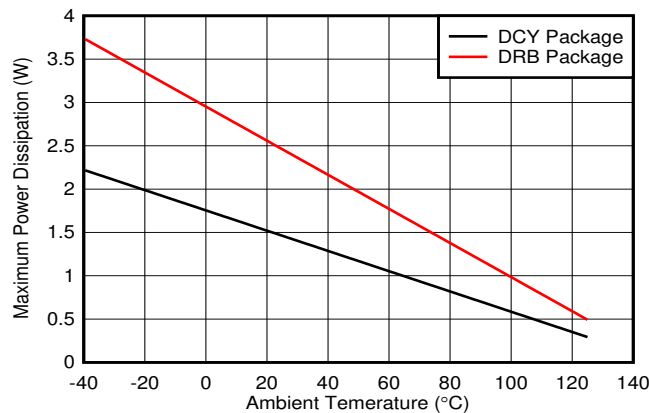

8-6. TPS7B84-Q1 Allowable Power Dissipation

8.1.7 Estimating Junction Temperature

The JEDEC standard now recommends the use of psi (Ψ) thermal metrics to estimate the junction temperatures of the linear regulator when in-circuit on a typical PCB board application. These metrics are not thermal resistance parameters and instead offer a practical and relative way to estimate junction temperature. These psi metrics are determined to be significantly independent of the copper area available for heat-spreading. The *Thermal Information* table lists the primary thermal metrics, which are the junction-to-top characterization parameter (ψ_{JT}) and junction-to-board characterization parameter (ψ_{JB}). These parameters provide two methods for calculating the junction temperature (T_J), as described in the following equations. Use the junction-to-top characterization parameter (ψ_{JT}) with the temperature at the center-top of device package (T_T) to calculate the junction temperature. Use the junction-to-board characterization parameter (ψ_{JB}) with the PCB surface temperature 1 mm from the device package (T_B) to calculate the junction temperature.

$$T_J = T_T + \psi_{JT} \times P_D \quad (9)$$

where:

- P_D is the dissipated power
- T_T is the temperature at the center-top of the device package

$$T_J = T_B + \psi_{JB} \times P_D \quad (10)$$

where

- T_B is the PCB surface temperature measured 1 mm from the device package and centered on the package edge

For detailed information on the thermal metrics and how to use them, see the [Semiconductor and IC Package Thermal Metrics application report](#).

8.2 Typical Application

Figure 8-7 shows a typical application circuit for the TPS7B84-Q1. Use different values of external components, depending on the end application. An application may require a larger output capacitor during fast load steps in order to prevent a reset from occurring. TI recommends a low-ESR ceramic capacitor with a dielectric of type X5R or X7R.

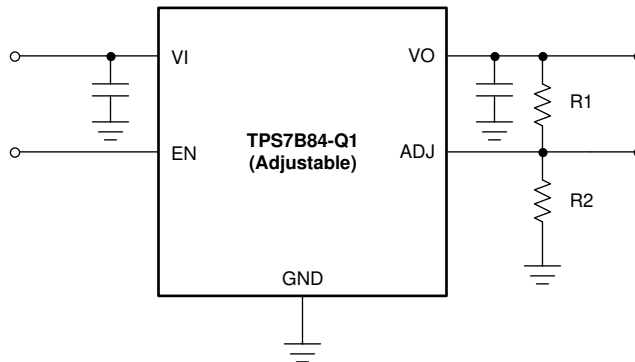

Figure 8-7. Typical Application Schematic for the TPS7B84-Q1

8.2.1 Design Requirements

For this design example, use the parameters listed in Table 8-1 as the input parameters.

Table 8-1. Design Parameters

DESIGN PARAMETER	EXAMPLE VALUE
Input voltage range	6 V to 40 V
Output voltage	5 V
Output current	100 mA
Output capacitor	10 μ F

8.2.2 Detailed Design Procedure

8.2.2.1 Input Capacitor

The device requires an input decoupling capacitor, the value of which depends on the application. The typical recommended value for the decoupling capacitor is 1 μ F. The voltage rating must be greater than the maximum input voltage.

8.2.2.2 Output Capacitor

The device requires an output capacitor to stabilize the output voltage. The capacitor value must be between 2.2 μ F and 200 μ F and the ESR range must be between 1 m Ω and 2 Ω . For this design a low ESR, 10- μ F ceramic capacitor was used to improve transient performance.

8.2.3 Application Curves

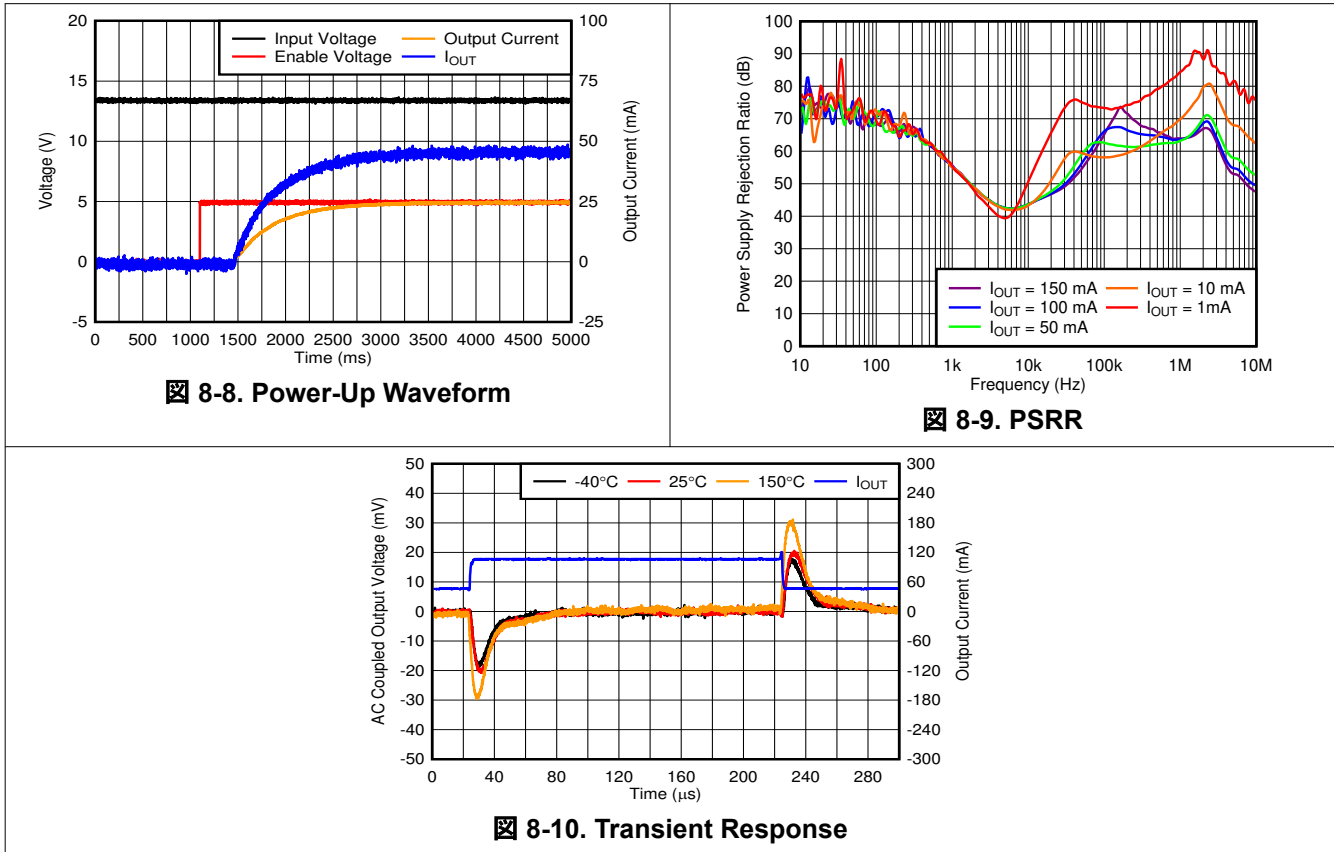

9 Power Supply Recommendations

This device is designed for operation from an input voltage supply with a range between 3 V and 40 V. This input supply must be well regulated. If the input supply is located more than a few inches from the TPS7B84-Q1, add an electrolytic capacitor and a ceramic bypass capacitor at the input.

10 Layout

10.1 Layout Guidelines

For best overall performance, place all circuit components on the same side of the circuit board and as near as practical to the respective LDO pin connections. Place ground return connections to the input and output capacitor, and to the LDO ground pin as close as possible to each other, connected by a wide, component-side, copper surface. The use of vias and long traces to the input and output capacitors is strongly discouraged and negatively affects system performance. TI also recommends a ground reference plane either embedded in the PCB itself or located on the bottom side of the PCB opposite the components. This reference plane serves to assure accuracy of the output voltage, shield noise, and behaves similarly to a thermal plane to spread (or sink) heat from the LDO device when connected to the thermal pad. In most applications, this ground plane is necessary to meet thermal requirements.

10.1.1 Package Mounting

Solder pad footprint recommendations for the TPS7B84-Q1 are available at the end of this document and at www.ti.com.

10.1.2 Board Layout Recommendations to Improve PSRR and Noise Performance

As depicted in [Figure 10-1](#) and [Figure 10-2](#), place the input and output capacitors close to the device for the layout of the TPS7B84-Q1. In order to enhance the thermal performance, place as many vias as possible around the device. These vias improve the heat transfer between the different GND planes in the PCB.

To improve ac performance such as PSRR, output noise, and transient response, TI recommends a board design with separate ground planes for IN and OUT, with each ground plane connected only at the GND pin of the device. In addition, the ground connection for the output capacitor must connect directly to the GND pin of the device.

Minimize equivalent series inductance (ESL) and ESR in order to maximize performance and ensure stability. Place each capacitor as close as possible to the device and on the same side of the PCB as the regulator itself.

Do not place any of the capacitors on the opposite side of the PCB from where the regulator is installed. TI strongly discourages the use of vias and long traces to connect the capacitors because these can negatively impact system performance and may even cause instability.

If possible, and to ensure the maximum performance specified in this document, use the same layout pattern used for the TPS7B84-Q1 evaluation board, available at www.ti.com.

10.2 Layout Examples

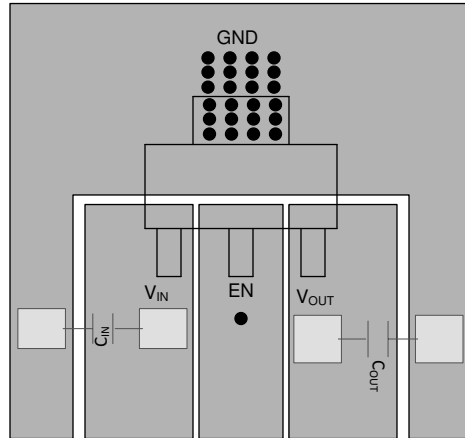

● Denotes a via

10-1. SOT-223 (DCY) Layout

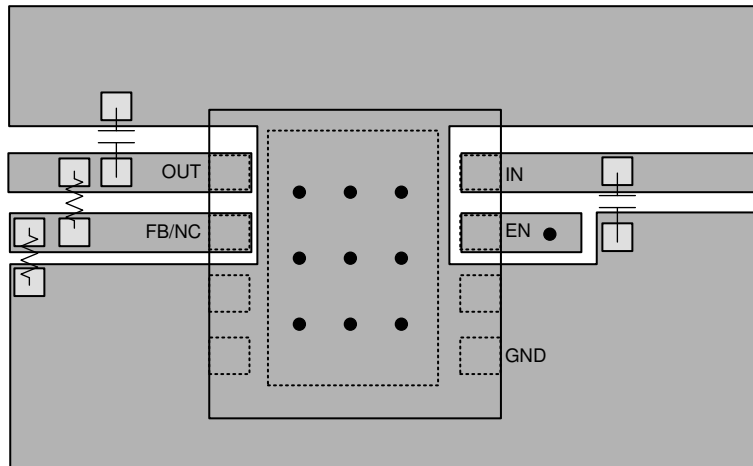

● Denotes a via

10-2. VSON (DRB) Layout

11 Device and Documentation Support

11.1 Device Support

11.1.1 Device Nomenclature

表 11-1. Device Nomenclature⁽¹⁾

PRODUCT	V _{OUT}
TPS7B84xxQ(W)yyyRQ1	<p>xx is the nominal output voltage (for example, 33 = 3.3 V; 50 = 5.0 V).</p> <p>Q indicates that this device is a grade-1 device in accordance with the AEC-Q100 standard.</p> <p>W indicates the package has wettable flanks.</p> <p>yyy is the package designator.</p> <p>R is the package quantity. R is for reel (3000 pieces).</p> <p>Q1 indicates that this device is an automotive grade (AEC-Q100) device.</p>

(1) For the most current package and ordering information see the Package Option Addendum at the end of this document, or visit the device product folder on www.ti.com.

11.2 ドキュメントの更新通知を受け取る方法

ドキュメントの更新についての通知を受け取るには、ti.com のデバイス製品フォルダを開いてください。「更新の通知を受け取る」をクリックして登録すると、変更されたすべての製品情報に関するダイジェストを毎週受け取れます。変更の詳細については、修正されたドキュメントに含まれている改訂履歴をご覧ください。

11.3 サポート・リソース

TI E2E™ サポート・フォーラムは、エンジニアが検証済みの回答と設計に関するヒントをエキスパートから迅速かつ直接得ることができる場所です。既存の回答を検索したり、独自の質問をしたりすることで、設計に必要な支援を迅速に得ることができます。

リンクされているコンテンツは、該当する貢献者により、現状のまま提供されるものです。これらは TI の仕様を構成するものではなく、必ずしも TI の見解を反映したものではありません。TI の[使用条件](#)を参照してください。

11.4 Trademarks

TI E2E™ is a trademark of Texas Instruments.

すべての商標は、それぞれの所有者に帰属します。

11.5 静電気放電に関する注意事項



この IC は、ESD によって破損する可能性があります。テキサス・インスツルメンツは、IC を取り扱う際には常に適切な注意を払うことを推奨します。正しい ESD 対策をとらないと、デバイスを破損するおそれがあります。

ESD による破損は、わずかな性能低下からデバイスの完全な故障まで多岐にわたります。精密な IC の場合、パラメータがわずかに変化するだけで公表されている仕様から外れる可能性があるため、破損が発生しやすくなっています。

11.6 用語集

TI 用語集 この用語集には、用語や略語の一覧および定義が記載されています。

Mechanical, Packaging, and Orderable Information

The following pages include mechanical, packaging, and orderable information. This information is the most current data available for the designated devices. This data is subject to change without notice and revision of this document. For browser-based versions of this data sheet, refer to the left-hand navigation.

PACKAGING INFORMATION

Orderable Device	Status (1)	Package Type	Package Drawing	Pins	Package Qty	Eco Plan (2)	Lead finish/ Ball material (6)	MSL Peak Temp (3)	Op Temp (°C)	Device Marking (4/5)	Samples
TPS7B8401QWDRBRQ1	ACTIVE	SON	DRB	8	3000	RoHS & Green	NIPDAU	Level-2-260C-1 YEAR	-40 to 125	7B8401	Samples
TPS7B8433QDCYRQ1	ACTIVE	SOT-223	DCY	4	2500	RoHS & Green	NIPDAU SN	Level-2-260C-1 YEAR	-40 to 125	7B8433	Samples
TPS7B8433QDCYRQ1M3	ACTIVE	SOT-223	DCY	4	2500	RoHS & Green	SN	Level-2-260C-1 YEAR	-40 to 125	7B8433	Samples
TPS7B8433QDCYRQ1W	ACTIVE	SOT-223	DCY	4	2500	RoHS & Green	SN	Level-2-260C-1 YEAR	-40 to 125	7B8433	Samples
TPS7B8433QWDRBRQ1	ACTIVE	SON	DRB	8	3000	RoHS & Green	NIPDAU	Level-2-260C-1 YEAR	-40 to 125	7B8433	Samples
TPS7B8450QDCYRQ1	ACTIVE	SOT-223	DCY	4	2500	RoHS & Green	NIPDAU SN	Level-2-260C-1 YEAR	-40 to 125	7B8450	Samples
TPS7B8450QDCYRQ1M3	ACTIVE	SOT-223	DCY	4	2500	RoHS & Green	SN	Level-2-260C-1 YEAR	-40 to 125	7B8450	Samples
TPS7B8450QDCYRQ1W	ACTIVE	SOT-223	DCY	4	2500	RoHS & Green	SN	Level-2-260C-1 YEAR	-40 to 125	7B8450	Samples
TPS7B8450QWDRBRQ1	ACTIVE	SON	DRB	8	3000	RoHS & Green	NIPDAU	Level-2-260C-1 YEAR	-40 to 125	7B8450	Samples
TPS7B8480QWDRBRQ1	ACTIVE	SON	DRB	8	3000	RoHS & Green	NIPDAU	Level-2-260C-1 YEAR	-40 to 125	7B8480	Samples

(1) The marketing status values are defined as follows:

ACTIVE: Product device recommended for new designs.

LIFEBUY: TI has announced that the device will be discontinued, and a lifetime-buy period is in effect.

NRND: Not recommended for new designs. Device is in production to support existing customers, but TI does not recommend using this part in a new design.

PREVIEW: Device has been announced but is not in production. Samples may or may not be available.

OBSOLETE: TI has discontinued the production of the device.

(2) **RoHS:** TI defines "RoHS" to mean semiconductor products that are compliant with the current EU RoHS requirements for all 10 RoHS substances, including the requirement that RoHS substance do not exceed 0.1% by weight in homogeneous materials. Where designed to be soldered at high temperatures, "RoHS" products are suitable for use in specified lead-free processes. TI may reference these types of products as "Pb-Free".

RoHS Exempt: TI defines "RoHS Exempt" to mean products that contain lead but are compliant with EU RoHS pursuant to a specific EU RoHS exemption.

Green: TI defines "Green" to mean the content of Chlorine (Cl) and Bromine (Br) based flame retardants meet JS709B low halogen requirements of <=1000ppm threshold. Antimony trioxide based flame retardants must also meet the <=1000ppm threshold requirement.

(3) MSL, Peak Temp. - The Moisture Sensitivity Level rating according to the JEDEC industry standard classifications, and peak solder temperature.

(4) There may be additional marking, which relates to the logo, the lot trace code information, or the environmental category on the device.

⁽⁵⁾ Multiple Device Markings will be inside parentheses. Only one Device Marking contained in parentheses and separated by a "~" will appear on a device. If a line is indented then it is a continuation of the previous line and the two combined represent the entire Device Marking for that device.

⁽⁶⁾ Lead finish/Ball material - Orderable Devices may have multiple material finish options. Finish options are separated by a vertical ruled line. Lead finish/Ball material values may wrap to two lines if the finish value exceeds the maximum column width.

Important Information and Disclaimer:The information provided on this page represents TI's knowledge and belief as of the date that it is provided. TI bases its knowledge and belief on information provided by third parties, and makes no representation or warranty as to the accuracy of such information. Efforts are underway to better integrate information from third parties. TI has taken and continues to take reasonable steps to provide representative and accurate information but may not have conducted destructive testing or chemical analysis on incoming materials and chemicals. TI and TI suppliers consider certain information to be proprietary, and thus CAS numbers and other limited information may not be available for release.

In no event shall TI's liability arising out of such information exceed the total purchase price of the TI part(s) at issue in this document sold by TI to Customer on an annual basis.

TAPE AND REEL INFORMATION

QUADRANT ASSIGNMENTS FOR PIN 1 ORIENTATION IN TAPE

*All dimensions are nominal

Device	Package Type	Package Drawing	Pins	SPQ	Reel Diameter (mm)	Reel Width W1 (mm)	A0 (mm)	B0 (mm)	K0 (mm)	P1 (mm)	W (mm)	Pin1 Quadrant
TPS7B8401QWDRBRQ1	SON	DRB	8	3000	330.0	12.4	3.3	3.3	1.1	8.0	12.0	Q2
TPS7B8433QDCYRQ1	SOT-223	DCY	4	2500	330.0	12.4	7.05	7.4	1.9	8.0	12.0	Q3
TPS7B8433QDCYRQ1M3	SOT-223	DCY	4	2500	330.0	12.4	7.05	7.4	1.9	8.0	12.0	Q3
TPS7B8433QDCYRQ1W	SOT-223	DCY	4	2500	330.0	16.4	7.05	7.4	1.9	8.0	16.0	Q3
TPS7B8433QWDRBRQ1	SON	DRB	8	3000	330.0	12.4	3.3	3.3	1.1	8.0	12.0	Q2
TPS7B8450QDCYRQ1	SOT-223	DCY	4	2500	330.0	12.4	7.05	7.4	1.9	8.0	12.0	Q3
TPS7B8450QDCYRQ1M3	SOT-223	DCY	4	2500	330.0	12.4	7.05	7.4	1.9	8.0	12.0	Q3
TPS7B8450QDCYRQ1W	SOT-223	DCY	4	2500	330.0	16.4	7.05	7.4	1.9	8.0	16.0	Q3
TPS7B8450QWDRBRQ1	SON	DRB	8	3000	330.0	12.4	3.3	3.3	1.1	8.0	12.0	Q2
TPS7B8480QWDRBRQ1	SON	DRB	8	3000	330.0	12.4	3.3	3.3	1.1	8.0	12.0	Q2

TAPE AND REEL BOX DIMENSIONS

*All dimensions are nominal

Device	Package Type	Package Drawing	Pins	SPQ	Length (mm)	Width (mm)	Height (mm)
TPS7B8401QWDRBRQ1	SON	DRB	8	3000	367.0	367.0	35.0
TPS7B8433QDCYRQ1	SOT-223	DCY	4	2500	366.0	364.0	50.0
TPS7B8433QDCYRQ1M3	SOT-223	DCY	4	2500	366.0	364.0	50.0
TPS7B8433QDCYRQ1W	SOT-223	DCY	4	2500	366.0	364.0	50.0
TPS7B8433QWDRBRQ1	SON	DRB	8	3000	367.0	367.0	35.0
TPS7B8450QDCYRQ1	SOT-223	DCY	4	2500	340.0	340.0	38.0
TPS7B8450QDCYRQ1M3	SOT-223	DCY	4	2500	340.0	340.0	38.0
TPS7B8450QDCYRQ1W	SOT-223	DCY	4	2500	340.0	340.0	38.0
TPS7B8450QWDRBRQ1	SON	DRB	8	3000	367.0	367.0	35.0
TPS7B8480QWDRBRQ1	SON	DRB	8	3000	367.0	367.0	35.0

重要なお知らせと免責事項

TI は、技術データと信頼性データ(データシートを含みます)、設計リソース(リファレンス・デザインを含みます)、アプリケーションや設計に関する各種アドバイス、Web ツール、安全性情報、その他のリソースを、欠陥が存在する可能性のある「現状のまま」提供しており、商品性および特定目的に対する適合性の黙示保証、第三者の知的財産権の非侵害保証を含むいかなる保証も、明示的または黙示的にかかわらず拒否します。

これらのリソースは、TI 製品を使用する設計の経験を積んだ開発者への提供を意図したものです。(1) お客様のアプリケーションに適した TI 製品の選定、(2) お客様のアプリケーションの設計、検証、試験、(3) お客様のアプリケーションに該当する各種規格や、その他のあらゆる安全性、セキュリティ、規制、または他の要件への確実な適合に関する責任を、お客様のみが単独で負うものとし、

上記の各種リソースは、予告なく変更される可能性があります。これらのリソースは、リソースで説明されている TI 製品を使用するアプリケーションの開発の目的でのみ、TI はその使用をお客様に許諾します。これらのリソースに関して、他の目的で複製することや掲載することは禁止されています。TI や第三者の知的財産権のライセンスが付与されている訳ではありません。お客様は、これらのリソースを自身で使用した結果発生するあらゆる申し立て、損害、費用、損失、責任について、TI およびその代理人を完全に補償するものとし、TI は一切の責任を拒否します。

TI の製品は、[TI の販売条件](#)、または [ti.com](#) やかかる TI 製品の関連資料などのいずれかを通じて提供する適用可能な条項の下で提供されています。TI がこれらのリソースを提供することは、適用される TI の保証または他の保証の放棄の拡大や変更を意味するものではありません。

お客様がいかなる追加条項または代替条項を提案した場合でも、TI はそれらに異議を唱え、拒否します。

郵送先住所 : Texas Instruments, Post Office Box 655303, Dallas, Texas 75265
Copyright © 2024, Texas Instruments Incorporated