

TPS7B91 150mA、40V、 I_Q 1.5 μ A、低ドロップアウト リニア レギュレータ

1 特長

- 入力電圧範囲: 2.5V~40V
- 選択可能な出力電圧:
 - 固定: 1.2V~12V
 - 可変: 1.205V~ $V_{IN} - V_{DO}$
- 出力電流: 150mA
- きわめて小さい I_Q : $I_{OUT} = 0$ mA で 1.8 μ A
- 1.0 μ F 以上の出力コンデンサで安定動作
- 高 PSRR:
 - 1kHz 時に 70dB
 - 100kHz 時に 43dB
- フォールドバック電流制限
- 過熱保護
- パッケージ:
 - 5ピン SOT-23 (DBV)
- 動作時接合部温度: -40°C~+125°C

2 アプリケーション

- 電化製品
- ホーム/ビルディング オートメーション
- リテール オートメーションおよびペイメント
- グリッド インフラ
- 医療用アプリケーション
- 照明アプリケーション

3 概要

TPS7B91 低ドロップアウト (LDO) リニア電圧レギュレータは、低静止電流のデバイスです。TPS7B91 は、広い入力電圧範囲 (最大 40V)、広い出力範囲、低消費電力動作を小型パッケージで実現します。広い出力範囲は、可変構成では最大 $V_{IN} - V_{DO}$ 、固定構成では最大 12V です。

TPS7B91 は、バッテリー駆動アプリケーション向けにマイコンや他の低消費電力負荷への電力供給に最適化されています。TPS7B91 は、1.0 μ F~47 μ F の出力コンデンサ範囲で安定です。

静止電流が小さい (標準値 1.8 μ A) TPS7B91 は、アイドル時の消費電力が非常に小さいバッテリー駆動または常時オンのシステム向けに設計されています。

TPS7B91 LDO は、150mA の負荷電流で標準 900mV の低ドロップアウトをサポートしています。また、TPS7B91 には内部ソフトスタートが搭載されており、起動時の突入電流を低減できます。フォールドバック過電流制限保護およびサーマル シャットダウン機能を内蔵しているため、負荷の短絡やフォルト時にもレギュレータが保護されます。

TPS7B91 は、固定および可変出力用の 2.9mm × 2.8mm、5ピン SOT-23 (DBV) パッケージで供給されます。

パッケージ情報

部品番号	パッケージ (1)	パッケージ サイズ (2)
TPS7B91	DBV (SOT-23, 5)	2.9mm × 2.8mm

- 詳細については、「メカニカル、パッケージ、および注文情報」を参照してください。
- パッケージサイズ (長さ × 幅) は公称値であり、該当する場合はピンも含まれます。

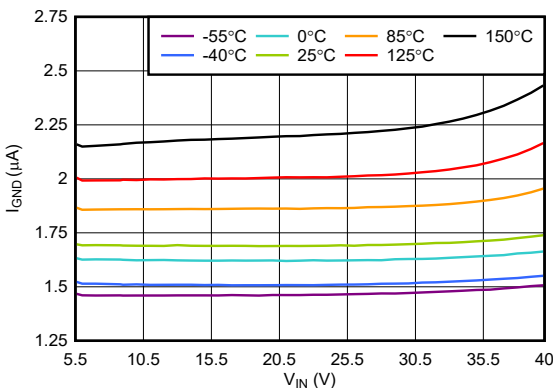

I_{GND} と V_{IN} との関係 ($V_{OUT} = 5.0$ V、 $I_{OUT} = 0$ mA)

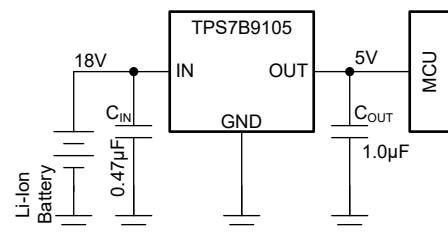

代表的なアプリケーション



Table of Contents

1 特長	1	7.1 Application Information.....	18
2 アプリケーション	1	7.2 Typical Application.....	18
3 概要	1	7.3 Best Design Practices.....	25
4 Pin Configuration and Functions	3	7.4 Power Supply Recommendations.....	25
5 Specifications	4	7.5 Layout.....	25
5.1 Absolute Maximum Ratings.....	4	8 Device and Documentation Support	27
5.2 ESD Ratings.....	4	8.1 Device Support.....	27
5.3 Recommended Operating Conditions.....	5	8.2 Documentation Support.....	27
5.4 Thermal Information.....	5	8.3 ドキュメントの更新通知を受け取る方法.....	27
5.5 Electrical Characteristics.....	5	8.4 サポート・リソース.....	27
5.6 Typical Characteristics.....	7	8.5 Trademarks.....	27
6 Detailed Description	14	8.6 静電気放電に関する注意事項.....	27
6.1 Overview.....	14	8.7 用語集.....	28
6.2 Functional Block Diagrams.....	14	9 Revision History	28
6.3 Feature Description.....	15	10 Mechanical, Packaging, and Orderable	
6.4 Device Functional Modes.....	16	Information	28
7 Application and Implementation	18		

4 Pin Configuration and Functions



図 4-1. DBV Package (Fixed), 5-Pin SOT-23 (Top View)



図 4-2. DBV Package (Adjustable), 5-Pin SOT-23 (Top View)

表 4-1. Pin Functions

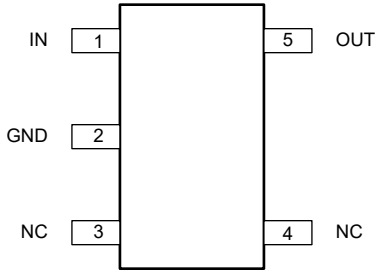
NAME	PIN		TYPE	DESCRIPTION
	DBV (Fixed)	DBV (Adj)		
GND	2	2	—	Ground pin.
IN	1	1	I	Input supply pin. See the Recommended Operating Conditions table and the Input and Output Capacitor Requirements section for more information.
OUT	5	5	O	Output of the regulator. See the Recommended Operating Conditions table and the Input and Output Capacitor Requirements section for more information.
FB	—	4	I	In the adjustable configuration, this pin sets the output voltage with the help of a feedback divider.
NC	3, 4	3	—	Not internally connected. Leave this pin open or connected to any potential. Tie this pin to ground for improved thermal performance.

5 Specifications

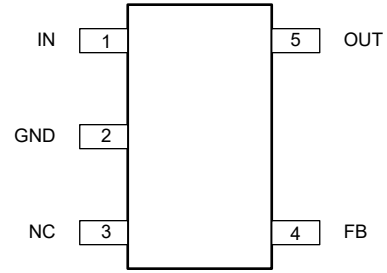
5.1 Absolute Maximum Ratings

over operating free-air temperature range (unless otherwise noted)⁽¹⁾

		MIN	MAX	UNIT
Voltage ⁽²⁾	V _{IN}	-0.3	42	V
	V _{OUT} (for fixed only)	-0.3	2 × V _{OUT(typ)} or V _{IN} + 0.3 or 15 (whichever is lower) ⁽²⁾	
	V _{OUT} (for adjustable only)	-0.3	42 or V _{IN} + 0.3 (whichever is lower)	
	V _{FB}	-0.3	3.6	
Power dissipation ^{(3) (4)}	SOT-23 (DBV)	T _A = -55°C	1.775	W
		T _A = +25°C	1.375	
		T _A = +125°C	0.875	
Current	V _{OUT}	Internally limited		A
Temperature	Operating junction, T _J	-55	125	°C
	Storage, T _{stg}	-65	150	

- (1) Operation outside the *Absolute Maximum Ratings* may cause permanent device damage. *Absolute Maximum Ratings* do not imply functional operation of the device at these or any other conditions beyond those listed under *Recommended Operating Conditions*. If used outside the *Recommended Operating Conditions* but within the *Absolute Maximum Ratings*, the device may not be fully functional, and this may affect device reliability, functionality, performance, and shorten the device lifetime.
- (2) All voltage values are with respect to the ground terminal.
- (3) The power dissipation rating is defined as the continuous peak power that is dissipated across a voltage regulator over a 24-hour period. This rating represents the maximum amount of heat energy that the voltage regulator handles without exceeding safe operating limits during continuous operation.
- (4) The power dissipation values mentioned in *Absolute Maximum Ratings* are PCB mounted and is for reference only. The PCB configuration is based on JEDEC standard of 2s2p configuration (EIA/JESD51-x).

5.2 ESD Ratings

			VALUE	UNIT
V _(ESD)	Electrostatic discharge	Human body model (HBM), per ANSI/ESDA/ JEDEC JS-001, all pins ⁽¹⁾	±750	V
		Charged device model (CDM), per JEDEC specification JESD22-C101, all pins ⁽²⁾	±500	

- (1) JEDEC document JEP155 states that 500V HBM allows safe manufacturing with a standard ESD control process.
- (2) JEDEC document JEP157 states that 250V CDM allows safe manufacturing with a standard ESD control process.

5.3 Recommended Operating Conditions

over operating junction temperature range (unless otherwise noted)

		MIN	NOM	MAX	UNIT
V _{IN}	Input supply voltage	2.5		40	V
V _{OUT}	Output voltage ⁽¹⁾	1.2		38	V
I _{OUT}	Output current	0		150	mA
C _{IN}	Input capacitor ⁽²⁾		0.47		μF
C _{OUT}	Output capacitor ⁽³⁾	1		47	μF
T _J	Operating junction temperature	-40		125	°C

- (1) All voltages are with respect to GND.
- (2) An input capacitor is not required for LDO stability. However, an input capacitance with an effective value of 0.1 μF minimum is recommended to counteract the effect of source resistance and inductance, which may in some cases cause symptoms of systemlevel instability such as ringing or oscillation, especially in the presence of load transients.
- (3) All capacitor values listed are the nominal value and the effective capacitance is assumed to derate to 50% of the nominal capacitor value.

5.4 Thermal Information

THERMAL METRIC ⁽¹⁾		TPS7B91	UNIT
		DBV (SOT-23) ⁽²⁾	
		5 PINS	
R _{θJA}	Junction-to-ambient thermal resistance	207.0	°C/W
R _{θJC(top)}	Junction-to-case (top) thermal resistance	104.7	°C/W
R _{θJB}	Junction-to-board thermal resistance	73.6	°C/W
Ψ _{JT}	Junction-to-top characterization parameter	40.6	°C/W
Ψ _{JB}	Junction-to-board characterization parameter	73.2	°C/W
R _{θJC(bot)}	Junction-to-case (bottom) thermal resistance	n/a	°C/W

- (1) For more information about traditional and new thermal metrics, see the [Semiconductor and IC Package Thermal Metrics](#) application note.
- (2) Thermal performance results are based on the JEDEC standard of 2s2p PCB configuration. These thermal metric parameters are further improved by 35-55% based on thermally optimized PCB layout designs. See the analysis of the [Impact of board layout on LDO thermal performance](#) application note.

5.5 Electrical Characteristics

over operating junction temperature range (T_J = -40°C to +125°C), V_{IN} = 2.5V or V_{IN} = V_{OUT}(nom) + 0.5V (whichever is greater), C_{IN} = 1μF, C_{OUT} = 1μF, and I_{OUT} = 1mA (unless otherwise noted); typical values are at T_J = 25°C ⁽¹⁾

PARAMETER		TEST CONDITIONS		MIN	TYP	MAX	UNIT
V _{IN}	Input voltage			2.5		40	V
I _{OUT} ^{(2) (3)}	Maximum output current				150		mA
V _{FB}	Feedback voltage	V _{OUT} + 2.0V ≤ V _{IN} ≤ 40V, T _J = 25°C		1.169	1.205	1.237	V
		V _{OUT} + 2.0V ≤ V _{IN} ≤ 40V, -40°C ≤ T _J ≤ 125°C		1.162	1.205	1.243	
V _{OUT}	Output voltage	V _{OUT} = 1.8V	V _{IN} = V _{OUT} + 2.0V, 100μA ≤ I _{OUT} ≤ 150mA, T _J = 25°C	-3.0		4.5	%
		V _{OUT} = 3.3V		-2.75		4.25	
		V _{OUT} = 5.0V		-3.75		4.25	
		V _{OUT} = 12V		-5.25		5.25	
		V _{OUT} = 1.8V	V _{IN} = V _{OUT} + 2.0V, 100μA ≤ I _{OUT} ≤ 150mA, -40°C ≤ T _J ≤ 125°C	-3.75		5.0	
		V _{OUT} = 3.3V		-3.5		5.0	
		V _{OUT} = 5.0V		-4.25		4.75	
		V _{OUT} = 12V		-5.75		5.75	

5.5 Electrical Characteristics (続き)

over operating junction temperature range ($T_J = -40^\circ\text{C}$ to $+125^\circ\text{C}$), $V_{IN} = 2.5\text{V}$ or $V_{IN} = V_{OUT(\text{nom})} + 0.5\text{V}$ (whichever is greater), $C_{IN} = 1\mu\text{F}$, $C_{OUT} = 1\mu\text{F}$, and $I_{OUT} = 1\text{mA}$ (unless otherwise noted); typical values are at $T_J = 25^\circ\text{C}$ ⁽¹⁾

PARAMETER		TEST CONDITIONS	MIN	TYP	MAX	UNIT
$\Delta V_{OUT}/V_{IN}$	Line regulation	$I_{OUT} = 1\text{mA}$, $V_{OUT} + 1\text{V} \leq V_{IN} \leq 40\text{V}$		0.000 05	0.007	%/V
$\Delta V_{OUT}/I_{OUT}$	Load regulation	$V_{IN} = V_{OUT} + 2\text{V}$, $100\mu\text{A} \leq I_{OUT} \leq 150\text{mA}$		0.1		%/A
V_{DO}	Dropout voltage	$I_{OUT} = 50\text{mA}$		440	700	mV
V_{DO}	Dropout voltage	$I_{OUT} = 150\text{mA}$		1100	1800	mV
I_{LIM}	Output current limit	$V_{OUT} = 0.90 \cdot V_{OUT(\text{nom})}$, $V_{IN} = V_{OUT(\text{nom})} + 4\text{V}$	165	270	360	mA
I_{SC}	Short-circuit current limit	$V_{OUT} = 0\text{V}$, $V_{IN} = V_{OUT(\text{nom})} + 4\text{V}$	42	90	140	mA
I_{GND}	GND pin current	$V_{IN} = V_{OUT(\text{nom})} + 0.5\text{V}$, $I_{OUT} = 0\text{mA}$, $T_J = 25^\circ\text{C}$ (fixed)		1.7	2.65	μA
		$V_{IN} = V_{OUT(\text{nom})} + 0.5\text{V}$, $I_{OUT} = 0\text{mA}$, $T_J = 25^\circ\text{C}$ (adjustable)		1.3	2.65	
		$V_{IN} = V_{OUT(\text{nom})} + 0.5\text{V}$, $I_{OUT} = 0\text{mA}$, $T_J = -40^\circ\text{C}$ to 85°C			2.9	
		$V_{IN} = V_{OUT(\text{nom})} + 0.5\text{V}$, $I_{OUT} = 0\text{mA}$, $T_J = -40^\circ\text{C}$ to 125°C			3	
		$V_{IN} = V_{OUT(\text{nom})} + 0.5\text{V}$, $I_{OUT} = 100\mu\text{A}$ (fixed)		2.8		
		$V_{IN} = V_{OUT(\text{nom})} + 0.5\text{V}$, $I_{OUT} = 100\mu\text{A}$ (adjustable)		2.4		
I_{GND}	GND pin current	$V_{IN} = V_{OUT(\text{nom})} + 2\text{V}$, $I_{OUT} = 150\text{mA}$		150		μA
I_{FB}	FB pin leakage current	$V_{IN} = 40\text{V}$			25	nA
PSRR	Power-supply ripple rejection	$V_{IN} = V_{OUT(\text{nom})} + 1\text{V}$, $I_{OUT} = 50\text{mA}$, $C_{OUT} = 0.47\mu\text{F}$, $f = 10\text{kHz}$		55		dB
		$V_{IN} = V_{OUT(\text{nom})} + 1\text{V}$, $I_{OUT} = 50\text{mA}$, $C_{OUT} = 0.47\mu\text{F}$, $f = 100\text{kHz}$		43		
V_n	Output noise voltage	Bandwidth = 10Hz to 100kHz, $V_{IN} = V_{OUT(\text{nom})} + 2.0\text{V}$, $I_{OUT} = 150\text{mA}$, $C_{OUT} = 1\mu\text{F}$		470		μV_{RMS}
T_{sd+}	Thermal shutdown temperature increasing	Shutdown, temperature increasing		160		$^\circ\text{C}$
T_{sd-}	Thermal shutdown temperature decreasing	Reset, temperature decreasing		140		$^\circ\text{C}$
t_{sup} ⁽⁴⁾	Start-up time			400		μs

- (1) Pulse-testing techniques are used to maintain virtual junction temperature as close as possible to ambient temperature; take thermal effects into account separately.
- (2) Higher power dissipation across the voltage regulator leads to activation of thermal shutdown circuit, preventing attainment of maximum output current.
- (3) Maximum supported power dissipation ratings are listed in *Absolute Maximum Rating* table. Exceeding these ratings leads to permanent SOA damage to the voltage regulator.
- (4) Start-up time is measured as difference between $t = 0$ when V_{IN} is ramped at slew rate more than $1\text{V}/\mu\text{s}$ and the time when V_{OUT} reaches 95% of $V_{OUT(\text{nom})}$ value.

5.6 Typical Characteristics

at operating junction temperature $T_J = 25^\circ\text{C}$, $V_{IN} = 2.5\text{V}$ or $V_{IN} = V_{OUT}(\text{nom}) + 0.5\text{V}$ (whichever is greater), $C_{IN} = 1\mu\text{F}$, $C_{OUT} = 1\mu\text{F}$, and $I_{OUT} = 1\text{mA}$ (unless otherwise noted)

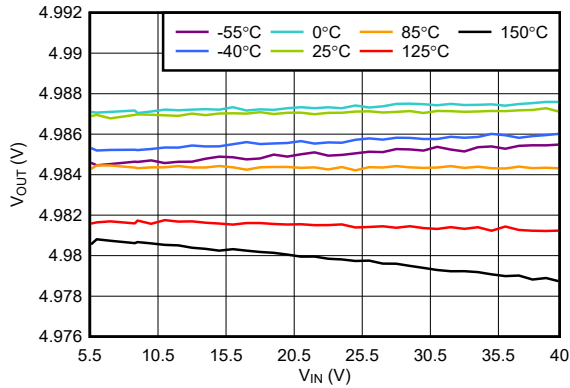

$V_{OUT} = 5.0\text{V}$, $I_{OUT} = 10\text{mA}$

図 5-1. V_{OUT} vs V_{IN}

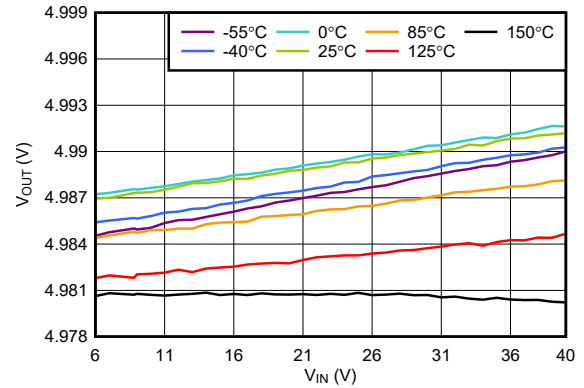

$V_{OUT} = 5.0\text{V}$, $I_{OUT} = 50\text{mA}$

図 5-2. V_{OUT} vs V_{IN}

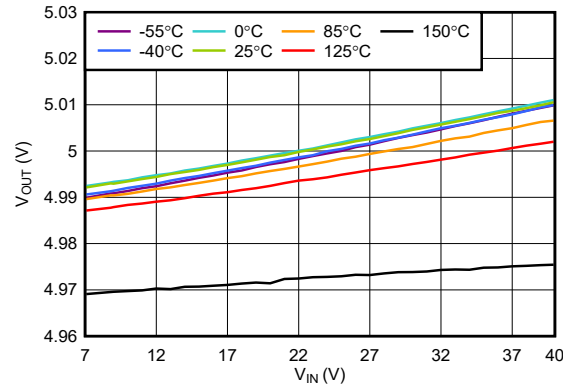

$V_{OUT} = 5.0\text{V}$, $I_{OUT} = 150\text{mA}$

図 5-3. V_{OUT} vs V_{IN}

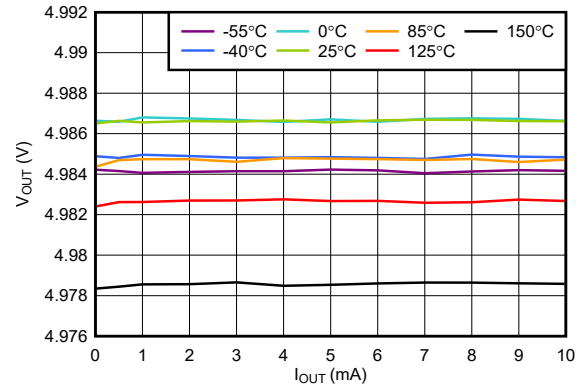

$V_{IN} = 5.5\text{V}$, $V_{OUT} = 5.0\text{V}$

図 5-4. V_{OUT} vs I_{OUT}

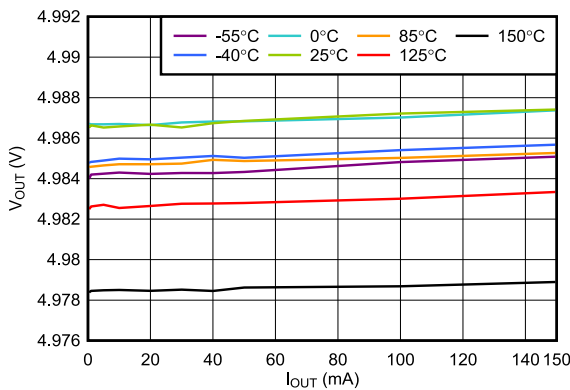

$V_{IN} = 7.0\text{V}$, $V_{OUT} = 5.0\text{V}$

図 5-5. V_{OUT} vs I_{OUT}

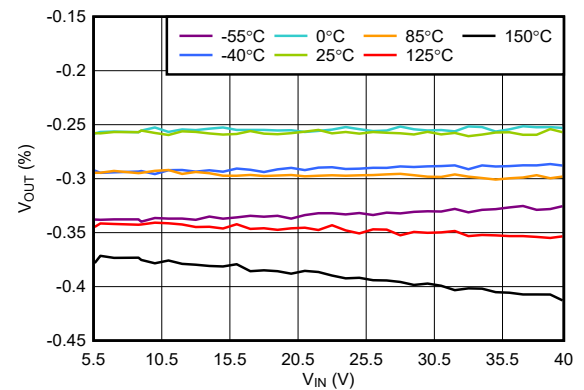

$V_{OUT} = 5.0\text{V}$, $I_{OUT} = 1.0\text{mA}$

図 5-6. V_{OUT} Accuracy vs V_{IN}

5.6 Typical Characteristics (continued)

at operating junction temperature $T_J = 25^\circ\text{C}$, $V_{IN} = 2.5\text{V}$ or $V_{IN} = V_{OUT}(\text{nom}) + 0.5\text{V}$ (whichever is greater), $C_{IN} = 1\mu\text{F}$, $C_{OUT} = 1\mu\text{F}$, and $I_{OUT} = 1\text{mA}$ (unless otherwise noted)

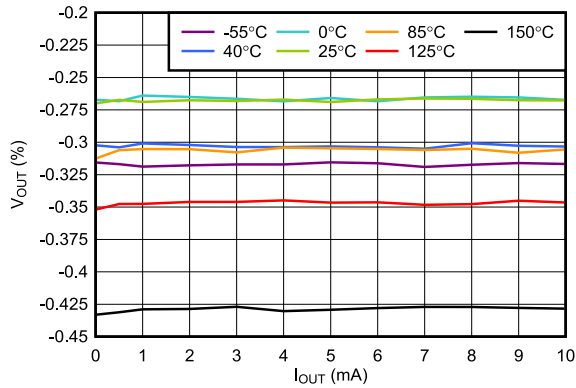

$V_{IN} = 5.5\text{V}$, $V_{OUT} = 5.0\text{V}$

5-7. V_{OUT} Accuracy vs I_{OUT}

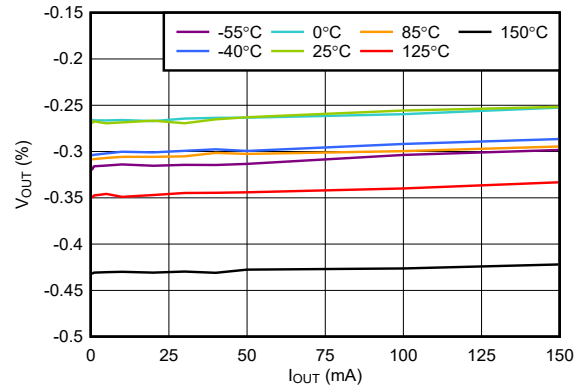

$V_{IN} = 7.0\text{V}$, $V_{OUT} = 5.0\text{V}$

5-8. V_{OUT} Accuracy vs I_{OUT}

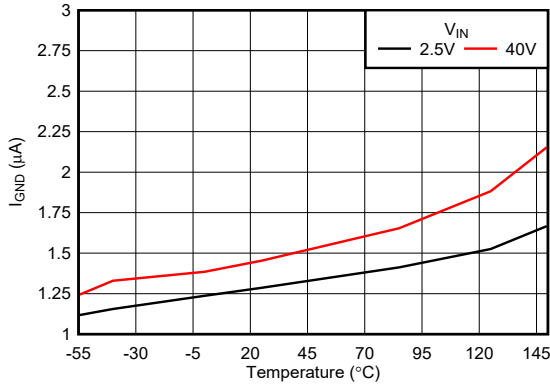

For adjustable configuration

5-9. I_{GND} vs Temperature

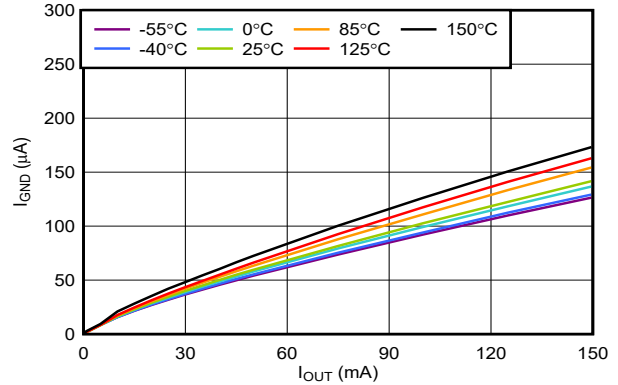

$V_{IN} = 8.8\text{V}$, $V_{OUT} = 5.0\text{V}$

5-10. I_{GND} vs I_{OUT}

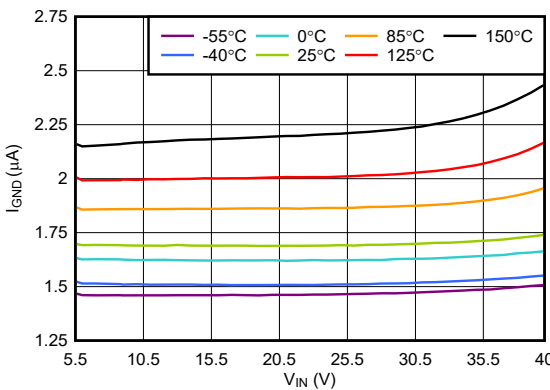

$V_{OUT} = 5.0\text{V}$, $I_{OUT} = 0\text{mA}$

5-11. I_{GND} vs V_{IN}

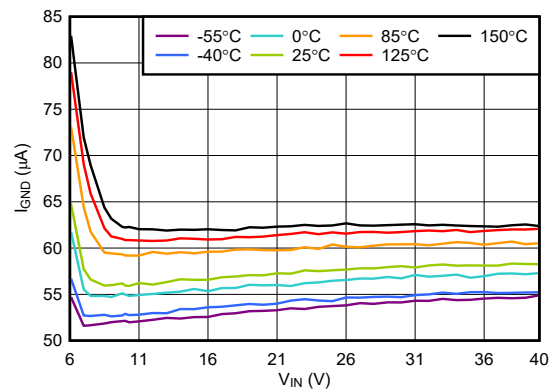

$V_{OUT} = 5.0\text{V}$, $I_{OUT} = 50\text{mA}$

5-12. I_{GND} vs V_{IN}

5.6 Typical Characteristics (continued)

at operating junction temperature $T_J = 25^\circ\text{C}$, $V_{IN} = 2.5\text{V}$ or $V_{IN} = V_{OUT}(\text{nom}) + 0.5\text{V}$ (whichever is greater), $C_{IN} = 1\mu\text{F}$, $C_{OUT} = 1\mu\text{F}$, and $I_{OUT} = 1\text{mA}$ (unless otherwise noted)

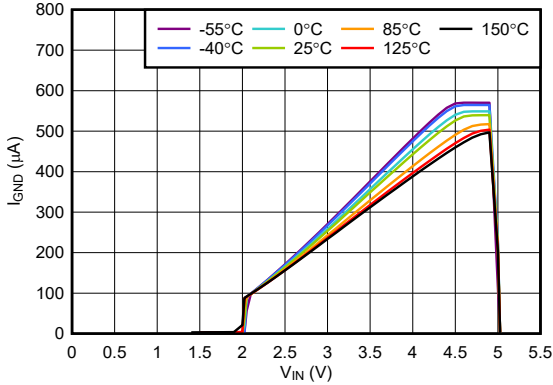

$V_{OUT} = 5.0\text{V}$, $I_{OUT} = 0\text{mA}$

图 5-13. I_{GND} vs V_{IN} (Dropout Operation)

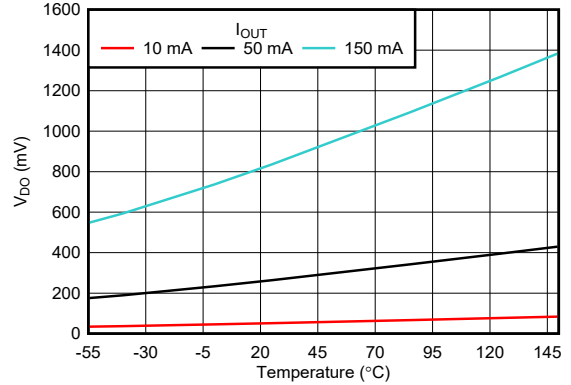

$V_{OUT} = 5.0\text{V}$

图 5-14. Dropout vs Temperature

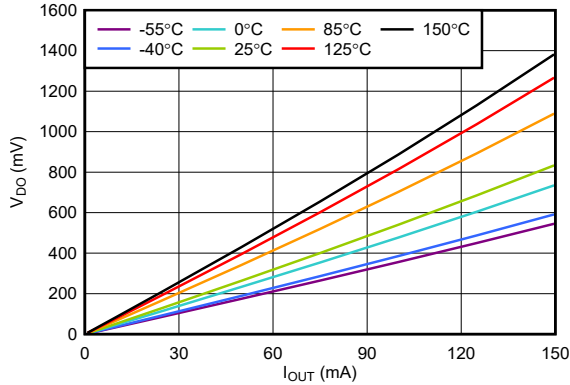

$V_{OUT} = 5.0\text{V}$

图 5-15. Dropout vs I_{OUT}

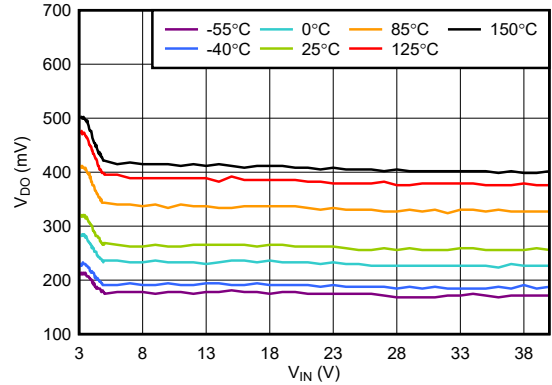

For adjustable configuration, $I_{OUT} = 50\text{mA}$

图 5-16. Dropout vs V_{IN}

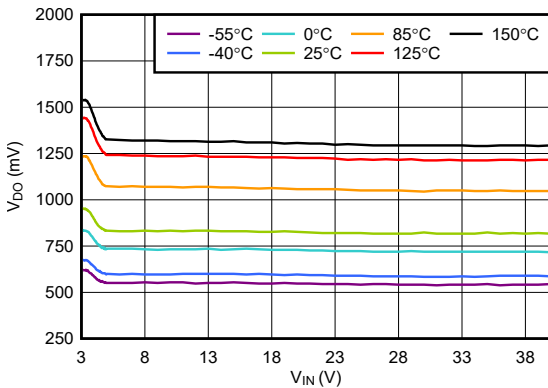

For adjustable configuration, $I_{OUT} = 150\text{mA}$

图 5-17. Dropout vs V_{IN}

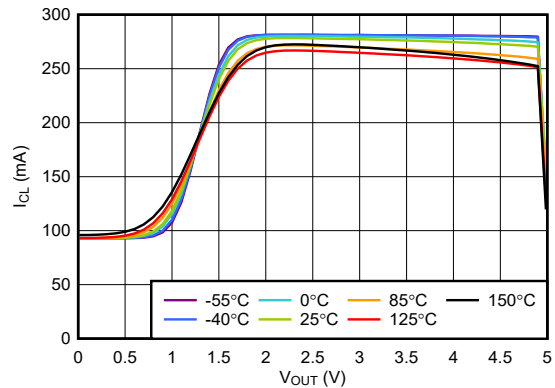

$V_{IN} = 9.0\text{V}$

图 5-18. Current Limit vs V_{OUT}

5.6 Typical Characteristics (continued)

at operating junction temperature $T_J = 25^\circ\text{C}$, $V_{IN} = 2.5\text{V}$ or $V_{IN} = V_{OUT}(\text{nom}) + 0.5\text{V}$ (whichever is greater), $C_{IN} = 1\mu\text{F}$, $C_{OUT} = 1\mu\text{F}$, and $I_{OUT} = 1\text{mA}$ (unless otherwise noted)

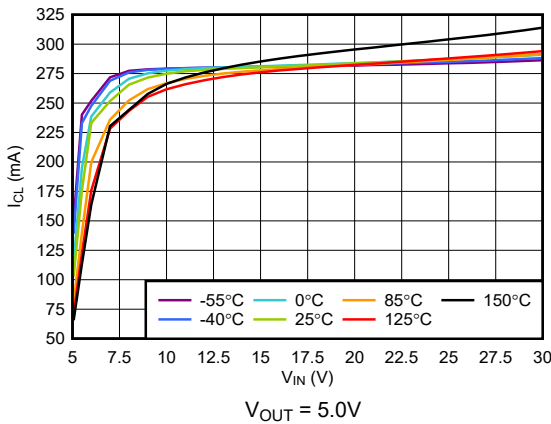

5-19. Current Limit vs V_{IN}

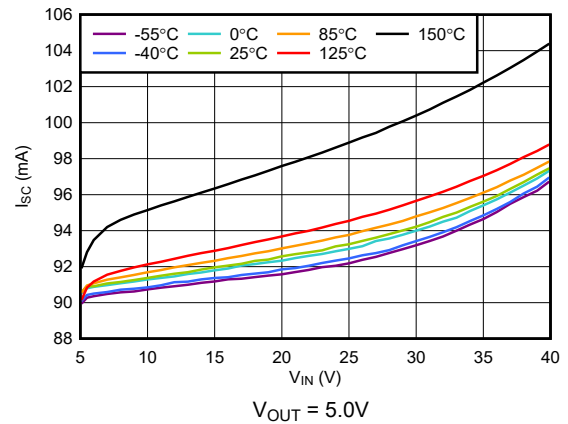

5-20. Short-Current Limit vs V_{IN}

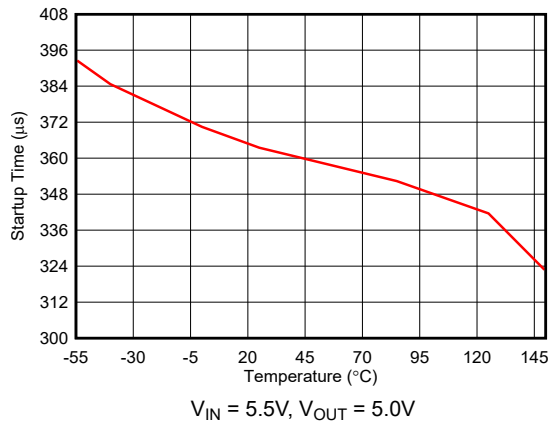

5-21. Start-Up Time vs Temperature

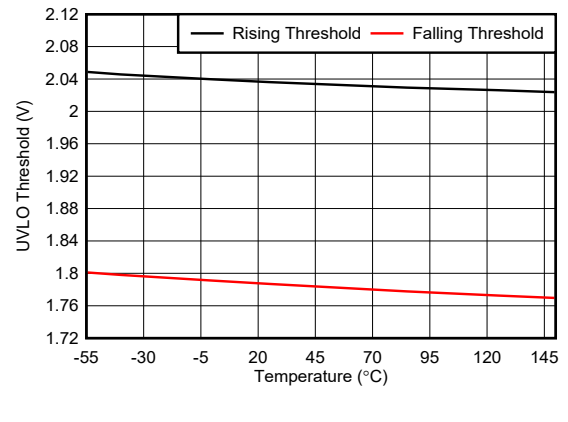

5-22. UVLO Thresholds vs Temperature

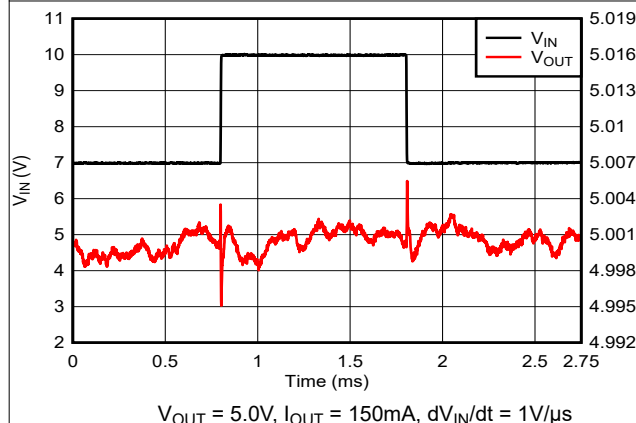

5-23. V_{IN} Line Transient (7V to 10V)

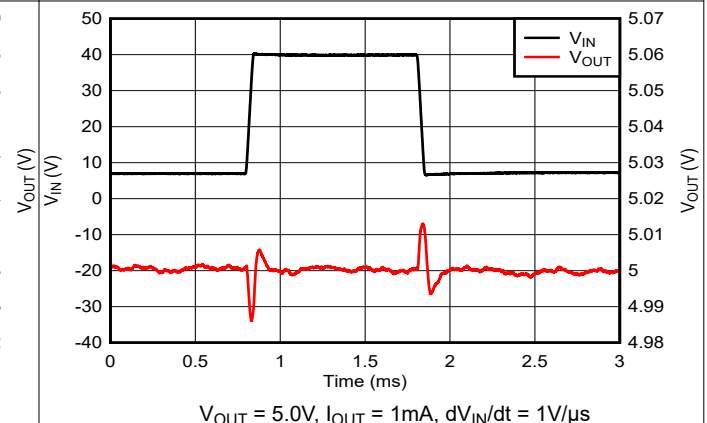

5-24. V_{IN} Line Transient (7V to 40V)

5.6 Typical Characteristics (continued)

at operating junction temperature $T_J = 25^\circ\text{C}$, $V_{IN} = 2.5\text{V}$ or $V_{IN} = V_{OUT}(\text{nom}) + 0.5\text{V}$ (whichever is greater), $C_{IN} = 1\mu\text{F}$, $C_{OUT} = 1\mu\text{F}$, and $I_{OUT} = 1\text{mA}$ (unless otherwise noted)

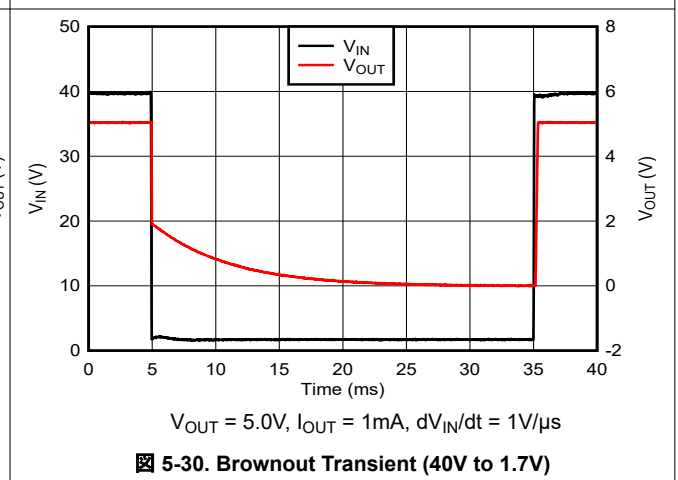
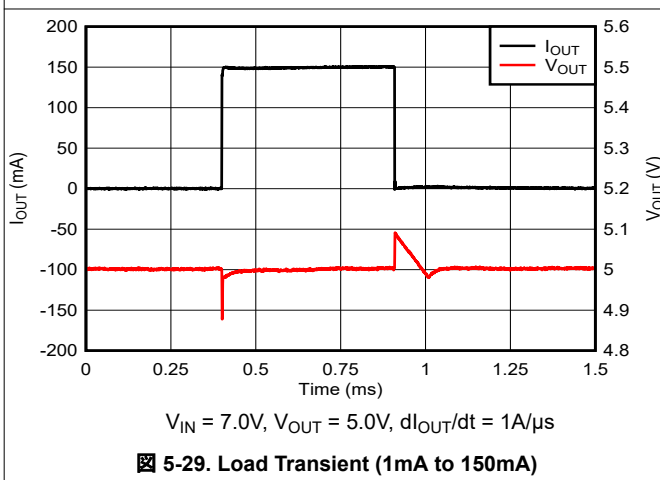
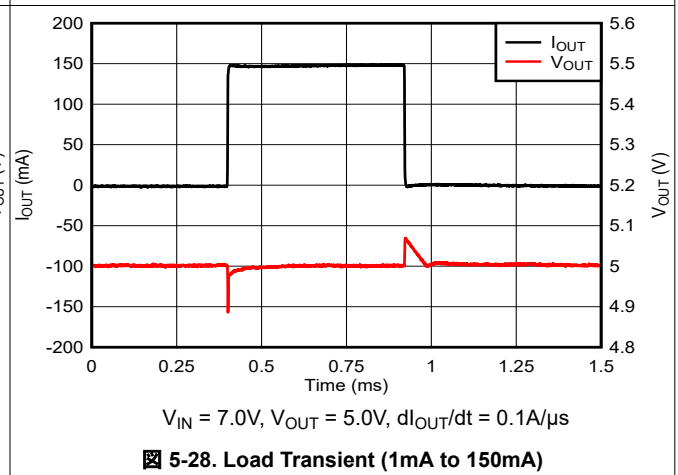
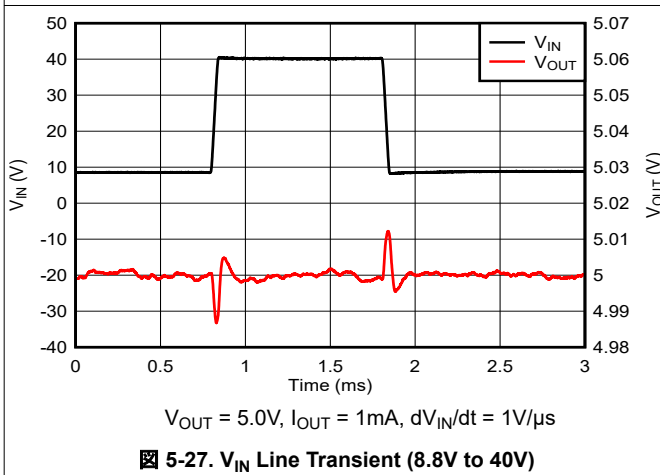
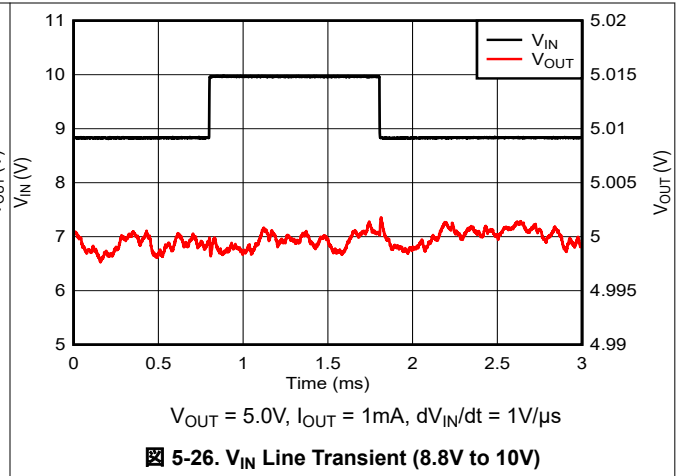
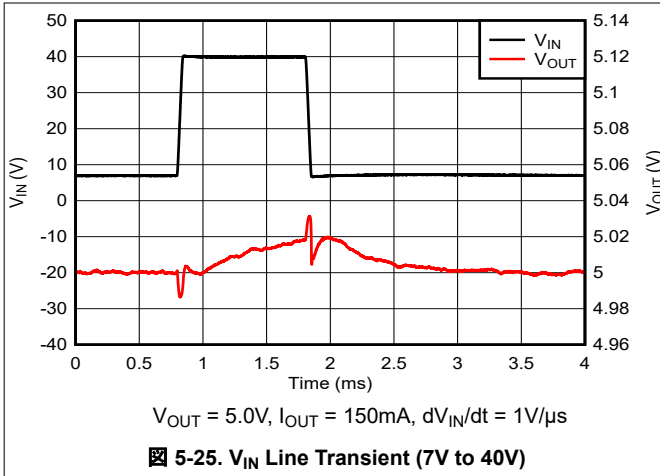

5.6 Typical Characteristics (continued)

at operating junction temperature $T_J = 25^\circ\text{C}$, $V_{IN} = 2.5\text{V}$ or $V_{IN} = V_{OUT}(\text{nom}) + 0.5\text{V}$ (whichever is greater), $C_{IN} = 1\mu\text{F}$, $C_{OUT} = 1\mu\text{F}$, and $I_{OUT} = 1\text{mA}$ (unless otherwise noted)

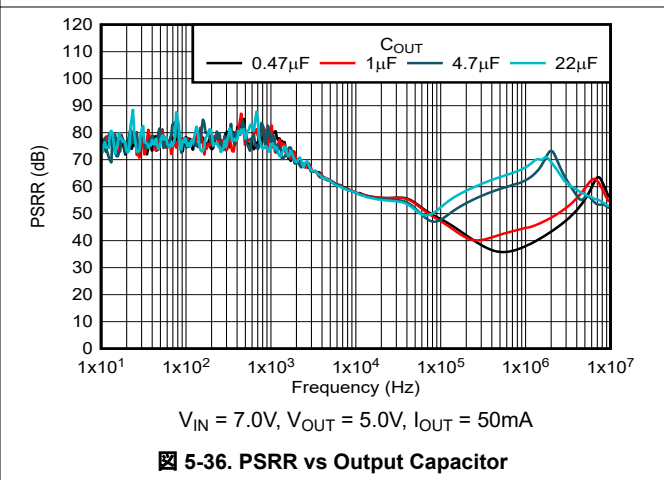
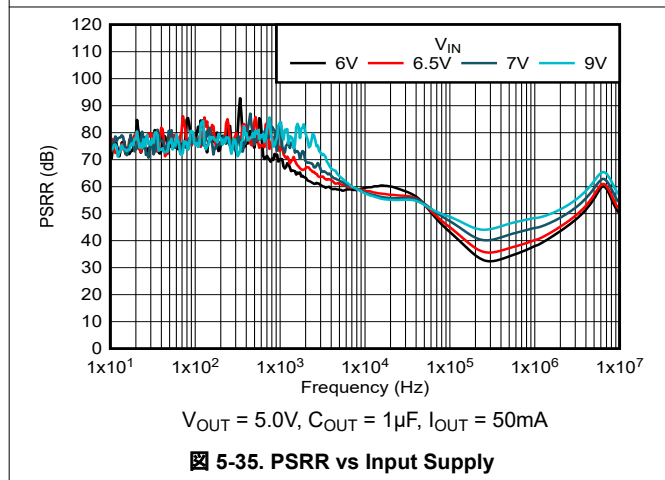
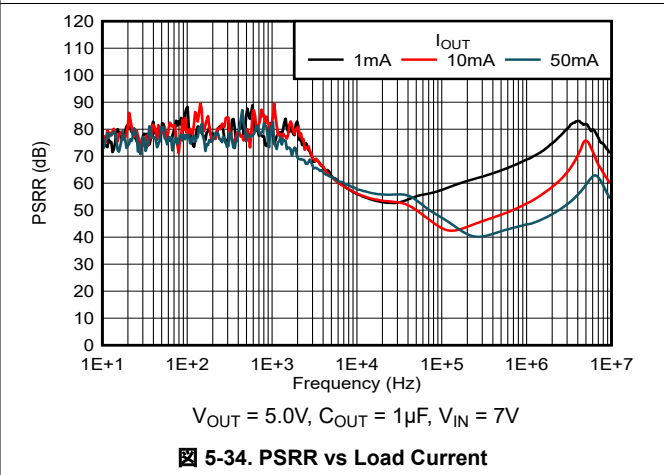
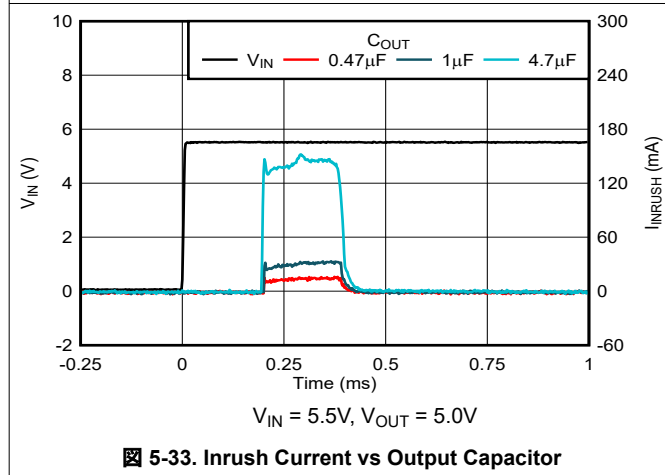
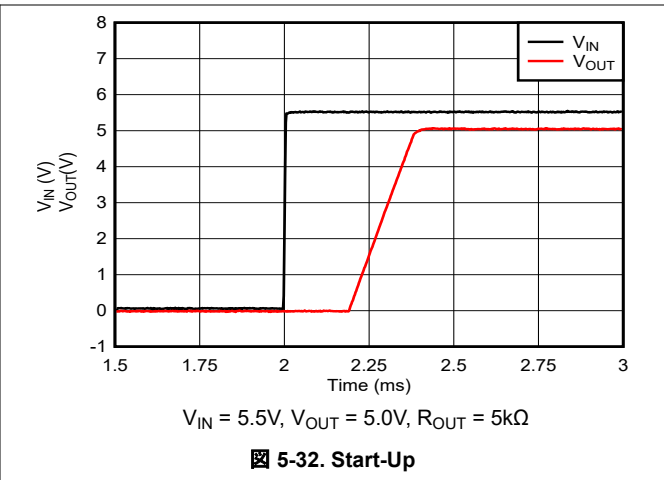
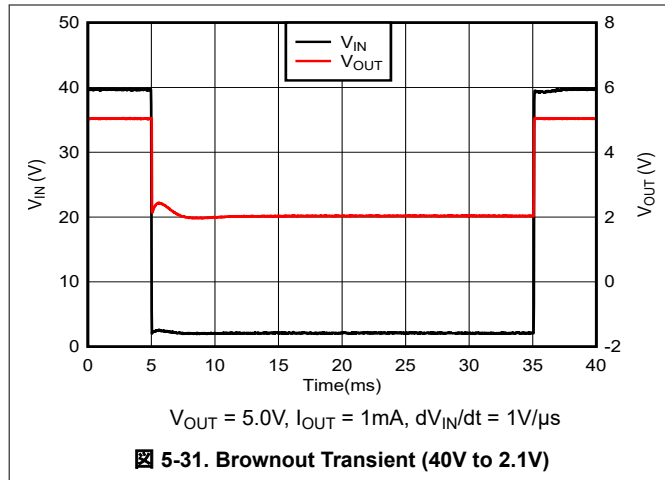

5.6 Typical Characteristics (continued)

at operating junction temperature $T_J = 25^\circ\text{C}$, $V_{IN} = 2.5\text{V}$ or $V_{IN} = V_{OUT}(\text{nom}) + 0.5\text{V}$ (whichever is greater), $C_{IN} = 1\mu\text{F}$, $C_{OUT} = 1\mu\text{F}$, and $I_{OUT} = 1\text{mA}$ (unless otherwise noted)

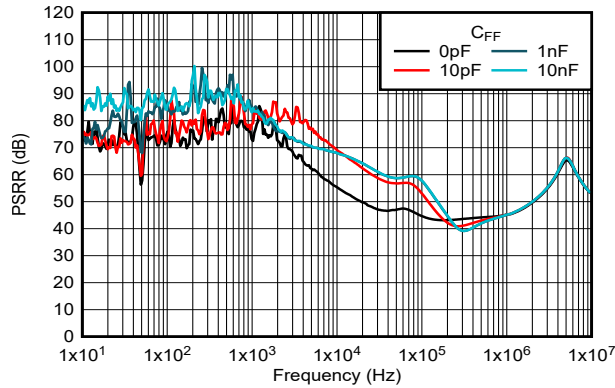

$V_{IN} = 7.0\text{V}$, $V_{OUT} = 5.0\text{V}$, $I_{OUT} = 50\text{mA}$, $C_{OUT} = 1\mu\text{F}$

5-37. PSRR vs Feed-Forward Capacitor

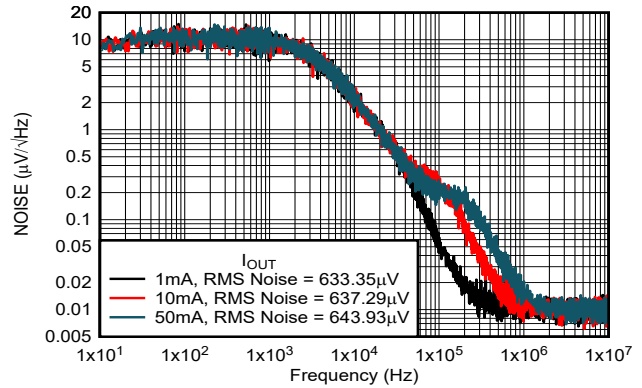

$V_{IN} = 7.0\text{V}$, $V_{OUT} = 5.0\text{V}$, $C_{OUT} = 1\mu\text{F}$

5-38. Noise vs Load Current

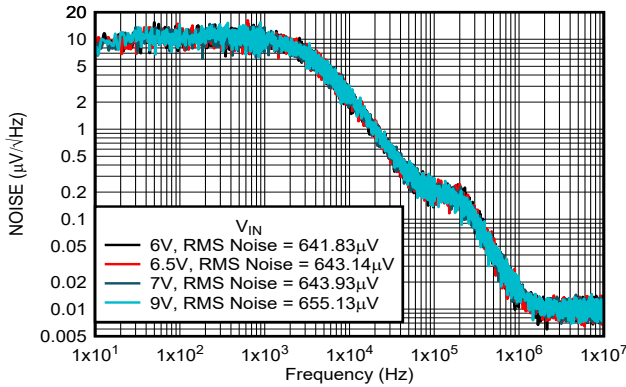

$V_{OUT} = 5.0\text{V}$, $I_{OUT} = 50\text{mA}$, $C_{OUT} = 1\mu\text{F}$

5-39. Noise vs Input Supply

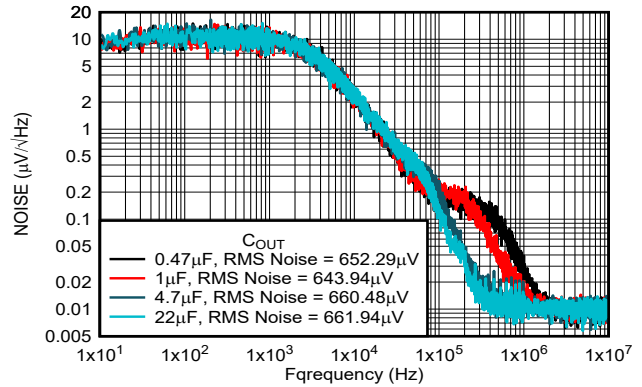

$V_{IN} = 7.0\text{V}$, $V_{OUT} = 5.0\text{V}$, $I_{OUT} = 50\text{mA}$

5-40. Noise vs Output Capacitor

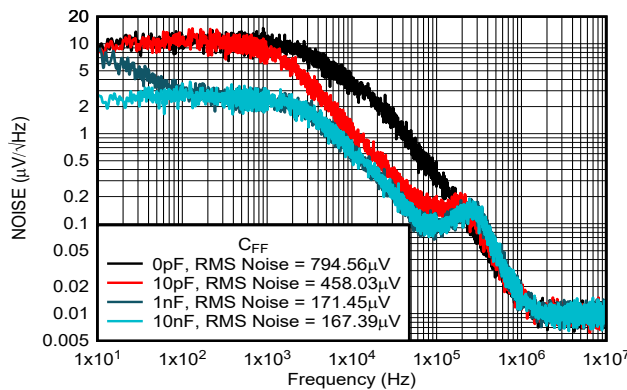

$V_{IN} = 7.0\text{V}$, $V_{OUT} = 5.0\text{V}$, $I_{OUT} = 50\text{mA}$, $C_{OUT} = 1\mu\text{F}$

5-41. Noise vs Feed-Forward Capacitor

6 Detailed Description

6.1 Overview

The TPS7B91 low-dropout regulator (LDO) consumes only 1.8µA (typ) of quiescent current at no-load current. The device offers a wide input voltage range (2.5V to 40V) and wide output range in small packaging. The wide output range is from 1.2V to $V_{IN} - V_{DO}$ for the adjustable output. The device is stable with the output capacitor range of 1µF to 47µF. The low quiescent current across the complete load current range makes the TPS7B91 designed for powering battery-operated applications. The TPS7B91 has an internal soft-start mechanism that provides a uniform start-up with controlled inrush current. This LDO also has fold-back overcurrent and thermal protection during a load-short or fault condition on the output.

6.2 Functional Block Diagrams



图 6-1. Functional Block Diagram: Adjustable Version



图 6-2. Functional Block Diagram: Fixed Version

6.3 Feature Description

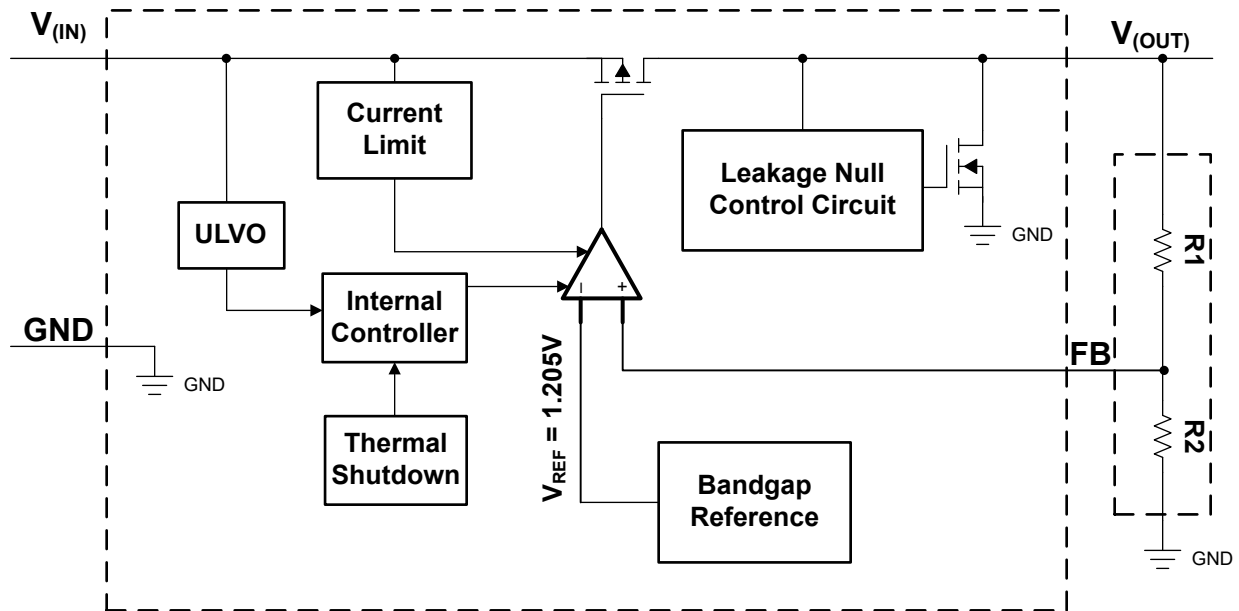
6.3.1 Wide Supply Range

This device has an operational input supply range of 2.5V to 40V, allowing for a wide range of applications. This wide supply range is designed for applications that have either large transients or high DC voltage supplies.

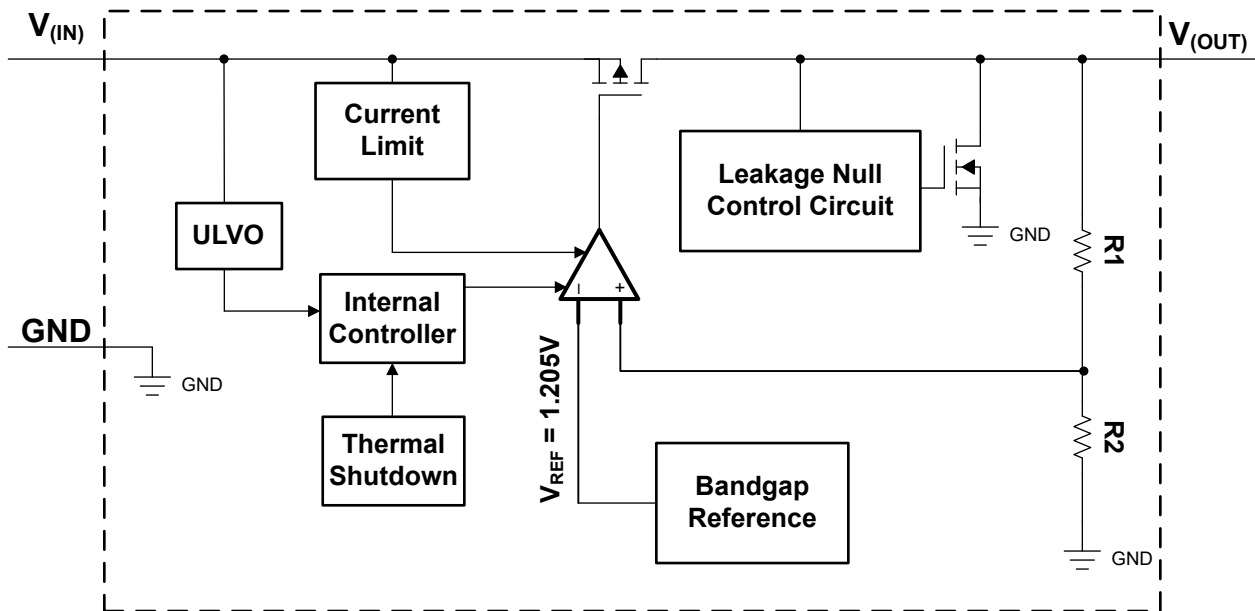
6.3.2 Low Quiescent Current

This device only requires 1.8μA (typical) of quiescent current at no load. The LDO consumes less than 0.1% of the full load current capacity (150mA) at room temperature. For load currents higher than 1mA, the TPS7B91 manages the I_Q consumption to be less than 0.5% of the load current to maintain high efficiency. In this manner, the device maintains good transient performance.

6.3.3 Dropout Voltage (V_{DO})

Dropout voltage (V_{DO}) is defined as $V_{IN} - V_{OUT}$ at the rated output current (I_{RATED}), where the pass transistor is fully on. $V_{IN} - V_{OUT}$ is input voltage minus the output voltage. I_{RATED} is the maximum I_{OUT} listed in the [Recommended Operating Conditions](#) table. In dropout operation, the pass transistor is in the ohmic or triode region of operation, and acts as a switch. Dropout voltage indirectly specifies a minimum input voltage greater than the nominal programmed output voltage where the output voltage is expected to stay in regulation. If the input voltage falls to less than the value required to maintain output regulation, then the output voltage falls as well.

For a CMOS regulator, the dropout voltage is determined by the drain-source, on-state resistance ($R_{DS(ON)}$) of the pass transistor. Therefore, if the linear regulator operates at less than the rated current, the dropout voltage for that current scales accordingly. [式 1](#) calculates the $R_{DS(ON)}$ of the device.

$$R_{DS(ON)} = \frac{V_{DO}}{I_{RATED}} \quad (1)$$

6.3.4 Current Limit

The device has an internal current limit circuit that protects the regulator during transient high-load current faults or shorting events. The current limit is a hybrid brick-wall-foldback scheme. The current limit transitions from a brick-wall scheme to a foldback scheme at the foldback voltage ($V_{FOLDBACK}$). In a high-load current fault with the output voltage above $V_{FOLDBACK}$, the brick-wall scheme limits the output current to the current limit (I_{CL}). When the voltage drops below $V_{FOLDBACK}$, a foldback current limit activates that scales back the current as the output voltage approaches GND. When the output is shorted, the device supplies a typical current called the short-circuit current limit (I_{SC}). I_{CL} and I_{SC} are listed in the [Electrical Characteristics](#) table.

For this device, $V_{FOLDBACK} = 50\% \times V_{OUT(nom)}$.

The output voltage is not regulated when the device is in current limit. When a current limit event occurs, the device begins to heat up because of the increase in power dissipation. When the device is in brick-wall current limit, the pass transistor dissipates power $[(V_{IN} - V_{OUT}) \times I_{CL}]$. When the device output is shorted and the output is below $V_{FOLDBACK}$, the pass transistor dissipates power $[(V_{IN} - V_{OUT}) \times I_{SC}]$. If thermal shutdown is triggered, the device turns off. After the device cools down, the internal thermal shutdown circuit turns the device back on. If the output current fault condition continues, the device cycles between current limit and thermal shutdown. For more information on current limits, see the [Know Your Limits application note](#).

☒ 6-3 shows a diagram of the foldback current limit.

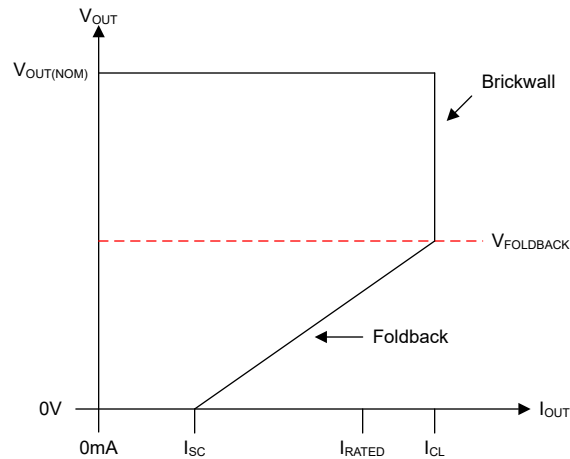

☒ 6-3. Foldback Current Limit

6.3.5 Leakage Null Control Circuit

This device has a built-in, leakage-null control circuit. At high temperatures, pass-transistor leakage increases and starts impacting the V_{OUT} accuracy at low-load conditions. This leakage becomes more aggravated with higher headroom across the LDO ($V_{IN} - V_{OUT}$). The TPS7B91 has a built-in, leakage-null control circuit that detects pass-transistor leakage and provides a ground discharge path for the leakage. This circuitry helps the TPS7B91 maintain much tighter V_{OUT} accuracy across wide V_{IN} and temperature ($-40^{\circ}C$ to $+125^{\circ}C$) ranges.

6.4 Device Functional Modes

表 6-1 provides a quick comparison between the normal and dropout modes of operation.

表 6-1. Device Functional Mode Comparison

OPERATING MODE	PARAMETER	
	V_{IN}	I_{OUT}
Normal	$V_{IN} > V_{OUT(nom)} + V_{DO}$	$I_{OUT} < I_{CL}$
Dropout	$V_{IN} < V_{OUT(nom)} + V_{DO}$	$I_{OUT} < I_{CL}$

6.4.1 Normal Operation

The device regulates to the nominal output voltage under the following conditions:

- The input voltage is greater than the nominal output voltage plus the dropout voltage ($V_{OUT(nom)} + V_{DO}$)
- The output current is less than the current limit ($I_{OUT} < I_{CL}$)
- The device junction temperature is greater than $-40^{\circ}C$ and less than $+125^{\circ}C$

6.4.2 Dropout Operation

The device operates in dropout mode when the input voltage is lower than the nominal output voltage plus the specified dropout voltage. However, make sure all other conditions are met for normal operation. In dropout operation, the pass transistor is in the ohmic or triode region of operation, and acts as a switch. Because of this operation, the transient performance of the device becomes significantly degraded. Line or load transients in dropout potentially result in large output voltage deviations.

When the device is in a steady dropout state, the pass transistor is driven into the ohmic or triode region. This state is defined as when the device is in dropout, directly after being in a normal regulation state, but *not* during start up. During dropout, $V_{IN} < V_{OUT(NOM)} + V_{DO}$. When the input voltage returns to a value $\geq V_{OUT(NOM)} + V_{DO}$,

the output voltage overshoots for a short period of time. During this time, the device pulls the pass transistor back into the linear region. $V_{OUT(NOM)}$ is the nominal output voltage and V_{DO} is the dropout voltage.

7 Application and Implementation

注

Information in the following applications sections is not part of the TI component specification, and TI does not warrant its accuracy or completeness. TI's customers are responsible for determining suitability of components for their purposes, as well as validating and testing their design implementation to confirm system functionality.

7.1 Application Information

The TPS7B91 LDO regulator is a good choice for battery-powered applications. The device is a good supply for low-power microcontrollers, such as the [MSP430](#), because of the device low I_Q performance across load current range. The ultra-low-supply current of the TPS7B91 maximizes efficiency at light loads. The device features flexibility in the output voltage selection for the adjustable configuration and fixed output levels. These features and the high input voltage range makes the device optimal as a supply in building automation and power tools.

7.2 Typical Application



図 7-1. Typical Application Circuit (Fixed-Voltage Version)



図 7-2. TPS7B9101 Adjustable LDO Regulator Programming

NOTE: Dotted lines indicate an optional input capacitor and feed-forward capacitor. See the [Input and Output Capacitor Requirements](#) and [Feed-Forward Capacitor \(\$C_{FF}\$ \)](#) sections and the [Recommended Operating Conditions](#) table.

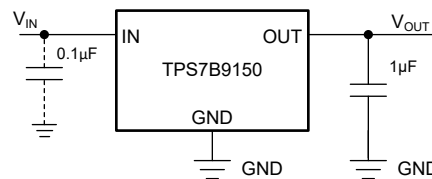
表 7-1. Adjustable Output Voltage for Resistors R_1 and R_2

OUTPUT VOLTAGE (V)	R_1 (MΩ)	R_2 (MΩ)
1.8	0.499	1
2.8	1.33	1
5.0	3.16	1

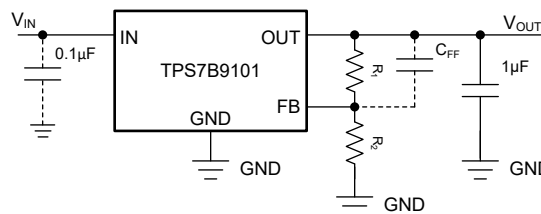
7.2.1 Design Requirements

表 7-2 summarizes the design requirements for 図 7-1.

表 7-2. Design Parameters

PARAMETER	DESIGN REQUIREMENT
Input voltage	12V
Output voltage	5.0V
Output current	100mA

7.2.2 Detailed Design Procedure

7.2.2.1 Setting V_{OUT} for the TPS7B9101 Adjustable LDO

As illustrated in [Figure 7-2](#), the TPS7B91 contains an adjustable version (the TPS7B9101) that sets the output voltage using an external resistor divider. The output voltage operating range is 1.205V to $V_{IN} - V_{DO}$, and is calculated using:

$$V_{OUT} = V_{REF} \times \left(1 + \frac{R_1}{R_2}\right) \quad (2)$$

where:

- $V_{REF} = 1.205\text{V}$ (typical)

Choose resistors R_1 and R_2 to allow approximately 1.5 μA of current through the resistor divider. To ignore the FB pin current error term in the V_{OUT} equation, set the feedback divider current to 15 times the FB pin current listed in the [Electrical Characteristics](#) table. Using lower value resistors improves noise performance, but consumes more power. Avoid higher resistor values. Leakage current into or out of FB across R_1 / R_2 creates an offset voltage proportional to V_{OUT} divided by V_{REF} . Choose $R_2 = 1\text{M}\Omega$ to set the divider current at 1.205 μA . [Equation 3](#) calculates R_1 . [Figure 7-2](#) depicts this configuration.

$$R_1 = \left(\frac{V_{OUT}}{V_{REF}} - 1\right) \times R_2 \quad (3)$$

To understand more about the impact of feedback divider current on the output accuracy, see the [\$I_Q\$ vs Accuracy Tradeoff in Designing Resistor Divider](#) application note.

7.2.2.2 External Capacitor Requirements

The device is designed to be stable using low equivalent series resistance (ESR) ceramic capacitors at the input and output. Multilayer ceramic capacitors have become the industry standard for these types of applications and are recommended, but use good judgment. Ceramic capacitors that employ X7R-, X5R-, and C0G-rated dielectric materials provide relatively good capacitive stability across temperature. However, using Y5V-rated capacitors is discouraged because of large variations in capacitance.

Regardless of the ceramic capacitor type selected, the effective capacitance varies with operating voltage and temperature. Generally, expect the effective capacitance to decrease by as much as 50%. The input and output capacitors listed in the [Recommended Operating Conditions](#) table account for an effective capacitance of approximately 50% of the nominal value.

7.2.2.3 Input and Output Capacitor Requirements

Although an input capacitor is not required for stability, good analog design practice is to connect a capacitor from IN to GND. This capacitor counteracts reactive input sources and improves transient response, input ripple, and PSRR. Use an input capacitor if the source impedance is more than 0.5 Ω . A higher value capacitor is necessary if large, fast rise-time load or line transients are anticipated. A higher value capacitor is also required if the device is located several inches from the input power source.

Dynamic performance of the device is improved by using a larger output capacitor. The TPS7B91 requires an output capacitor of 1 μF or larger (0.47 μF or larger capacitance) for stability. An equivalent series resistance (ESR) between 0.001 Ω and 1 Ω is also required. For best transient performance, use X5R- and X7R-type ceramic capacitors because these capacitors have minimal variation in value and ESR over temperature. When choosing a capacitor for a specific application, be mindful of the DC bias characteristics for the capacitor. Higher output voltages cause a significant derating of the capacitor. Use an output capacitor within the range specified in the [Recommended Operating Conditions](#) table for stability.

7.2.2.4 Reverse Current

Excessive reverse current potentially damages this device. Reverse current flows through the intrinsic body diode of the PMOS pass transistor instead of the normal conducting channel. At high magnitudes, this current flow degrades the long-term reliability of the device.

Conditions where reverse current occur are outlined in this section, all of which exceed the absolute maximum rating of $V_{OUT} \leq V_{IN} + 0.3V$. These conditions are:

- If the device has a large C_{OUT} and the input supply collapses with little or no load current
- The output is biased when the input supply is not established
- The output is biased above the input supply

If reverse current flow is expected in the application, use external protection to protect the device. Reverse current is not limited in the device, so external limiting is required if extended reverse voltage operation is anticipated. Limit reverse current to 5% or less of the rated output current of the device in the event this current cannot be avoided.

Figure 7-3 shows one approach for protecting the device.

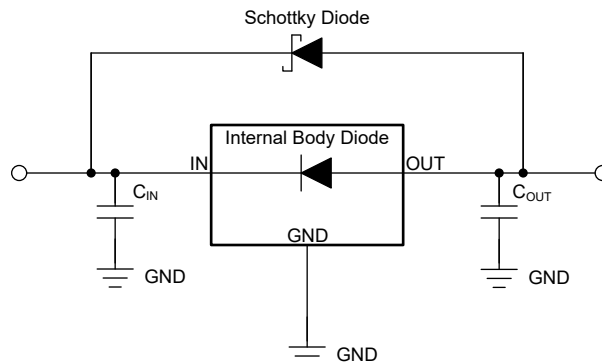

Figure 7-3. Example Circuit for Reverse Current Protection Using a Schottky Diode

7.2.2.5 Feed-Forward Capacitor (C_{FF})

For the adjustable-voltage version device, connect a feed-forward capacitor (C_{FF}) from the OUT pin to the FB pin. C_{FF} improves transient, noise, and PSRR performance, but is not required for regulator stability. Recommended C_{FF} values are listed in the [Recommended Operating Conditions](#) table. Using a higher capacitance C_{FF} causes the start-up time to increase. For a detailed description of C_{FF} tradeoffs, see the [Pros and Cons of Using a Feedforward Capacitor with a Low-Dropout Regulator application note](#).

C_{FF} and R_1 form a zero in the loop gain at frequency f_z . C_{FF} , R_1 , and R_2 form a pole in the loop gain at frequency f_p . Calculate the C_{FF} zero and pole frequencies from the following equations:

$$f_z = 1 / (2 \times \pi \times C_{FF} \times R_1) \quad (4)$$

$$f_p = 1 / (2 \times \pi \times C_{FF} \times (R_1 \parallel R_2)) \quad (5)$$

$C_{FF} \geq 10\text{pF}$ is required for stability if the feedback divider current is less than $5\mu\text{A}$. Equation 6 calculates the feedback divider current.

$$I_{FB_Divider} = V_{OUT} / (R_1 + R_2) \quad (6)$$

To avoid the start-up time increasing from C_{FF} , limit the product of $C_{FF} \times R_1 < 50\mu\text{s}$.

For an output voltage of 1.205V with the FB pin tied to the OUT pin, do not use C_{FF} .

7.2.2.6 Power Dissipation (P_D)

Circuit reliability requires consideration of the device power dissipation, circuit location on the printed circuit board (PCB), and correct sizing of the thermal plane. Make sure the PCB area around the regulator has few or no other heat-generating devices that cause added thermal stress.

To first-order approximation, power dissipation in the regulator depends on the input-to-output voltage difference and load conditions. The following equation calculates power dissipation (P_D).

$$P_D = (V_{IN} - V_{OUT}) \times I_{OUT} \quad (7)$$

注

Power dissipation is minimized, and therefore greater efficiency achieved, by correct selection of the system voltage rails. For the lowest power dissipation, use the minimum input voltage required for correct output regulation.

For devices with a thermal pad, the primary heat conduction path for the device package is through the thermal pad to the PCB. Solder the thermal pad to a copper pad area under the device. Make sure this pad area contains an array of plated vias that conduct heat to additional copper planes for increased heat dissipation.

The maximum power dissipation determines the maximum allowable ambient temperature (T_A) for the device. According to 式 8, power dissipation and junction temperature are most often related by the junction-to-ambient thermal resistance ($R_{\theta JA}$). The $R_{\theta JA}$ component is the combined PCB, device package, and the temperature of the ambient air (T_A).

$$T_J = T_A + (R_{\theta JA} \times P_D) \quad (8)$$

The maximum peak power dissipation supported for the TPS7B91 is defined in the *Absolute Maximum Ratings*. The power dissipation ratings are recorded for the PCB configurations and are based on a JEDEC standard of 2s2p configuration (EIA/JESD51-x). The maximum supported power provides reliable operation for the TPS7B91. Exceeding the power limits leads to extreme junction temperatures (related to junction-to-ambient thermal resistance $R_{\theta JA}$, 式 8). Extreme temperatures risk damage to the device, and potentially reduces the expected device lifetime. Based on the safe operating limits, 図 7-4 shows the supported load current (I_{OUT}) for a headroom ($V_{IN} - V_{OUT}$).



図 7-4. I_{OUT} vs Headroom ($V_{IN} - V_{OUT}$)

Thermal resistance ($R_{\theta JA}$) is highly dependent on the heat-spreading capability built into the particular PCB design. Therefore, $R_{\theta JA}$ varies according to the total copper area, copper weight, and location of the planes. The junction-to-ambient thermal resistance listed in the *Thermal Information* table is determined by the JEDEC standard PCB and copper-spreading area. $R_{\theta JA}$ is used as a relative measure of package thermal performance.

$R_{\theta JA}$ is improved by 35% to 55% compared to the *Thermal Information* table value with the PCB board layout optimized. See the [An empirical analysis of the impact of board layout on LDO thermal performance application note](#).

7.2.2.7 Estimating Junction Temperature

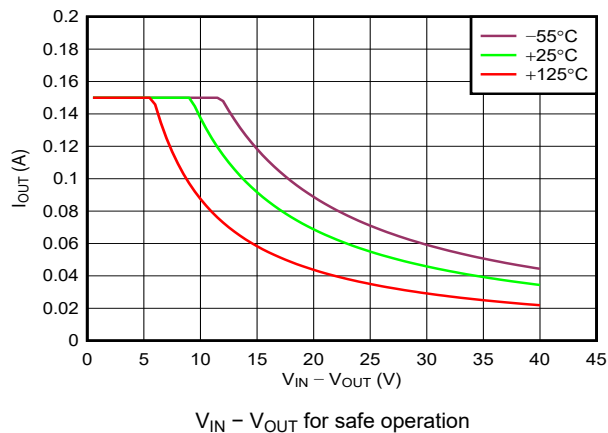
The JEDEC standard now recommends using psi (Ψ) thermal metrics to estimate the junction temperatures of the LDO when in-circuit on a typical PCB board application. These metrics are not thermal resistance parameters and instead offer a practical and relative way to estimate junction temperature. These psi metrics are determined to be significantly independent of the copper area available for heat-spreading. The *Thermal Information* table lists the primary thermal metrics, which are the junction-to-top characterization parameter (ψ_{JT}) and junction-to-board characterization parameter (ψ_{JB}). These parameters provide two methods for calculating the junction temperature (T_J), as described in the following equations. Use the junction-to-top characterization parameter (ψ_{JT}) with the temperature at the center-top of device package (T_T) to calculate the junction temperature. Use the junction-to-board characterization parameter (ψ_{JB}) with the PCB surface temperature 1mm from the device package (T_B) to calculate the junction temperature.

$$T_J = T_T + \psi_{JT} \times P_D \quad (9)$$

where:

- P_D is the dissipated power
- T_T is the temperature at the center-top of the device package

$$T_J = T_B + \psi_{JB} \times P_D \quad (10)$$

where:

- T_B is the PCB surface temperature measured 1mm from the device package and centered on the package edge

For detailed information on the thermal metrics and how to use them, see [Semiconductor and IC Package Thermal Metrics application note](#).

7.2.3 Application Curves

at operating temperature $T_J = 25^\circ\text{C}$, $V_{IN} = V_{OUT(\text{NOM})} + 0.5\text{V}$ or 2.5V (whichever is greater), $I_{OUT} = 1\text{mA}$, $C_{IN} = 1\mu\text{F}$, and $C_{OUT} = 1\mu\text{F}$ (unless otherwise noted)

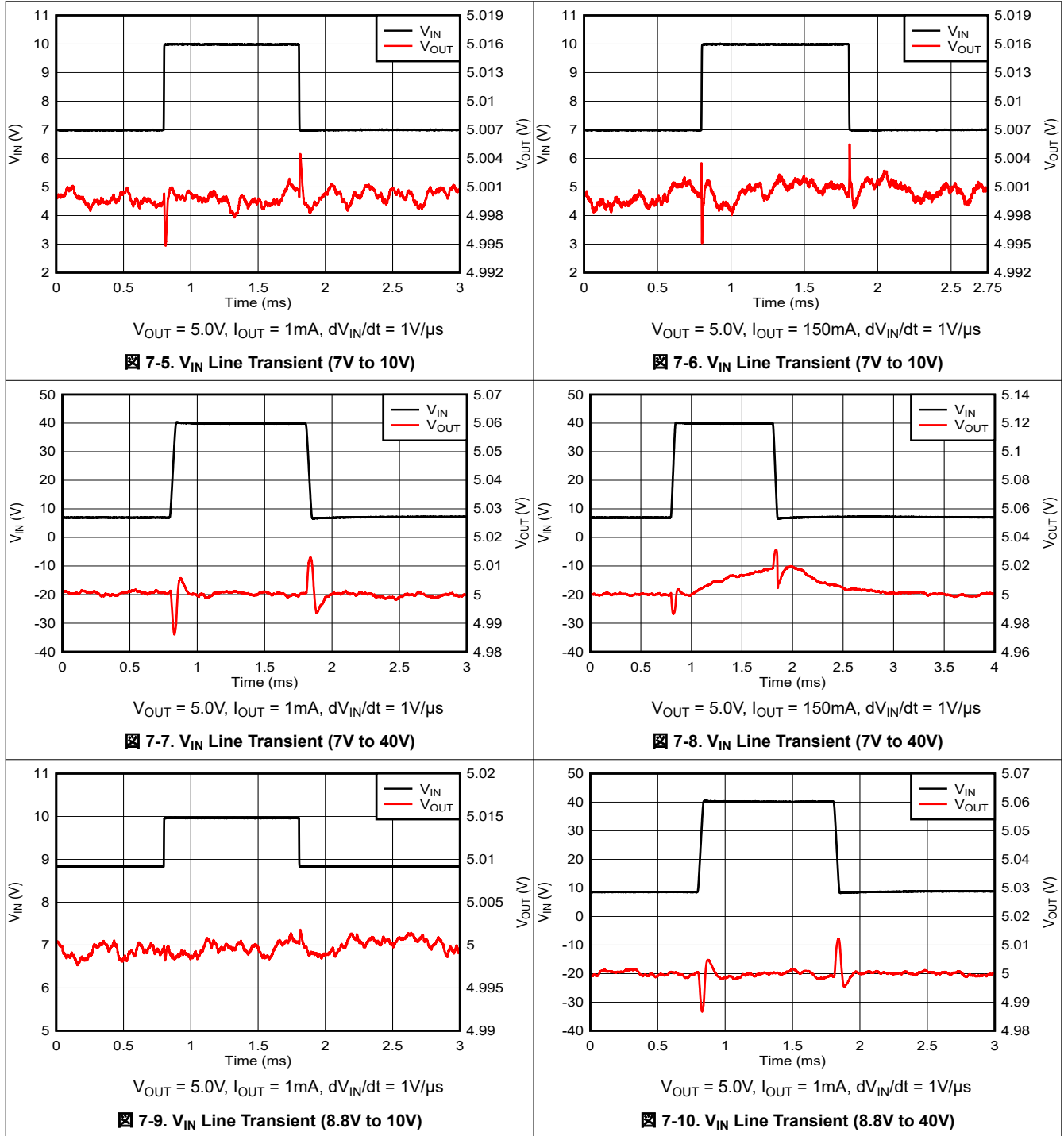

7.2.3 Application Curves (continued)

at operating temperature $T_J = 25^\circ\text{C}$, $V_{IN} = V_{OUT(\text{NOM})} + 0.5\text{V}$ or 2.5V (whichever is greater), $I_{OUT} = 1\text{mA}$, $C_{IN} = 1\mu\text{F}$, and $C_{OUT} = 1\mu\text{F}$ (unless otherwise noted)

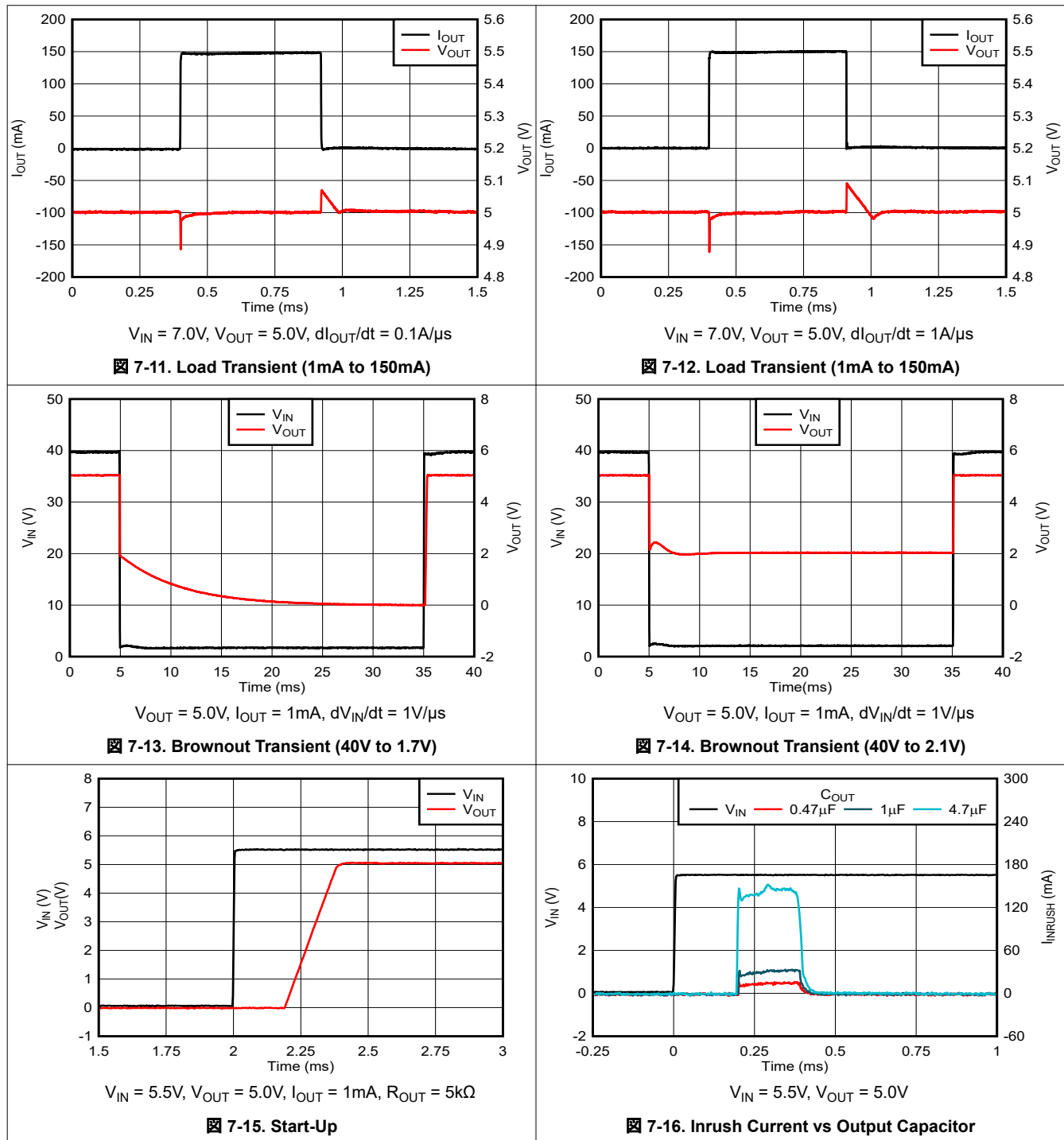

7.3 Best Design Practices

Place at least one 1.0µF capacitor as close as possible to the OUT and GND pins of the regulator.

Do not connect the output capacitor to the regulator using a long, thin trace.

Connect an input capacitor as close as possible to the IN and GND pins of the regulator for best performance.

Do not exceed the absolute maximum ratings.

7.4 Power Supply Recommendations

The TPS7B91 is designed to operate from an input voltage supply range between 2.5V and 40V. The input voltage range provides adequate headroom for the device to have a regulated output. If the input supply is noisy, additional input capacitors with low ESR help improve output noise performance.

7.5 Layout

7.5.1 Layout Guidelines

For best overall performance, follow the guidelines in this section. Place all circuit components on the same side of the printed circuit board (PCB) and as near as practical to the respective LDO pin connections. Place ground return connections for the input and output capacitors as close to the GND pin as possible, using wide, component-side, copper planes. Do not use vias and long traces to create LDO circuit connections to the input capacitor, output capacitor, or resistor divider. This practice negatively affects system performance. This grounding and layout scheme minimizes inductive parasitics, and thereby reduces load current transients, minimizes noise, and increases circuit stability. A ground reference plane is also recommended and is embedded in the PCB or located on the bottom side of the PCB opposite the components. This reference plane serves to provide accuracy of the output voltage and shield the LDO from noise.

7.5.1.1 Power Dissipation

To provide reliable operation, make sure worst-case junction temperature does not exceed 125°C. This restriction limits the power dissipation the regulator handles in any given application. To make sure the junction temperature is within acceptable limits, calculate the maximum allowable dissipation ($P_{D(max)}$). Also calculate the actual dissipation (P_D) to be less than or equal to $P_{D(max)}$.

式 11 determines the maximum-power-dissipation limit:

$$P_{D(max)} = \frac{T_{Jmax} - T_A}{R_{\theta JA}} \quad (11)$$

where:

- T_{Jmax} is the maximum allowable junction temperature
- $R_{\theta JA}$ is the thermal resistance junction-to-ambient for the package (see the *Thermal Information* table)
- T_A is the ambient temperature

式 12 calculates the regulator dissipation:

$$P_D = (V_{IN} - V_{OUT}) \times I_{OUT} \quad (12)$$

7.5.2 Layout Example



図 7-17. Example Layout for the TPS7B9101

8 Device and Documentation Support

8.1 Device Support

8.1.1 Development Support

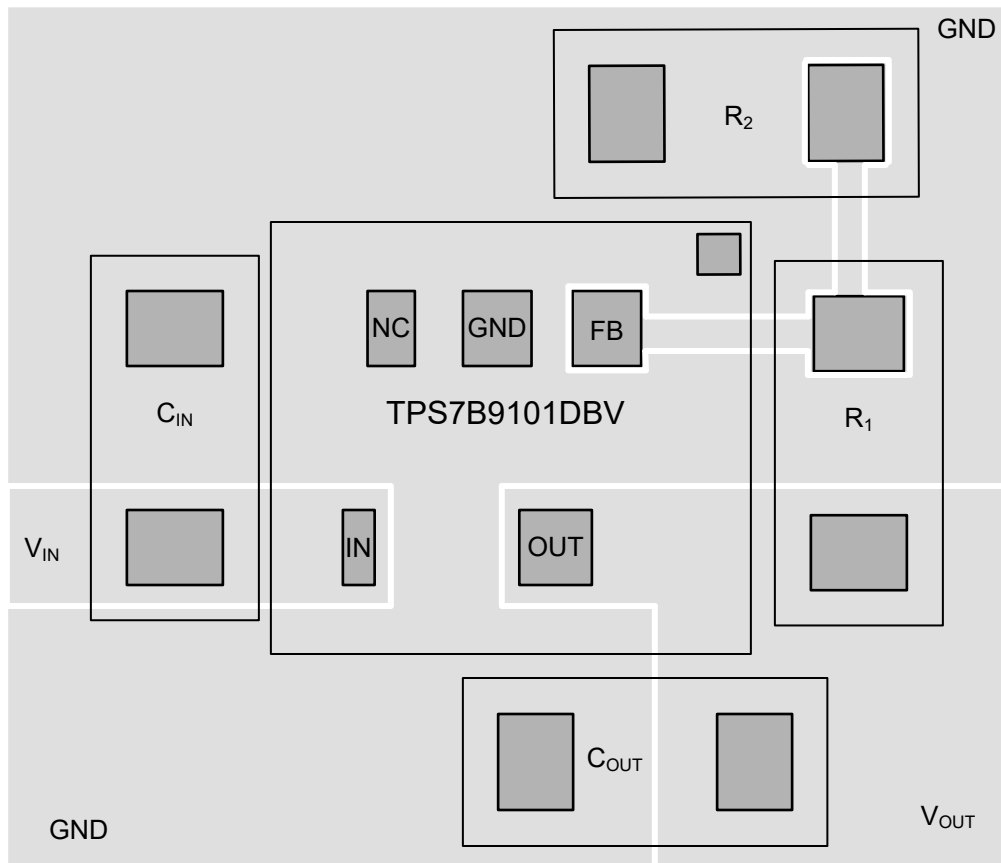
8.1.1.1 Evaluation Module

An evaluation module (EVM) is available to assist in the initial circuit performance evaluation using the TPS7B91. The [Universal EVM](#) (and related [user's guide](#)) can be requested at the TI website through the product folders or purchased directly from [the TI eStore](#).

8.1.1.2 Spice Models

Computer simulation of circuit performance using SPICE is often useful when analyzing the performance of analog circuits and systems. A SPICE model for the TPS7B91 is available through the product folders under *Tools & Software*.

8.1.2 Device Nomenclature

表 8-1. Device Nomenclature

PRODUCT ⁽¹⁾	V _{OUT}
TPS7B91 xxDBVz	In the SOT-23 (DBV) package: XX is the nominal output voltage (for example, 33 = 3.3V, 50 = 5.0V, 01 = Adjustable). Z is the package quantity.

(1) For the most current package and ordering information see the Package Option Addendum at the end of this document, or see the TI website at [www.ti.com](#).

8.2 Documentation Support

8.2.1 Related Documentation

For related documentation see the following:

- Texas Instruments, [Universal Low-Dropout Linear Voltage Regulator \(LDO\) Evaluation Module user guide](#)

8.3 ドキュメントの更新通知を受け取る方法

ドキュメントの更新についての通知を受け取るには、[www.tij.co.jp](#) のデバイス製品フォルダを開いてください。[通知] をクリックして登録すると、変更されたすべての製品情報に関するダイジェストを毎週受け取ることができます。変更の詳細については、改訂されたドキュメントに含まれている改訂履歴をご覧ください。

8.4 サポート・リソース

[テキサス・インスツルメンツ E2E™ サポート・フォーラム](#)は、エンジニアが検証済みの回答と設計に関するヒントをエキスパートから迅速かつ直接得ることができる場所です。既存の回答を検索したり、独自の質問をしたりすることで、設計に必要な支援を迅速に得ることができます。

リンクされているコンテンツは、各寄稿者により「現状のまま」提供されるものです。これらはテキサス・インスツルメンツの仕様を構成するものではなく、必ずしもテキサス・インスツルメンツの見解を反映したものではありません。テキサス・インスツルメンツの[使用条件](#)を参照してください。

8.5 Trademarks

テキサス・インスツルメンツ E2E™ is a trademark of Texas Instruments.

すべての商標は、それぞれの所有者に帰属します。

8.6 静電気放電に関する注意事項



この IC は、ESD によって破損する可能性があります。テキサス・インスツルメンツは、IC を取り扱う際には常に適切な注意を払うことを推奨します。正しい取り扱いおよび設置手順に従わない場合、デバイスを破損するおそれがあります。

ESD による破損は、わずかな性能低下からデバイスの完全な故障まで多岐にわたります。精密な IC の場合、パラメータがわずかに変化するだけで公表されている仕様から外れる可能性があるため、破損が発生しやすくなっています。

8.7 用語集

[テキサス・インスツルメンツ用語集](#) この用語集には、用語や略語の一覧および定義が記載されています。

9 Revision History

資料番号末尾の英字は改訂を表しています。その改訂履歴は英語版に準じています。

DATE	REVISION	NOTES
April 2024	*	Initial Release

10 Mechanical, Packaging, and Orderable Information

The following pages include mechanical, packaging, and orderable information. This information is the most current data available for the designated devices. This data is subject to change without notice and revision of this document. For browser-based versions of this data sheet, refer to the left-hand navigation.

重要なお知らせと免責事項

テキサス・インスツルメンツは、技術データと信頼性データ (データシートを含みます)、設計リソース (リファレンス デザインを含みます)、アプリケーションや設計に関する各種アドバイス、Web ツール、安全性情報、その他のリソースを、欠陥が存在する可能性のある「現状のまま」提供しており、商品性および特定目的に対する適合性の黙示保証、第三者の知的財産権の非侵害保証を含むいかなる保証も、明示的または黙示的にかかわらず拒否します。

これらのリソースは、テキサス・インスツルメンツ製品を使用する設計の経験を積んだ開発者への提供を意図したものです。(1) お客様のアプリケーションに適した テキサス・インスツルメンツ製品の選定、(2) お客様のアプリケーションの設計、検証、試験、(3) お客様のアプリケーションに該当する各種規格や、その他のあらゆる安全性、セキュリティ、規制、または他の要件への確実な適合に関する責任を、お客様のみが単独で負うものとします。

上記の各種リソースは、予告なく変更される可能性があります。これらのリソースは、リソースで説明されている テキサス・インスツルメンツ製品を使用するアプリケーションの開発の目的でのみ、テキサス・インスツルメンツはその使用をお客様に許諾します。これらのリソースに関して、他の目的で複製することや掲載することは禁止されています。テキサス・インスツルメンツや第三者の知的財産権のライセンスが付与されている訳ではありません。お客様は、これらのリソースを自身で使用した結果発生するあらゆる申し立て、損害、費用、損失、責任について、テキサス・インスツルメンツおよびその代理人を完全に補償するものとし、テキサス・インスツルメンツは一切の責任を拒否します。

テキサス・インスツルメンツの製品は、[テキサス・インスツルメンツの販売条件](#)、または [ti.com](https://www.ti.com) やかかる テキサス・インスツルメンツ製品の関連資料などのいずれかを通じて提供する適用可能な条項の下で提供されています。テキサス・インスツルメンツがこれらのリソースを提供することは、適用されるテキサス・インスツルメンツの保証または他の保証の放棄の拡大や変更を意味するものではありません。

お客様がいかなる追加条項または代替条項を提案した場合でも、テキサス・インスツルメンツはそれらに異議を唱え、拒否します。

郵送先住所: Texas Instruments, Post Office Box 655303, Dallas, Texas 75265
Copyright © 2024, Texas Instruments Incorporated

TAPE AND REEL INFORMATION

QUADRANT ASSIGNMENTS FOR PIN 1 ORIENTATION IN TAPE

*All dimensions are nominal

Device	Package Type	Package Drawing	Pins	SPQ	Reel Diameter (mm)	Reel Width W1 (mm)	A0 (mm)	B0 (mm)	K0 (mm)	P1 (mm)	W (mm)	Pin1 Quadrant
TPS7B91018DBVR	SOT-23	DBV	5	3000	180.0	8.4	3.2	3.2	1.4	4.0	8.0	Q3
TPS7B91033DBVR	SOT-23	DBV	5	3000	180.0	8.4	3.2	3.2	1.4	4.0	8.0	Q3
TPS7B91050DBVR	SOT-23	DBV	5	3000	180.0	8.4	3.2	3.2	1.4	4.0	8.0	Q3
TPS7B91120DBVR	SOT-23	DBV	5	3000	180.0	8.4	3.2	3.2	1.4	4.0	8.0	Q3

TAPE AND REEL BOX DIMENSIONS



*All dimensions are nominal

Device	Package Type	Package Drawing	Pins	SPQ	Length (mm)	Width (mm)	Height (mm)
TPS7B91018DBVR	SOT-23	DBV	5	3000	210.0	185.0	35.0
TPS7B91033DBVR	SOT-23	DBV	5	3000	210.0	185.0	35.0
TPS7B91050DBVR	SOT-23	DBV	5	3000	210.0	185.0	35.0
TPS7B91120DBVR	SOT-23	DBV	5	3000	210.0	185.0	35.0

重要なお知らせと免責事項

TI は、技術データと信頼性データ (データシートを含みます)、設計リソース (リファレンス・デザインを含みます)、アプリケーションや設計に関する各種アドバイス、Web ツール、安全性情報、その他のリソースを、欠陥が存在する可能性のある「現状のまま」提供しており、商品性および特定目的に対する適合性の黙示保証、第三者の知的財産権の非侵害保証を含むいかなる保証も、明示的または黙示的にかかわらず拒否します。

これらのリソースは、TI 製品を使用する設計の経験を積んだ開発者への提供を意図したものです。(1) お客様のアプリケーションに適した TI 製品の選定、(2) お客様のアプリケーションの設計、検証、試験、(3) お客様のアプリケーションに該当する各種規格や、その他のあらゆる安全性、セキュリティ、規制、または他の要件への確実な適合に関する責任を、お客様のみが単独で負うものとし、

上記の各種リソースは、予告なく変更される可能性があります。これらのリソースは、リソースで説明されている TI 製品を使用するアプリケーションの開発の目的でのみ、TI はその使用をお客様に許諾します。これらのリソースに関して、他の目的で複製することや掲載することは禁止されています。TI や第三者の知的財産権のライセンスが付与されている訳ではありません。お客様は、これらのリソースを自身で使用した結果発生するあらゆる申し立て、損害、費用、損失、責任について、TI およびその代理人を完全に補償するものとし、TI は一切の責任を拒否します。

TI の製品は、[TI の販売条件](#)、または [ti.com](#) やかかる TI 製品の関連資料などのいずれかを通じて提供する適用可能な条項の下で提供されています。TI がこれらのリソースを提供することは、適用される TI の保証または他の保証の放棄の拡大や変更を意味するものではありません。

お客様がいかなる追加条項または代替条項を提案した場合でも、TI はそれらに異議を唱え、拒否します。

郵送先住所 : Texas Instruments, Post Office Box 655303, Dallas, Texas 75265
Copyright © 2024, Texas Instruments Incorporated