

# TPS82740x 360-nA I<sub>Q</sub> MicroSiP™ Step Down Converter Module for Low Power Applications

## 1 Features

- 360-nA Typical Quiescent Current
- Up to 90% Efficiency at 10-μA Output Current
- Pin-Selectable Output Voltages in 100-mV Steps
- Integrated Slew Rate Controlled Load Switch
- Up to 200-mA Output Current
- Input Voltage Range V<sub>IN</sub> from 2.2 V to 5.5 V
- RF Friendly DCS-Control™
- Low Output Voltage Ripple
- Automatic Transition to No Ripple 100% Mode
- Discharge Function on V<sub>OUT</sub> and LOAD
- Sub 1.1-mm Profile Solution
- Total Solution Size < 6.7mm<sup>2</sup>
- Small 2.3 mm × 2.9 mm MicroSiP™ Package

## 2 Applications

- Bluetooth® Low Energy, RF4CE, Zigbee
- Wearable Electronics
- Energy Harvesting

## 3 Description

The TPS82740 is the industry's first step-down converter module featuring typically 360-nA quiescent current consumption. It is a complete MicroSiP™ DC/DC step-down power solution intended for ultra low-power applications. The module includes the switching regulator, inductor and input/output capacitors. The integration of all required passive components enables a tiny solution size of only 6.7 mm<sup>2</sup>.

This new DCS-Control™ based device extends the light load efficiency range below 10-μA load currents. It supports output currents up to 200 mA.

The device operates from rechargeable Li-Ion batteries, Li-primary battery chemistries such as Li-SOCI<sub>2</sub>, Li-MnO<sub>2</sub> and two or three cell alkaline batteries. The input voltage range up to 5.5 V also allows operation from an USB port and thin-film solar modules.

The output voltage is user selectable by three voltage select pins (VSEL), within a range from 1.8 V to 2.5 V (TPS82740A) and 2.6 V to 3.3 V (TPS82740B) in 100-mV steps. The TPS82740 features low output voltage ripple and low noise. Once the battery voltage comes close to the output voltage (close to 100% duty cycle), the device enters no ripple 100% mode operation preventing an increase of output voltage ripple. In this case the device stops switching and the output is connected to the input voltage.

The integrated slew rate controlled load switch with a typical ON-resistance of 0.6Ω distributes the selected output voltage to a temporarily used sub-system.

The TPS82740 is available in a small 9-bump 6.7 mm<sup>2</sup> MicroSiP™ package.

### Device Information<sup>(1)</sup>

PART NUMBER	PACKAGE	BODY SIZE (NOM)
TPS82740A	μSiP	2.30 mm × 2.90 mm
TPS82740B	μSiP	2.30 mm × 2.90 mm

(1) For all available packages, see the orderable addendum at the end of the datasheet.

**Figure 1. Typical Application**

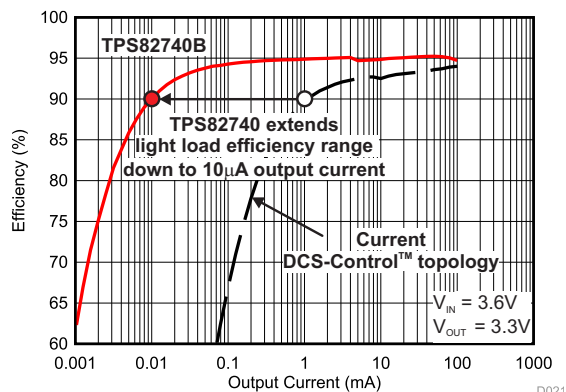
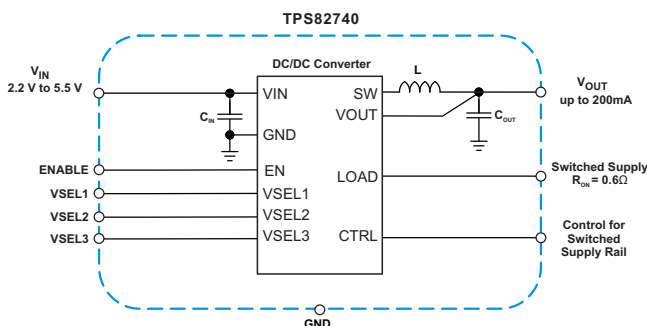

D021



## Table of Contents

<b>1 Features</b> .....	<b>1</b>	9.3 Feature Description.....	<b>15</b>
<b>2 Applications</b> .....	<b>1</b>	9.4 Device Functional Modes.....	<b>17</b>
<b>3 Description</b> .....	<b>1</b>	<b>10 Application and Implementation</b> .....	<b>20</b>
<b>4 Revision History</b> .....	<b>2</b>	10.1 Application Information.....	<b>20</b>
<b>5 Device Comparison Table</b> .....	<b>3</b>	10.2 Typical Application .....	<b>20</b>
<b>6 Pin Configuration and Functions</b> .....	<b>3</b>	<b>11 Power Supply Recommendations</b> .....	<b>23</b>
<b>7 Specifications</b> .....	<b>4</b>	<b>12 Layout</b> .....	<b>23</b>
7.1 Absolute Maximum Ratings .....	<b>4</b>	12.1 Layout Guidelines .....	<b>23</b>
7.2 ESD Ratings .....	<b>4</b>	12.2 Layout Example .....	<b>23</b>
7.3 Recommended Operating Conditions.....	<b>4</b>	12.3 Surface Mount Information.....	<b>24</b>
7.4 Thermal Information .....	<b>5</b>	<b>13 Device and Documentation Support</b> .....	<b>25</b>
7.5 Electrical Characteristics.....	<b>5</b>	13.1 Documentation Support .....	<b>25</b>
7.6 Typical Characteristics .....	<b>6</b>	13.2 Trademarks .....	<b>25</b>
<b>8 Parameter Measurement Information</b> .....	<b>14</b>	13.3 Electrostatic Discharge Caution.....	<b>25</b>
<b>9 Detailed Description</b> .....	<b>15</b>	13.4 Glossary .....	<b>25</b>
9.1 Overview .....	<b>15</b>	<b>14 Mechanical, Packaging, and Orderable Information</b> .....	<b>25</b>
9.2 Functional Block Diagram .....	<b>15</b>	14.1 Tape and Reel Information .....	<b>26</b>

## 4 Revision History

NOTE: Page numbers for previous revisions may differ from page numbers in the current version.

### Changes from Original (June 2014) to Revision A

Page

- Added 150 mA Typical current specification for  $I_{LIM\_softstart}$ , Low side MOSFET switch current limit..... **6**

## 5 Device Comparison Table

PART NUMBER	OUTPUT VOLTAGE SETTINGS (VSEL1, VSEL2, VSEL3)	PACKAGE MARKING
TPS82740A	1.8V to 2.5V in 100mV steps	E7
TPS82740B	2.6V to 3.3V in 100mV steps	E8

## 6 Pin Configuration and Functions

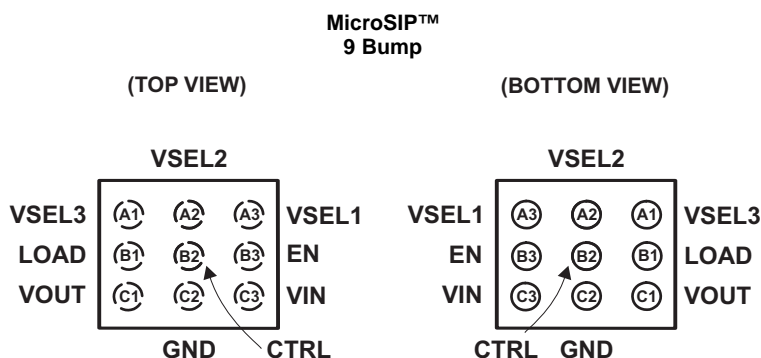

### Pin Functions

PIN		I/O	DESCRIPTION
NAME	NO		
VIN	C3	IN	Input voltage supply pin of the module.
GND	C2	-	Ground terminal.
CTRL	B2	IN	CTRL pin controls the LOAD output pin. With CTRL = low, the LOAD output is disabled. This pin must be terminated and not left floating.
VOUT	C1	OUT	Output voltage pin of the module. An internal load switch is connected between VOUT pin and LOAD pin.
LOAD	B1	OUT	Load switch output pin controlled by the CTRL pin. With CTRL = high, an internal load switch connects the LOAD pin to the VOUT pin. The LOAD pin allows connect / disconnect other system components to the output of the DC/DC converter. This pin is pulled to GND with the CTRL pin = low. The LOAD pin features soft switching. If not used, leave the pin open.
VSEL3	A1	IN	Output voltage selection pins. See <a href="#">Table 1</a> and <a href="#">Table 2</a> for V <sub>OUT</sub> selection. These pins must be terminated and can be changed during operation.
VSEL2	A2	IN	
VSEL1	A3	IN	
EN	B3	IN	High level enables the devices and low level turns the device into shutdown mode. This pin must be terminated and not left floating.

**Table 1. Output Voltage Setting TPS82740A**

Device	VOUT	VSEL3	VSEL2	VSEL1
TPS82740A	1.8	0	0	0
	1.9	0	0	1
	2.0	0	1	0
	2.1	0	1	1
	2.2	1	0	0
	2.3	1	0	1
	2.4	1	1	0
	2.5	1	1	1

**Table 2. Output Voltage Setting TPS82740B**

Device	VOUT	VSEL3	VSEL2	VSEL1
TPS82740B	2.6	0	0	0
	2.7	0	0	1
	2.8	0	1	0
	2.9	0	1	1
	3.0	1	0	0
	3.1	1	0	1
	3.2	1	1	0
	3.3	1	1	1

## 7 Specifications

### 7.1 Absolute Maximum Ratings<sup>(1)</sup>

Over operating free-air temperature range (unless otherwise noted)

		VALUE		UNIT
		MIN	MAX	
Pin voltage <sup>(2)</sup>	VIN	-0.3	6	V
	EN, CTRL, VSEL1, VSEL2, VSEL3	-0.3	VIN + 0.3V	V
	VOUT, LOAD	-0.3	3.7	V
Operating ambient temperature range, TA <sup>(3)</sup>		-40	85	°C
Operating junction temperature TJ		-40	125	°C
Storage temperature, Tstg		-55	125	

- (1) Stresses beyond those listed under *absolute maximum ratings* may cause permanent damage to the device. These are stress ratings only and functional operation of the device at these or any other conditions beyond those indicated under *recommended operating conditions* is not implied. Exposure to absolute–maximum–rated conditions for extended periods may affect device reliability.
- (2) All voltage values are with respect to network ground terminal GND.
- (3) In applications where ambient temperature (TA) constantly stays above 70°C, the product life time might degrade. MLCC capacitor reliability and lifetime is depending on temperature and applied voltage conditions. At higher temperatures, MLCC capacitors are subject to stronger stress. The most critical parameter is the Insulation Resistance (IR) resulting in leakage current.

### 7.2 ESD Ratings

			VALUE	UNIT
V(ESD)	Electrostatic discharge	Human body model (HBM), per ANSI/ESDA/JEDEC JS-001, all pins <sup>(1)</sup>	±2000	V
		Charged device model (CDM), per JEDEC specification JESD22-C101, all pins <sup>(2)</sup>	±1000	

- (1) JEDEC document JEP155 states that 500-V HBM allows safe manufacturing with a standard ESD control process. The human body model is a 100-pF capacitor discharged through a 1.5-kΩ resistor into each pin.
- (2) JEDEC document JEP157 states that 250-V CDM allows safe manufacturing with a standard ESD control process.

### 7.3 Recommended Operating Conditions

over operating free-air temperature range (unless otherwise noted)

		MIN	NOM	MAX	UNIT
VIN	Supply voltage VIN	2.2		5.5	V
IOUT + ILOAD	Device output current (sum of IOUT and ILOAD)	VOUTnom + 0.7V ≤ VIN ≤ 5.5V		200	mA
		VOUTnom ≤ VIN ≤ VOUTnom + 0.7V		100	
ILOAD	Load current (current from LOAD pin)			100	
COUT	Additional output capacitance connected to VOUT pin (not including LOAD pin)			10	μF
CLOAD	Capacitance connected to LOAD pin			10	
TJ	Operating junction temperature range	-40		90	°C
TA	Operating ambient temperature range	-40		85	

## 7.4 Thermal Information

THERMAL METRIC <sup>(1)</sup>		TPS82740		UNIT
		μSIP		
		9 PINS		
R <sub>θJA</sub>	Junction-to-ambient thermal resistance	83		°C/W
R <sub>θJC(top)</sub>	Junction-to-case (top) thermal resistance	53		
R <sub>θJB</sub>	Junction-to-board thermal resistance	-		
ψ <sub>JT</sub>	Junction-to-top characterization parameter	-		
ψ <sub>JB</sub>	Junction-to-board characterization parameter	-		
R <sub>θJC(bot)</sub>	Junction-to-case (bottom) thermal resistance	-		

(1) For more information about traditional and new thermal metrics, see the *IC Package Thermal Metrics* application report, [SPRA953](#).

## 7.5 Electrical Characteristics

V<sub>IN</sub> = 3.6V, T<sub>A</sub> = -40°C to 85°C, typical values are at T<sub>A</sub> = 25°C (unless otherwise noted)

PARAMETER		TEST CONDITIONS	MIN	TYP	MAX	UNIT
<b>SUPPLY</b>						
V <sub>IN</sub>	Input voltage range		2.2		5.5	V
I <sub>Q</sub>	Operating quiescent current	EN = V <sub>IN</sub> , CTRL = GND, I <sub>OUT</sub> = 0μA, V <sub>OUT</sub> = 1.8V / 2.6V, device not switching		360	2300	nA
		EN = V <sub>IN</sub> , I <sub>OUT</sub> = 0mA, CTRL = GND, V <sub>OUT</sub> = 1.8V device switching		460		
		EN = V <sub>IN</sub> , I <sub>OUT</sub> = 0mA, CTRL = GND, V <sub>OUT</sub> = 2.6V, device switching		500		
		EN = V <sub>IN</sub> , I <sub>OUT</sub> = 0mA., CTRL = V <sub>IN</sub> , V <sub>OUT</sub> = 1.8V, device not switching		12.5		μA
		EN = V <sub>IN</sub> , I <sub>OUT</sub> = 0mA., CTRL = V <sub>IN</sub> , V <sub>OUT</sub> = 2.6V, device not switching		13.5		
I <sub>SD</sub>	Shutdown current	EN = GND, shutdown current into V <sub>IN</sub>		70		nA
		EN = GND, shutdown current into V <sub>IN</sub> , T <sub>A</sub> = 60°C		150		
V <sub>TH_UVLO+</sub>	Undervoltage lockout threshold	Rising V <sub>IN</sub>		2.075	2.15	V
V <sub>TH_UVLO-</sub>		Falling V <sub>IN</sub>		1.925	2	
<b>INPUTS EN, CTRL, VSEL 1-3</b>						
V <sub>IH TH</sub>	High level input threshold	2.2V ≤ V <sub>IN</sub> ≤ 5.5V			1.1	V
V <sub>IL TH</sub>	Low level input threshold	2.2V ≤ V <sub>IN</sub> ≤ 5.5V		0.4		V
I <sub>IN</sub>	Input bias Current	T <sub>A</sub> = 25°C			10	nA
		T <sub>A</sub> = -40°C to 85°C			25	
<b>POWER SWITCHES</b>						
I <sub>LIMF</sub>	High side MOSFET switch current limit	2.2V ≤ V <sub>IN</sub> ≤ 5.5V		430		mA
	Low side MOSFET switch current limit			430		mA
<b>OUTPUT DISCHARGE SWITCH (VOUT)</b>						
R <sub>DSCH_VOUT</sub>	MOSFET on-resistance	EN = GND, I <sub>OUT</sub> = -10mA into VOUT pin		30	65	Ω
I <sub>IN_VOUT</sub>	Bias current into VOUT pin	EN = V <sub>IN</sub> , V <sub>OUT</sub> = 2V / 2.8V, CTRL = GND	T <sub>A</sub> = 25°C	40	660	nA
			T <sub>A</sub> = -40°C to 85°C			
<b>LOAD OUTPUT (LOAD)</b>						
R <sub>LOAD</sub>	High side MOSFET on-resistance	I <sub>LOAD</sub> = 50mA, CTRL = V <sub>IN</sub> , V <sub>OUT</sub> = 2.0V / 2.8V, 2.2V ≤ V <sub>IN</sub> ≤ 5.5V		0.6	1.25	Ω
R <sub>DSCH_LOAD</sub>	Low side MOSFET on-resistance	CTRL = GND, 2.2V ≤ V <sub>IN</sub> ≤ 5.5V, I <sub>LOAD</sub> = -10mA		30	65	
t <sub>Rise_LOAD</sub>	V <sub>LOAD</sub> rise time	Starting with CTRL low to high transition, time to ramp V <sub>LOAD</sub> from 0V to 95%, V <sub>OUT</sub> = 1.8V / 2.6V, 2.2V ≤ V <sub>IN</sub> ≤ 5.5V, I <sub>LOAD</sub> = 1mA, T <sub>A</sub> = 25°C		315	800	μs

## Electrical Characteristics (continued)

 $V_{IN} = 3.6V$ ,  $T_A = -40^{\circ}C$  to  $85^{\circ}C$ , typical values are at  $T_A = 25^{\circ}C$  (unless otherwise noted)

PARAMETER		TEST CONDITIONS	MIN	TYP	MAX	UNIT	
<b>AUTO 100% MODE TRANSITION</b>							
$V_{TH\_100+}$	Auto 100% Mode exit detection threshold <sup>(1)</sup>	Rising $V_{IN}$ , 100% Mode is left with $V_{IN} = V_{OUT} + V_{TH\_100+}$ , max value at $T_J = 85^{\circ}C$	170	250	340	mV	
$V_{TH\_100-}$	Auto 100% Mode enter detection threshold <sup>(1)</sup>	Falling $V_{IN}$ , 100% Mode is entered with $V_{IN} = V_{OUT} + V_{TH\_100-}$ , max value at $T_J = 85^{\circ}C$	110	200	280		
<b>OUTPUT</b>							
$t_{Startup\_delay}$	Regulator start up delay time	From transition EN = low to high until device starts switching		10	25	ms	
$t_{Softstart}$	Softstart time with reduced switch current limit	$2.2V \leq V_{IN} \leq 5.5V$ , EN = $V_{IN}$		400	1200	$\mu s$	
$I_{LIM\_softstart}$	High side MOSFET switch current limit	Reduced switch current limit during softstart		80	150	200	mA
	Low side MOSFET switch current limit				150		
$V_{OUT}$	Output voltage range	Output voltages are selected with pins VSEL1, VSEL2, VSEL3		TPS82740A: 1.8 – 2.5 TPS82740B: 2.6 – 3.3		V	
	Output voltage accuracy	$I_{OUT} = 10mA$ , $V_{OUT} = 1.8V / 2.6V$	-2.5	0	2.5	%	
		$I_{OUT} = 100mA$ , $V_{OUT} = 1.8V / 2.6V$	-2	0	2		
	DC output voltage load regulation	$V_{OUT} = 1.8V / 2.6V$ , CTRL = $V_{IN}$		0.001		%/mA	
	DC output voltage line regulation	$V_{OUT} = 1.8V / 2.6V$ , CTRL = $V_{IN}$ , $I_{OUT} = 10 mA$ , $2.5V \leq V_{IN} \leq 5.5V$		0		%/V	

(1)  $V_{IN}$  is compared to the programmed output voltage ( $V_{OUT}$ ). When  $V_{IN} - V_{OUT}$  falls below  $V_{TH\_100-}$ , the device enters 100% Mode by turning the high side MOSFET on. 100% Mode is exited when  $V_{IN} - V_{OUT}$  exceeds  $V_{TH\_100+}$  and the device starts switching. The hysteresis for the 100% Mode detection threshold  $V_{TH\_100+} - V_{TH\_100-}$  is always positive and 50 mV(typ.)

## 7.6 Typical Characteristics

TABLE OF GRAPHS			FIGURE
$\eta$	Efficiency	vs Output Current	Figure 4, Figure 5, Figure 6, Figure 7
$\eta$	Efficiency	vs Input Voltage	Figure 8, Figure 9, Figure 10, Figure 11
$V_{OUT}$	Output voltage	vs Output current	Figure 12, Figure 13, Figure 14, Figure 15
$I_Q$	Operating quiescent current	vs Input voltage	Figure 2
$I_{SD}$	Shutdown current	vs Input voltage	Figure 3
	Automatic Transition into 100% Mode		Figure 19, Figure 20, Figure 21
$F_{SW}$	Switching frequency	vs Output current	Figure 16, Figure 17, Figure 18
	Line and Load Transient Performance		Figure 22, Figure 23, Figure 24, Figure 25, Figure 26, Figure 27, Figure 28, Figure 29, Figure 30, Figure 31
	AC load regulation performance		Figure 32, Figure 33
LOAD	LOAD Output Behavior		Figure 34, Figure 35, Figure 36
	Input Voltage Ramp up / down		Figure 37, Figure 38, Figure 39, Figure 40

Typical Characteristics (continued)

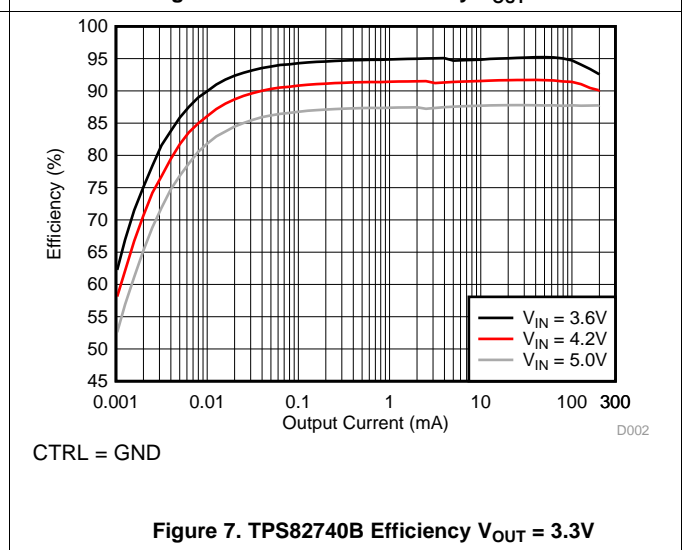
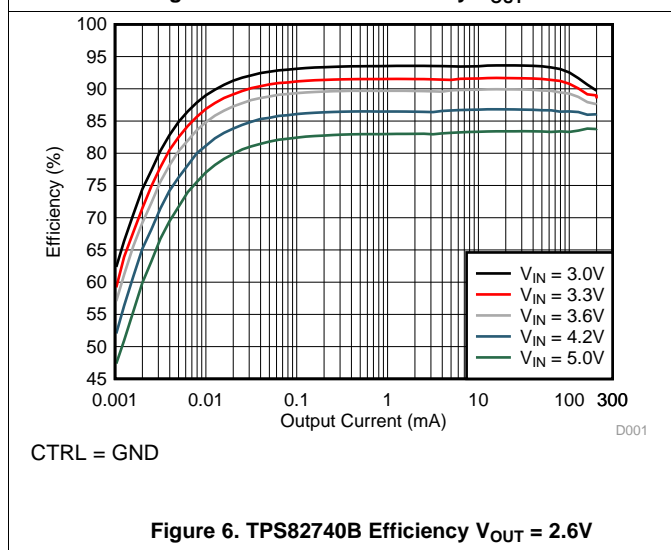
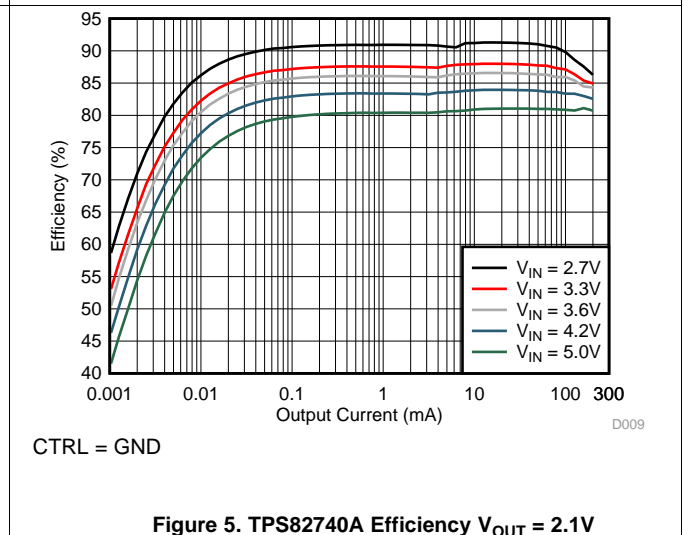
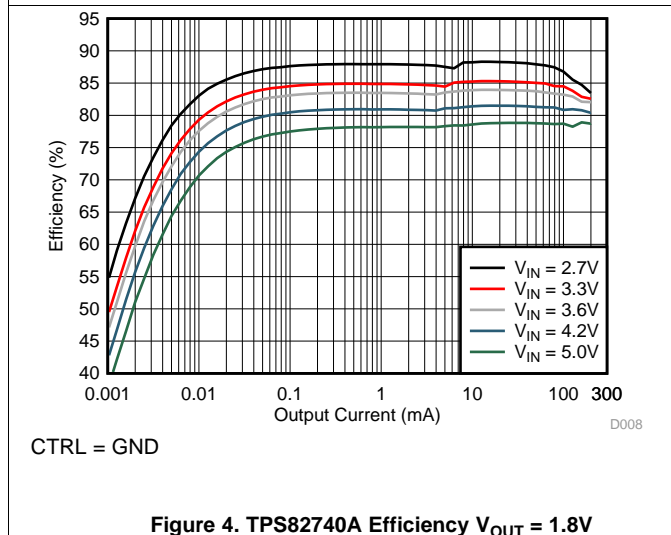
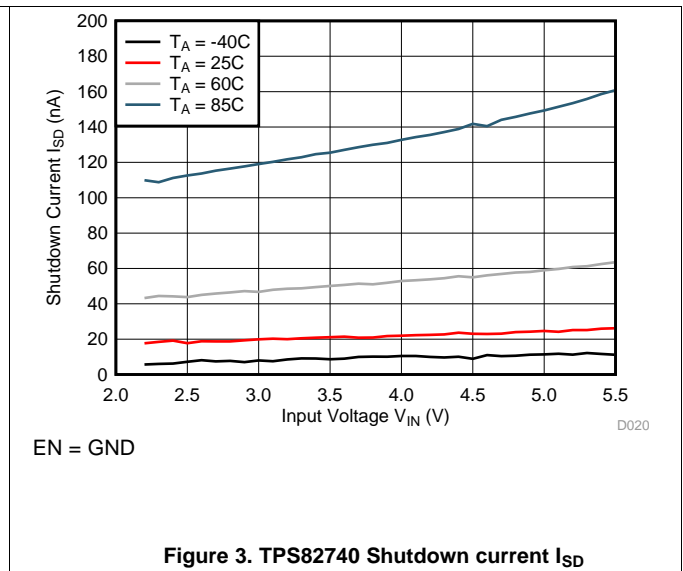
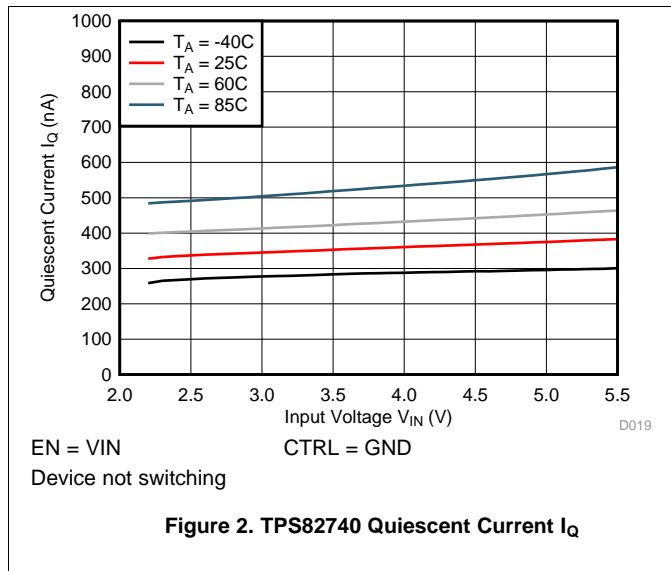

Typical Characteristics (continued)

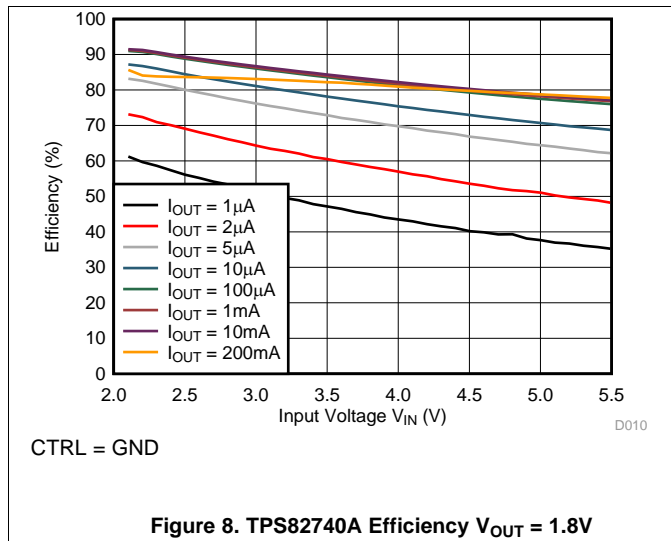

Figure 8. TPS82740A Efficiency  $V_{OUT} = 1.8V$

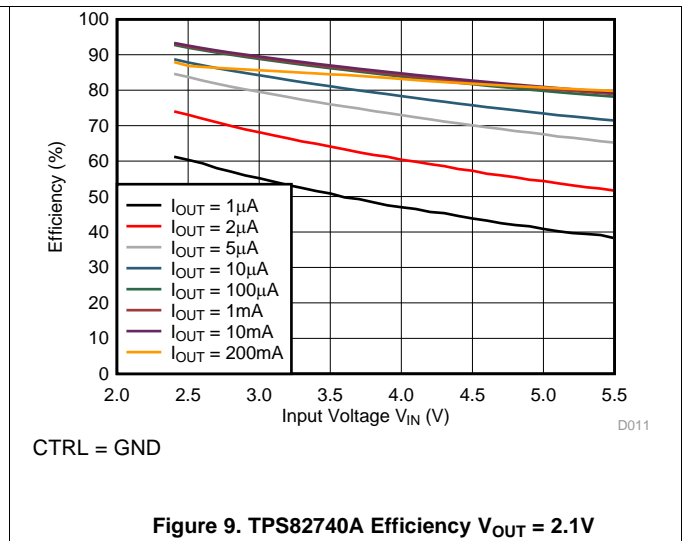

Figure 9. TPS82740A Efficiency  $V_{OUT} = 2.1V$

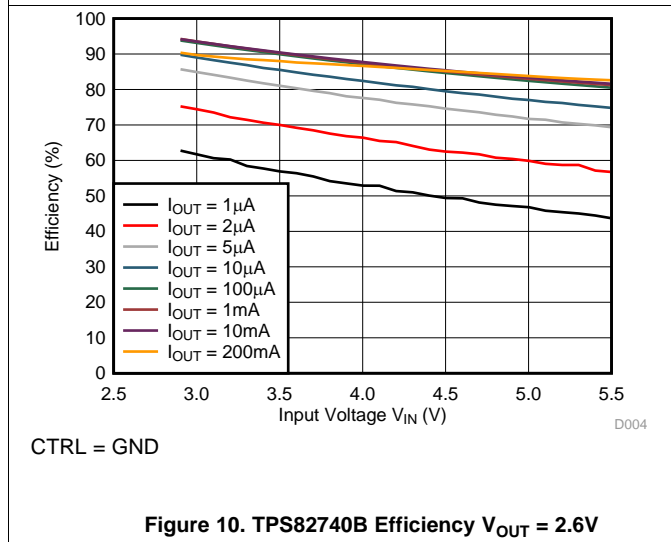

Figure 10. TPS82740B Efficiency  $V_{OUT} = 2.6V$

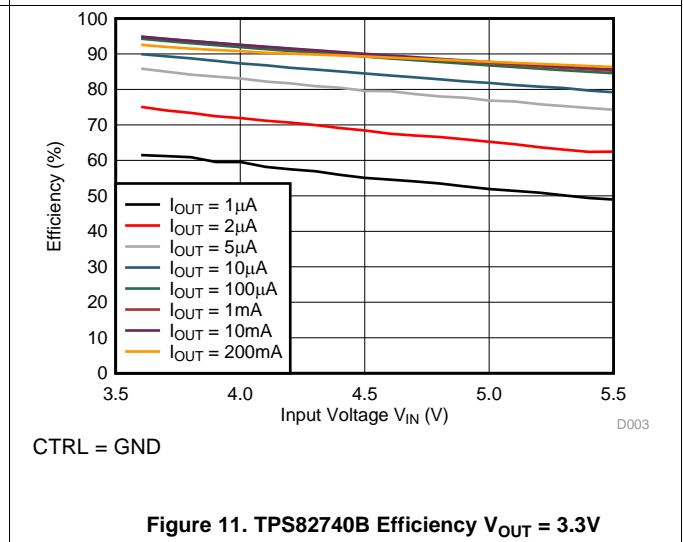

Figure 11. TPS82740B Efficiency  $V_{OUT} = 3.3V$

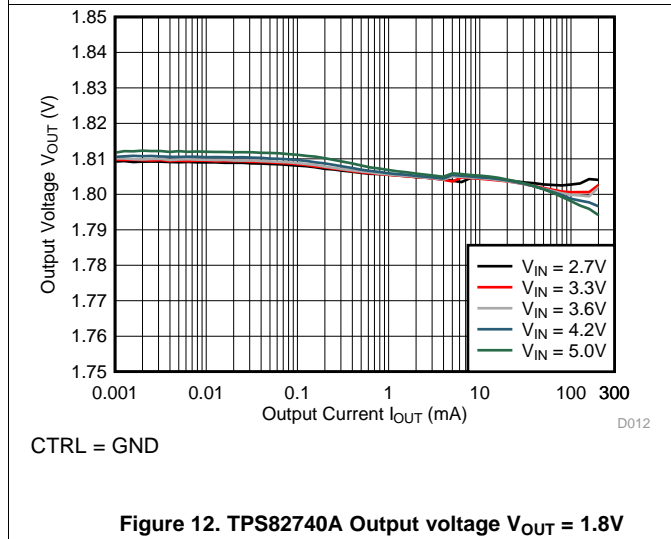

Figure 12. TPS82740A Output voltage  $V_{OUT} = 1.8V$

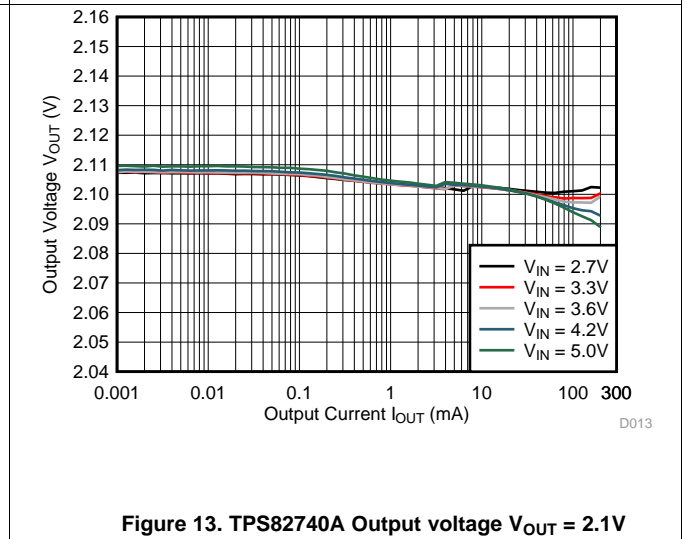

Figure 13. TPS82740A Output voltage  $V_{OUT} = 2.1V$



Typical Characteristics (continued)

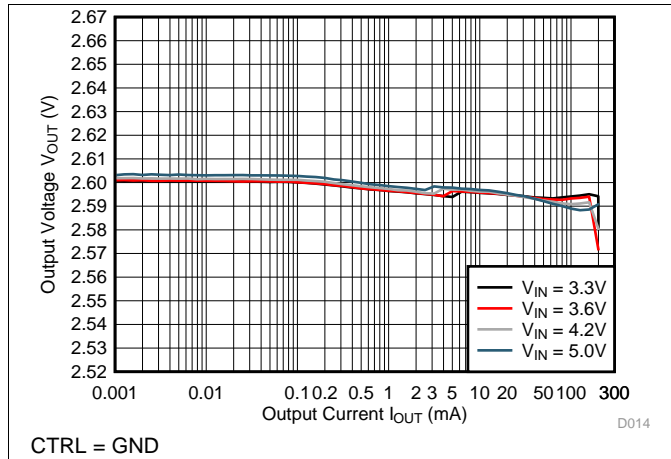

Figure 14. TPS82740B Output voltage  $V_{OUT} = 2.6V$

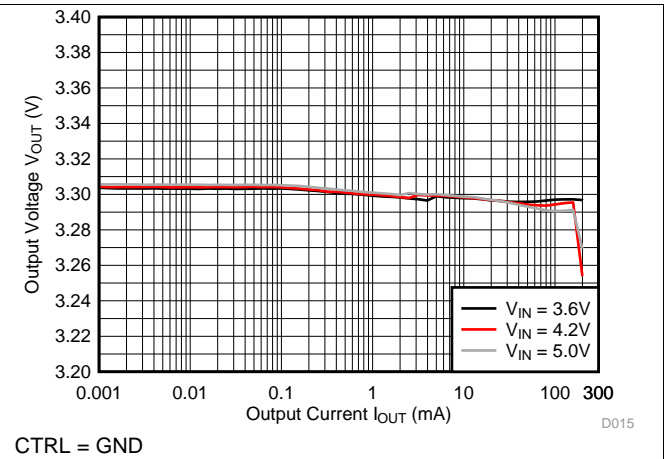

Figure 15. TPS82740B Output voltage  $V_{OUT} = 3.3V$

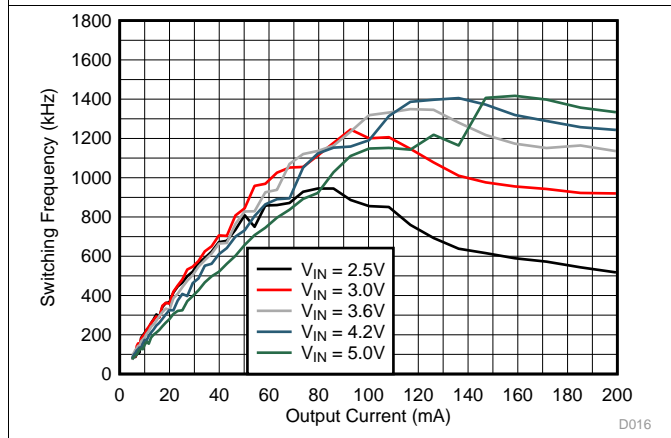

Figure 16. TPS82740A Switching frequency  $V_{OUT} = 1.8V$

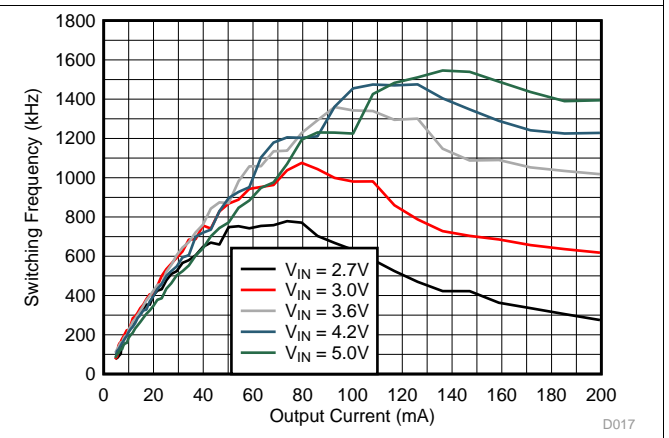

Figure 17. TPS82740A Switching frequency  $V_{OUT} = 2.1V$

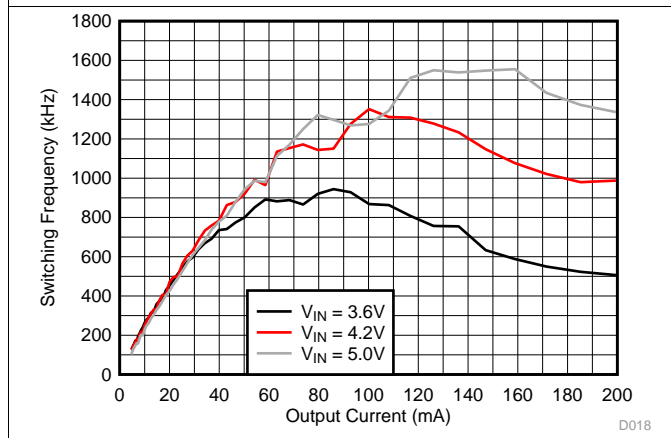

Figure 18. TPS82740B switching frequency  $V_{OUT} = 3.0V$

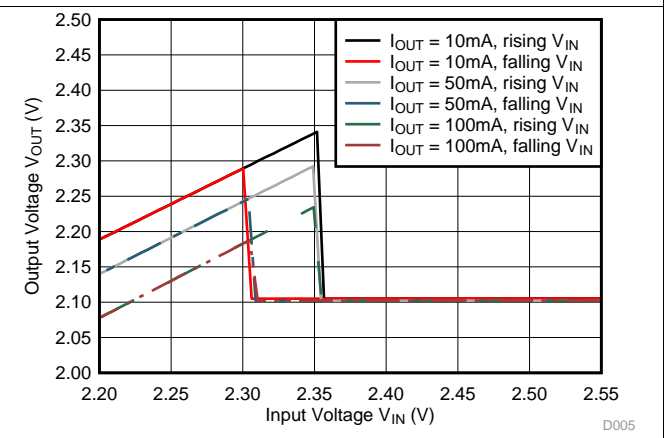
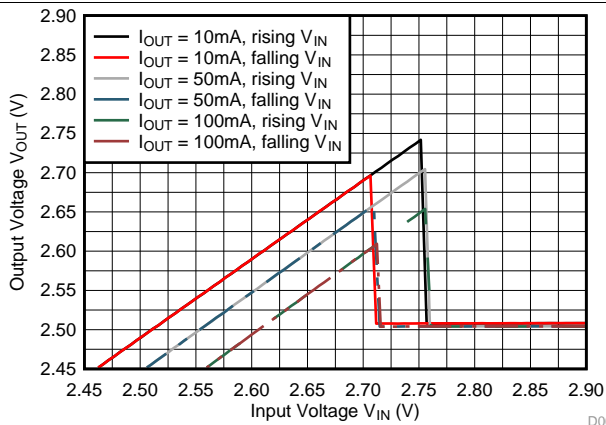

Figure 19. TPS82740A 100% Mode Transition  $V_{OUT} = 2.1V$

Typical Characteristics (continued)



D006

Figure 20. TPS82740A 100% Mode Transition  $V_{OUT} = 2.5V$

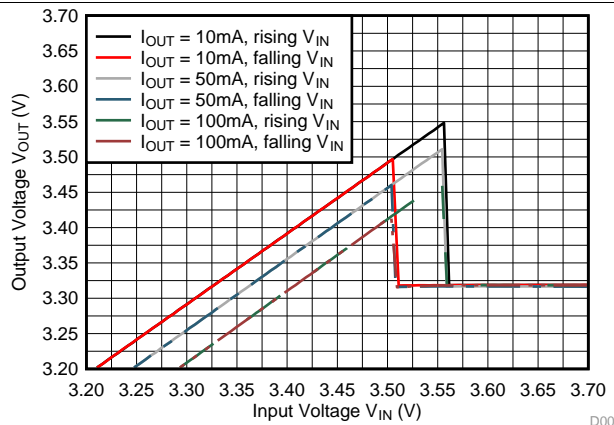

D007

Figure 21. TPS82740B 100% Mode Transition  $V_{OUT} = 3.3V$

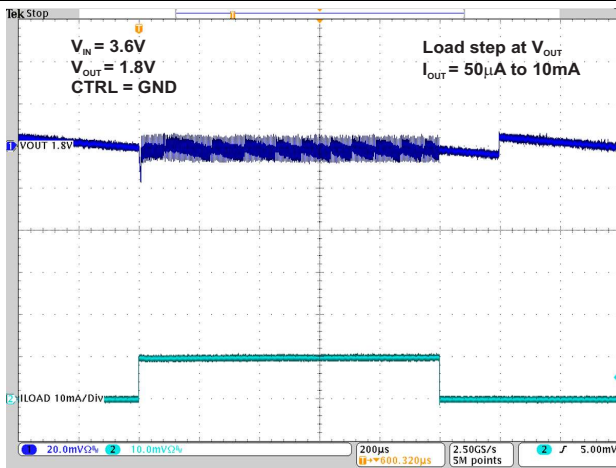

Figure 22. TPS82740A Load Transient Response  $V_{OUT} = 1.8V$

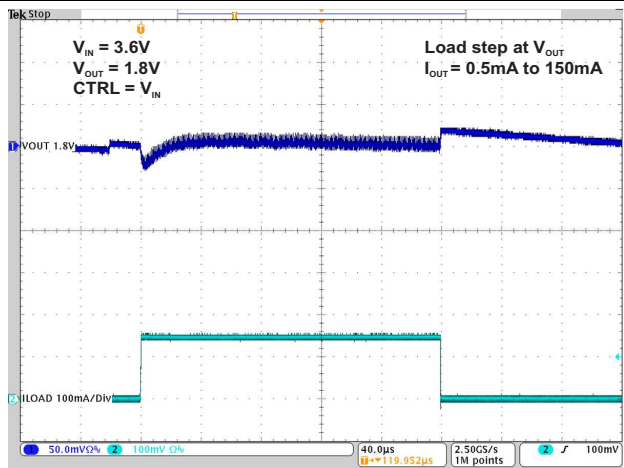

Figure 23. TPS82740A Load Transient Response  $V_{OUT} = 1.8V$

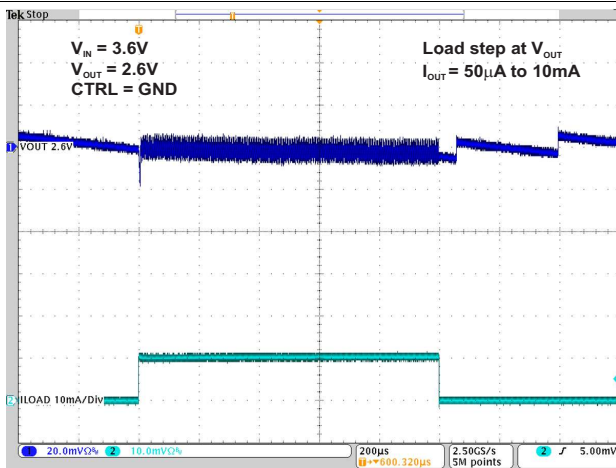

Figure 24. TPS82740B Load Transient Response  $V_{OUT} = 2.6V$

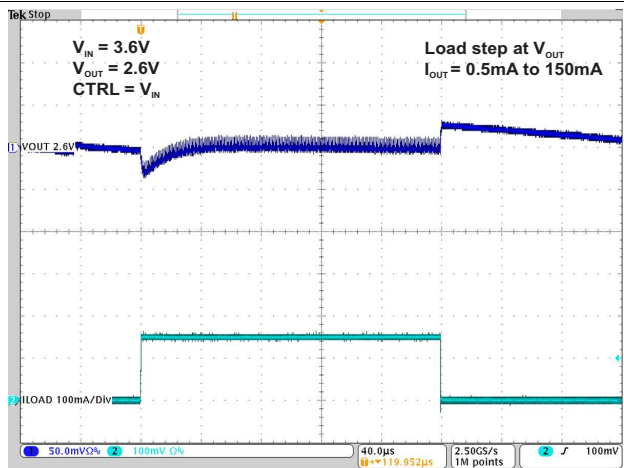

Figure 25. TPS82740B Load Transient Response  $V_{OUT} = 2.6V$

Typical Characteristics (continued)

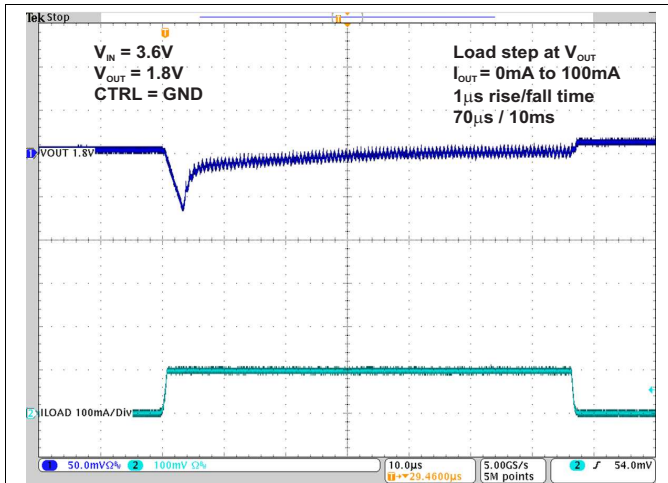

Figure 26. TPS82740A Load Transient Response  $V_{OUT} = 1.8V$

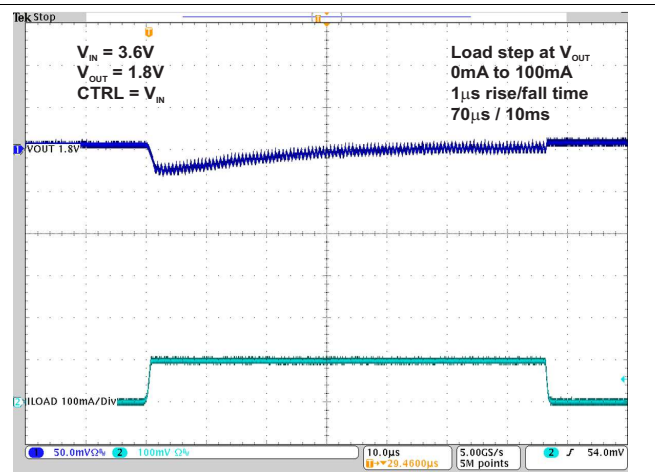

Figure 27. TPS82740A Load Transient Response  $V_{OUT} = 1.8V$

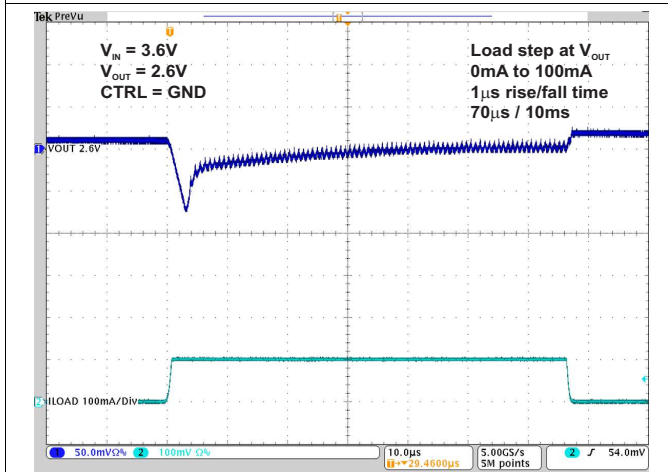

Figure 28. TPS82740B Load Transient Response  $V_{OUT} = 2.6V$

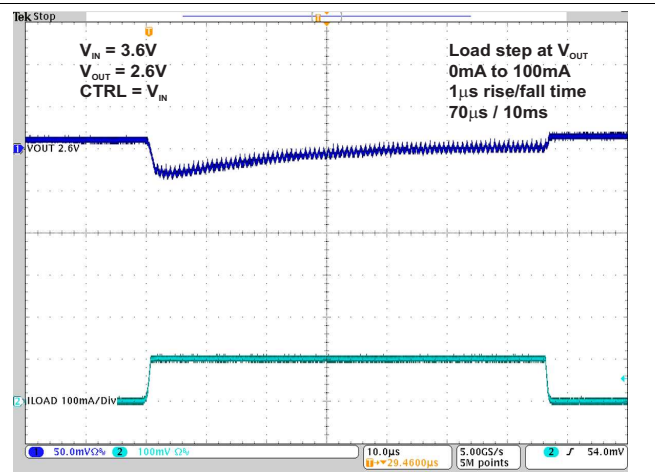

Figure 29. TPS82740B Load Transient response  $V_{OUT} = 2.6V$

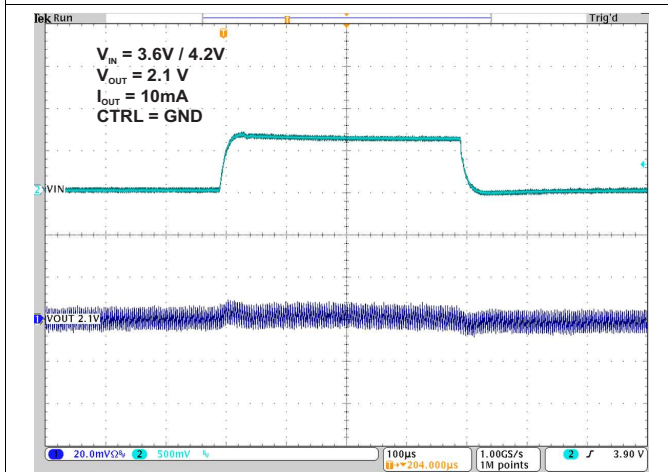

Figure 30. TPS82740A Line Transient Response  
 $I_{OUT} = 10mA$

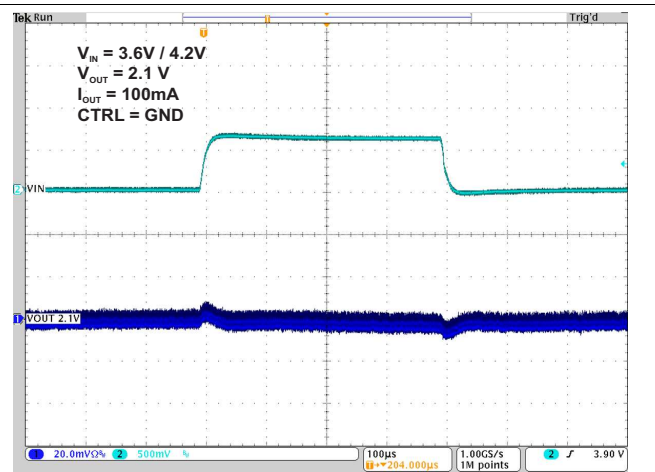

Figure 31. TPS82740A Line Transient Response  
 $I_{OUT} = 100mA$

Typical Characteristics (continued)

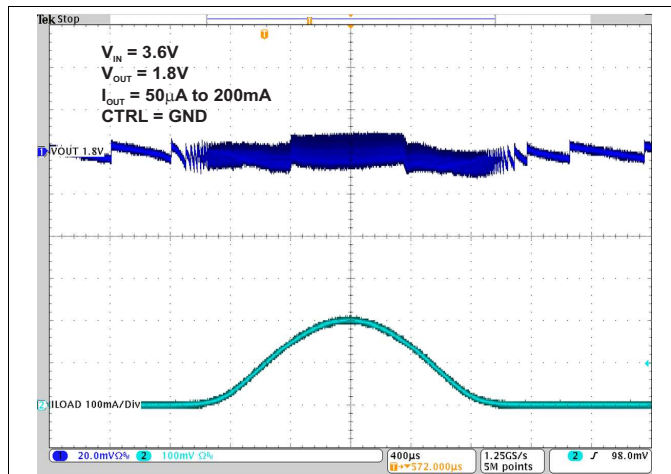

Figure 32. TPS82740A AC Load Sweep  $V_{OUT} = 1.8V$

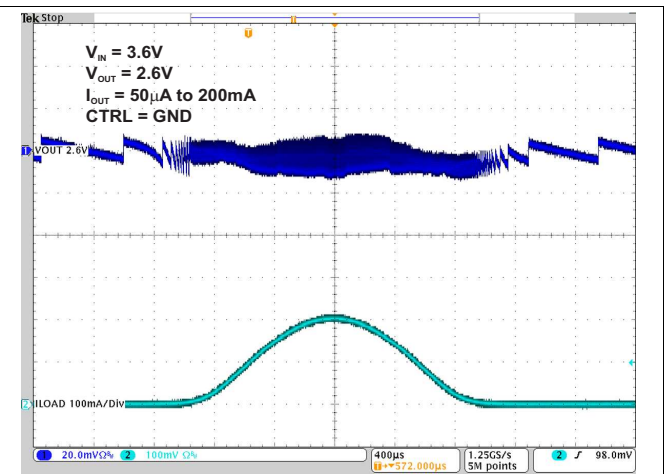

Figure 33. TPS82740B AC Load Sweep  $V_{OUT} = 2.6V$

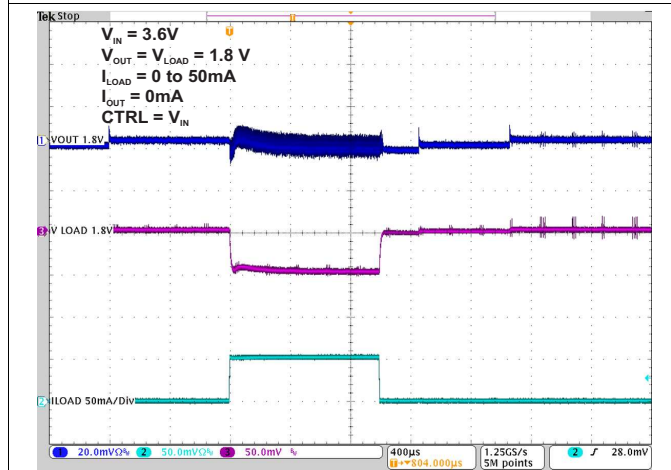

Figure 34. TPS82740A Load Step at LOAD Output

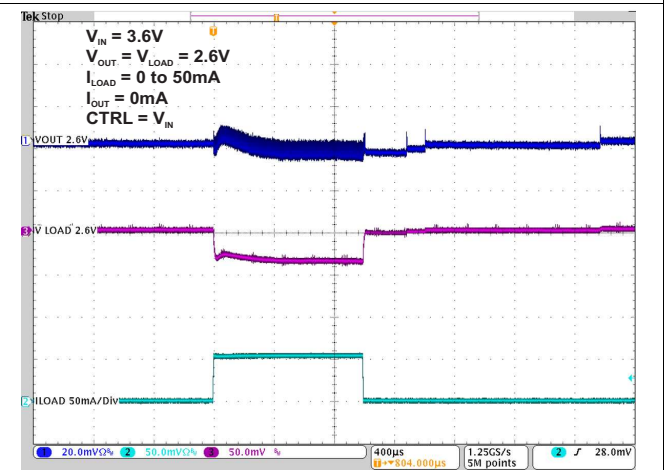

Figure 35. TPS82740B Load Step at LOAD Output

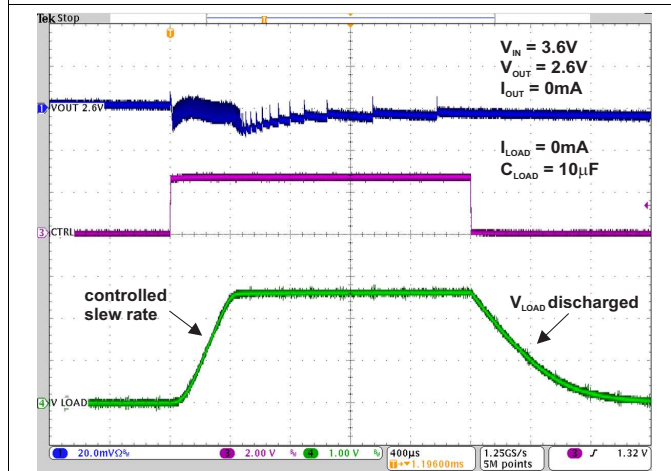

Figure 36. TPS82740B Load Output ON / OFF

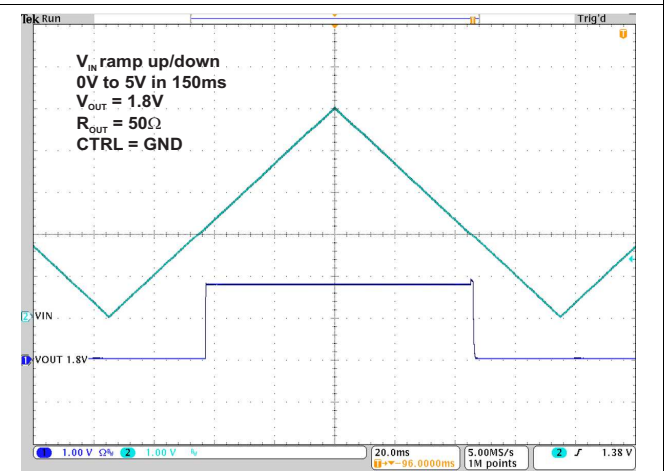

Figure 37. TPS82740A Input Voltage Ramp Up / Down

Typical Characteristics (continued)

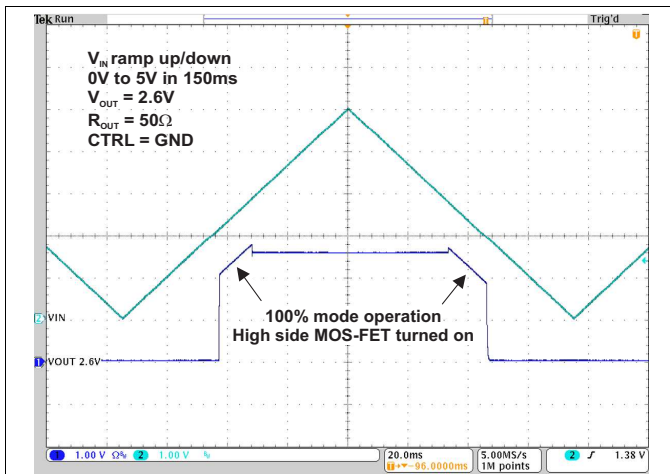

Figure 38. TPS82740B Input Voltage Ramp Up / Down

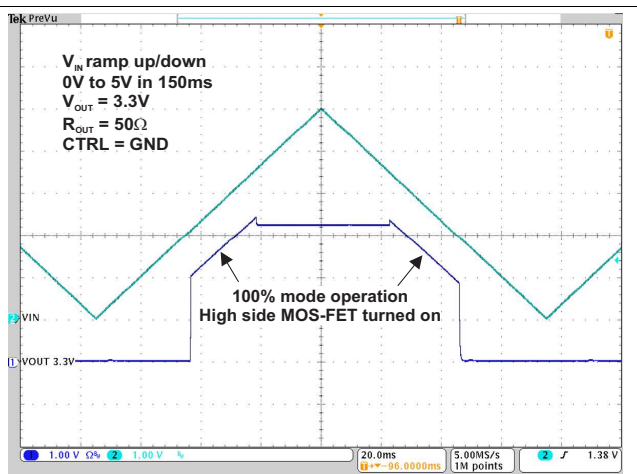

Figure 39. TPS82740B Input Voltage Ramp Up / Down

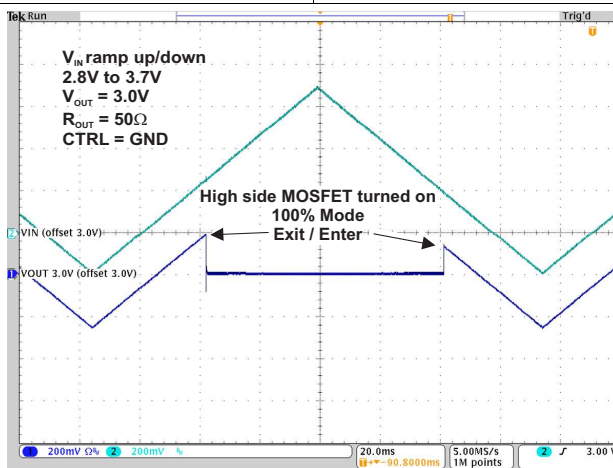
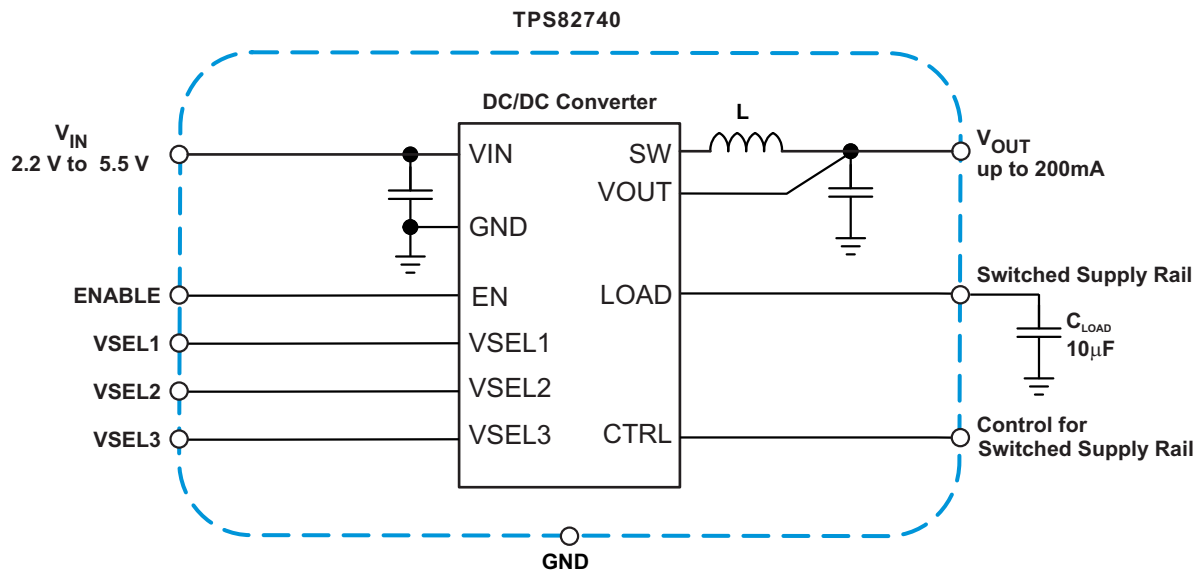

Figure 40. TPS82740B Enter / Exit 100% Mode Operation

## 8 Parameter Measurement Information



## 9 Detailed Description

### 9.1 Overview

The TPS82740 is the first fully integrated step down converter module with an ultra low quiescent current consumption (360nA typ.) while maintaining a regulated output voltage and featuring TI's DCS-Control™ topology. The device extends high efficiency operation to output currents down to a few micro amperes.

### 9.2 Functional Block Diagram

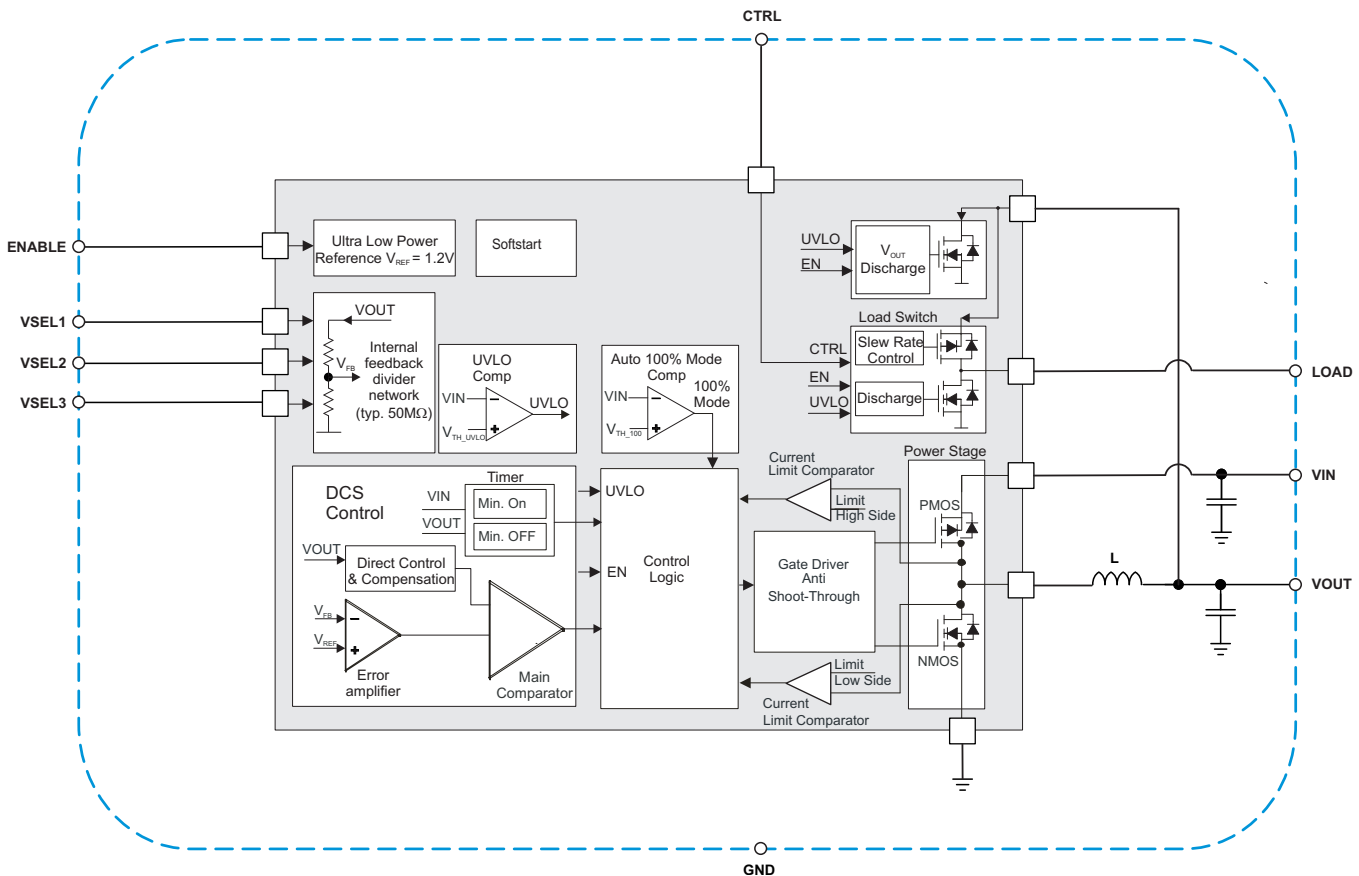

### 9.3 Feature Description

#### 9.3.1 DCS-Control™

TI's DCS-Control™ (Direct Control with Seamless Transition into Power Save Mode) is an advanced regulation topology, which combines the advantages of hysteretic and voltage mode control. Characteristics of DCS-Control™ are excellent AC load regulation and transient response, low output ripple voltage and a seamless transition between PFM and PWM mode operation. DCS-Control™ includes an AC loop which senses the output voltage (VOUT pin) and directly feeds the information to a fast comparator stage. This comparator sets the switching frequency, which is constant for steady state operating conditions, and provides immediate response to dynamic load changes. In order to achieve accurate DC load regulation, a voltage feedback loop is used.

The DCS-Control™ topology supports PWM (Pulse Width Modulation) mode for medium and high load conditions and Power Save Mode at light loads. During PWM mode, it operates in continuous conduction. The switching frequency goes up to 1.7MHz with a controlled frequency variation depending on the input voltage. If the load current decreases, the converter seamlessly enters Power Save Mode to maintain high efficiency down to very light loads. In Power Save Mode, the switching frequency varies nearly linearly with the load current. Since DCS-Control™ supports both operation modes within one single building block, the transition from PWM to Power Save Mode is seamless without effects on the output voltage. The TPS82740 offers both excellent DC

## Feature Description (continued)

voltage and superior load transient regulation, combined with very low output voltage ripple, minimizing interference with RF circuits. At high load currents, the converter operates in quasi fixed frequency PWM mode operation and at light loads in PFM (Pulse Frequency Modulation) mode to maintain highest efficiency over the full load current range. In PFM Mode, the device generates a single switching pulse to ramp up the inductor current and recharge the output capacitor, followed by a sleep period where most of the internal circuits are shutdown to achieve the lowest quiescent current. During this time, the load current is supported by the output capacitor. The duration of the sleep period depends on the load current and the inductor peak current.

During the sleep periods, the quiescent current of the TPS82740 is reduced to 360nA. This low quiescent current consumption is achieved by an ultra low power voltage reference, an integrated high impedance (typ. 50MΩ) feedback divider network and an optimized DCS-Control™ block.

### 9.3.2 LOAD Switch

The LOAD pin can be used to power an additional, temporarily used sub-system. If the CTRL pin is set high, the LOAD pin is connected to the VOUT pin via an integrated load switch. The load switch is slew rate controlled to support soft switching and not impacting the regulated output VOUT. If the CTRL pin is set to low, the LOAD pin is disconnected from the VOUT pin and internally connected to GND by an internal discharge switch. The CTRL pin can be controlled by a micro controller and must be terminated. With CTRL pin high, the quiescent current is increased to improve the transient response.

### 9.3.3 Output Voltage Selection (VSEL1, VSEL2, VSEL3)

The TPS82740 provides an integrated, high impedance (typ. 50MΩ) feedback resistor divider network which is programmed by the pins VSEL1-3. The TPS82740A supports an output voltage range of 1.8V to 2.5V in 100mV steps, while the TPS82740B supports an output voltage range from 2.6V to 3.3V in 100mV steps. The output voltage can be changed during operation and supports a simple dynamic output voltage scaling, shown in [Figure 46](#). The output voltage is programmed according to [Table 1](#) and [Table 2](#).

### 9.3.4 Output Discharge Function (VOUT and LOAD)

Both the VOUT pin and the LOAD pin feature a discharge circuit to connect each rail to GND, once they are disabled. This feature prevents residual charge voltages on capacitors connected to these pins, which may impact proper power up of the main- and sub-system. With the CTRL pin pulled low, the discharge circuit at the LOAD pin activates. With the EN pin pulled low, the discharge circuit at the pin VOUT activates.

### 9.3.5 Internal Current Limit

The TPS82740 integrates a current limit in the high side, as well as in the low side MOSFETs to protect the device against overload or short circuit conditions. The peak current in the switches is monitored cycle by cycle. If the high side MOSFET current limit is reached, the high side MOSFET is turned off and the low side MOSFET is turned on until the current decreases below the low side MOSFET current limit.

**Table 3. Load Pin Condition Table**

Pin condition			Operating condition	Remark
LOAD	EN	CTRL	VIN	
Connected to VOUT	high	high	$> V_{UVLO}$	load switch enabled and slew rate controlled
Connected to GND	high	low	$> V_{UVLO}$	load switch turned off
	low	high or low	$> V_{UVLO}$	device and load switch disabled
	high	high	$< V_{UVLO}$	device disabled due to UVLO



### 9.3.6 CTRL / DVS (Dynamic Voltage Scaling TPS62741)

In TPS62741, the CTRL pin controls beside the load switch as well Dynamic Voltage Scaling. The CTRL pin selects between two different voltage setting banks. The voltage of each bank are set with the VSEL pins 1-4 according to .

The output LOAD is controlled with the CTRL pin. The pin is internally connected either to VOUT pin or GND and can be used to power up/down temporarily used external circuits to reduce leakage current consumption of the system.

## 9.4 Device Functional Modes

### 9.4.1 Enable / Shutdown

The TPS82740 is activated when the EN pin is set high. For proper operation, the pin must be terminated and must not be left floating. With the EN pin set low, the device enters shutdown mode with less than typ. 70nA current consumption.

### 9.4.2 Soft Start

When the device is enabled, the internal reference is powered up and after the startup delay time  $t_{Startup\_delay}$  has expired, the device enters softstart, starts switching and ramps up the output voltage. During softstart, the device operates with a reduced current limit,  $I_{LIM\_softstart}$ , of typ. 1/3 of the nominal current limit. This reduced current limit is active during the time  $t_{Softstart}$ . The current limit is increased to its nominal value,  $I_{LIMF}$ , once this time has expired or the nominal output voltage is reached.

### 9.4.3 POWER GOOD OUTPUT (PG)

The Power Good comparator features an open drain output. The PG comparator is active with EN pin set to high and  $V_{IN}$  is above the threshold  $V_{TH\_UVLO+}$ . It is driven to high impedance once  $V_{OUT}$  trips the threshold  $V_{TH\_PG+}$  for rising  $V_{OUT}$ . The output is pulled to low level once  $V_{OUT}$  falls below the PG hysteresis,  $V_{PG\_hys}$ . The output is also pulled to low level in case the input voltage  $V_{IN}$  falls below the undervoltage lockout threshold  $V_{TH\_UVLO-}$  or the device is disabled with EN = low. The power good output (PG) can be used as an indicator for the system to signal that the converter has started up and the output voltage is in regulation.

**Table 4. PG condition table**

Pin condition			Operating condition			Remark
PG	EN	CTRL	IOUT / ILOAD	VIN	VOUT	
hiz	high	high	don't care	$> V_{UVLO}$	$V_{OUT} > V_{TH\_PG+}$	PG comparator active, pull up resistor pulls PG to high
hiz	high	low	medium load ( $> 1mA$ )	$> V_{UVLO}$	$V_{OUT} > V_{TH\_PG+}$	PG comparator active, pull up resistor pulls PG to high
hiz	high	low	light load ( $< 1mA$ )	$> V_{UVLO}$	$V_{OUT} > V_{TH\_PG+}$	PG comparator disabled for low Iq operation, pull up resistor pulls PG to high
low	high	don't care	$0mA < I_{OUT} < 100mA$	$> V_{UVLO}$	$V_{OUT} < V_{TH\_PG-}$	startup, overload or ramp down
low	low	don't care	output disabled	$V_{IN} > 1.2V$	$V_{OUT} = 0$	device disabled
low	high	don't care	output disabled	$< V_{UVLO}$	$V_{OUT}$ not present	device disabled, due to UVLO

**Table 5. VOUT Output Discharge Condition Table**

VOUT pin	EN	VIN condition	remark
connected to GND, output discharged	low	$1.5V < V_{IN} < V_{UVLO}$	
connected to GND, output discharged	high	$< V_{UVLO}$	

**Table 5. VOUT Output Discharge Condition Table (continued)**

VOUT pin	EN	VIN condition	remark
hiz, discharge switch disabled	high	$> V_{UVLO}$	during regulator start up, the discharge switch is enabled and VOUT pulled to low, until the regulator start up time $t_{Start}$ expires. During the softstart time and later, the discharge switch is disabled.

### 9.4.4 Automatic Transition into 100% Mode

Once the input voltage comes close to the output voltage, the TPS82740 stops switching and enters 100% duty cycle operation. It connects the output VOUT via the inductor and the internal high side MOSFET switch to the input VIN, once the input voltage VIN falls below the 100% mode enter threshold, VTH\_100-. In 100% mode switching stops eliminating output voltage ripple. Because the output is connected to the input, the output voltage tracks the input voltage minus the voltage drop across the internal high side switch and the inductor caused by the output current. Once the input voltage increases and trips the 100% mode exit threshold, VTH\_100+, the TPS82740 turns on and starts switching again. See [Figure 41](#), [Figure 19](#), [Figure 20](#) and [Figure 21](#).

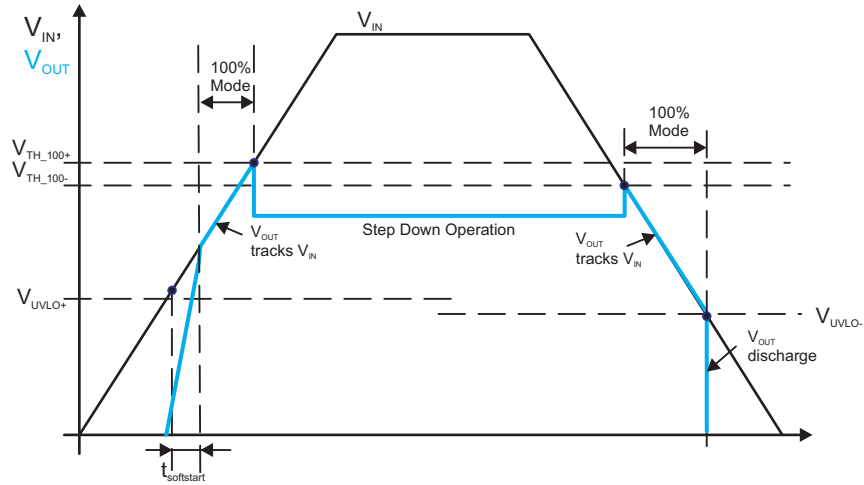

**Figure 41. Automatic Transition into 100% Mode**

## 10 Application and Implementation

### 10.1 Application Information

The device is designed to operate from an input voltage supply range between 2.2V and 5.5V with a maximum output current of 200mA. Once the input voltage comes close to the output voltage, the DC/DC converter stops switching and enters 100% duty cycle operation. The integrated slew rate controlled load switch can distribute the selected output voltage to a temporarily used sub-system. The TPS82740 module operates in PWM mode for medium and high load conditions and in power save mode at light load currents.

At high load currents, the converter operates in quasi fixed frequency PWM mode operation. The switching frequency is up to 1.7MHz with a controlled frequency variation depending on the input voltage. If the load current decreases, the converter seamlessly enters Power Save Mode by varying the switching frequency linearly to maintain high efficiency over the full load current range. At very light load conditions the device generates a single switching pulse to ramp up the inductor current and recharge the output capacitor, followed by a sleep period where most of the internal circuits are shutdown to achieve 360nA quiescent current consumption.

### 10.2 Typical Application

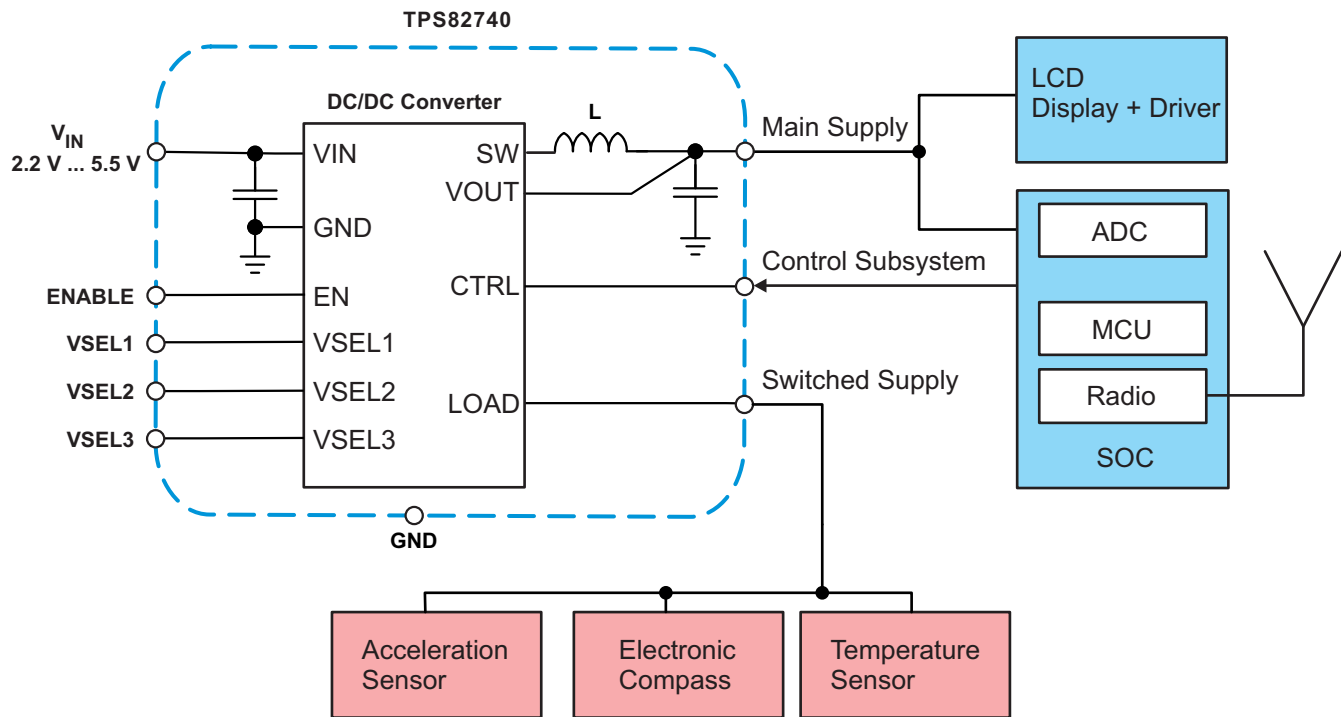

**Figure 42. Example of Implementation in a SOC Based System**

#### 10.2.1 Design Requirements

TPS82740 is a complete step-down converter module including all passive components (inductor, input and output capacitor). For most applications no additional input / output capacitors are required. Use the following typical application design procedure to select additional external components in case further performance improvement of the module is desired.

#### 10.2.2 Detailed Design Procedure

##### 10.2.2.1 Input Capacitor Selection

For most applications, the integrated input capacitor at the VIN pin is sufficient.

## Typical Application (continued)

TPS82740 uses a tiny ceramic input capacitor. When a ceramic capacitor is combined with trace or cable inductance, such as that from a wall adapter, a load step at the output can induce ringing at the VIN pin. This ringing can couple to the output and be mistaken as loop instability or can even damage the module. In this circumstance, additional ceramic "bulk" capacitance, such as electrolytic or tantalum, should be placed between the input of the module and the power source lead to reduce ringing that occurs between the inductance of the power source leads and the module.

### 10.2.2.1.1 Input Buffer Capacitor Selection

In addition to the small ceramic input capacitor a larger buffer capacitor  $C_{Buf}$  is recommended to reduce voltage drops and ripple voltage. When using battery chemistries like Li-SOCl<sub>2</sub>, Li-SO<sub>2</sub>, Li-MnO<sub>2</sub>, the impedance of the battery has to be considered. These battery types tend to increase their impedance depending on discharge status and often can support output currents of only a few mA. Therefore a buffer capacitor is recommended to stabilize the battery voltage during DC/DC operations e.g. for a RF transmission. A voltage drop on the input of the TPS82740 during DC/DC operation impacts the advantage of the step down conversion for system power reduction. Furthermore the voltage drops can fall below the minimum recommended operating voltage of the device and leads to an early system cut off. Both effects reduce the battery life time. To achieve best performance and to extract the most energy out of the battery a good procedure is to select the buffer capacitor value for an voltage drop below 50mVpp during DC/DC operation. The capacitor value strongly depends on the used battery type, as well the current consumption during a RF transmission as well the duration of the transmission.

### 10.2.2.2 Output Capacitor Selection

For most applications, the integrated output capacitor at the VOUT pin is sufficient.

In order to further reduce the output voltage ripple and improve the load transient performance an additional external output capacitance may be used. For most applications an additional 4.7 $\mu$ F or 10 $\mu$ F capacitor will be sufficient. Care should be taken that the total effective capacitance present at the output does not exceed 10 $\mu$ F in order to guarantee loop stability. Ceramic capacitors with low ESR values have the lowest output voltage ripple and are recommended.

At the LOAD output pin, no additional output capacitor is required. For applications demanding external capacitance connected to the LOAD pin, the total capacitance should not exceed 10 $\mu$ F.

Typical Application (continued)

10.2.3 Application Curves

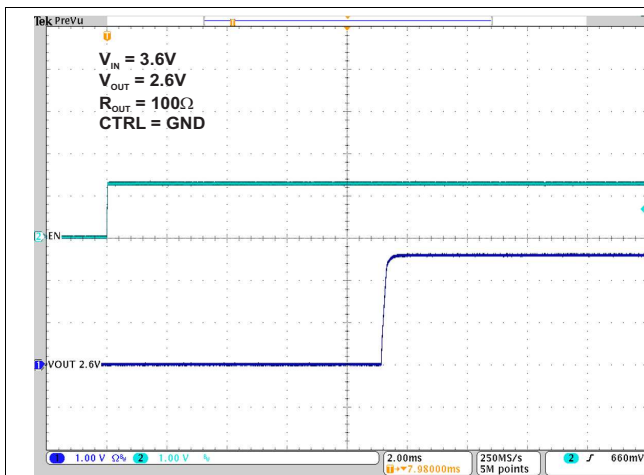

Figure 43. TPS82740B Device Enable and Start up

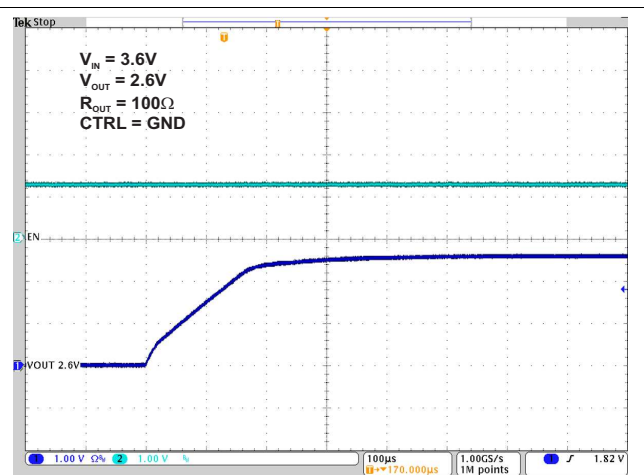

Figure 44. TPS82740B V<sub>OUT</sub> Ramp after Enable

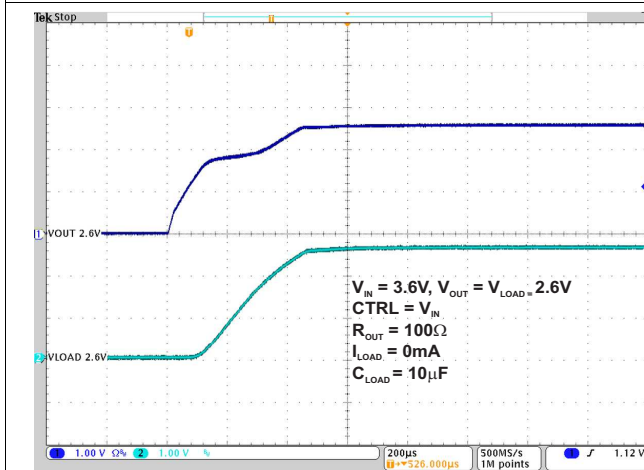

Figure 45. TPS82740B V<sub>OUT</sub> Ramp with activated LOAD Switch

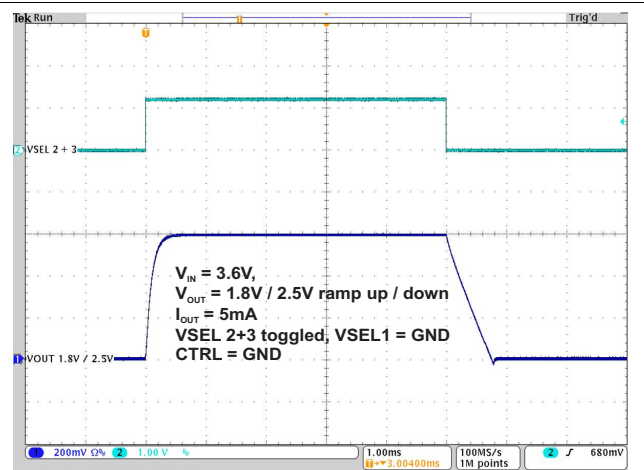

Figure 46. TPS82740A Dynamic Output Voltage Scaling: V<sub>OUT</sub> = 1.8V / 2.5V

## 11 Power Supply Recommendations

The TPS82740 device is a complete and optimized power supply module working within the given specification range without additional components. Please use the information given in the Application Information section to connect the input and output circuitry appropriately.

## 12 Layout

### 12.1 Layout Guidelines

In making the pad size for the uSiP LGA balls, it is recommended that the layout use a non-solder-mask defined (NSMD) land. With this method, the solder mask opening is made larger than the desired land area, and the opening size is defined by the copper pad width. Figure 47 shows the appropriate diameters for a MicroSiP™ layout. Figure 48 shows a suggestion for the PCB layout.

### 12.2 Layout Example

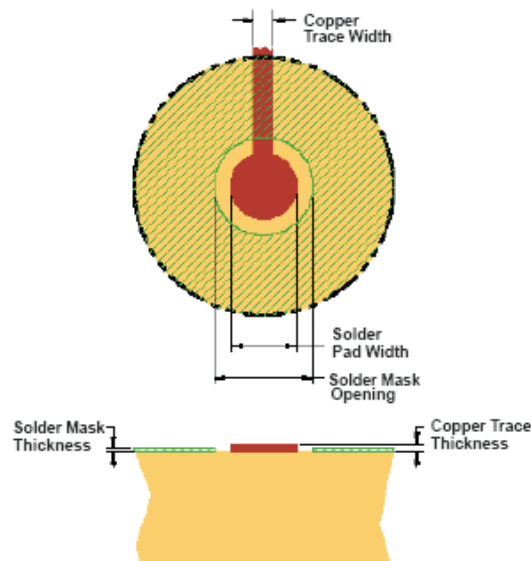

**Figure 47. Recommended Land Pattern Image and Dimensions**

SOLDER PAD DEFINITIONS <sup>(1)(2)(3)(4)</sup>	COPPER PAD	SOLDER MASK <sup>(5)</sup> OPENING	COPPER THICKNESS	STENCIL <sup>(6)</sup> OPENING	STENCIL THICKNESS
Non-solder-mask defined (NSMD)	0.30mm	0.360mm	1oz max (0.032mm)	0.34mm diameter	0.1mm thick

- (1) Circuit traces from non-solder-mask defined PWB lands should be 75µm to 100µm wide in the exposed area inside the solder mask opening. Wider trace widths reduce device stand off and affect reliability.
- (2) Best reliability results are achieved when the PWB laminate glass transition temperature is above the operating the range of the intended application.
- (3) Recommend solder paste is Type 3 or Type 4.
- (4) For a PWB using a Ni/Au surface finish, the gold thickness should be less than 0.5µm to avoid a reduction in thermal fatigue performance.
- (5) Solder mask thickness should be less than 20 µm on top of the copper circuit pattern.
- (6) For best solder stencil performance use laser cut stencils with electro polishing. Chemically etched stencils give inferior solder paste volume control.

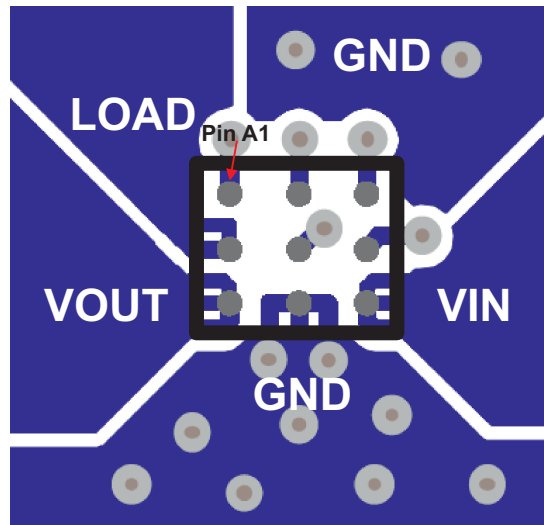

**Figure 48. PCB Layout Suggestion**

### 12.3 Surface Mount Information

The TPS82740 MicroSIP™ module uses an open frame construction for a fully automated assembly process and provides a large surface area for pick and place operations. See the "Pick Area" in the package drawing.

Package height and weight have been kept to a minimum, allowing MicroSIP™ device handling similar to a 0805 footprint component.

For reflow recommendations, see document J-STD-20 from the JEDEC/IPC standard.



## 13 Device and Documentation Support

### 13.1 Documentation Support

#### 13.1.1 Related Links

The table below lists quick access links. Categories include technical documents, support and community resources, tools and software, and quick access to sample or buy.

**Table 6. Related Links**

PARTS	PRODUCT FOLDER	SAMPLE & BUY	TECHNICAL DOCUMENTS	TOOLS & SOFTWARE	SUPPORT & COMMUNITY
TPS82740A	<a href="#">Click here</a>	<a href="#">Click here</a>	<a href="#">Click here</a>	<a href="#">Click here</a>	<a href="#">Click here</a>
TPS82740B	<a href="#">Click here</a>	<a href="#">Click here</a>	<a href="#">Click here</a>	<a href="#">Click here</a>	<a href="#">Click here</a>

### 13.2 Trademarks

DCS-Control, MicroSiP, MicroSiP are trademarks of Texas Instruments. Bluetooth is a registered trademark of Bluetooth SIG, Inc..

### 13.3 Electrostatic Discharge Caution



These devices have limited built-in ESD protection. The leads should be shorted together or the device placed in conductive foam during storage or handling to prevent electrostatic damage to the MOS gates.

### 13.4 Glossary

[SLYZ022](#) — *TI Glossary*.

This glossary lists and explains terms, acronyms, and definitions.

## 14 Mechanical, Packaging, and Orderable Information

The following pages include mechanical, packaging, and orderable information. This information is the most current data available for the designated devices. This data is subject to change without notice and revision of this document. For browser-based versions of this data sheet, refer to the left-hand navigation.

# TPS82740A, TPS82740B

SLVSCE3A – JUNE 2014 – REVISED JUNE 2014

www.ti.com

## 14.1 Tape and Reel Information

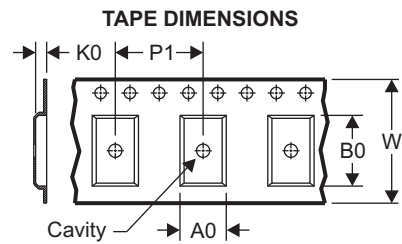
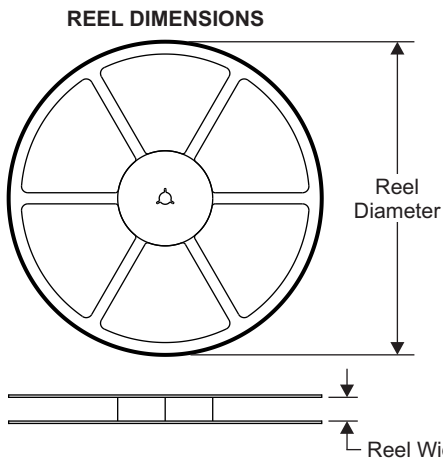

A0	Dimension designed to accommodate the component width
B0	Dimension designed to accommodate the component length
K0	Dimension designed to accommodate the component thickness
W	Overall width of the carrier tape
P1	Pitch between successive cavity centers

### QUADRANT ASSIGNMENTS FOR PIN 1 ORIENTATION IN TAPE

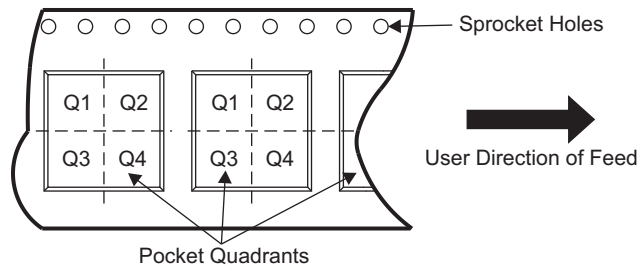

Device	Package Type	Package Drawing	Pins	SPQ	Reel Diameter (mm)	Reel Width W1 (mm)	A0 (mm)	B0 (mm)	K0 (mm)	P1 (mm)	W (mm)	Pin1 Quadrant
TPS82740ASIPR	uSIP	SIP	9	3000	178	9.0	2.5	3.1	1.35	4.0	8.0	Q2
TPS82740ASIPT	uSIP	SIP	9	250	178	9.0	2.83	3.18	1.2	4.0	8.0	Q2
TPS82740BSIPR	uSIP	SIP	9	3000	178	9.0	2.5	3.1	1.35	4.0	8.0	Q2
TPS82740BSIPT	uSIP	SIP	9	250	178	9.0	2.83	3.18	1.2	4.0	8.0	Q2

**TAPE AND REEL BOX DIMENSIONS**

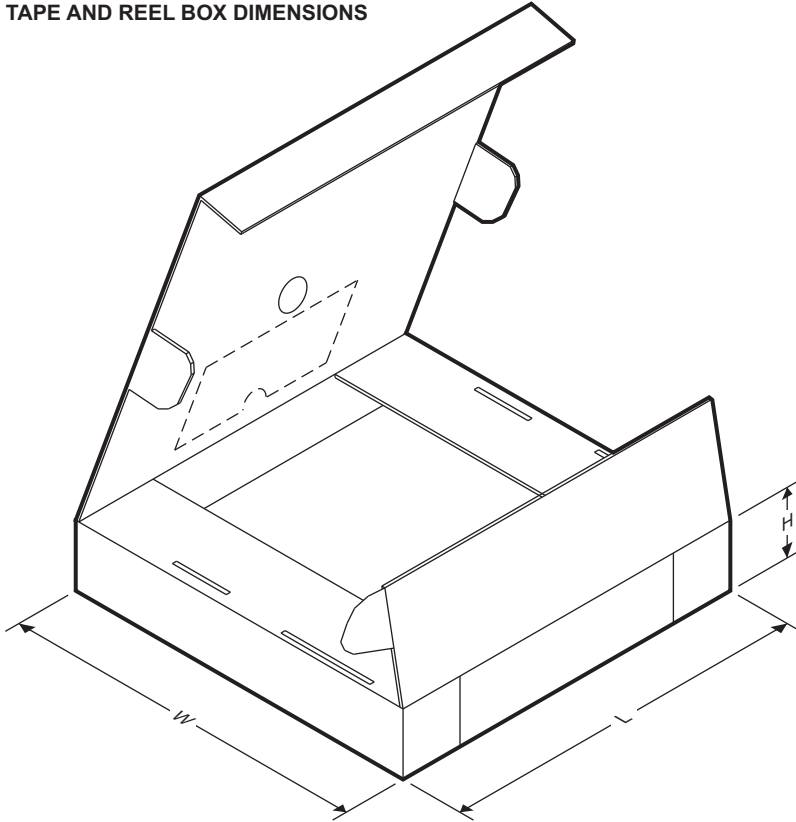

Device	Package Type	Package Drawing	Pins	SPQ	Length (mm)	Width (mm)	Height (mm)
TPS82740ASIPR	uSIP	SIP	9	3000	223	194	35
TPS82740ASIPT	uSIP	SIP	9	250	223	194	35
TPS82740BSIPR	uSIP	SIP	9	3000	223	194	35
TPS82740BSIPT	uSIP	SIP	9	250	223	194	35



# PACKAGE OUTLINE

## SIP0009F

### MicroSiP™ - 1.1 mm max height

MICRO SYSTEM IN PACKAGE

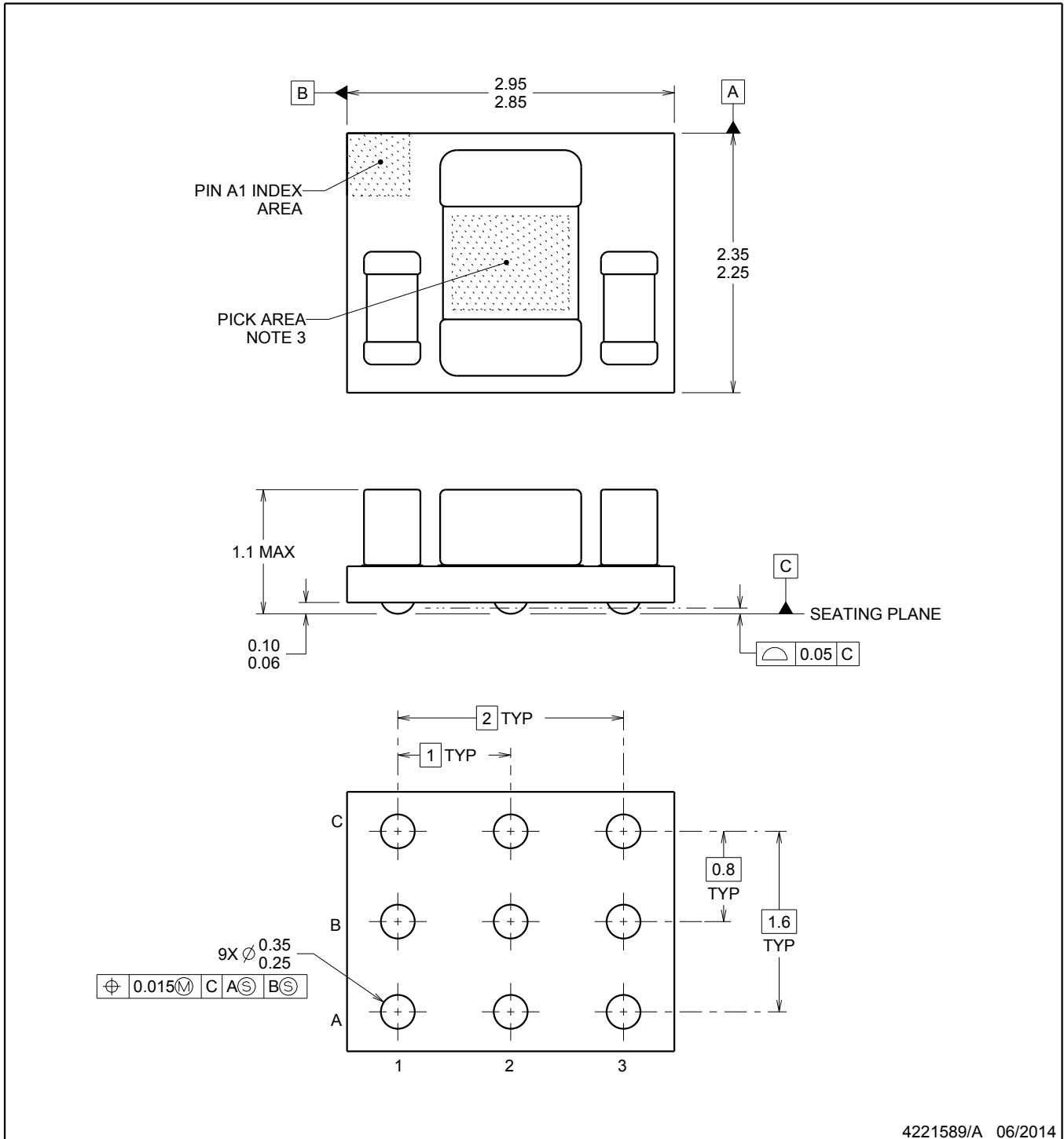

4221589/A 06/2014

MicroSiP is a trademark of Texas Instruments.

#### NOTES:

1. All linear dimensions are in millimeters. Any dimensions in parenthesis are for reference only. Dimensioning and tolerancing per ASME Y14.5M.
2. This drawing is subject to change without notice.
3. For pick and place nozzle recommendation, see product datasheet.
4. Location, size and quantity of each component are for reference only and may vary.

# EXAMPLE BOARD LAYOUT

SIP0009F

MicroSiP™ - 1.1 mm max height

MICRO SYSTEM IN PACKAGE

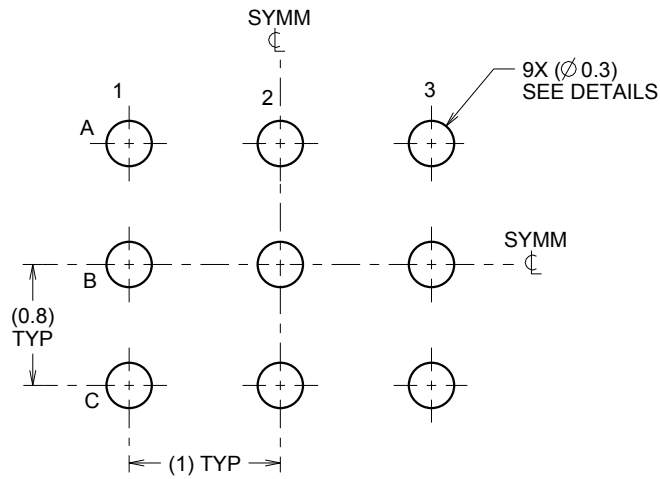

LAND PATTERN EXAMPLE  
NOT TO SCALE

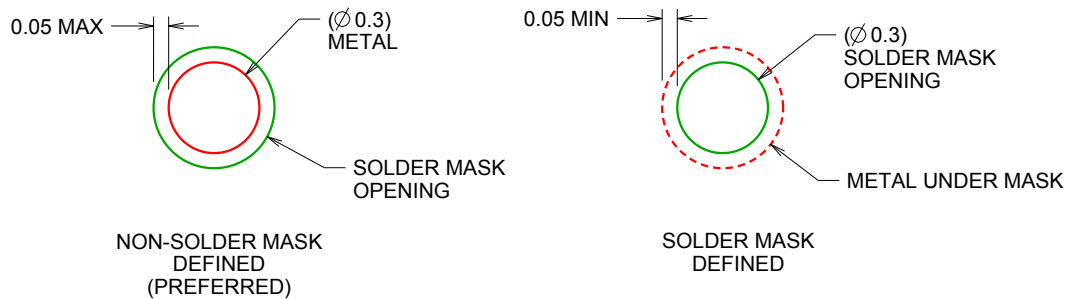

SOLDER MASK DETAILS  
NOT TO SCALE

4221589/A 06/2014

NOTES: (continued)

5. For more information, see Texas Instruments literature number SBVA017 ([www.ti.com/lit/sbva017](http://www.ti.com/lit/sbva017)).

# EXAMPLE STENCIL DESIGN

SIP0009F

MicroSiP™ - 1.1 mm max height

MICRO SYSTEM IN PACKAGE

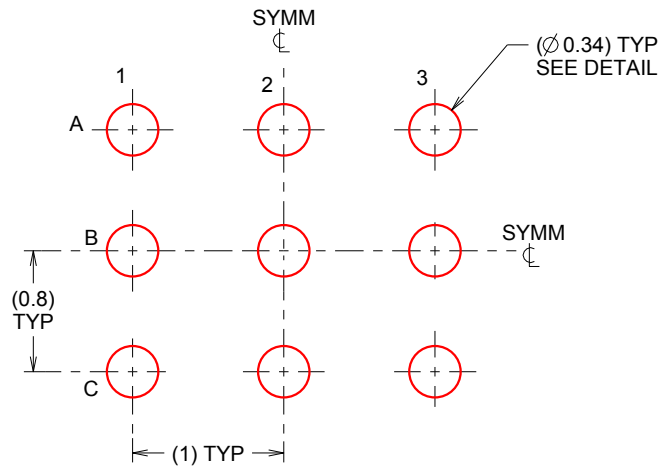

SOLDER PASTE EXAMPLE  
BASED ON 0.1 mm THICK STENCIL  
SCALE:20X

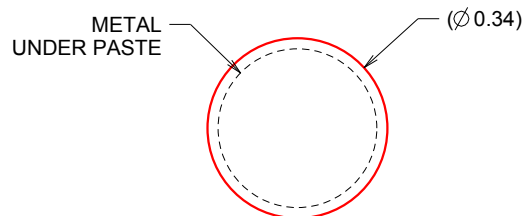

SOLDER PASTE DETAIL  
TYPICAL

4221589/A 06/2014

NOTES: (continued)

6. Laser cutting apertures with trapezoidal walls and rounded corners may offer better paste release. IPC-7525 may have alternate design recommendations.

**PACKAGING INFORMATION**

Orderable part number	Status (1)	Material type (2)	Package   Pins	Package qty   Carrier	RoHS (3)	Lead finish/ Ball material (4)	MSL rating/ Peak reflow (5)	Op temp (°C)	Part marking (6)
<a href="#">TPS82740ASIPR</a>	Active	Production	uSiP (SIP)   9	3000   LARGE T&R	Yes	NIAU	Level-2-260C-1 YEAR	-40 to 85	E7 TXI740XEC
TPS82740ASIPR.B	Active	Production	uSiP (SIP)   9	3000   LARGE T&R	-	Call TI	Call TI	-40 to 125	
<a href="#">TPS82740ASIPT</a>	Active	Production	uSiP (SIP)   9	250   SMALL T&R	Yes	NIAU	Level-2-260C-1 YEAR	-40 to 85	E7 TXI740XEC
TPS82740ASIPT.B	Active	Production	uSiP (SIP)   9	250   SMALL T&R	-	Call TI	Call TI	-40 to 125	
<a href="#">TPS82740BSIPR</a>	Active	Production	uSiP (SIP)   9	3000   LARGE T&R	Yes	NIAU	Level-2-260C-1 YEAR	-40 to 85	E8 TXI2743EC
TPS82740BSIPR.B	Active	Production	uSiP (SIP)   9	3000   LARGE T&R	-	Call TI	Call TI	-40 to 125	
<a href="#">TPS82740BSIPT</a>	Active	Production	uSiP (SIP)   9	250   SMALL T&R	Yes	NIAU	Level-2-260C-1 YEAR	-40 to 85	E8 TXI2743EC
TPS82740BSIPT.B	Active	Production	uSiP (SIP)   9	250   SMALL T&R	-	Call TI	Call TI	-40 to 125	

**(1) Status:** For more details on status, see our [product life cycle](#).

**(2) Material type:** When designated, preproduction parts are prototypes/experimental devices, and are not yet approved or released for full production. Testing and final process, including without limitation quality assurance, reliability performance testing, and/or process qualification, may not yet be complete, and this item is subject to further changes or possible discontinuation. If available for ordering, purchases will be subject to an additional waiver at checkout, and are intended for early internal evaluation purposes only. These items are sold without warranties of any kind.

**(3) RoHS values:** Yes, No, RoHS Exempt. See the [TI RoHS Statement](#) for additional information and value definition.

**(4) Lead finish/Ball material:** Parts may have multiple material finish options. Finish options are separated by a vertical ruled line. Lead finish/Ball material values may wrap to two lines if the finish value exceeds the maximum column width.

**(5) MSL rating/Peak reflow:** The moisture sensitivity level ratings and peak solder (reflow) temperatures. In the event that a part has multiple moisture sensitivity ratings, only the lowest level per JEDEC standards is shown. Refer to the shipping label for the actual reflow temperature that will be used to mount the part to the printed circuit board.

**(6) Part marking:** There may be an additional marking, which relates to the logo, the lot trace code information, or the environmental category of the part.

Multiple part markings will be inside parentheses. Only one part marking contained in parentheses and separated by a "-" will appear on a part. If a line is indented then it is a continuation of the previous line and the two combined represent the entire part marking for that device.

**Important Information and Disclaimer:** The information provided on this page represents TI's knowledge and belief as of the date that it is provided. TI bases its knowledge and belief on information provided by third parties, and makes no representation or warranty as to the accuracy of such information. Efforts are underway to better integrate information from third parties. TI has taken and continues to take reasonable steps to provide representative and accurate information but may not have conducted destructive testing or chemical analysis on incoming materials and chemicals. TI and TI suppliers consider certain information to be proprietary, and thus CAS numbers and other limited information may not be available for release.

In no event shall TI's liability arising out of such information exceed the total purchase price of the TI part(s) at issue in this document sold by TI to Customer on an annual basis.



**TAPE AND REEL INFORMATION**

**QUADRANT ASSIGNMENTS FOR PIN 1 ORIENTATION IN TAPE**

\*All dimensions are nominal

Device	Package Type	Package Drawing	Pins	SPQ	Reel Diameter (mm)	Reel Width W1 (mm)	A0 (mm)	B0 (mm)	K0 (mm)	P1 (mm)	W (mm)	Pin1 Quadrant
TPS82740ASIPR	uSiP	SIP	9	3000	178.0	9.0	2.5	3.1	1.35	4.0	8.0	Q2
TPS82740ASIPT	uSiP	SIP	9	250	178.0	9.0	2.83	3.18	1.2	4.0	8.0	Q2
TPS82740BSIPR	uSiP	SIP	9	3000	178.0	9.0	2.5	3.1	1.35	4.0	8.0	Q2
TPS82740BSIPT	uSiP	SIP	9	250	178.0	9.0	2.83	3.18	1.2	4.0	8.0	Q2

## TAPE AND REEL BOX DIMENSIONS



\*All dimensions are nominal

Device	Package Type	Package Drawing	Pins	SPQ	Length (mm)	Width (mm)	Height (mm)
TPS82740ASIPR	uSiP	SIP	9	3000	223.0	194.0	35.0
TPS82740ASIPT	uSiP	SIP	9	250	223.0	194.0	35.0
TPS82740BSIPR	uSiP	SIP	9	3000	223.0	194.0	35.0
TPS82740BSIPT	uSiP	SIP	9	250	223.0	194.0	35.0

## IMPORTANT NOTICE AND DISCLAIMER

TI PROVIDES TECHNICAL AND RELIABILITY DATA (INCLUDING DATASHEETS), DESIGN RESOURCES (INCLUDING REFERENCE DESIGNS), APPLICATION OR OTHER DESIGN ADVICE, WEB TOOLS, SAFETY INFORMATION, AND OTHER RESOURCES "AS IS" AND WITH ALL FAULTS, AND DISCLAIMS ALL WARRANTIES, EXPRESS AND IMPLIED, INCLUDING WITHOUT LIMITATION ANY IMPLIED WARRANTIES OF MERCHANTABILITY, FITNESS FOR A PARTICULAR PURPOSE OR NON-INFRINGEMENT OF THIRD PARTY INTELLECTUAL PROPERTY RIGHTS.

These resources are intended for skilled developers designing with TI products. You are solely responsible for (1) selecting the appropriate TI products for your application, (2) designing, validating and testing your application, and (3) ensuring your application meets applicable standards, and any other safety, security, regulatory or other requirements.

These resources are subject to change without notice. TI grants you permission to use these resources only for development of an application that uses the TI products described in the resource. Other reproduction and display of these resources is prohibited. No license is granted to any other TI intellectual property right or to any third party intellectual property right. TI disclaims responsibility for, and you fully indemnify TI and its representatives against any claims, damages, costs, losses, and liabilities arising out of your use of these resources.

TI's products are provided subject to [TI's Terms of Sale](#), [TI's General Quality Guidelines](#), or other applicable terms available either on [ti.com](#) or provided in conjunction with such TI products. TI's provision of these resources does not expand or otherwise alter TI's applicable warranties or warranty disclaimers for TI products. Unless TI explicitly designates a product as custom or customer-specified, TI products are standard, catalog, general purpose devices.

TI objects to and rejects any additional or different terms you may propose.

Copyright © 2025, Texas Instruments Incorporated

Last updated 10/2025