

TPSM5601R5 60V 入力、1V~6V 出力、1.5A パワー・モジュール、Enhanced HotRod™ QFN パッケージ

1 特長

- 機能安全対応
 - 機能安全システムの設計に役立つ資料を利用可能
- 5.0mm × 5.5mm × 4.0mm の Enhanced HotRod™ QFN
 - 優れた熱性能: 85°C、空気流なしで、最大 18W の出力
 - 標準的なフットプリント: 1 つの大型サーマル・パッド、すべてのピンに外周から接続可能
- 高信頼性の堅牢なアプリケーション用に設計
 - 広い入力電圧範囲: 4.2V~60V
 - 最大 66V の入力電圧過渡保護
 - 動作時の接合部温度範囲: -40°C~+125°C
 - EXT サフィックスの接合部温度範囲: -55°C~+125°C
- 400kHz の固定スイッチング周波数
- FPWM 動作モード
- 超低 EMI 要件に最適化
 - シールド付きインダクタと高周波バイパス・コンデンサを内蔵
 - [EN55011 EMI 規格に準拠](#)
 - スペクトラム拡散オプションによって放射を低減
- 非スイッチング時の静止電流: 26µA
- あらかじめ出力にバイアスが印加された状態でも単調にスタートアップ
- ループ補償またはブートストラップ部品が不要
- ヒステリシス付きの高精度イネーブルおよび入力 UVLO
- ヒステリシス付きのサーマル・シャットダウン保護
- [WEBENCH® Power Designer](#) により、TPSM5601R5 を使用するカスタム設計を作成

2 アプリケーション

- フィールド・トランスミッタおよびセンサ、PLC モジュール
- サーモスタット、ビデオ監視、HVAC システム
- AC およびサーボ・ドライブ、ロータリー・エンコーダ
- 産業用輸送、アセット・トラッキング
- 負出力アプリケーション

3 概要

TPSM5601R5 パワー・モジュールは、60V 入力の降圧型 DC/DC コンバータとパワー MOSFET、シールド付きインダクタ、受動素子を、放熱特性の優れた QFN パッケージに統合した高集積 1.5A 電源ソリューションです。5mm × 5.5mm × 4mm の 15 ピン QFN パッケージに Enhanced HotRod QFN テクノロジーを採用し、熱性能の強化、小さなフットプリント、低 EMI を実現しています。1 つの大型サーマル・パッドを搭載し、パッケージのすべてのピンに外周からアクセスできるため、レイアウトが単純で製造時の扱いも簡単です。

TPSM5601R5 は、1.0V~6V と広い調整可能な出力電圧範囲を持つコンパクトで使いやすいパワー・モジュールです。ソリューション全体に必要な外付け部品はわずか 4 つであり、設計プロセスではループ補償と磁気部品選択は不要です。パワー・グッド、プログラム可能な UVLO、プリバイアス・スタートアップ、過電流および過熱保護などの完全な機能セットを備えているため、TPSM5601R5 は広範なアプリケーションの電源として非常に優れたデバイスです。5.0mm × 5.5mm のパッケージは、スペースに制約のあるアプリケーションに適しています。さらに、TPSM5601R5S は周波数スペクトラム拡散動作を実現します。

製品情報

部品番号	パッケージ ⁽¹⁾	本体サイズ (公称)
TPSM5601R5	QFN (15)	5.0mm × 5.5mm
TPSM5601R5S		

- (1) 利用可能なパッケージについては、このデータシートの末尾にある注文情報を参照してください。



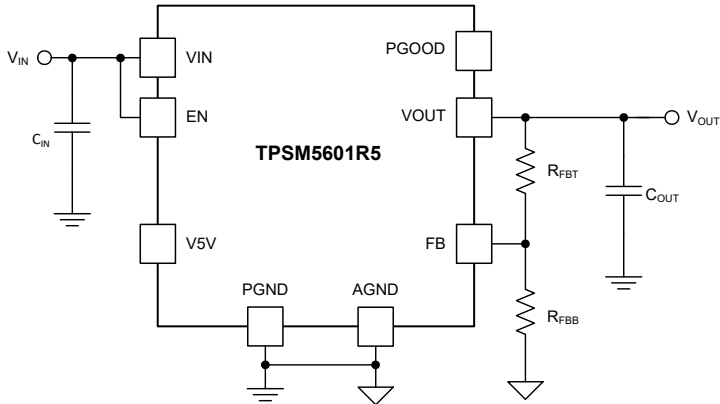

代表的な回路図

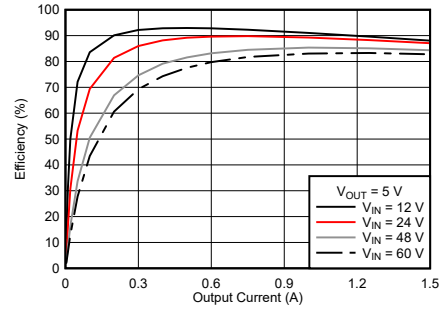

標準的な効率、 $V_{OUT} = 5V$

Table of Contents

1 特長	1	8.3 Feature Description.....	14
2 アプリケーション	1	8.4 Device Functional Modes.....	16
3 概要	1	9 Applications and Implementation	18
4 Revision History	3	9.1 Application Information.....	18
5 Device Comparison Table	4	9.2 Typical Application.....	18
6 Pin Configuration and Functions	4	10 Power Supply Recommendations	20
7 Specifications	6	11 Layout	21
7.1 Absolute Maximum Ratings	6	11.1 Layout Guidelines.....	21
7.2 ESD Ratings	6	11.2 Layout Example.....	21
7.3 Recommended Operating Conditions	7	12 Device and Documentation Support	25
7.4 Thermal Information	7	12.1 Device Support.....	25
7.5 Electrical Characteristics	8	12.2 Documentation Support.....	25
7.6 Typical Characteristics ($V_{IN} = 12\text{ V}$).....	9	12.3 Receiving Notification of Documentation Updates..	25
7.7 Typical Characteristics ($V_{IN} = 24\text{ V}$).....	10	12.4 サポート・リソース.....	25
7.8 Typical Characteristics ($V_{IN} = 48\text{ V}$).....	11	12.5 Trademarks.....	25
7.9 Typical Characteristics ($V_{IN} = 60\text{ V}$).....	12	12.6 Electrostatic Discharge Caution.....	26
8 Detailed Description	13	12.7 Glossary.....	26
8.1 Overview.....	13	13 Mechanical, Packaging, and Orderable Information	26
8.2 Functional Block Diagram.....	13		

4 Revision History

DATE	REVISION	NOTES
September 2021	*	Initial release

5 Device Comparison Table

DEVICE	DESCRIPTION
TPSM5601R5	60-V input voltage, 1-V to 6-V output voltage, 1.5-A power module, fixed 400-kHz switching, -40°C to +125°C operating junction temperature range
TPSM5601R5S	Equivalent to TPSM5601R5, but with spread spectrum operation

6 Pin Configuration and Functions



图 6-1. 15-Pin QFN RDA Package (Top View)

表 6-1. Pin Functions

PIN		TYPE ⁽¹⁾	DESCRIPTION
NO.	NAME		
10	AGND	G	Analog ground. Zero voltage reference for internal references and logic. All electrical parameters are measured with respect to this pin. <i>This pin must be connected to PGND at a single point.</i> See セクション 11.2 for a recommended layout.
5	DNC	—	Do not connect. Do not connect this pin to ground, to another pin, or to any other voltage. This pin is connected to the internal bootstrap capacitor. This pin must be soldered to an isolated pad.
2	EN	I	Enable pin. This pin turns the converter on when pulled high and turns off the converter when pulled low. This pin can be connected directly to VIN. <i>Do not float.</i> This pin can be used to set the input undervoltage lockout with two resistors. See セクション 8.3.4 .
9	FB	I	Feedback input. Connect the mid-point of the feedback resistor divider to this pin. Connect the upper resistor (R_{FBT}) of the feedback divider to V_{OUT} at the desired point of regulation. Connect the lower resistor (R_{FBB}) of the feedback divider to AGND.
3, 6, 13	NC	—	Not connected. These pins are not connected to any circuitry within the module. Leaving these pins unconnected to any other signal increases spacing near the high voltage pins (VIN, SW, EN, and DNC). However, if the high voltage spacing is not needed in the application, connecting these pins to the PGND plane can help enhance shielding and thermal performance.
15	PGND	G	Power ground. This is the return current path for the power stage of the device. Connect this pad to the input supply return, load return, and capacitors associated with the VIN and VOUT pins. See セクション 11.2 for a recommended layout.
12	PGOOD	O	Power-good pin. Open-drain output that asserts low if the feedback voltage is not within the specified window thresholds. A 10-k Ω to 100-k Ω pullup resistor is required and can be tied to the V5V pin or other DC voltage less than 18 V. If not used, this pin can be left open or connected to PGND.
4	SW	O	Switch node. Do not place any external component on this pin or connect to any signal.
1, 14	VIN	I	Input supply voltage. Connect the input supply to these pins. Connect input capacitors between these pins and PGND in close proximity to the device.

表 6-1. Pin Functions (continued)

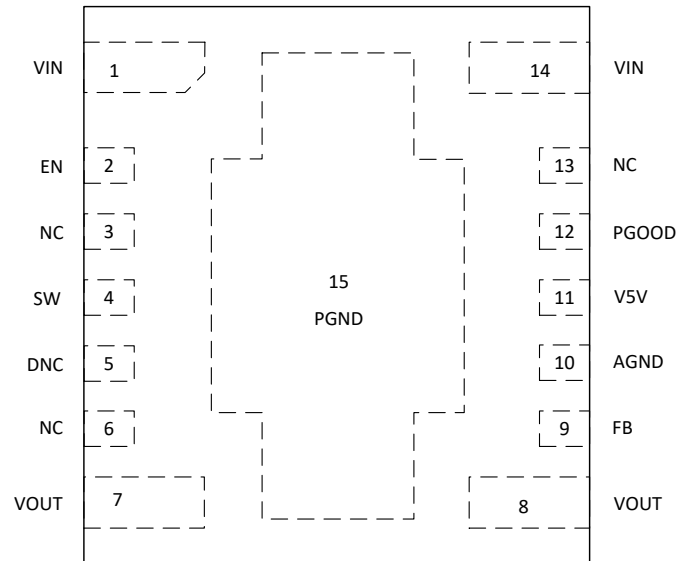
PIN		TYPE ⁽¹⁾	DESCRIPTION
NO.	NAME		
7, 8	VOUT	O	Output voltage. These pins are connected to the internal output inductor. Connect these pins to the output load and connect external output capacitors between these pins and PGND.
11	V5V	O	Internal 5-V LDO output. Supplies internal control circuits. Do not connect to external loads. This pin can be used as logic supply for the PGOOD pin.

(1) G = Ground, I = Input, O = Output

7 Specifications

7.1 Absolute Maximum Ratings

Over the operating ambient temperature range⁽¹⁾

PARAMETER		MIN	MAX	UNIT
Input voltage	VIN to PGND	-0.3	66	V
	EN to AGND ⁽²⁾	-0.3	V _{IN} + 0.3	
	PGOOD to AGND ⁽²⁾	-0.3	22	
	FB to AGND	-0.3	5.5	
	AGND to PGND	-0.3	0.3	
Output voltage	VOUT to PGND ⁽²⁾	-0.3	30	
	VCC to AGND	0	5.5	
Operating IC junction temperature, T _J ⁽³⁾		-40	125	°C
Storage temperature, T _{stg}		-55	150	°C
Peak reflow case temperature			245	°C
Maximum number of reflows allowed			3	
Mechanical vibration	Mil-STD-883H, Method 2007.3, 1 msec, 1/2 sine, mounted		20	G
Mechanical shock	Mil-STD-883H, Method 2002.5, 20 to 2000Hz		500	G

- (1) Operation outside the *Absolute Maximum Ratings* may cause permanent device damage. *Absolute Maximum Ratings* do not imply functional operation of the device at these or any other conditions beyond those listed under *Recommended Operating Conditions*. If used outside the *Recommended Operating Conditions* but within the *Absolute Maximum Ratings*, the device may not be fully functional, and this may affect device reliability, functionality, performance, and shorten the device lifetime.
- (2) The voltage on this pin must not exceed the voltage on the VIN pin by more than 0.3 V.
- (3) The ambient temperature is the air temperature of the surrounding environment. The junction temperature is the temperature of the internal power IC when the device is powered. Operating below the maximum ambient temperature, as shown in the safe operating area (SOA) curves in the typical characteristics sections, ensures that the maximum junction temperature of any component inside the module is never exceeded.

7.2 ESD Ratings

			VALUE	UNIT
V _(ESD)	Electrostatic discharge	Human-body model (HBM) ⁽¹⁾	±1500	V
		Charged-device model (CDM) ⁽²⁾	±1500	

- (1) JEDEC document JEP155 states that 500-V HBM allows safe manufacturing with a standard ESD control process.
- (2) JEDEC document JEP157 states that 250-V CDM allows safe manufacturing with a standard ESD control process.

7.3 Recommended Operating Conditions

Over operating ambient temperature range (unless otherwise noted) ⁽¹⁾

	MIN	MAX	UNIT
Input voltage, V_{IN}	4.2	60	V
Output voltage, V_{OUT}	1	6 ⁽³⁾	V
Output current, I_{OUT}	0	1.5	A
EN voltage, V_{EN} ⁽²⁾	0	V_{IN}	V
PGOOD pullup voltage, V_{PGOOD} ⁽²⁾	0	18	V
Operating ambient temperature, T_A	-40	105	°C

- (1) Recommended operating conditions indicate conditions for which the device is intended to be functional, but do not ensure specific performance limits. For ensured specifications, see the [Electrical Characteristics](#).
- (2) The voltage on this pin must not exceed the voltage on the V_{IN} pin by more than 0.3 V.
- (3) The recommended maximum output voltage varies depending input voltage.

7.4 Thermal Information

THERMAL METRIC ⁽¹⁾		TPSM5601R5		UNIT
		RDA (QFN)		
		15 PINS		
$R_{\theta JA}$	Junction-to-ambient thermal resistance ⁽²⁾	Nat Conv	20.4	°C/W
		100 LFM	18.9	°C/W
		200 LFM	17.6	°C/W
ψ_{JT}	Junction-to-top characterization parameter ⁽³⁾		3.6	°C/W
ψ_{JB}	Junction-to-board characterization parameter ⁽⁴⁾		15.3	°C/W
T_{SHDN}	Thermal shutdown temperature		170	°C
	Recovery temperature		158	°C

- (1) For more information about traditional and new thermal metrics, see the [Semiconductor and IC Package Thermal Metrics](#) application report.
- (2) The junction-to-ambient thermal resistance, $R_{\theta JA}$, applies to devices soldered directly to a 6.35-cm × 8.25-cm, four-layer PCB with 2-oz. copper. Additional airflow and PCB copper area reduces $R_{\theta JA}$. See [セクション 11.2.1](#) for more information.
- (3) The junction-to-top board characterization parameter, ψ_{JT} , estimates the junction temperature, T_J , of a device in a real system, using a procedure described in JE51-2A (section 6 and 7). $T_J = \psi_{JT} \times P_{dis} + T_T$; where P_{dis} is the power dissipated in the device and T_T is the temperature of the top of the device.
- (4) The junction-to-board characterization parameter, ψ_{JB} , estimates the junction temperature, T_J , of a device in a real system, using a procedure described in JE51-2A (sections 6 and 7). $T_J = \psi_{JB} \times P_{dis} + T_B$; where P_{dis} is the power dissipated in the device and T_B is the temperature of the board 1mm from the device.

7.5 Electrical Characteristics

Limits apply over $T_A = -40^\circ\text{C}$ to $+105^\circ\text{C}$, $V_{IN} = 24\text{ V}$, $V_{OUT} = 3.3\text{ V}$, $I_{OUT} = 1.5\text{ A}$, 600 mA , (unless otherwise noted); minimum and maximum limits are specified through production test or by design. Typical values represent the most likely parametric norm and are provided for reference only.

PARAMETER		TEST CONDITIONS	MIN	TYP	MAX	UNIT
INPUT VOLTAGE (V_{IN})						
V_{IN}	Input voltage range	Over I_{OUT} range	4.2 ⁽¹⁾		60	V
	V_{IN} turn-on	V_{IN} increasing, $I_{OUT} = 0\text{ A}$, $V_{EN} = V_{IN}$		3.8		V
	V_{IN} turn-off	V_{IN} decreasing, $I_{OUT} = 0\text{ A}$, $V_{EN} = V_{IN}$		3.3		V
I_{SHDN}	Shutdown supply current	$V_{EN} = 0\text{ V}$, $I_{OUT} = 0\text{ A}$		5		μA
INTERNAL LDO (V5V)						
V5V	Internal LDO output voltage appearing at the V5V pin	$6\text{ V} \leq V_{IN} \leq 60\text{ V}$	4.75	5	5.25	V
FEEDBACK						
V_{FB}	Load regulation	$T_A = +25^\circ\text{C}$, $0\text{ A} \leq I_{OUT} \leq 1.5\text{ A}$		0.057%		
V_{FB}	Line regulation	$T_A = +25^\circ\text{C}$, $I_{OUT} = 0\text{ A}$, $6\text{ V} \leq V_{IN} \leq 60\text{ V}$		0.024%		
I_{FB}	Current into FB pin	$FB = 1\text{ V}$		0.2		nA
CURRENT						
I_{OUT}	Output current	$T_A = 25^\circ\text{C}$	0		1.5	A
I_{OUT}	Overcurrent threshold	$V_{OUT} = 3.3\text{ V}$, $T_A = 25^\circ\text{C}$		1.9		A
V_{HC}	FB pin voltage required to trip short-circuit hiccup mode			0.4		V
t_{HC}	Time between current-limit hiccup burst			94		ms
ENABLE (EN PIN)						
$V_{EN-VCC-H}$	EN input level required to turn on internal LDO	Rising threshold			1.14	V
$V_{EN-VCC-L}$	EN input level required to turn off internal LDO	Falling threshold	0.3			V
V_{EN-H}	EN input level required to start switching	Rising threshold	1.157	1.231	1.30	V
V_{EN-HYS}	Hysteresis below V_{EN-H}	Hysteresis below V_{EN-H} ; falling		110		mV
I_{LKG-EN}	Enable input leakage current	$V_{EN} = 3.3\text{ V}$		0.2		nA
POWER GOOD (PGOOD PIN)						
$V_{PG-LOW-UP}$	V_{OUT} rising (fault)	% of FB voltage		107%		
$V_{PG-HIGH-DN}$	V_{OUT} falling (good)	% of FB voltage		105%		
$V_{PG-HIGH-UP}$	V_{OUT} rising (good)	% of FB voltage		95%		
$V_{PG-LOW-DN}$	V_{OUT} falling (fault)	% of FB voltage		93%		
R_{PG}	Power-good flag R_{DSON}	$V_{EN} = 0\text{ V}$		35		Ω
V_{IN-PG}	Minimum input voltage for proper PGOOD function	$I_{PG} = 50\text{ }\mu\text{A}$, $EN = 0\text{ V}$			2	V
PERFORMANCE						
η	Efficiency	$V_{OUT} = 3.3\text{ V}$, $I_{OUT} = 0.75\text{ A}$, $T_A = 25^\circ\text{C}$		81%		
η	Efficiency	$V_{OUT} = 5.0\text{ V}$, $I_{OUT} = 0.75\text{ A}$, $T_A = 25^\circ\text{C}$		86%		
SOFT START						
t_{SS}	Internal soft-start time			4.5		ms
SWITCHING FREQUENCY						
f_{SW}	Switching frequency	$I_{OUT} = 0.75\text{ A}$, $T_A = 25^\circ\text{C}$	340	400 ⁽²⁾	460	kHz
f_{SW} ss device	Switching frequency for spread spectrum device only	$I_{OUT} = 0.75\text{ A}$, $T_A = 25^\circ\text{C}$	320	400	480	kHz

(1) The recommended minimum V_{IN} is 4.2 V or ($V_{OUT} + 600\text{ mV}$), whichever is greater.

(2) The typical switching frequency of this device will change based on operating conditions. See the Switching Frequency section for more information.

7.6 Typical Characteristics ($V_{IN} = 12\text{ V}$)

$T_A = 25^\circ\text{C}$, unless otherwise noted.

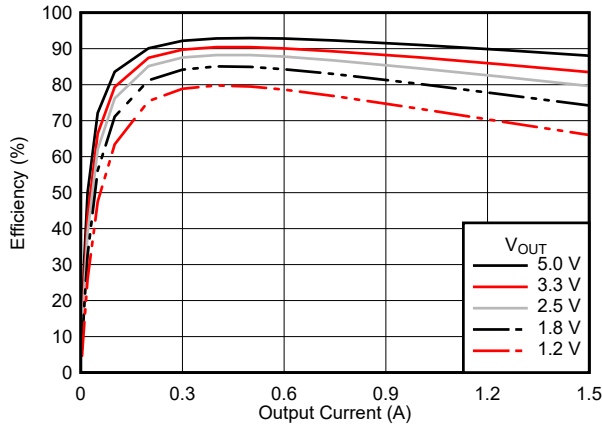

7-1. Efficiency

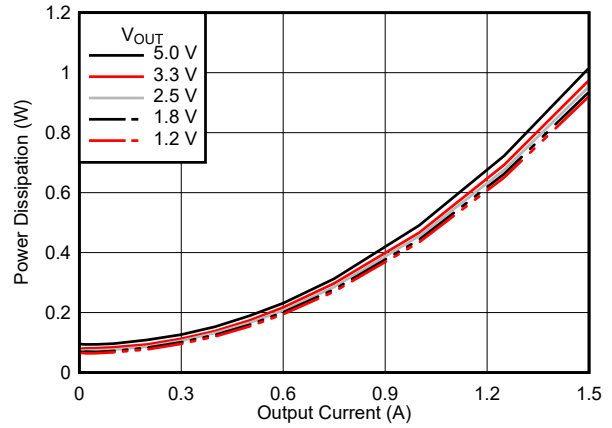

7-2. Power Dissipation

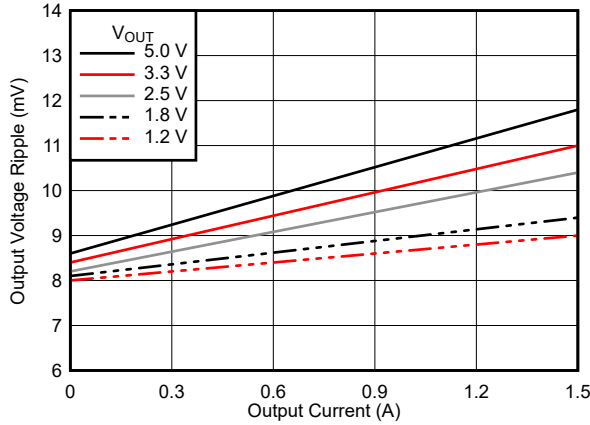

$C_{OUT} = 4 \times 100\ \mu\text{F}$, 10-V, ceramic

7-3. Output Voltage Ripple

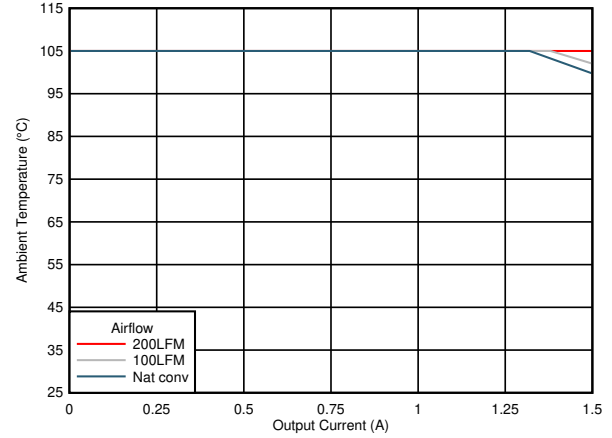

Device soldered to a 63.5-mm \times 82.5-mm, 4-layer PCB

7-4. Safe Operating Area ($V_{OUT} = 1.2\text{ V}$)

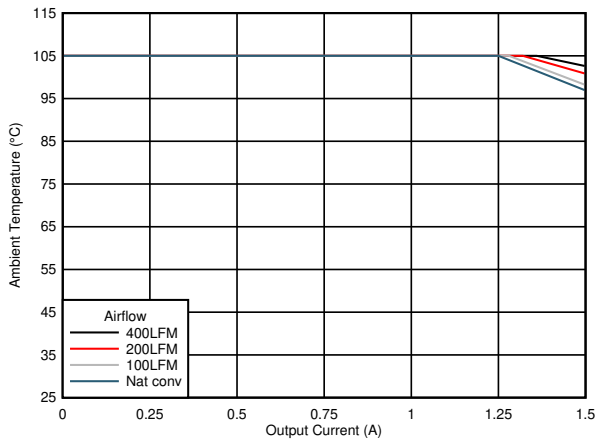

Device soldered to a 63.5-mm \times 82.5-mm, 4-layer PCB

7-5. Safe Operating Area ($V_{OUT} = 3.3\text{ V}$)

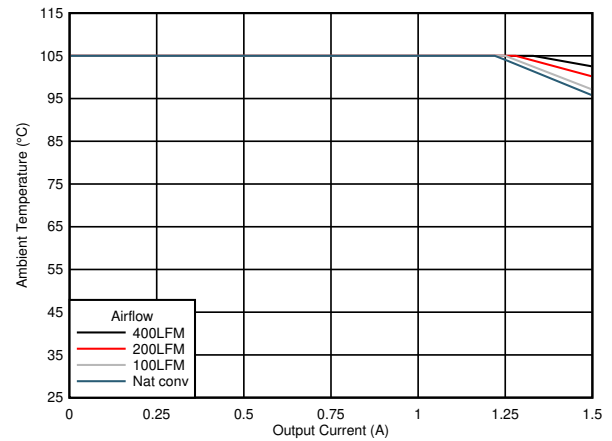

Device soldered to a 63.5-mm \times 82.5-mm, 4-layer PCB

7-6. Safe Operating Area ($V_{OUT} = 5.0\text{ V}$)

7.7 Typical Characteristics ($V_{IN} = 24\text{ V}$)

$T_A = 25^\circ\text{C}$, unless otherwise noted.

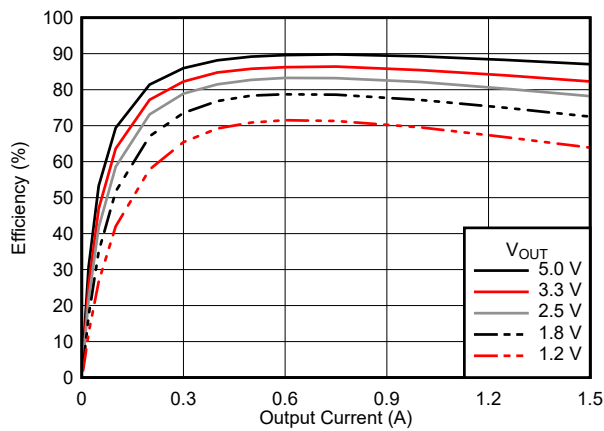

7-7. Efficiency

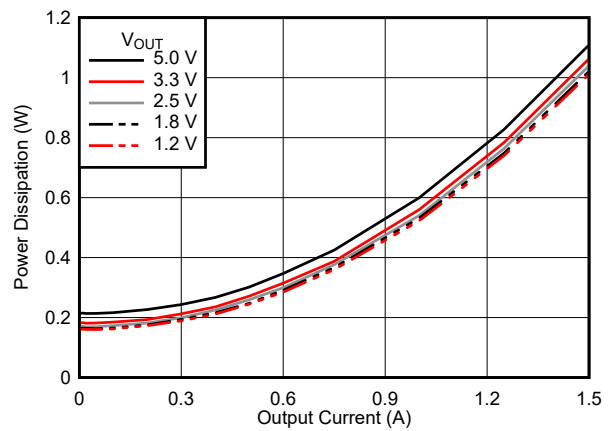

7-8. Power Dissipation

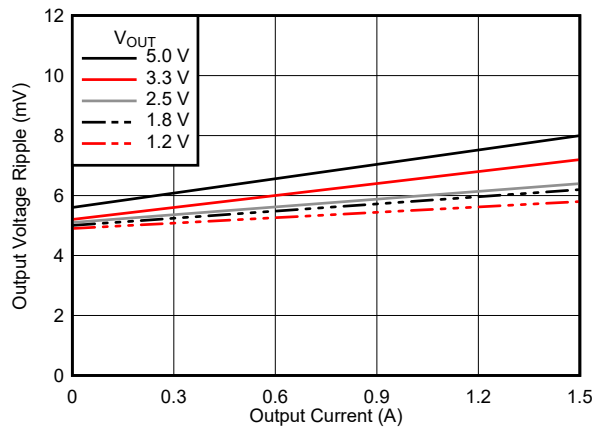

$C_{OUT} = 4 \times 100\text{-}\mu\text{F}$, 10-V, ceramic

7-9. Output Voltage Ripple

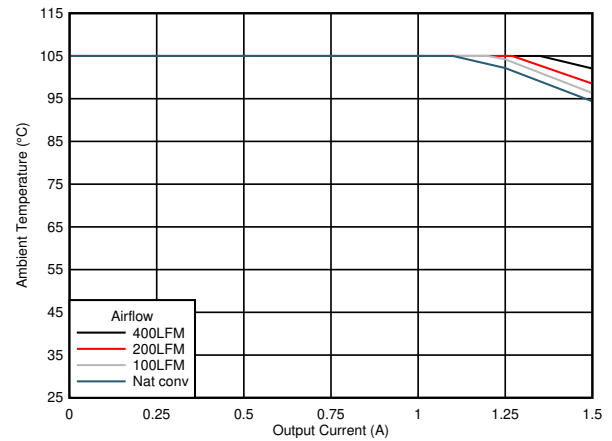

Device soldered to a 63.5-mm \times 82.5-mm, 4-layer PCB

7-10. Safe Operating Area ($V_{OUT} = 1.8\text{ V}$)

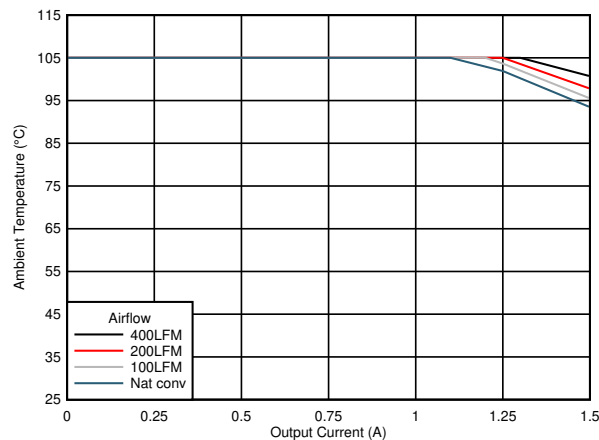

Device soldered to a 63.5-mm \times 82.5-mm, 4-layer PCB

7-11. Safe Operating Area ($V_{OUT} = 5.0\text{ V}$)

7.8 Typical Characteristics ($V_{IN} = 48\text{ V}$)

$T_A = 25^\circ\text{C}$, unless otherwise noted.

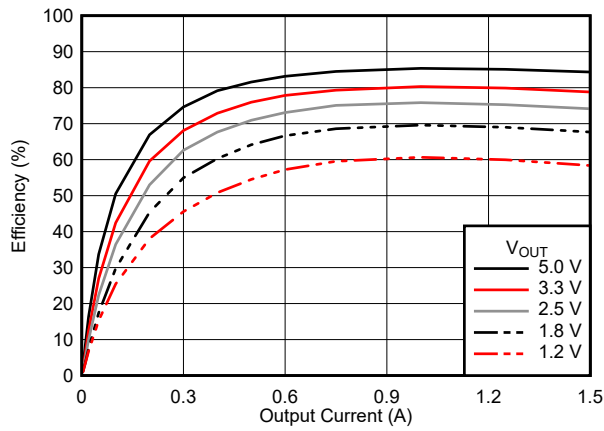

7-12. Efficiency

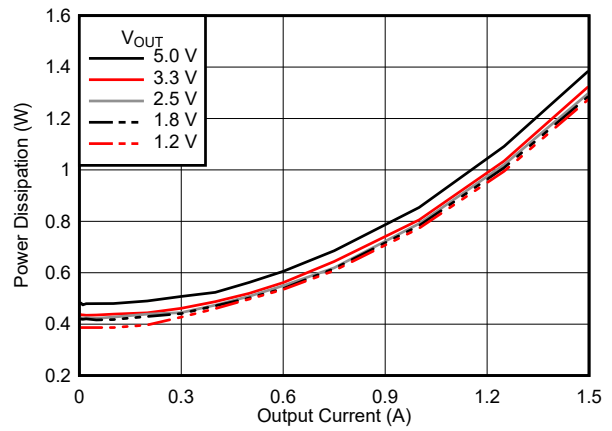

7-13. Power Dissipation

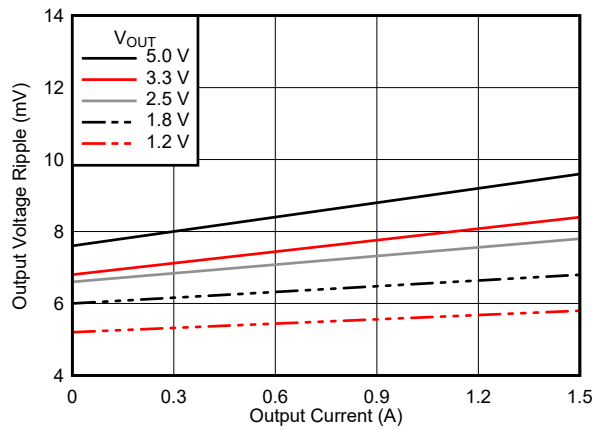

$C_{OUT} = 4 \times 100\text{-}\mu\text{F}$, 10-V, ceramic

7-14. Output Voltage Ripple

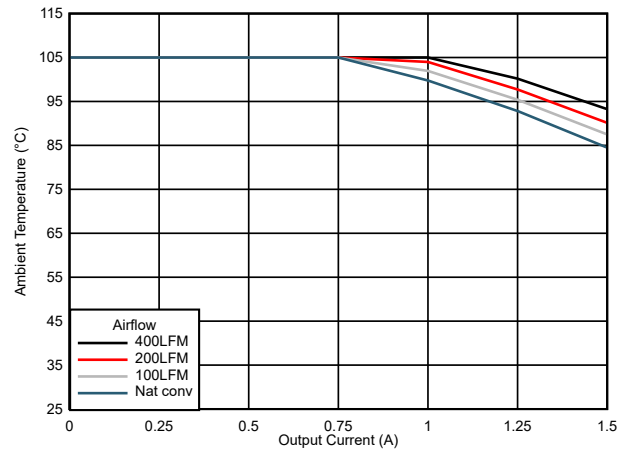

Device soldered to a 63.5-mm \times 82.5-mm, 4-layer PCB

7-15. Safe Operating Area ($V_{OUT} = 3.3\text{ V}$)

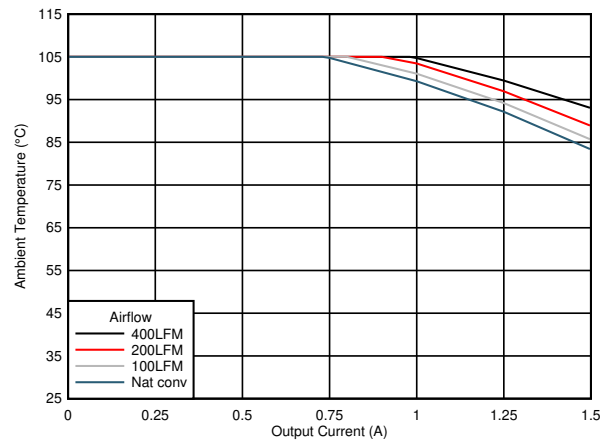

Device soldered to a 63.5-mm \times 82.5-mm, 4-layer PCB

7-16. Safe Operating Area ($V_{OUT} = 5.0\text{ V}$)

7.9 Typical Characteristics ($V_{IN} = 60\text{ V}$)

$T_A = 25^\circ\text{C}$, unless otherwise noted.

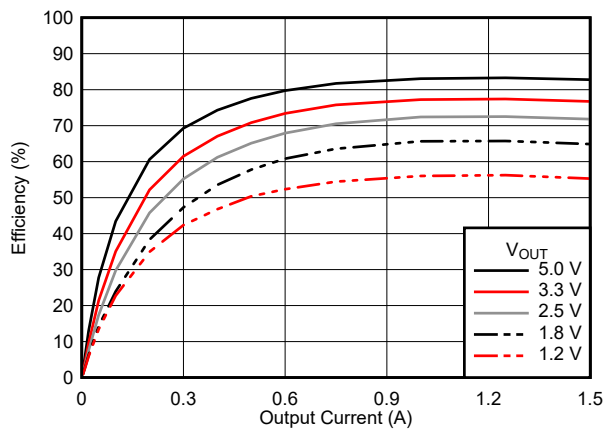

7-17. Efficiency

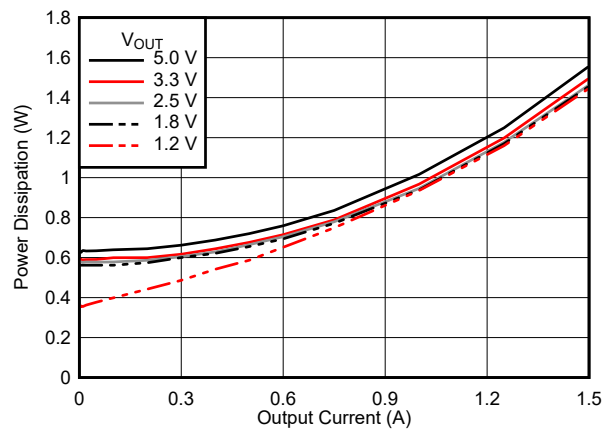

7-18. Power Dissipation

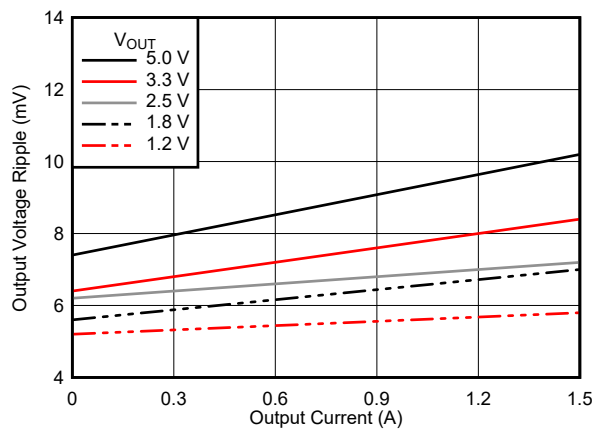

7-19. Output Voltage Ripple

$C_{OUT} = 4 \times 100\text{-}\mu\text{F}$, 10-V, ceramic

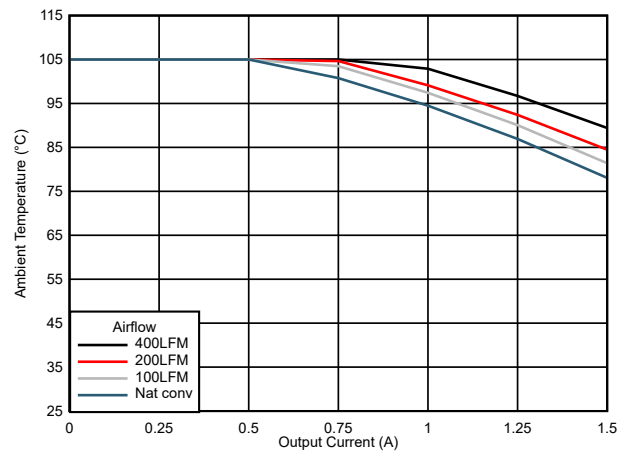

7-20. Safe Operating Area ($V_{OUT} = 3.3\text{ V}$)

Device soldered to a 63.5-mm \times 82.5-mm, 4-layer PCB

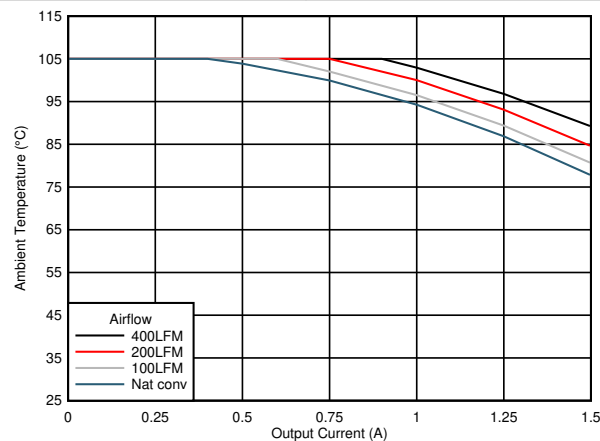

7-21. Safe Operating Area ($V_{OUT} = 5.0\text{ V}$)

Device soldered to a 63.5-mm \times 82.5-mm, 4-layer PCB

8 Detailed Description

8.1 Overview

The TPSM5601R5 converter is an easy-to-use, synchronous buck, DC-DC power module that operates from a 4.2-V to 60-V supply voltage. The device is intended for step-down conversions from 5-V, 12-V, 24-V, and 48-V unregulated, semi-regulated, or fully-regulated supply rails. With an integrated power controller, inductor, and MOSFETs, the TPSM5601R5 delivers up to 1.5-A DC load current, with high efficiency and ultra-low input quiescent current, in a very small solution size. Although designed for simple implementation, this device offers flexibility to optimize its usage according to the target application. Control-loop compensation is not required, reducing design time and external component count.

The TPSM5601R5 incorporates several features for comprehensive system requirements, including the following:

- Open-drain power-good circuit for power-rail sequencing and fault reporting
- Monotonic start-up into prebiased loads
- Precision enable with customizable hysteresis for programmable line undervoltage lockout (UVLO)
- Overcurrent and thermal shutdown with automatic recovery

Additionally, the TPSM5601R5S offers frequency spread-spectrum operation. These features enable a flexible and easy-to-use platform for a wide range of applications. The pin arrangement is designed for simple PCB layout, requiring as few as four external components.

8.2 Functional Block Diagram

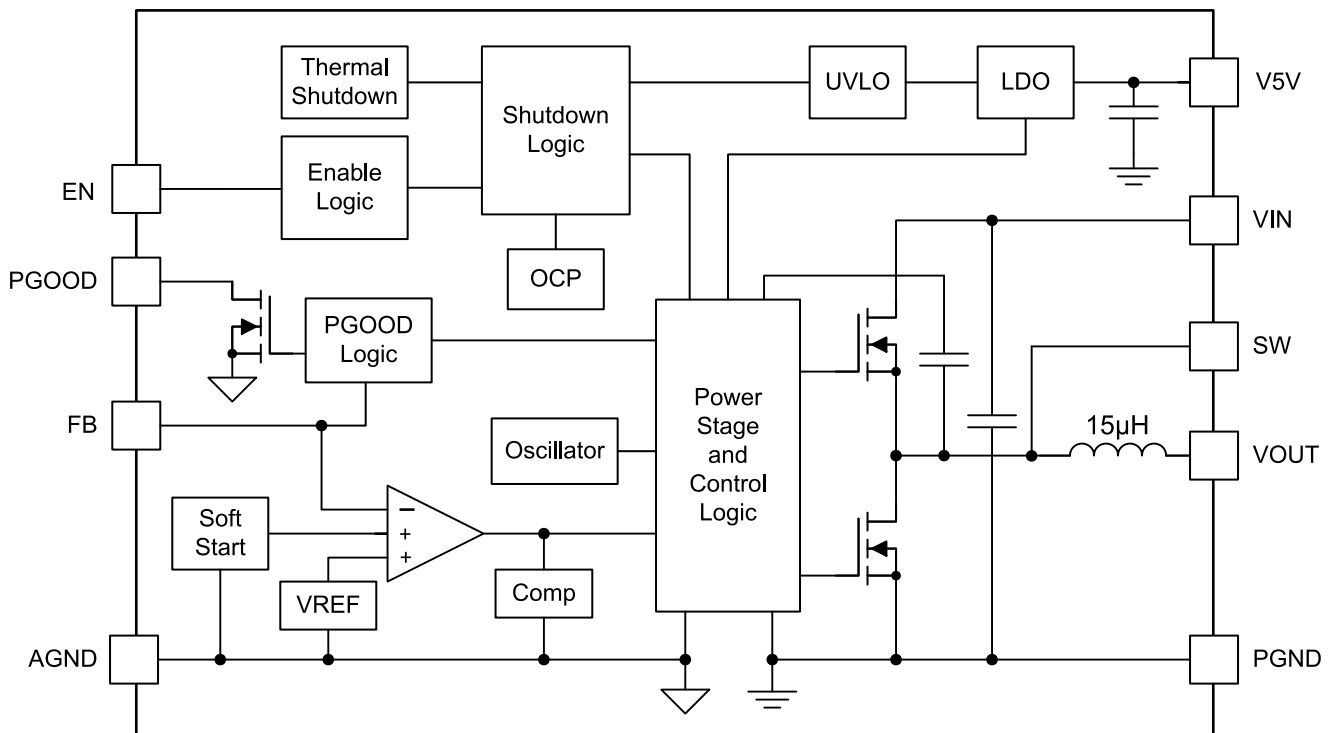

8.3 Feature Description

8.3.1 Adjustable Output Voltage (FB)

The TPSM5601R5 has an adjustable output voltage range of 1.0 V to 6 V. Setting the output voltage requires two resistors, R_{FBT} and R_{FBB} (see [Figure 8-1](#)). Connect R_{FBT} between VOUT, at the regulation point, and the FB pin. Connect R_{FBB} between the FB pin and AGND (pin 10). The recommended value of R_{FBT} is 10 k Ω . The value for R_{FBB} can be calculated using [Equation 1](#).

$$R_{FBB} = \frac{1.0}{V_{OUT} - 1.0} \times R_{FBT} \quad (1)$$

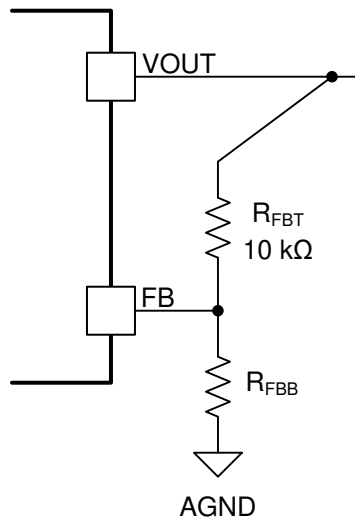

Figure 8-1. FB Resistor Divider

Table 8-1. Standard R_{FBB} Values

VOUT (V)	R_{FBB} (k Ω) ⁽¹⁾
1.0	open
1.2	49.9
1.5	20.0
1.8	12.4
2.0	10.0
2.5	6.65
3.0	4.99
3.3	4.32
5.0	2.49
6.0	2.0

(1) $R_{FBT} = 10$ k Ω

Select an R_{FBT} value of 10 k Ω for most applications. A larger R_{FBT} consumes less DC current, which is mandatory if light-load efficiency is critical. However, R_{FBT} larger than 1 M Ω is not recommended as the feedback path becomes more susceptible to noise. High feedback resistance generally requires more careful layout of the feedback path. It is important to keep the feedback trace as short as possible while keeping the feedback trace away from the noisy area of the PCB. For more layout recommendations, see [Section 11](#).

8.3.2 Minimum Input Capacitance

The TPSM5601R5 requires a minimum input capacitance of 9.4 μF ($2 \times 4.7 \mu\text{F}$) of ceramic type. High-quality, ceramic-type X5R or X7R capacitors with sufficient voltage rating are required. Place the input capacitors, as close as possible to both VIN pins of the device, between VIN and PGND as shown in [セクション 11.1](#). Applications with transient load requirements can benefit from adding additional bulk capacitance to the input as well.

8.3.3 Minimum Output Capacitance

The TPSM5601R5 requires a minimum amount of ceramic output capacitance for stability depending on the output voltage setting. [図 8-2](#) shows the amount of required output capacitance, which is the amount of *effective* capacitance. The effects of DC bias and temperature variation must be considered when using ceramic capacitance. For ceramic capacitors, the package size, voltage rating, and dielectric material contribute to differences between the standard rated value and the actual effective value of the capacitance. Additional output capacitance above the minimum can be added to reduce output voltage ripple and to improve transient response. When adding additional capacitance above the minimum, the capacitance can be ceramic type, low-ESR polymer type, or a combination of the two.



図 8-2. Minimum Required Output Capacitance

8.3.4 Precision Enable (EN), Undervoltage Lockout (UVLO), and Hysteresis (HYS)

The EN pin provides precision ON and OFF control for the TPSM5601R5. Once the EN pin voltage exceeds the threshold voltage, the device starts operation. The simplest way to enable the device is to connect EN directly to VIN. This allows the device to start up when V_{IN} is within its valid operating range. An external logic signal can also be used to drive the EN input to toggle the output on and off and for system sequencing or protection. *This input must not be allowed to float.*

The TPSM5601R5 implements internal undervoltage lockout (UVLO) circuitry on the VIN pin. The device is disabled when the VIN pin voltage is below the internal VIN UVLO threshold. The internal VIN UVLO rising threshold is 3.8 V (typical) with a typical hysteresis of 500 mV.

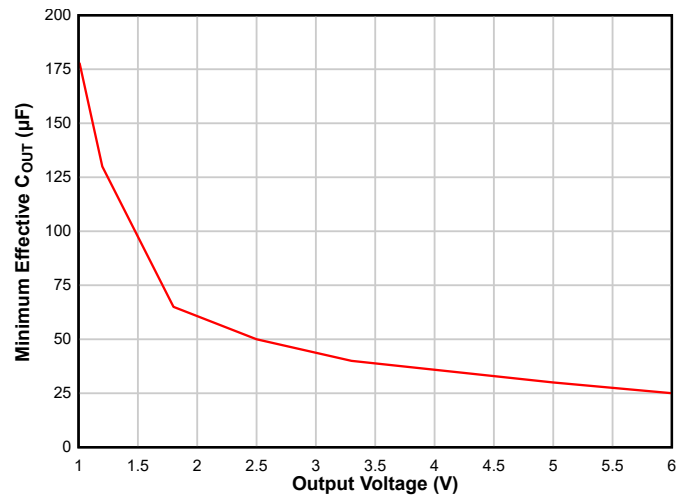
If an application requires a higher UVLO threshold, the EN input supports adjustable UVLO by connecting a resistor divider from VIN to the EN pin. Applying a voltage greater than or equal to 1.14 V causes the device to enter Standby mode, powering the internal LDO, but not producing an output voltage. Increasing the EN voltage to 1.231 V (typical) fully enables the device, allowing it to enter Start-up mode and start the soft-start period. When the EN input is brought below 1.121 V (110-mV hysteresis), the regulator stops running and enters Standby mode. Further decrease in the EN voltage to below 0.3 V completely shuts down the device.

The TPSM5601R5 utilizes a reference-based soft start that prevents output voltage overshoots and large inrush currents as the regulator is starting up. The rise time of the output voltage is about 4 ms.

8.3.5 Power Good (PGOOD)

The TPSM5601R5 provides a PGOOD signal to indicate when the output voltage is within regulation. Use the PGOOD signal for output monitoring, fault protection, or start-up sequencing of downstream converters. PGOOD is an open-drain output that requires a pullup resistor to a DC supply not greater than 18 V. V5V or VOUT can be used as the pullup voltage source. Typical range of pullup resistance is 10 k Ω to 100 k Ω . If necessary, use a resistor divider to decrease the voltage from a higher voltage pullup rail. If this function is not needed, the PGOOD pin must be grounded.

When the output voltage exceeds 95% (rising) or decreases below 105% (falling) of the setpoint, the internal PGOOD switch turns off and PGOOD can be pulled high by the external pullup. If the FB voltage falls below 93% or rises above 107% of the setpoint, the internal PGOOD switch turns on, and PGOOD is pulled low to indicate that the output voltage is out of regulation.

Note that during initial power up, a delay of about 4 ms (typical) is inserted from the time that EN is asserted to the time that the power-good flag goes high. This delay only occurs during start-up and is not encountered during normal operation of the power-good function.

8.3.6 Spread Spectrum Operation

Spread spectrum is a factory option in the TPSM5601R5S variant. The purpose of the spread spectrum is to eliminate peak emissions at specific frequencies by spreading emissions across a wider range of frequencies than a part with fixed frequency operation. In most systems, low frequency conducted emissions from the first few harmonics of the switching frequency can be easily filtered. A more difficult design criterion is reduction of emissions at higher harmonics which fall in the FM band. These harmonics often couple to the environment through electric fields around the switch node. The TPSM5601R5S device with triangular spread spectrum uses a $\pm 4\%$ spreading rate (typical) with the modulation rate set at 16 kHz (typical). The spread spectrum is only available while the internal clock is free running at its natural frequency. Any of the following conditions override spread spectrum, turning it off:

- At high input voltages/low output voltage ratio when the device operates at minimum on time the internal clock is slowed disabling spread spectrum.
- The clock is slowed during dropout.

8.3.7 Overcurrent Protection (OCP)

The TPSM5601R5 is protected from overcurrent conditions using cycle-by-cycle current limiting for overload conditions and Hiccup mode for short circuits. The current is compared every switching cycle to the current limit threshold. During an overcurrent condition, the output voltage decreases.

8.3.8 Thermal Shutdown

Thermal shutdown is an integrated self-protection used to limit junction temperature and prevent damage related to overheating. Thermal shutdown turns off the device when the junction temperature exceeds 170°C (typical) to prevent further power dissipation and temperature rise. Junction temperature decreases after shutdown and the TPSM5601R5 restarts when the junction temperature falls to 158°C (typical).

8.4 Device Functional Modes

8.4.1 Active Mode

The TPSM5601R5 is in Active mode when VIN is above the turn-on threshold and the EN pin voltage is above the EN high threshold. Connect the EN pin to VIN to allow the device to start up when a valid input voltage is applied. This allows self start-up of the TPSM5601R5 when the input voltage is in the operation range of 4.2 V to 60 V. Connecting a resistor divider between VIN, EN, and AGND adjusts the UVLO to delay the turn on until VIN is closer to its regulated voltage.

8.4.2 Standby Mode

Start-up and shutdown are controlled by the EN input. This input features precision thresholds, allowing the use of an external voltage divider to provide an adjustable input UVLO. Applying a voltage of greater than or equal to 1.14 V causes the device to enter Standby mode, powering the internal LDO, but not producing an output voltage. Increasing the EN voltage to 1.231 V (typical) fully enables the device, allowing it to enter Start-up mode

and start the soft-start period. When the EN input is brought below 1.121 V (110-mV hysteresis), the regulator stops running and enters Standby mode. Further decrease in the EN voltage to below 0.3 V completely shuts down the device.

8.4.3 Shutdown Mode

The EN pin provides ON and OFF control for the TPSM5601R5. When V_{EN} is below the EN low threshold, the device is in shutdown mode. Both the internal LDO and the switching regulator are off. The quiescent current in shutdown mode drops to 5 μ A at $V_{IN} = 24$ V.

9 Applications and Implementation

注

Information in the following applications sections is not part of the TI component specification, and TI does not warrant its accuracy or completeness. TI's customers are responsible for determining suitability of components for their purposes, as well as validating and testing their design implementation to confirm system functionality.

9.1 Application Information

The TPSM5601R5 only requires a few external components to convert from a wide range of supply voltages to a fixed output voltage. To expedite and streamline the process of designing a TPSM5601R5, WEBENCH® online software is available to generate complete designs, leveraging iterative design procedures and access to comprehensive component databases. The following section describes the design procedure to configure the TPSM5601R5 power module.

As mentioned previously, the TPSM5601R5 also integrates several optional features to meet system design requirements, including precision enable, UVLO, and PGOOD indicator. The application circuit detailed below shows TPSM5601R5 configuration options suitable for several application use cases. Refer to the [TPSM5601R5EVM User's Guide](#) for more detail.

9.2 Typical Application

☒ 9-1 shows the schematic diagram of a 24-V input, 5-V output, 1.5-A converter.

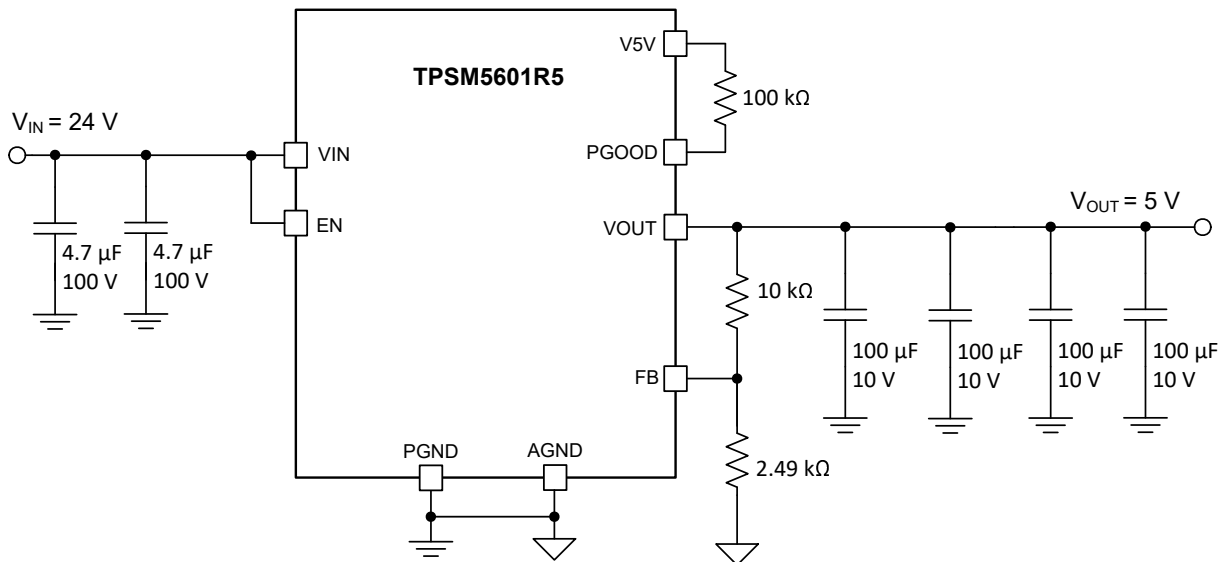

☒ 9-1. TPSM5601R5 Typical Schematic

9.2.1 Design Requirements

For this design example, use the parameters listed in 表 9-1 as the input parameters and follow the design procedures in セクション 9.2.2.

表 9-1. Design Example Parameters

DESIGN PARAMETER	VALUE
Input voltage V_{IN}	24 V typical
Output voltage V_{OUT}	5 V
Output current rating	1.5 A

9.2.2 Detailed Design Procedure

9.2.2.1 Custom Design With WEBENCH® Tools

[Click here](#) to create a custom design using the TPSM5601R5 device with the WEBENCH® Power Designer.

1. Start by entering the input voltage (V_{IN}), output voltage (V_{OUT}), and output current (I_{OUT}) requirements.
2. Optimize the design for key parameters such as efficiency, footprint, and cost using the optimizer dial.
3. Compare the generated design with other possible solutions from Texas Instruments.

The WEBENCH Power Designer provides a customized schematic along with a list of materials with real-time pricing and component availability.

In most cases, these actions are available:

- Run electrical simulations to see important waveforms and circuit performance.
- Run thermal simulations to understand board thermal performance.
- Export customized schematic and layout into popular CAD formats.
- Print PDF reports for the design, and share the design with colleagues.

Get more information about WEBENCH tools at www.ti.com/WEBENCH.

9.2.2.2 Output Voltage Setpoint

The output voltage of the TPSM5601R5 device is externally adjustable using a resistor divider. The recommended value of R_{FBT} is 10 k Ω . The value for R_{FBB} can be selected from [表 8-1](#) or calculated using [式 2](#):

$$R_{FBB} = \frac{1.0}{V_{OUT} - 1.0} \times R_{FBT} \quad (2)$$

For the desired output voltage of 5 V, the formula yields a value of 2.5 k Ω . Choose the closest available standard value of 2.49 k Ω for R_{FBB} .

9.2.2.3 Input Capacitors

The TPSM5601R5 requires a minimum input capacitance of $2 \times 4.7\text{-}\mu\text{F}$ ceramic type. High-quality ceramic type X5R or X7R capacitors with sufficient voltage rating are recommended. The voltage rating of input capacitors must be greater than the maximum input voltage.

For this design, $2 \times 4.7\text{-}\mu\text{F}$, 100-V ceramic capacitors are selected.

9.2.2.4 Output Capacitor Selection

The TPSM5601R5 requires a minimum amount of output capacitance for proper operation. The minimum amount of required output varies depending on the output voltage. See [图 8-2](#) for the required output capacitance. Additional output capacitance can be added to reduce ripple voltage or for applications with transient load requirements.

For this design example, $4 \times 100\text{-}\mu\text{F}$, 10-V, ceramic capacitors are used.

9.2.2.5 Power Good Signal

Applications requiring a power good signal to indicate that the output voltage is present and in regulation must use a pullup resistor between the PGOOD pin and a valid voltage source.

For this design a 100-k Ω resistor is placed between the PGOOD pin and the V5V pin (the internal 5-V LDO output).

9.2.3 Application Curves

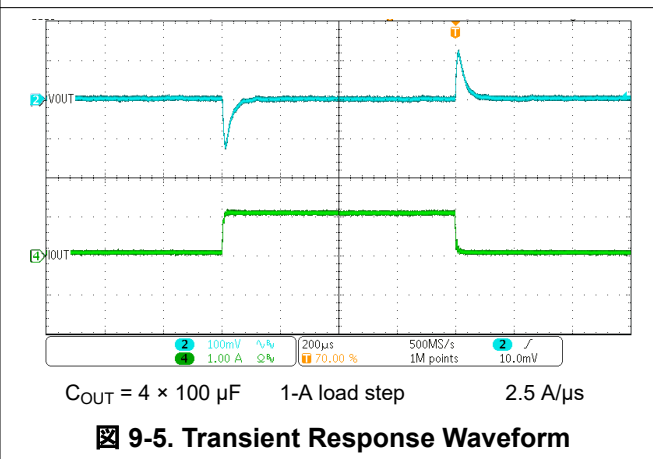
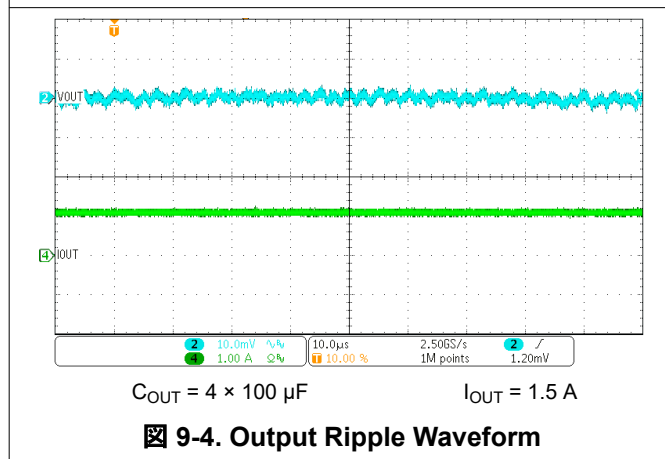
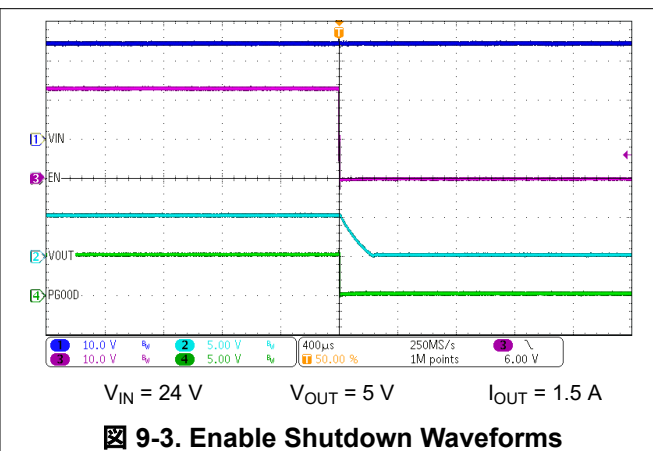
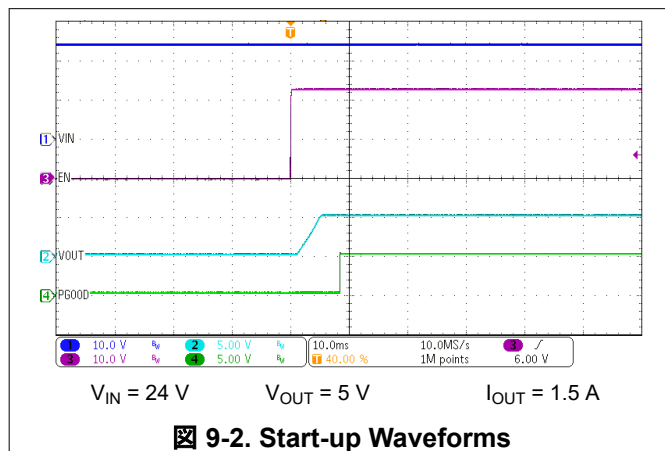

10 Power Supply Recommendations

The TPSM5601R5 is designed to operate from an input voltage supply range between 4.2 V and 60 V. This input supply must be able to provide the maximum input current and maintain a voltage above the set UVLO voltage. Ensure that the resistance of the input supply rail is low enough that an input current transient does not cause a high enough drop at the TPSM5601R5 supply rail to cause a false UVLO fault triggering and system reset. If the input supply is located more than a few inches from the TPSM5601R5, additional bulk capacitance can be required in addition to the ceramic input capacitance. A 47- μF electrolytic capacitor is a typical choice for this function, whereby the capacitor ESR provides a level of damping against input filter resonances. A typical ESR of 0.5 Ω provides enough damping for most input circuit configurations.

11 Layout

The performance of any switching power supply depends as much upon the layout of the PCB as the component selection. Use the following guidelines to design a PCB with the best power conversion performance, optimal thermal performance, and minimal generation of unwanted EMI.

11.1 Layout Guidelines

To achieve optimal electrical and thermal performance, an optimized PCB layout is required. [Fig 11-1](#) and [Fig 11-2](#) show a typical PCB layout. Some considerations for an optimized layout are:

- Use large copper areas for power planes (VIN, VOUT, and PGND) to minimize conduction loss and thermal stress.
- *Connect all PGND pins together using copper plane.*
- Connect AGND pin to the PGND copper at a single point near the pin.
- Place ceramic input and output capacitors close to the device pins to minimize high frequency noise.
- Locate additional output capacitors between the ceramic capacitor and the load.
- Place R_{FBT} and R_{FBB} as close as possible to their respective pins.
- Use multiple vias to connect the power planes to internal layers.

11.2 Layout Example

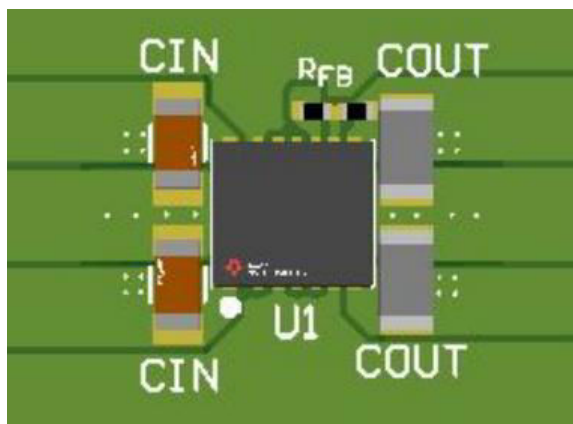

Fig 11-1. Typical Layout

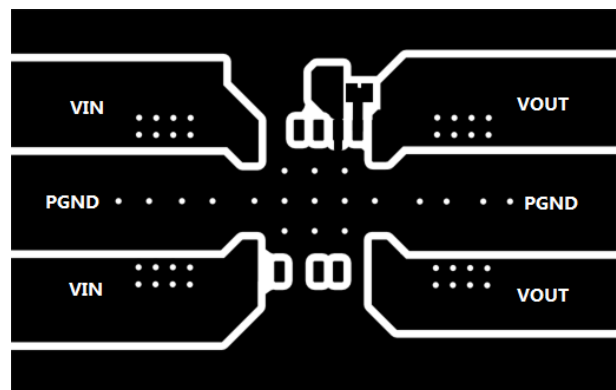

Fig 11-2. Typical Top-Layer

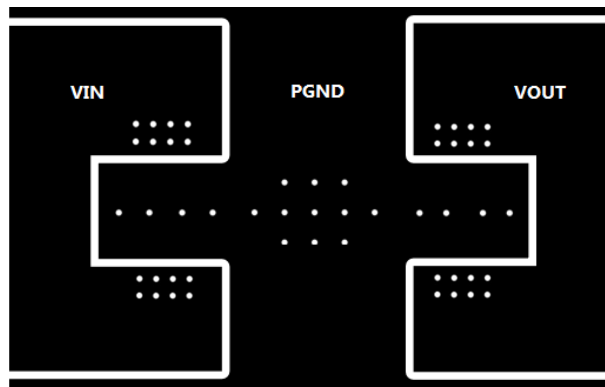

Fig 11-3. Typical Mid-Layer

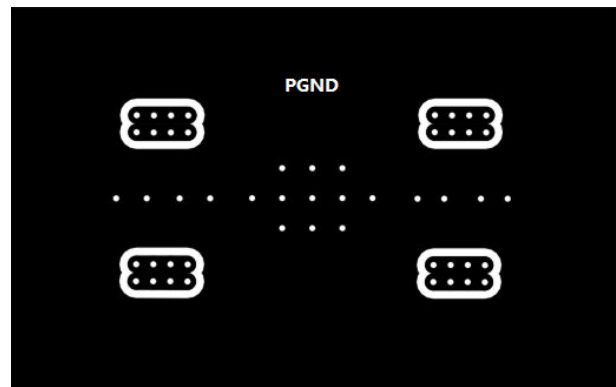

Fig 11-4. Typical PGND-Layer

11.2.1 Theta JA Versus PCB Area

The amount of PCB copper as well as airflow effects the thermal performance of the device. [Figure 11-5](#) shows the effects of copper area and airflow on the junction-to-ambient thermal resistance ($R_{\theta JA}$) of the TPSM5601R5. The junction-to-ambient thermal resistance versus PCB area is plotted for a 4-layer PCB.

To determine the required copper area for an application:

1. Determine the maximum power dissipation of the device in the application by referencing the power dissipation graphs in the *Typical Characteristics*.
2. Calculate the maximum θ_{JA} using [Equation 3](#) and the maximum ambient temperature of the application.

$$\theta_{JA} = \frac{(125^{\circ}\text{C} - T_{A(\text{max})})}{P_{D(\text{max})}} \quad (^{\circ}\text{C}/\text{W}) \quad (3)$$

3. Reference [Figure 11-5](#) to determine the minimum required PCB area for the application conditions.



图 11-5. θ_{JA} vs PCB Area

11.2.2 Package Specifications

表 11-1. Package Specifications Table

TPSM5601R5		VALUE	UNIT
Weight		429	mg
Flammability	Meets UL 94 V-O		
MTBF Calculated Reliability	Per Bellcore TR-332, 50% stress, $T_A = 40^{\circ}\text{C}$, ground benign	87.7	MHrs

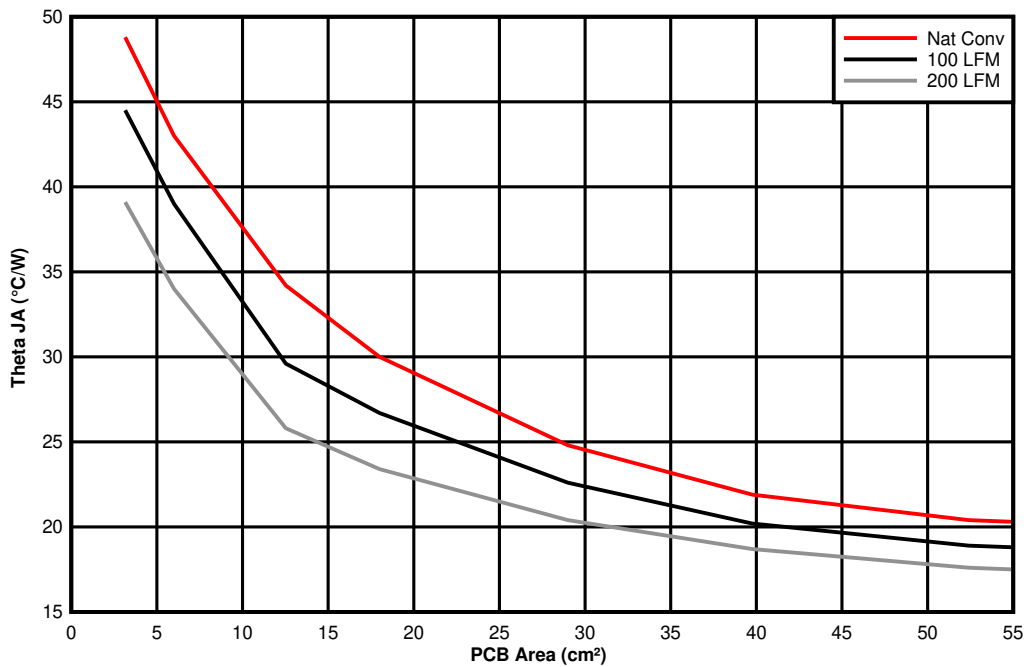
11.2.3 EMI

The TPSM5601R5 is compliant with EN55011 radiated emissions. [Figure 11-6](#) through [Figure 11-9](#) show typical examples of radiated emission plots for the TPSM5601R5H (1.5-A, 1-MHz version). Expect similar results for the TPSM5601R5. The graphs include the plots of the antenna in the horizontal and vertical positions.

11.2.3.1 EMI Plots

EMI plots were measured using the standard TPSM5601R5HEVM.

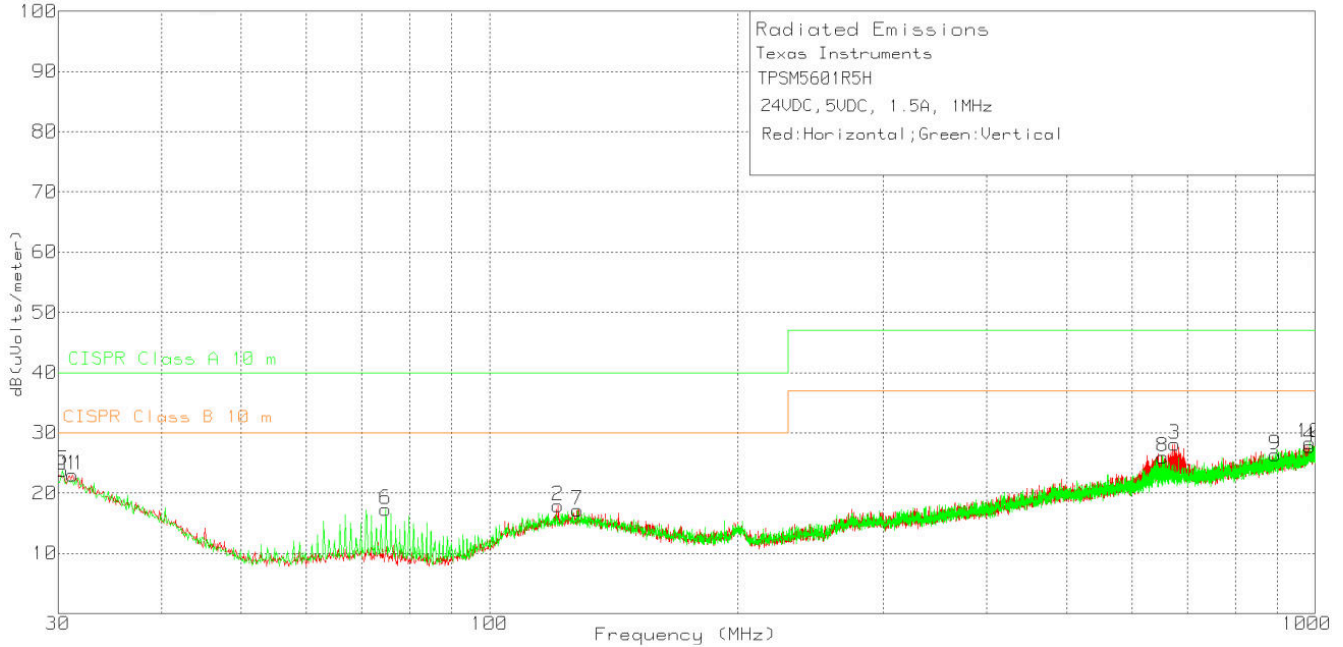

Figure 11-6. Radiated Emissions 24-V Input, 5-V Output, 1.5-A Load

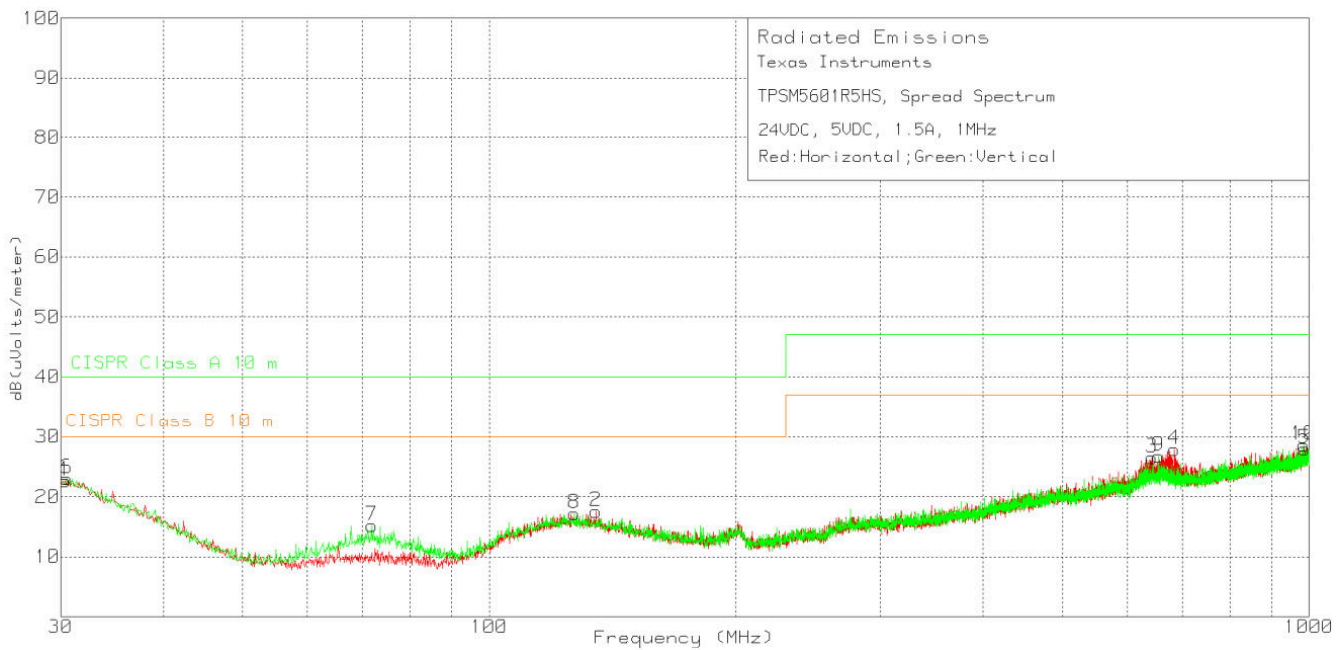
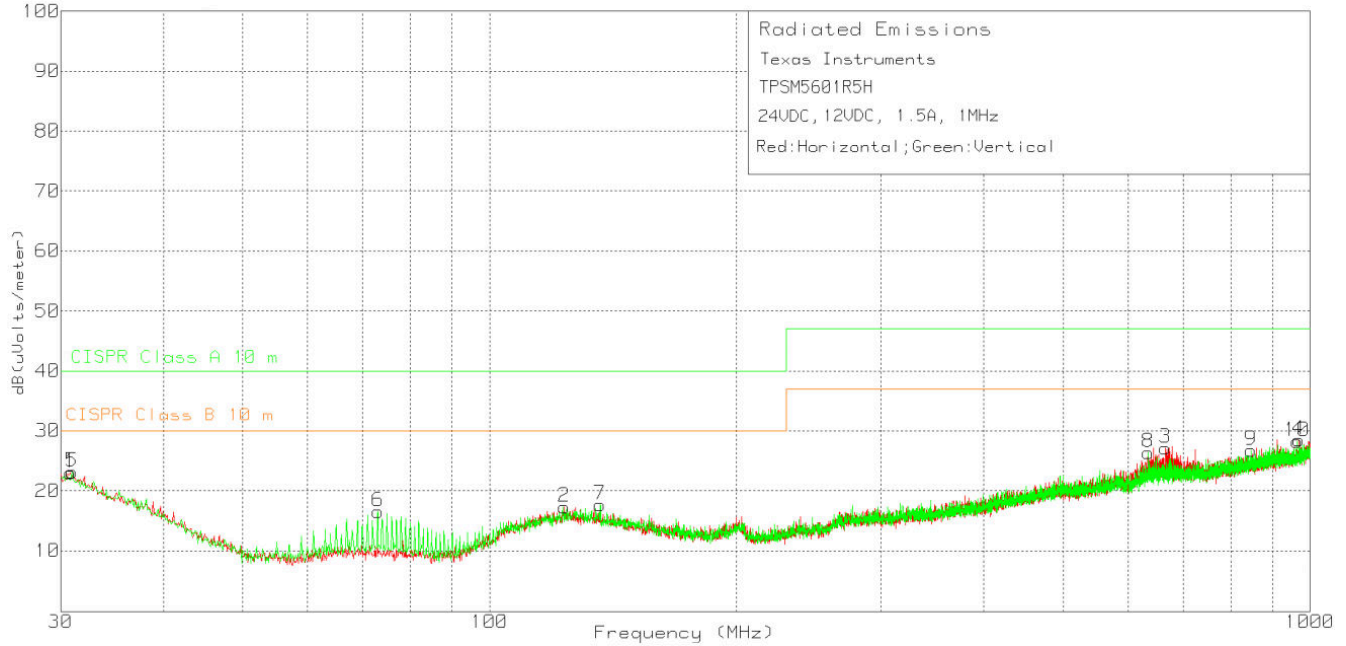
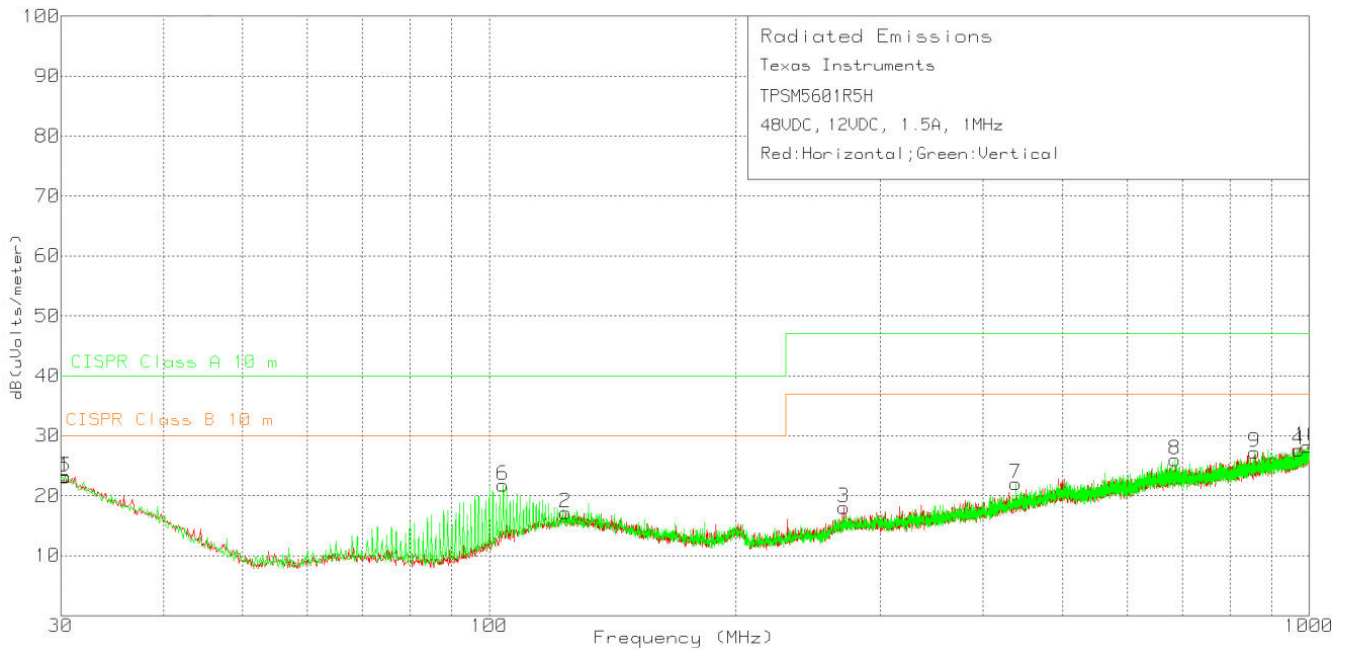

Figure 11-7. Radiated Emissions 24-V Input, 5-V Output, 1.5-A Load (Spread Spectrum)



☒ 11-8. Radiated Emissions 24-V Input, 12-V Output, 1.5-A Load



☒ 11-9. Radiated Emissions 48-V Input, 12-V Output, 1.5-A Load

12 Device and Documentation Support

12.1 Device Support

12.1.1 Third-Party Products Disclaimer

TI'S PUBLICATION OF INFORMATION REGARDING THIRD-PARTY PRODUCTS OR SERVICES DOES NOT CONSTITUTE AN ENDORSEMENT REGARDING THE SUITABILITY OF SUCH PRODUCTS OR SERVICES OR A WARRANTY, REPRESENTATION OR ENDORSEMENT OF SUCH PRODUCTS OR SERVICES, EITHER ALONE OR IN COMBINATION WITH ANY TI PRODUCT OR SERVICE.

12.1.2 Development Support

For development support, see the following:

- For TI's reference design library, visit [TI Designs](#).
- To view a related device of this product, see the [TPSM5601R5Hx](#).

12.1.2.1 Custom Design With WEBENCH® Tools

[Click here](#) to create a custom design using the TPSM5601R5 device with WEBENCH® Power Designer.

1. Start by entering the input voltage (V_{IN}), output voltage (V_{OUT}), and output current (I_{OUT}) requirements.
2. Optimize the design for key parameters such as efficiency, footprint, and cost using the optimizer dial.
3. Compare the generated design with other possible solutions from Texas Instruments.

The WEBENCH Power Designer provides a customized schematic along with a list of materials with real-time pricing and component availability.

In most cases, these actions are available:

- Run electrical simulations to see important waveforms and circuit performance.
- Run thermal simulations to understand board thermal performance.
- Export customized schematic and layout into popular CAD formats.
- Print PDF reports for the design, and share the design with colleagues.

Get more information about WEBENCH tools at www.ti.com/WEBENCH.

12.2 Documentation Support

12.2.1 Related Documentation

For related documentation, see the following:

- Texas Instruments, [TPSM5601R5EVM User's Guide](#)
- Texas Instruments, [Using the TPSM5601R5Hx in an Inverting Buck-Boost Topology Application Report](#)
- Texas Instruments, [Using New Thermal Metrics Application Report](#)
- Texas Instruments, [Semiconductor and IC Package Thermal Metrics Application Report](#)

12.3 Receiving Notification of Documentation Updates

To receive notification of documentation updates, navigate to the device product folder on ti.com. Click on *Subscribe to updates* to register and receive a weekly digest of any product information that has changed. For change details, review the revision history included in any revised document.

12.4 サポート・リソース

TI E2E™ サポート・フォーラムは、エンジニアが検証済みの回答と設計に関するヒントをエキスパートから迅速かつ直接得ることができる場所です。既存の回答を検索したり、独自の質問をしたりすることで、設計に必要な支援を迅速に得ることができます。

リンクされているコンテンツは、該当する貢献者により、現状のまま提供されるものです。これらは TI の仕様を構成するものではなく、必ずしも TI の見解を反映したものではありません。TI の[使用条件](#)を参照してください。

12.5 Trademarks

HotRod™ and TI E2E™ are trademarks of Texas Instruments.

WEBENCH® is a registered trademark of Texas Instruments.

すべての商標は、それぞれの所有者に帰属します。

12.6 Electrostatic Discharge Caution



This integrated circuit can be damaged by ESD. Texas Instruments recommends that all integrated circuits be handled with appropriate precautions. Failure to observe proper handling and installation procedures can cause damage.

ESD damage can range from subtle performance degradation to complete device failure. Precision integrated circuits may be more susceptible to damage because very small parametric changes could cause the device not to meet its published specifications.

12.7 Glossary

[TI Glossary](#) This glossary lists and explains terms, acronyms, and definitions.

13 Mechanical, Packaging, and Orderable Information

The following pages include mechanical packaging and orderable information. This information is the most current data available for the designated devices. This data is subject to change without notice and revision of this document. For browser-based versions of this datasheet, refer to the left-hand navigation.

PACKAGING INFORMATION

Orderable Device	Status (1)	Package Type	Package Drawing	Pins	Package Qty	Eco Plan (2)	Lead finish/ Ball material (6)	MSL Peak Temp (3)	Op Temp (°C)	Device Marking (4/5)	Samples
TPSM5601R5RDAR	ACTIVE	B3QFN	RDA	15	1000	RoHS & Green	NIPDAU	Level-3-245C-168 HR	-40 to 125	5601R5	Samples
TPSM5601R5SRDAR	ACTIVE	B3QFN	RDA	15	1000	RoHS & Green	NIPDAU	Level-3-245C-168 HR	-40 to 125	5601R5S	Samples

(1) The marketing status values are defined as follows:

ACTIVE: Product device recommended for new designs.

LIFEBUY: TI has announced that the device will be discontinued, and a lifetime-buy period is in effect.

NRND: Not recommended for new designs. Device is in production to support existing customers, but TI does not recommend using this part in a new design.

PREVIEW: Device has been announced but is not in production. Samples may or may not be available.

OBSOLETE: TI has discontinued the production of the device.

(2) **RoHS:** TI defines "RoHS" to mean semiconductor products that are compliant with the current EU RoHS requirements for all 10 RoHS substances, including the requirement that RoHS substance do not exceed 0.1% by weight in homogeneous materials. Where designed to be soldered at high temperatures, "RoHS" products are suitable for use in specified lead-free processes. TI may reference these types of products as "Pb-Free".

RoHS Exempt: TI defines "RoHS Exempt" to mean products that contain lead but are compliant with EU RoHS pursuant to a specific EU RoHS exemption.

Green: TI defines "Green" to mean the content of Chlorine (Cl) and Bromine (Br) based flame retardants meet JS709B low halogen requirements of <=1000ppm threshold. Antimony trioxide based flame retardants must also meet the <=1000ppm threshold requirement.

(3) MSL, Peak Temp. - The Moisture Sensitivity Level rating according to the JEDEC industry standard classifications, and peak solder temperature.

(4) There may be additional marking, which relates to the logo, the lot trace code information, or the environmental category on the device.

(5) Multiple Device Markings will be inside parentheses. Only one Device Marking contained in parentheses and separated by a "~" will appear on a device. If a line is indented then it is a continuation of the previous line and the two combined represent the entire Device Marking for that device.

(6) Lead finish/Ball material - Orderable Devices may have multiple material finish options. Finish options are separated by a vertical ruled line. Lead finish/Ball material values may wrap to two lines if the finish value exceeds the maximum column width.

Important Information and Disclaimer:The information provided on this page represents TI's knowledge and belief as of the date that it is provided. TI bases its knowledge and belief on information provided by third parties, and makes no representation or warranty as to the accuracy of such information. Efforts are underway to better integrate information from third parties. TI has taken and continues to take reasonable steps to provide representative and accurate information but may not have conducted destructive testing or chemical analysis on incoming materials and chemicals. TI and TI suppliers consider certain information to be proprietary, and thus CAS numbers and other limited information may not be available for release.

In no event shall TI's liability arising out of such information exceed the total purchase price of the TI part(s) at issue in this document sold by TI to Customer on an annual basis.

RDA0015A

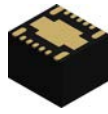

PACKAGE OUTLINE

B3QFN - 4.1 mm max height

PLASTIC QUAD FLATPACK - NO LEAD

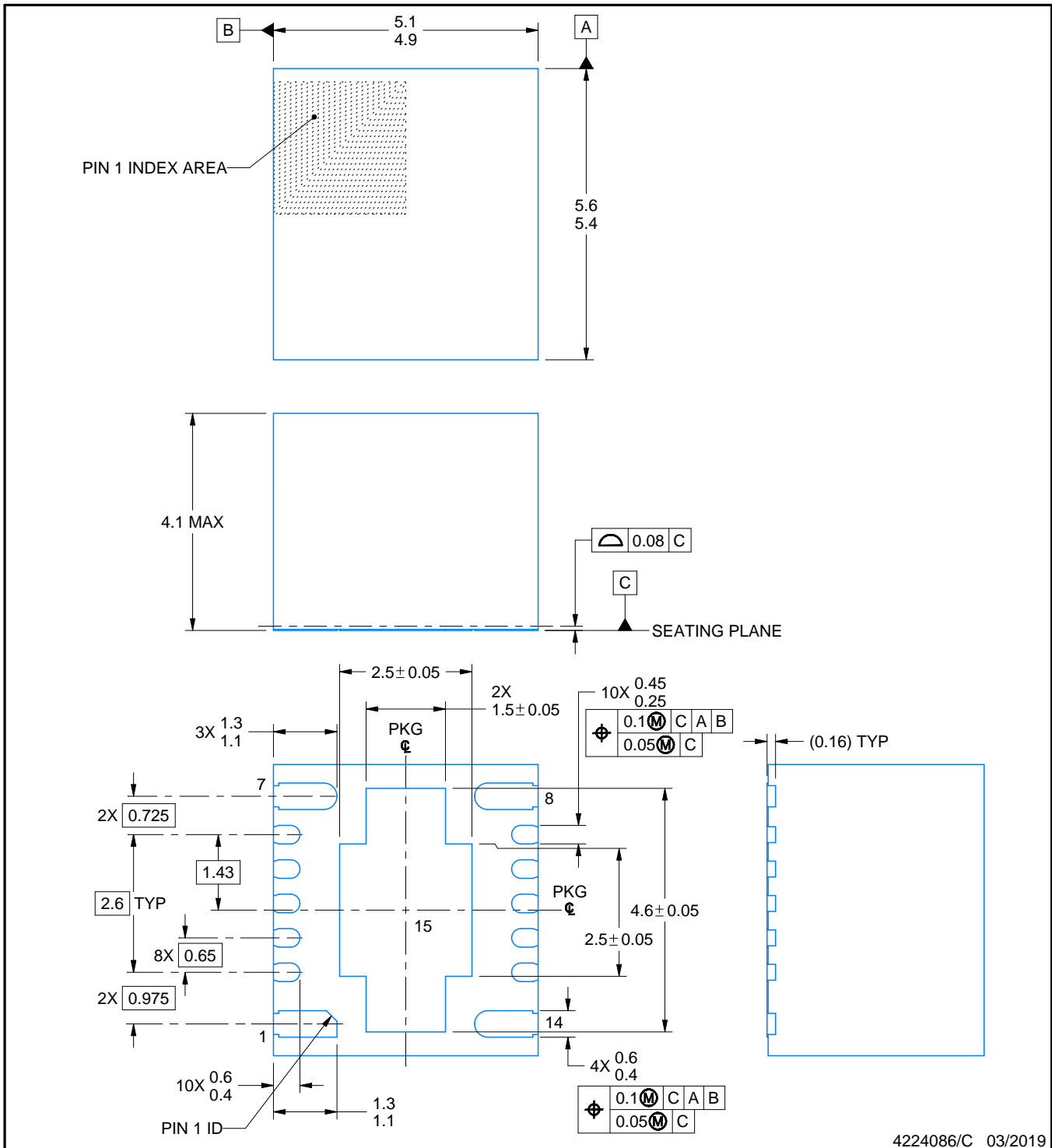

NOTES:

1. All linear dimensions are in millimeters. Any dimensions in parenthesis are for reference only. Dimensioning and tolerancing per ASME Y14.5M.
2. This drawing is subject to change without notice.
3. The package thermal pad must be soldered to the printed circuit board for optimal thermal and mechanical performance.

EXAMPLE BOARD LAYOUT

RDA0015A

B3QFN - 4.1 mm max height

PLASTIC QUAD FLATPACK - NO LEAD

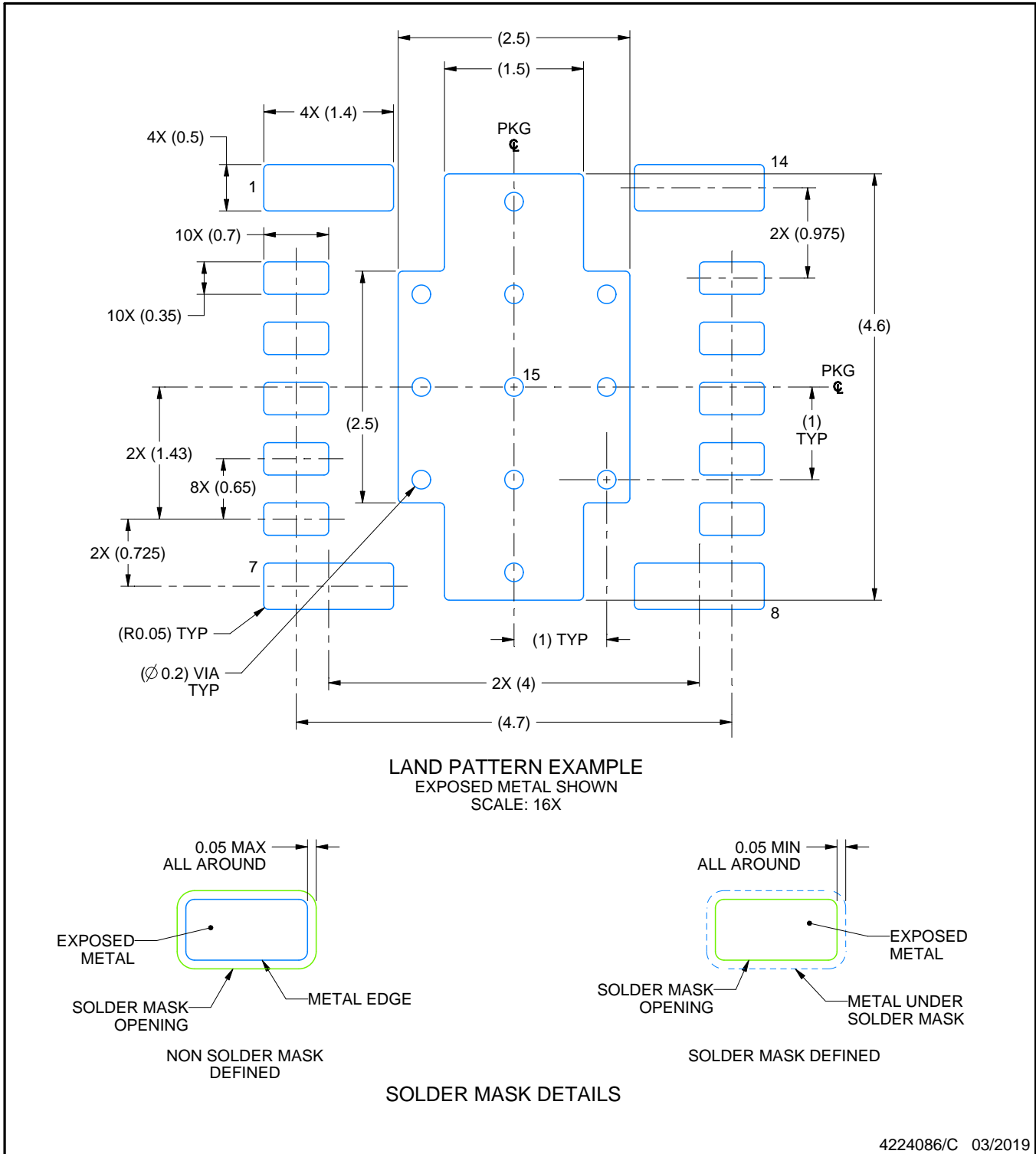

NOTES: (continued)

4. This package is designed to be soldered to a thermal pad on the board. For more information, see Texas Instruments literature number SLUA271 (www.ti.com/lit/sluea271).
5. Vias are optional depending on application, refer to device data sheet. If any vias are implemented, refer to their locations shown on this view. It is recommended that vias under paste be filled, plugged or tented.

EXAMPLE STENCIL DESIGN

RDA0015A

B3QFN - 4.1 mm max height

PLASTIC QUAD FLATPACK - NO LEAD

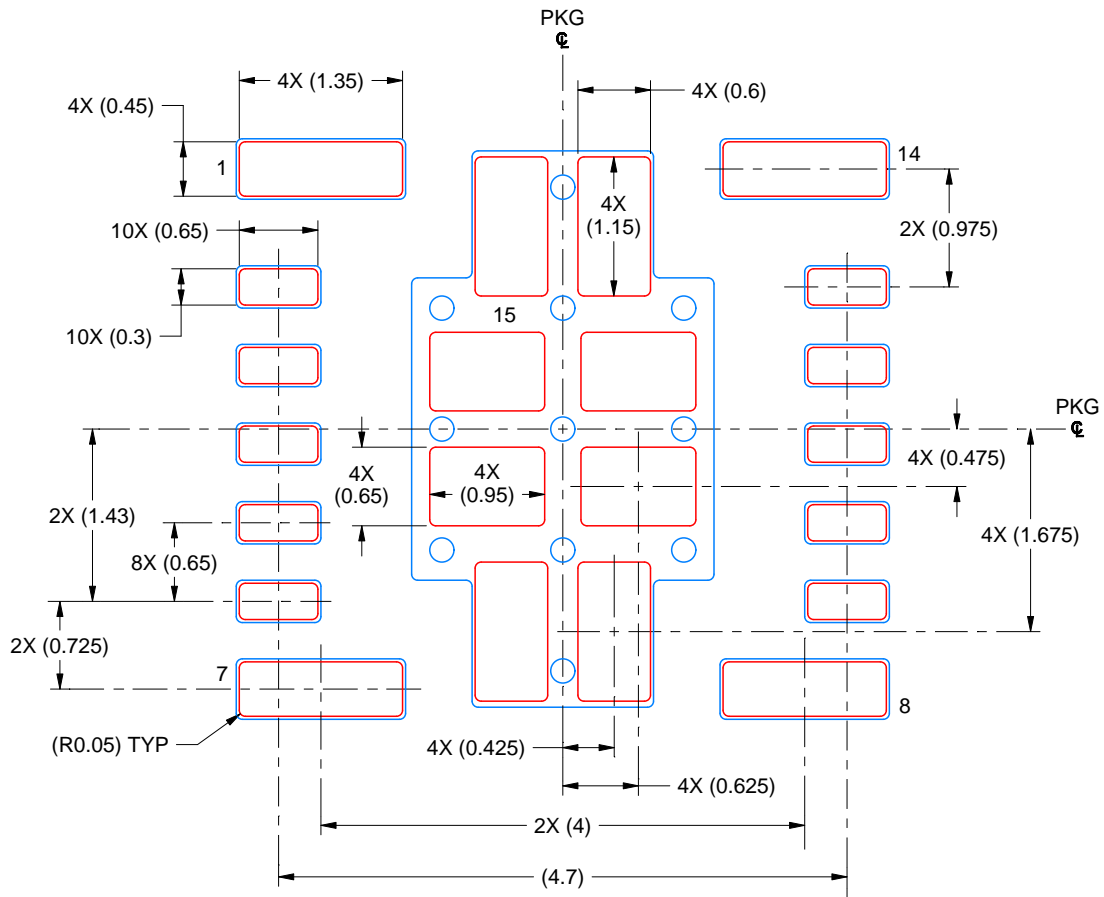

SOLDER PASTE EXAMPLE
BASED ON 0.125 mm THICK STENCIL

EXPOSED PAD 15:
56% PRINTED SOLDER COVERAGE BY AREA
SCALE: 16X

4224086/C 03/2019

NOTES: (continued)

6. Laser cutting apertures with trapezoidal walls and rounded corners may offer better paste release. IPC-7525 may have alternate design recommendations.

重要なお知らせと免責事項

TI は、技術データと信頼性データ (データシートを含みます)、設計リソース (リファレンス・デザインを含みます)、アプリケーションや設計に関する各種アドバイス、Web ツール、安全性情報、その他のリソースを、欠陥が存在する可能性のある「現状のまま」提供しており、商品性および特定目的に対する適合性の黙示保証、第三者の知的財産権の非侵害保証を含むいかなる保証も、明示的または黙示的にかかわらず拒否します。

これらのリソースは、TI 製品を使用する設計の経験を積んだ開発者への提供を意図したものです。(1) お客様のアプリケーションに適した TI 製品の選定、(2) お客様のアプリケーションの設計、検証、試験、(3) お客様のアプリケーションに該当する各種規格や、その他のあらゆる安全性、セキュリティ、規制、または他の要件への確実な適合に関する責任を、お客様のみが単独で負うものとし、

上記の各種リソースは、予告なく変更される可能性があります。これらのリソースは、リソースで説明されている TI 製品を使用するアプリケーションの開発の目的でのみ、TI はその使用をお客様に許諾します。これらのリソースに関して、他の目的で複製することや掲載することは禁止されています。TI や第三者の知的財産権のライセンスが付与されている訳ではありません。お客様は、これらのリソースを自身で使用した結果発生するあらゆる申し立て、損害、費用、損失、責任について、TI およびその代理人を完全に補償するものとし、TI は一切の責任を拒否します。

TI の製品は、[TI の販売条件](#)、または [ti.com](https://www.ti.com) やかかる TI 製品の関連資料などのいずれかを通じて提供する適用可能な条項の下で提供されています。TI がこれらのリソースを提供することは、適用される TI の保証または他の保証の放棄の拡大や変更を意味するものではありません。

お客様がいかなる追加条項または代替条項を提案した場合でも、TI はそれらに異議を唱え、拒否します。

郵送先住所 : Texas Instruments, Post Office Box 655303, Dallas, Texas 75265
Copyright © 2023, Texas Instruments Incorporated