

# TPSM82903、3-A、3V~17V、高効率の低 $I_Q$ 降圧コンバータ・モジュール、MicroSiP™ パッケージで供給、インダクタ内蔵

## 1 特長

- 高効率で、広いデューティ・サイクルと広い負荷範囲に対応
  - $I_Q$ : 4 $\mu$ A (標準値)
  - 62m $\Omega$  ハイサイドおよび 22m $\Omega$  ローサイド  $R_{DS(ON)}$
- 3mm × 2.8mm × 1.6mm の MicroSiP™ パッケージ
- 最大 3A の連続出力電流
- 40°C ~ 125°C の範囲で  $\pm 0.9\%$  の帰還電圧精度
- 構成可能な出力電圧:
  - $V_{FB}$  外部分圧器: 0.6V ~ 5.5V
  - $V_{SET}$  内部分圧器: 0.4V ~ 5.5V の 16 通りの選択肢
- 100% モードを備えた DCS-Control トポロジ
- MODE/S-CONF ピンによる優れた柔軟性
  - 2.5MHz または 1.0MHz のスイッチング周波数
  - 強制 PWM または自動 PFM パワー・セーブ・モード (動的モード変更機能付き)
  - 自動効率向上 (AEE)
  - 出力放電のオン/オフ
- きわめてフレキシブルで優れた使いやすさ
  - 単層ルーティング用に最適化されたピン配置
  - 高精度イネーブル入力
  - パワー・グッド出力
  - 可変ソフトスタートおよびトラッキング
- 外部ブートストラップ・コンデンサ不要
- WEBENCH® Power Designer により、TPSM82903 を使用するカスタム設計を作成

## 2 アプリケーション

- データ・センターおよびエンタープライズ・コンピューティング
- 有線ネットワーク
- ワイヤレス・インフラ
- ファクトリ・オートメーション / 制御
- 試験 / 測定機器

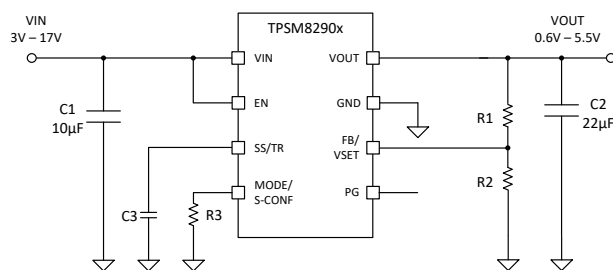

概略回路図

## 3 概要

TPSM82903 は、使いやすく、高効率、小型、フレキシブルな同期整流降圧 DC/DC コンバータ MicroSiP パッケージ・モジュールです。スイッチング周波数は 2.5MHz または 1.0MHz を選択可能で、小型の部品を使用でき、高速な過渡応答を実現します。このデバイスは、DCS-Control トポロジにより  $\pm 1\%$  の高い  $V_{OUT}$  精度をサポートしています。3V ~ 17V の広い入力電圧レンジで動作するため、12V 電源レール、シングル・セルまたはマルチ・セルのリチウムイオン、5V または 3.3V レールなど、各種の公称入力に対応します。

TPSM82903 は、軽負荷時には自動的にパワー・セーブ・モードに移行し (自動 PFM/PWM 選択時)、高効率を維持します。また、非常に小さな負荷でも高い効率を実現するため、標準的な静止電流は 4 $\mu$ A と低くなっています。AEE がイネーブルの場合、 $V_{IN}$ 、 $V_{OUT}$ 、負荷電流の全体にわたる高効率を実現します。このデバイスは、内部 / 外部分圧器、スイッチング周波数、出力電圧放電、自動パワー・セーブ・モードまたは強制 PWM 動作を設定する MODE/Smart-CONF 入力を備えています。

このデバイスは、3.0mm × 2.8mm × 1.6mm の小型 11 ピン MicroSiP パッケージで供給され、1 $\mu$ H インダクタが内蔵されています。

### パッケージ情報

部品番号	パッケージ (1)	本体サイズ (公称)
TPSM82903	SIS (uSiP, 11)	3.00mm × 2.80mm

- (1) 利用可能なパッケージについては、このデータシートの末尾にある注文情報を参照してください。

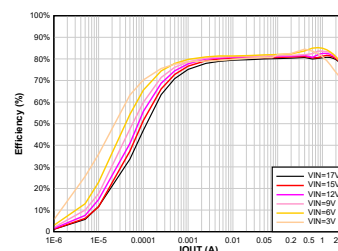

効率と出力電流との関係 ( $V_O = 1.2V$ 、2.5MHz の自動 PFM/PWM 時)



## Table of Contents

<b>1 特長</b> .....	1	7.4 Device Functional Modes.....	14
<b>2 アプリケーション</b> .....	1	<b>8 Application and Implementation</b> .....	17
<b>3 概要</b> .....	1	8.1 Application Information.....	17
<b>4 Revision History</b> .....	2	8.2 Typical Application with Adjustable Output Voltage..	17
<b>5 Pin Configuration and Functions</b> .....	3	8.3 Typical Application with Settable V <sub>O</sub> Using VSET ....	29
<b>6 Specifications</b> .....	4	8.4 Power Supply Recommendations.....	32
6.1 Absolute Maximum Ratings.....	4	8.5 Layout.....	32
6.2 ESD Ratings.....	4	<b>9 Device and Documentation Support</b> .....	35
6.3 Recommended Operating Conditions.....	4	9.1 Device Support.....	35
6.4 Thermal Information.....	5	9.2 Receiving Notification of Documentation Updates....	35
6.5 Electrical Characteristics.....	5	9.3 サポート・リソース.....	35
6.6 Typical Characteristics.....	7	9.4 Trademarks.....	35
<b>7 Detailed Description</b> .....	8	9.5 Electrostatic Discharge Caution.....	35
7.1 Overview.....	8	9.6 Glossary.....	35
7.2 Functional Block Diagram.....	8	<b>10 Mechanical, Packaging, and Orderable Information</b> .....	36
7.3 Feature Description.....	9		

## 4 Revision History

資料番号末尾の英字は改訂を表しています。その改訂履歴は英語版に準じています。

### Changes from Revision A (October 2022) to Revision B (November 2022) Page

- ステータスを「事前情報」から「量産データ」に変更..... 1

### Changes from Revision \* (February 2022) to Revision A (October 2022) Page

- ドキュメント全体を通して商標の情報を更新..... 1
- 「パッケージ情報」の表のパッケージを「uSiP(11)」から「SIS (uSiP、11)」に更新..... 1
- Added Peak reflow case temperature..... 4
- Added Maximum number of reflows allowed..... 4
- Added Mil-STD-883D, Method 2002.3, 1 msec, 1/2 sine, mounted..... 4
- Added Mil-STD-883D, Method 2007.2, 20 to 2000 Hz..... 4
- Updated [図 8-4](#) “SW” pin to “VOOUT” pin to reflect accurate pin name..... 19

## 5 Pin Configuration and Functions



图 5-1. 11-Pin SIS MicroSIP™ Package (Top View, Device Pins Face Down)

表 5-1. Pin Functions

Pin		I/O	Description
Name	Number		
VIN	1, 2	I	Power supply input pin. Ensure the input capacitor is connected as close as possible between the VIN and GND pins.
EN	3	I	Enable input pin. Connect to logic low to disable the device. Pull high to enable the device. Do not leave this pin unconnected.
MODE/ S-CONF	4	I	Device mode selection (auto PFM/PWM or forced PWM operation) and SmartConfig™ application. Connect high, low, or to a resistor to configure the device according to 表 7-2. Do not leave this pin unconnected.
SS/TR	5	I	Soft start/tracking pin. An external capacitor connected from this pin to GND defines the rise time for the internal reference voltage. The pin can also be used as an input for tracking and sequencing. The pin can be left floating for the fastest ramp-up time.
PG	6	O	Open-drain power-good output. High = $V_{OUT}$ is ready. Low = $V_{OUT}$ is below nominal regulation. This pin requires a pullup resistor.
FB/VSET	7	I	Depends on device configuration (see セクション 7.3.1) <ul style="list-style-type: none"> <li>• FB: Voltage feedback input. Connect a resistive output voltage divider to this pin.</li> <li>• VSET: Output voltage setting pin. Connect a resistor to GND to choose the output voltage according to 表 7-3.</li> </ul>
SW/NC	8	NC	Switch pin of the converter. Do not connect, leave floating.
VOUT	9, 10	O	Output voltage pin. Connect directly to the positive pin of the output capacitor.
GND	11	—	Ground pin. It must be connected directly to the common ground plane. It must be soldered to achieve appropriate power dissipation and mechanical reliability.

## 6 Specifications

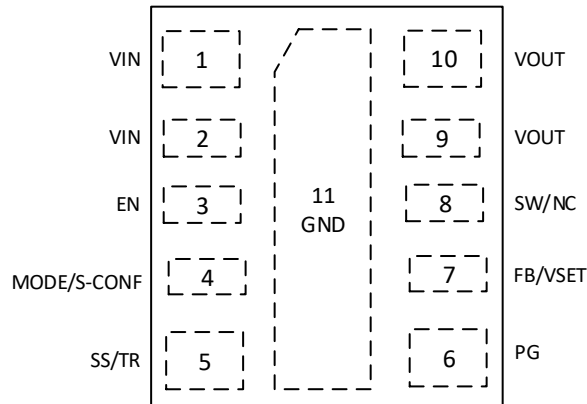
### 6.1 Absolute Maximum Ratings

over operating temperature range (unless otherwise noted)<sup>(1)</sup>

		MIN	MAX	UNIT
Voltage <sup>(2)</sup>	VIN	-0.3	18	V
	EN, PG	-0.3	18	
	MODE/S-CONF	-0.3	18	
	FB/VSET, SS/TR, VOUT	-0.3	6	
T <sub>J</sub>	Junction temperature	-55	125	°C
	Peak reflow case temperature		260	°C
	Maximum number of reflows allowed		3	
Mechanical shock	Mil-STD-883D, Method 2002.3, 1 msec, 1/2 sine, mounted		1500	G
Mechanical vibration	Mil-STD-883D, Method 2007.2, 20 to 2000 Hz		20	G
T <sub>stg</sub>	Storage temperature	-55	125	°C

(1) Operation outside the Absolute Maximum Ratings may cause permanent device damage. Absolute Maximum Ratings do not imply functional operation of the device at these or any other conditions beyond those listed under Recommended Operating Conditions. If used outside the Recommended Operating Conditions but within the Absolute Maximum Ratings, the device may not be fully functional, and this may affect device reliability, functionality, performance, and shorten the device lifetime.

(2) All voltage values are with respect to network ground terminal.

### 6.2 ESD Ratings

			VALUE	UNIT
V <sub>(ESD)</sub>	Electrostatic discharge	Human body model (HBM), per ANSI/ESDA/ JEDEC JS-001, all pins <sup>(1)</sup>	±2000	V
		Charged device model (CDM), per ANSI/ESDA/ JEDEC JS-002, all pins <sup>(2)</sup>	±500	

(1) JEDEC document JEP155 states that 500-V HBM allows safe manufacturing with a standard ESD control process.

(2) JEDEC document JEP157 states that 250-V CDM allows safe manufacturing with a standard ESD control process.

### 6.3 Recommended Operating Conditions

Over operating junction temperature range (unless otherwise noted)

		MIN	NOM	MAX	UNIT
V <sub>I</sub>	Input voltage range	3.0		17	V
V <sub>O</sub>	Output voltage range	0.4		5.5	V
C <sub>I</sub>	Effective input capacitance	3	10		µF
C <sub>O</sub>	Effective output capacitance (2.5MHz selection)	10	22	100 <sup>(1)</sup>	µF
C <sub>O</sub>	Effective output capacitance (1.0MHz selection)	6	22	50 <sup>(1)</sup>	µF
I <sub>OUT</sub>	Output current	0		3	A
I <sub>SINK_PG</sub>	Sink current at PG-Pin			1	mA
T <sub>J</sub>	Junction temperature <sup>(2)</sup>	-40		125	°C

(1) This is for capacitors directly at the output of the device. More capacitance is allowed if there is a series resistance associated to the capacitor.

(2) Operating lifetime is derated at junction temperatures greater than 125°C.

## 6.4 Thermal Information

THERMAL METRIC <sup>(1)</sup>		TPSM8290x		UNIT
		uSIP11-Pin		
		JEDEC PCB	TPSM8290xEVM-188	
R <sub>θJA</sub>	Junction-to-ambient thermal resistance	58.2	48.7	°C/W
R <sub>θJC(top)</sub>	Junction-to-case (top) thermal resistance	34.5		°C/W
R <sub>θJB</sub>	Junction-to-board thermal resistance	26.9		°C/W
Ψ <sub>JT</sub>	Junction-to-top characterization parameter	0.3	0.8	°C/W
Ψ <sub>JB</sub>	Junction-to-board characterization parameter	26.6	27.8	°C/W
R <sub>θJC(bot)</sub>	Junction-to-case (bottom) thermal resistance	26.0		°C/W

(1) For more information about traditional and new thermal metrics, see the [Semiconductor and IC Package Thermal Metrics](#) application report.

## 6.5 Electrical Characteristics

V<sub>I</sub> = 3 V to 17 V, T<sub>J</sub> = -40°C to +125°C, Typical values at V<sub>I</sub> = 12.0 V and T<sub>A</sub> = 25°C, unless otherwise noted

PARAMETER		TEST CONDITIONS	MIN	TYP	MAX	UNIT
<b>SUPPLY</b>						
I <sub>Q_PSM</sub>	Operating Quiescent Current (Power Save Mode)	I <sub>out</sub> = 0 mA, device not switching		4		μA
I <sub>Q_PWM</sub>	Operating Quiescent Current (PWM Mode)	V <sub>IN</sub> =12 V, V <sub>OUT</sub> =1.2 V; I <sub>out</sub> = 0 mA, device switching		8		mA
I <sub>SD</sub>	Shutdown current into VIN pin	EN = 0 V		0.27	3.5	μA
V <sub>UVLO</sub>	Under Voltage Lock-Out	V <sub>IN</sub> rising	2.85	2.925	3.0	V
	Under Voltage Lock-Out	V <sub>IN</sub> falling	2.7	2.775	2.85	V
V <sub>UVLO_HYS</sub>	Under Voltage Lock-Out Hysteresis	Hysteresis		150		mV
<b>CONTROL &amp; INTERFACE</b>						
I <sub>LKG</sub>	EN Input leakage current	EN = 12 V		10	300	nA
V <sub>IH_MODE</sub>	High-Level Input Voltage at MODE/S-CONF-Pin		1.0			V
T <sub>SD</sub>	Thermal Shutdown Threshold	T <sub>J</sub> rising		170		°C
	Thermal Shutdown Hysteresis	Hysteresis		20		
V <sub>IH</sub>	High-level input voltage at EN-Pin		0.97	1.0	1.03	V
V <sub>IL</sub>	Low-level input voltage at EN-Pin		0.87	0.9	0.93	V
R <sub>EN_PD</sub>	Smart-Enable Internal Pulldown Resistor	EN = LOW		0.5		MΩ
V <sub>PG</sub>	Power good threshold	V <sub>FB</sub> rising, referenced to V <sub>FB</sub> nominal	93.5%	96%	99%	
		V <sub>FB</sub> falling, referenced to V <sub>FB</sub> nominal	88.5%	93%	96%	
		Hysteresis	1.5%	3.5%	6%	
V <sub>PG_OL</sub>	Low-level output voltage at PG pin	I <sub>SINK</sub> = 1 mA			0.4	V
I <sub>PG_LKG</sub>	Input leakage current into PG pin	V <sub>PG</sub> = 5 V		15	550	nA
t <sub>PG_DLY</sub>	Power good delay time	V <sub>FB</sub> falling		32		μs
R <sub>SET</sub>	S-CONF/VSET Resistor Tolerance		-4		+4	%
C <sub>SET</sub>	Maximum Capacitance connected to S-CONF/VSET Pins				30	pF
<b>POWER SWITCHES</b>						
I <sub>LKG_SW</sub>	Leakage current into SW-Pin	V <sub>SW</sub> = V <sub>OS</sub> = 5.5 V		2	7	μA
R <sub>DS_ON</sub>	High-side FET on resistance	V <sub>IN</sub> > 4 V, I <sub>SW</sub> = 500 mA		62	111	mΩ
	Low-side FET on resistance	V <sub>IN</sub> > 4 V, I <sub>SW</sub> = 500 mA		22	40	

## 6.5 Electrical Characteristics (continued)

$V_I = 3\text{ V to }17\text{ V}$ ,  $T_J = -40^\circ\text{C to }+125^\circ\text{C}$ , Typical values at  $V_I = 12.0\text{ V}$  and  $T_A = 25^\circ\text{C}$ , unless otherwise noted

PARAMETER		TEST CONDITIONS	MIN	TYP	MAX	UNIT
$I_{LIM}$	High-side FET current limit		4.1	4.9	5.8	A
	Low-side FET current limit		3.8	4.3	4.7	A
$I_{LIM\_SINK}$	Low-side FET sink current limit		1.3	1.7	2.5	A
$f_{SW}$	Switching frequency	2.5-MHz selection		2.5		MHz
$T_{ON(MIN)}$	Minimum On-time			50		ns
$f_{SW}$	Switching frequency	1.0-MHz selection		1.0		MHz
D	Dutycycle				1	
$R_{PD}$	Dropout resistance	100% mode, $V_{IN} > 4\text{ V}$		100		m $\Omega$
<b>OUTPUT</b>						
$V_{O\_Reg1}$	Output Voltage Regulation	VSET Configuration selected. $T_J = 25^\circ\text{C}$ .	-0.9%		+0.9%	
$V_{O\_Reg2}$	Output Voltage Regulation	VSET Configuration selected. $0^\circ\text{C} < T_J < 85^\circ\text{C}$	-1.1%		+1.1%	
$V_{O\_Reg3}$	Output Voltage Regulation	VSET Configuration selected. $-40^\circ\text{C} < T_J < 125^\circ\text{C}$	-1.25%		+1.25%	
$V_{FB}$	Feedback Regulation Voltage	Adjustable Configuration selected		0.6		V
$V_{FB\_Reg1}$	Feedback Voltage Regulation	FB-Option selected. $T_J = 25^\circ\text{C}$ .	-0.6%		+0.6%	
$V_{FB\_Reg2}$	Feedback Voltage Regulation	FB-Option selected. $0^\circ\text{C} < T_J < 85^\circ\text{C}$ .	-0.65%		+0.65%	
$V_{FB\_Reg3}$	Feedback Voltage Regulation	FB-Option selected. $-40^\circ\text{C} < T_J < 125^\circ\text{C}$	-0.9%		+0.9%	
$I_{FB}$	Input leakage current into FB pin	Adjustable configuration, $V_{FB} = 0.6\text{ V}$		1	70	nA
$T_{delay}$	Start-up delay time	$I_O = 0\text{ mA}$ , time from EN=HIGH until start switching, Adjustable Configuration selected		600	1400	$\mu\text{s}$
	Start-up delay time	$I_O = 0\text{ mA}$ , time from EN=HIGH until start switching, VSET Configuration selected. The typical value is based on the first option of VSET configuration.		650	1850	$\mu\text{s}$
$T_{SS}$	Soft-Start time	$I_O = 0\text{ mA}$ after $T_{delay}$ , from 1 <sup>st</sup> switching pulse until target $V_O$ ; TR/SS-Pin = OPEN		150	200	$\mu\text{s}$
$I_{SS}$	SS/TR source current		2.3	2.5	2.7	$\mu\text{A}$
$V_{FB}/V_{SS/TR}$	Tracking Gain, Adjustable Configuration			0.75		
$V_{FB}/V_{SS/TR}$	Tracking Gain tolerance			$\pm 8$		mV
$R_{DISCH}$	Active Discharge Resistance	Discharge = ON - Option Selected, EN = LOW,		7.5	20	$\Omega$

## 6.6 Typical Characteristics

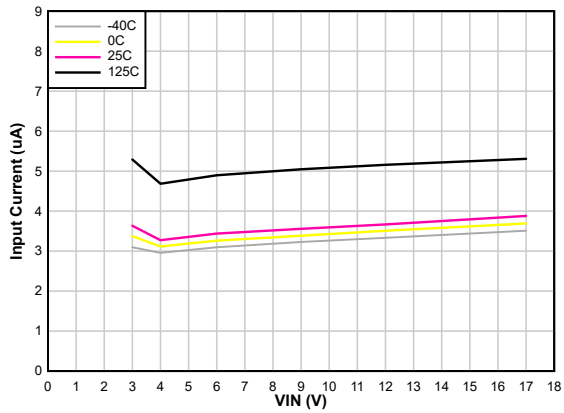

**6-1. Typical Quiescent Current vs V<sub>IN</sub>**

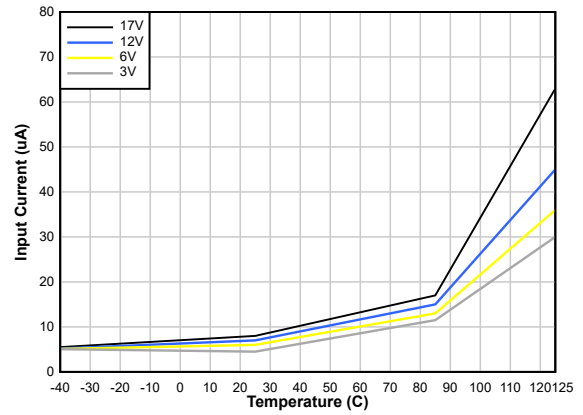

**6-2. Maximum Quiescent Current vs Temperature**

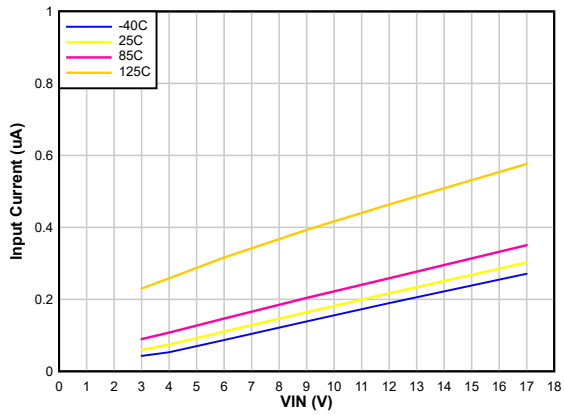

**6-3. Typical Shutdown Current**

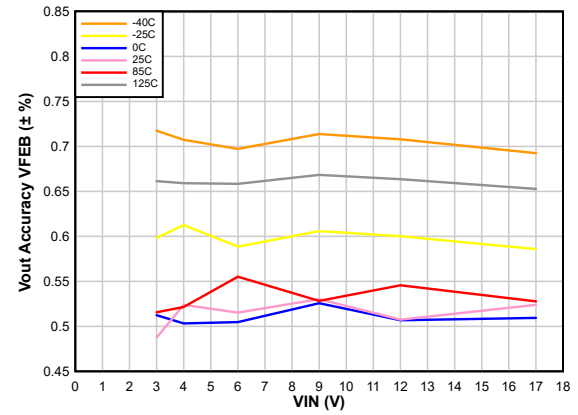

**6-4. Output Voltage Accuracy – VFEB Selected**

## 7 Detailed Description

### 7.1 Overview

The TPSM82903 synchronous step-down converter MicroSiP package module is based on DCS-Control (Direct Control with Seamless Transition into power save mode). DCS-Control is an advanced regulation topology that combines the advantages of hysteretic, voltage mode, and current mode control. This control loop takes information about output voltage changes and feeds it directly to a fast comparator stage. The control loop sets the switching frequency, which is constant for steady-state operating conditions, and provides immediate response to dynamic load changes. To get accurate DC load regulation, a voltage feedback loop is used. The internally compensated regulation network achieves fast and stable operation with small external components and low-ESR capacitors.

### 7.2 Functional Block Diagram

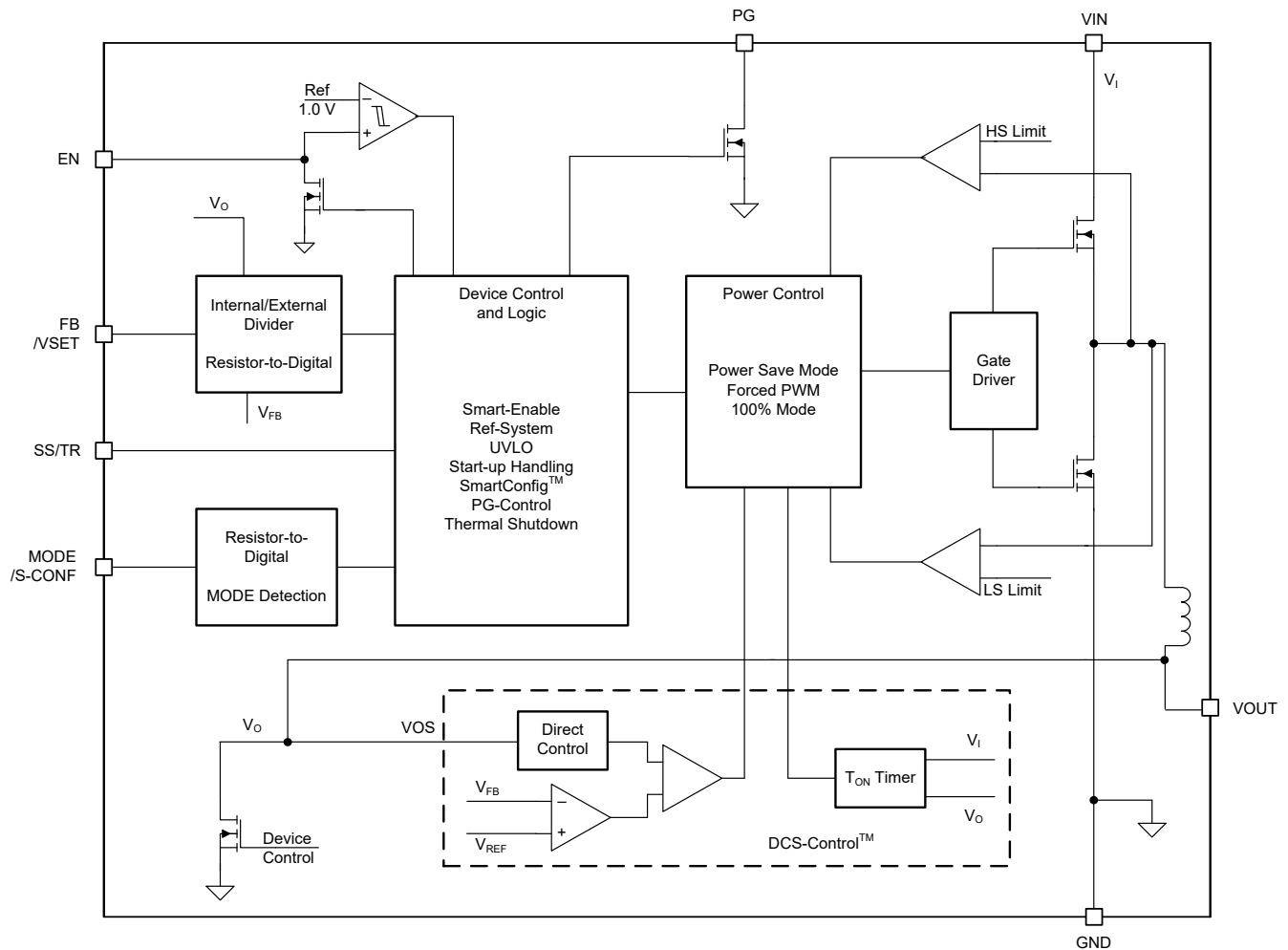



## 7.3 Feature Description

### 7.3.1 Mode Selection and Device Configuration (MODE/S-CONF)

With MODE/S-CONF (SmartConfig application), this device features an input with two functions. It can be used to customize the device behavior in two ways:

- Select the device mode (FPWM or auto PFM/PWM with AEE operation) traditionally with a HIGH- or LOW-level.
- Select the device configuration (switching frequency, internal/external feedback, output discharge, and PFM/PWM mode) by connecting a single resistor to the MODE/S-CONF pin.

The device interprets this pin during the start-up sequence after the internal OTP readout and before it starts switching in soft start. If the device reads a HIGH- or LOW-level, the dynamic mode change is active and PFM/PWM mode can be changed during operation. If the device reads a resistor value, there is no further interpretation during operation and device mode or other configurations cannot be changed afterward.

注

The MODE/S-CONF pin must not be left floating. Connect the pin high, low, or to a resistor to configure the device according to 表 7-2.



图 7-1. Interpretation of S-CONF and VSET Flow

注意

For each operating mode and switching frequency, the following  $V_{OUT}$  range is recommended:

表 7-1. Recommended  $V_{OUT}$  Ranges with Respect to MODE and  $F_{SW}$

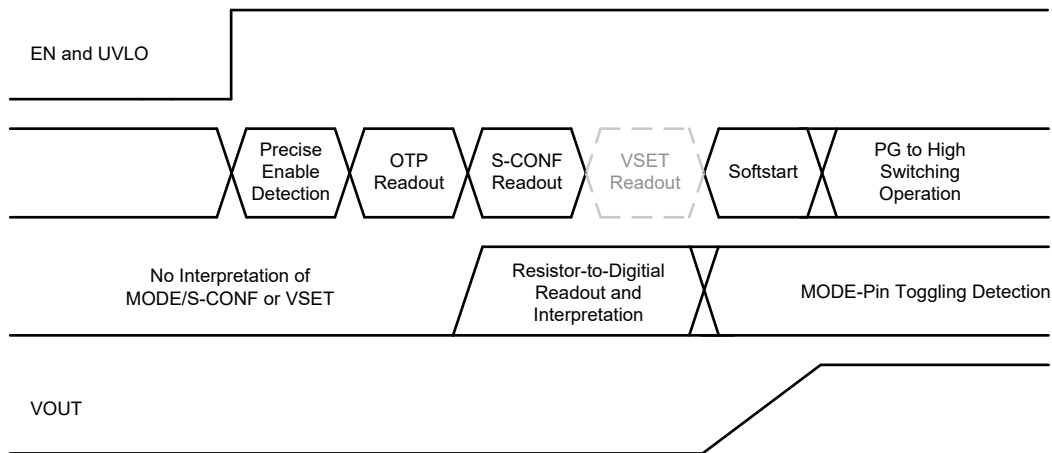
Mode	$F_{SW}$ (MHz)	$V_{OUT}$
Auto PFM/PWM	1 MHz	$0.4\text{ V} < V_{OUT} < 2.0\text{ V}$
Forced PWM	1 MHz	$0.4\text{ V} < V_{OUT} < 2.0\text{ V}$
Auto PFM/PWM with AEE	2.5 MHz	$0.4\text{ V} < V_{OUT} < 5.5\text{ V}$
Forced PWM	2.5 MHz	$2.0\text{ V} < V_{OUT} < 5.5\text{ V}$

Failure to follow the recommended  $V_{OUT}$  ranges causes the device to malfunction.

表 7-2. SmartConfig™ Application Setting Table

#	Level Or Resistor Value [Ω] (1)	FB/VSET-Pin	F <sub>sw</sub> (MHz)	Output Discharge	Mode (Auto or Forced PWM)	Dynamic Mode Change
<b>Setting Options by Level</b>						
1	GND	external FB	2.5	yes	Auto PFM/PWM with AEE	active
2	HIGH (>V <sub>IH_MODE</sub> )	external FB	2.5	yes	Forced PWM	
<b>Setting Options by Resistor</b>						
3	7.15 k	external FB	2.5	no	Auto PFM/PWM with AEE	not active
4	8.87 k	external FB	2.5	no	Forced PWM	
5	11.0 k	external FB	1	yes	Auto PFM/PWM	
6	13.7 k	external FB	1	yes	Forced PWM	
7	16.9 k	external FB	1	no	Auto PFM/PWM	
8	21.0 k	external FB	1	no	Forced PWM	
9	26.1 k	VSET	2.5	yes	Auto PFM/PWM with AEE	
10	32.4 k	VSET	2.5	yes	Forced PWM	
11	40.2 k	VSET	2.5	no	Auto PFM/PWM with AEE	
12	49.9 k	VSET	2.5	no	Forced PWM	
13	61.9 k	VSET	1	yes	Auto PFM/PWM	
14	76.8 k	VSET	1	yes	Forced PWM	
15	95.3 k	VSET	1	no	Auto PFM/PWM	
16	118 k	VSET	1	no	Forced PWM	

(1) E96 Resistor Series, 1% Accuracy, Temperature Coefficient better or equal than ±200 ppm/°C

### 7.3.2 Adjustable V<sub>O</sub> Operation (External Voltage Divider)

The TPSM82903 can be programmed by the MODE/S-CONF pin to either classical configuration where the FB/VSET pin is used as the feedback pin, sensing V<sub>O</sub> through an external resistive divider. The TPSM82903 can also be programmed to 16 different fixed output voltages. These are set through an external resistor between the FB/VSET pin and GND. In this configuration, V<sub>O</sub> is directly sensed at the VOS internal terminal connection of the device.

If the device is configured to operate in classical adjustable V<sub>O</sub> operation, the FB/VSET pin is used as the feedback pin and needs to sense V<sub>O</sub> through an external divider network. 图 7-2 shows the typical schematic for this configuration.

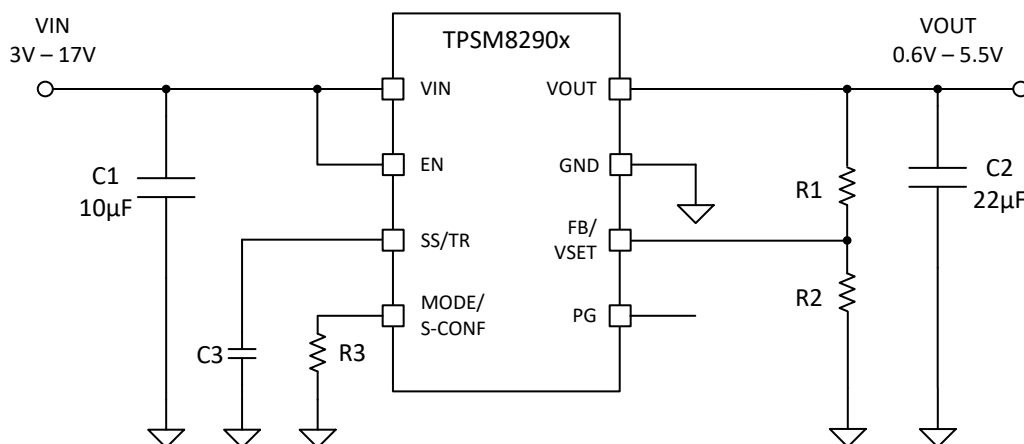
图 7-2. Adjustable V<sub>O</sub> Operation Schematic

### 7.3.3 Setable $V_O$ Operation (VSET and Internal Voltage Divider)

If the device is configured to VSET operation,  $V_O$  is sensed only through the internal VOS connection by an internal resistor divider. The target  $V_O$  is programmed by an external resistor connected between the VSET pin and GND. [Figure 7-3](#) shows the typical schematic for this configuration.

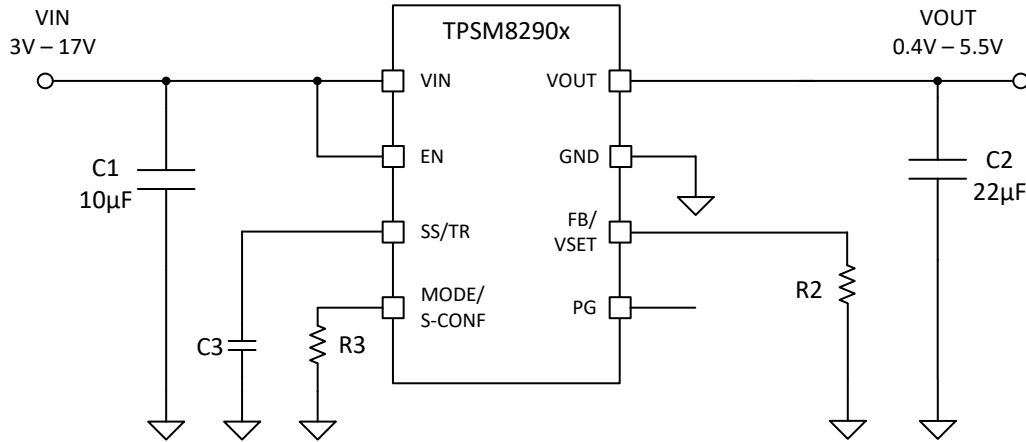

Figure 7-3. Setable  $V_O$  Operation Schematic

Table 7-3. VSET Selection Table

#	Resistor Value [ $\Omega$ ]	Target $V_O$ [V]
1	GND	1.2
2	4.64 k	0.4
3	5.76 k	0.6
4	7.15 k	0.8
5	8.87 k	1.0
6	11.0 k	1.1
7	13.7 k	1.3
8	16.9 k	1.35
9	21.0 k	1.8
10	26.1 k	1.9
11	40.2 k	2.5
12	61.9 k	3.8
13	76.8 k	5.0
14	95.3 k	5.1
15	118.0 k	5.5
16	249.00 k or larger/Open	3.3

### 7.3.4 Soft Start/Tracking (SS/TR)

With the SS/TR pin, it is possible to adjust the soft-start behavior and track an external voltage. See [Section 8.2.2.4](#) for operation details.

The internal soft-start circuitry controls the output voltage slope during start-up. This avoids excessive inrush current and makes sure there is a controlled output voltage rise time. It also prevents unwanted voltage drops from high impedance power sources or batteries. When EN is set high to start operation, the device starts switching after a delay, then the internal reference, and hence  $V_O$ , rises with a slope controlled by an external capacitor connected to the SS/TR pin.

Leaving the SS/TR pin unconnected provides the fastest start-up, limited internally (the pin must not be pulled LOW externally).

If the device is set to shut down (EN = GND), undervoltage lockout, or thermal shutdown, an internal resistor pulls the SS/TR pin down to ensure a proper low level. Returning from those states causes a new start-up sequence as set by the SS/TR connection.

A voltage supplied to SS/TR can be used to track a primary voltage. The output voltage follows this voltage up and down in forced PWM mode. In PFM mode, the output voltage decreases based on the load current.

### 7.3.5 Smart Enable with Precise Threshold

The voltage applied at the enable pin of the TPSM82903 is compared to a fixed threshold rising voltage, allowing the user to drive the pin by a slowly changing voltage and enables the use of an external RC network to achieve a power-up delay.

The precise enable input allows the user to program the undervoltage lockout by adding a resistor divider to the input of the enable pin.

The enable input threshold for a falling edge is lower than the rising edge threshold. The TPSM82903 starts operation when the rising threshold is exceeded. For proper operation, the EN pin must be terminated and must not be left floating. Pulling the EN pin low forces the device into shutdown. In this mode, the internal high-side and low-side MOSFETs are turned off and the entire internal control circuitry is switched off.

An internal resistor pulls the EN pin to GND when the device is disabled and avoids floating the pin after the device is enabled, the pulldown is removed. This prevents an uncontrolled start-up of the device in case the EN pin cannot be driven to a low level safely. With EN low, the device is in shutdown mode. The device is turned on with EN set to a high level. The pulldown control circuit disconnects the pulldown resistor on the EN pin after the internal control logic and the reference have been powered up. With EN set to a low level, the device enters shutdown mode and the pulldown resistor is activated again.

### 7.3.6 Power Good (PG)

The TPSM82903 has a built-in power-good (PG) feature to indicate whether the output voltage has reached its target and the device is ready. The PG signal can be used for start-up sequencing of multiple rails. The PG pin is an open-drain output that requires a pullup resistor to any voltage up to the recommended input voltage level. PG is low when the device is turned off due to EN, UVLO (undervoltage lockout), or thermal shutdown.  $V_{IN}$  must remain present for the PG pin to stay low.

If the power-good output is not used, it is recommended to tie to GND or leave it open.

**表 7-4. Power Good Indicator Functional Table**

Logic Signals				PG Status
$V_I$	EN Pin	Thermal Shutdown	$V_O$	
$V_I > UVLO$	HIGH	No	$V_O$ on target	High Impedance
		Yes	$V_O < target$	LOW
	LOW	x	x	LOW
$1.8 V < V_I < UVLO$	x	x	x	LOW
$V_I < 1.8 V$	x	x	x	Undefined

### 7.3.7 Undervoltage Lockout (UVLO)

If the input voltage drops, the undervoltage lockout prevents mis-operation of the device by switching off both the power FETs. The device is fully operational for voltages above the rising UVLO threshold and turns off if the input voltage trips below the threshold for a falling supply voltage.

### 7.3.8 Current Limit And Short Circuit Protection

The TPSM82903 is protected against overload and short circuit events. If the inductor current exceeds the high-side FET current limit ( $I_{LIMH}$ ), the high-side switch is turned off and the low-side switch is turned on to ramp down the inductor current. The high-side FET turns on again only if the current in the low-side FET has decreased below the low-side FET current limit threshold.

Due to internal propagation delay, the actual current can exceed the static current limit during that time. The dynamic current limit is given as 式 1:

$$I_{peak(typ)} = I_{LIMH} + \frac{V_L}{L} \times t_{PD} \quad (1)$$

where

- $I_{LIMH}$  is the static high-side FET current limit as specified in the [Electrical Characteristics](#).
- $L$  is the effective inductance at the peak current (approximately 0.9  $\mu$ H).
- $V_L$  is the voltage across the inductor ( $V_{IN} - V_{OUT}$ ).
- $t_{PD}$  is the internal propagation delay of typically 50 ns.

The current limit can exceed static values, especially if the input voltage is high and very small inductances are used. The dynamic high-side switch peak current can be calculated as follows:

$$I_{peak(typ)} = I_{LIMH} + \frac{V_{IN} - V_{OUT}}{L} \times 50 ns \quad (2)$$

### 7.3.9 Thermal Shutdown

The junction temperature,  $T_J$ , of the device is monitored by an internal temperature sensor. If  $T_J$  rises and exceeds the thermal shutdown threshold,  $T_{SD}$ , the device shuts down. Both the high-side and low-side power FETs are turned off and PG goes low. When  $T_J$  decreases below the hysteresis, the converter resumes normal operation, beginning with soft start. During a PFM skip pause, the thermal shutdown feature is not active. A shutdown or re-start is only triggered during a switching cycle. See [セクション 7.4.3](#).

## 7.4 Device Functional Modes

### 7.4.1 Pulse Width Modulation (PWM) Operation

The TPSM82903 has two operating modes: forced PWM mode discussed in this section and PWM/PFM as discussed in [セクション 7.4.3](#).

With the MODE/S-CONF pin configured for PWM mode, the TPSM82903 operates with pulse width modulation in continuous conduction mode (CCM) with a nominal switching frequency of 2.5 MHz/1.0 MHz. The frequency variation in PWM is controlled and depends on  $V_{IN}$ ,  $V_{OUT}$ , and the inductance. The on time in forced PWM mode is given by [式 3](#):

$$TON = \frac{V_{OUT}}{V_{IN}} \times \frac{1}{f_{sw}} \quad (3)$$

### 7.4.2 AEE (Automatic Efficiency Enhancement)

When the MODE/S-CONF pin is configured for AEE mode, the TPSM82903 provides the highest efficiency over the entire input voltage and output voltage range by automatically adjusting the switching frequency of the converter. This is achieved by setting the predictive off time of the converter. The efficiency of a switched mode converter is determined by the power losses during the conversion. The efficiency decreases if  $V_{OUT}$  decreases,  $V_{IN}$  increases as shown in [式 4](#), or both. In order to keep the efficiency high over the entire duty cycle range ( $V_{OUT}/V_{IN}$  ratio), the switching frequency is adjusted while maintaining the ripple current.

$$F_{sw} (MHz) = 10 \times V_{OUT} \times \frac{V_{IN} - V_{OUT}}{V_{IN}^2} \quad (4)$$

The AEE function in the TPSM82903 adjusts the on time (TON) in power save mode, depending on the input voltage and the output voltage to maintain highest efficiency. The on time in steady-state operation can be estimated as using [式 5](#):

$$TON = 100 \times \frac{VIN}{VIN - VOUT} [ns] \quad (5)$$

[式 6](#) shows the relationship among the inductor ripple current, switching frequency, and duty cycle.

$$\Delta I_L = V_{OUT} \times \left( \frac{1-D}{L \times f_{sw}} \right) = V_{OUT} \times \left( \frac{1 - \left( \frac{V_{OUT}}{V_{IN}} \right)}{L \times f_{sw}} \right) \quad (6)$$

Efficiency increases by decreasing switching losses and preserving high efficiency for varying duty cycles, while the ripple current amplitude remains low enough to deliver the full output current without reaching current limit. The AEE feature provides an efficiency enhancement for various duty cycles, especially for lower  $V_{OUT}$  values where fixed frequency converters suffer from a significant efficiency drop. Furthermore, this feature compensates for the very small duty cycles of high  $V_{IN}$  to low  $V_{OUT}$  conversion, which limits the control range in other topologies.

### 7.4.3 Power Save Mode Operation (Auto PFM/PWM)

When the MODE/S-CONF pin is configured for power save mode (auto PFM/PWM), the device operates in PWM mode as long the output current is higher than half of the ripple current of the inductor. To maintain high efficiency at light loads, the device enters power save mode at the boundary to discontinuous conduction mode (DCM). This happens if the output current becomes smaller than half of the ripple current of the inductor. The power save mode is entered seamlessly when the load current decreases. This makes sure there is a high efficiency in light load operation. The device remains in power save mode as long as the inductor current is discontinuous.

In power save mode, the switching frequency decreases linearly with the load current maintaining high efficiency. The transition in and out of power save mode is seamless in both directions.

In addition to adjusting the switching, the TPSM82903 adjusts the on time (TON) in power save mode, depending on the input voltage and the output voltage to maintain the highest efficiency using the AEE function when 2.5 MHz is selected as described in [セクション 7.4.2](#).

In power save mode, the TON time can be estimated using [式 3](#) for 1 MHz and [式 5](#) for 2.5 MHz (given the AEE is enabled for 2.5 MHz).

For very small output voltages, an absolute minimum on time of about 50 ns is kept to limit switching losses. The operating frequency is thereby reduced from its nominal value, which keeps efficiency high. Using TON, the typical peak inductor current in power save mode is approximated by [式 7](#):

$$ILPSM_{(peak)} = \frac{(VIN - VOUT)}{L} \times TON \quad (7)$$

There is a minimum off time that limits the duty cycle of the TPSM82903. When  $V_{IN}$  decreases to typically 15% above  $V_{OUT}$ , the TPSM82903 does not enter power save mode, regardless of the load current. The device maintains output regulation in PWM mode.

The output voltage ripple in power save mode is given by [式 8](#):

$$\Delta V = \frac{L \times VIN^2}{200 \times C} \left( \frac{1}{VIN - VOUT} + \frac{1}{VOUT} \right) \quad (8)$$

where

- L is the effective inductance (approximately 0.9  $\mu$ F).
- C is the output effective capacitance.

#### 7.4.4 100% Duty-Cycle Operation

The duty cycle of the buck converter operating in PWM mode is given as  $D = V_{OUT}/V_{IN}$ . The duty cycle increases as the input voltage comes close to the output voltage and the off time gets smaller. When the minimum off time of typically 80 ns is reached, the TPSM82903 scales down its switching frequency while it approaches 100% mode. In 100% mode, the device keeps the high-side switch on continuously. The high-side switch stays turned on as long as the output voltage is below the internal set point. This allows the conversion of small input to output voltage differences (for example, getting longest operation time of battery-powered applications). In 100% duty cycle mode, the low-side FET is switched off.

The minimum input voltage to maintain output voltage regulation, depending on the load current and the output voltage level, can be calculated as:

$$VIN_{(min)} = VOUT + IOUT(R_{DS(on)} + RL) \quad (9)$$

where

- $I_{OUT}$  is the output current.
- $R_{DS(on)}$  is the on-state resistance of the high-side FET.
- $R_L$  is the DC resistance of the inductor used (approximately 40 m $\Omega$ ).

#### 7.4.5 Output Discharge Function

The purpose of the discharge function is to ensure a defined down-ramp of the output voltage when the device is being disabled but also to keep the output voltage close to 0 V when the device is off. The output discharge feature is only active after the TPSM82903 has been enabled at least once since the supply voltage was applied. The internal discharge resistor is connected to the VOS pin. The discharge function is enabled as soon

as the device is disabled, in thermal shutdown, or in undervoltage lockout. The minimum supply voltage required for the discharge function to remain active typically is 2 V.

#### 7.4.6 Starting into a Pre-Biased Load

The TPSM82903 is capable of starting into a pre-biased output. The device only starts switching when the internal soft-start ramp is equal or higher than the feedback voltage. If the voltage at the feedback pin is biased to a higher voltage than the nominal value, the TPSM82903 does not start switching unless the voltage at the feedback pin drops to the target.



## 8 Application and Implementation

### 注

Information in the following applications sections is not part of the TI component specification, and TI does not warrant its accuracy or completeness. TI's customers are responsible for determining suitability of components for their purposes. Customers should validate and test their design implementation to confirm system functionality.

### 8.1 Application Information

The TPSM82903 device is highly efficient, small, and flexible synchronous step-down DC-DC converter MicroSiP package module that is easy to use. A wide input voltage range of 3 V to 17 V supports a wide variety of inputs like 12-V supply rails, single-cell or multi-cell Li-Ion, and 5-V or 3.3-V rails.

### 8.2 Typical Application with Adjustable Output Voltage



図 8-1. Typical Application Circuit

#### 8.2.1 Design Requirements

表 8-1. List of Components

Reference	Description	Manufacturer
IC	17 V, 3-A Step-Down Converter	TPSM8290x series; Texas Instruments
CIN	10 µF, 25 V, Ceramic, 0805	C3216X7R1E106M160AE, TDK
COUT	22 µF, 16 V, Ceramic, 0805	C2012X7S1A226M125AC, TDK
CSS	Depends on soft start time; see <a href="#">セクション 8.2.2.3.3</a> .	16 V, Ceramic, X7R
R1	Depending on $V_{OUT}$ ; see <a href="#">セクション 8.2.2.2</a> .	Standard 1% metal film
R2	Depending on $V_{OUT}$ ; see <a href="#">セクション 8.2.2.2</a> .	Standard 1% metal film
R3	Depending on device setting, see <a href="#">セクション 7.3.1</a> .	Standard 1% metal film

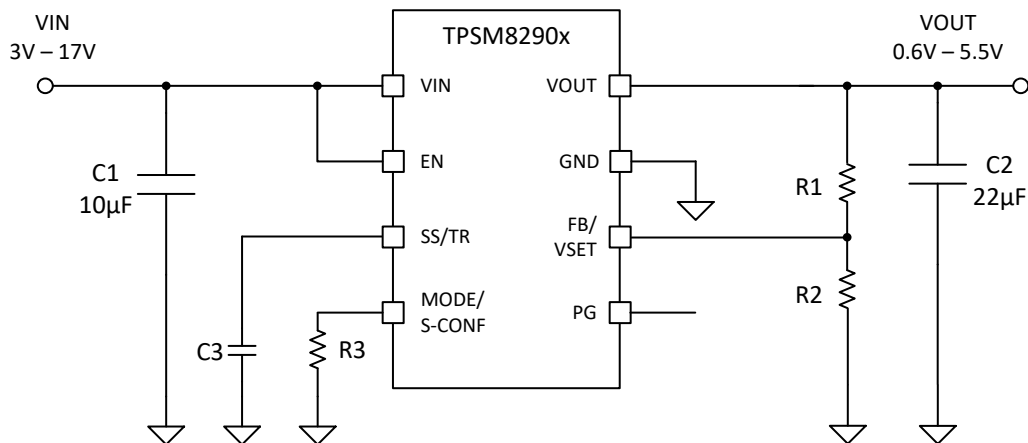
#### 8.2.2 Detailed Design Procedure

##### 8.2.2.1 Custom Design With WEBENCH® Tools

[Click here](#) to create a custom design using the TPSM82903 device with the WEBENCH® Power Designer.

1. Start by entering the input voltage ( $V_{IN}$ ), output voltage ( $V_{OUT}$ ), and output current ( $I_{OUT}$ ) requirements.
2. Optimize the design for key parameters such as efficiency, footprint, and cost using the optimizer dial.
3. Compare the generated design with other possible solutions from Texas Instruments.

The WEBENCH Power Designer provides a customized schematic along with a list of materials with real-time pricing and component availability.

In most cases, these actions are available:

- Run electrical simulations to see important waveforms and circuit performance
- Run thermal simulations to understand board thermal performance
- Export customized schematic and layout into popular CAD formats
- Print PDF reports for the design, and share the design with colleagues

Get more information about WEBENCH tools at [www.ti.com/WEBENCH](http://www.ti.com/WEBENCH).

### 8.2.2.2 Programming the Output Voltage

The output voltage of the TPSM82903 is adjustable. It can be programmed for output voltages from 0.6 V to 5.5 V using a resistor divider from  $V_{OUT}$  to GND. The voltage at the FB pin is regulated to 600 mV. The value of the output voltage is set by the selection of the resistor divider from 式 10. It is recommended to choose resistor values that allow a current of at least 2  $\mu$ A, meaning the value of R2 must not exceed 400 k $\Omega$ . Lower resistor values are recommended for highest accuracy and most robust design.

$$R_1 = R_2 \times \left( \frac{V_{OUT}}{V_{FB}} - 1 \right) \quad (10)$$

With typical  $V_{FB} = 0.6$  V, 1-MHz switching frequency is not recommended for  $V_{OUT} > 1.8$  V.

**表 8-2. Setting the Output Voltage**

Nominal Output Voltage	R1	R2	Exact Output Voltage
0.75 V	24.9 k $\Omega$	100 k $\Omega$	0.749 V
1.2 V	100 k $\Omega$	100 k $\Omega$	1.2 V
1.5 V	150 k $\Omega$	100 k $\Omega$	1.5 V
1.8 V	200 k $\Omega$	100 k $\Omega$	1.8 V
2.0 V	49.9 k $\Omega$	21.5 k $\Omega$	1.992 V
2.5 V	100 k $\Omega$	31.6 k $\Omega$	2.498 V
3.0 V	100 k $\Omega$	24.9 k $\Omega$	3.009 V
3.3 V	113 k $\Omega$	24.9 k $\Omega$	3.322 V
5.0 V	182 k $\Omega$	24.9 k $\Omega$	4.985 V

### 8.2.2.3 Capacitor Selection

#### 8.2.2.3.1 Output Capacitor

The recommended value for the output capacitor is 22  $\mu$ F. Output capacitance above 100  $\mu$ F needs to have a ESR of  $\geq 10$  m $\Omega$  for stable operation. The architecture of the TPSM82903 allows the use of tiny ceramic output capacitors with low equivalent series resistance (ESR). These capacitors provide low output voltage ripple and are recommended. To keep its low resistance up to high frequencies and to get narrow capacitance variation with temperature, use X7R or X5R dielectric. Using a higher value has advantages like smaller voltage ripple and a tighter DC output accuracy in power save mode (see the [Optimizing the TPS62130/40/50/60 Output Filter](#) application report).

In power save mode, the output voltage ripple depends on the output capacitance, its ESR, ESL, and the peak inductor current. Using ceramic capacitors provides small ESR, ESL, and low ripple. The output capacitor needs to be as close as possible to the device.

For large output voltages, the DC bias effect of ceramic capacitors is large and the effective capacitance must be observed.

#### 8.2.2.3.2 Input Capacitor

For most applications, 10  $\mu$ F nominal is sufficient and is recommended, though a larger value reduces input current ripple further. The input capacitor buffers the input voltage for transient events and also decouples the converter from the supply. A low-ESR multilayer ceramic capacitor (MLCC) is recommended for best filtering and must be placed between VIN and GND as close as possible to those pins.

表 8-3. List of Capacitors

Type <sup>(1)</sup>	Nominal Capacitance [μF]	Voltage Rating [V]	Size	Manufacturer
C3216X7R1E106K160AB	10	25	0805	TDK
C2012X7S1A226M125AC	22	10	0805	TDK

(1) Lower of I<sub>RMS</sub> at 40°C rise or I<sub>SAT</sub> at 30% drop

### 8.2.2.3.3 Soft-Start Capacitor

A capacitor connected between SS/TR pin and GND allows a user-programmable start-up slope of the output voltage.



图 8-2. Soft-Start Operation Simplified Schematic

An internal constant current source is provided to charge the external capacitance. The capacitor required for a given soft-start ramp time is given by:

$$C_{SS} = T_{SS} \times \frac{I_{SS}}{V_{REF}} \quad (11)$$

where

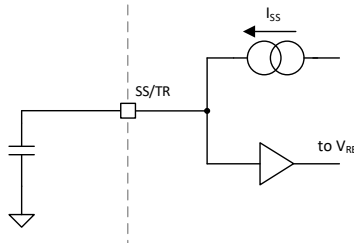
- C<sub>SS</sub> is the capacitance required at the SS/TR pin.
- T<sub>SS</sub> is the desired soft-start ramp time.
- I<sub>SS</sub> is the SS/TR source current, see the [Electrical Characteristics](#).
- V<sub>REF</sub> is the feedback regulation voltage divided by tracking gain (V<sub>FB</sub>/0.75), see the [Electrical Characteristics](#).

The fastest achievable typical ramp time is 150 μs even if the external C<sub>SS</sub> capacitance is lower than 680 pF or the pin is open.

### 8.2.2.4 Tracking Function

If a tracking function is desired, the SS/TR pin can be used for this purpose by connecting it to an external tracking voltage. The output voltage tracks that voltage with the typical gain and offset as specified in the [Electrical Characteristics](#).



图 8-3. Tracking Operation Simplified Schematic

$$V_{FB} = 0.75 \times V_{SS/TR} \quad (12)$$

When the SS/TR pin voltage is above 0.8 V, the internal voltage is clamped and the device goes to normal regulation. This works for rising and falling tracking voltages with the same behavior, as long as the input voltage is inside the recommended operating conditions. For decreasing SS/TR pin voltage in PFM mode, the device does not sink current from the output. The resulting decrease of the output voltage can therefore be slower than the SS/TR pin voltage if the load is light. When driving the SS/TR pin with an external voltage, do not exceed the voltage rating of the SS/TR pin, which is 6 V. The SS/TR pin is internally connected with a resistor to GND when EN = 0.

If the input voltage drops below undervoltage lockout, the output voltage goes to zero, independent of the tracking voltage. [Figure 8-4](#) shows how to connect devices to get ratiometric and simultaneous sequencing by using the tracking function.

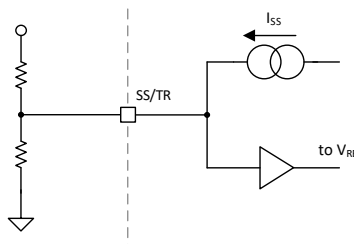
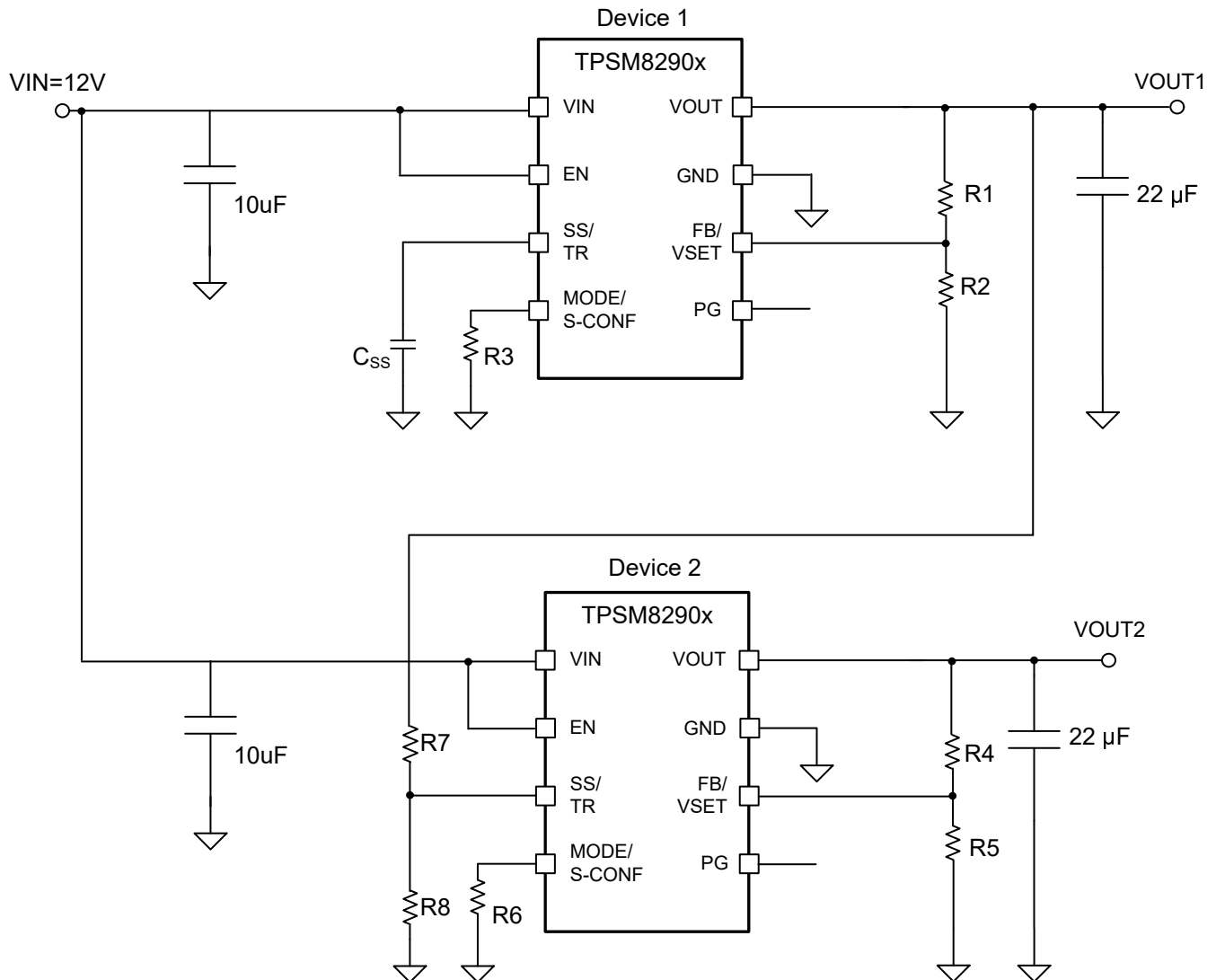

**Figure 8-4. Schematic for Ratiometric and Simultaneous Start-Up**

The resistive divider of R7 and R8 can be used to change the ramp rate of VOUT2 to be faster, slower, or the same as VOUT1.

A sequential start-up is achieved by connecting the PG pin of VOUT of device 1 to the EN pin of device 2. PG requires a pullup resistor. Ratiometric start-up sequence happens if both supplies are sharing the same soft-start capacitor. [Equation 11](#) gives the soft-start time, though the SS/TR current has to be doubled. Details about these and other tracking and sequencing circuits are found in [Sequencing and Tracking With the TPS621-Family and TPS821-Family](#) application report.

---

注

If the voltage at the FB pin is below its typical value of 0.6 V, the output voltage accuracy can have a wider tolerance than specified. The current of 2.5  $\mu$ A out of the SS/TR pin also has an influence on the tracking function, especially for high resistive external voltage dividers on the SS/TR pin.

---

### 8.2.3 Application Curves

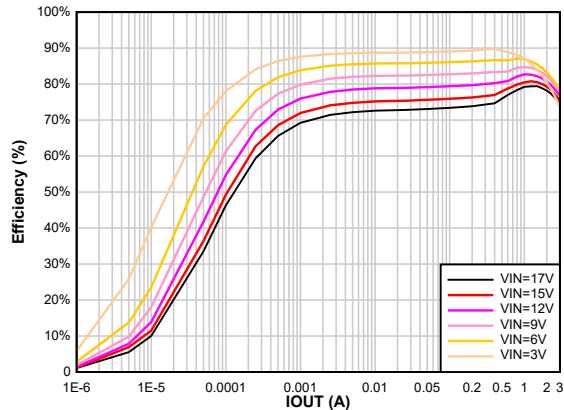

Auto PFM/PWM  $F_{sw} = 1 \text{ MHz}$

**8-5. Efficiency vs Output Current**  
 $V_{OUT} = 1.2 \text{ V}$

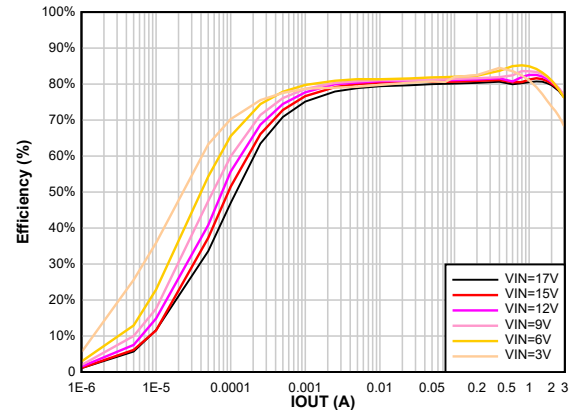

Auto PFM/PWM  $F_{sw} = 2.5 \text{ MHz}$

**8-6. Efficiency vs Output Current**  
 $V_{OUT} = 1.2 \text{ V}$

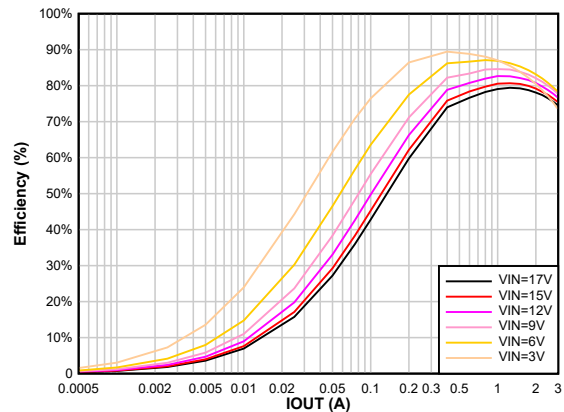

FPWM  $F_{sw} = 1 \text{ MHz}$

**8-7. Efficiency vs Output Current**  
 $V_{OUT} = 1.2 \text{ V}$

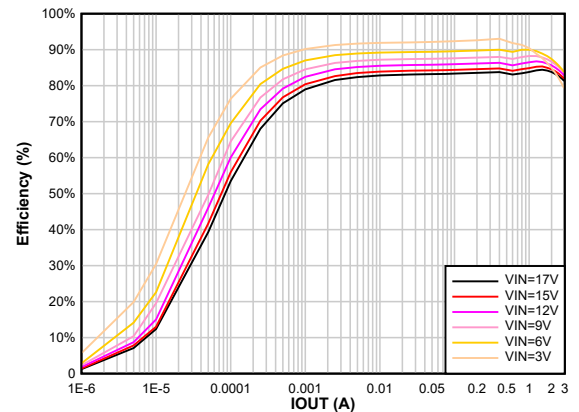

Auto PFM/PWM  $F_{sw} = 1 \text{ MHz}$

**8-8. Efficiency vs Output Current**  
 $V_{OUT} = 1.8 \text{ V}$

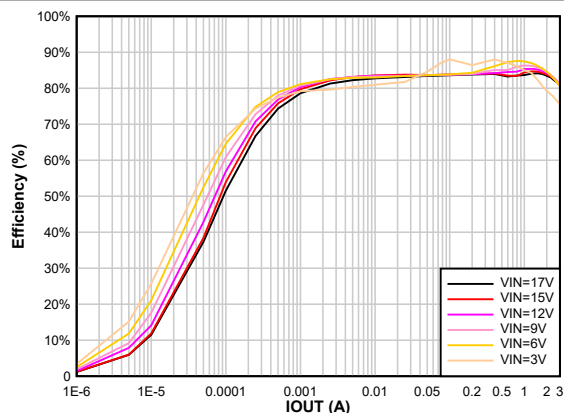

Auto PFM/PWM  $F_{sw} = 2.5 \text{ MHz}$

**8-9. Efficiency vs Output Current**  
 $V_{OUT} = 1.8 \text{ V}$

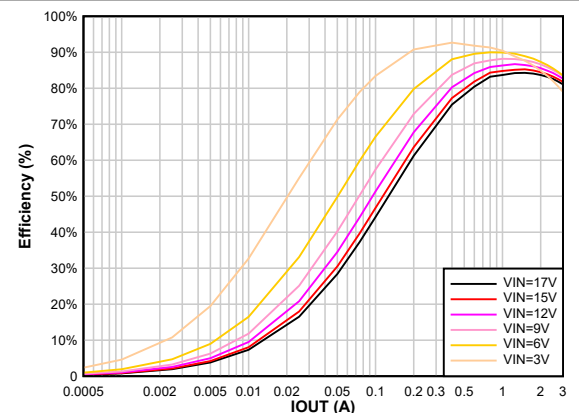

FPWM  $F_{sw} = 1 \text{ MHz}$

**8-10. Efficiency vs Output Current**  
 $V_{OUT} = 1.8 \text{ V}$

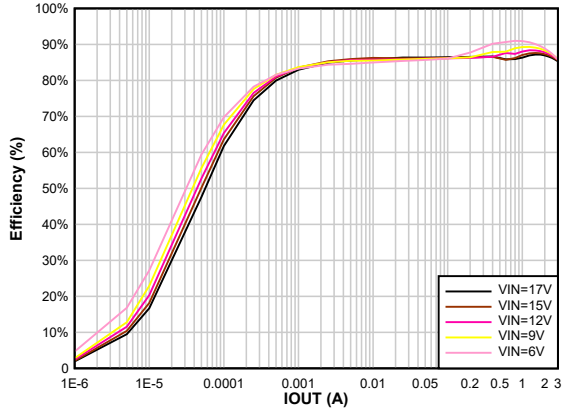

Auto PFM/PWM  $F_{sw} = 2.5 \text{ MHz}$

**8-11. Efficiency vs Output Current**  
 $V_{OUT} = 3.3 \text{ V}$

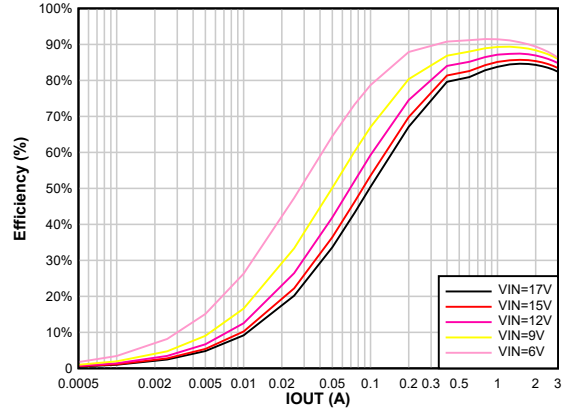

FPWM  $F_{sw} = 2.5 \text{ MHz}$

**8-12. Efficiency vs Output Current**  
 $V_{OUT} = 3.3 \text{ V}$

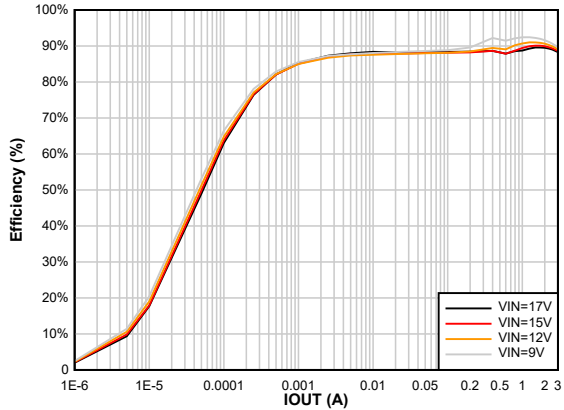

Auto PFM/PWM  $F_{sw} = 2.5 \text{ MHz}$

**8-13. Efficiency vs Output Current**  
 $V_{OUT} = 5.5 \text{ V}$

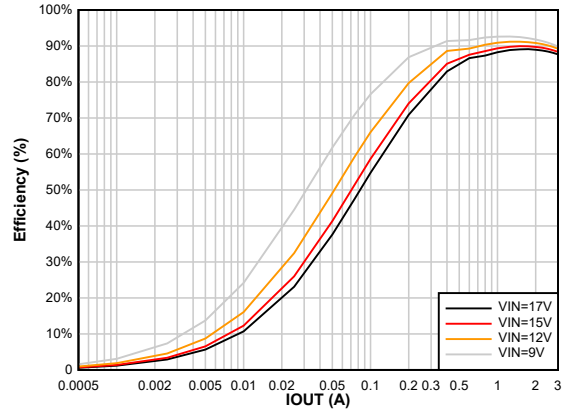

FPWM  $F_{sw} = 2.5 \text{ MHz}$

**8-14. Efficiency vs Output Current**  
 $V_{OUT} = 5.5 \text{ V}$

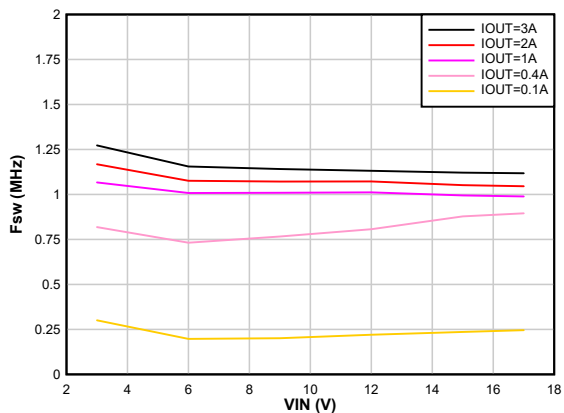

Auto PFM/PWM  $F_{sw} = 1 \text{ MHz}$

**8-15. Switching Frequency vs Input Voltage**  
 $V_{OUT} = 1.2 \text{ V}$

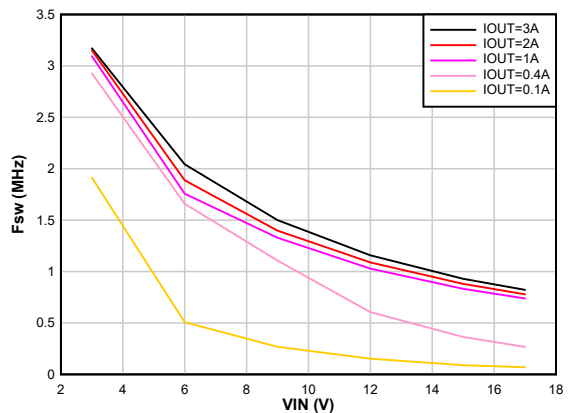

Auto PFM/PWM  $F_{sw} = 2.5 \text{ MHz}$

**8-16. Switching Frequency vs Input Voltage**  
 $V_{OUT} = 1.2 \text{ V}$

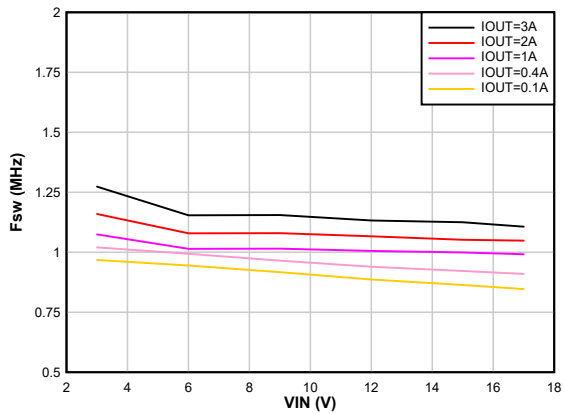

FPWM  $F_{sw} = 1 \text{ MHz}$

**8-17. Switching Frequency vs Input Voltage**  
 $V_{OUT} = 1.2 \text{ V}$

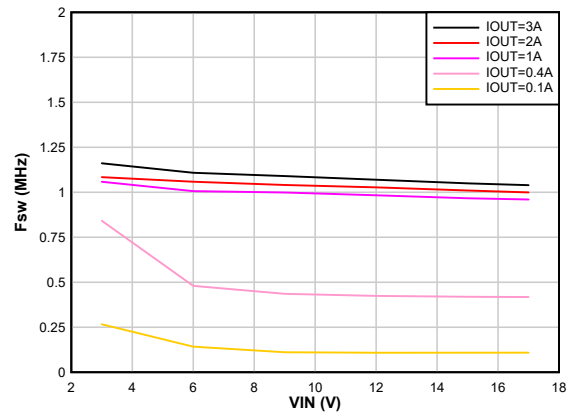

Auto PFM/PWM  $F_{sw} = 1 \text{ MHz}$

**8-18. Switching Frequency vs Input Voltage**  
 $V_{OUT} = 1.8 \text{ V}$

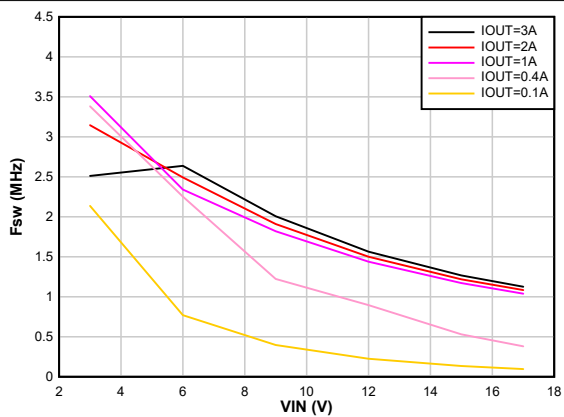

Auto PFM/PWM  $F_{sw} = 2.5 \text{ MHz}$

**8-19. Switching Frequency vs Input Voltage**  
 $V_{OUT} = 1.8 \text{ V}$

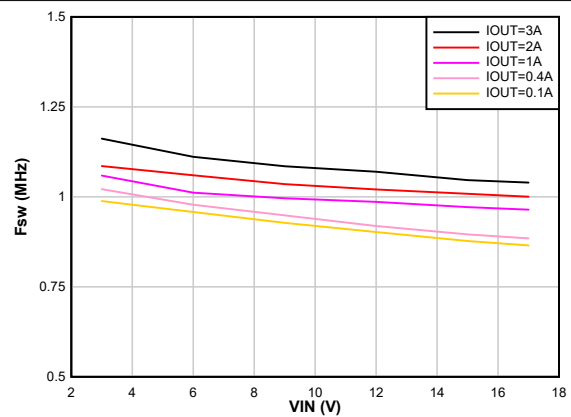

FPWM  $F_{sw} = 1 \text{ MHz}$

**8-20. Switching Frequency vs Input Voltage**  
 $V_{OUT} = 1.8 \text{ V}$

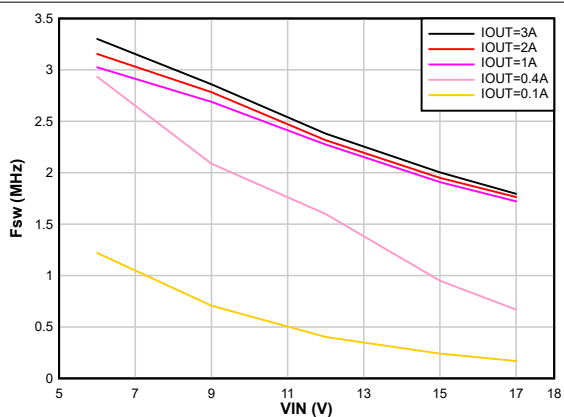

Auto PFM/PWM  $F_{sw} = 2.5 \text{ MHz}$

**8-21. Switching Frequency vs Input Voltage**  
 $V_{OUT} = 3.3 \text{ V}$

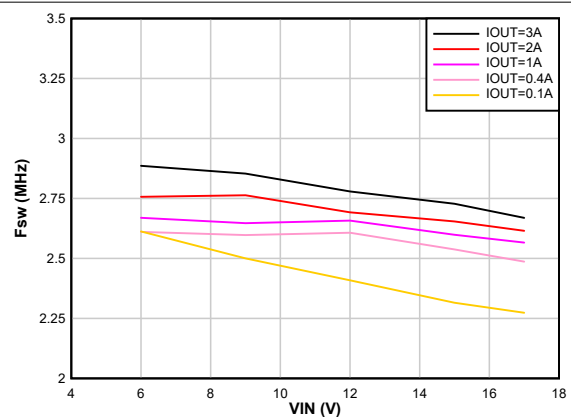

FPWM  $F_{sw} = 2.5 \text{ MHz}$

**8-22. Switching Frequency vs Input Voltage**  
 $V_{OUT} = 3.3 \text{ V}$



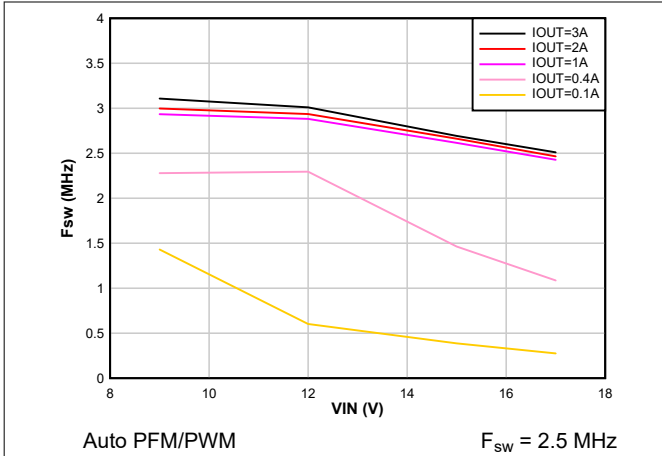



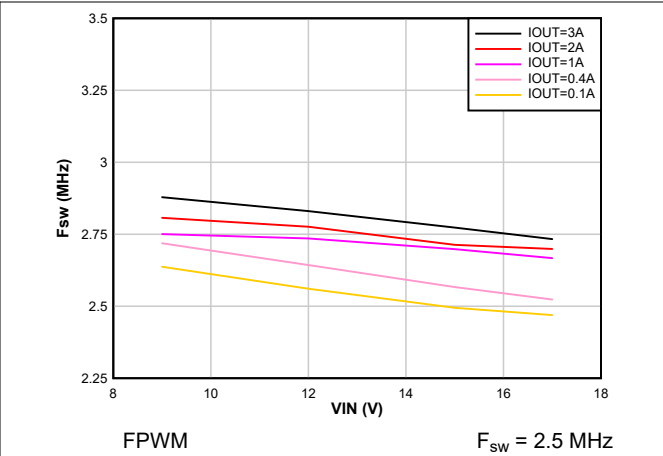

**8-23. Switching Frequency vs Input Voltage**  
 $V_{OUT} = 5.5 \text{ V}$

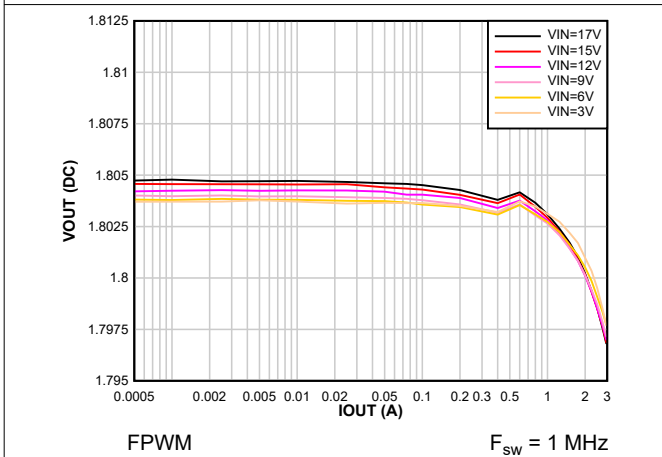



**8-24. Switching Frequency vs Input Voltage**  
 $V_{OUT} = 5.5 \text{ V}$

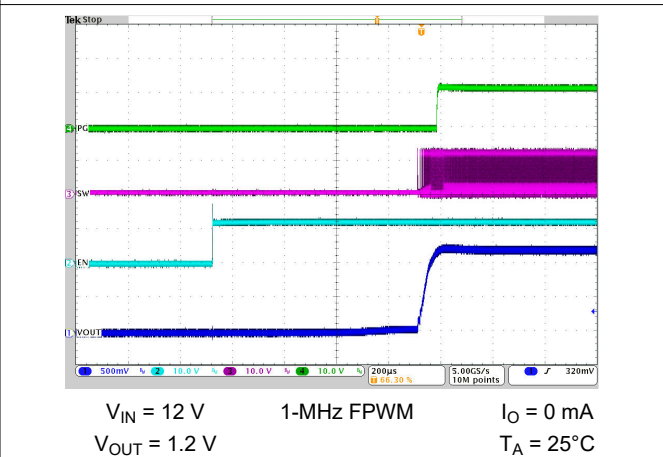



**8-25. Output Voltage vs Output Current**  
 $V_{OUT} = 1.8 \text{ V}$

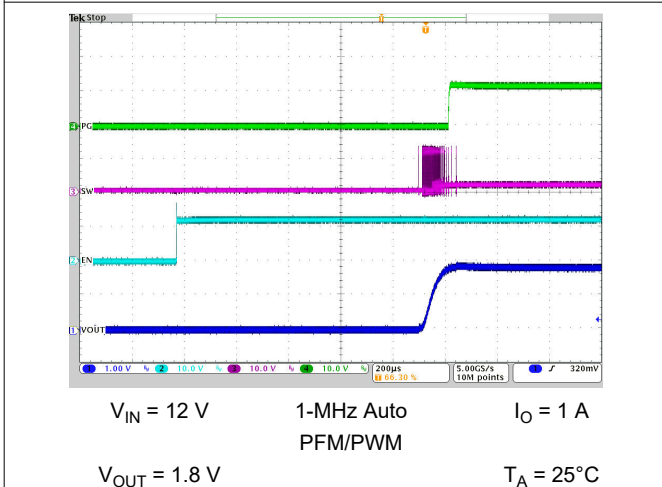



**8-26. Start-Up Timing**

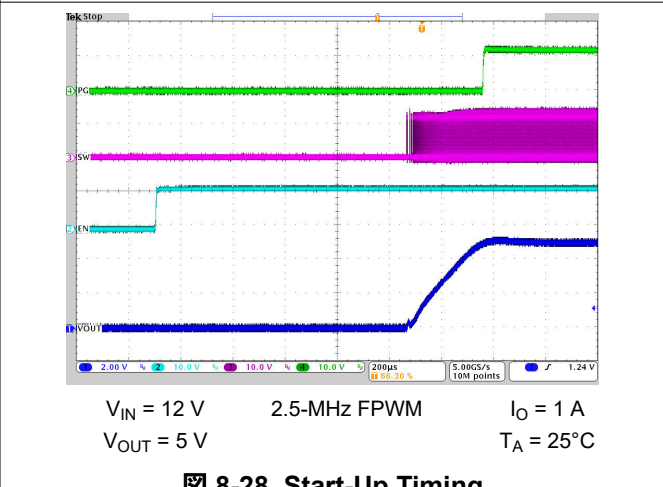

**8-27. Start-Up Timing**



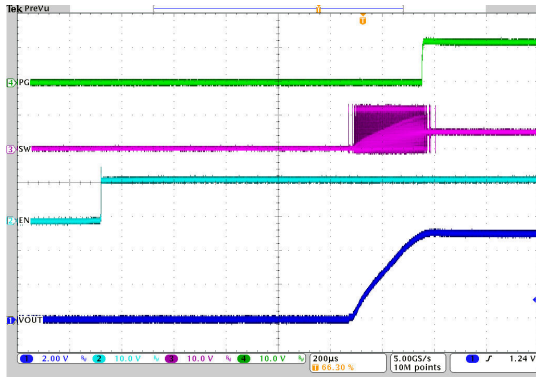

**8-28. Start-Up Timing**

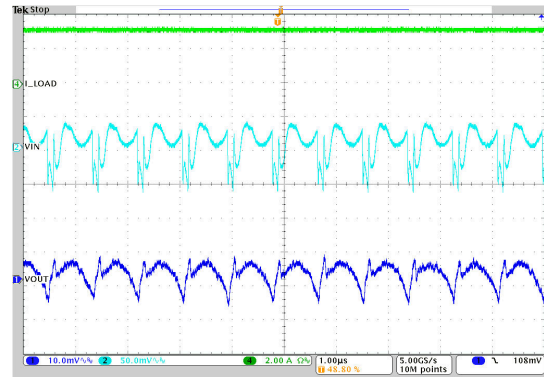

$V_{IN} = 12\text{ V}$       2.5-MHz       $I_O = 1\text{ A}$   
PFM/PWM  
 $V_{OUT} = 5\text{ V}$        $T_A = 25^\circ\text{C}$

**图 8-29. Start-Up Timing**



$V_{IN} = 12\text{ V}$       1-MHz Auto       $I_O = 3\text{ A}$   
PFM/PWM  
 $V_{OUT} = 1.2\text{ V}$        $T_A = 25^\circ\text{C}$

**图 8-30. Output Voltage Ripple**

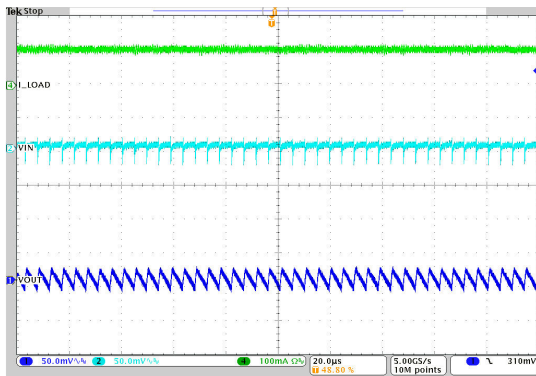

$V_{IN} = 12\text{ V}$       1-MHz Auto       $I_O = 0.1\text{ A}$   
PFM/PWM  
 $V_{OUT} = 1.2\text{ V}$        $T_A = 25^\circ\text{C}$

**图 8-31. Output Voltage Ripple**

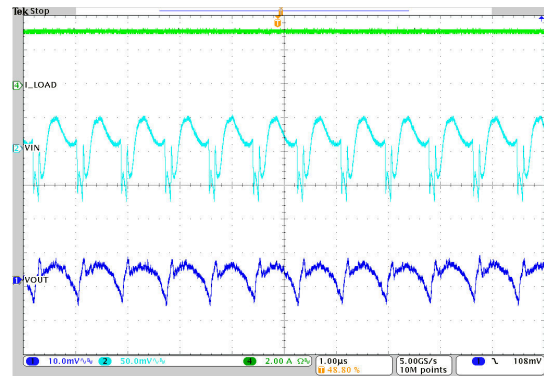

$V_{IN} = 12\text{ V}$       2.5-MHz Auto       $I_O = 3\text{ A}$   
PFM/PWM  
 $V_{OUT} = 1.2\text{ V}$        $T_A = 25^\circ\text{C}$

**图 8-32. Output Voltage Ripple**

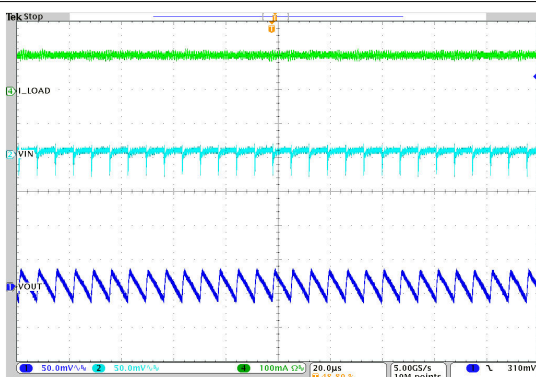

$V_{IN} = 12\text{ V}$       2.5-MHz Auto       $I_O = 0.1\text{ A}$   
PFM/PWM  
 $V_{OUT} = 1.2\text{ V}$        $T_A = 25^\circ\text{C}$

**图 8-33. Output Voltage Ripple**

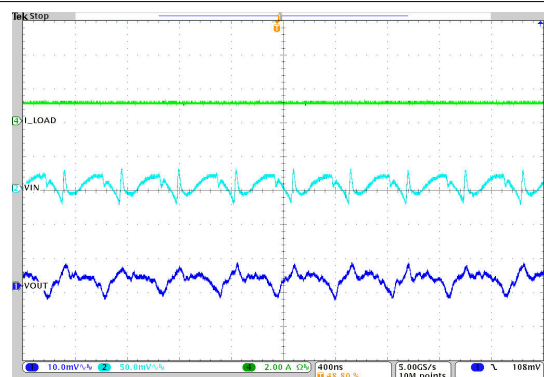

$V_{IN} = 12\text{ V}$       2.5-MHz Auto       $I_O = 1\text{ A}$   
PFM/PWM  
 $V_{OUT} = 3.3\text{ V}$        $T_A = 25^\circ\text{C}$

**图 8-34. Output Voltage Ripple**

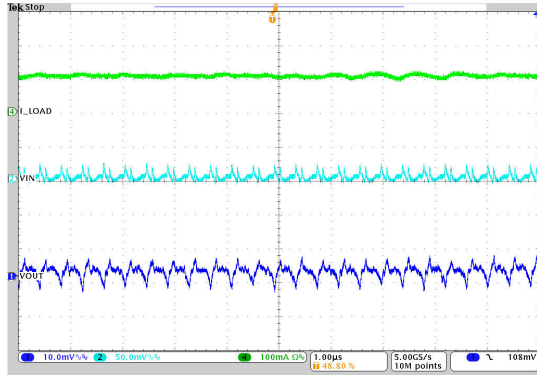

$V_{IN} = 12\text{ V}$       2.5-MHz FPWM       $I_O = 0.1\text{ A}$   
 $V_{OUT} = 3.3\text{ V}$                                        $T_A = 25^\circ\text{C}$

**8-35. Output Voltage Ripple**

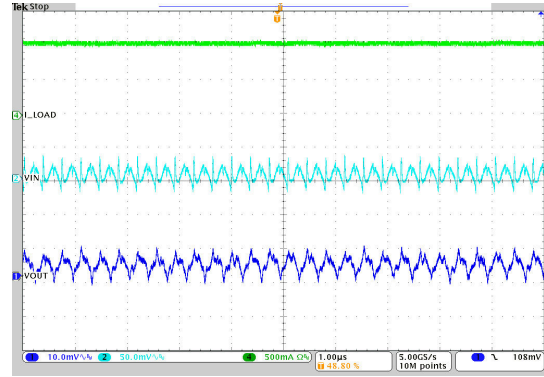

$V_{IN} = 12\text{ V}$       2.5-MHz FPWM       $I_O = 1\text{ A}$   
 $V_{OUT} = 5.0\text{ V}$                                        $T_A = 25^\circ\text{C}$

**8-36. Output Voltage Ripple**

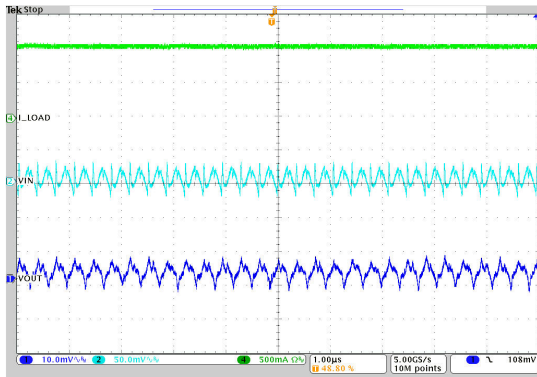

$V_{IN} = 12\text{ V}$                                       2.5-MHz Auto PFM/PWM  
 $V_{OUT} = 5.0\text{ V}$                                        $I_O = 1\text{ A}$                                        $T_A = 25^\circ\text{C}$

**8-37. Output Voltage Ripple**

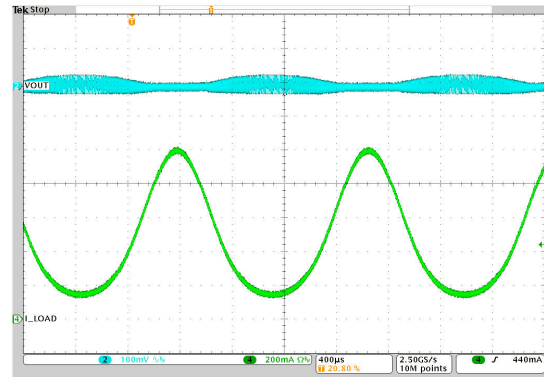

$V_{IN} = 12\text{ V}$                                       1-MHz Auto PFM/PWM       $I_O = 0.1\text{ A to }1\text{ A}$   
 $V_{OUT} = 1.2\text{ V}$                                        $T_A = 25^\circ\text{C}$

**8-38. PSM-to-PWM Transition**

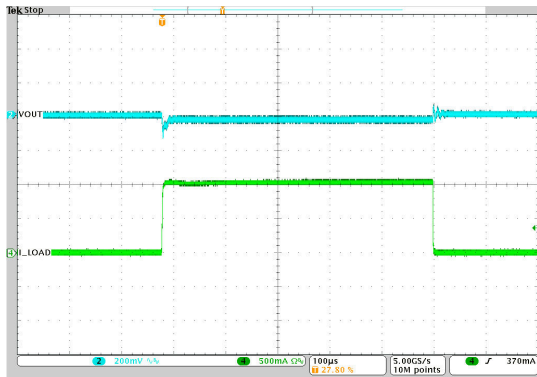

$V_{IN} = 12\text{ V}$                                       1-MHz Auto PFM/PWM       $I_O = 5\text{ mA to }1\text{ A to }5\text{ mA}$   
 $V_{OUT} = 1.2\text{ V}$                                        $T_A = 25^\circ\text{C}$

**8-39. Load Transient Response**

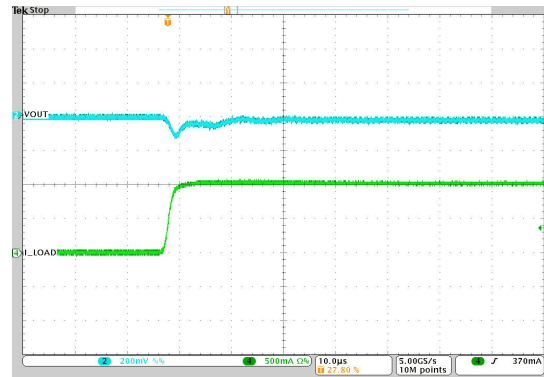

$V_{IN} = 12\text{ V}$                                       1-MHz Auto PFM/PWM       $I_O = 5\text{ mA to }1\text{ A}$   
 $V_{OUT} = 1.2\text{ V}$                                        $T_A = 25^\circ\text{C}$

**8-40. Load Transient Response – Rising Edge**

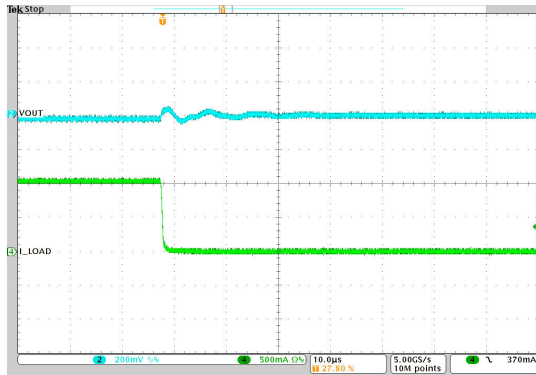

$V_{IN} = 12\text{ V}$       1-MHz Auto       $I_O = 1\text{ A to }5\text{ mA}$   
PFM/PWM  
 $V_{OUT} = 1.2\text{ V}$        $T_A = 25^\circ\text{C}$

**8-41. Load Transient Response – Falling Edge**

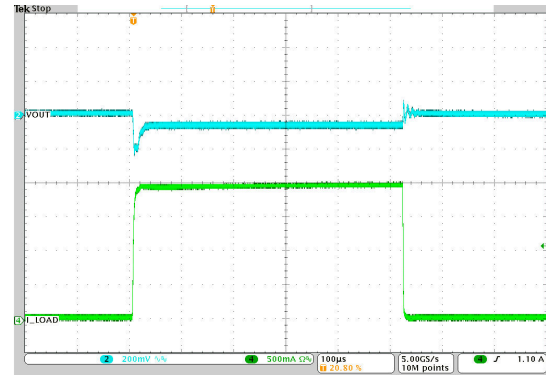

$V_{IN} = 12\text{ V}$        $I_O = 5\text{ mA to }2\text{ A to }5\text{ mA}$   
 $V_{OUT} = 3.3\text{ V}$       2.5-MHz Auto       $T_A = 25^\circ\text{C}$   
PFM/PWM

**8-42. Load Transient Response**

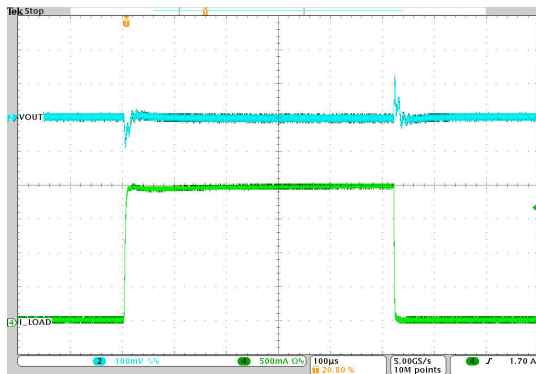

$V_{IN} = 12\text{ V}$        $I_O = 5\text{ mA to }2\text{ A to }5\text{ mA}$   
 $V_{OUT} = 3.3\text{ V}$       2.5-MHz FPWM       $T_A = 25^\circ\text{C}$

**8-43. Load Transient Response**

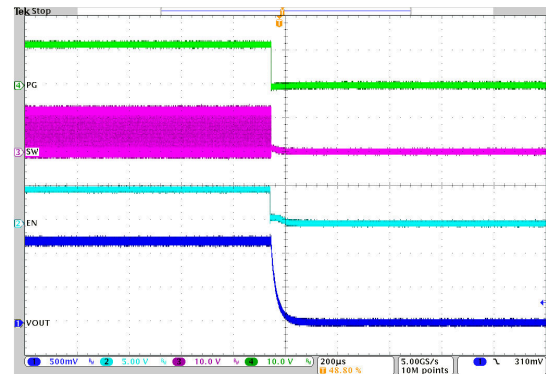

$V_{IN} = 12\text{ V}$       Output Discharge = Yes  
 $V_{OUT} = 1.2\text{ V}$        $T_A = 25^\circ\text{C}$

**8-44. Output Discharge Function – Enabled**

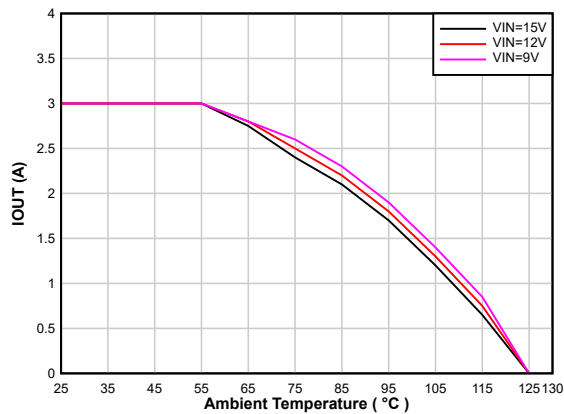

Auto PFM/PWM       $F_{sw} = 2.5\text{ MHz}$

**8-45. Thermal Derating  $V_{OUT} = 1.2\text{ V}$**

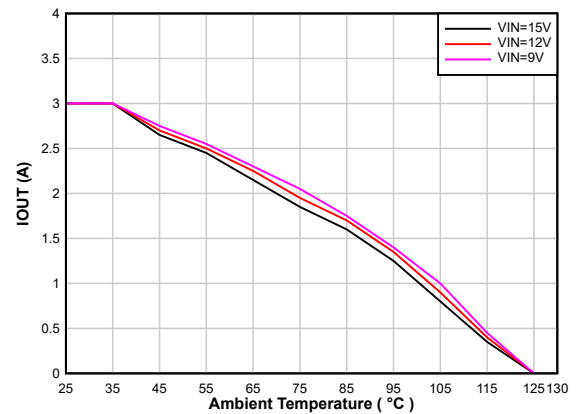

Auto PFM/PWM       $F_{sw} = 2.5\text{ MHz}$

**8-46. Thermal Derating  $V_{OUT} = 3.3\text{ V}$**

### 8.3 Typical Application with Setable $V_O$ Using VSET

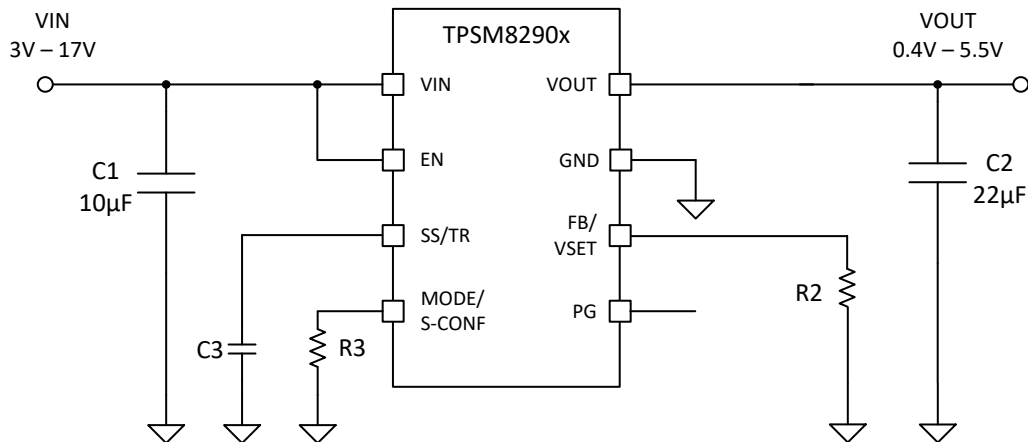

**图 8-47. Typical Application Circuit (VSET)**

#### 8.3.1 Design Requirements

VSET allows the user to set the output voltage using only one resistor to ground on the FB/VSET pin. [表 7-3](#) shows the 16 available options.

#### 8.3.2 Detailed Design Procedure

The VSET option needs to be selected using the MODE/S-CONF pin. After the device is configured to VSET operation,  $V_O$  is sensed only through the VOS pin by an internal resistor divider. The target  $V_O$  is programmed by an external resistor R2 connected between FB/VSET and GND.

### 8.3.3 Application Curves

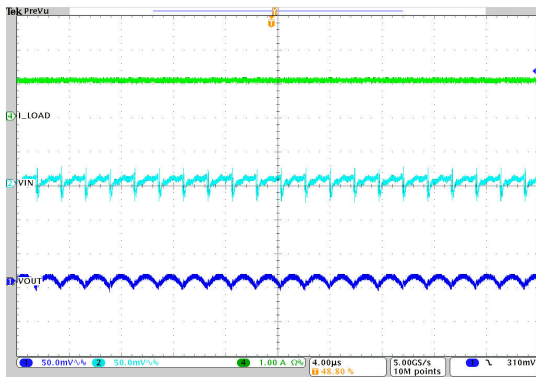

$V_{IN} = 12\text{ V}$       1-MHz Auto       $I_O = 1\text{ A}$   
 $V_{OUT} = 0.4\text{ V}$       PFM/PWM       $T_A = 25^\circ\text{C}$

8-48. Output Voltage Ripple

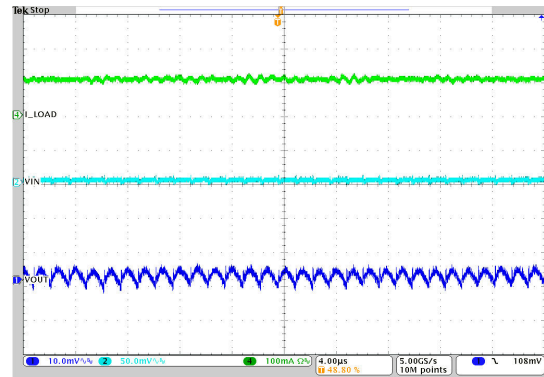

$V_{IN} = 12\text{ V}$       1-MHz Auto       $I_O = 100\text{ mA}$   
 $V_{OUT} = 0.4\text{ V}$       PFM/PWM       $T_A = 25^\circ\text{C}$

8-49. Output Voltage Ripple

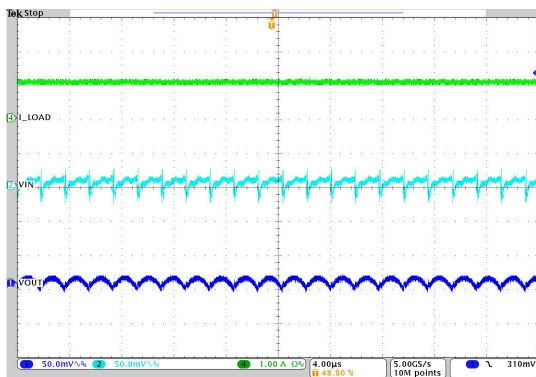

$V_{IN} = 12\text{ V}$       1-MHz FPWM       $I_O = 1\text{ A}$   
 $V_{OUT} = 0.4\text{ V}$        $T_A = 25^\circ\text{C}$

8-50. Output Voltage Ripple

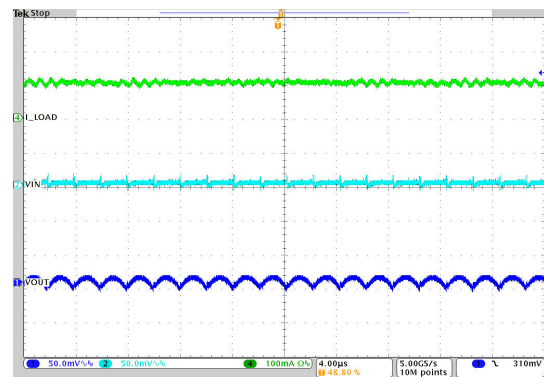

$V_{IN} = 12\text{ V}$       1-MHz FPWM       $I_O = 100\text{ mA}$   
 $V_{OUT} = 0.4\text{ V}$        $T_A = 25^\circ\text{C}$

8-51. Output Voltage Ripple

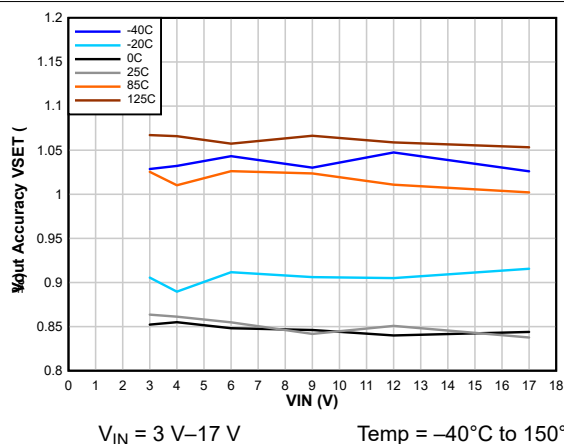

$V_{IN} = 3\text{ V} - 17\text{ V}$       Temp =  $-40^\circ\text{C}$  to  $150^\circ\text{C}$

8-52. Output Voltage Accuracy – VSET Selected

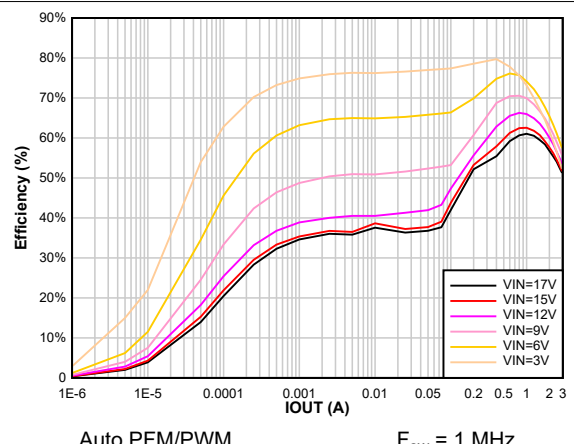

Auto PFM/PWM       $F_{sw} = 1\text{ MHz}$

8-53. Efficiency vs Output Current  
 $V_{OUT} = 0.4\text{ V}$



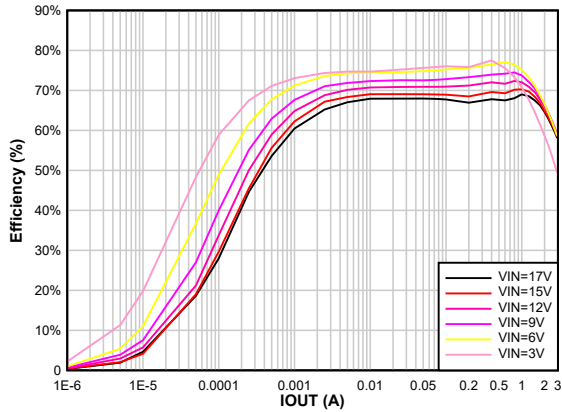

Auto PFM/PWM  $F_{sw} = 2.5 \text{ MHz}$   
8-54. Efficiency vs Output Current  
 $V_{OUT} = 0.4 \text{ V}$

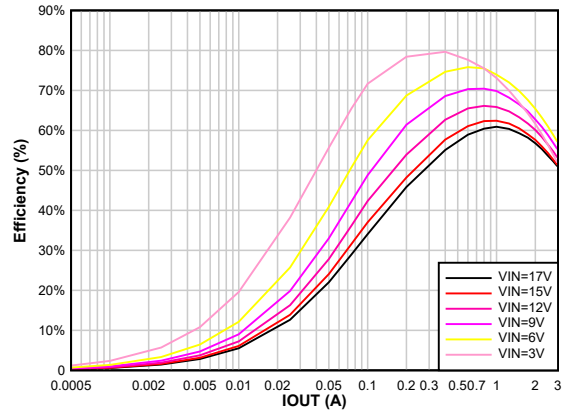

FPWM  $F_{sw} = 1 \text{ MHz}$   
8-55. Efficiency vs Output Current  
 $V_{OUT} = 0.4 \text{ V}$

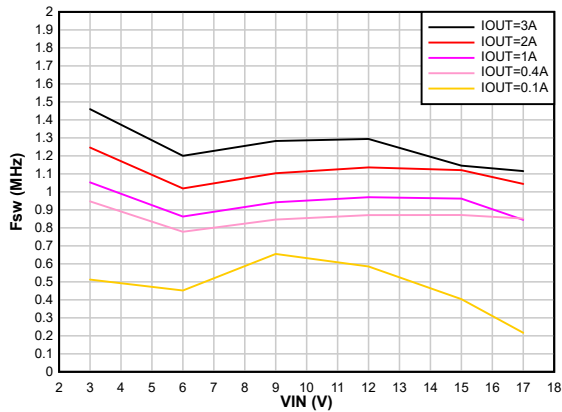

Auto PFM/PWM  $F_{sw} = 1 \text{ MHz}$   
8-56. Switching Frequency vs Input Voltage  
 $V_{OUT} = 0.4 \text{ V}$

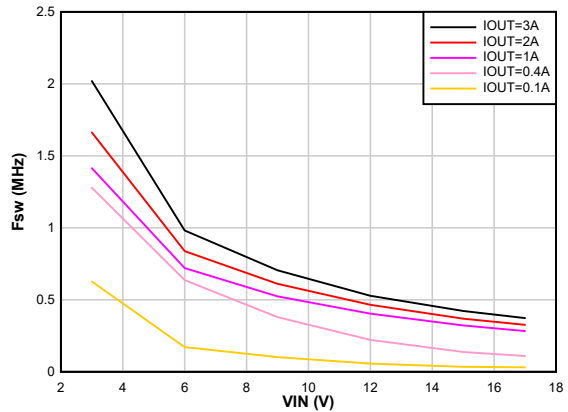

Auto PFM/PWM  $F_{sw} = 2.5 \text{ MHz}$   
8-57. Switching Frequency vs Input Voltage  
 $V_{OUT} = 0.4 \text{ V}$

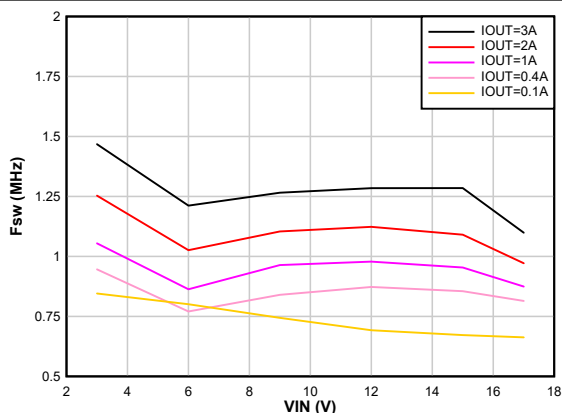

FPWM  $F_{sw} = 1 \text{ MHz}$   
8-58. Switching Frequency vs Input Voltage  
 $V_{OUT} = 0.4 \text{ V}$

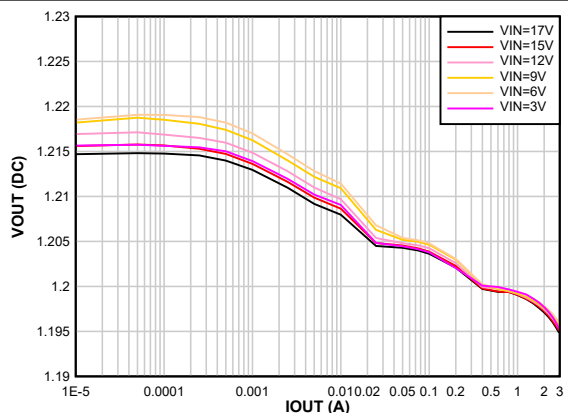

Auto PFM/PWM  $F_{sw} = 1 \text{ MHz}$   
8-59. Output Voltage vs Output Current  
 $V_{OUT} = 1.2 \text{ V}$

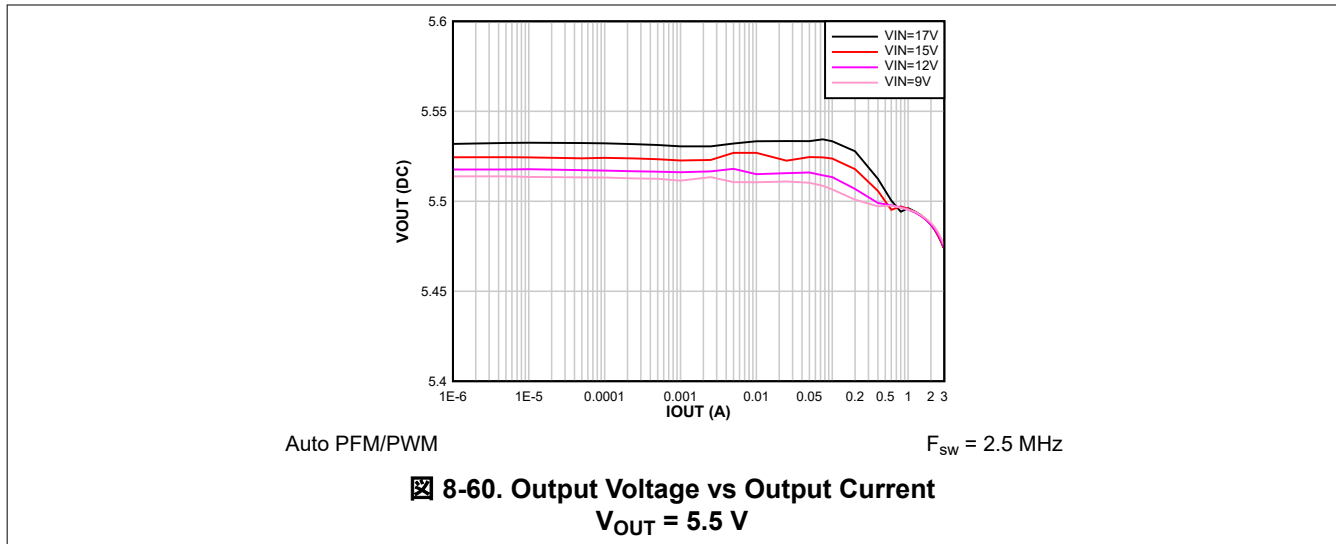

## 8.4 Power Supply Recommendations

The power supply to the TPSM82903 must have a current rating according to the supply voltage, output voltage, and output current of the TPSM82903.

## 8.5 Layout

### 8.5.1 Layout Guidelines

A proper layout is critical for the operation of a switched mode power supply, even more at high switching frequencies. Therefore, the PCB layout of the TPSM82903 demands careful attention to ensure operation and to get the performance specified. A poor layout can lead to issues like poor regulation (both line and load), stability and accuracy weaknesses, increased EMI radiation, bad thermal performance, and noise sensitivity.

- See [8-61](#) for the recommended layout of the TPSM82903, which is designed for common external ground connections. TI recommends placing all components as close as possible to the package pins. The input and output capacitors placement specifically, must be closest to the VIN, VOUT, and GND pins of the TPSM82903.
- Provide low capacitive paths (with respect to all other nodes) for traces with high dv/dt. Therefore, the input and output capacitance must be placed as close as possible to the IC pins and parallel wiring over long distances as well as narrow traces must be avoided. Loops which conduct an alternating current must outline an area as small as possible, as this area is proportional to the energy radiated.
- Sensitive nodes like FB needs to be connected with short wires and not nearby high dv/dt signals. As it carries information about the output voltage, it must be connected as close as possible to the actual output voltage (at the output capacitor). The capacitor on the SS/TR pin as well as the FB resistors, R1 and R2, must be kept close to the module and connect directly to those pins and the system ground plane. The same applies to VSET resistor if VSET is used to scale the output voltage.
- The package uses the pins for power dissipation. Thermal vias on the VIN, VOUT, and GND pins help to spread the heat through the PCB.
- In case of the EN, and MODE/S-CONF need to be tied to the input supply voltage at V<sub>IN</sub>, the connection must be made directly at the input capacitor as indicated in the schematics.
- The SW/NC pin must not be connected to any other traces. For best practice, this pin must be left floating. If the pin is soldered to PCB copper, the pour needs to be: as small as possible, no inner layer connections, no vias, electrically floating, and limited to the pin area as possible.
- Refer to [8-61](#) for an example of component placement, routing and thermal design. The recommended layout is implemented on the EVM and shown in its user's guide.



### 8.5.2 Layout Example

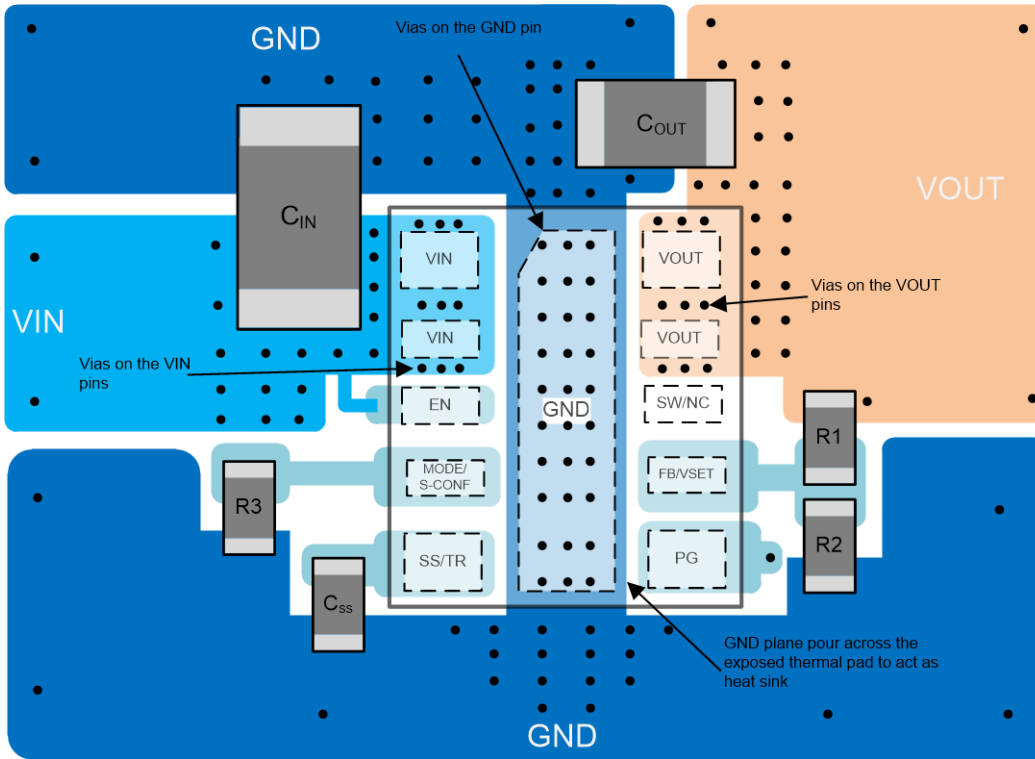

8-61. Layout

### 8.5.2.1 Thermal Considerations

Implementation of power converter modules with low-profile and fine-pitch such as MircoSiP packages typically requires special attention to power dissipation and thermal rise. Many system-dependent issues such as thermal coupling, airflow, added heat sinks and convection surfaces, and the presence of other heat-generating components affect the power-dissipation limits of a given component.

The TPSM82903 is designed for a maximum operating junction temperature ( $T_J$ ) of 125°C. Therefore, the maximum output power is limited by the power losses that can be dissipated over the actual thermal resistance, given by the package and the surrounding PCB structures. If the thermal resistance of the package is given, the size of the surrounding copper area and a proper thermal connection of the module can reduce the thermal resistance. To get an improved thermal behavior, TI recommends to follow the following guidelines:

- Use a multi-layer PCB boards (at least four layers, with 1-oz or more copper).
- Use thermal vias on the GND pin to connect the GND top layer with the GND inner and bottom layers. This helps dissipate the heat across layers.
- Generate as large a GND plane as allowable on the top and bottom layers, especially right near the package. The exposed thermal pad of the device sits right at the middle of the package. This is ideal for thermal dissipation. To take advantage of that, TI recommends the ground plan to cross through the package to allow maximum ground plan connection with the exposed pad. See [Figure 8-61](#) how the north ground pour is connecting with the south ground pour as it crosses through the exposed pad of the package.
- Use thermal vias on the VIN and VOUT pins (as close as possible to the pin) and around input and output capacitors to connect the VIN and VOUT top layer with the inner and bottom layers. This helps dissipate the heat across layers as well as decreases the resistance drop on these traces.
- Use wide and short traces for the main current paths to reduce the parasitic inductance and resistance and helps on thermal dissipation.
- Introduce airflow in the system if possible.
- Refer to [Figure 8-61](#) for an example of component placement, routing and thermal design.

For more details on how to use the thermal parameters, see the [Thermal Characteristics of Linear and Logic Packages Using JEDEC PCB Designs](#) and [Semiconductor and IC Package Thermal Metrics](#) application reports.

If short circuit or overload conditions are present, the device is protected by limiting internal power dissipation.

The device is qualified for long term qualification with a 125°C junction temperature.

## 9 Device and Documentation Support

### 9.1 Device Support

#### 9.1.1 Third-Party Products Disclaimer

TI'S PUBLICATION OF INFORMATION REGARDING THIRD-PARTY PRODUCTS OR SERVICES DOES NOT CONSTITUTE AN ENDORSEMENT REGARDING THE SUITABILITY OF SUCH PRODUCTS OR SERVICES OR A WARRANTY, REPRESENTATION OR ENDORSEMENT OF SUCH PRODUCTS OR SERVICES, EITHER ALONE OR IN COMBINATION WITH ANY TI PRODUCT OR SERVICE.

#### 9.1.2 Development Support

##### 9.1.2.1 Custom Design With WEBENCH® Tools

[Click here](#) to create a custom design using the TPSM82903 device with the WEBENCH® Power Designer.

1. Start by entering the input voltage ( $V_{IN}$ ), output voltage ( $V_{OUT}$ ), and output current ( $I_{OUT}$ ) requirements.
2. Optimize the design for key parameters such as efficiency, footprint, and cost using the optimizer dial.
3. Compare the generated design with other possible solutions from Texas Instruments.

The WEBENCH Power Designer provides a customized schematic along with a list of materials with real-time pricing and component availability.

In most cases, these actions are available:

- Run electrical simulations to see important waveforms and circuit performance
- Run thermal simulations to understand board thermal performance
- Export customized schematic and layout into popular CAD formats
- Print PDF reports for the design, and share the design with colleagues

Get more information about WEBENCH tools at [www.ti.com/WEBENCH](http://www.ti.com/WEBENCH).

### 9.2 Receiving Notification of Documentation Updates

To receive notification of documentation updates, navigate to the device product folder on [ti.com](http://ti.com). Click on *Subscribe to updates* to register and receive a weekly digest of any product information that has changed. For change details, review the revision history included in any revised document.

### 9.3 サポート・リソース

TI E2E™ サポート・フォーラムは、エンジニアが検証済みの回答と設計に関するヒントをエキスパートから迅速かつ直接得ることができる場所です。既存の回答を検索したり、独自の質問をしたりすることで、設計に必要な支援を迅速に得ることができます。

リンクされているコンテンツは、該当する貢献者により、現状のまま提供されるものです。これらは TI の仕様を構成するものではなく、必ずしも TI の見解を反映したものではありません。TI の [使用条件](#) を参照してください。

### 9.4 Trademarks

MicroSiP™, SmartConfig™, and TI E2E™ are trademarks of Texas Instruments.

WEBENCH® is a registered trademark of Texas Instruments.

すべての商標は、それぞれの所有者に帰属します。

### 9.5 Electrostatic Discharge Caution



This integrated circuit can be damaged by ESD. Texas Instruments recommends that all integrated circuits be handled with appropriate precautions. Failure to observe proper handling and installation procedures can cause damage.

ESD damage can range from subtle performance degradation to complete device failure. Precision integrated circuits may be more susceptible to damage because very small parametric changes could cause the device not to meet its published specifications.

### 9.6 Glossary

[TI Glossary](#) This glossary lists and explains terms, acronyms, and definitions.

## 10 Mechanical, Packaging, and Orderable Information

The following pages include mechanical, packaging, and orderable information. This information is the most current data available for the designated devices. This data is subject to change without notice and revision of this document. For browser-based versions of this data sheet, refer to the left-hand navigation.

**PACKAGING INFORMATION**

Orderable Device	Status (1)	Package Type	Package Drawing	Pins	Package Qty	Eco Plan (2)	Lead finish/ Ball material (6)	MSL Peak Temp (3)	Op Temp (°C)	Device Marking (4/5)	Samples
TPSM82903SISR	ACTIVE	uSiP	SIS	11	3000	RoHS & Green	ENEPIG	Level-2-260C-1 YEAR	-40 to 125	TM2903	Samples

(1) The marketing status values are defined as follows:

**ACTIVE:** Product device recommended for new designs.

**LIFEBUY:** TI has announced that the device will be discontinued, and a lifetime-buy period is in effect.

**NRND:** Not recommended for new designs. Device is in production to support existing customers, but TI does not recommend using this part in a new design.

**PREVIEW:** Device has been announced but is not in production. Samples may or may not be available.

**OBSELETE:** TI has discontinued the production of the device.

(2) **RoHS:** TI defines "RoHS" to mean semiconductor products that are compliant with the current EU RoHS requirements for all 10 RoHS substances, including the requirement that RoHS substance do not exceed 0.1% by weight in homogeneous materials. Where designed to be soldered at high temperatures, "RoHS" products are suitable for use in specified lead-free processes. TI may reference these types of products as "Pb-Free".

**RoHS Exempt:** TI defines "RoHS Exempt" to mean products that contain lead but are compliant with EU RoHS pursuant to a specific EU RoHS exemption.

**Green:** TI defines "Green" to mean the content of Chlorine (Cl) and Bromine (Br) based flame retardants meet JS709B low halogen requirements of <=1000ppm threshold. Antimony trioxide based flame retardants must also meet the <=1000ppm threshold requirement.

(3) MSL, Peak Temp. - The Moisture Sensitivity Level rating according to the JEDEC industry standard classifications, and peak solder temperature.

(4) There may be additional marking, which relates to the logo, the lot trace code information, or the environmental category on the device.

(5) Multiple Device Markings will be inside parentheses. Only one Device Marking contained in parentheses and separated by a "~" will appear on a device. If a line is indented then it is a continuation of the previous line and the two combined represent the entire Device Marking for that device.

(6) Lead finish/Ball material - Orderable Devices may have multiple material finish options. Finish options are separated by a vertical ruled line. Lead finish/Ball material values may wrap to two lines if the finish value exceeds the maximum column width.

**Important Information and Disclaimer:**The information provided on this page represents TI's knowledge and belief as of the date that it is provided. TI bases its knowledge and belief on information provided by third parties, and makes no representation or warranty as to the accuracy of such information. Efforts are underway to better integrate information from third parties. TI has taken and continues to take reasonable steps to provide representative and accurate information but may not have conducted destructive testing or chemical analysis on incoming materials and chemicals. TI and TI suppliers consider certain information to be proprietary, and thus CAS numbers and other limited information may not be available for release.

In no event shall TI's liability arising out of such information exceed the total purchase price of the TI part(s) at issue in this document sold by TI to Customer on an annual basis.



# PACKAGE OUTLINE

## SIS0011A

## MicroSiP™ - 1.6 mm max height

MICRO SYSTEM IN PACKAGE

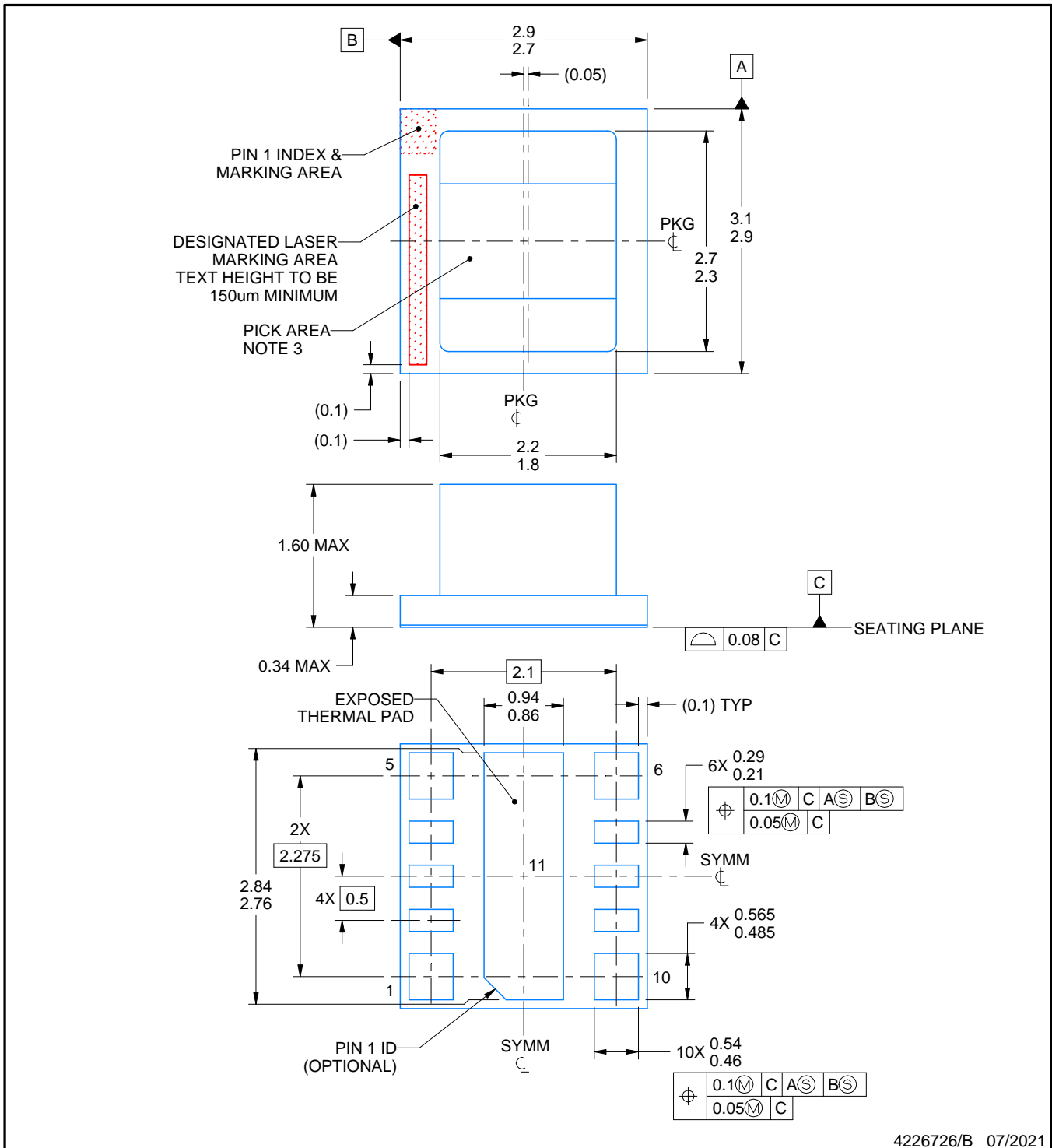

4226726/B 07/2021

MicroSiP is a trademark of Texas Instruments

### NOTES:

- All linear dimensions are in millimeters. Any dimensions in parenthesis are for reference only. Dimensioning and tolerancing per ASME Y14.5M.
- This drawing is subject to change without notice.
- Pick and place nozzle  $\phi$  1.3 mm or smaller recommended.
- The package thermal pad must be soldered to the printed circuit board for thermal and mechanical performance.

# EXAMPLE BOARD LAYOUT

SIS0011A

MicroSiP™ - 1.6 mm max height

MICRO SYSTEM IN PACKAGE

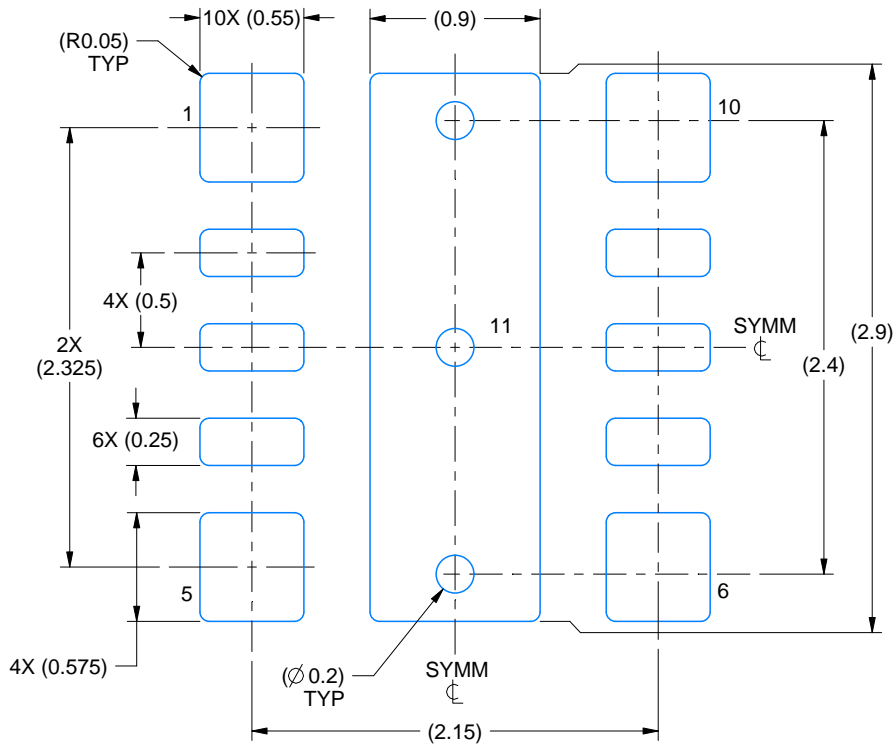

LAND PATTERN EXAMPLE  
SOLDER MASK DEFINED  
SCALE:25X



SOLDER MASK DETAIL

4226726/B 07/2021

NOTES: (continued)

5. This package is designed to be soldered to a thermal pad on the board. For more information, see Texas Instruments literature number SLUA271 ([www.ti.com/lit/slua271](http://www.ti.com/lit/slua271)).
6. Vias are optional depending on application, refer to device data sheet. If any vias are implemented, refer to their locations shown on this view. It is recommended that vias under paste be filled, plugged or tented

# EXAMPLE STENCIL DESIGN

SIS0011A

MicroSiP™ - 1.6 mm max height

MICRO SYSTEM IN PACKAGE

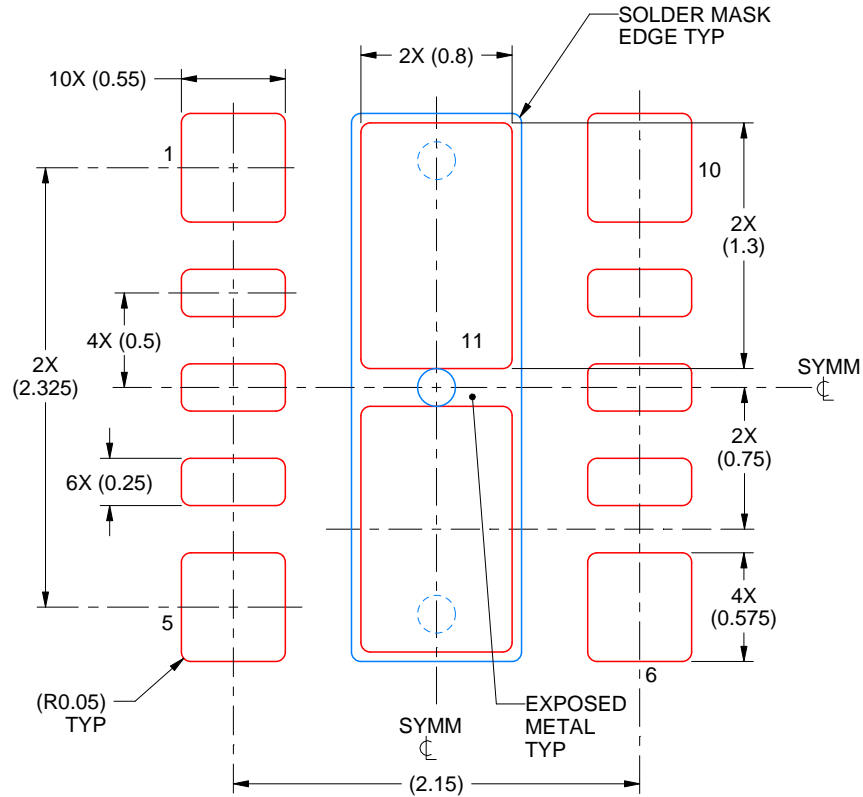

SOLDER PASTE EXAMPLE  
BASED ON 0.125 mm THICK STENCIL

EXPOSED PAD  
80% PRINTED SOLDER COVERAGE BY AREA  
SCALE:25X

4226726/B 07/2021

NOTES: (continued)

7. Laser cutting apertures with trapezoidal walls and rounded corners may offer better paste release. IPC-7525 may have alternate design recommendations.



## 重要なお知らせと免責事項

TI は、技術データと信頼性データ (データシートを含みます)、設計リソース (リファレンス・デザインを含みます)、アプリケーションや設計に関する各種アドバイス、Web ツール、安全性情報、その他のリソースを、欠陥が存在する可能性のある「現状のまま」提供しており、商品性および特定目的に対する適合性の黙示保証、第三者の知的財産権の非侵害保証を含むいかなる保証も、明示的または黙示的にかかわらず拒否します。

これらのリソースは、TI 製品を使用する設計の経験を積んだ開発者への提供を意図したものです。(1) お客様のアプリケーションに適した TI 製品の選定、(2) お客様のアプリケーションの設計、検証、試験、(3) お客様のアプリケーションに該当する各種規格や、その他のあらゆる安全性、セキュリティ、規制、または他の要件への確実な適合に関する責任を、お客様のみが単独で負うものとし、

上記の各種リソースは、予告なく変更される可能性があります。これらのリソースは、リソースで説明されている TI 製品を使用するアプリケーションの開発の目的でのみ、TI はその使用をお客様に許諾します。これらのリソースに関して、他の目的で複製することや掲載することは禁止されています。TI や第三者の知的財産権のライセンスが付与されている訳ではありません。お客様は、これらのリソースを自身で使用した結果発生するあらゆる申し立て、損害、費用、損失、責任について、TI およびその代理人を完全に補償するものとし、TI は一切の責任を拒否します。

TI の製品は、[TI の販売条件](#)、または [ti.com](https://www.ti.com) やかかる TI 製品の関連資料などのいずれかを通じて提供する適用可能な条項の下で提供されています。TI がこれらのリソースを提供することは、適用される TI の保証または他の保証の放棄の拡大や変更を意味するものではありません。

お客様がいかなる追加条項または代替条項を提案した場合でも、TI はそれらに異議を唱え、拒否します。

郵送先住所 : Texas Instruments, Post Office Box 655303, Dallas, Texas 75265  
Copyright © 2023, Texas Instruments Incorporated