

**ABSTRACT**

This user's guide describes the TPS23731 evaluation module (EVM). The TPS23731 evaluation module (TPS23731EVM-095) contains evaluation and reference circuitry for the TPS23731, which is a IEEE802.3bt Class 4 PoE PD, EA Gen 2 Ready, controller suitable for Class 4 (25.5 W) PoE PD applications. The TPS23731EVM-095 is targeted for 5-V primary side regulated synch flyback with high efficiency 25-W solutions.

Table of Contents

1 Introduction	2
1.1 Features.....	2
1.2 Applications.....	2
2 Electrical Specifications	2
3 Description	3
4 General Configuration and Description	4
4.1 Physical Access.....	4
5 TPS23731EVM-095 Performance Data	5
5.1 Startup Response.....	5
5.2 Transient Response.....	5
5.3 Efficiency.....	6
5.4 Load Regulation.....	6
5.5 Hiccup Performance During an Output Short and Recovery.....	7
5.6 Bode Plots.....	8
6 EVM Assembly Drawings and Layout Guidelines	9
6.1 PCB Drawings.....	9
6.2 Layout Guidelines.....	9
6.3 EMI Containment.....	10
7 Schematic	11
8 Bill of Materials	13
9 Revision History	18

List of Figures

Figure 5-1. DC/DC Startup.....	5
Figure 5-2. Transient Response from 500 mA to 5 A for a 48-V Input.....	5
Figure 5-3. Efficiency of the TPS23731EVM-095.....	6
Figure 5-4. TPS23731EVM-095 Load Regulation.....	6
Figure 5-5. DC/DC Hiccup Performance During an Output Short.....	7
Figure 5-6. Bode Plot Response of the TPS23731EVM-095.....	8
Figure 6-1. Top-Side Routing and Component Placement.....	9
Figure 6-2. Layer 2 Routing.....	9
Figure 6-3. Layer 3 Routing.....	9
Figure 6-4. Bottom Side Routing and Component Placement.....	9
Figure 7-1. TPS23731EVM-095 Schematic Page One.....	11
Figure 7-2. TPS23731EVM-095 Schematic Page Two.....	12

List of Tables

Table 2-1. TPS23731EVM-095 Electrical and Performance Specifications at 25°C.....	2
Table 4-1. Connector Inputs.....	4
Table 4-2. Jumper Functionality.....	4
Table 8-1. TPS23731EVM-095 Bill of Materials.....	13

Trademarks

All trademarks are the property of their respective owners.

1 Introduction

The TPS23731EVM-095 allows reference circuitry evaluation of the TPS23731 device. It contains input and output power connectors and an array of onboard test points for circuit evaluation.

1.1 Features

- IEEE802.3bt Class 4 compliant PoE PD
- Integrated PWM controller for active clamp forward configuration
- Frequency dithering for EMI reduction
- Soft-start control with advanced startup and Hiccup mode overload protection
- Soft-stop shutdown

1.2 Applications

- IEEE 802.3bt compliant devices up to Class 4
- Video and VoIP telephones
- Access points
- Pass-through system
- Security cameras

2 Electrical Specifications

Table 2-1. TPS23731EVM-095 Electrical and Performance Specifications at 25°C

Design Example Specifications					
Parameter	Test Conditions	MIN	TYP	MAX	Unit
Power interface					
Input voltage range	Applied to the PoE Input	37	48	57	V
	Applied to the Adapter Input		48		
Detection voltage	At device terminals	2.7		10.1	
Classification voltage	At device terminals	14.5		20.5	
Classification			4		
Inrush current limit			140		mA
Operating current limit			0.925		A
DC-to-DC Converter					
Output voltage	$V_{IN} = 48\text{ V}$, $i_{load} \leq i_{load}(\text{MAX})$		5		V
Output current	$37\text{ V} \leq V_{IN} \leq 57\text{ V}$		5		A
Output ripple voltage peak-to-peak	$V_{IN} = 48\text{ V}$, $i_{load} = 1\text{ A}$		30		mV
Efficiency, end to end	$V_{IN} = 48\text{ V}$, $i_{load} = 500\text{ mA}$		58		%
	$V_{IN} = 48\text{ V}$, $i_{load} = 2.5\text{ A}$		86		
	$V_{IN} = 48\text{ V}$, $i_{load} = 5\text{ A}$		89		
Switching frequency			250		kHz

3 Description

The TPS23731VM-095 enables full evaluation of the TPS23731 device. Refer to the schematic shown in [Figure 7-1](#) and [Figure 7-2](#). Ethernet power is applied from J1 and is dropped to the bridge rectifier. The Power over Ethernet (PoE) transformer needed to transfer power or data is T1. The Bob Smith Terminations help balance the Ethernet cabled impedance and are critical for ESD and EMI or EMC performance. The EMI or EMC filter and transient protection for the TPS23731 device are at the output of the bridge rectifier.

Input power can also be applied at J3 from a DC source when power at J1 is not present.

The TPS23731 (U1) PD and DC-to-DC converter circuitry is shown in Figure 1. R28 provides the detection signature. The switched side of the PD controller is to the right of U1. The TPS23731 RTN pin(s) provides inrush limited turn on and charge of the bulk capacitor, C12.

The DC-to-DC converter is a high-efficiency primary side regulated synch flyback.

R34 provides a means for error injection to measure the frequency response of the converter.

4 General Configuration and Description

4.1 Physical Access

Table 4-1 lists the EVM connector inputs. Table 4-2 describes the jumper functionality.

Table 4-1. Connector Inputs

Connector	Description
J1	PoE (Power+Data) input
J2	Data-only Ethernet
J3	Adapter input
J4	Output voltage connector

Table 4-2. Jumper Functionality

Jumper	Description
J7	APD selection. Short Pins 1 and 2 to turn OFF APD, Short Pins 2 and 3 to turn ON APD. Leave floating for input voltage related APD threshold
J14	Dithering selection. Short Pins 1 and 2 to turn OFF Dithering, Short Pins 2 and 3 to turn ON Dithering. Do NOT leave floating.
J18	Short to disable autoMPS. Float to enable autoMPS
J6	Logic or visual signal for APDO and T2P. Short Pins 1 and 2 visual LED signal, Short Pins 2 and 3 to use a logic voltage signal.
J11	Short to bypass the output inductor (recommended).
J15	Output LED indicator

5 TPS23731EVM-095 Performance Data

5.1 Startup Response

Figure 5-1 shows the DC/DC startup response of the TPS23731EVM-095.

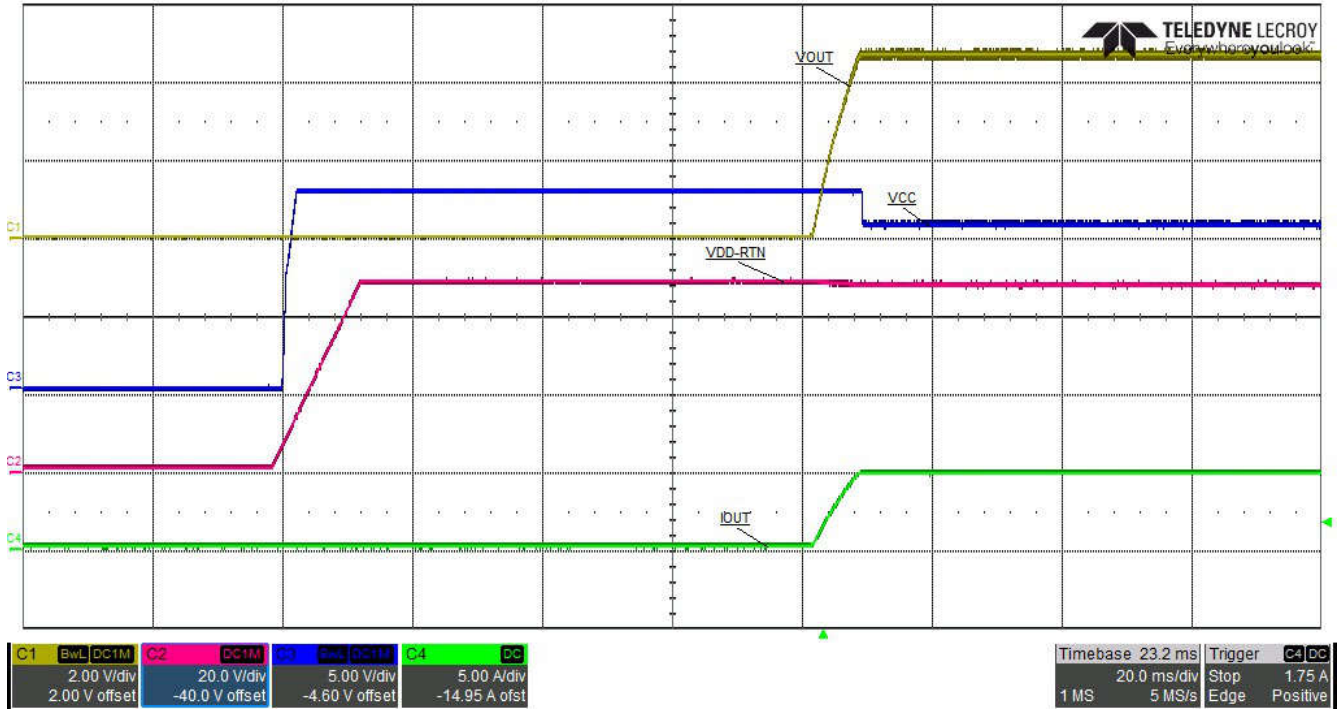

Figure 5-1. DC/DC Startup

5.2 Transient Response

Figure 5-2 shows the transient response of the TPS23731EVM-095.

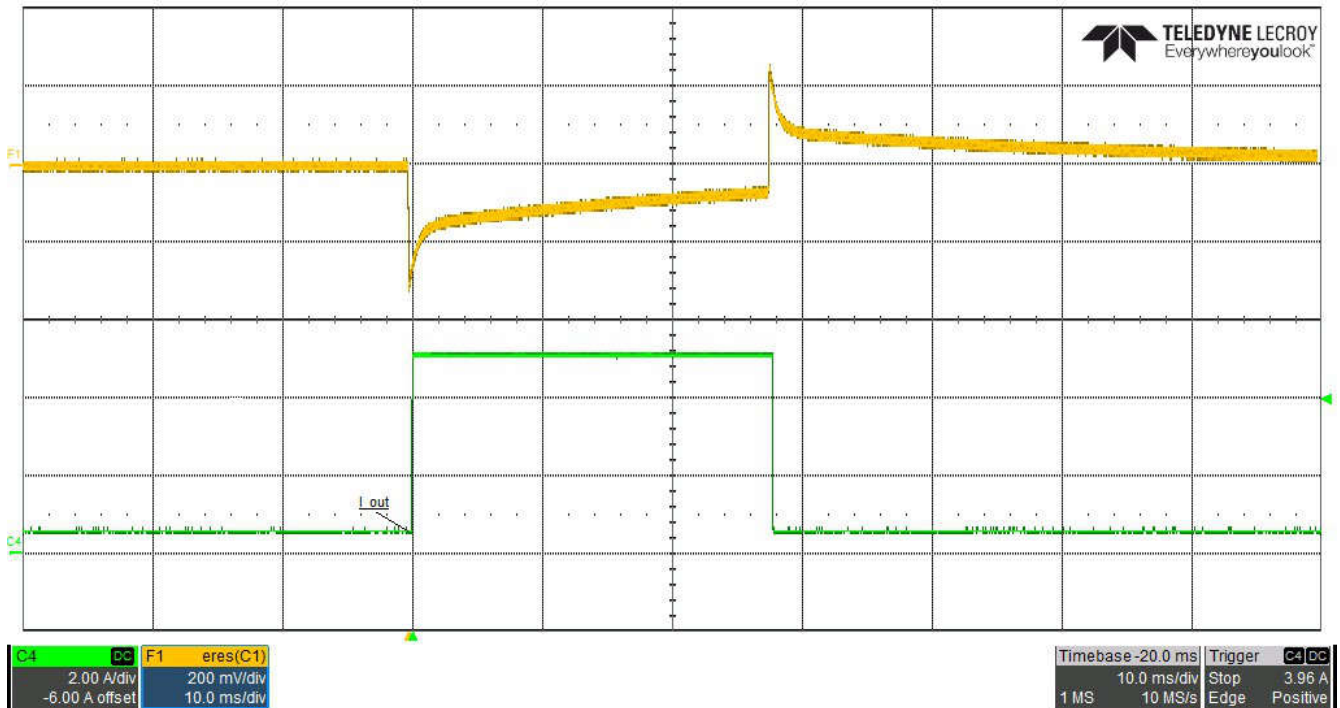

Figure 5-2. Transient Response from 500 mA to 5 A for a 48-V Input

5.3 Efficiency

Figure 5-3 shows the efficiency of the TPS23731EVM-095

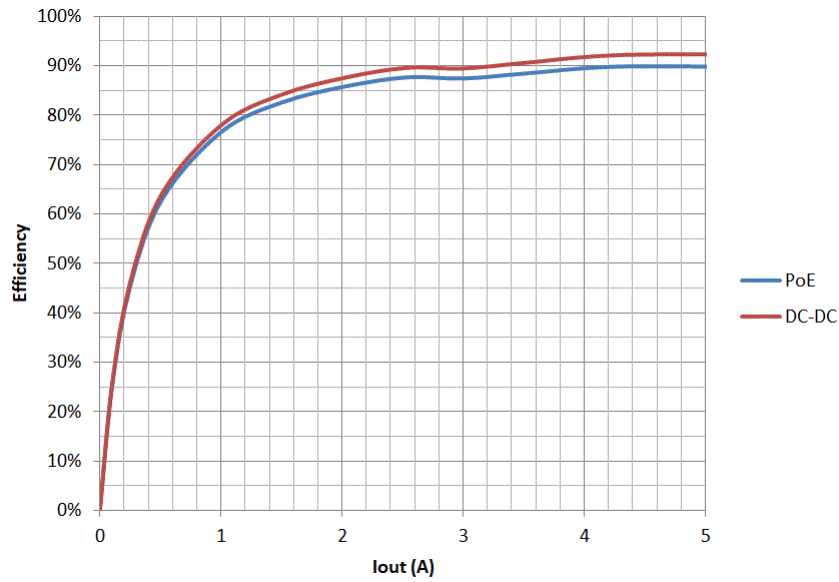

Figure 5-3. Efficiency of the TPS23731EVM-095

5.4 Load Regulation

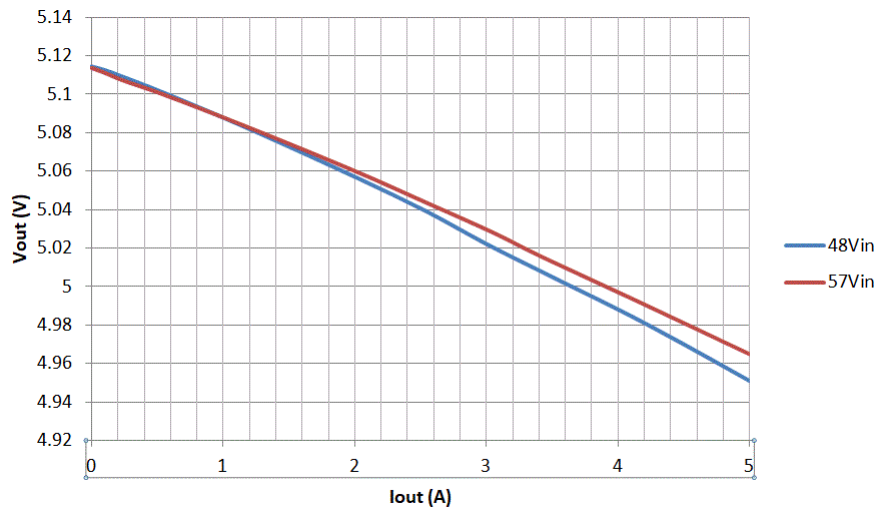

Figure 5-4. TPS23731EVM-095 Load Regulation

5.5 Hiccup Performance During an Output Short and Recovery

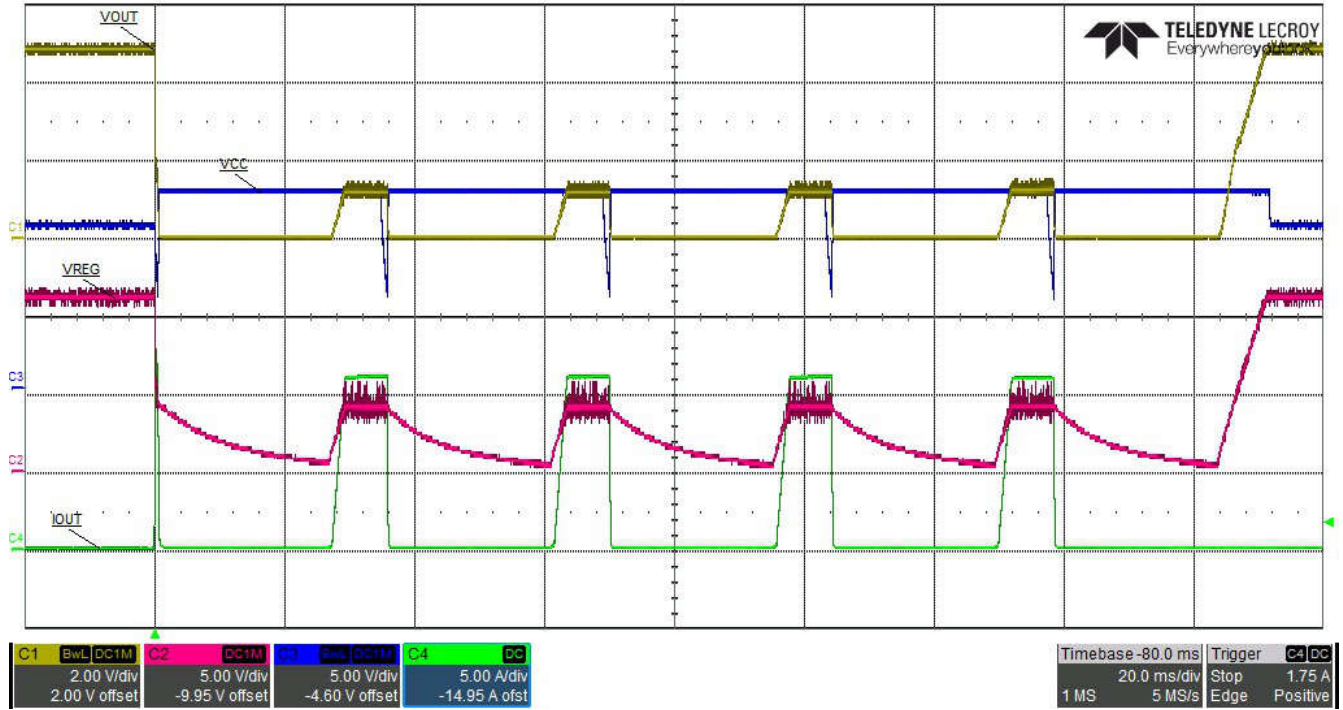

Figure 5-5. DC/DC Hiccup Performance During an Output Short

5.6 Bode Plots

Figure 5-6 show the 500mA- and 5-A load bode plots.

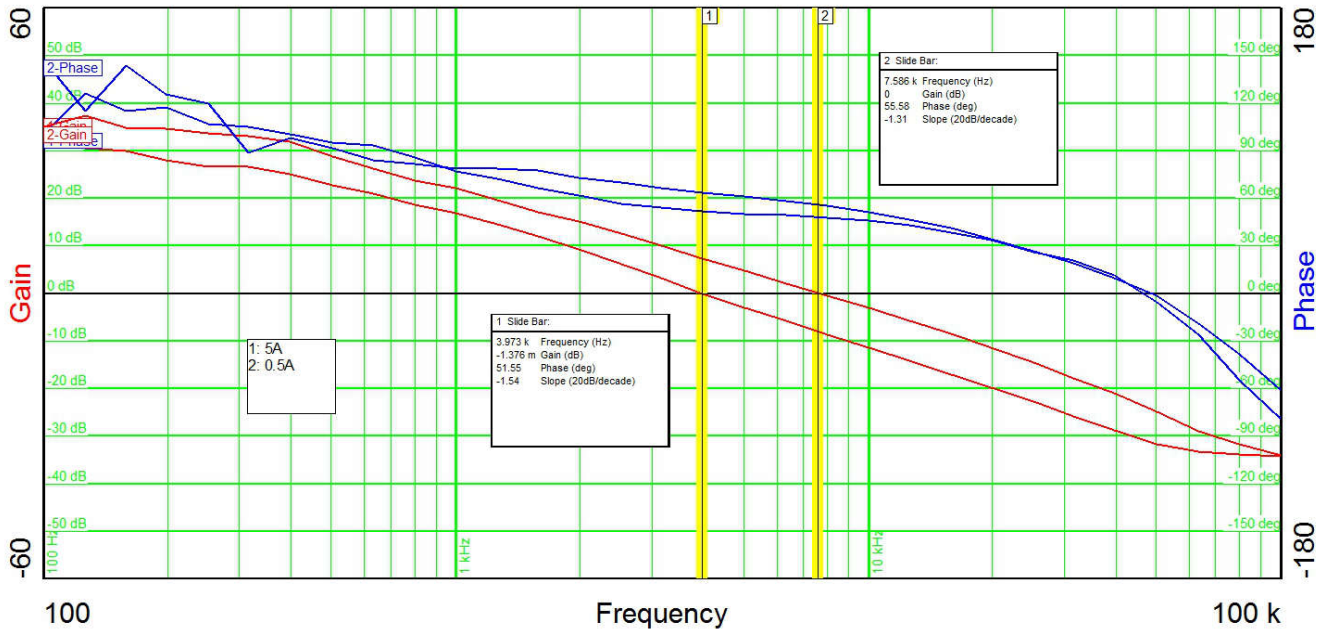

Figure 5-6. Bode Plot Response of the TPS23731EVM-095

6 EVM Assembly Drawings and Layout Guidelines

6.1 PCB Drawings

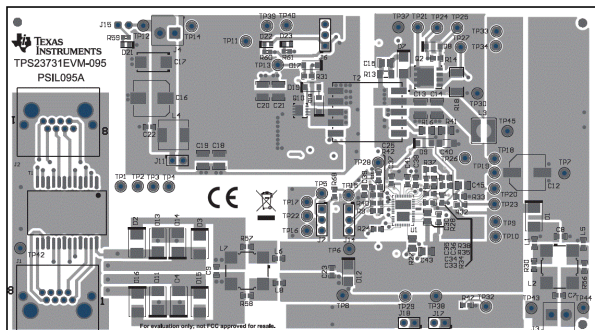

Figure 6-1. Top-Side Routing and Component Placement

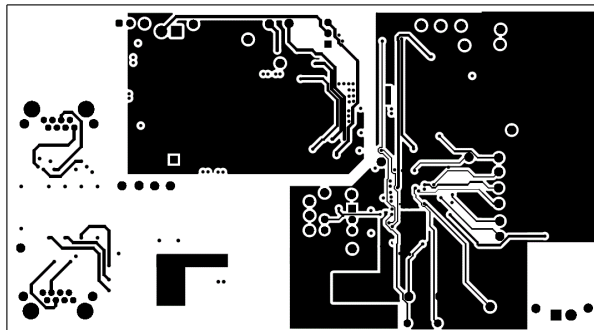

Figure 6-2. Layer 2 Routing

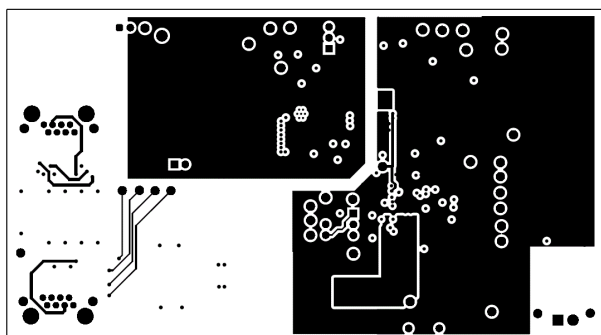

Figure 6-3. Layer 3 Routing

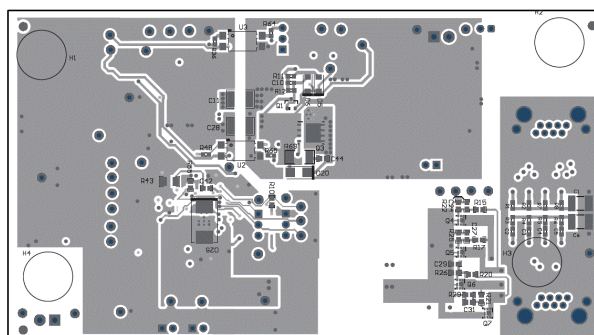

Figure 6-4. Bottom Side Routing and Component Placement

6.2 Layout Guidelines

The layout of the PoE front end should follow power and EMI or ESD best-practice guidelines. A basic set of recommendations includes:

- It is recommended having at least 8 vias (PAD G) and 5 vias on (PAD S) connecting the exposed thermal pad through a top layer plane (2 oz copper recommended) to a bottom VSS plane (2 oz. copper recommended) to help with thermal dissipation.
- Place the primary MOSFET near the power transformer and keep the current sense resistor close to source of the MOSFET to minimize the primary loop. The same is true for the secondary MOSFETs. Keep the MOSFETs close to the transformer, and associated components as close together as possible to minimize the loop.
- Parts placement must be driven by power flow in a point-to-point manner; RJ-45, Ethernet transformer, diode bridges, TVS and 0.1- μ F capacitor, and TPS23731 converter input bulk capacitor.
- Make all leads as short as possible with wide power traces and paired signal and return.
- No crossovers of signals from one part of the flow to another are allowed.
- Spacing consistent with safety standards like IEC60950 must be observed between the 48-V input voltage rails and between the input and an isolated converter output.
- Use large copper fills and traces on SMT power-dissipating devices, and use wide traces or overlay copper fills in the power path.
- Place the Schottky diode between VSS and RTN as close to the IC as possible, preferably on directly on the opposite side of the board (ex. The TPS23731EVM-095 places the IC on the top side, so the diode is on the bottom side directly underneath it).

The DC-to-DC converter layout benefits from basic rules such as:

- Having at least 4 vias (VDD) near the power transformer pin connected to VDD through multiple layer planes to help with thermal dissipation of the power transformer.
- Pair signals to reduce emissions and noise, especially the paths that carry high-current pulses, which include the power semiconductors and magnetics
- Minimize the trace length of high current power semiconductors and magnetic components
- Use the ground plane for the switching currents carefully
- Keep the high-current and high-voltage switching away from low-level sensing circuits including those outside the power supply
- Proper spacing around the high-voltage sections of the converter

6.3 EMI Containment

- Use compact loops for dv/dt and di/dt circuit paths (power loops and gate drives)
- Use minimal, yet thermally adequate, copper areas for heat sinking of components tied to switching nodes (minimize exposed radiating surface). Hide copper associated with switching nodes under shielded magnetics, where possible
- Use copper ground planes (possible stitching) and top-layer copper floods (surround circuitry with ground floods)
- Use a 4-layer PCB, if economically feasible (for better grounding)
- Minimize the amount of copper area associated with input traces (to minimize radiated pickup)
- Heat sink the quiet side of components instead of the switching side, where possible (like the output side of inductor)
- Use Bob Smith terminations, Bob Smith EFT capacitor, and Bob Smith plane. Use Bob Smith plane as a ground shield on input side of PCB (creating a phantom or literal earth ground)
- Use LC filter at DC-to-DC input
- Dampen high-frequency ringing on all switching nodes, if present (allow for possible snubbers)
- Control rise times with gate-drive resistors and possibly snubbers
- Switching frequency considerations
- Use of EMI bridge capacitor across isolation boundary (isolated topologies)
- Observe the polarity dot on inductors (embed noisy end)
- Use of ferrite beads on input (allow for possible use of beads or 0- Ω resistors)
- Maintain physical separation between input-related circuitry and power circuitry (use ferrite beads as boundary line)
- Balance efficiency versus acceptable noise margin
- Possible use of common-mode inductors
- Possible use of integrated RJ-45 jacks (shielded with internal transformer and Bob Smith terminations)
- End-product enclosure considerations (shielding)

7 Schematic

Figure 7-1 and Figure 7-2 illustrate the EVM schematics.

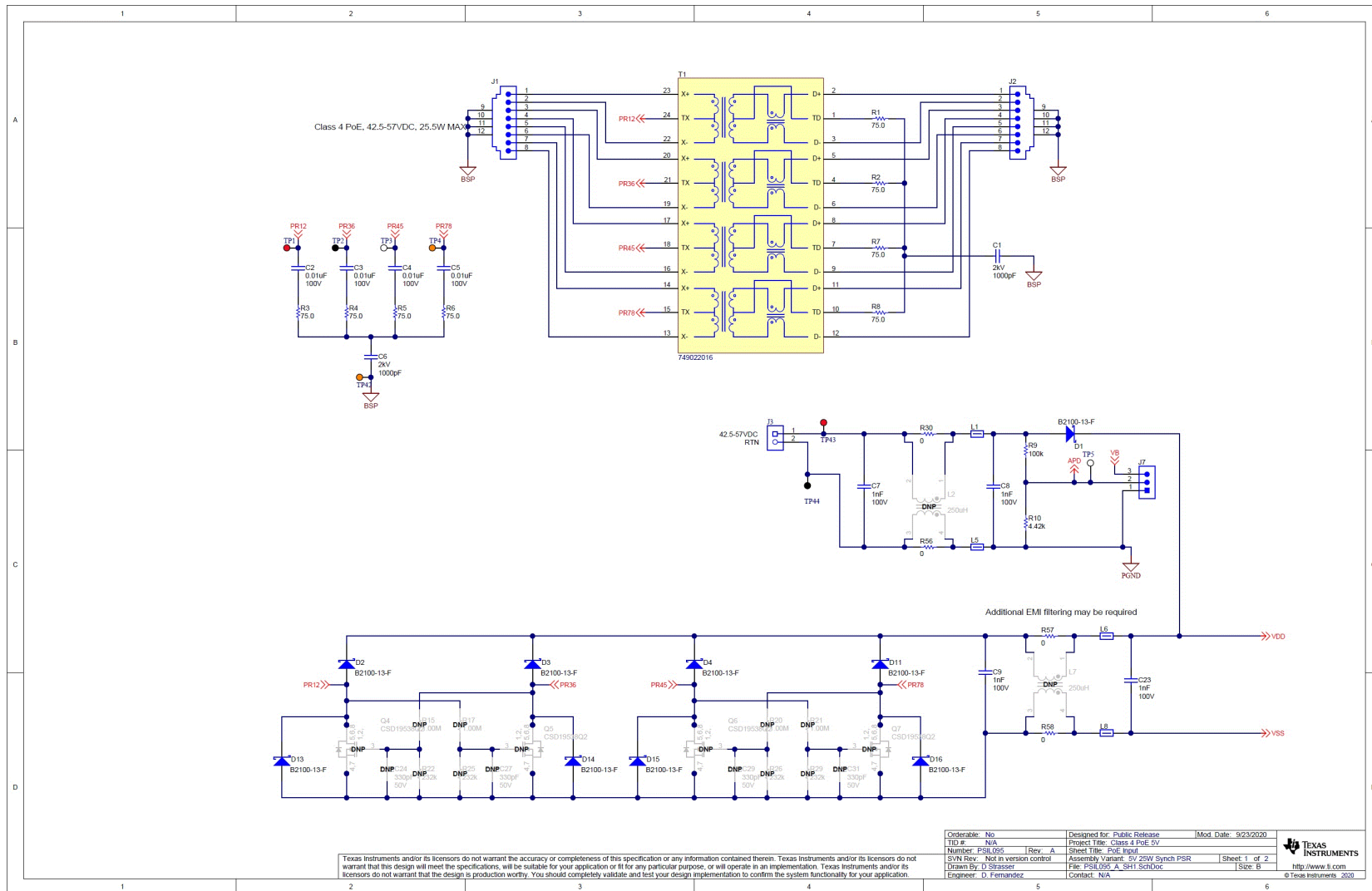

Figure 7-1. TPS23731EVM-095 Schematic Page One

Schematic

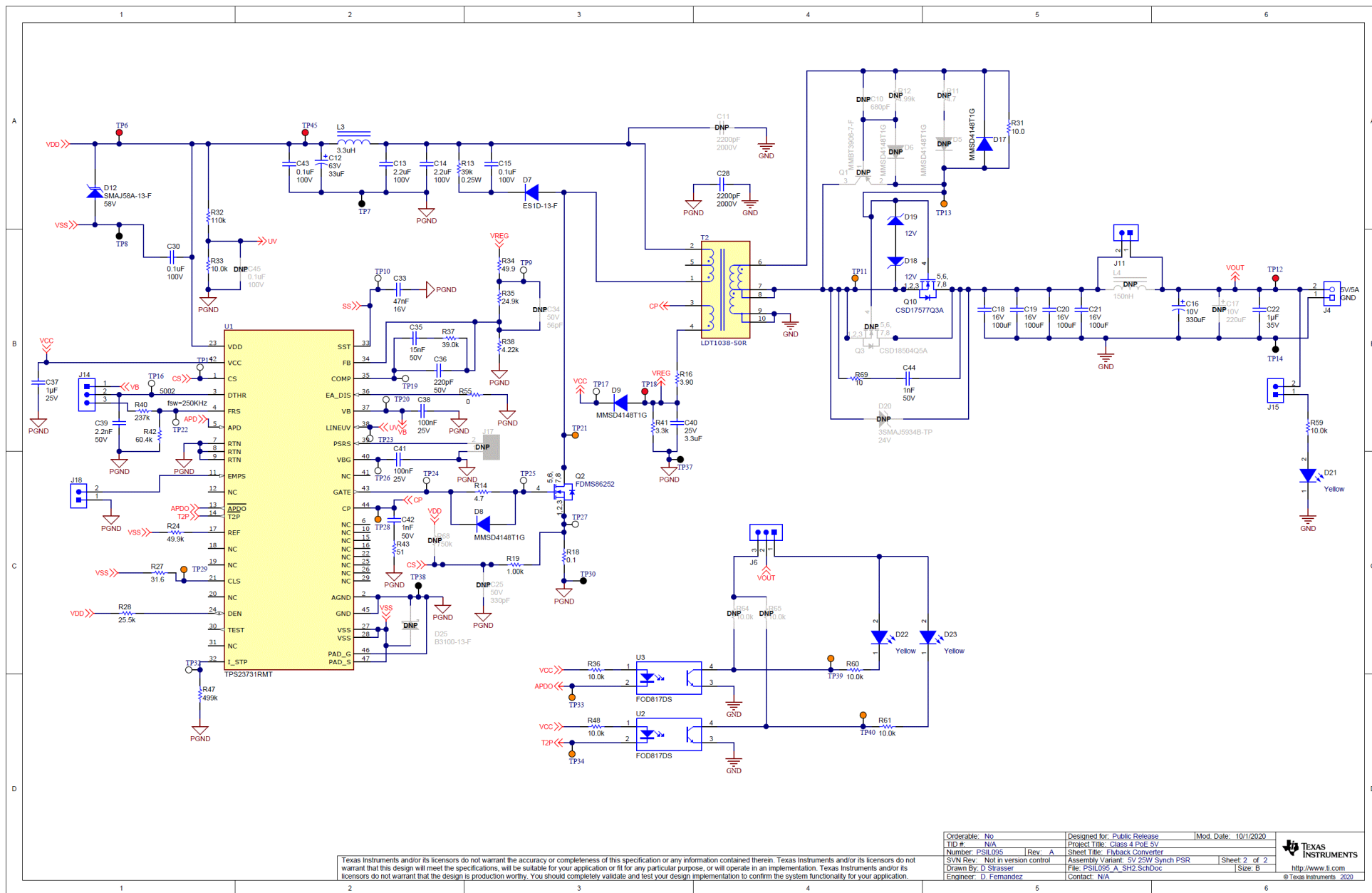

Figure 7-2. TPS23731EVM-095 Schematic Page Two

8 Bill of Materials

Table 8-1 lists the TPS23731EVM-095 Bill of Materials (BOM).

Table 8-1. TPS23731EVM-095 Bill of Materials

Designator	QTY	Value	Description	Package Reference	Part Number	Manufacturer	Alternate Part Number	Alternate Manufacturer
!PCB1	1		Printed Circuit Board		PSIL095	Any		
C1, C6	2	1000 pF	CAP, CERM, 1000 pF, 2000 V, +/- 10%, X7R, 1812	1812	GR443QR73D102KW01L	MuRata		
C2, C3, C4, C5	4	0.01uF	CAP, CERM, 0.01 uF, 100 V, +/- 10%, X7R, 0603	0603	GRM188R72A103KA01D	MuRata		
C7, C8, C9, C23	4	1000 pF	CAP, CERM, 1000 pF, 100 V, +/- 10%, X7R, 0603	0603	C1608X7R2A102K080AA	TDK		
C12	1	33uF	CAP, AL, 33 uF, 63 V, +/- 20%, 0.65 ohm, AEC-Q200 Grade 2, SMD	SMT Radial F	EEE-FK1J330P	Panasonic		
C13, C14	2	2.2uF	CAP, CERM, 2.2 uF, 100 V, +/- 10%, X7R, 1210	1210	GRM32ER72A225KA35L	MuRata		
C15, C30, C43	3	0.1uF	CAP, CERM, 0.1 uF, 100 V, +/- 10%, X7R, 0805	0805	C2012X7R2A104K125AA	TDK		
C16	1	330uF	CAP, Aluminum Polymer, 330 uF, 10 V, +/- 20%, 0.017 ohm, 8x10 SMD	8x10	10SVP330M	Panasonic		
C18, C19, C20, C21	4	100uF	CAP, CERM, 100 uF, 16 V, +/- 20%, X5R, 1210	1210	C1210C107M4PAC7800	Kemet		
C22	1	1uF	CAP, CERM, 1 uF, 35 V, +/- 10%, X7R, AEC-Q200 Grade 0, 0603	0603	GMK107AB7105KAHT	Taiyo Yuden		
C28	1	2200 pF	CAP, CERM, 2200 pF, 2000 V, +/- 10%, X7R, 1812	1812	C4532X7R3D222K130KA	TDK		
C33	1	0.047uF	CAP, CERM, 0.047 uF, 16 V, +/- 10%, X7R, 0603	0603	GRM188R71C473KA01D	MuRata		
C35	1	0.015uF	CAP, CERM, 0.015 uF, 50 V, +/- 10%, X7R, AEC-Q200 Grade 1, 0603	0603	C1608X7R1H153K080AA	TDK		
C36	1	220 pF	CAP, CERM, 220 pF, 50 V, +/- 10%, X7R, 0603	0603	GRM188R71H221KA01D	MuRata		
C37	1	1uF	CAP, CERM, 1 uF, 25 V, +/- 10%, X7R, 0603	0603	GRJ188R71E105KE11D	MuRata		
C38, C41	2	0.1uF	CAP, CERM, 0.1 uF, 25 V, +/- 5%, X7R, 0603	0603	C0603C104J3RACTU	Kemet		
C39	1	2200 pF	CAP, CERM, 2200 pF, 50 V, +/- 10%, X7R, 0603	0603	C0603C222K5RAC	Kemet		
C40	1	3.3uF	CAP, CERM, 3.3 uF, 25 V, +/- 10%, X7R, 1206	1206	GRM31CR71E335KA88L	MuRata		

Table 8-1. TPS23731EVM-095 Bill of Materials (continued)

Designator	QTY	Value	Description	Package Reference	Part Number	Manufacturer	Alternate Part Number	Alternate Manufacturer
C42, C44	2	1000 pF	CAP, CERM, 1000 pF, 50 V, +/- 10%, X7R, 0603	0603	GRM188R71H102KA01D	MuRata		
D1, D2, D3, D4, D11, D13, D14, D15, D16	9	100 V	Diode, Schottky, 100 V, 2 A, SMB	SMB	B2100-13-F	Diodes Inc.		
D7	1	200 V	Diode, Ultrafast, 200 V, 1 A, SMA	SMA	ES1D-13-F	Diodes Inc.		
D8, D9, D17	3	100 V	Diode, Switching, 100 V, 0.2 A, SOD-123	SOD-123	MMSD4148T1G	ON Semiconductor		
D12	1	58 V	Diode, TVS, Uni, 58 V, SMA	SMA	SMAJ58A-13-F	Diodes Inc.		
D18, D19	2	12 V	Diode, Zener, 12 V, 500 mW, SOD-123	SOD-123	MMSZ5242B-7-F	Diodes Inc.		
D21, D22, D23	3	Yellow	LED, Yellow, SMD	LED_0603	150060YS75000	Wurth Elektronik		
FID1, FID2, FID3, FID4, FID5, FID6	6		Fiducial mark. There is nothing to buy or mount.	N/A	N/A	N/A		
H1, H2, H3, H4	4		Bumpon, Hemisphere, 0.44 X 0.20, Clear	Transparent Bumpon	SJ-5303 (CLEAR)	3M		
J1, J2	2		RJ45, No LED, tab up, R/A, TH	16.26x14.54x15.75	1-406541-1	TE Connectivity		
J3, J4	2		Terminal Block, 3.5mm Pitch, 2x1, TH	7.0x8.2x6.5mm	ED555/2DS	On-Shore Technology		
J6, J7, J14	3		Header, 100mil, 3x1, Tin, TH	Header, 3x1, 100mil, TH	5-146278-3	TE Connectivity		
J11, J18	2		Header, 100mil, 2x1, Tin, TH	Header, 2x1, 100mil, TH	5-146278-2	TE Connectivity		
J15	1		Header, 100mil, 2x1, Gold, TH	2x1 Header	TSW-102-07-G-S	Samtec		
L1, L5, L6, L8	4	300 ohm	Ferrite Bead, 300 ohm @ 100 MHz, 2 A, 0603	0603	742792641	Wurth Elektronik		
L3	1	3.3uH	Inductor, Shielded Drum Core, Ferrite, 3.3 uH, 1.8 A, 0.055 ohm, SMD	WE-TPC-M1	744042003	Wurth Elektronik		
Q2	1	150 V	MOSFET, N-CH, 150 V, 4.6 A, PQFN08A	PQFN08A	FDMS86252	Fairchild Semiconductor		
Q10	1	30 V	MOSFET, N-CH, 30 V, 19 A, DNH0008A (VSONP-8)	DNH0008A	CSD17577Q3A	Texas Instruments		
R1, R2, R3, R4, R5, R6, R7, R8	8	75.0	RES, 75.0, 1%, 0.1 W, AEC-Q200 Grade 0, 0603	0603	CRCW060375R0FKEA	Vishay-Dale		
R9	1	100k	RES, 100 k, 1%, 0.1 W, AEC-Q200 Grade 0, 0603	0603	CRCW0603100KFKEA	Vishay-Dale		
R10	1	4.42k	RES, 4.42 k, 1%, 0.1 W, AEC-Q200 Grade 0, 0603	0603	CRCW06034K42FKEA	Vishay-Dale		

Table 8-1. TPS23731EVM-095 Bill of Materials (continued)

Designator	QTY	Value	Description	Package Reference	Part Number	Manufacturer	Alternate Part Number	Alternate Manufacturer
R13	1	39k	RES, 39 k, 5%, 0.25 W, AEC-Q200 Grade 0, 1206	1206	CRCW120639K0JNE A	Vishay-Dale		
R14	1	4.7	RES, 4.7, 5%, 0.1 W, AEC-Q200 Grade 0, 0603	0603	CRCW06034R70JNE A	Vishay-Dale		
R16	1	3.90	RES, 3.90, 1%, 0.125 W, AEC-Q200 Grade 0, 0805	0805	ERJ-6RQF3R9V	Panasonic		
R18	1	0.1	RES, 0.1, 1%, 0.5 W, 2010	2010	ERJ-L1DKF10CU	Panasonic		
R19	1	1.00k	RES, 1.00 k, 1%, 0.1 W, 0603	0603	RC0603FR-071KL	Yageo		
R24	1	49.9k	RES, 49.9 k, 1%, 0.1 W, AEC-Q200 Grade 0, 0603	0603	CRCW060349K9FKE A	Vishay-Dale		
R27	1	31.6	RES, 31.6, 1%, 0.125 W, AEC-Q200 Grade 0, 0805	0805	CRCW080531R6FKE A	Vishay-Dale		
R28	1	25.5k	RES, 25.5 k, 1%, 0.1 W, 0603	0603	RC0603FR-0725K5L	Yageo		
R30, R55, R56, R57, R58	5	0	RES, 0, 5%, 0.1 W, AEC-Q200 Grade 0, 0603	0603	ERJ-3GEY0R00V	Panasonic		
R31	1	10.0	RES, 10.0, 1%, 0.1 W, AEC-Q200 Grade 0, 0603	0603	CRCW060310R0FKE A	Vishay-Dale		
R32	1	110k	RES, 110 k, 1%, 0.1 W, AEC-Q200 Grade 0, 0603	0603	CRCW0603110KFKE A	Vishay-Dale		
R33	1	10.0k	RES, 10.0 k, 1%, 0.1 W, 0603	0603	RC0603FR-0710KL	Yageo		
R34	1	49.9	RES, 49.9, 1%, 0.1 W, AEC-Q200 Grade 0, 0603	0603	CRCW060349R9FKE A	Vishay-Dale		
R35	1	24.9k	RES, 24.9 k, 1%, 0.1 W, 0603	0603	RC0603FR-0724K9L	Yageo		
R36, R48, R59, R60, R61	5	10.0k	RES, 10.0 k, 1%, 0.1 W, AEC-Q200 Grade 0, 0603	0603	CRCW060310K0FKE A	Vishay-Dale		
R37	1	39.0k	RES, 39.0 k, 1%, 0.1 W, 0603	0603	RC0603FR-0739KL	Yageo		
R38	1	4.22k	RES, 4.22 k, 1%, 0.1 W, AEC-Q200 Grade 0, 0603	0603	CRCW06034K22FKE A	Vishay-Dale		
R40	1	237k	RES, 237 k, 1%, 0.1 W, 0603	0603	RC0603FR-07237KL	Yageo		
R41	1	3.3k	RES, 3.3 k, 5%, 0.125 W, AEC-Q200 Grade 0, 0805	0805	CRCW08053K30JNE A	Vishay-Dale		
R42	1	60.4k	RES, 60.4 k, 1%, 0.1 W, AEC-Q200 Grade 0, 0603	0603	CRCW060360K4FKE A	Vishay-Dale		
R43	1	51	RES, 51, 5%, 0.25 W, AEC-Q200 Grade 0, 1206	1206	CRCW120651R0JNE A	Vishay-Dale		
R47	1	499k	RES, 499 k, 1%, 0.1 W, AEC-Q200 Grade 0, 0603	0603	CRCW0603499KFKE A	Vishay-Dale		

Table 8-1. TPS23731EVM-095 Bill of Materials (continued)

Designator	QTY	Value	Description	Package Reference	Part Number	Manufacturer	Alternate Part Number	Alternate Manufacturer
R69	1	10	RES, 10, 5%, 0.75 W, AEC-Q200 Grade 0, 2010	2010	CRCW201010R0JNE F	Vishay-Dale		
SH-J1, SH-J2, SH-J3, SH-J4, SH-J5, SH-J6	6		Shunt, 2.54mm, Gold, Black	Shunt, 2.54mm, Black	60900213421	Wurth Elektronik		
T1	1	350uH	Transformer, PoE+, SMT	Transformer, SOIC-24 Wide	749022016	Wurth Elektronik		
T2	1		Flyback transformer for PoE applications	SMD10	LDT1038-50R	LinkCom	750320321	Wurth Elektronik
TP1, TP6, TP12, TP18, TP43, TP45	6		Test Point, Miniature, Red, TH	Red Miniature Testpoint	5000	Keystone		
TP2, TP7, TP8, TP14, TP30, TP37, TP38, TP44	8		Test Point, Miniature, Black, TH	Black Miniature Testpoint	5001	Keystone		
TP3, TP5, TP9, TP10, TP15, TP16, TP17, TP19, TP20, TP22, TP23, TP24, TP25, TP26, TP27, TP32	16		Test Point, Miniature, White, TH	White Miniature Testpoint	5002	Keystone		
TP4, TP11, TP13, TP21, TP28, TP29, TP33, TP34, TP39, TP40, TP42	11		Test Point, Miniature, Orange, TH	Orange Miniature Testpoint	5003	Keystone		
U1	1		IEEE 802.3bt Type 3 Class 1-4 PoE PD with No-Opto Flyback DC-DC Controller	VQFN45	TPS23731RMT	Texas Instruments		
U2, U3	2		Optocoupler, 5 kV, 300-600% CTR, SMT	DIP-4L Gullwing	FOD817DS	Fairchild Semiconductor		
C10	0	680 pF	CAP, CERM, 680 pF, 50 V, +/- 10%, X7R, 0603	0603	GRM188R71H681KA01D	MuRata		
C11	0	2200 pF	CAP, CERM, 2200 pF, 2000 V, +/- 10%, X7R, 1812	1812	C4532X7R3D222K130KA	TDK		
C17	0	220uF	CAP, Tantalum Polymer, 220 uF, 10 V, +/- 20%, 0.025 ohm, 7343-30 SMD	7343-30	10TPE220ML	Panasonic		
C24, C25, C27, C29, C31	0	330 pF	CAP, CERM, 330 pF, 50 V, +/- 5%, C0G/NP0, 0603	0603	GRM1885C1H331JA01D	MuRata		
C34	0	56 pF	CAP, CERM, 56 pF, 50 V, +/- 1%, C0G/NP0, 0603	0603	06035A560FAT2A	AVX		
C45	0	0.1uF	CAP, CERM, 0.1 uF, 100 V, +/- 10%, X7R, 0805	0805	C2012X7R2A104K125AA	TDK		

Table 8-1. TPS23731EVM-095 Bill of Materials (continued)

Designator	QTY	Value	Description	Package Reference	Part Number	Manufacturer	Alternate Part Number	Alternate Manufacturer
D5, D6	0	100 V	Diode, Switching, 100 V, 0.2 A, SOD-123	SOD-123	MMSD4148T1G	ON Semiconductor		
D20	0	24 V	Diode, Zener, 24 V, 3 W, SMA	SMA	3SMAJ5934B-TP	Micro Commercial Components		
D25	0	100 V	Diode, Schottky, 100 V, 3 A, SMC	SMC	B3100-13-F	Diodes Inc.		
J17	0		Header, 100mil, 2x1, Tin, TH	Header, 2x1, 100mil, TH	5-146278-2	TE Connectivity		
L2, L7	0	250uH	Coupled inductor, 250 uH, A, 0.035 ohm, SMD	8.7x10mm	744272251	Wurth Elektronik		
L4	0	150nH	Inductor, Shielded Drum Core, Ferrite, 150 nH, 30 A, 0.000235 ohm, SMD	7x5x7mm	744302015	Wurth Elektronik		
Q1	0	40 V	Transistor, PNP, 40 V, 0.2 A, SOT-23	SOT-23	MMBT3906-7-F	Diodes Inc.		
Q3	0	40 V	MOSFET, N-CH, 40 V, 15 A, DQJ0008A (VSONP-8)	DQJ0008A	CSD18504Q5A	Texas Instruments		
Q4, Q5, Q6, Q7	0	100 V	MOSFET, N-CH, 100 V, 4.5 A, DQK0006C (WSON-6)	DQK0006C	CSD19538Q2	Texas Instruments		
R11	0	4.7	RES, 4.7, 5%, 0.1 W, AEC-Q200 Grade 0, 0603	0603	CRCW06034R70JNEA	Vishay-Dale		
R12	0	4.99k	RES, 4.99 k, 1%, 0.1 W, AEC-Q200 Grade 0, 0603	0603	CRCW06034K99FKEA	Vishay-Dale		
R15, R17, R20, R21	0	1.00Meg	RES, 1.00 M, 1%, 0.1 W, AEC-Q200 Grade 0, 0603	0603	CRCW06031M00FKEA	Vishay-Dale		
R22, R25, R26, R29	0	232k	RES, 232 k, 1%, 0.1 W, AEC-Q200 Grade 0, 0603	0603	CRCW0603232KFKEA	Vishay-Dale		
R64, R65	0	10.0k	RES, 10.0 k, 1%, 0.1 W, AEC-Q200 Grade 0, 0603	0603	CRCW060310K0FKEA	Vishay-Dale		
R68	0	750k	RES, 750 k, 5%, 0.1 W, AEC-Q200 Grade 0, 0603	0603	CRCW0603750KJNEA	Vishay-Dale		

9 Revision History

NOTE: Page numbers for previous revisions may differ from page numbers in the current version.

Changes from Revision * (November 2020) to Revision A (August 2023)	Page
• Added alternate part for T2 in <i>Bill of Materials</i>	13

STANDARD TERMS FOR EVALUATION MODULES

1. *Delivery:* TI delivers TI evaluation boards, kits, or modules, including any accompanying demonstration software, components, and/or documentation which may be provided together or separately (collectively, an "EVM" or "EVMs") to the User ("User") in accordance with the terms set forth herein. User's acceptance of the EVM is expressly subject to the following terms.
 - 1.1 EVMs are intended solely for product or software developers for use in a research and development setting to facilitate feasibility evaluation, experimentation, or scientific analysis of TI semiconductor products. EVMs have no direct function and are not finished products. EVMs shall not be directly or indirectly assembled as a part or subassembly in any finished product. For clarification, any software or software tools provided with the EVM ("Software") shall not be subject to the terms and conditions set forth herein but rather shall be subject to the applicable terms that accompany such Software
 - 1.2 EVMs are not intended for consumer or household use. EVMs may not be sold, sublicensed, leased, rented, loaned, assigned, or otherwise distributed for commercial purposes by Users, in whole or in part, or used in any finished product or production system.
2. *Limited Warranty and Related Remedies/Disclaimers:*
 - 2.1 These terms do not apply to Software. The warranty, if any, for Software is covered in the applicable Software License Agreement.
 - 2.2 TI warrants that the TI EVM will conform to TI's published specifications for ninety (90) days after the date TI delivers such EVM to User. Notwithstanding the foregoing, TI shall not be liable for a nonconforming EVM if (a) the nonconformity was caused by neglect, misuse or mistreatment by an entity other than TI, including improper installation or testing, or for any EVMs that have been altered or modified in any way by an entity other than TI, (b) the nonconformity resulted from User's design, specifications or instructions for such EVMs or improper system design, or (c) User has not paid on time. Testing and other quality control techniques are used to the extent TI deems necessary. TI does not test all parameters of each EVM. User's claims against TI under this Section 2 are void if User fails to notify TI of any apparent defects in the EVMs within ten (10) business days after delivery, or of any hidden defects with ten (10) business days after the defect has been detected.
 - 2.3 TI's sole liability shall be at its option to repair or replace EVMs that fail to conform to the warranty set forth above, or credit User's account for such EVM. TI's liability under this warranty shall be limited to EVMs that are returned during the warranty period to the address designated by TI and that are determined by TI not to conform to such warranty. If TI elects to repair or replace such EVM, TI shall have a reasonable time to repair such EVM or provide replacements. Repaired EVMs shall be warranted for the remainder of the original warranty period. Replaced EVMs shall be warranted for a new full ninety (90) day warranty period.

WARNING

Evaluation Kits are intended solely for use by technically qualified, professional electronics experts who are familiar with the dangers and application risks associated with handling electrical mechanical components, systems, and subsystems.

User shall operate the Evaluation Kit within TI's recommended guidelines and any applicable legal or environmental requirements as well as reasonable and customary safeguards. Failure to set up and/or operate the Evaluation Kit within TI's recommended guidelines may result in personal injury or death or property damage. Proper set up entails following TI's instructions for electrical ratings of interface circuits such as input, output and electrical loads.

NOTE:

EXPOSURE TO ELECTROSTATIC DISCHARGE (ESD) MAY CAUSE DEGRADATION OR FAILURE OF THE EVALUATION KIT; TI RECOMMENDS STORAGE OF THE EVALUATION KIT IN A PROTECTIVE ESD BAG.

3 Regulatory Notices:

3.1 United States

3.1.1 Notice applicable to EVMs not FCC-Approved:

FCC NOTICE: This kit is designed to allow product developers to evaluate electronic components, circuitry, or software associated with the kit to determine whether to incorporate such items in a finished product and software developers to write software applications for use with the end product. This kit is not a finished product and when assembled may not be resold or otherwise marketed unless all required FCC equipment authorizations are first obtained. Operation is subject to the condition that this product not cause harmful interference to licensed radio stations and that this product accept harmful interference. Unless the assembled kit is designed to operate under part 15, part 18 or part 95 of this chapter, the operator of the kit must operate under the authority of an FCC license holder or must secure an experimental authorization under part 5 of this chapter.

3.1.2 For EVMs annotated as FCC – FEDERAL COMMUNICATIONS COMMISSION Part 15 Compliant:

CAUTION

This device complies with part 15 of the FCC Rules. Operation is subject to the following two conditions: (1) This device may not cause harmful interference, and (2) this device must accept any interference received, including interference that may cause undesired operation.

Changes or modifications not expressly approved by the party responsible for compliance could void the user's authority to operate the equipment.

FCC Interference Statement for Class A EVM devices

NOTE: This equipment has been tested and found to comply with the limits for a Class A digital device, pursuant to part 15 of the FCC Rules. These limits are designed to provide reasonable protection against harmful interference when the equipment is operated in a commercial environment. This equipment generates, uses, and can radiate radio frequency energy and, if not installed and used in accordance with the instruction manual, may cause harmful interference to radio communications. Operation of this equipment in a residential area is likely to cause harmful interference in which case the user will be required to correct the interference at his own expense.

FCC Interference Statement for Class B EVM devices

NOTE: This equipment has been tested and found to comply with the limits for a Class B digital device, pursuant to part 15 of the FCC Rules. These limits are designed to provide reasonable protection against harmful interference in a residential installation. This equipment generates, uses and can radiate radio frequency energy and, if not installed and used in accordance with the instructions, may cause harmful interference to radio communications. However, there is no guarantee that interference will not occur in a particular installation. If this equipment does cause harmful interference to radio or television reception, which can be determined by turning the equipment off and on, the user is encouraged to try to correct the interference by one or more of the following measures:

- Reorient or relocate the receiving antenna.
- Increase the separation between the equipment and receiver.
- Connect the equipment into an outlet on a circuit different from that to which the receiver is connected.
- Consult the dealer or an experienced radio/TV technician for help.

3.2 Canada

3.2.1 For EVMs issued with an Industry Canada Certificate of Conformance to RSS-210 or RSS-247

Concerning EVMs Including Radio Transmitters:

This device complies with Industry Canada license-exempt RSSs. Operation is subject to the following two conditions:

(1) this device may not cause interference, and (2) this device must accept any interference, including interference that may cause undesired operation of the device.

Concernant les EVMs avec appareils radio:

Le présent appareil est conforme aux CNR d'Industrie Canada applicables aux appareils radio exempts de licence. L'exploitation est autorisée aux deux conditions suivantes: (1) l'appareil ne doit pas produire de brouillage, et (2) l'utilisateur de l'appareil doit accepter tout brouillage radioélectrique subi, même si le brouillage est susceptible d'en compromettre le fonctionnement.

Concerning EVMs Including Detachable Antennas:

Under Industry Canada regulations, this radio transmitter may only operate using an antenna of a type and maximum (or lesser) gain approved for the transmitter by Industry Canada. To reduce potential radio interference to other users, the antenna type and its gain should be so chosen that the equivalent isotropically radiated power (e.i.r.p.) is not more than that necessary for successful communication. This radio transmitter has been approved by Industry Canada to operate with the antenna types listed in the user guide with the maximum permissible gain and required antenna impedance for each antenna type indicated. Antenna types not included in this list, having a gain greater than the maximum gain indicated for that type, are strictly prohibited for use with this device.

Concernant les EVMs avec antennes détachables

Conformément à la réglementation d'Industrie Canada, le présent émetteur radio peut fonctionner avec une antenne d'un type et d'un gain maximal (ou inférieur) approuvé pour l'émetteur par Industrie Canada. Dans le but de réduire les risques de brouillage radioélectrique à l'intention des autres utilisateurs, il faut choisir le type d'antenne et son gain de sorte que la puissance isotrope rayonnée équivalente (p.i.r.e.) ne dépasse pas l'intensité nécessaire à l'établissement d'une communication satisfaisante. Le présent émetteur radio a été approuvé par Industrie Canada pour fonctionner avec les types d'antenne énumérés dans le manuel d'usage et ayant un gain admissible maximal et l'impédance requise pour chaque type d'antenne. Les types d'antenne non inclus dans cette liste, ou dont le gain est supérieur au gain maximal indiqué, sont strictement interdits pour l'exploitation de l'émetteur.

3.3 Japan

3.3.1 *Notice for EVMs delivered in Japan:* Please see http://www.tij.co.jp/llds/ti_ja/general/eStore/notice_01.page 日本国内に輸入される評価用キット、ボードについては、次のところをご覧ください。

<https://www.ti.com/ja-jp/legal/notice-for-evaluation-kits-delivered-in-japan.html>

3.3.2 *Notice for Users of EVMs Considered "Radio Frequency Products" in Japan:* EVMs entering Japan may not be certified by TI as conforming to Technical Regulations of Radio Law of Japan.

If User uses EVMs in Japan, not certified to Technical Regulations of Radio Law of Japan, User is required to follow the instructions set forth by Radio Law of Japan, which includes, but is not limited to, the instructions below with respect to EVMs (which for the avoidance of doubt are stated strictly for convenience and should be verified by User):

1. Use EVMs in a shielded room or any other test facility as defined in the notification #173 issued by Ministry of Internal Affairs and Communications on March 28, 2006, based on Sub-section 1.1 of Article 6 of the Ministry's Rule for Enforcement of Radio Law of Japan,
2. Use EVMs only after User obtains the license of Test Radio Station as provided in Radio Law of Japan with respect to EVMs, or
3. Use of EVMs only after User obtains the Technical Regulations Conformity Certification as provided in Radio Law of Japan with respect to EVMs. Also, do not transfer EVMs, unless User gives the same notice above to the transferee. Please note that if User does not follow the instructions above, User will be subject to penalties of Radio Law of Japan.

【無線電波を送信する製品の開発キットをお使いになる際の注意事項】 開発キットの中には技術基準適合証明を受けていないものがあります。技術適合証明を受けていないものご使用に際しては、電波法遵守のため、以下のいずれかの措置を取っていただく必要がありますのでご注意ください。

1. 電波法施行規則第6条第1項第1号に基づく平成18年3月28日総務省告示第173号で定められた電波暗室等の試験設備でご使用いただく。
2. 実験局の免許を取得後ご使用いただく。
3. 技術基準適合証明を取得後ご使用いただく。

なお、本製品は、上記の「ご使用にあたっての注意」を譲渡先、移転先に通知しない限り、譲渡、移転できないものとします。

上記を遵守頂けない場合は、電波法の罰則が適用される可能性があることをご留意ください。日本テキサス・イ

ンスツルメンツ株式会社

東京都新宿区西新宿 6 丁目 2 4 番 1 号

西新宿三井ビル

3.3.3 *Notice for EVMs for Power Line Communication:* Please see http://www.tij.co.jp/llds/ti_ja/general/eStore/notice_02.page

電力線搬送波通信についての開発キットをお使いになる際の注意事項については、次のところをご覧ください。 <https://www.ti.com/ja-jp/legal/notice-for-evaluation-kits-for-power-line-communication.html>

3.4 European Union

3.4.1 *For EVMs subject to EU Directive 2014/30/EU (Electromagnetic Compatibility Directive):*

This is a class A product intended for use in environments other than domestic environments that are connected to a low-voltage power-supply network that supplies buildings used for domestic purposes. In a domestic environment this product may cause radio interference in which case the user may be required to take adequate measures.

-
4. *EVM Use Restrictions and Warnings:*
 - 4.1 EVMS ARE NOT FOR USE IN FUNCTIONAL SAFETY AND/OR SAFETY CRITICAL EVALUATIONS, INCLUDING BUT NOT LIMITED TO EVALUATIONS OF LIFE SUPPORT APPLICATIONS.
 - 4.2 User must read and apply the user guide and other available documentation provided by TI regarding the EVM prior to handling or using the EVM, including without limitation any warning or restriction notices. The notices contain important safety information related to, for example, temperatures and voltages.
 - 4.3 *Safety-Related Warnings and Restrictions:*
 - 4.3.1 User shall operate the EVM within TI's recommended specifications and environmental considerations stated in the user guide, other available documentation provided by TI, and any other applicable requirements and employ reasonable and customary safeguards. Exceeding the specified performance ratings and specifications (including but not limited to input and output voltage, current, power, and environmental ranges) for the EVM may cause personal injury or death, or property damage. If there are questions concerning performance ratings and specifications, User should contact a TI field representative prior to connecting interface electronics including input power and intended loads. Any loads applied outside of the specified output range may also result in unintended and/or inaccurate operation and/or possible permanent damage to the EVM and/or interface electronics. Please consult the EVM user guide prior to connecting any load to the EVM output. If there is uncertainty as to the load specification, please contact a TI field representative. During normal operation, even with the inputs and outputs kept within the specified allowable ranges, some circuit components may have elevated case temperatures. These components include but are not limited to linear regulators, switching transistors, pass transistors, current sense resistors, and heat sinks, which can be identified using the information in the associated documentation. When working with the EVM, please be aware that the EVM may become very warm.
 - 4.3.2 EVMs are intended solely for use by technically qualified, professional electronics experts who are familiar with the dangers and application risks associated with handling electrical mechanical components, systems, and subsystems. User assumes all responsibility and liability for proper and safe handling and use of the EVM by User or its employees, affiliates, contractors or designees. User assumes all responsibility and liability to ensure that any interfaces (electronic and/or mechanical) between the EVM and any human body are designed with suitable isolation and means to safely limit accessible leakage currents to minimize the risk of electrical shock hazard. User assumes all responsibility and liability for any improper or unsafe handling or use of the EVM by User or its employees, affiliates, contractors or designees.
 - 4.4 User assumes all responsibility and liability to determine whether the EVM is subject to any applicable international, federal, state, or local laws and regulations related to User's handling and use of the EVM and, if applicable, User assumes all responsibility and liability for compliance in all respects with such laws and regulations. User assumes all responsibility and liability for proper disposal and recycling of the EVM consistent with all applicable international, federal, state, and local requirements.
 5. *Accuracy of Information:* To the extent TI provides information on the availability and function of EVMs, TI attempts to be as accurate as possible. However, TI does not warrant the accuracy of EVM descriptions, EVM availability or other information on its websites as accurate, complete, reliable, current, or error-free.
 6. *Disclaimers:*
 - 6.1 EXCEPT AS SET FORTH ABOVE, EVMS AND ANY MATERIALS PROVIDED WITH THE EVM (INCLUDING, BUT NOT LIMITED TO, REFERENCE DESIGNS AND THE DESIGN OF THE EVM ITSELF) ARE PROVIDED "AS IS" AND "WITH ALL FAULTS." TI DISCLAIMS ALL OTHER WARRANTIES, EXPRESS OR IMPLIED, REGARDING SUCH ITEMS, INCLUDING BUT NOT LIMITED TO ANY EPIDEMIC FAILURE WARRANTY OR IMPLIED WARRANTIES OF MERCHANTABILITY OR FITNESS FOR A PARTICULAR PURPOSE OR NON-INFRINGEMENT OF ANY THIRD PARTY PATENTS, COPYRIGHTS, TRADE SECRETS OR OTHER INTELLECTUAL PROPERTY RIGHTS.
 - 6.2 EXCEPT FOR THE LIMITED RIGHT TO USE THE EVM SET FORTH HEREIN, NOTHING IN THESE TERMS SHALL BE CONSTRUED AS GRANTING OR CONFERRING ANY RIGHTS BY LICENSE, PATENT, OR ANY OTHER INDUSTRIAL OR INTELLECTUAL PROPERTY RIGHT OF TI, ITS SUPPLIERS/LICENSORS OR ANY OTHER THIRD PARTY, TO USE THE EVM IN ANY FINISHED END-USER OR READY-TO-USE FINAL PRODUCT, OR FOR ANY INVENTION, DISCOVERY OR IMPROVEMENT, REGARDLESS OF WHEN MADE, CONCEIVED OR ACQUIRED.
 7. *USER'S INDEMNITY OBLIGATIONS AND REPRESENTATIONS.* USER WILL DEFEND, INDEMNIFY AND HOLD TI, ITS LICENSORS AND THEIR REPRESENTATIVES HARMLESS FROM AND AGAINST ANY AND ALL CLAIMS, DAMAGES, LOSSES, EXPENSES, COSTS AND LIABILITIES (COLLECTIVELY, "CLAIMS") ARISING OUT OF OR IN CONNECTION WITH ANY HANDLING OR USE OF THE EVM THAT IS NOT IN ACCORDANCE WITH THESE TERMS. THIS OBLIGATION SHALL APPLY WHETHER CLAIMS ARISE UNDER STATUTE, REGULATION, OR THE LAW OF TORT, CONTRACT OR ANY OTHER LEGAL THEORY, AND EVEN IF THE EVM FAILS TO PERFORM AS DESCRIBED OR EXPECTED.
-

8. *Limitations on Damages and Liability:*

8.1 *General Limitations.* IN NO EVENT SHALL TI BE LIABLE FOR ANY SPECIAL, COLLATERAL, INDIRECT, PUNITIVE, INCIDENTAL, CONSEQUENTIAL, OR EXEMPLARY DAMAGES IN CONNECTION WITH OR ARISING OUT OF THESE TERMS OR THE USE OF THE EVMS , REGARDLESS OF WHETHER TI HAS BEEN ADVISED OF THE POSSIBILITY OF SUCH DAMAGES. EXCLUDED DAMAGES INCLUDE, BUT ARE NOT LIMITED TO, COST OF REMOVAL OR REINSTALLATION, ANCILLARY COSTS TO THE PROCUREMENT OF SUBSTITUTE GOODS OR SERVICES, RETESTING, OUTSIDE COMPUTER TIME, LABOR COSTS, LOSS OF GOODWILL, LOSS OF PROFITS, LOSS OF SAVINGS, LOSS OF USE, LOSS OF DATA, OR BUSINESS INTERRUPTION. NO CLAIM, SUIT OR ACTION SHALL BE BROUGHT AGAINST TI MORE THAN TWELVE (12) MONTHS AFTER THE EVENT THAT GAVE RISE TO THE CAUSE OF ACTION HAS OCCURRED.

8.2 *Specific Limitations.* IN NO EVENT SHALL TI'S AGGREGATE LIABILITY FROM ANY USE OF AN EVM PROVIDED HEREUNDER, INCLUDING FROM ANY WARRANTY, INDEMNITY OR OTHER OBLIGATION ARISING OUT OF OR IN CONNECTION WITH THESE TERMS, , EXCEED THE TOTAL AMOUNT PAID TO TI BY USER FOR THE PARTICULAR EVM(S) AT ISSUE DURING THE PRIOR TWELVE (12) MONTHS WITH RESPECT TO WHICH LOSSES OR DAMAGES ARE CLAIMED. THE EXISTENCE OF MORE THAN ONE CLAIM SHALL NOT ENLARGE OR EXTEND THIS LIMIT.

9. *Return Policy.* Except as otherwise provided, TI does not offer any refunds, returns, or exchanges. Furthermore, no return of EVM(s) will be accepted if the package has been opened and no return of the EVM(s) will be accepted if they are damaged or otherwise not in a resalable condition. If User feels it has been incorrectly charged for the EVM(s) it ordered or that delivery violates the applicable order, User should contact TI. All refunds will be made in full within thirty (30) working days from the return of the components(s), excluding any postage or packaging costs.

10. *Governing Law:* These terms and conditions shall be governed by and interpreted in accordance with the laws of the State of Texas, without reference to conflict-of-laws principles. User agrees that non-exclusive jurisdiction for any dispute arising out of or relating to these terms and conditions lies within courts located in the State of Texas and consents to venue in Dallas County, Texas. Notwithstanding the foregoing, any judgment may be enforced in any United States or foreign court, and TI may seek injunctive relief in any United States or foreign court.

Mailing Address: Texas Instruments, Post Office Box 655303, Dallas, Texas 75265
Copyright © 2023, Texas Instruments Incorporated

IMPORTANT NOTICE AND DISCLAIMER

TI PROVIDES TECHNICAL AND RELIABILITY DATA (INCLUDING DATA SHEETS), DESIGN RESOURCES (INCLUDING REFERENCE DESIGNS), APPLICATION OR OTHER DESIGN ADVICE, WEB TOOLS, SAFETY INFORMATION, AND OTHER RESOURCES "AS IS" AND WITH ALL FAULTS, AND DISCLAIMS ALL WARRANTIES, EXPRESS AND IMPLIED, INCLUDING WITHOUT LIMITATION ANY IMPLIED WARRANTIES OF MERCHANTABILITY, FITNESS FOR A PARTICULAR PURPOSE OR NON-INFRINGEMENT OF THIRD PARTY INTELLECTUAL PROPERTY RIGHTS.

These resources are intended for skilled developers designing with TI products. You are solely responsible for (1) selecting the appropriate TI products for your application, (2) designing, validating and testing your application, and (3) ensuring your application meets applicable standards, and any other safety, security, regulatory or other requirements.

These resources are subject to change without notice. TI grants you permission to use these resources only for development of an application that uses the TI products described in the resource. Other reproduction and display of these resources is prohibited. No license is granted to any other TI intellectual property right or to any third party intellectual property right. TI disclaims responsibility for, and you will fully indemnify TI and its representatives against, any claims, damages, costs, losses, and liabilities arising out of your use of these resources.

TI's products are provided subject to [TI's Terms of Sale](#) or other applicable terms available either on [ti.com](https://www.ti.com) or provided in conjunction with such TI products. TI's provision of these resources does not expand or otherwise alter TI's applicable warranties or warranty disclaimers for TI products.

TI objects to and rejects any additional or different terms you may have proposed.

Mailing Address: Texas Instruments, Post Office Box 655303, Dallas, Texas 75265
Copyright © 2023, Texas Instruments Incorporated