

LMT84 1.5V、SC70/TO-92/TO-92S、 アナログ温度センサ

1 特長

- LMT84LPG (TO-92Sパッケージ)は高速な熱時定数、標準値10s (エアフロー1.2m/s)
- 非常に正確: $\pm 0.4^{\circ}\text{C}$ (標準値)
- 低電圧1.5Vでの動作
- 平均センサ・ゲイン: $-5.5\text{mV}/^{\circ}\text{C}$
- 低い静止電流: $5.4\mu\text{A}$
- 広い温度範囲: $-50^{\circ}\text{C}\sim 150^{\circ}\text{C}$
- 出力の短絡保護
- 駆動能力 $\pm 50\mu\text{A}$ のプッシュプル出力
- 業界標準のLM20/19およびLM35温度センサとフットプリント互換
- コスト効率に優れたサーミスタの代替

2 アプリケーション

- インフォテインメントおよびクラスタ
- パワートレイン・システム
- 煙および熱感知器
- ドローン
- 家電製品

3 概要

LMT84は高精度のCMOS温度センサで、標準精度は $\pm 0.4^{\circ}\text{C}$ (最大値 $\pm 2.7^{\circ}\text{C}$)で、リニアなアナログ出力電圧を持ち、この電圧は温度に反比例します。1.5Vの電源電圧で動作し、静止電流が $5.4\mu\text{A}$ 、パワーオン時間が 0.7ms で、効果的なパワーサイクリング・アーキテクチャを実現し、ドローンやセンサ・ノードなどバッテリー駆動のアプリケーションで消費電力を最小化できます。LMT84LPGスルーホールTO-92Sパッケージは熱時定数が高速で、煙および熱感知器など、オフボードで時間-温度の感度が高いアプリケーションに対応できます。広い動作範囲にわたる精度や、その他の特長から、LMT84はサーミスタの優れた代替となります。

異なる平均センサ・ゲインおよび類似の精度を持つデバイスについては、「[類似の代替デバイス](#)」で、LMT8xファミリの他のデバイスを参照してください。

製品情報⁽¹⁾

型番	パッケージ	本体サイズ(公称)
LMT84	SOT (5)	2.00mm×1.25mm
	TO-92 (3)	4.30mm×3.50mm
	TO-92S (3)	4.00mm×3.15mm

(1) 利用可能なすべてのパッケージについては、このデータシートの末尾にある注文情報を参照してください。

熱時定数

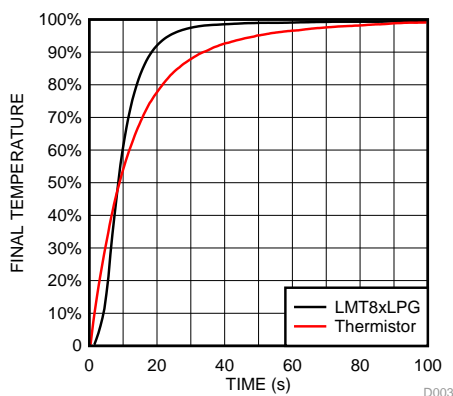

* 高速な熱応答NTC

出力電圧と温度との関係

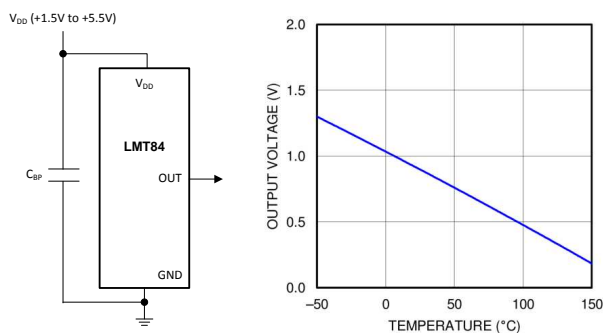

Copyright © 2016, Texas Instruments Incorporated



目次

1	特長	1	8.3	Feature Description	9
2	アプリケーション	1	8.4	Device Functional Modes	11
3	概要	1	9	Application and Implementation	13
4	改訂履歴	2	9.1	Applications Information	13
5	Device Comparison Tables	3	9.2	Typical Applications	13
6	Pin Configuration and Functions	4	10	Power Supply Recommendations	14
7	Specifications	5	11	Layout	15
7.1	Absolute Maximum Ratings	5	11.1	Layout Guidelines	15
7.2	ESD Ratings	5	11.2	Layout Examples	15
7.3	Recommended Operating Conditions	5	12	デバイスおよびドキュメントのサポート	16
7.4	Thermal Information	5	12.1	ドキュメントの更新通知を受け取る方法	16
7.5	Accuracy Characteristics	6	12.2	コミュニティ・リソース	16
7.6	Electrical Characteristics	6	12.3	商標	16
7.7	Typical Characteristics	7	12.4	静電気放電に関する注意事項	16
8	Detailed Description	9	12.5	Glossary	16
8.1	Overview	9	13	メカニカル、パッケージ、および注文情報	16
8.2	Functional Block Diagram	9			

4 改訂履歴

資料番号末尾の英字は改訂を表しています。その改訂履歴は英語版に準じています。

Revision D (June 2017) から Revision E に変更

Page

•	車載用デバイスを単独のデータシート(SNIS178)に移動	1
•	Changed TO-92 GND pin number from: 1 to: 3	4
•	Changed TO-92 V _{DD} pin number from: 3 to: 1	4

Revision C (October 2015) から Revision D に変更

Page

•	データシートのテキストを最新のドキュメントおよび翻訳標準に更新	1
•	「特長」の箇条書きにAEC-Q100車載用認定の項目を追加	1
•	時定数のグラフを追加	1
•	「アプリケーション」からディスク・ドライバ、ゲーム、ワイヤレス・トランシーバ、携帯電話を削除	1
•	Added LPG (TO-92S) package	4
•	Added Figure 10 to <i>Typical Characteristics</i>	7

Revision B (May 2014) から Revision C に変更

Page

•	TO-126パッケージへのすべての言及 削除	1
•	Added TO-92 LPM pin configuration graphic	4
•	Changed Handling Ratings to ESD Ratings and moved Storage Temperature to Absolute Maximum Ratings table	5
•	Changed KV to V	5
•	Added layout recommendation for TO-92 LP and LPM packages	15

Revision A (June 2013) から Revision B に変更

Page

•	新しいTIの標準に準拠するようデータシートのフローとレイアウトを変更。「アプリケーションと実装」、「電源に関する推奨事項」、「レイアウト」、「デバイスおよびドキュメントのサポート」、「メカニカル、パッケージ、および注文情報」の各セクションを追加変更	1
•	ドキュメント全体を通してTO-92およびTO-126パッケージの情報を追加	1

- Changed from 450°C/W to 275 °C/W. New specification is derived using TI 's latest methodology. 5
- Deleted Note: The input current is leakage only and is highest at high temperature. It is typically only 0.001 µA. The 1 µA limit is solely based on a testing limitation and does not reflect the actual performance of the part. 6

5 Device Comparison Tables

Table 1. Available Device Packages

ORDER NUMBER ⁽¹⁾	PACKAGE	PIN	BODY SIZE (NOM)	MOUNTING TYPE
LMT84DCK	SOT (AKA ⁽²⁾ : SC70, DCK)	5	2.00 mm × 1.25 mm	Surface Mount
LMT84LP	TO-92 (AKA ⁽²⁾ : LP)	3	4.30 mm × 3.50 mm	Through-hole; straight leads
LMT84LPG	TO-92S (AKA ⁽²⁾ : LPG)	3	4.00 mm × 3.15 mm	Through-hole; straight leads
LMT84LPM	TO-92 (AKA ⁽²⁾ : LPM)	3	4.30 mm × 3.50 mm	Through-hole; formed leads
LMT84DCK-Q1	SOT (AKA ⁽²⁾ : SC70, DCK)	5	2.00 mm × 1.25 mm	Surface Mount

(1) For all available packages and complete order numbers, see the Package Option addendum at the end of the data sheet.

(2) AKA = Also Known As

Table 2. Comparable Alternative Devices

DEVICE NAME	AVERAGE OUTPUT SENSOR GAIN	POWER SUPPLY RANGE
LMT84	–5.5 mV/°C	1.5 V to 5.5 V
LMT85	–8.2 mV/°C	1.8 V to 5.5 V
LMT86	–10.9 mV/°C	2.2 V to 5.5 V
LMT87	–13.6 mV/°C	2.7 V to 5.5 V

6 Pin Configuration and Functions

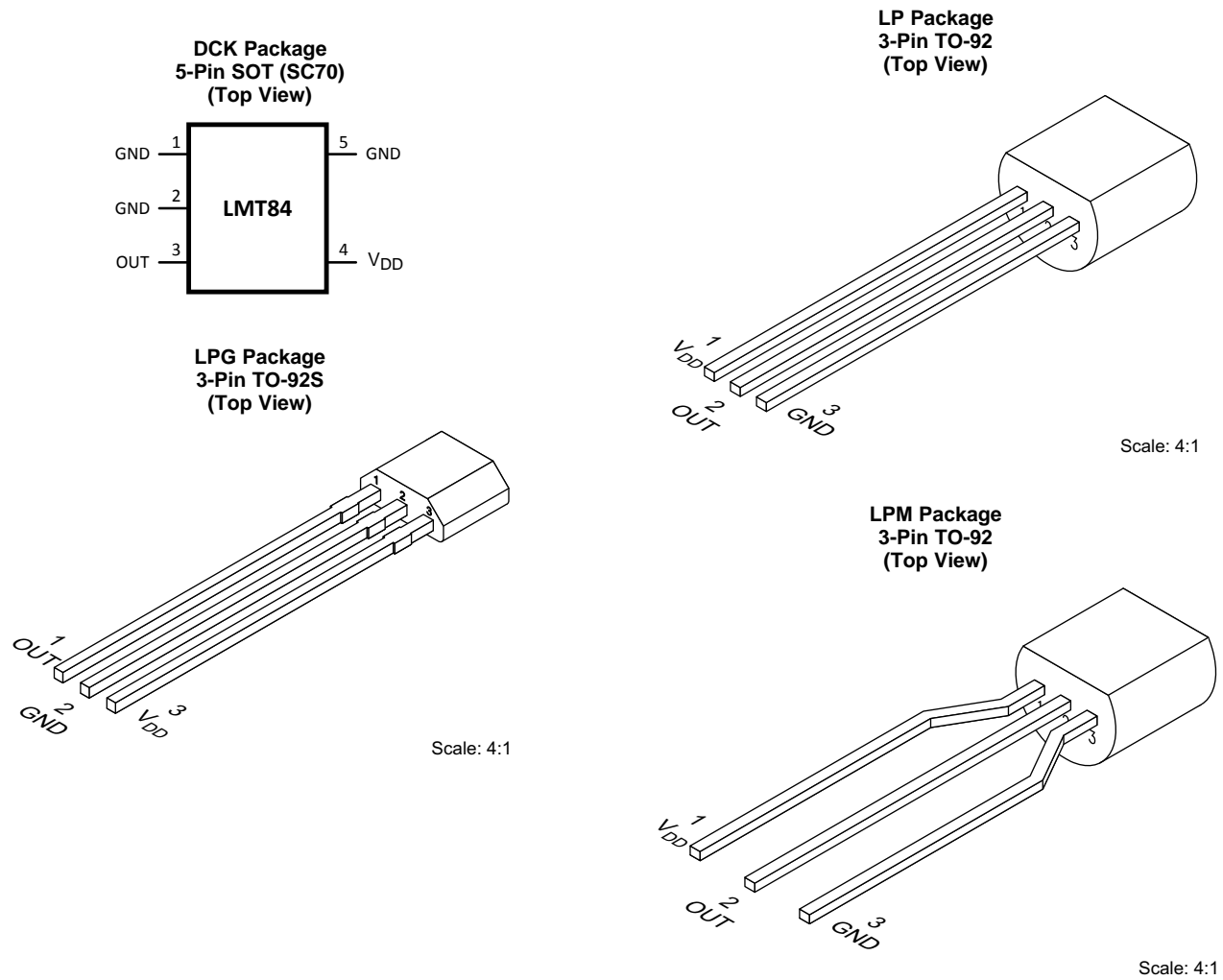

Pin Functions

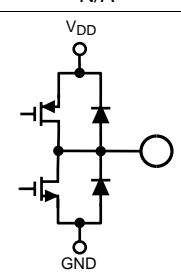
NAME	PIN			TYPE	DESCRIPTION	
	SOT (SC70)	TO-92	TO-92S		EQUIVALENT CIRCUIT	FUNCTION
GND	1, 2 ⁽¹⁾ , 5	3	2	Ground	N/A	Power Supply Ground
OUT	3	2	1	Analog Output		Outputs a voltage that is inversely proportional to temperature
V _{DD}	4	1	3	Power	N/A	Positive Supply Voltage

(1) Direct connection to the back side of the die

7 Specifications

7.1 Absolute Maximum Ratings

See ⁽¹⁾⁽²⁾

	MIN	MAX	UNIT
Supply voltage	−0.3	6	V
Voltage at output pin	−0.3	(V _{DD} + 0.5)	V
Output current	−7	7	mA
Input current at any pin ⁽³⁾	−5	5	mA
Maximum junction temperature (T _{JMAX})		150	°C
Storage temperature T _{stg}	−65	150	°C

- (1) Stresses beyond those listed under *Absolute Maximum Ratings* may cause permanent damage to the device. These are stress ratings only, which do not imply functional operation of the device at these or any other conditions beyond those indicated under *Recommended Operating Conditions*. Exposure to absolute-maximum-rated conditions for extended periods may affect device reliability.
- (2) *Soldering process must comply with Reflow Temperature Profile specifications. Refer to www.ti.com/packaging.*
- (3) When the input voltage (V_I) at any pin exceeds power supplies (V_I < GND or V_I > V), the current at that pin should be limited to 5 mA.

7.2 ESD Ratings

			VALUE	UNIT
LMT84LP in TO-92/TO-92S package				
V _(ESD)	Electrostatic discharge	Human-body model (HBM), per ANSI/ESDA/JEDEC JS-001 ⁽¹⁾⁽²⁾	±2500	V
		Charged-device model (CDM), per JEDEC specification JESD22-C101 ⁽³⁾	±1000	
LMT84DCK in SC70 package				
V _(ESD)	Electrostatic discharge	Human-body model (HBM), per JESD22-A114 ⁽²⁾	±2500	V
		Charged-device model (CDM), per JEDEC specification JESD22-C101 ⁽³⁾	±1000	

- (1) JEDEC document JEP155 states that 500-V HBM allows safe manufacturing with a standard ESD control process.
- (2) The human body model is a 100-pF capacitor discharged through a 1.5-kΩ resistor into each pin.
- (3) JEDEC document JEP157 states that 250-V CDM allows safe manufacturing with a standard ESD control process.

7.3 Recommended Operating Conditions

	MIN	MAX	UNIT
Specified temperature	T _{MIN} ≤ T _A ≤ T _{MAX}		°C
	−50 ≤ T _A ≤ 150		°C
Supply voltage (V _{DD})	1.5	5.5	V

7.4 Thermal Information⁽¹⁾

THERMAL METRIC ⁽²⁾	LMT84/ LMT84-Q1	LMT84LP	LMT84LPG	UNIT
	DCK (SOT/SC70)	LP/LPM (TO-92)	LPG (TO-92S)	
	5 PINS	3 PINS	3 PINS	
R _{θJA} Junction-to-ambient thermal resistance ⁽³⁾⁽⁴⁾	275	167	130.4	°C/W
R _{θJC(top)} Junction-to-case (top) thermal resistance	84	90	64.2	°C/W
R _{θJB} Junction-to-board thermal resistance	56	146	106.2	°C/W
ψ _{JT} Junction-to-top characterization parameter	1.2	35	14.6	°C/W
ψ _{JB} Junction-to-board characterization parameter	55	146	106.2	°C/W

- (1) For information on self-heating and thermal response time see section [Mounting and Thermal Conductivity](#).
- (2) For more information about traditional and new thermal metrics, see the [IC Package Thermal Metrics](#) application report.
- (3) The junction to ambient thermal resistance (R_{θJA}) under natural convection is obtained in a simulation on a JEDEC-standard, High-K board as specified in JESD51-7, in an environment described in JESD51-2. Exposed pad packages assume that thermal vias are included in the PCB, per JESD 51-5.
- (4) Changes in output due to self heating can be computed by multiplying the internal dissipation by the thermal resistance.

7.5 Accuracy Characteristics

These limits do not include DC load regulation. These stated accuracy limits are with reference to the values in [Table 3](#).

PARAMETER	TEST CONDITIONS	MIN ⁽¹⁾	TYP ⁽²⁾	MAX ⁽¹⁾	UNIT
Temperature accuracy ⁽³⁾	70°C to 150°C; V _{DD} = 1.5 V to 5.5 V	-2.7	±0.6	2.7	°C
	0°C to 70°C; V _{DD} = 1.5 V to 5.5 V	-2.7	±0.9	2.7	°C
	-50°C to +0°C; V _{DD} = 1.6 V to 5.5 V	-2.7	±0.9	2.7	°C
	-50°C to +150°C; V _{DD} = 2.3 V to 5.5 V		±0.4		°C

- (1) Limits are specified to TI's AOQL (Average Outgoing Quality Level).
- (2) Typical values are at T_J = T_A = 25°C and represent most likely parametric norm.
- (3) Accuracy is defined as the error between the measured and reference output voltages, tabulated in [Table 3](#) at the specified conditions of supply gain setting, voltage, and temperature (expressed in °C). Accuracy limits include line regulation within the specified conditions. Accuracy limits do not include load regulation; they assume no DC load.

7.6 Electrical Characteristics

Unless otherwise noted, these specifications apply for V_{DD} = +1.5 V to +5.5 V. minimum and maximum limits apply for T_A = T_J = T_{MIN} to T_{MAX}; typical values apply for T_A = T_J = 25°C.

PARAMETER	TEST CONDITIONS	MIN ⁽¹⁾	TYP ⁽²⁾	MAX ⁽¹⁾	UNIT
Sensor gain			-5.5		mV/°C
Load regulation ⁽³⁾	Source ≤ 50 μA, (V _{DD} - V _{OUT}) ≥ 200 mV	-1	-0.22		mV
	Sink ≤ 50 μA, V _{OUT} ≥ 200 mV		0.26	1	mV
Line regulation ⁽⁴⁾			200		μV/V
I _S Supply current	T _A = 30°C to 150°C, (V _{DD} - V _{OUT}) ≥ 100 mV		5.4	8.1	μA
	T _A = -50°C to 150°C, (V _{DD} - V _{OUT}) ≥ 100 mV		5.4	9	μA
C _L Output load capacitance			1100		pF
Power-on time ⁽⁵⁾	C _L = 0 pF to 1100 pF		0.7	1.9	ms
Output drive			±50		μA

- (1) Limits are specific to TI's AOQL (Average Outgoing Quality Level).
- (2) Typical values are at T_J = T_A = 25°C and represent most likely parametric norm.
- (3) Source currents are flowing out of the LMT84-xx. Sink currents are flowing into the LMT84-xx.
- (4) Line regulation (DC) is calculated by subtracting the output voltage at the highest supply voltage from the output voltage at the lowest supply voltage. The typical DC line regulation specification does not include the output voltage shift discussed in [Output Voltage Shift](#).
- (5) Specified by design and characterization.

7.7 Typical Characteristics

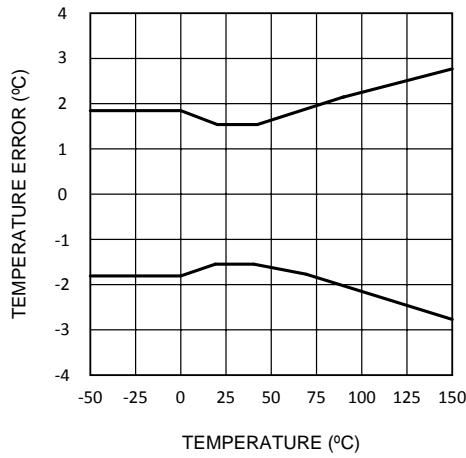

Figure 1. Temperature Error vs Temperature

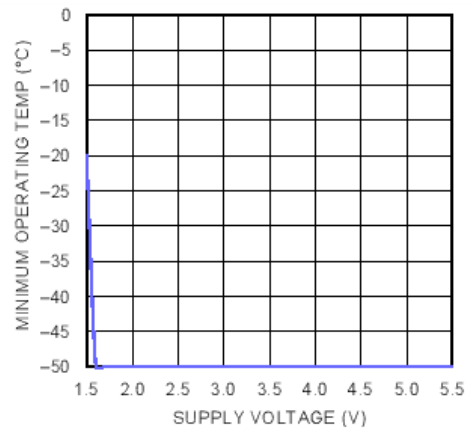

Figure 2. Minimum Operating Temperature vs Supply Voltage

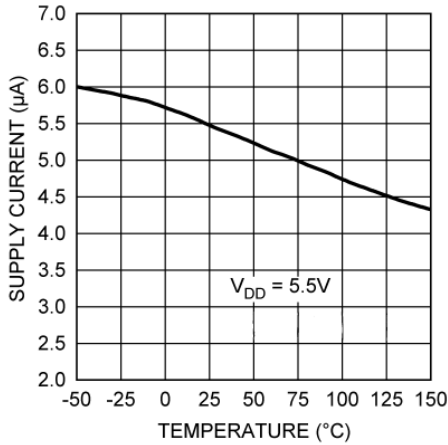

Figure 3. Supply Current vs Temperature

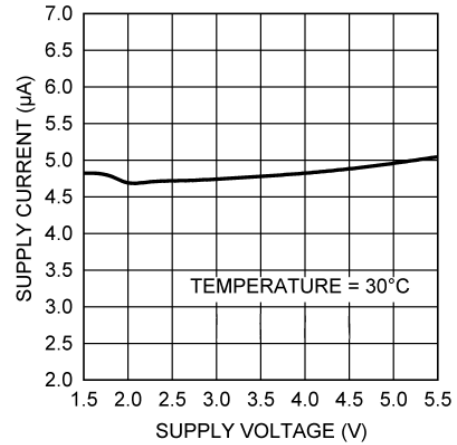

Figure 4. Supply Current vs Supply Voltage

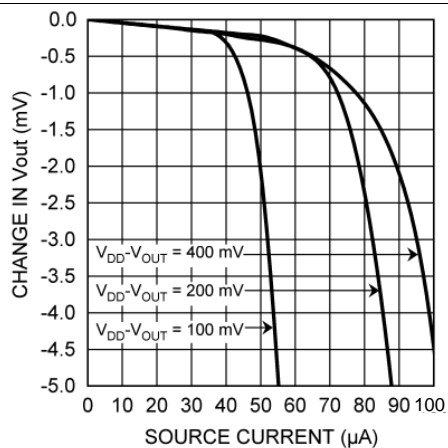

Figure 5. Load Regulation, Sourcing Current

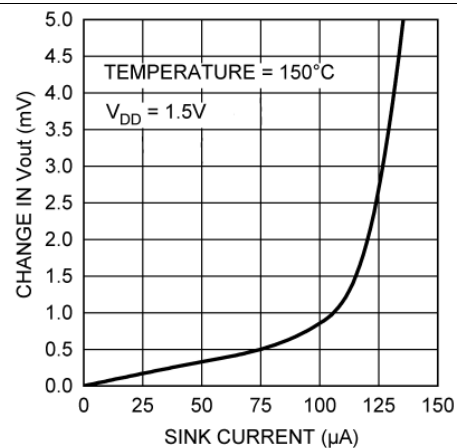

Figure 6. Load Regulation, Sinking Current

Typical Characteristics (continued)

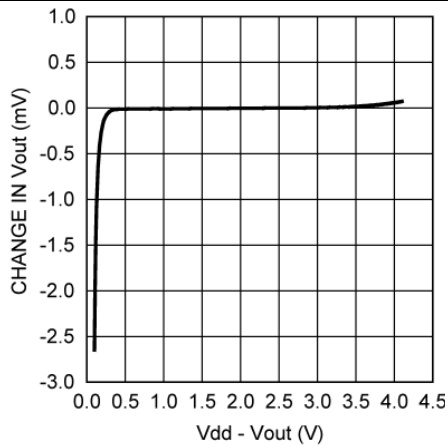

Figure 7. Change in Vout vs Overhead Voltage

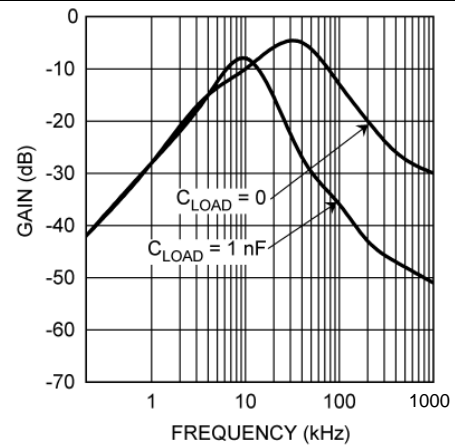

Figure 8. Supply-Noise Gain vs Frequency

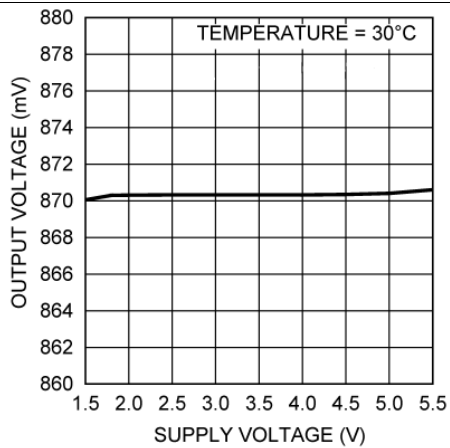

Figure 9. Output Voltage vs Supply Voltage

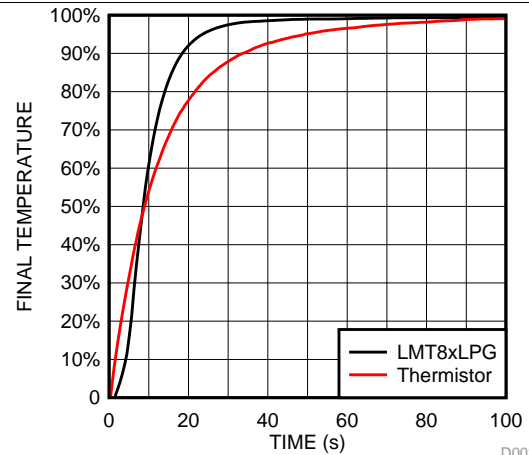

Figure 10. LMT84LPG Thermal Response vs Common Leaded Thermistor With 1.2-m/s Airflow

8 Detailed Description

8.1 Overview

The LMT84 is an analog output temperature sensor. The temperature-sensing element is comprised of a simple base emitter junction that is forward biased by a current source. The temperature-sensing element is then buffered by an amplifier and provided to the OUT pin. The amplifier has a simple push-pull output stage thus providing a low impedance output source.

8.2 Functional Block Diagram

Full-Range Celsius Temperature Sensor (–50°C to +150°C)

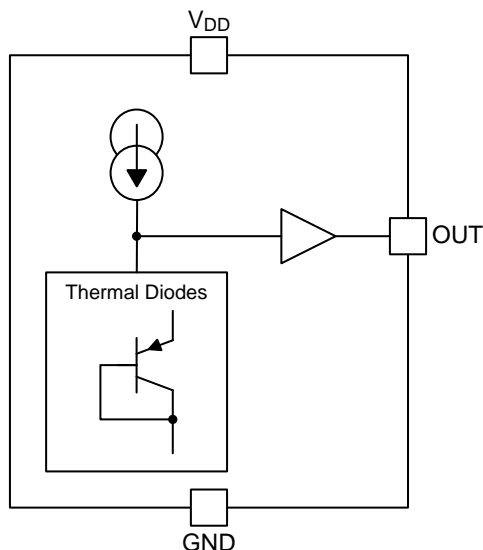

8.3 Feature Description

8.3.1 LMT84 Transfer Function

The output voltage of the LMT84, across the complete operating temperature range, is shown in [Table 3](#). This table is the reference from which the LMT84 accuracy specifications (listed in the [Accuracy Characteristics](#) section) are determined. This table can be used, for example, in a host processor look-up table. A file containing this data is available for download at the [LMT84](#) product folder under *Tools and Software Models*.

Table 3. LMT84 Transfer Table

TEMP (°C)	V _{OUT} (mV)	TEMP (°C)	V _{OUT} (mV)	TEMP (°C)	V _{OUT} (mV)	TEMP (°C)	V _{OUT} (mV)	TEMP (°C)	V _{OUT} (mV)
–50	1299	–10	1088	30	871	70	647	110	419
–49	1294	–9	1082	31	865	71	642	111	413
–48	1289	–8	1077	32	860	72	636	112	407
–47	1284	–7	1072	33	854	73	630	113	401
–46	1278	–6	1066	34	849	74	625	114	396
–45	1273	–5	1061	35	843	75	619	115	390
–44	1268	–4	1055	36	838	76	613	116	384
–43	1263	–3	1050	37	832	77	608	117	378
–42	1257	–2	1044	38	827	78	602	118	372
–41	1252	–1	1039	39	821	79	596	119	367
–40	1247	0	1034	40	816	80	591	120	361
–39	1242	1	1028	41	810	81	585	121	355
–38	1236	2	1023	42	804	82	579	122	349

Feature Description (continued)

Table 3. LMT84 Transfer Table (continued)

TEMP (°C)	V _{OUT} (mV)	TEMP (°C)	V _{OUT} (mV)	TEMP (°C)	V _{OUT} (mV)	TEMP (°C)	V _{OUT} (mV)	TEMP (°C)	V _{OUT} (mV)
-37	1231	3	1017	43	799	83	574	123	343
-36	1226	4	1012	44	793	84	568	124	337
-35	1221	5	1007	45	788	85	562	125	332
-34	1215	6	1001	46	782	86	557	126	326
-33	1210	7	996	47	777	87	551	127	320
-32	1205	8	990	48	771	88	545	128	314
-31	1200	9	985	49	766	89	539	129	308
-30	1194	10	980	50	760	90	534	130	302
-29	1189	11	974	51	754	91	528	131	296
-28	1184	12	969	52	749	92	522	132	291
-27	1178	13	963	53	743	93	517	133	285
-26	1173	14	958	54	738	94	511	134	279
-25	1168	15	952	55	732	95	505	135	273
-24	1162	16	947	56	726	96	499	136	267
-23	1157	17	941	57	721	97	494	137	261
-22	1152	18	936	58	715	98	488	138	255
-21	1146	19	931	59	710	99	482	139	249
-20	1141	20	925	60	704	100	476	140	243
-19	1136	21	920	61	698	101	471	141	237
-18	1130	22	914	62	693	102	465	142	231
-17	1125	23	909	63	687	103	459	143	225
-16	1120	24	903	64	681	104	453	144	219
-15	1114	25	898	65	676	105	448	145	213
-14	1109	26	892	66	670	106	442	146	207
-13	1104	27	887	67	664	107	436	147	201
-12	1098	28	882	68	659	108	430	148	195
-11	1093	29	876	69	653	109	425	149	189
								150	183

Although the LMT84 is very linear, the response does have a slight umbrella parabolic shape. This shape is very accurately reflected in Table 3. The transfer table can be calculated by using the parabolic equation (Equation 1).

$$V_{TEMP} \text{ (mV)} = 870.6\text{mV} - \left[5.506 \frac{\text{mV}}{^{\circ}\text{C}} (T - 30^{\circ}\text{C}) \right] - \left[0.00176 \frac{\text{mV}}{^{\circ}\text{C}^2} (T - 30^{\circ}\text{C})^2 \right] \tag{1}$$

The parabolic equation is an approximation of the transfer table and the accuracy of the equation degrades slightly at the temperature range extremes. Equation 1 can be solved for T, resulting in:

$$T = \frac{5.506 - \sqrt{(-5.506)^2 + 4 \times 0.00176 \times (870.6 - V_{TEMP} \text{ (mV)})}}{2 \times (-0.00176)} + 30 \tag{2}$$

For an even less accurate linear approximation, a line can easily be calculated over the desired temperature range from the table using the two-point equation (Equation 3):

$$V - V_1 = \left(\frac{V_2 - V_1}{T_2 - T_1} \right) \times (T - T_1)$$

where

- V is in mV,
- T is in °C,
- T₁ and V₁ are the coordinates of the lowest temperature,
- and T₂ and V₂ are the coordinates of the highest temperature.

(3)

For example, if the user wanted to resolve this equation, over a temperature range of 20°C to 50°C, they would proceed as follows:

$$V - 925 \text{ mV} = \left(\frac{760 \text{ mV} - 925 \text{ mV}}{50^\circ\text{C} - 20^\circ\text{C}} \right) \times (T - 20^\circ\text{C}) \quad (4)$$

$$V - 925 \text{ mV} = (-5.50 \text{ mV} / ^\circ\text{C}) \times (T - 20^\circ\text{C}) \quad (5)$$

$$V = (-5.50 \text{ mV} / ^\circ\text{C}) \times T + 1035 \text{ mV} \quad (6)$$

Using this method of linear approximation, the transfer function can be approximated for one or more temperature ranges of interest.

8.4 Device Functional Modes

8.4.1 Mounting and Thermal Conductivity

The LMT84 can be applied easily in the same way as other integrated-circuit temperature sensors. It can be glued or cemented to a surface.

To ensure good thermal conductivity, the backside of the LMT84 die is directly attached to the GND pin. The temperatures of the lands and traces to the other leads of the LMT84 will also affect the temperature reading.

Alternatively, the LMT84 can be mounted inside a sealed-end metal tube, and can then be dipped into a bath or screwed into a threaded hole in a tank. As with any IC, the LMT84 and accompanying wiring and circuits must be kept insulated and dry, to avoid leakage and corrosion. This is especially true if the circuit may operate at cold temperatures where condensation can occur. If moisture creates a short circuit from the output to ground or V_{DD} , the output from the LMT84 will not be correct. Printed-circuit coatings are often used to ensure that moisture cannot corrode the leads or circuit traces.

The thermal resistance junction to ambient ($R_{\theta JA}$ or θ_{JA}) is the parameter used to calculate the rise of a device junction temperature due to its power dissipation. Use [Equation 7](#) to calculate the rise in the LMT84 die temperature:

$$T_J = T_A + \theta_{JA} [(V_{DD} I_S) + (V_{DD} - V_O) I_L]$$

where

- T_A is the ambient temperature,
- I_S is the supply current,
- I_L is the load current on the output,
- and V_O is the output voltage. (7)

For example, in an application where $T_A = 30^\circ\text{C}$, $V_{DD} = 5 \text{ V}$, $I_S = 5.4 \mu\text{A}$, $V_{OUT} = 871 \text{ mV}$, and $I_L = 2 \mu\text{A}$, the junction temperature would be 30.015°C , showing a self-heating error of only 0.015°C . Because the junction temperature of the LMT84 device is the actual temperature being measured, take care to minimize the load current that the LMT84 is required to drive. [Thermal Information](#) shows the thermal resistance of the LMT84.

8.4.2 Output Noise Considerations

A push-pull output gives the LMT84 the ability to sink and source significant current. This is beneficial when, for example, driving dynamic loads like an input stage on an analog-to-digital converter (ADC). In these applications the source current is required to quickly charge the input capacitor of the ADC. The LMT84 is ideal for this and other applications which require strong source or sink current.

The LMT84 supply-noise gain (the ratio of the AC signal on V_{OUT} to the AC signal on V_{DD}) was measured during bench tests. The typical attenuation is shown in [Figure 8](#) found in the [Typical Characteristics](#) section. A load capacitor on the output can help to filter noise.

For operation in very noisy environments, some bypass capacitance should be present on the supply within approximately 5 centimeters of the LMT84.

Device Functional Modes (continued)

8.4.3 Capacitive Loads

The LMT84 handles capacitive loading well. In an extremely noisy environment, or when driving a switched sampling input on an ADC, it may be necessary to add some filtering to minimize noise coupling. Without any precautions, the LMT84 can drive a capacitive load less than or equal to 1100 pF as shown in [Figure 11](#). For capacitive loads greater than 1100 pF, a series resistor may be required on the output, as shown in [Figure 12](#).

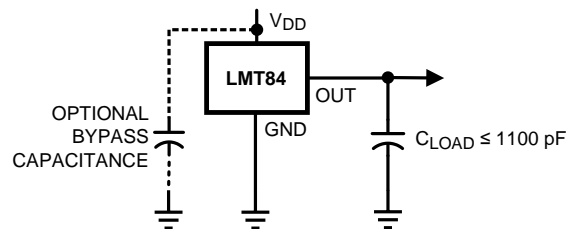

Figure 11. LMT84 No Decoupling Required for Capacitive Loads Less Than 1100 pF

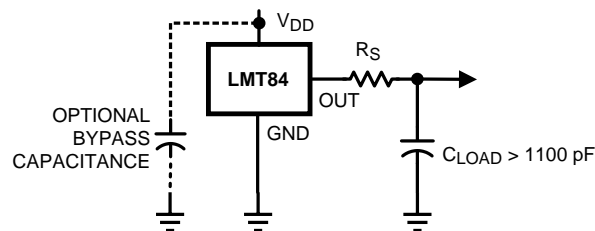

Figure 12. LMT84 With Series Resistor for Capacitive Loading Greater Than 1100 pF

Table 4. Recommended Series Resistor Values

C_{LOAD}	MINIMUM R_S
1.1 nF to 99 nF	3 k Ω
100 nF to 999 nF	1.5 k Ω
1 μ F	800 Ω

8.4.4 Output Voltage Shift

The LMT84 is very linear over temperature and supply voltage range. Due to the intrinsic behavior of an NMOS or PMOS rail-to-rail buffer, a slight shift in the output can occur when the supply voltage is ramped over the operating range of the device. The location of the shift is determined by the relative levels of V_{DD} and V_{OUT} . The shift typically occurs when $V_{DD} - V_{OUT} = 1$ V.

This slight shift (a few millivolts) takes place over a wide change (approximately 200 mV) in V_{DD} or V_{OUT} . Because the shift takes place over a wide temperature change of 5°C to 20°C, V_{OUT} is always monotonic. The accuracy specifications in the [Accuracy Characteristics](#) table already include this possible shift.

9 Application and Implementation

NOTE

Information in the following applications sections is not part of the TI component specification, and TI does not warrant its accuracy or completeness. TI's customers are responsible for determining suitability of components for their purposes. Customers should validate and test their design implementation to confirm system functionality.

9.1 Applications Information

The LMT84 features make it suitable for many general temperature-sensing applications. It can operate down to 1.5-V supply with 5.4- μ A power consumption, making it ideal for battery-powered devices. Package options like the through-hole TO-92 package allow the LMT84 to be mounted onboard, off-board, to a heat sink, or on multiple unique locations in the same application.

9.2 Typical Applications

9.2.1 Connection to an ADC

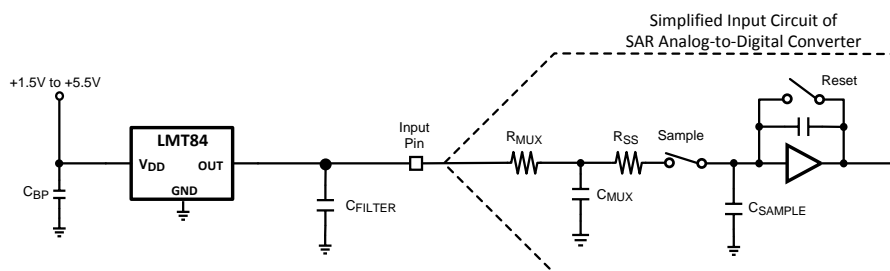

Figure 13. Suggested Connection to a Sampling Analog-to-Digital Converter Input Stage

9.2.1.1 Design Requirements

Most CMOS ADCs found in microcontrollers and ASICs have a sampled data comparator input structure. When the ADC charges the sampling cap, it requires instantaneous charge from the output of the analog source such as the LMT84 temperature sensor and many op amps. This requirement is easily accommodated by the addition of a capacitor (C_{FILTER}).

9.2.1.2 Detailed Design Procedure

The size of C_{FILTER} depends on the size of the sampling capacitor and the sampling frequency. Because not all ADCs have identical input stages, the charge requirements will vary. This general ADC application is shown as an example only.

9.2.1.3 Application Curve

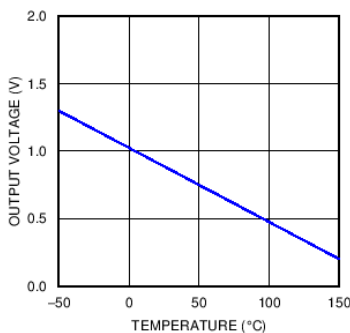

Figure 14. Analog Output Transfer Function

Typical Applications (continued)

9.2.2 Conserving Power Dissipation With Shutdown

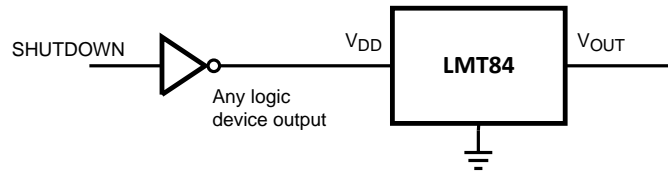

Figure 15. Simple Shutdown Connection of the LMT84

9.2.2.1 Design Requirements

Because the power consumption of the LMT84 is less than 9 μA , it can simply be powered directly from any logic gate output and therefore not require a specific shutdown pin. The device can even be powered directly from a microcontroller GPIO. In this way, it can easily be turned off for cases such as battery-powered systems where power savings are critical.

9.2.2.2 Detailed Design Procedure

Simply connect the V_{DD} pin of the LMT84 directly to the logic shutdown signal from a microcontroller.

9.2.2.3 Application Curves

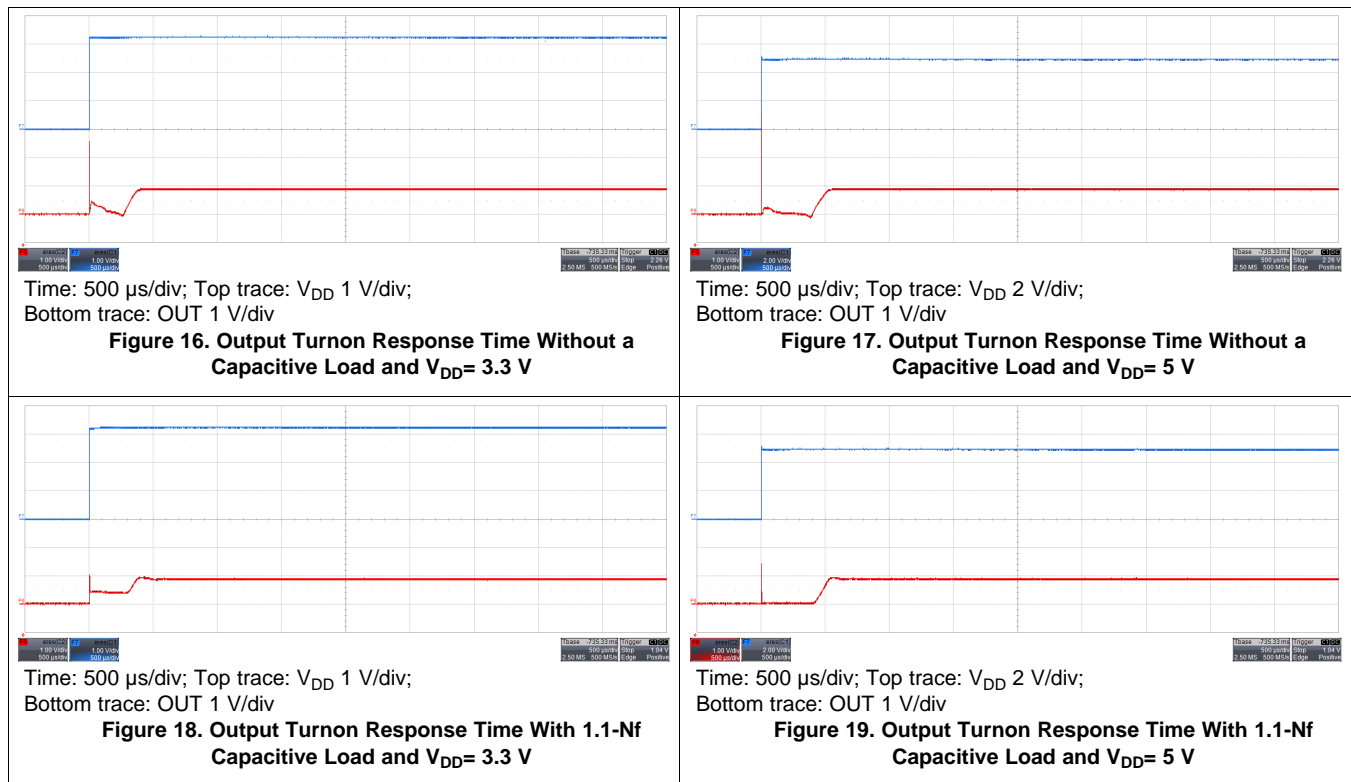

10 Power Supply Recommendations



The low supply current and supply range (1.5 V to 5.5 V) of the LMT84 allow the device to easily be powered from many sources. Power supply bypassing is optional and is mainly dependent on the noise on the power supply used. In noisy systems, it may be necessary to add bypass capacitors to lower the noise that is coupled to the output of the LMT84.

11 Layout

11.1 Layout Guidelines

The LMT84 is extremely simple to layout. If a power-supply bypass capacitor is used, it should be connected as shown in the [Layout Examples](#).

11.2 Layout Examples

-  VIA to ground plane
-  VIA to power plane

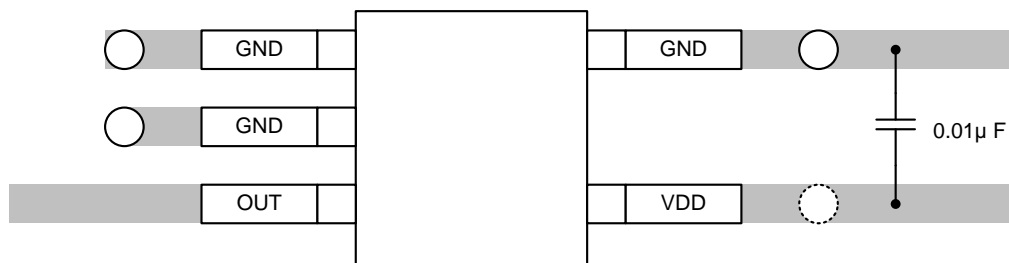

Figure 20. SC70 Package Recommended Layout

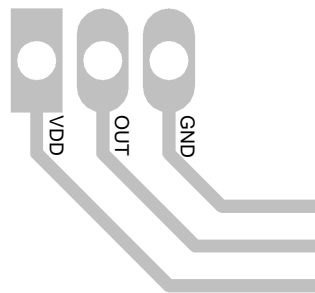

Figure 21. TO-92 LP Package Recommended Layout

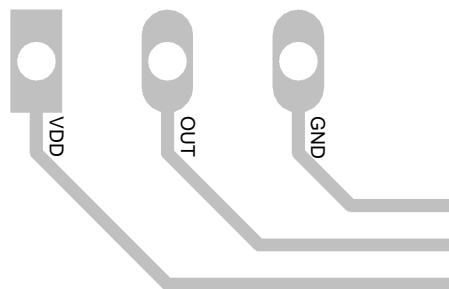

Figure 22. TO-92 LPM Package Recommended Layout

12 デバイスおよびドキュメントのサポート

12.1 ドキュメントの更新通知を受け取る方法

ドキュメントの更新についての通知を受け取るには、ti.comのデバイス製品フォルダを開いてください。右上の隅にある「通知を受け取る」をクリックして登録すると、変更されたすべての製品情報に関するダイジェストを毎週受け取れます。変更の詳細については、修正されたドキュメントに含まれている改訂履歴をご覧ください。

12.2 コミュニティ・リソース

The following links connect to TI community resources. Linked contents are provided "AS IS" by the respective contributors. They do not constitute TI specifications and do not necessarily reflect TI's views; see TI's [Terms of Use](#).

TI E2E™オンライン・コミュニティ *TIのE2E (Engineer-to-Engineer) コミュニティ*。エンジニア間の共同作業を促進するために開設されたものです。e2e.ti.comでは、他のエンジニアに質問し、知識を共有し、アイデアを検討して、問題解決に役立てることができます。

設計サポート *TIの設計サポート* 役に立つE2Eフォーラムや、設計サポート・ツールをすばやく見つけることができます。技術サポート用の連絡先情報も参照できます。

12.3 商標

E2E is a trademark of Texas Instruments.
All other trademarks are the property of their respective owners.

12.4 静電気放電に関する注意事項



これらのデバイスは、限定的なESD(静電破壊)保護機能を内蔵しています。保存時または取り扱い時は、MOSゲートに対する静電破壊を防止するために、リード線同士をショートさせておくか、デバイスを導電フォームに入れる必要があります。

12.5 Glossary

[SLYZ022](#) — *TI Glossary*.

This glossary lists and explains terms, acronyms, and definitions.

13 メカニカル、パッケージ、および注文情報

以降のページには、メカニカル、パッケージ、および注文に関する情報が記載されています。この情報は、そのデバイスについて利用可能な最新のデータです。このデータは予告なく変更されることがあり、ドキュメントが改訂される場合もあります。本データシートのブラウザ版を使用されている場合は、画面左側の説明をご覧ください。

PACKAGING INFORMATION

Orderable Device	Status (1)	Package Type	Package Drawing	Pins	Package Qty	Eco Plan (2)	Lead finish/ Ball material (6)	MSL Peak Temp (3)	Op Temp (°C)	Device Marking (4/5)	Samples
LMT84DCKR	ACTIVE	SC70	DCK	5	3000	RoHS & Green	SN	Level-1-260C-UNLIM	-50 to 150	BNA	Samples
LMT84DCKT	OBSOLETE	SC70	DCK	5		TBD	Call TI	Call TI	-50 to 150	BNA	
LMT84LP	ACTIVE	TO-92	LP	3	1800	RoHS & Green	SN	N / A for Pkg Type	-50 to 150	LMT84	Samples
LMT84LPG	ACTIVE	TO-92	LPG	3	1000	RoHS & Green	SN	N / A for Pkg Type	-50 to 150	LMT84	Samples
LMT84LPGM	ACTIVE	TO-92	LPG	3	3000	RoHS & Green	SN	N / A for Pkg Type	-50 to 150	LMT84	Samples
LMT84LPM	ACTIVE	TO-92	LP	3	2000	RoHS & Green	SN	N / A for Pkg Type	-50 to 150	LMT84	Samples

(1) The marketing status values are defined as follows:

ACTIVE: Product device recommended for new designs.

LIFEBUY: TI has announced that the device will be discontinued, and a lifetime-buy period is in effect.

NRND: Not recommended for new designs. Device is in production to support existing customers, but TI does not recommend using this part in a new design.

PREVIEW: Device has been announced but is not in production. Samples may or may not be available.

OBSOLETE: TI has discontinued the production of the device.

(2) **RoHS:** TI defines "RoHS" to mean semiconductor products that are compliant with the current EU RoHS requirements for all 10 RoHS substances, including the requirement that RoHS substance do not exceed 0.1% by weight in homogeneous materials. Where designed to be soldered at high temperatures, "RoHS" products are suitable for use in specified lead-free processes. TI may reference these types of products as "Pb-Free".

RoHS Exempt: TI defines "RoHS Exempt" to mean products that contain lead but are compliant with EU RoHS pursuant to a specific EU RoHS exemption.

Green: TI defines "Green" to mean the content of Chlorine (Cl) and Bromine (Br) based flame retardants meet JS709B low halogen requirements of <=1000ppm threshold. Antimony trioxide based flame retardants must also meet the <=1000ppm threshold requirement.

(3) MSL, Peak Temp. - The Moisture Sensitivity Level rating according to the JEDEC industry standard classifications, and peak solder temperature.

(4) There may be additional marking, which relates to the logo, the lot trace code information, or the environmental category on the device.

(5) Multiple Device Markings will be inside parentheses. Only one Device Marking contained in parentheses and separated by a "~" will appear on a device. If a line is indented then it is a continuation of the previous line and the two combined represent the entire Device Marking for that device.

(6) Lead finish/Ball material - Orderable Devices may have multiple material finish options. Finish options are separated by a vertical ruled line. Lead finish/Ball material values may wrap to two lines if the finish value exceeds the maximum column width.

Important Information and Disclaimer: The information provided on this page represents TI's knowledge and belief as of the date that it is provided. TI bases its knowledge and belief on information provided by third parties, and makes no representation or warranty as to the accuracy of such information. Efforts are underway to better integrate information from third parties. TI has taken and continues to take reasonable steps to provide representative and accurate information but may not have conducted destructive testing or chemical analysis on incoming materials and chemicals. TI and TI suppliers consider certain information to be proprietary, and thus CAS numbers and other limited information may not be available for release.

In no event shall TI's liability arising out of such information exceed the total purchase price of the TI part(s) at issue in this document sold by TI to Customer on an annual basis.

OTHER QUALIFIED VERSIONS OF LMT84 :

- Automotive : [LMT84-Q1](#)

NOTE: Qualified Version Definitions:

- Automotive - Q100 devices qualified for high-reliability automotive applications targeting zero defects

TAPE AND REEL INFORMATION

QUADRANT ASSIGNMENTS FOR PIN 1 ORIENTATION IN TAPE

*All dimensions are nominal

Device	Package Type	Package Drawing	Pins	SPQ	Reel Diameter (mm)	Reel Width W1 (mm)	A0 (mm)	B0 (mm)	K0 (mm)	P1 (mm)	W (mm)	Pin1 Quadrant
LMT84DCKR	SC70	DCK	5	3000	178.0	8.4	2.25	2.45	1.2	4.0	8.0	Q3

TAPE AND REEL BOX DIMENSIONS

*All dimensions are nominal

Device	Package Type	Package Drawing	Pins	SPQ	Length (mm)	Width (mm)	Height (mm)
LMT84DCKR	SC70	DCK	5	3000	208.0	191.0	35.0

LPG0003A



PACKAGE OUTLINE

TO-92 - 5.05 mm max height

TRANSISTOR OUTLINE



4221343/C 01/2018

NOTES:

1. All linear dimensions are in millimeters. Any dimensions in parenthesis are for reference only. Dimensioning and tolerancing per ASME Y14.5M.
2. This drawing is subject to change without notice.

EXAMPLE BOARD LAYOUT

LPG0003A

TO-92 - 5.05 mm max height

TRANSISTOR OUTLINE



LAND PATTERN EXAMPLE
NON-SOLDER MASK DEFINED
SCALE:20X

4221343/C 01/2018

TAPE SPECIFICATIONS

LPG0003A

TO-92 - 5.05 mm max height

TRANSISTOR OUTLINE

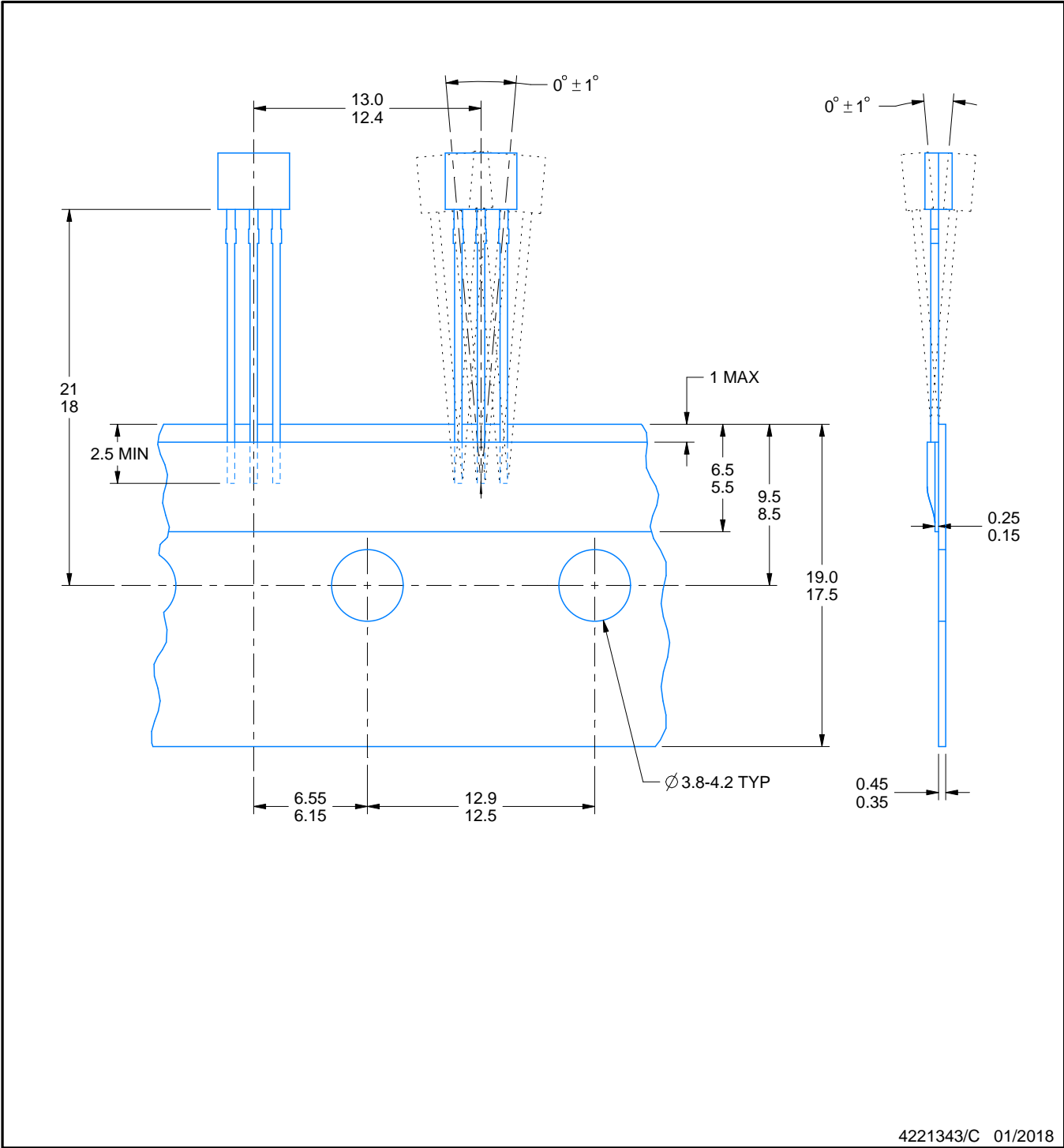

4221343/C 01/2018

DCK0005A



PACKAGE OUTLINE

SOT - 1.1 max height

SMALL OUTLINE TRANSISTOR



4214834/G 11/2024

NOTES:

1. All linear dimensions are in millimeters. Any dimensions in parenthesis are for reference only. Dimensioning and tolerancing per ASME Y14.5M.
2. This drawing is subject to change without notice.
3. Reference JEDEC MO-203.
4. Support pin may differ or may not be present.
5. Lead width does not comply with JEDEC.
6. Body dimensions do not include mold flash, protrusions, or gate burrs. Mold flash, protrusions, or gate burrs shall not exceed 0.25mm per side

EXAMPLE BOARD LAYOUT

DCK0005A

SOT - 1.1 max height

SMALL OUTLINE TRANSISTOR



LAND PATTERN EXAMPLE
EXPOSED METAL SHOWN
SCALE:18X



SOLDER MASK DETAILS

4214834/G 11/2024

NOTES: (continued)

- 7. Publication IPC-7351 may have alternate designs.
- 8. Solder mask tolerances between and around signal pads can vary based on board fabrication site.

EXAMPLE STENCIL DESIGN

DCK0005A

SOT - 1.1 max height

SMALL OUTLINE TRANSISTOR



SOLDER PASTE EXAMPLE
BASED ON 0.125 THICK STENCIL
SCALE: 18X

4214834/G 11/2024

NOTES: (continued)

9. Laser cutting apertures with trapezoidal walls and rounded corners may offer better paste release. IPC-7525 may have alternate design recommendations.
10. Board assembly site may have different recommendations for stencil design.

GENERIC PACKAGE VIEW

LP 3

TO-92 - 5.34 mm max height

TRANSISTOR OUTLINE



Images above are just a representation of the package family, actual package may vary.
Refer to the product data sheet for package details.

4040001-2/F

LP0003A



PACKAGE OUTLINE

TO-92 - 5.34 mm max height

TO-92



4215214/B 04/2017

NOTES:

1. All linear dimensions are in millimeters. Any dimensions in parenthesis are for reference only. Dimensioning and tolerancing per ASME Y14.5M.
2. This drawing is subject to change without notice.
3. Lead dimensions are not controlled within this area.
4. Reference JEDEC TO-226, variation AA.
5. Shipping method:
 - a. Straight lead option available in bulk pack only.
 - b. Formed lead option available in tape and reel or ammo pack.
 - c. Specific products can be offered in limited combinations of shipping medium and lead options.
 - d. Consult product folder for more information on available options.



LAND PATTERN EXAMPLE
STRAIGHT LEAD OPTION
NON-SOLDER MASK DEFINED
SCALE:15X



LAND PATTERN EXAMPLE
FORMED LEAD OPTION
NON-SOLDER MASK DEFINED
SCALE:15X

TAPE SPECIFICATIONS

LP0003A

TO-92 - 5.34 mm max height

TO-92

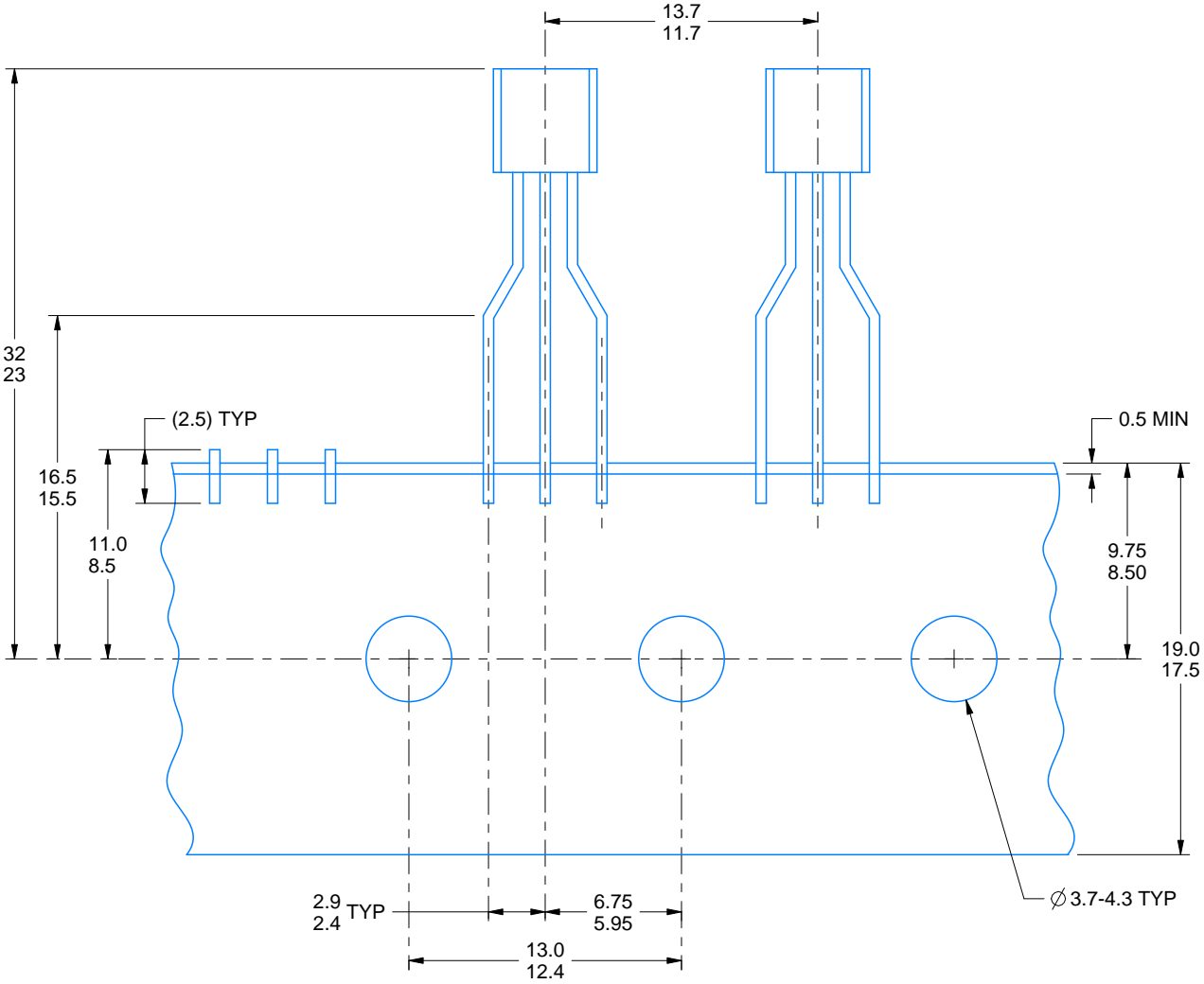

FOR FORMED LEAD OPTION PACKAGE

4215214/B 04/2017

重要なお知らせと免責事項

テキサス・インスツルメンツは、技術データと信頼性データ(データシートを含みます)、設計リソース(リファレンス デザインを含みます)、アプリケーションや設計に関する各種アドバイス、Web ツール、安全性情報、その他のリソースを、欠陥が存在する可能性のある「現状のまま」提供しており、商品性および特定目的に対する適合性の黙示保証、第三者の知的財産権の非侵害保証を含むいかなる保証も、明示的または黙示的にかかわらず拒否します。

これらのリソースは、テキサス・インスツルメンツ製品を使用する設計の経験を積んだ開発者への提供を意図したものです。(1) お客様のアプリケーションに適したテキサス・インスツルメンツ製品の選定、(2) お客様のアプリケーションの設計、検証、試験、(3) お客様のアプリケーションに該当する各種規格や、その他のあらゆる安全性、セキュリティ、規制、または他の要件への確実な適合に関する責任を、お客様のみが単独で負うものとし、ます。

上記の各種リソースは、予告なく変更される可能性があります。これらのリソースは、リソースで説明されているテキサス・インスツルメンツ製品を使用するアプリケーションの開発の目的でのみ、テキサス・インスツルメンツはその使用をお客様に許諾します。これらのリソースに関して、他の目的で複製することや掲載することは禁止されています。テキサス・インスツルメンツや第三者の知的財産権のライセンスが付与されている訳ではありません。お客様は、これらのリソースを自身で使用した結果発生するあらゆる申し立て、損害、費用、損失、責任について、テキサス・インスツルメンツおよびその代理人を完全に補償するものとし、テキサス・インスツルメンツは一切の責任を拒否します。

テキサス・インスツルメンツの製品は、[テキサス・インスツルメンツの販売条件](#)、または [ti.com](https://www.ti.com) やかかるテキサス・インスツルメンツ製品の関連資料などのいずれかを通じて提供する適用可能な条項の下で提供されています。テキサス・インスツルメンツがこれらのリソースを提供することは、適用されるテキサス・インスツルメンツの保証または他の保証の放棄の拡大や変更を意味するものではありません。

お客様がいかなる追加条項または代替条項を提案した場合でも、テキサス・インスツルメンツはそれらに異議を唱え、拒否します。

郵送先住所：Texas Instruments, Post Office Box 655303, Dallas, Texas 75265
Copyright © 2025, Texas Instruments Incorporated