

## LMX8410L 高性能ミキサ、シンセサイザ内蔵

### 1 特長

- 広帯域RF入力: 4~10GHz
- 広いIF帯域幅: DC~1350MHz
- 入力IP3 : 5GHz RF入力時28dBm
- ノイズ指数 : 5GHz RF入力時15dB
- 高電圧変換ゲイン : 5GHz RF入力時11dB
- 広帯域RF入力バランを内蔵
- $\pm 2\text{mV}$ までの自動オフラインDCオフセット補正
- IMRR較正をプログラム可能
- 複数デバイスに対応する同期機能
- 高性能な内蔵LOシンセサイザ : 5GHz搬送波で56.5dBcのDSB積算ノイズ
- 外部LOモード : 内蔵LOシンセサイザをバイパス可能、外部LO注入をサポート
- 低ノイズLDOを内蔵
- 7mmx7mmの48ピンQFNパッケージ

### 2 アプリケーション

- テストおよび計測機器
- ワイヤレス・インフラ
- フェーズド・アレイ・レーダー
- マイクロ波バックホール
- 衛星通信
- ソフトウェア無線

### 3 概要

LMX8410Lは、LOおよびIFアンプを内蔵した、高性能な広帯域(RF周波数入力4~10GHz)のI/Q復調器です。28dBmのIIP3と15dBのNF(いずれも5GHz時)により、高性能アプリケーションで優れたダイナミック・レンジが得られます。高データレートのアプリケーションで、2.7GHzの広大な複合帯域を実現します。

LMX8410Lは自動DCオフセット補正アルゴリズムを採用しているため、オフセットを $\pm 2\text{mV}$ 未満まで低減できます。SPIインターフェイスを使用して、IおよびQチャンネルのゲインと位相の微調整を有効にすることにより、高いイメージ除去率を達成できます。

LMX8410Lは高度な統合により、高性能を実現しながら基板面積を縮小し、複雑さを低減します。広帯域RF入力バランを内蔵しているため外付けバランは必要なく、高性能PLLおよびVCOを内蔵しているため外付けLOおよびLOドライバも必要ありません。また、IFアンプといくつかの低ノイズLDOも内蔵しているため、基板をさらに簡素化できます。

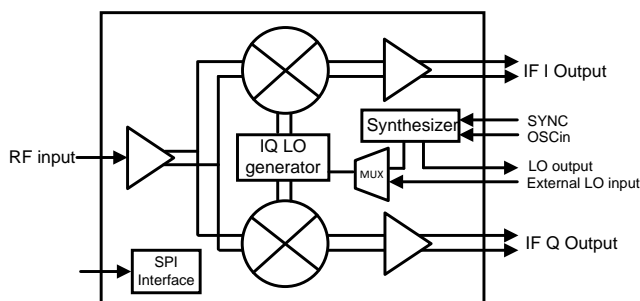
LMX8410Lは超低ノイズのシンセサイザを搭載し、PLL FOMが $-236\text{dBc/Hz}$ であることから、5GHz搬送波でのDSB積算ノイズが最大56.5dBcとなります。LOにより、複数デバイスでの位相同期が可能で、高性能シンセサイザの出力を引き出して、別の段またはデータ・コンバータを駆動できます。共通の外付けLOを共有するアプリケーションでは、内蔵LOを迂回できます。

#### 製品情報<sup>(1)</sup>

型番	パッケージ	本体サイズ(公称)
LMX8410L	VQFN (48)	7.00mmx7.00mm

(1) 提供されているすべてのパッケージについては、巻末の注文情報を参照してください。

#### ブロック概略図



## 目次

<b>1</b>	<b>特長</b> .....	<b>1</b>	7.5	Programming.....	<b>29</b>
<b>2</b>	<b>アプリケーション</b> .....	<b>1</b>	7.6	Register Map.....	<b>30</b>
<b>3</b>	<b>概要</b> .....	<b>1</b>	<b>8</b>	<b>Application and Implementation</b> .....	<b>53</b>
<b>4</b>	<b>改訂履歴</b> .....	<b>2</b>	8.1	Application Information.....	<b>53</b>
<b>5</b>	<b>Pin Configuration and Functions</b> .....	<b>3</b>	8.2	Typical Application.....	<b>53</b>
<b>6</b>	<b>Specifications</b> .....	<b>6</b>	<b>9</b>	<b>Power Supply Recommendations</b> .....	<b>56</b>
6.1	Absolute Maximum Ratings.....	<b>6</b>	<b>10</b>	<b>Layout</b> .....	<b>56</b>
6.2	ESD Ratings.....	<b>6</b>	10.1	Layout Guidelines.....	<b>56</b>
6.3	Recommended Operating Conditions.....	<b>6</b>	10.2	Layout Examples.....	<b>57</b>
6.4	Thermal Information.....	<b>6</b>	<b>11</b>	<b>デバイスおよびドキュメントのサポート</b> .....	<b>61</b>
6.5	Electrical Characteristics.....	<b>7</b>	11.1	ドキュメントのサポート.....	<b>61</b>
6.6	Timing Requirements.....	<b>12</b>	11.2	ドキュメントの更新通知を受け取る方法.....	<b>61</b>
6.7	Typical Characteristics.....	<b>14</b>	11.3	コミュニティ・リソース.....	<b>61</b>
<b>7</b>	<b>Detailed Description</b> .....	<b>22</b>	11.4	商標.....	<b>61</b>
7.1	Overview.....	<b>22</b>	11.5	静電気放電に関する注意事項.....	<b>61</b>
7.2	Functional Block Diagram.....	<b>22</b>	11.6	Glossary.....	<b>61</b>
7.3	Feature Description.....	<b>23</b>	<b>12</b>	<b>メカニカル、パッケージ、および注文情報</b> .....	<b>61</b>
7.4	Device Functional Modes.....	<b>28</b>			

## 4 改訂履歴

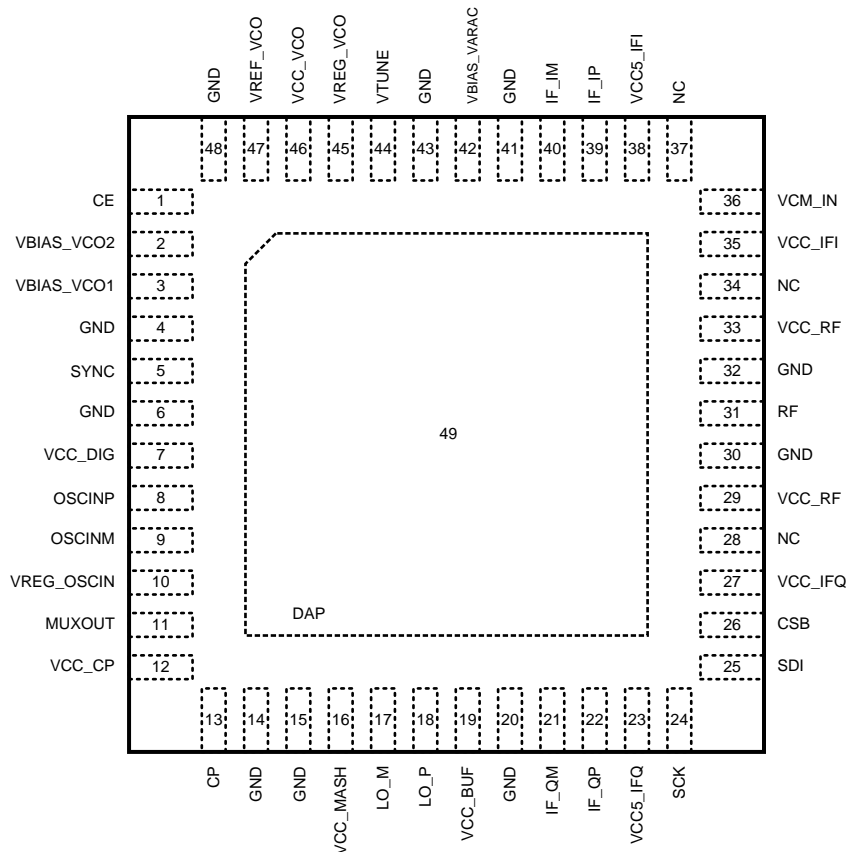
資料番号末尾の英字は改訂を表しています。その改訂履歴は英語版に準じています。

### 2018年3月発行のものから更新

	<b>Page</b>
• 生産データを用いたデータシートの初版.....	<b>1</b>
• Changed many numbers in electrical specifications table.....	<b>6</b>
• 追加 typical performance characteristics section.....	<b>14</b>
• 変更 and added significant details in detailed descriptions sections. Added sections, changed several portions of the register map.....	<b>22</b>

## 5 Pin Configuration and Functions

**RGZ Package  
48-Pin QFN  
Top View**



**Pin Functions**

PIN		I/O	DESCRIPTION
NAME	NAME		
1	CE	Input	Chip Enable input. Active HIGH powers on the device. 1.8V to 3.3V logic.
2	VBIAS_VCO2	Bypass	VCO bias. Requires connecting 10- $\mu$ F capacitor to VCO ground. Place close to pin. If using external LO, this pin should either be floated or configured the same way as internal LO mode.
3	VBIAS_VCO1	Bypass	VCO bias. Requires connecting 10- $\mu$ F capacitor to VCO ground. Place close to pin. If using external LO, this pin should either be floated or configured the same way as internal LO mode.
4	GND	Ground	VCO ground. VBIAS pin capacitors must bypass to this point.
5	SYNC	Input	Trigger pin for synchronizing multiple devices. If using external LO, tie this pin to GND.
6	GND	Ground	Digital ground. VCC_DIG bypass capacitors must bypass to this point.
7	VCC_DIG	Supply	Digital supply. TI recommends connecting 0.1- $\mu$ F capacitor to digital ground.
8	OSCINP	Input	Reference input clock (+). High input impedance. Requires connecting series capacitor (0.1 $\mu$ F recommended). If using external LO, tie this pin to GND.
9	OSCINM	Input	Reference input clock (-). High input impedance. Requires connecting series capacitor (0.1 $\mu$ F recommended). If using external LO, tie this pin to GND.
10	VREG_OSCIN	Bypass	Internal LDO output. Requires connecting 1- $\mu$ F capacitor to digital ground. Place close to pin. If using external LO, this pin should either be floated or configured the same way as internal LO mode.

**Pin Functions (continued)**

PIN		I/O	DESCRIPTION
NAME	NAME		
11	MUXOUT	Output	Readback or lock detect output. Pin mode configured by internal register settings.
12	VCC_CP	Supply	Charge pump supply. TI recommends connecting 0.1 $\mu$ F and 100 pF to charge pump ground. Place close to pin. This pin must be connected to VCC, even if using external LO.
13	CP	Output	Charge pump output. TI recommends connecting C1 of loop filter close to pin. If using external LO, this pin should either be floated or configured the same way as internal LO mode.
14	GND	Ground	Charge pump ground. VCC_CP bypass capacitors must bypass to this point.
15	GND	Ground	MASH engine ground. VCC_MASH bypass capacitors must bypass to this point.
16	VCC_MASH	Supply	MASH engine supply. TI recommends connecting 0.1 $\mu$ F and 100 pF to MASH engine ground. Place close to pin. This pin must be connected to VCC, even if using external LO.
17	LO_M	Input/Output	Internal LO differential output (–) or external LO differential input (–). In differential output mode, requires connecting 50- $\Omega$ resistor pullup to V <sub>CC</sub> as close as possible to pin. In differential input mode, remove the pull up resistors or inductors. The input should be capacitively coupled with internal biasing. See <a href="#">LO Interface</a> for more information.
18	LO_P	Input/Output	Internal LO differential output (+) or external LO differential input (+). In differential output mode, requires connecting 50- $\Omega$ resistor pullup to V <sub>CC</sub> as close as possible to pin. In differential input mode, remove the pull up resistors or inductors. The input should be capacitively coupled with internal biasing. See <a href="#">LO Interface</a> for more information.
19	VCC_BUF	Supply	LO buffer supply. TI recommends connecting 0.1 $\mu$ F and 100 pF to VCO ground. This pin must be connected to VCC, even if using external LO.
20	GND	Ground	IF amplifier Q-channel ground. Q-channel VCC5 bypass capacitors must bypass to this point.
21	IF_QM	Output	IF amplifier Q-channel differential output (–). TI recommends connecting series 50- $\Omega$ resistor close to pin.
22	IF_QP	Output	IF amplifier Q-channel differential output (+). TI recommends connecting series 50- $\Omega$ resistor close to pin.
23	VCC5_IFQ	Supply	IF amplifier Q-channel 5-V supply. TI recommends connecting 0.1 $\mu$ F and 100 pF to IF amplifier Q-channel ground. Place close to pin.
24	SCK	Input	SPI clock signal. High impedance CMOS input. 1.8-V to 3.3-V logic.
25	SDI	Input	SPI data signal. High impedance CMOS input. 1.8-V to 3.3-V logic.
26	CSB	Input	SPI chip select signal. High impedance CMOS input. 1.8-V to 3.3-V logic.
27	VCC_IFQ	Supply	IF mixer Q-channel supply. TI recommends connecting 0.1 $\mu$ F and 100 pF to digital ground.
28	NC	N/A	No connect. Pin is not internally connected and may be floated or shorted to other nodes.
29	VCC_RFQ	Supply	RF Q-channel supply. TI recommends connecting 0.1 $\mu$ F and 100 pF to digital ground.
32	GND	Ground	RF input path ground.
31	RF	Input	RF input. Single-ended. Must be AC coupled.
32	GND	Ground	RF input path ground.
33	VCC_RFI	Supply	RF I-channel supply. TI recommends connecting 0.1 $\mu$ F and 100 pF to digital ground.
34	GND	Ground	Should be connected IF ground.
35	VCC_IFI	Supply	IF mixer I-channel supply. TI recommends connecting 0.1 $\mu$ F and 100 pF to digital ground.
36	VCM_IN	Input	Common-mode voltage input. When the VCM_CONFIG register is set to external (0xF), the voltage on this pin sets the common-mode voltage of the IF amplifiers.
37	NC	Ground	Connect this pin to IF ground.
38	VCC5_IFI	Supply	IF amplifier I-channel 5-V supply. TI recommends connecting 0.1 $\mu$ F and 100 pF to IF amplifier I-channel ground. Place close to pin.
39	IF_IP	Output	IF amplifier I-channel differential output (+). TI recommends connecting series 50- $\Omega$ resistor close to pin.
40	IF_IM	Output	IF amplifier I-channel differential output (–). TI recommends connecting series 50- $\Omega$ resistor close to pin.
41	GND	Ground	IF amplifier I-channel ground. I-channel VCC5 bypass capacitors should bypass to this point.
42	VBIAS_VARAC	Bypass	VCO varactor bias. Requires connecting 10 $\mu$ F capacitor to VCO ground. If using external LO, this pin should either be floated or configured the same way as internal LO mode.
43	GND	Ground	VCO ground. Varactor bias bypass capacitor should bypass to this point.

**Pin Functions (continued)**

PIN		I/O	DESCRIPTION
NAME	NAME		
44	VTUNE	Input	VCO tuning voltage input. If using internal LO, connect the output of the loop filter to this point. If using external LO, tie this pin to GND.
45	VREG_VCO	Bypass	VCO LDO output node. Requires connecting 10- $\mu$ F capacitor to VCO ground. Place close to pin. This capacitor must be present even if used in external LO mode.
46	VCC_VCO	Supply	VCO supply. TI recommends connecting 0.1- $\mu$ F and 100-pF capacitors to VCO ground. This pin must be connected to VCC, even if using external LO.
47	VREF_VCO	Bypass	VCO LDO reference node. Requires connecting 1- $\mu$ F capacitor to VCO ground. If using external LO, this pin should either be floated or configured the same way as internal LO mode.
48	GND	Ground	VCO ground. VCO LDO, LDO reference, and supply bypass capacitors must bypass to this point.
49	PAD	Ground	Die attach pad. Internally connected to ground. TI recommends shorting ground pins to this pad on the same plane, if possible.

## 6 Specifications

### 6.1 Absolute Maximum Ratings

over operating free-air temperature range (unless otherwise noted)<sup>(1)</sup>

		MIN	MAX	UNIT
V <sub>CC</sub>	Power supply voltage, 3.3-V rail	-0.3	3.6	V
V <sub>CC5</sub>	Power supply voltage, 5-V rail	-0.3	5.3	V
P <sub>D</sub>	Power dissipation		5	W
T <sub>J</sub>	Junction temperature	-40	150	°C
T <sub>stg</sub>	Storage temperature	-65	150	°C

(1) Stresses beyond those listed under *Absolute Maximum Rating* may cause permanent damage to the device. These are stress ratings only, which do not imply functional operation of the device at these or any other conditions beyond those indicated under *Recommended Operating Condition*. Exposure to absolute-maximum-rated conditions for extended periods may affect device reliability.

### 6.2 ESD Ratings

			VALUE	UNIT
V <sub>(ESD)</sub>	Electrostatic discharge	Human body model (HBM), per ANSI/ESDA/JEDEC JS-001, all pins	2500	V
		Charged device model (CDM), per JEDEC specification JESD22-C101, all pins	500	

### 6.3 Recommended Operating Conditions

over operating free-air temperature range (unless otherwise noted)

		MIN	NOM	MAX	UNIT
V <sub>CC</sub>	Power supply voltage, 3.3V rail	3.15	3.3	3.45	V
V <sub>CC5</sub>	Power supply voltage, 5V rail	4.75	5	5.25	V
T <sub>A</sub>	Ambient temperature	-40	25	85	°C
T <sub>J</sub>	Junction temperature			125	°C

### 6.4 Thermal Information

THERMAL METRIC <sup>(1) (2)</sup>		LMX8410L	UNIT
		RGZ (VQFN)	
		48 PINS	
R <sub>θJA</sub>	Junction-to-ambient thermal resistance	21.9	°C/W
R <sub>θJC(top)</sub>	Junction-to-case (top) thermal resistance	9.4	°C/W
R <sub>θJB</sub>	Junction-to-board thermal resistance	5.6	°C/W
Ψ <sub>JT</sub>	Junction-to-top characterization parameter	0.1	°C/W
Ψ <sub>JB</sub>	Junction-to-board characterization parameter	5.6	°C/W
R <sub>θJC(bot)</sub>	Junction-to-case (bottom) thermal resistance	0.4	°C/W

- (1) For more information about traditional and new thermal metrics, see the [Semiconductor and IC Package Thermal Metrics](#) application report.
- (2) Thermal model based on JEDEC standard coupon, 50.8 mm × 50.8 mm × 1.6 mm, six-layer Cu, 0.5 oz top layer, 2 oz else. 6 × 6 thermal vias in DAP, 0.2 mm diameter.

## 6.5 Electrical Characteristics

Measurements are done at 25 degree C. Parameters are measured at IF = 65MHz with high side injection, unless otherwise noted. Measurements are done with external VCM = 1.7V.

PARAMETER		TEST CONDITIONS	MIN	TYP	MAX	UNIT
<b>POWER SUPPLY</b>						
V <sub>CC</sub>	Power supply voltage, 3.3-V rail		3.15	3.3	3.45	V
I <sub>CC</sub>	Power supply current, 3.3-V rail	Internal LO		650		mA
		External LO		330		
V <sub>CC5</sub>	Power supply voltage, 5-V rail		4.75	5	5.25	V
I <sub>CC5</sub>	Power supply current both channels I and Q, 5-V rail			130		mA
<b>FREQUENCY RANGES</b>						
F <sub>RF</sub>	RF port frequency range		4000		10000	MHz
F <sub>LO</sub>	LO port frequency range		4000		10000	MHz
F <sub>IF</sub>	IF port frequency range (3dB bandwidth)		DC		1350	MHz
<b>DYNAMIC PERFORMANCE</b>						
NF	Noise figure	RF = 4 GHz		15		dB
		RF = 5 GHz		15		
		RF = 6 GHz		16		
		RF = 7 GHz		17		
		RF = 8 GHz		18		
		RF = 9 GHz		19		
		RF = 10 GHz		19		
G	Voltage gain <sup>(1)</sup>	RF = 4 GHz		11		dB
		RF = 5 GHz		11		
		RF = 6 GHz		10.5		
		RF = 7 GHz		9.5		
		RF = 8 GHz		9		
		RF = 10 GHz		7		
IIP3	Input intercept point, 3rd order <sup>(2)</sup>	RF = 4 GHz		28		dBm
		RF = 5 GHz		28		
		RF = 6 GHz		26.5		
		RF = 7 GHz		27		
		RF = 8 GHz		26.5		
		RF = 10 GHz		27		
IIP2	Input intercept point, 2nd order (uncalibrated)	RF = 4 GHz		48		dBm
		RF = 5 GHz		48		
		RF = 6 GHz		46		
		RF = 7 GHz		44		
		RF = 8 GHz		45		
		RF = 10 GHz		42		

(1) For measurements that require RF input, RF input power is -10dBm unless otherwise specified.

(2) For two-tone measurements, tone separation is 17MHz.

**Electrical Characteristics (continued)**

Measurements are done at 25 degree C. Parameters are measured at IF = 65MHz with high side injection, unless otherwise noted. Measurements are done with external VCM = 1.7V.

PARAMETER		TEST CONDITIONS	MIN	TYP	MAX	UNIT
SP <sub>2x2</sub>	2x2 spur [RF input power at -10 dBm]	RF = 4 GHz		-58		dBc
		RF = 5 GHz		-58		
		RF = 6 GHz		-58		
		RF = 7 GHz		-54		
		RF = 8 GHz		-52		
		RF = 9 GHz		-50		
		RF = 10 GHz		-48		
SP <sub>3x3</sub>	3x3 spur [RF input power at -10 dBm]	RF = 4 GHz		-75		dBc
		RF = 5 GHz		-75		
		RF = 6 GHz		-75		
		RF = 7 GHz		-75		
		RF = 8 GHz		-75		
		RF = 9 GHz		-75		
		RF = 10 GHz		-75		
OP <sub>1dB</sub>	Output 1-dB compression point	RF = 4 GHz		12		dBm
		RF = 5 GHz		12		
		RF = 6 GHz		12		
		RF = 7 GHz		12		
		RF = 8 GHz		12		
		RF = 9 GHz		12		
		RF = 10 GHz		12		
IRR	Image rejection ratio [calibrated]	RF = 4 GHz		43		dB
		RF = 5 GHz		43		
		RF = 6 GHz		44		
		RF = 7 GHz		44		
		RF = 8 GHz		43		
		RF = 9 GHz		42		
		RF = 10 GHz		36		
ISO <sub>RFxIF</sub>	RF to IF isolation	RF = 4 GHz		40		dB
		RF = 5 GHz		40		
		RF = 6 GHz		40		
		RF = 7 GHz		40		
		RF = 8 GHz		40		
		RF = 9 GHz		40		
		RF = 10 GHz		40		
LEAK <sub>RFxIF</sub>	LO to IF leakage	LO = 4 GHz		-35		dBm
		LO = 5 GHz		-35		
		LO = 6 GHz		-35		
		LO = 7 GHz		-35		
		LO = 8 GHz		-35		
		LO = 9 GHz		-35		
		LO = 10 GHz		-35		



## Electrical Characteristics (continued)

Measurements are done at 25 degree C. Parameters are measured at IF = 65MHz with high side injection, unless otherwise noted. Measurements are done with external VCM = 1.7V.

PARAMETER		TEST CONDITIONS	MIN	TYP	MAX	UNIT
LEAK <sub>LOxRF</sub>	LO to RF leakage (internal Lo mode)	LO = 4 GHz		-60		dBm
		LO = 5 GHz		-60		
		LO = 6 GHz		-52		
		LO = 7 GHz		-50		
		LO = 8 GHz		-50		
		LO = 9 GHz		-45		
		LO = 10 GHz		-40		
<b>PERFORMANCE TUNING</b>						
G <sub>IQ_CAL</sub>	I/Q gain calibration range	IMRR_GCAL register full range		±0.5		dB
G <sub>IQ_STEP</sub>	I/Q gain calibration step size			0.05		dB
PH <sub>IQ_CAL</sub>	I/Q phase calibration range	IMRR_PCAL register full range		±20		Deg
PH <sub>IQ_STEP</sub>	I/Q phase calibration step size	Step size can be made reduced to 0.25 deg in fine accuracy mode		0.45		Deg
V <sub>DCOC</sub>	calibrated differential DC offset			+/- 2		mV
<b>PORTS</b>						
S <sub>11RF</sub>	RF return loss	RF = 4 GHz		8		dB
		RF = 5 GHz		19		dB
		RF = 6 GHz		21		dB
		RF = 7 GHz		16		dB
		RF = 8 GHz		10		dB
		RF = 9 GHz		9		dB
		RF = 10 GHz		9		dB
S <sub>11LO</sub>	LO return loss (differential measurement)	RF = 4 GHz		15		dB
		RF = 5 GHz		15		dB
		RF = 6 GHz		20		dB
		RF = 7 GHz		17		dB
		RF = 8 GHz		18		dB
		RF = 9 GHz		17		dB
		RF = 10 GHz		12		dB
P <sub>LO_IN</sub>	External LO input power	8 GHz RF <sub>IN</sub>		6		dBm
P <sub>LO_OUT</sub>	External LO output power <sup>(3)</sup>	<7 GHz RF <sub>out</sub>		2		dBm
		<10 GHz RF <sub>out</sub>		-1		dBm
V <sub>IF_RANGE</sub>	IF output voltage swing (differential)			2		V <sub>PP</sub>
V <sub>CM</sub>	IF common mode voltage, internal or external source		1.2	1.7	2	V
P <sub>inRF</sub>	RF input power				5	dBm
<b>LO SYNTHESIZER INPUT SIGNAL PATH</b>						
F <sub>OSCIN</sub>	Reference oscillator port frequency range	OSC_2X = 0		5	1400	MHz
		OSC_2X = 1		5	200	
V <sub>OSCIN</sub>	Reference input voltage	AC-coupled required <sup>(4)</sup>		0.2	2	V <sub>pp</sub>
F <sub>MULT</sub>	Multiplier frequency (when multiplier enabled)	Input range		30	70	MHz
		Output range		180	250	

(3) Output power, spurs, and harmonics can vary based on board layout and components.

(4) For lower VCO frequencies, the N divider minimum value can limit the phase detector frequency.

**Electrical Characteristics (continued)**

Measurements are done at 25 degree C. Parameters are measured at IF = 65MHz with high side injection, unless otherwise noted. Measurements are done with external VCM = 1.7V.

PARAMETER	TEST CONDITIONS	MIN	TYP	MAX	UNIT
<b>LO SYNTHESIZER PHASE DETECTOR AND CHARGE PUMP</b>					
F <sub>PD</sub>	Phase detector frequency	Integer Mode (FRAC_ORDER = 0)	0.125	400	MHz
		Fractional Mode (FRAC_ORDER = 1,2,3)	5	300	
		Fractional Mode (FRAC_ORDER = 4)	5	240	
I <sub>CPOUT</sub>	Charge pump leakage current	CPG = 0	15		nA
	Effective charge pump current (sum of up and down currents)	CPG = 4	3		mA
		CPG = 1	6		
		CPG = 5	9		
		CPG = 3	12		
		CPG = 7	15		
PN <sub>1/F</sub>	Normalized PLL flicker noise	F <sub>PD</sub> = 100 MHz, F <sub>VCO</sub> = 12 GHz <sup>(5)</sup>		-129	dBc/Hz
PN <sub>FLAT</sub>	Normalized PLL thermal noise floor			-236	dBc/Hz

- (5) The PLL noise contribution is measured using a clean reference and a wide loop bandwidth and is composed into flicker and flat components.  $PLL_{FLAT} = PLL_{FOM} + 20\log(F_{VCO} / F_{PD}) + 10\log(F_{PD} / 1\text{Hz})$ .  $PLL_{FLICKER}(\text{offset}) = PLL_{FLICKER\_NORM} + 20\log(F_{VCO} / 1\text{GHz}) - 10\log(\text{offset frequency} / 10\text{kHz})$ . Once these two components are found, the total PLL noise can be calculated as  $PLL_{NOISE} = 10\log(10^{PLL_{FLAT} / 10} + 10^{PLL_{FLICKER} / 10})$ .

**Electrical Characteristics (continued)**

Measurements are done at 25 degree C. Parameters are measured at IF = 65MHz with high side injection, unless otherwise noted. Measurements are done with external VCM = 1.7V.

PARAMETER		TEST CONDITIONS	MIN	TYP	MAX	UNIT
<b>LO SYNTHESIZER VCO</b>						
PNvco	Open loop VCO phase noise	8 GHz VCO, 10 kHz offset		-80		dBc/Hz
		8 GHz VCO, 100 kHz offset		-107		
		8 GHz VCO, 1 MHz offset		-128		
		8 GHz VCO, 10 MHz offset		-148		
		8 GHz VCO, 90 MHz offset		-157		
		9.2 GHz VCO, 10 kHz offset		-79		
		9.2 GHz VCO, 100 kHz offset		-105		
		9.2 GHz VCO, 1 MHz offset		-127		
		9.2 GHz VCO, 10 MHz offset		-147		
		9.2 GHz VCO, 90 MHz offset		-157		
		10.3 GHz VCO, 10 kHz offset		-77		
		10.3 GHz VCO, 100 kHz offset		-104		
		10.3 GHz VCO, 1 MHz offset		-126		
		10.3 GHz VCO, 10 MHz offset		-147		
		10.3 GHz VCO, 90 MHz offset		-157		
		11.3 GHz VCO, 10 kHz offset		-76		
		11.3 GHz VCO, 100 kHz offset		-103		
		11.3 GHz VCO, 1 MHz offset		-125		
		11.3 GHz VCO, 10 MHz offset		-145		
		11.3 GHz VCO, 90 MHz offset		-158		
		12.5 GHz VCO, 10 kHz offset		-74		
		12.5 GHz VCO, 100 kHz offset		-100		
		12.5 GHz VCO, 1 MHz offset		-123		
		12.5 GHz VCO, 10 MHz offset		-144		
		12.5 GHz VCO, 90 MHz offset		-157		
		13.3 GHz VCO, 10 kHz offset		-73		
		13.3 GHz VCO, 100 kHz offset		-100		
		13.3 GHz VCO, 1 MHz offset		-122		
13.3 GHz VCO, 10 MHz offset		-143				
13.3 GHz VCO, 90 MHz offset		-155				
14.5 GHz VCO, 10 kHz offset		-73				
14.5 GHz VCO, 100 kHz offset		-99				
14.5 GHz VCO, 1 MHz offset		-121				
14.5 GHz VCO, 10 MHz offset		-143				
14.5 GHz VCO, 90 MHz offset		-152				
t <sub>VCO_CAL</sub>	VCO calibration speed, switch across the entire frequency band, F <sub>OSC</sub> = 200 MHz, F <sub>PD</sub> = 100 MHz <sup>(6)</sup>	No assist		50		μs
		Close frequency		20		

(6) See Application and Implementation for more details on the different VCO calibration modes.

## Electrical Characteristics (continued)

Measurements are done at 25 degree C. Parameters are measured at IF = 65MHz with high side injection, unless otherwise noted. Measurements are done with external VCM = 1.7V.

PARAMETER		TEST CONDITIONS	MIN	TYP	MAX	UNIT
K <sub>VCO</sub>	VCO gain	8 GHz		89		MHz/V
		9.2 GHz		93		
		10.3 GHz		110		
		11.3 GHz		124		
		12.5 GHz		189		
		13.3 GHz		182		
		14.5 GHz		205		
ΔT <sub>CL</sub>	Allowable temperature drift when VCO is not re-calibrated			125		°C
H2	VCO second harmonic	FVCO = 8 GHz, divider disabled		-30		dBc
H3	VCO third harmonic	FVCO = 8 GHz, divider disabled		-40		
<b>SYNC PIN AND PHASE ALIGNMENT</b>						
F <sub>OSCIN_SYNC</sub>	Maximum usable OSCIN frequency with SYNC pin	Category 3 (int LO mode)	0		100	MHz
		Category 1 or 2	0		1400	
<b>DIGITAL INTERFACE (SCK, SDI, CSB, MUXOUT, SYNC, CE)</b>						
V <sub>IH</sub>	High level input voltage		1.4		VCC	V
V <sub>IL</sub>	Low level input voltage		0		0.4	V
I <sub>IH</sub>	High level input current		-50		50	μA
I <sub>IL</sub>	Low level input current		-50		50	μA
V <sub>OH</sub>	High level output voltage	I <sub>L</sub> = -5 mA		VCC - 0.55		V
V <sub>OL</sub>	High level output current	I <sub>L</sub> = 5 mA			0.55	V

## 6.6 Timing Requirements

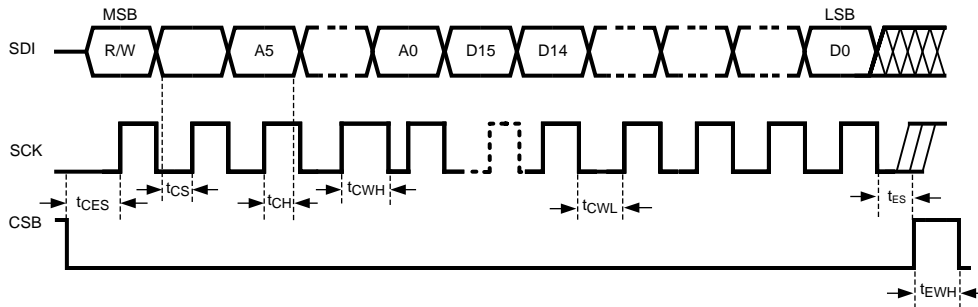
		MIN	NOM	MAX	UNIT
<b>SYNC</b>					
t <sub>SETUP</sub>	Setup time for pin relative to OSCIN rising edge	2.5			ns
t <sub>HOLD</sub>	Hold time for pin relative to OSCIN rising edge	2			ns
<b>DIGITAL WRITE INTERFACE<sup>(1)</sup></b>					
F <sub>SPI_WRITE</sub>	SPI write speed			50	MHz
t <sub>ES</sub>	Clock to enable low time	5			ns
t <sub>CS</sub>	Data to clock setup time	2			ns
t <sub>CH</sub>	Data to clock hold time	2			ns
t <sub>CWH</sub>	Clock pulse width high	5			ns
t <sub>CWL</sub>	Clock pulse width low	10			ns
t <sub>CES</sub>	Enable to clock setup time	10			ns
t <sub>EWL</sub>	Enable pulse width high	10			ns
<b>DIGITAL READBACK INTERFACE<sup>(2)</sup></b>					
F <sub>SPI_READ</sub>	SPI readback speed			50	MHz
t <sub>ES</sub>	Clock to enable low time	10			ns
t <sub>CS</sub>	Clock to data wait time			10	ns
t <sub>CWH</sub>	Clock pulse width high	10			ns
t <sub>CWL</sub>	Clock pulse width low	10			ns
t <sub>CES</sub>	Enable to clock setup time	10			ns

(1) See Figure 1

(2) See Figure 2

**Timing Requirements (continued)**

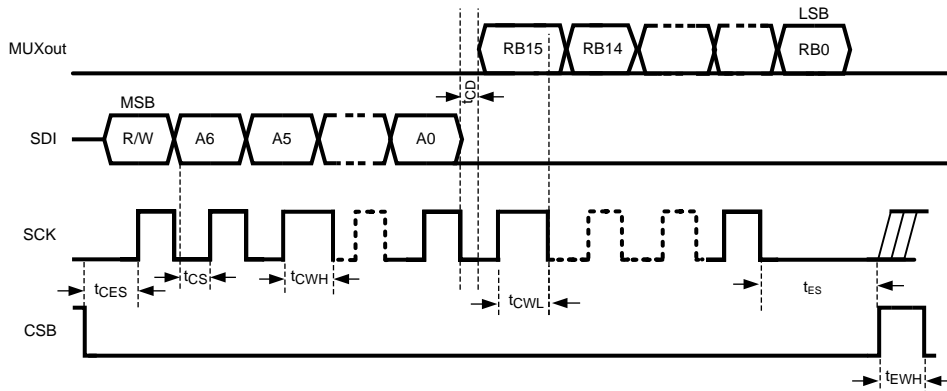
		MIN	NOM	MAX	UNIT
$t_{EWH}$	Enable pulse width high	10			ns



**Fig. 1. Serial Data Input Timing Diagram**

There are several other considerations for writing on the SPI:

- The R/W bit must be set to 0.
- The signal on the SDI pin is clocked into a shift register on each rising edge of the SCK pin.
- The CSB must be held low for data to be clocked. Device ignores clock pulses if CSB is held high.
- The CSB transition from high to low must occur when SCK is low.
- When SCK and SDI lines are shared between devices, TI recommends holding the CSB line high on any devices besides the intended programming target.

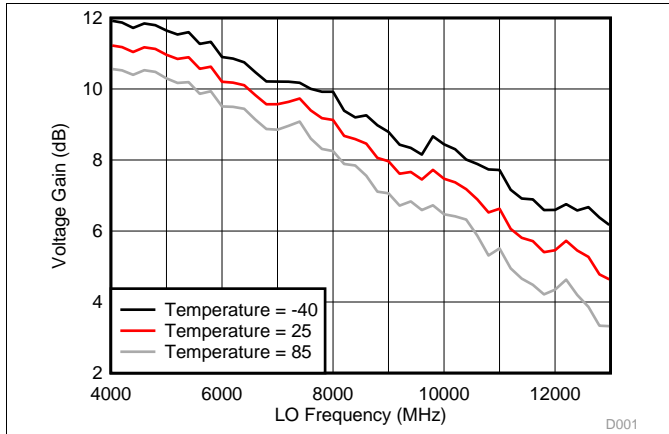


**Fig. 2. Serial Data Readback Timing Diagram**

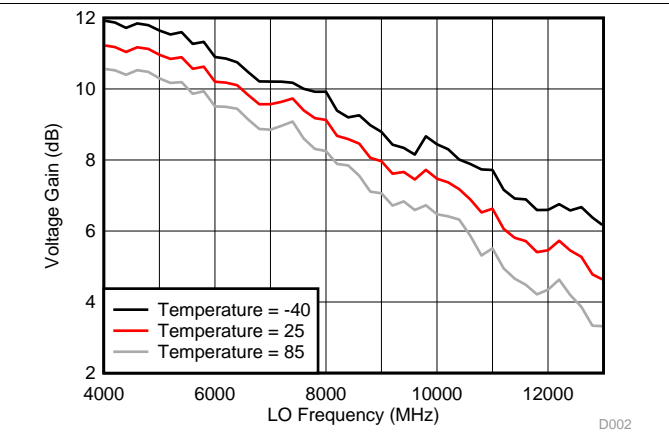
There are several other considerations for SPI readback:

- The R/W bit must be set to 1.
- The MUXOUT pin is always for the address portion of the transaction.
- The address on the SDI pin is clocked into a shift register on each rising edge of the SCK pin.
- The data portion of the transaction on the SDI line is always ignored.
- The data on the MUXOUT pin should be considered valid on each rising edge of the SCK pin, provided all timing requirements are met.
- All CSB considerations for SPI writing also apply to SPI readback.

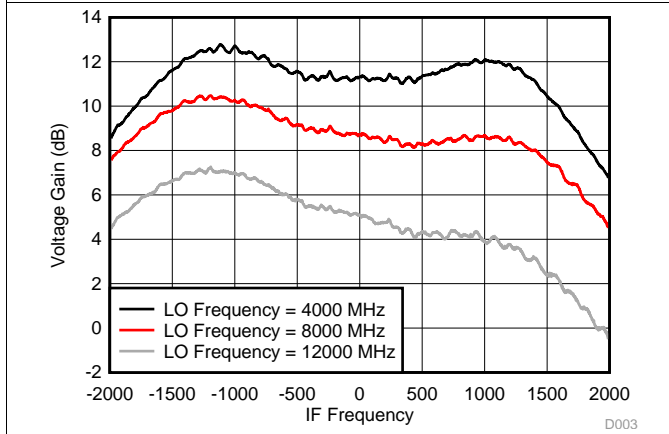
**6.7 Typical Characteristics**



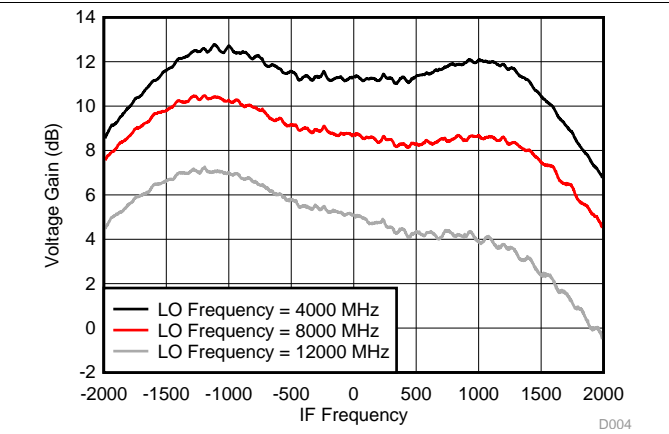
**Figure 3. Voltage Gain Across LO Frequency for Internal LO Mode**



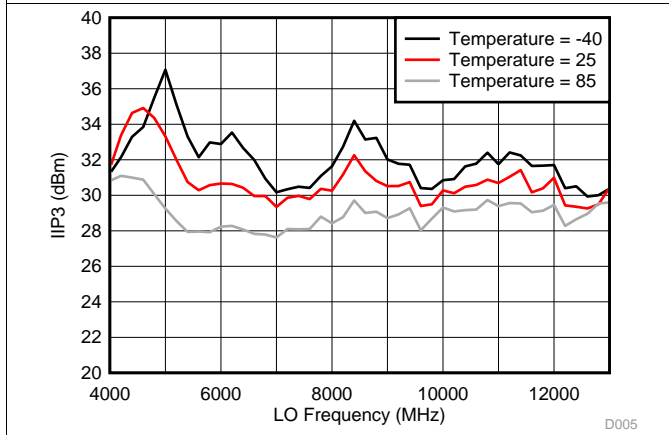
**Figure 4. Voltage Gain Across LO frequency for External LO Mode**



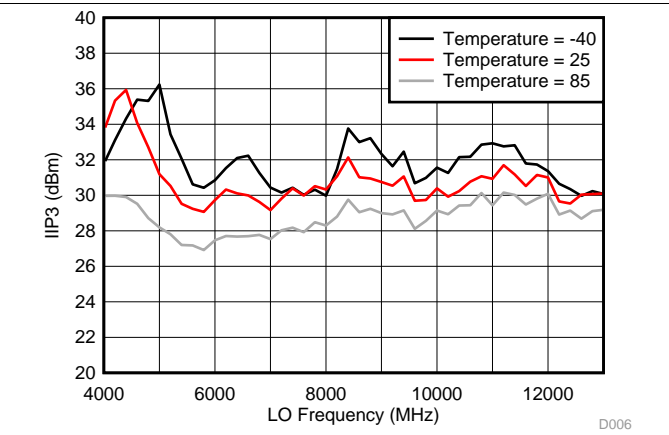
**Figure 5. Voltage Gain Across IF Frequency for Internal LO Mode**



**Figure 6. Voltage Gain Across IF Frequency for External LO Mode**

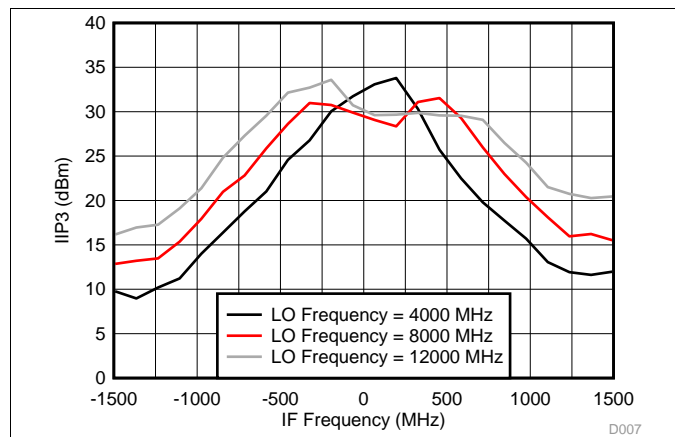


**Figure 7. IIP3 Across LO Frequency for Internal LO Mode**

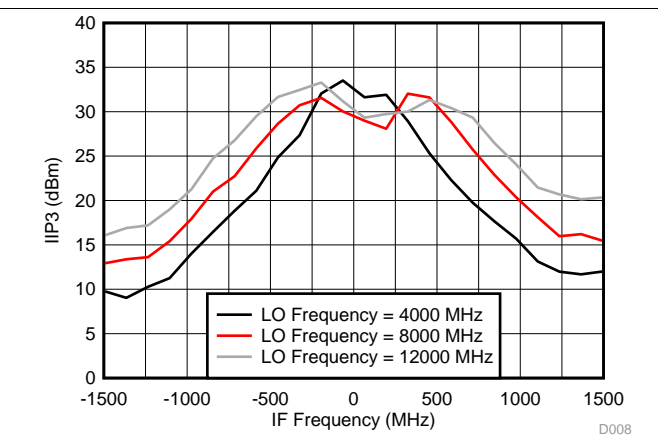


**Figure 8. IIP3 Across LO Frequency for External LO Mode**

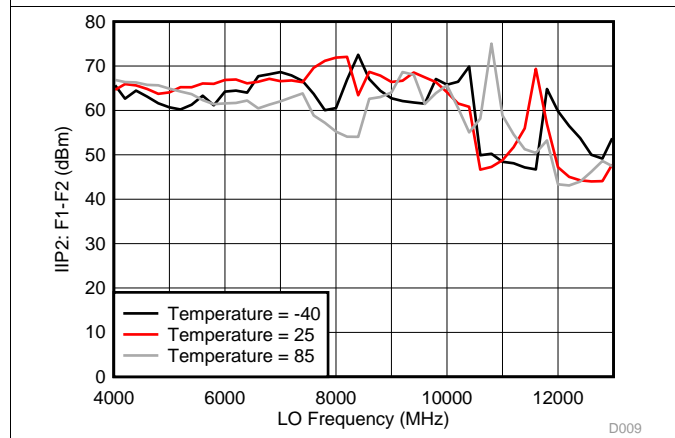
Typical Characteristics (continued)



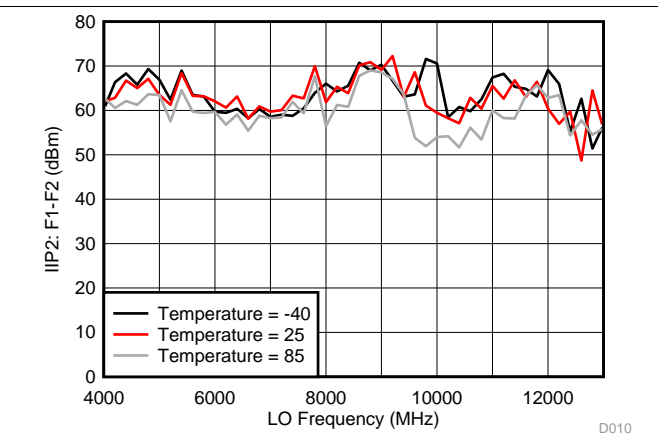
9. IIP3 Across IF Frequency for Internal LO Mode



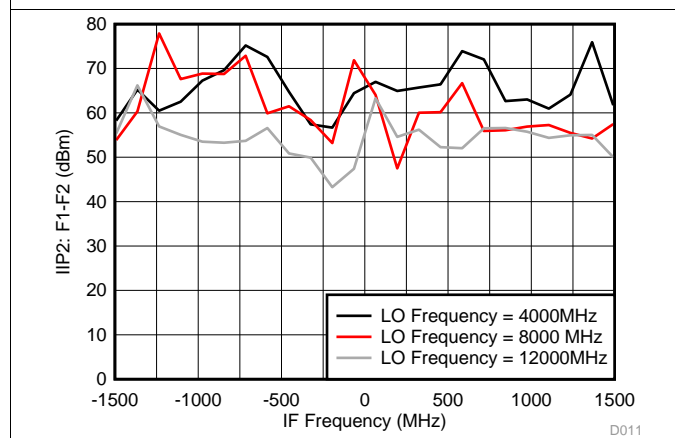
10. IIP3 Across IF Frequency for External LO Mode



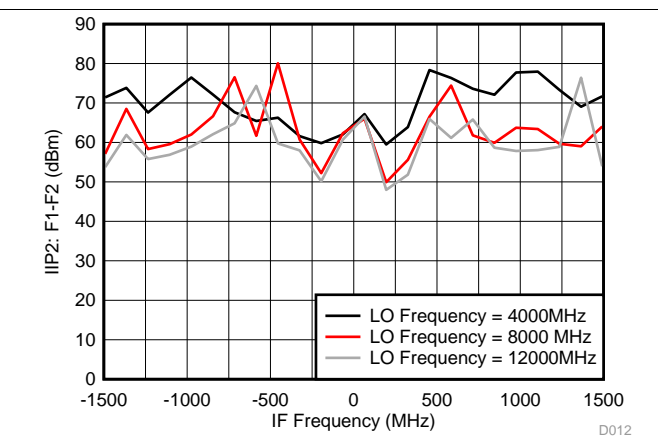
11. IIP2: F1-F2 Across LO Frequency for Internal LO Mode



12. IIP2: F1-F2 Across LO Frequency for External LO Mode

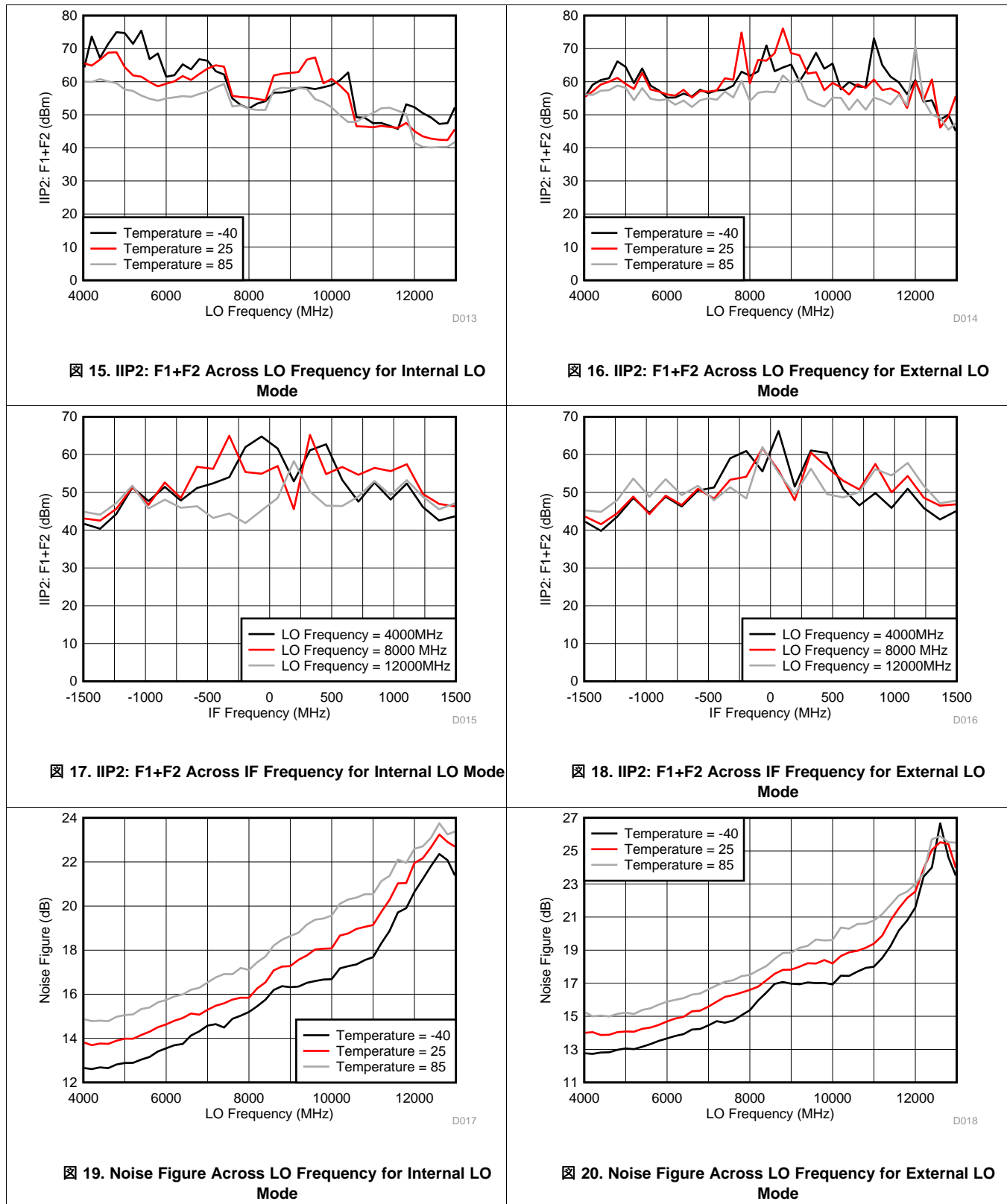


13. IIP2: F1-F2 Across IF Frequency for Internal LO Mode



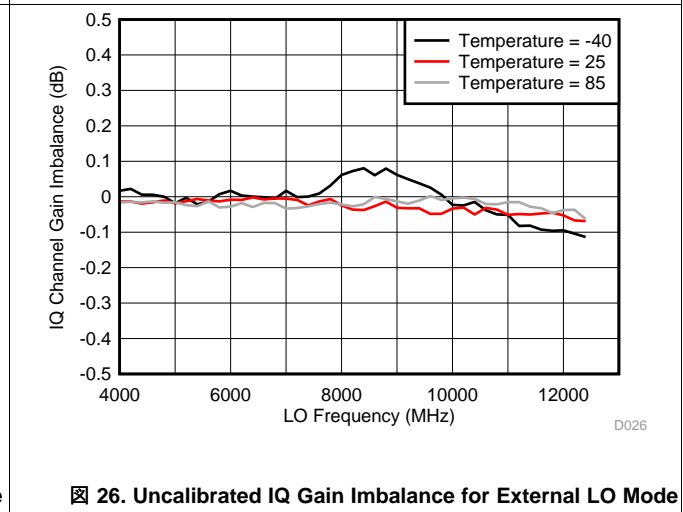
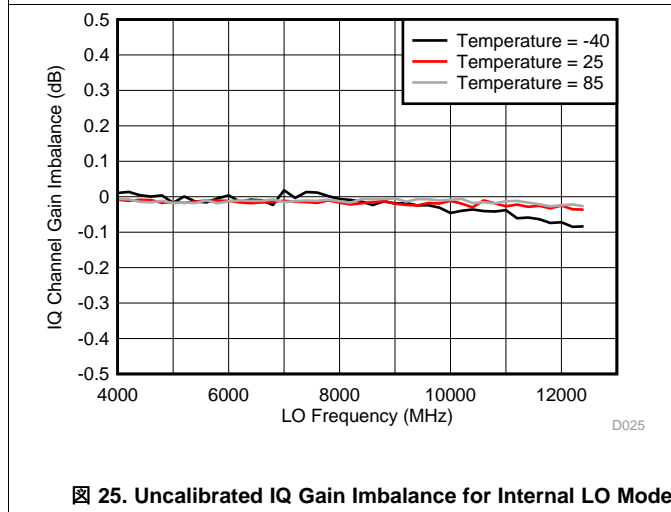
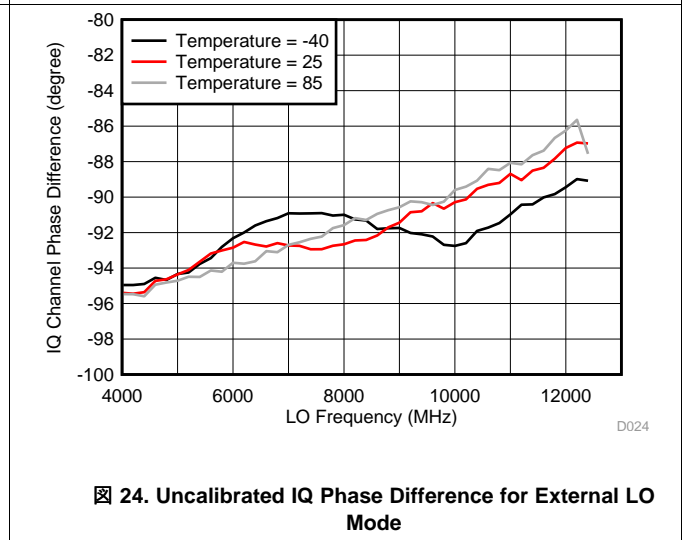
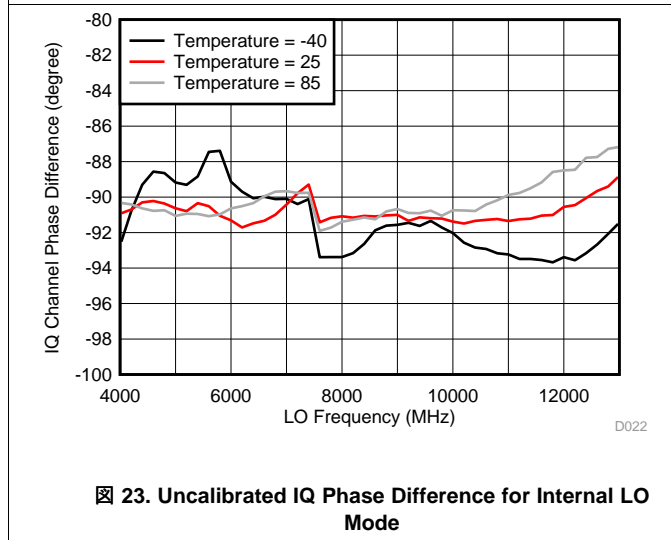
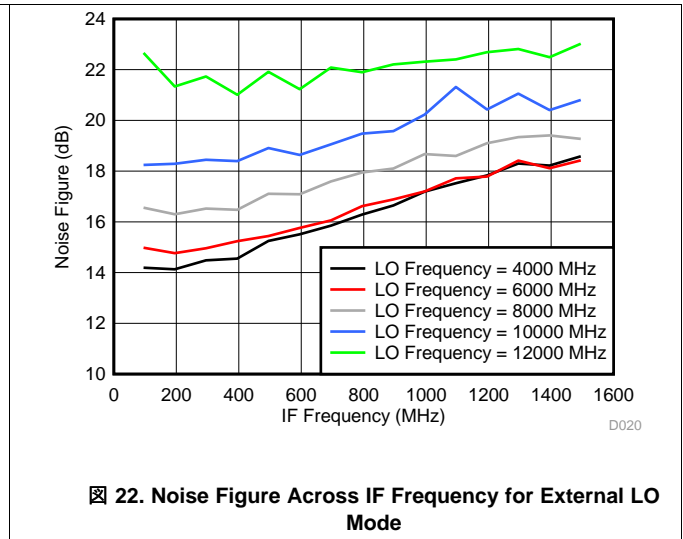
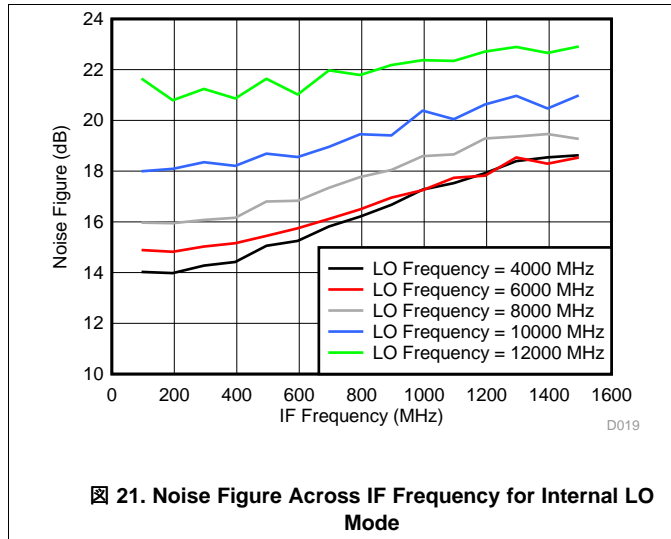
14. IIP2: F1-F2 Across IF Frequency for External LO Mode

Typical Characteristics (continued)

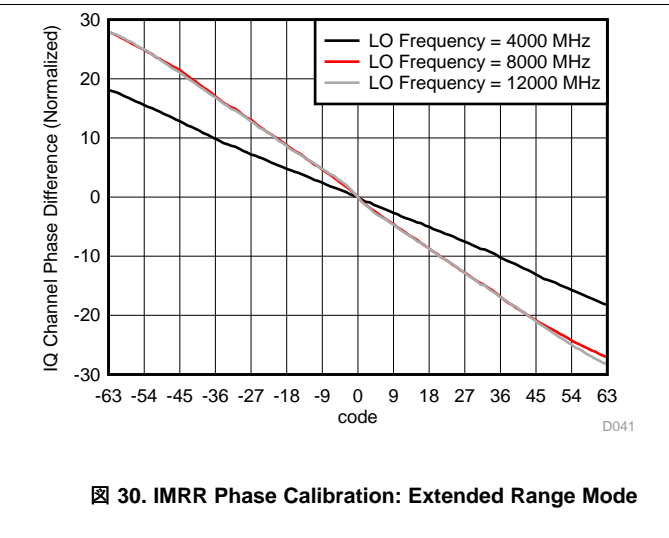
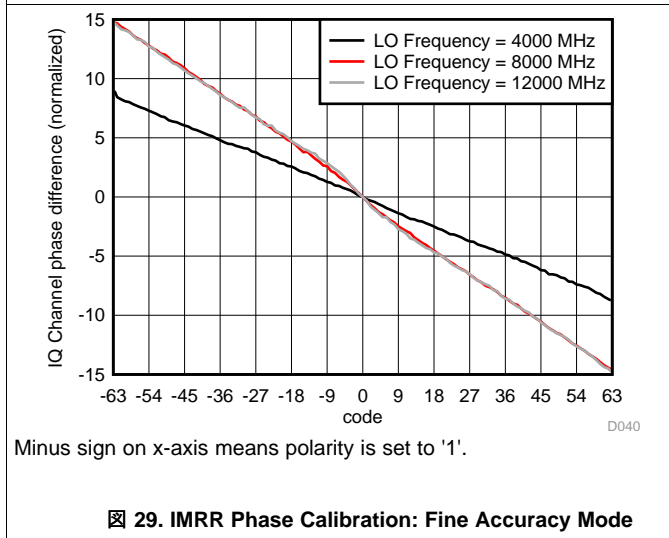
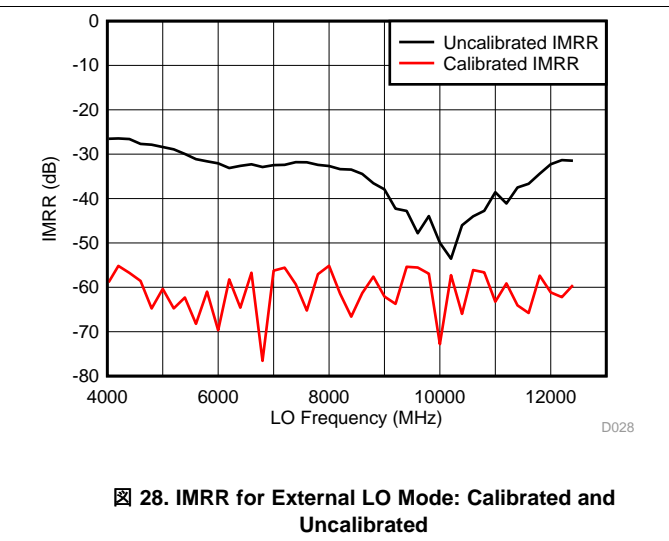
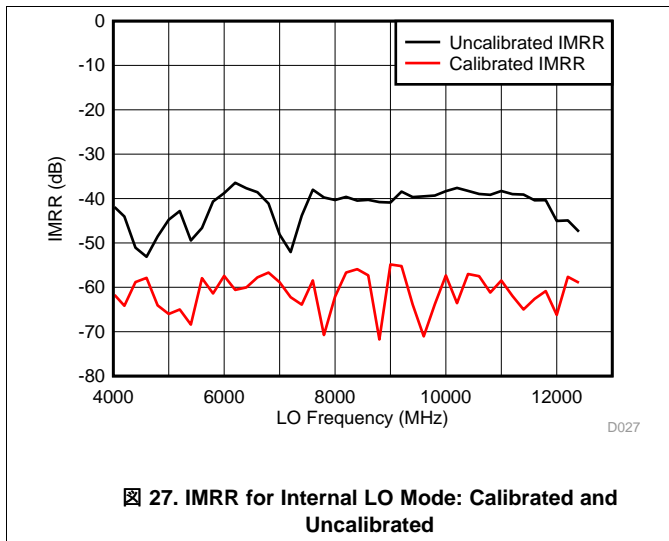




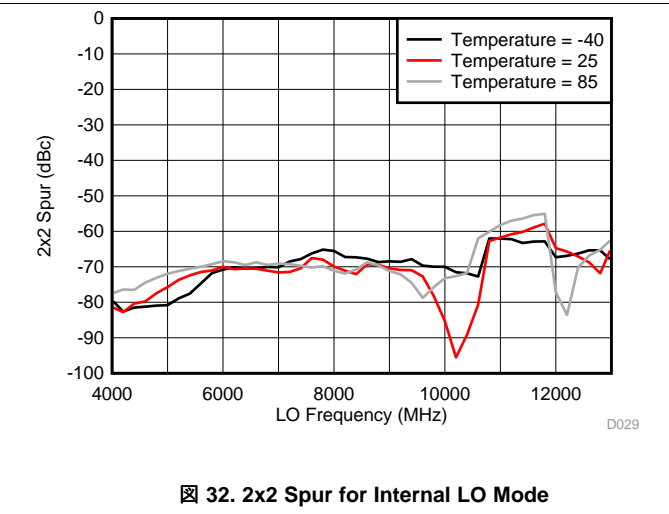
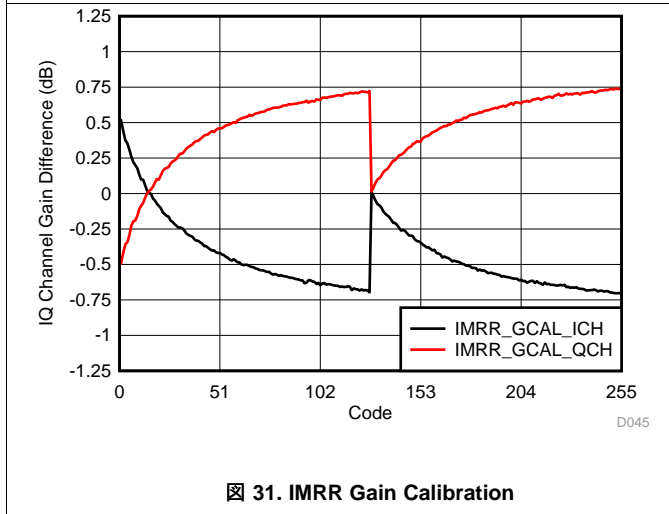
**Typical Characteristics (continued)**



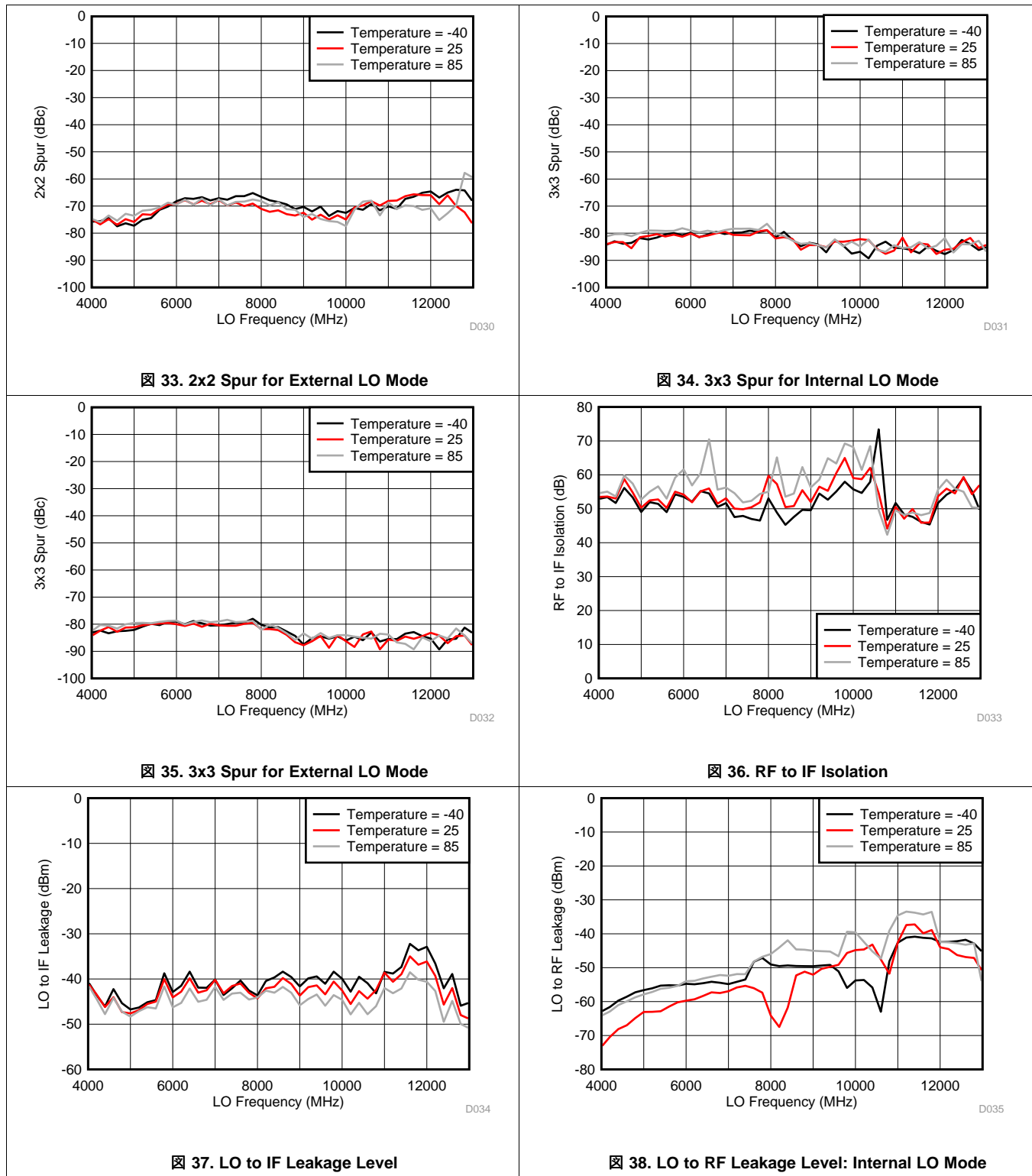
**Typical Characteristics (continued)**



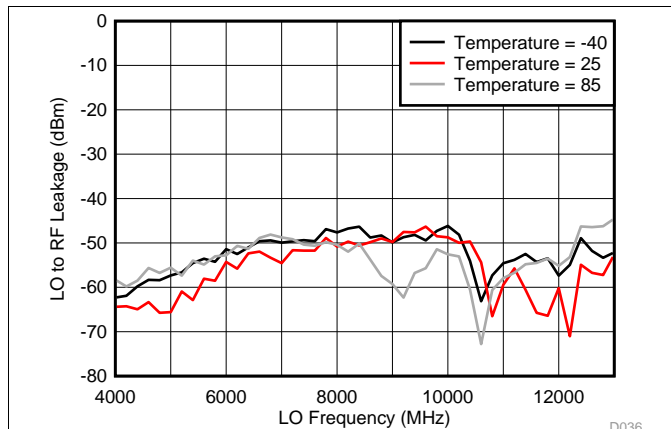
Minus sign on x-axis means polarity is set to '1'.



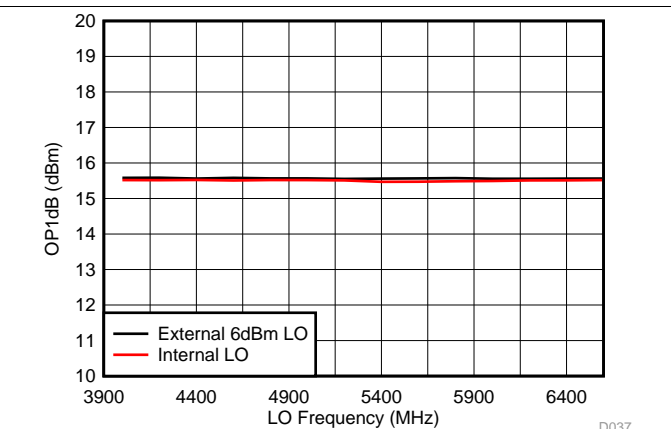
Typical Characteristics (continued)



**Typical Characteristics (continued)**

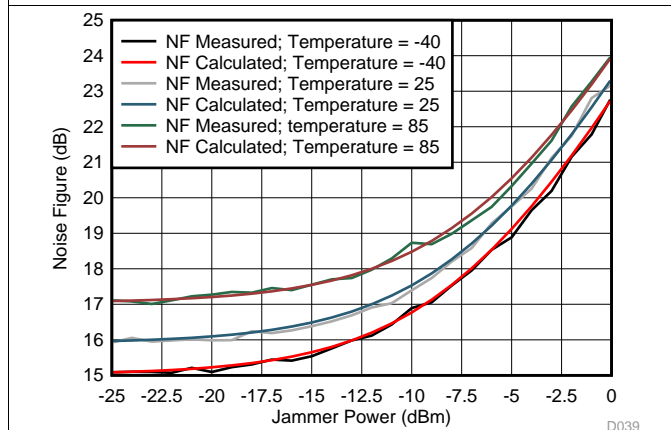


**39. LO to RF Leakage Level: External LO Mode**



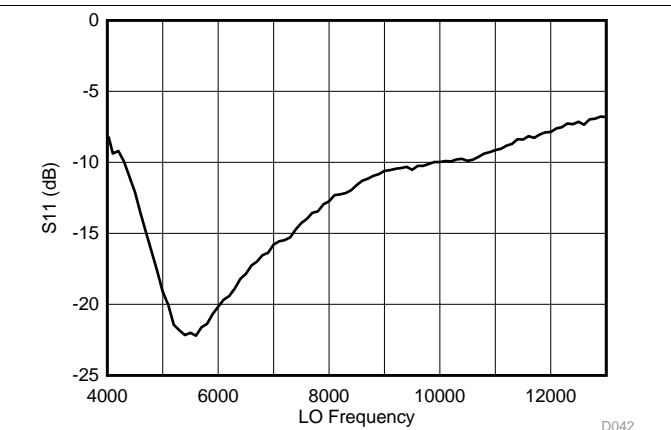
**40. OP1dB Across LO Frequency**

1. The LO frequency is capped at 6600MHz because IP1dB exceeds +10dBm when LO frequency goes beyond 6600MHz; The device can be damaged when input power is more than +10dBm.



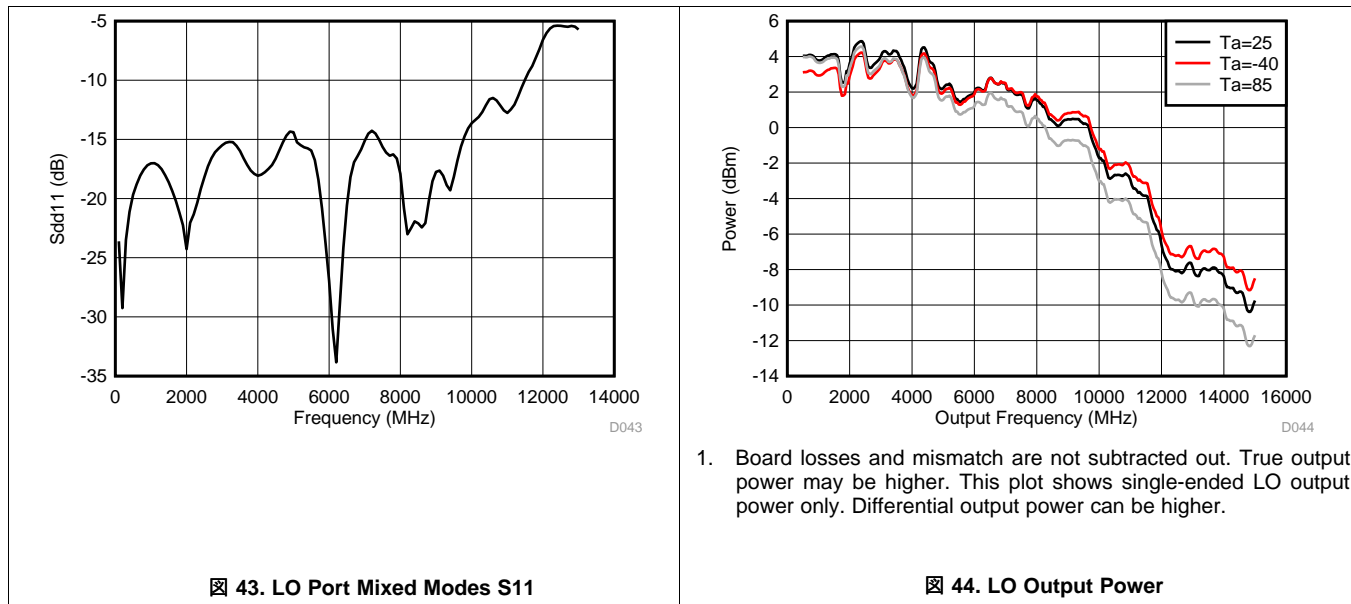
**41. Noise Figure with Jammer**

1. Jammer frequency = 8.8GHz, LO = 7.8GHz, IF = 100MHz.
2. Internal LO phase noise values used for calculation at -40, 25, and 85 degrees C are -155, -154.5 and -154 dBc/Hz, separately.



**42. RF Port S11**

**Typical Characteristics (continued)**



Measurements are done at 25 degree C unless temperature is specified in the plots.

For measurements across LO frequency, IF = 65MHz, and LO injection type is high side injection. For measurements across IF frequency, high side injection is applied

For all measurements that require RF input, RF input power = -10 dBm unless otherwise specified.

For two-tone measurements, the separation between two tones is 17MHz.

For all measurements, internal 1.7V VCM is applied.

For all external LO mode measurements, LO power = +6 dBm.

IF baluns used for measurements are: ADT2-18+ from Mini-Circuits™.

LO balun used for measurements is: BIB-100G from PPM-Test™.

RF combiner used for measurements of IP2, IP3 and NF with jammer is: 4426-2 from Narda-MITEQ™.

All path losses are calibrated out.

# LMX8410L

JAJSF07A – MARCH 2018 – REVISED NOVEMBER 2018

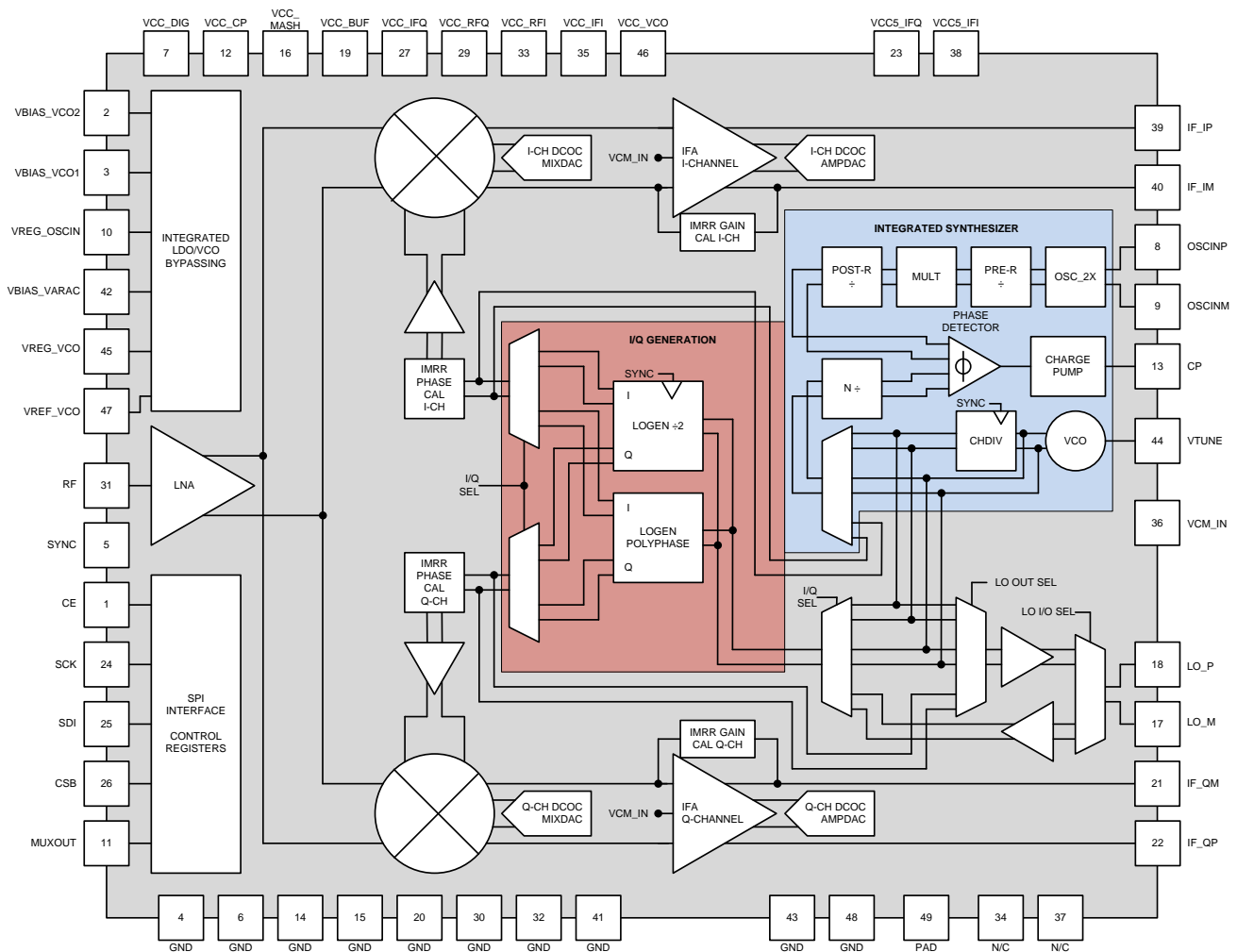
www.tij.co.jp

## 7 Detailed Description

### 7.1 Overview

The LMX8410L is a high-performance I/Q demodulator with an RF input range of 4 to 10 GHz and an IF output range of DC to 1350 MHz. This device integrates many components to allow high system performance as well as simplified design. There is an integrated synthesizer that generates wide-band frequencies at very low phase noise, with signal carefully conditioned for driving the mixer LO port. The RF input is single ended, enabled by an integrated wide-band RF balun at the front end. The two mixers on each I/Q channel are highly linear with optimized filtering and interfacing with components on each port. The IF amplifier is a high gain and high linearity component, saving users from matching discrete amplifiers and being restricted by common mode voltages typically encountered when interfacing mixers and ADC's. In addition to high linearity and low noise performance, the LMX8410L comes equipped with many features to further optimize certain parameters. The automatic DC offset calibration is run by an internal automatic algorithm which will sense and tune the DC offset between the N and P sides of the differential signal of each IF amplifier, thus ensuring optimal performance when directly DC coupled to the ADC. The I/Q calibration knob allows tuning blocks within the mixer and IF amplifier to balance both the gain and the phase of the I/Q output signals, thus giving the user capability to adjust and achieve high image rejection. The internal synthesizer also has a feature of synchronization, which allows multiple LMX8410L designed in parallel to have synchronized LO signal phase.

### 7.2 Functional Block Diagram



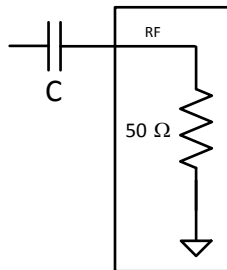
## 7.3 Feature Description

### 7.3.1 Device Configurations and Feature Description

#### 7.3.1.1 RF, LO and IF Interfaces

##### 7.3.1.1.1 RF Interface

LMX8410 RF input stage provides a wideband input matching in complete RF frequency range. The RF interface requires an external DC block capacitor.



✎ 45. RF Interface

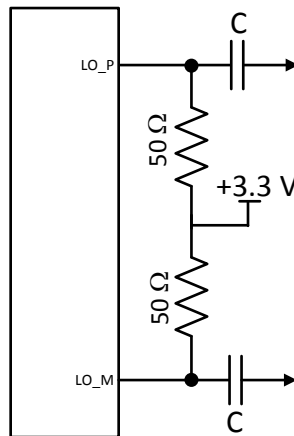
##### 7.3.1.1.2 LO Interface

LO interface for LMX8410 serves dual functionality:

1. Drive the VCO or channel divider output to pin LO\_M and LO\_P.
2. Inject external LO signal in external LO mode where on-chip synthesizer needs to be bypassed.

##### 7.3.1.1.2.1 LO Interface as Output Port

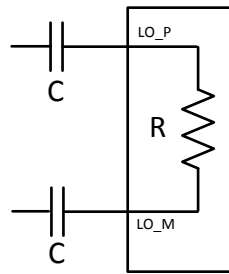
When LO interface operates as output port, it drives either VCO or Channel Divider output to the port. The device provides open collector output. Therefore, a pair of off-chip load resistors or inductors are needed in order to have LO output power.



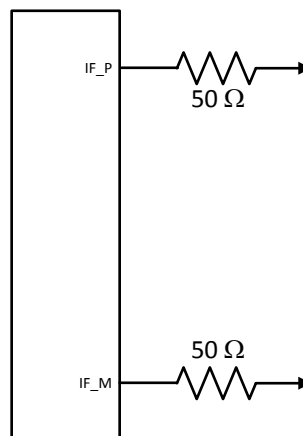
✎ 46. LO Port Operating In Output Mode Requires Load Resistors Or Inductors

##### 7.3.1.1.2.2 LO Interface as Input Port

When LO interface operates as input port, the pull-up resistors or inductors must be removed. Device pins must be AC coupled with DC block. LO pins offer wideband differential 100 Ohm termination to enable port matching. The value of termination can be set to 100Ohm, 200Ohm or high impedance through register EXTLO\_INT\_MATCH\_RES (R123<1:0>). It is recommended to keep the termination setting to 100 ohm during external LO injection and to high impedance mode while LO is brought out from the device.

**Feature Description (continued)**

**☒ 47. LO Port Operating In Input Mode**
**7.3.1.1.3 Baseband Interface**

LMX8410 has a low impedance output driver capable of driving the resistive as well as capacitive loads. Therefore, a pair of 50 ohm off-chip resistors can be placed in both IF\_P and IF\_M paths to provide 100Ohm differential matching if IF port matching is required.


**☒ 48. IF Interface Requires External Resistors for 100Ohm Differential Matching**
**7.3.1.2 Device Configurations Overview**

Follow below steps to configure the device successfully.

**7.3.1.2.1 Initialize the Device**

After the device is powered on, follow below setups in sequence.

1. Set R127 = 0x0003
2. Set R6 = 0x0100
3. Set R127 = 0x0000
4. Load device configuration bits.

**7.3.1.2.2 Configure LO Modes**

Refer to [表 5](#) to set up correct LO modes. After LO mode is configured, In case of internal LO mode, lock the integrated synthesizer and jump to [Perform DCOC \(DC Offset Correction\)](#). In case of external LO mode, go to [Set Up External LO Clock](#).



## Feature Description (continued)

### 7.3.1.2.3 Set Up External LO Clock

Follow below steps to set up external LO clock:

1. Set external LO divider. Refer to [State Machine Clock](#)
2. Provide external LO signal on the pin.
3. Enable the divider by setting EXTLO\_CLK\_DIV\_EN (R81<7:6>) to 3. This step should be done only after valid external LO signal is driven on the pin.
4. Select SM clock source towards external LO driven SM clock by setting SM\_CLK\_SEL (R81<0>) = 1.
5. Wait for 100 usec before performing DCOC.

### 7.3.1.2.4 Perform DCOC (DC Offset Correction)

Perform DCOC for both I and Q channels. Refer to [DCOC \(DC Offset Correction\)](#) for detailed instructions.

### 7.3.1.2.5 Turn Off SM Clock

Turn off SM clock after DCOC to remove coupling spurs from clock signals.

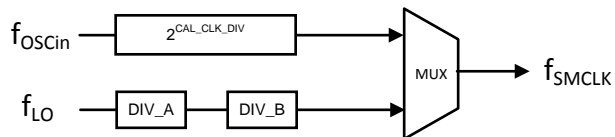
1. In internal LO mode, set SM\_CLK\_EN (R2<10>) to 0.
2. In external LO mode, set EXTLO\_CLK\_DIV\_EN (R81<7:6>) to 0.

### 7.3.1.2.6 Perform IMRR (Image Rejection Ratio) Calibration

Refer to [Image Rejection Calibration](#) for detailed instructions.

### 7.3.1.3 State Machine Clock

The State machine clock can be derived, through a MUX, from division of OSCin frequency in internal LO mode or from division of external LO frequency in external LO mode. The upper bound for State machine clock is 200MHz while lower bound is 1MHz/10MHZ in internal/external LO modes. In external LO mode, two sets of dividers need to be programmed to set the right SM clock frequency. DIV\_A is an 8-state divider which drives DIV\_B. Input frequency to DIV\_B must be kept less than 1.4GHz. Recommended SM\_CLK frequency is 100MHz.



49. Block Diagram of SM Clock

#### 7.3.1.3.1 Set Divider Values For Internal LO Mode

The value of divider in internal LO mode is  $2^{(value\ of\ CAL\_CLK\_DIV)}$ .

## Feature Description (continued)

### 7.3.1.3.2 Set Divider Values For External LO Mode

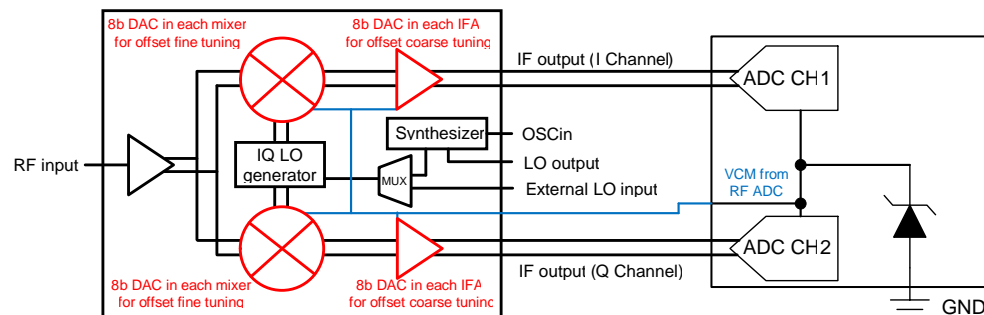
The divider for external LO mode is EXTLO\_DIV (R82<5:0>), where R82<5:3> sets DIV\_A and R82<2:0> sets DIV\_B. The value of DIV\_A should be set according to [表 1](#). The value of DIV\_B is  $2^{(\text{value of R82}<2:0>)}$ .

**表 1. DIV\_A Encoding**

EXTLO_DIV (R82<5:3>)	Division Value
000	/1
001	/2
010	/16
011	/4
100	/16
101	/16
110	/16
111	/8

### 7.3.1.4 DCOC (DC Offset Correction)

The DC offset of IF output can be automatically corrected by checking EN\_DCOC\_ICH\_LUT and EN\_DCOC\_QCH\_LUT



**图 50. DC Offset Correction Diagram**

#### 7.3.1.4.1 RF Input Power Restriction During DCOC

For best accuracy, power at the RF input of the LMX8410 should be kept below -50dBm during DCOC calibration. Additional isolation (~15dB) can be obtained by turning of LNA\_PD and LNA\_BIAS\_OFF.

#### 7.3.1.4.2 Set Up DCOC Clock Divider

DCOC state machine clock can operate from 0.5MHz to 2MHz, preferably set to 1MHz. Calculation of clock frequency: DCOC clock Frequency = (SM\_CLK frequency)/(2\*DCOC\_CLK\_DIV value). Refer to [State Machine Clock](#) for SM\_CLK setup. It is recommended to set and reset DCOC\_FSM\_RESET (R126<8>) every time the LO frequency is changed.

### 7.3.1.5 Image Rejection Calibration

LMX8410 provides registers to vary the gain and phase of the I and Q channel individually to improve image rejection.

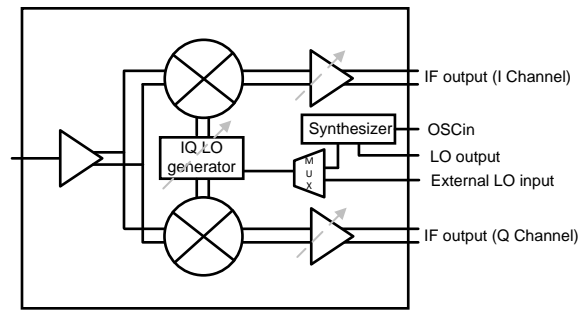


图 51. Image Reject Calibration Example

### 7.3.1.5.1 Phase Calibration

Phase magnitude can be tuned using IMRR\_PHCAL (R95<14:9>), polarity of phase calibration can be set by IMRR\_PHCAL\_POL (R95<15>). If Q channel leads I by > 90 deg. Set polarity to '0', otherwise set it to '1'. Typical step size of magnitude tuning is 0.2 deg for fine accuracy mode and 0.45 deg for extended range mode. The fine accuracy mode and extended range mode can be set by IMRR\_PHCAL\_EXTEND (R126<15>). Refer to 图 29 and 图 30 for details of the two modes.

### 7.3.1.5.2 Gain Calibration

The voltage magnitude of I and Q channel can be tuned by IMRR\_GCAL\_ICH (R94<7:0>) and IMRR\_GCAL\_QCH (R94<15:8>). The recommended code range is 128 to 255. In this code range, gain tuning range is 0.5dB. Extended code range is 0 to 127. In this range, step size is higher and gain tuning range is 1dB. Refer to 图 31 for details of the two code ranges. Re-calibration may be needed with temperature drift.

### 7.3.1.6 IF Amplifier Common Mode Configurations

IF amplifier common mode voltage can be set by VCM\_CONFIG (R83<12:9>). Additional setups are needed depending on VCM magnitude. Refer to 表 2 for more details. For best common mode voltage accuracy, supply external VCM and choose "External" in VCM\_CONFIG.

表 2. IF Amplifier Common Mode Configurations

IFA common mode(V)	IFA_PULLUP_EN (R79<6>)	IFA_PULLUP (R83<15:13>)	IFA_CONFIG (R88<1:0>)
1.2	1	7	0
1.3	1	3	0
1.4	1	1	0
1.5	0	0	0
>= 1.6	0	0	3

### 7.3.1.7 Synchronization Mode (Internal LO Mode Only)

#### 7.3.1.7.1 Synchronization of the LO\_OUT Output to the Fosc Input

The LO\_OUT pin can be synchronized to the Fosc input in exactly the same way that the LMX2594 can. For cases where the output frequency is not a multiple of the input frequency, the SYNC pin can be used.

#### 7.3.1.7.2 Synchronization of I/Q Outputs to Fosc Inputs Using Internal LO

When the internal LO is used, IF outputs of two devices can be synchronized to the Fosc input if and only if the VCO frequency is a multiple of the Fosc frequency and there is no multiplication in the input path (OSC\_2X = 0 and MULT=1). The device is inherently in SYNC all the time in this condition so therefore there is no need to use the SYNC pin or to toggle the SYNC\_PHASE\_PLL bit.

## 7.4 Device Functional Modes

The LMX8410L can be programmed for two functional modes: internal LO mode (using the integrated synthesizer) or external LO mode (bypassing the integrated synthesizer). In internal LO mode, when 4GHz <= LO frequency <= 7.5 GHz, use divide-by-2 (Div 2) mode; when 7.5 GHz <= LO frequency <= 10 GHz, use polyphase filter mode (Poly). Refer to [表 3](#) to set up registers correctly. Under special circumstances where integrated synthesizer fails to lock at 7.5 ~ 7.7GHz, refer to [VCO Range Uncertainty for 7.5 to 7.7 GHz](#) for more instructions.

**表 3. Internal LO Mode and External LO Mode Register Configurations**

FIELD NAME	ADDRESS	INTERNAL LO/DIV2	INTERNAL LO/Poly	EXTERNAL LO
PLL_PD	R0[0]	0	0	1
LO_OUT_PD	R44[7]	1	1	1
SIGCHAIN_PD	R79[0]	0	0	0
LO_PATH_EN	R79[14:12]	0	7	7
LO_MUX	R80[5:0]	9	10	34
SM_CLK_SEL	R81[0]	0	0	1
EXTLO_CLK_DRV_EN	R81[2:1]	0	0	3
LO_DRVR_MODE	R81[5:4]	1	0	3
EXTLO_CLK_DIV_EN	R81[7:6]	0	0	3
LO_POLY_MODE1	R81[11:8]	3	0	15
LO_POLY_MODE2	R103[13:10]	11	0	0
EXTLO_INT_MATCH_RES	R123[1:0]	0	0	3

### 7.4.1 Internal LO Mode

When using internal LO mode, the integrated synthesizer is activated to generate the desired LO frequency. The OSCINP and OSCINM pins are used to provide a reference frequency to the PLL and are required to generate the internal state machine clock. The CP pin generates the phase detector output for use with an external loop filter. The filtered phase detector output is fed into the VTUNE pin to control the internal VCO, generating frequencies between 7.5 GHz and 15 GHz. The VCO output is divided down to close the loop into the phase detector. The VCO output may be fed directly into the I/Q generation circuitry.

The I/Q generation circuitry has two paths: a divide-by-2 path, and a polyphase filter path. Depending on the frequency of the LO, the I/Q generation circuitry used will differ. The divide-by-2 path requires the VCO frequency to be double that of the LO frequency. When the LO frequency is between 4 GHz and 7.5 GHz, the VCO can be programmed to between 8 GHz and 15 GHz, and the VCO output can be fed into the divide-by-2 path. When the LO frequency is greater than 7.5 GHz, the VCO can be programmed to between 7.5 GHz and 15 GHz, and the VCO output can be fed into the polyphase filter path.

In Internal LO mode, the LO pins may be used as outputs (refer to [LO Interface as Output Port](#)) for three separate signals internal to the device:

1. The VCO output may be fed directly to the LO pins.
2. The VCO may be divided by any possible combination using the channel divider, and the divided output may be fed to the LO pins. Refer to the datasheet of LMX2594 for more details.

### 7.4.1.1 VCO Range Uncertainty for 7.5 to 7.7 GHz

Although the majority of devices have a VCO range of 7.5 to 15 GHz, this is NOT ensured. In reality, the VCO is tested for sure to cover 7.7 to 15 GHz. In the range of 7.5 to 7.7 GHz and 15 to 15.4 GHz, the VCO will cover at least enough frequency to cover a factor of two in frequency. What this means if using the internal mixer is that if one wants a LO frequency of 7.6 GHz, then first try this using the poly mode and VCO frequency of 7.6 GHz. However, if the VCO can not do 7.6 GHz, then one has to try DIV2 Mode with the VCO at 15.2 GHz.

**表 4. VCO Ensured Frequency**

Parameter	Symbol	Ensured Condition
Minimum VCO Frequency	$f_{VCO\text{Min}}$	$f_{VCO\text{Min}} \leq 7.7 \text{ GHz}$
Maximum VCO Frequency	$f_{VCO\text{Max}}$	$f_{VCO\text{Max}} \geq \text{Max}\{ 15 \text{ GHz}, 2 \times f_{VCO\text{Min}} \}$

### 7.4.2 External LO Mode

When using External LO mode, the integrated synthesizer may be powered down and bypassed. The internal state machine clock is derived by dividing down the LO input. Since the frequency range of the LO circuit is bounded below the operational frequency of the divide-by-2 path, I/Q generation must be done using the polyphase filter path.

In External LO mode, some pins must be configured differently than in Internal LO mode. Even when the synthesizer circuitry is bypassed, VCC should be applied to all power pins (though bypass capacitors are no longer required). 表 5 contains a summary of the External LO requirements.

**表 5. External LO Pin Configuration**

PIN NO.	NAME	I/O	EXTERNAL LO REQUIREMENTS
2	VBIAS_VCO2	Bypass	Floating (no connection) or same configuration with internal LO mode
3	VBIAS_VCO1	Bypass	Floating (no connection) or same configuration with internal LO mode
5	SYNC	Input	Grounded
8	OSCINP	input	Grounded
9	OSCINM	input	Grounded
10	VREG_OSCIN	Bypass	Floating (no connection) or same configuration with internal LO mode
13	CP	Output	Floating (no connection) or same configuration with internal LO mode
17	LO_M	Input	Matching network recommended. No pull-up resistors / inductors. <sup>(1)</sup>
18	LO_P	Input	Matching network recommended. No pull-up resistors / inductors. <sup>(1)</sup>
42	VBIAS_VARAC	Bypass	Floating (no connection) or same configuration with internal LO mode
44	VTUNE	Input	Grounded
47	VREF_VCO	Bypass	Floating (no connection) or same configuration with internal LO mode

(1) Refer to [LO Interface as Input Port](#) for LO interfacing.

## 7.5 Programming

### 7.5.1 General Comments Regarding Programming

This device is programmed using 24-bit shift registers. The shift register consists of a R/W bit (MSB), followed by a 7-bit address field and a 16-bit data field. For the R/W bit, 0 is for write, and 1 is for read. The address field ADDRESS[6:0] is used to decode the internal register address. The remaining 16 bits form the data field DATA[15:0]. While CSB is low, serial data is clocked into the shift register upon the rising edge of clock (data is programmed MSB first). When CSB goes

## Programming (continued)

### 7.5.2 Recommended Initial Power Up Sequence

For the most reliable programming, TI recommends this procedure: 1. 2. Program RESET = 1 to reset registers. 3. Program RESET = 0 to remove reset. 4. Program registers as shown in the register map in REVERSE order from highest to lowest. 5. Program register R0 one additional time with FCAL\_EN = 1 to ensure that the VCO calibration runs from a stable state.

1. Apply power to device.
2. Program Register R127 to value 0x7F0003
3. Program Register R6 to value 0x060100
4. Program registers R127 to R0 in REVERSE Order
5. If using internal LO, wait 10 ms and then Program register R0 again

### 7.5.3 Recommended and Power on Reset Bit Values

There are a few points of clarification for power on reset values and recommended values.

1. Whenever power is cycled on the chip, the registers are reset to their power on reset (not necessarily recommended) state.
2. In the main register map, there are several registers with only 1's and 0's and no defined words. DO NOT ASSUME that these registers do not need to be programmed. In many cases, these 1's and 0's are different than the power on reset values.
3. In the register description, the word 'RESET' is used, but what is really meant is "Recommended" State

## 7.6 Register Map

This device has 128 registers from R0 to R127. They must be programmed in REVERSE order. Note that there are several registers that have no description, but they still need to be programmed as the power on reset value is not always the correct value. The complete listing for all registers, including those not described in this datasheet are available on the Registers tab on the TI TICSPRO software.

表 6. Full Register Map

	D15	D14	D13	D12	D11	D10	D9	D8	D7	D6	D5	D4	D3	D2	D1	D0
R0	0	SYNC_P HASE_P LL	1	0	0	0	OUT_MU TE	FCAL_HPFD_ADJ 0			0	1	FCAL_E N	MUXOU T_SEL	RESET_ PLL	PLL_PD
R1	0	0	0	0	1	0	0	0	0	0	0	0	1	CAL_CLK_DIV		
R2	0	0	0	0	0	1	0	1	0	0	0	0	0	0	0	0
R3	0	0	0	0	0	1	1	0	0	1	0	0	0	0	1	0
R4	0	0	0	1	1	0	0	1	0	1	0	0	0	0	1	1
R5	0	0	0	0	0	0	0	0	1	1	0	0	1	0	0	0
R6	1	1	0	0	1	0	0	0	0	0	0	0	0	0	1	0
R7	0	0	0	0	0	0	0	0	1	0	1	1	0	0	1	0
R8	0	0	1	0	0	0	0	0	0	0	0	0	0	0	0	0
R9	0	0	0	OSC_2X	0	1	1	0	0	0	0	0	0	1	0	0
R10	0	0	0	1	MULT					1	0	1	1	0	0	0
R11	0	0	0	0	PLL_R							1	0	0	0	
R12	0	1	0	1	0	0	0	0	0	0	0	0	0	0	0	1
R13	0	1	0	0	0	0	0	0	0	0	0	0	0	0	0	0
R14	0	0	0	1	0	0	1	1	1	CPG			0	0	0	0
R15	0	0	0	0	0	1	1	0	0	1	0	0	1	1	1	1
R16	0	0	0	0	0	0	0	0	1	0	0	0	0	0	0	0
R17	0	0	0	0	0	0	0	0	1	1	1	1	1	0	1	0
R18	0	0	0	0	0	0	0	0	0	1	1	0	0	1	0	0
R19	0	0	1	0	0	1	1	1	1	0	1	1	0	1	1	1
R20	1	1	1	1	1	0	0	0	0	1	0	0	1	0	0	0
R21	0	0	0	0	0	1	0	0	0	0	0	0	0	0	0	1
R22	0	0	0	0	0	0	0	0	0	0	0	0	0	0	0	1
R23	0	0	0	0	0	0	0	0	0	1	1	1	1	1	0	0
R24	0	0	0	0	0	1	1	1	0	0	0	1	1	0	1	0
R25	0	0	0	0	0	1	1	0	0	0	1	0	0	1	0	0
R26	0	0	0	0	1	1	0	1	1	0	1	1	0	0	0	0
R27	0	0	0	0	0	0	0	0	0	0	0	0	0	0	1	0
R28	0	0	0	0	0	1	0	0	1	0	0	0	1	0	0	0
R29	0	0	1	1	0	0	0	1	1	0	0	0	1	1	0	0
R30	0	0	1	1	0	0	0	1	1	0	0	0	1	1	0	0
R31	0	1	0	0	0	0	1	1	1	1	1	0	1	1	0	0

**表 6. Full Register Map (continued)**

	D15	D14	D13	D12	D11	D10	D9	D8	D7	D6	D5	D4	D3	D2	D1	D0	
R32	0	0	0	0	0	0	1	1	1	0	0	1	0	0	1	1	
R33	0	0	0	1	1	1	1	0	0	0	1	0	0	0	0	1	
R34	0	0	0	0	0	0	0	0	0	0	0	0	0	0	0	0	
R35	0	0	0	0	0	0	0	0	0	0	0	0	0	1	0	0	
R36	PLL_N																
R37	1	0	PFD_DLY_SEL						0	0	0	0	0	0	1	0	0
R38	PLL_DEN[31:16]																
R39	PLL_DEN[15:0]																
R40	MASH_SEED[31:16]																
R41	MASH_SEED[15:0]																
R42	PLL_NUM[31:16]																
R43	PLL_NUM[15:0]																
R44	0	0	0	1	1	1	1	1	LO_OUT_PD	0	MASH_RESET_N	0	0	MASH_ORDER			
R45	1	1	0	0	1	1	1	0	1	1	0	1	1	1	1	1	
R46	0	0	0	0	0	1	1	1	1	1	1	1	1	1	LO_OUT_MUX		
R47	0	0	0	0	0	0	1	1	0	0	0	0	0	0	0	0	
R48	0	0	0	0	0	0	1	1	0	0	0	0	0	0	0	0	
R49	0	1	0	0	0	0	0	1	1	0	0	0	0	0	0	0	
R50	0	0	0	0	0	0	0	0	0	0	0	0	0	0	0	0	
R51	0	0	0	0	0	0	0	0	1	0	0	0	0	0	0	0	
R52	0	0	0	0	1	0	0	0	0	0	1	0	0	0	0	0	
R53	0	0	0	0	0	0	0	0	0	0	0	0	0	0	0	0	
R54	0	0	0	0	0	0	0	0	0	0	0	0	0	0	0	0	
R55	0	0	0	0	0	0	0	0	0	0	0	0	0	0	0	0	
R56	0	0	0	0	0	0	0	0	0	0	0	0	0	0	0	0	
R57	0	0	0	0	0	0	0	0	0	0	0	0	0	0	0	0	
R58	SYNC_PIGNORE	0	0	0	0	0	0	0	0	0	0	0	0	0	0	1	
R59	0	0	0	0	0	0	0	0	0	0	0	0	0	0	0	LD_TYPE	
R60	0	0	0	0	0	0	1	1	1	1	1	0	1	0	0	0	
R61	0	0	0	0	0	0	0	0	1	0	1	0	1	0	0	0	
R62	0	0	0	0	0	0	0	0	0	0	1	0	0	0	1	0	



**表 6. Full Register Map (continued)**

	D15	D14	D13	D12	D11	D10	D9	D8	D7	D6	D5	D4	D3	D2	D1	D0	
R63	0	0	0	0	0	0	0	0	0	0	0	0	0	0	0	0	
R64	0	0	0	1	0	0	1	1	1	0	0	0	1	0	0	0	
R65	0	0	0	0	0	0	0	0	0	0	0	0	0	0	0	0	
R66	0	0	0	0	0	0	0	1	1	1	1	1	0	1	0	0	
R67	0	0	0	0	0	0	0	0	0	0	0	0	0	0	0	0	
R68	0	0	0	0	0	0	1	1	1	1	1	0	1	0	0	0	
R69	MASH_RST_COUNT[31:16]																
R70	MASH_RST_COUNT[15:0]																
R71	0	0	0	0	0	0	0	0	1	0	0	0	0	0	0	1	
R72	0	0	0	0	0	0	0	0	0	0	0	0	0	0	0	1	
R73	0	0	0	0	0	0	0	0	0	0	1	1	1	1	1	1	
R74	0	0	0	0	0	0	0	0	0	0	0	0	0	0	0	0	
R75	0	0	0	0	1	CHDIV					0	0	0	0	0	0	
R76	0	0	0	0	0	0	0	0	0	0	0	0	1	1	0	0	
R77	0	0	0	0	0	0	0	0	0	0	0	0	0	0	0	0	
R78	0	0	0	0	0	0	VCO_CALSTART_CLOSE	0	0	1	1	0	0	1	0	0	
R79	0	LO_PATH_EN			0	0	0	0	0	0	IFA_PULLUP_EN	0	0	0	LNA_PD	SIGPATH_RST	SIGCHAIN_PD
R80	0	0	0	0	SYNC_PHASE_MXLO	SYNC_DRV2_EN	SYNC_DRV1_EN	0	0	0	LO_MUX						
R81	0	0	0	0	LO_POLY_MODE1				EXTLO_CLK_DIV_EN		LO_DVR_MODE		0	EXTLO_CLK_DRV_EN		SM_CLK_SEL	
R82	0	0	0	0	1	0	1	0	0	0	EXTLO_DIV						
R83	IFA_PULLUP			VCM_CONFIG				0	0	0	1	0	0	0	0	0	1
R84	DCOC_CLK_DIV										0	0	0	0	EN_DCO_C_QCH_LUT	EN_DCO_C_ICH_LUT	
R85	0	0	0	0	0	0	0	0	0	0	0	0	0	0	0	0	
R86	0	0	0	0	0	0	0	0	0	0	0	0	0	0	0	0	
R87	0	0	0	0	0	0	0	0	0	0	0	0	0	0	0	0	
R88	rb_DCOC_CAL		0	0	0	0	0	0	0	0	0	0	0	0	1	1	
R89	0	0	0	0	0	0	0	0	0	0	0	0	0	0	0	0	
R90	0	0	0	0	0	0	0	0	0	0	0	0	0	0	0	0	

**表 6. Full Register Map (continued)**

	D15	D14	D13	D12	D11	D10	D9	D8	D7	D6	D5	D4	D3	D2	D1	D0	
R91	0	0	0	0	0	0	0	0	0	0	0	0	0	0	0	0	
R92	0	0	0	0	0	0	0	0	0	0	0	0	0	0	0	0	
R93	0	0	0	0	0	0	0	0	0	0	0	0	0	0	0	0	
R94	IMRR_GCAL_QCH							IMRR_GCAL_ICH									
R95	IMRR_P HCAL_P OL	IMRR_PHCAL						0	0	0	0	0	0	0	0	0	0
R96	1	0	0	1	0	0	1	0	0	0	0	1	1	0	0	0	
R97	0	0	0	0	0	0	0	0	0	0	0	0	0	0	0	0	
R98	0	0	0	0	0	0	0	0	0	0	0	0	0	0	0	0	
R99	0	0	0	0	0	0	0	0	0	0	0	0	0	0	0	0	
R100	0	0	0	0	0	0	0	0	0	0	0	0	0	0	1	0	
R101	0	0	0	0	0	0	0	0	0	0	0	0	0	0	1	0	
R102	0	0	0	0	0	0	0	0	0	0	0	0	0	0	0	0	
R103	0	0	LO_POLY_MODE2				0	0	0	0	0	0	0	0	0	0	0
R104	0	1	0	0	0	0	0	0	0	0	0	1	0	0	0	0	
R105	0	0	0	0	0	0	0	0	0	0	0	1	1	1	0	0	
R106	0	0	0	0	0	0	0	0	0	0	0	0	0	0	0	0	
R107	0	0	0	0	0	0	0	0	0	0	0	0	0	0	0	0	
R108	0	0	0	0	0	0	0	0	0	0	0	0	0	0	0	0	
R109	0	0	0	0	0	0	0	0	0	0	0	0	0	0	0	0	
R110	0	0	0	0	0	rb_LD_VTUNE		0	rb_VCO_SEL			0	0	0	0	0	
R111	0	0	0	0	0	0	0	0	rb_VCO_CAPCTRL								
R112	0	0	0	0	0	0	0	rb_VCO_DACISSET									
R113	0	0	0	0	0	0	0	0	0	0	0	0	0	0	0	0	
R114	0	0	0	0	0	0	0	0	0	0	0	0	0	0	0	0	
R115	0	0	0	0	0	1	1	1	0	0	0	0	0	0	0	0	
R116	0	0	0	0	0	0	0	0	0	0	0	0	0	0	0	0	
R117	0	0	0	0	0	0	0	0	1	1	0	0	0	0	0	0	
R118	0	0	0	0	0	0	0	0	0	0	0	0	0	0	0	0	
R119	0	0	0	0	0	0	0	0	0	0	0	0	1	0	1	0	
R120	0	0	0	0	0	0	0	0	0	0	0	0	0	0	0	0	
R121	0	0	0	0	0	0	0	0	0	BIAS_LNA_CUR_C ONFIG		0	0	0	0	0	
R122	0	0	0	0	0	0	0	0	0	0	0	0	0	0	0	0	

**表 6. Full Register Map (continued)**

	D15	D14	D13	D12	D11	D10	D9	D8	D7	D6	D5	D4	D3	D2	D1	D0
R123	0	0	0	0	0	0	0	0	0	0	0	0	0	0	EXTLO_INT_MATC H_RES	
R124	0	0	0	0	0	0	0	0	0	0	0	0	0	0	0	0
R125	0	0	0	0	0	0	0	0	0	0	0	0	0	0	0	0
R126	IMRR_P HCAL_E XTEND	0	0	0	0	0	0	0	0	0	0	0	0	0	0	0
R127	0	0	0	0	0	0	0	0	0	0	0	0	0	0	0	0

Table 7 lists the memory-mapped registers for the Device registers. All register offset addresses not listed in Table 7 should be considered as reserved locations and the register contents should not be modified.

**Table 7. Device Registers**

Address	Acronym	Register Name	Section
0x0	R0		<a href="#">Go</a>
0x1	R1		<a href="#">Go</a>
0x2	R2		<a href="#">Go</a>
0x9	R9		<a href="#">Go</a>
0xA	R10		<a href="#">Go</a>
0xB	R11		<a href="#">Go</a>
0xE	R14		<a href="#">Go</a>
0x24	R36		<a href="#">Go</a>
0x25	R37		<a href="#">Go</a>
0x26	R38		<a href="#">Go</a>
0x27	R39		<a href="#">Go</a>
0x28	R40		<a href="#">Go</a>
0x29	R41		<a href="#">Go</a>
0x2A	R42		<a href="#">Go</a>
0x2B	R43		<a href="#">Go</a>
0x2C	R44		<a href="#">Go</a>
0x2E	R46		<a href="#">Go</a>
0x3A	R58		<a href="#">Go</a>
0x3B	R59		<a href="#">Go</a>
0x45	R69		<a href="#">Go</a>
0x46	R70		<a href="#">Go</a>
0x4B	R75		<a href="#">Go</a>
0x4E	R78		<a href="#">Go</a>
0x4F	R79		<a href="#">Go</a>
0x50	R80		<a href="#">Go</a>
0x51	R81		<a href="#">Go</a>
0x52	R82		<a href="#">Go</a>
0x53	R83		<a href="#">Go</a>
0x54	R84		<a href="#">Go</a>
0x58	R88		<a href="#">Go</a>
0x5E	R94		<a href="#">Go</a>
0x5F	R95		<a href="#">Go</a>
0x67	R103		<a href="#">Go</a>
0x6E	R110		<a href="#">Go</a>
0x6F	R111		<a href="#">Go</a>
0x70	R112		<a href="#">Go</a>
0x79	R121		<a href="#">Go</a>
0x7B	R123		<a href="#">Go</a>
0x7E	R126		<a href="#">Go</a>

Complex bit access types are encoded to fit into small table cells. Table 8 shows the codes that are used for access types in this section.

**Table 8. Device Access Type Codes**

Access Type	Code	Description
<b>Read Type</b>		
R	R	Read
<b>Write Type</b>		
W	W	Write
<b>Reset or Default Value</b>		
-n		Value after reset or the default value

**7.6.1 R0 Register (Address = 0x0) [reset = X]**

R0 is shown in [Figure 52](#) and described in [Table 9](#).

Return to [Summary Table](#).

**Figure 52. R0 Register**

7	6	5	4	3	2	1	0
FCAL_HPFD_ADJ	RESERVED			FCAL_EN	MUXOUT_SEL	RESET_PLL	PLL_PD
R/W-0x0	R-0x0			R/W-0x1	R/W-0x1	R/W-0x0	R/W-0x0

**Table 9. R0 Register Field Descriptions**

Bit	Field	Type	Reset	Description
14	SYNC_PHASE_PLL	R/W	X	Puts PLL in SYNC mode so that the channel divider can be synchronized
13-10	RESERVED	R	X	
9	OUT_MUTE	R/W	X	Output buffer automute. 0x0 = Disabled 0x1 = Mutes output buffer during FCAL and when PLL not locked
8-7	FCAL_HPFD_ADJ	R/W	0x0	VCO calibration adjust for higher phase detector frequencies 0x0 = Fpd < 100 MHz 0x1 = Fpd 100 - 150 MHz 0x2 = Fpd 150 - 200 MHz 0x3 = Fpd > 200 MHz
6-4	RESERVED	R	0x0	
3	FCAL_EN	R/W	0x1	Enables frequency calibration. When this bit is high, the VCO frequency calibration will be triggered whenever the R0 register is written to.
2	MUXOUT_SEL	R/W	0x1	Selects to route readback serial data output or lock detect output at the MUXout pin 0x0 = Readback 0x1 = Lock Detect
1	RESET_PLL	R/W	0x0	Reset registers to default values. This bit is self-clearing. 0x0 = No Reset 0x1 = Trigger Reset
0	PLL_PD	R/W	0x0	PLL power down. 0x0 = Powerd Up 0x1 = Powered Down

**7.6.2 R1 Register (Address = 0x1) [reset = 0x3]**

R1 is shown in [Figure 53](#) and described in [Table 10](#).

Return to [Summary Table](#).

**Figure 53. R1 Register**

7	6	5	4	3	2	1	0
RESERVED					CAL_CLK_DIV		
R-0x0					R/W-0x3		

**Table 10. R1 Register Field Descriptions**

Bit	Field	Type	Reset	Description
7-3	RESERVED	R	0x0	
2-0	CAL_CLK_DIV	R/W	0x3	Divides down for state machine clock [SM clock = $F_{osc}/2^{CAL\_CLK\_DIV}$ ]. Maximum state machine clock frequency is 200MHz. For fastest calibration speed, choose value which will make state machine clock closest to 200 MHz.

**7.6.3 R2 Register (Address = 0x2) [reset = X]**

R2 is shown in [Figure 54](#) and described in [Table 11](#).

Return to [Summary Table](#).

**Figure 54. R2 Register**

7	6	5	4	3	2	1	0
RESERVED							
R-0x0							

**Table 11. R2 Register Field Descriptions**

Bit	Field	Type	Reset	Description
10	SM_CLK_EN	R/W	X	Enables state machine clock
9-0	RESERVED	R	0x0	

**7.6.4 R9 Register (Address = 0x9) [reset = X]**

R9 is shown in [Figure 55](#) and described in [Table 12](#).

Return to [Summary Table](#).

**Figure 55. R9 Register**

7	6	5	4	3	2	1	0
RESERVED							
R-0x0							

**Table 12. R9 Register Field Descriptions**

Bit	Field	Type	Reset	Description
12	OSC_2X	R/W	X	Enables the frequency doubler after the input reference signal. 0x0 = Bypass 0x1 = Enable doubler
11-0	RESERVED	R	0x0	

**7.6.5 R10 Register (Address = 0xA) [reset = 0x80]**

R10 is shown in [Figure 56](#) and described in [Table 13](#).

Return to [Summary Table](#).

**Figure 56. R10 Register**

7	6	5	4	3	2	1	0
MULT		RESERVED					
R/W-0x1		R-0x0					

**Table 13. R10 Register Field Descriptions**

Bit	Field	Type	Reset	Description
11-7	MULT	R/W	0x1	Input signal multiplier. When not in bypass, input range is 40-70MHz, output range is 180-250MHz. 1,3,4,5,6, and 7 are the only valid values. 0x1 = Bypass 0x3 = x3 0x4 = x4 0x5 = x5 0x6 = x6
6-0	RESERVED	R	0x0	

**7.6.6 R11 Register (Address = 0xB) [reset = 0x10]**

R11 is shown in [Figure 57](#) and described in [Table 14](#).

Return to [Summary Table](#).

**Figure 57. R11 Register**

7	6	5	4	3	2	1	0
PLL_R				RESERVED			
R/W-0x1				R-0x0			

**Table 14. R11 Register Field Descriptions**

Bit	Field	Type	Reset	Description
11-4	PLL_R	R/W	0x1	PLL R divider that is after the input multiplier.
3-0	RESERVED	R	0x0	

**7.6.7 R14 Register (Address = 0xE) [reset = 0x70]**

R14 is shown in [Figure 58](#) and described in [Table 15](#).

Return to [Summary Table](#).

**Figure 58. R14 Register**

7	6	5	4	3	2	1	0
RESERVED		CPG			RESERVED		
R-0x0		R/W-0x7			R-0x0		

**Table 15. R14 Register Field Descriptions**

Bit	Field	Type	Reset	Description
7	RESERVED	R	0x0	
6-4	CPG	R/W	0x7	Charge pump gain 0x0 = 0 mA 0x1 = 6 mA 0x2 = 6 mA 0x3 = 12 mA 0x4 = 3 mA 0x5 = 9 mA 0x6 = 9 mA 0x7 = 15 mA
3-0	RESERVED	R	0x0	

**7.6.8 R36 Register (Address = 0x24) [reset = 0x64]**

 R36 is shown in [Figure 59](#) and described in [Table 16](#).

 Return to [Summary Table](#).

**Figure 59. R36 Register**

15	14	13	12	11	10	9	8	7	6	5	4	3	2	1	0
PLL_N															
R/W-0x64															

**Table 16. R36 Register Field Descriptions**

Bit	Field	Type	Reset	Description
15-0	PLL_N	R/W	0x64	Integer part of N divider

**7.6.9 R37 Register (Address = 0x25) [reset = 0x200]**

 R37 is shown in [Figure 60](#) and described in [Table 17](#).

 Return to [Summary Table](#).

**Figure 60. R37 Register**

15	14	13	12	11	10	9	8
RESERVED				PFD_DLY_SEL			
R-0x0				R/W-0x2			
7	6	5	4	3	2	1	0
RESERVED							
R-0x0							

**Table 17. R37 Register Field Descriptions**

Bit	Field	Type	Reset	Description
15-14	RESERVED	R	0x0	
13-8	PFD_DLY_SEL	R/W	0x2	Sets the appropriate delay adjustment for the phase detector based on PLL_N, MASH_ORDER, and phase detector frequency.
7-0	RESERVED	R	0x0	



### 7.6.10 R38 Register (Address = 0x26) [reset = 0x0]

R38 is shown in [Figure 61](#) and described in [Table 18](#).

Return to [Summary Table](#).

**Figure 61. R38 Register**

15	14	13	12	11	10	9	8	7	6	5	4	3	2	1	0
PLL_DEN_31:16															
R/W-0x0															

**Table 18. R38 Register Field Descriptions**

Bit	Field	Type	Reset	Description
15-0	PLL_DEN_31:16	R/W	0x0	Denominator of N divider fraction (MSB)

### 7.6.11 R39 Register (Address = 0x27) [reset = 0x2710]

R39 is shown in [Figure 62](#) and described in [Table 19](#).

Return to [Summary Table](#).

**Figure 62. R39 Register**

15	14	13	12	11	10	9	8	7	6	5	4	3	2	1	0
PLL_DEN															
R/W-0x2710															

**Table 19. R39 Register Field Descriptions**

Bit	Field	Type	Reset	Description
15-0	PLL_DEN	R/W	0x2710	Denominator of N divider fraction (LSB)

### 7.6.12 R40 Register (Address = 0x28) [reset = 0x0]

R40 is shown in [Figure 63](#) and described in [Table 20](#).

Return to [Summary Table](#).

**Figure 63. R40 Register**

15	14	13	12	11	10	9	8	7	6	5	4	3	2	1	0
MASH_SEED_31:16															
R/W-0x0															

**Table 20. R40 Register Field Descriptions**

Bit	Field	Type	Reset	Description
15-0	MASH_SEED_31:16	R/W	0x0	MSB bit of MASH_SEED

### 7.6.13 R41 Register (Address = 0x29) [reset = 0x0]

R41 is shown in [Figure 64](#) and described in [Table 21](#).

Return to [Summary Table](#).

**Figure 64. R41 Register**

15	14	13	12	11	10	9	8	7	6	5	4	3	2	1	0
MASH_SEED															
R/W-0x0															

**Table 21. R41 Register Field Descriptions**

Bit	Field	Type	Reset	Description
15-0	MASH_SEED	R/W	0x0	The MASH_SEED can be used for optimizing fractional mode (see simulation tool) and also phase adjustment feature. Phase adjustment writing to this register will trigger a phase shift (in degrees) = $360 \times [\text{MASH\_SEED}] \times [\text{PLL\_N\_PRE}] / [\text{N-divider denominator}] / [\text{Channel divider}]$ . MASH_SEED must be less than N-divider denominator For example, for MASH_SEED = 100, PLL_N_PRE=2, PLL_DEN = 200, CHDIV=3, Phase Shift = $360 * 100 * 2 / 200 / 3 = 120$ degrees

**7.6.14 R42 Register (Address = 0x2A) [reset = 0x0]**

 R42 is shown in [Figure 65](#) and described in [Table 22](#).

 Return to [Summary Table](#).

**Figure 65. R42 Register**

15	14	13	12	11	10	9	8	7	6	5	4	3	2	1	0
PLL_NUM_31:16															
R/W-0x0															

**Table 22. R42 Register Field Descriptions**

Bit	Field	Type	Reset	Description
15-0	PLL_NUM_31:16	R/W	0x0	Numerator of N divider fraction (MSB)

**7.6.15 R43 Register (Address = 0x2B) [reset = 0x0]**

 R43 is shown in [Figure 66](#) and described in [Table 23](#).

 Return to [Summary Table](#).

**Figure 66. R43 Register**

15	14	13	12	11	10	9	8	7	6	5	4	3	2	1	0
PLL_NUM															
R/W-0x0															

**Table 23. R43 Register Field Descriptions**

Bit	Field	Type	Reset	Description
15-0	PLL_NUM	R/W	0x0	Numerator of N divider fraction (LSB)

**7.6.16 R44 Register (Address = 0x2C) [reset = 0xA2]**

 R44 is shown in [Figure 67](#) and described in [Table 24](#).

 Return to [Summary Table](#).

**Figure 67. R44 Register**

15	14	13	12	11	10	9	8
RESERVED							
R-0x0							
7	6	5	4	3	2	1	0
LO_OUT_PD	RESERVED	MASH_RESET_N	RESERVED			MASH_ORDER	
R/W-0x1	R-0x0	R/W-0x1	R-0x0			R/W-0x2	

**Table 24. R44 Register Field Descriptions**

Bit	Field	Type	Reset	Description
15-8	RESERVED	R	0x0	
7	LO_OUT_PD	R/W	0x1	Disable output buffer of output A 0x0 = Enable 0x1 = Disable (disable if not using output B)
6	RESERVED	R	0x0	
5	MASH_RESET_N	R/W	0x1	MASH enable. Should be set to 1 in fractional mode. To reset the MASH toggle from 0 to 1.
4-3	RESERVED	R	0x0	
2-0	MASH_ORDER	R/W	0x2	Fractional-N divider sigma-delta MASH engine order. This sets the algorithm used in fractional-N mode generation and has impact on fractional spurs. Refer to the datasheet for more information. Recommended values are as follows, but other values may also work.

**7.6.17 R46 Register (Address = 0x2E) [reset = 0x1]**

R46 is shown in [Figure 68](#) and described in [Table 25](#).

Return to [Summary Table](#).

**Figure 68. R46 Register**

15	14	13	12	11	10	9	8
RESERVED							
R-0x0							
7	6	5	4	3	2	1	0
RESERVED						LO_OUT_MUX	
R-0x0						R/W-0x1	

**Table 25. R46 Register Field Descriptions**

Bit	Field	Type	Reset	Description
15-2	RESERVED	R	0x0	
1-0	LO_OUT_MUX	R/W	0x1	Selects signal to route to output B 0x0 = Selects the output from channel divider MUX 0x1 = Selects output from VCO

**7.6.18 R58 Register (Address = 0x3A) [reset = 0x8000]**

R58 is shown in [Figure 69](#) and described in [Table 26](#).

Return to [Summary Table](#).

**Figure 69. R58 Register**

15	14	13	12	11	10	9	8
SYNC_PIN_IG NORE	RESERVED						
R/W-0x1	R-0x0						
7	6	5	4	3	2	1	0
RESERVED							
R-0x0							

**Table 26. R58 Register Field Descriptions**

Bit	Field	Type	Reset	Description
15	SYNC_PIN_IGNORE	R/W	0x1	Enable this bit when NOT using SYNC mode as the SYNC pin interferes with lock detect in this case. When PLL_PHASE_SYNC=1, this bit may be disabled with no issues with lock detect.
14-0	RESERVED	R	0x0	

**7.6.19 R59 Register (Address = 0x3B) [reset = 0x1]**

 R59 is shown in [Figure 70](#) and described in [Table 27](#).

 Return to [Summary Table](#).

**Figure 70. R59 Register**

15	14	13	12	11	10	9	8
RESERVED							
R-0x0							
7	6	5	4	3	2	1	0
RESERVED							LD_TYPE
R-0x0							R/W-0x1

**Table 27. R59 Register Field Descriptions**

Bit	Field	Type	Reset	Description
15-1	RESERVED	R	0x0	
0	LD_TYPE	R/W	0x1	Lock detect type. VCOCal lock detect is high except when the VCO is calibrating and also during a timeout count right after calibration set LD_DLY. Vtune and VCOCal lock detect is high whenever VCOCal lock detect would be high and the VCO tuning voltage is within an acceptable range. 0x0 = VCOCal 0x1 = Vtune and VCOCal.

**7.6.20 R69 Register (Address = 0x45) [reset = 0x0]**

 R69 is shown in [Figure 71](#) and described in [Table 28](#).

 Return to [Summary Table](#).

**Figure 71. R69 Register**

15	14	13	12	11	10	9	8	7	6	5	4	3	2	1	0
MASH_RST_COUNT_31:16															
R/W-0x0															

**Table 28. R69 Register Field Descriptions**

Bit	Field	Type	Reset	Description
15-0	MASH_RST_COUNT_31:16	R/W	0x0	MSB of MASH_RST_COUNT

**7.6.21 R70 Register (Address = 0x46) [reset = 0xC350]**

 R70 is shown in [Figure 72](#) and described in [Table 29](#).

 Return to [Summary Table](#).

**Figure 72. R70 Register**

15	14	13	12	11	10	9	8	7	6	5	4	3	2	1	0
MASH_RST_COUNT															
R/W-0xC350															

**Table 29. R70 Register Field Descriptions**

Bit	Field	Type	Reset	Description
15-0	MASH_RST_COUNT	R/W	0xC350	When using a fractional N value with PLL_PHASE_SYNC=1, this is used to set a delay to allow the SYNC to work properly. In general, it should be set to a count equal to 4X the analog settling time of the PLL. (LSB)

### 7.6.22 R75 Register (Address = 0x4B) [reset = 0x0]

R75 is shown in [Figure 73](#) and described in [Table 30](#).

Return to [Summary Table](#).

**Figure 73. R75 Register**

15	14	13	12	11	10	9	8
RESERVED						CHDIV	
R-0x0						R/W-0x0	
7	6	5	4	3	2	1	0
CHDIV		RESERVED					
R/W-0x0		R-0x0					

**Table 30. R75 Register Field Descriptions**

Bit	Field	Type	Reset	Description
15-11	RESERVED	R	0x0	
10-6	CHDIV	R/W	0x0	Channel divider that divides the VCO frequency.
5-0	RESERVED	R	0x0	

### 7.6.23 R78 Register (Address = 0x4E) [reset = 0x0]

R78 is shown in [Figure 74](#) and described in [Table 31](#).

Return to [Summary Table](#).

**Figure 74. R78 Register**

15	14	13	12	11	10	9	8
RESERVED						VCO_CALSTA RT_CLOSE	RESERVED
R-0x0						R/W-0x0	R-0x0
7	6	5	4	3	2	1	0
RESERVED							
R-0x0							

**Table 31. R78 Register Field Descriptions**

Bit	Field	Type	Reset	Description
15-10	RESERVED	R	0x0	
9	VCO_CALSTART_CLOS E	R/W	0x0	Uses current values for VCO core, frequency band, and amplitude as the starting point for the next VCO calibration. Enable this if the VCO frequency change is close, on the order of 50 MHz or less.
8-0	RESERVED	R	0x0	

### 7.6.24 R79 Register (Address = 0x4F) [reset = 0x7000]

R79 is shown in [Figure 75](#) and described in [Table 32](#).

Return to [Summary Table](#).

**Figure 75. R79 Register**

15	14	13	12	11	10	9	8
RESERVED	LO_PATH_EN			RESERVED			
R-0x0	R/W-0x7			R-0x0			
7	6	5	4	3	2	1	0
RESERVED	IFA_PULLUP_EN	RESERVED			LNA_PD	SIGPATH_RST	SIGCHAIN_PD
R-0x0	R/W-0x0	R-0x0			R/W-0x0	R/W-0x0	R/W-0x0

**Table 32. R79 Register Field Descriptions**

Bit	Field	Type	Reset	Description
15	RESERVED	R	0x0	
14-12	LO_PATH_EN	R/W	0x7	Enables various parts of the Poly and DIV2 Path
11-7	RESERVED	R	0x0	
6	IFA_PULLUP_EN	R/W	0x0	Enable the pull up resistor at the input of the IFA. Needed when the output comoon mode is <1.4V
5-3	RESERVED	R	0x0	
2	LNA_PD	R/W	0x0	LNA power down
1	SIGPATH_RST	R/W	0x0	Master reset for the signal chain
0	SIGCHAIN_PD	R/W	0x0	Master power down for the signal chain.

### 7.6.25 R80 Register (Address = 0x50) [reset = 0xA]

R80 is shown in [Figure 76](#) and described in [Table 33](#).

Return to [Summary Table](#).

**Figure 76. R80 Register**

15	14	13	12	11	10	9	8
RESERVED				SYNC_PHASE_MIXLO	SYNC_DRV2_EN	SYNC_DRV1_EN	RESERVED
R-0x0				R/W-0x0	R/W-0x0	R/W-0x0	R-0x0
7	6	5	4	3	2	1	0
RESERVED		LO_MUX					
R-0x0		R/W-0xA					

**Table 33. R80 Register Field Descriptions**

Bit	Field	Type	Reset	Description
15-12	RESERVED	R	0x0	
11	SYNC_PHASE_MIXLO	R/W	0x0	Sync bit to close the loop from Mixer LO back to synthesizer
10	SYNC_DRV2_EN	R/W	0x0	Enables the SYNC 2nd stage driver from the LO output path. It should be enabled in SYNC mode. 0x0 = Disabled 0x1 = Enabled
9	SYNC_DRV1_EN	R/W	0x0	Enables the SYNC first stage driver from the LO output path. It should be enabled in SYNC mode. 0x0 = Disabled 0x1 = Enabled
8-6	RESERVED	R	0x0	

**Table 33. R80 Register Field Descriptions (continued)**

Bit	Field	Type	Reset	Description
5-0	LO_MUX	R/W	0xA	Sets up various MUXs and Drivers 0x9 = Internal LO DIV2 Mode 0x10 = Internal LO Poly 48 External LO

**7.6.26 R81 Register (Address = 0x51) [reset = 0x0]**

R81 is shown in [Figure 77](#) and described in [Table 34](#).

Return to [Summary Table](#).

**Figure 77. R81 Register**

15	14	13	12	11	10	9	8
RESERVED				LO_POLY_MODE1			
R-0x0				R/W-0x0			
7	6	5	4	3	2	1	0
EXTLO_CLK_DIV_EN		LO_DRV_MODE		RESERVED	EXTLO_CLK_DRV_EN		SM_CLK_SEL
R/W-0x0		R/W-0x0		R-0x0	R/W-0x0		R/W-0x0

**Table 34. R81 Register Field Descriptions**

Bit	Field	Type	Reset	Description
15-12	RESERVED	R	0x0	
11-8	LO_POLY_MODE1	R/W	0x0	Sets up parameters for the poly path 0x0 = Internal LO Poly 0x15 = External LO 0x19 = Internal LO DIV2
7-6	EXTLO_CLK_DIV_EN	R/W	0x0	Selects driver for SMCLK 0x0 = Internal LO 0x1 = Reserved 0x2 = Reserved 0x3 = External LO
5-4	LO_DRV_MODE	R/W	0x0	Sets up drivers for LO quadrature path 0x0 = Internal LO Poly 0x1 = Internal LO DIV2 0x2 = Reserved 0x3 = External LO
3	RESERVED	R	0x0	
2-1	EXTLO_CLK_DRV_EN	R/W	0x0	Enables drivers for state machine clock.
0	SM_CLK_SEL	R/W	0x0	Selects the state machine clock source for the signal path 0x0 = Internal LO 0x1 = External LO

**7.6.27 R82 Register (Address = 0x52) [reset = 0x23]**

R82 is shown in [Figure 78](#) and described in [Table 35](#).

Return to [Summary Table](#).

**Figure 78. R82 Register**

15	14	13	12	11	10	9	8
RESERVED							
R-0x0							
7	6	5	4	3	2	1	0

RESERVED	EXTLO_DIV
R-0x0	R/W-0x23

**Table 35. R82 Register Field Descriptions**

Bit	Field	Type	Reset	Description
15-6	RESERVED	R	0x0	
5-0	EXTLO_DIV	R/W	0x23	Sets total divide value for the state machine clock when using an external LO. This total divide is the product of two divides, DIVA and DIVB. 0x0 = 1 0x1 = 2 0x2 = 16 0x3 = 8 0x4 = 16 0x5 = 16 0x6 = 64 0x7 = 8

**7.6.28 R83 Register (Address = 0x53) [reset = 0x2000]**

R83 is shown in [Figure 79](#) and described in [Table 36](#).

Return to [Summary Table](#).

**Figure 79. R83 Register**

15	14	13	12	11	10	9	8
IFA_PULLUP			VCM_CONFIG				RESERVED
R/W-0x1			R/W-0x0				R-0x0
7	6	5	4	3	2	1	0
RESERVED							
R-0x0							

**Table 36. R83 Register Field Descriptions**

Bit	Field	Type	Reset	Description
15-13	IFA_PULLUP	R/W	0x1	IFA virtual node pull up resistor to set the biasing of the IFA input stage correct when the output common mode is <1.4V. Should be used in conjunction with the corresponding EN bit in first register. 0x2 = Invalid 0x4 = Invalid 0x5 = Invalid 0x6 = Invalid
12-9	VCM_CONFIG	R/W	0x0	Output Common mode (VOCM) configuration for IFA. Only one bit to be set as high at a time. Only valid states are 0,3,5,9. 0x0 = 1.7 0x3 = 2V 0x5 = External 0x9 = 1.4V
8-0	RESERVED	R	0x0	

**7.6.29 R84 Register (Address = 0x54) [reset = 0x1900]**

R84 is shown in [Figure 80](#) and described in [Table 37](#).

Return to [Summary Table](#).



**Figure 80. R84 Register**

15	14	13	12	11	10	9	8
DCOC_CLK_DIV							
R/W-0x64							
7	6	5	4	3	2	1	0
DCOC_CLK_DIV		RESERVED				EN_DCOC_QC H_LUT	EN_DCOC_IC H_LUT
R/W-0x64		R-0x0				R/W-0x0	R/W-0x0

**Table 37. R84 Register Field Descriptions**

Bit	Field	Type	Reset	Description
15-6	DCOC_CLK_DIV	R/W	0x64	DCOC clock division controlled
5-2	RESERVED	R	0x0	
1	EN_DCOC_QCH_LUT	R/W	0x0	Enable offset calibration for Q channel. Write 1 to trigger calibration. To re-trigger, clear this bit and then write 1 again.
0	EN_DCOC_ICH_LUT	R/W	0x0	Enable offset calibration for I channel. Write 1 to trigger calibration. To re-trigger, clear this bit and then write 1 again.

**7.6.30 R88 Register (Address = 0x58) [reset = 0x0]**

R88 is shown in [Figure 81](#) and described in [Table 38](#).

Return to [Summary Table](#).

**Figure 81. R88 Register**

15	14	13	12	11	10	9	8
RESERVED		rb_DCOC_CAL	RESERVED				
R-0x0		R-0x0	R-0x0				
7	6	5	4	3	2	1	0
RESERVED							
R-0x0							

**Table 38. R88 Register Field Descriptions**

Bit	Field	Type	Reset	Description
15	RESERVED	R	0x0	
14	rb_DCOC_CAL	R	0x0	Status bit. Indicates whether I channel DC offset calibration is done. 0x0 = Neither Channel Done 1 I Channel Done 0x2 = Q Channel Done 0x3 = Both Channels Done
13-0	RESERVED	R	0x0	

**7.6.31 R94 Register (Address = 0x5E) [reset = 0x8080]**

R94 is shown in [Figure 82](#) and described in [Table 39](#).

Return to [Summary Table](#).

**Figure 82. R94 Register**

15	14	13	12	11	10	9	8
IMRR_GCAL_QCH							
R/W-0x80							
7	6	5	4	3	2	1	0
IMRR_GCAL_ICH							
R/W-0x80							

**Table 39. R94 Register Field Descriptions**

Bit	Field	Type	Reset	Description
15-8	IMRR_GCAL_QCH	R/W	0x80	IMRR gain control for the Q channel.
7-0	IMRR_GCAL_ICH	R/W	0x80	IMRR gain control for the I channel.

**7.6.32 R95 Register (Address = 0x5F) [reset = X]**

 R95 is shown in [Figure 83](#) and described in [Table 40](#).

 Return to [Summary Table](#).

**Figure 83. R95 Register**

7	6	5	4	3	2	1	0
RESERVED							
R-0x0							

**Table 40. R95 Register Field Descriptions**

Bit	Field	Type	Reset	Description
15	IMRR_PHCAL_POL	R/W	X	IMRR Phase polarity control using the phase interpolator.
14-9	IMRR_PHCAL	R/W	X	IMRR Phase control using the phase interpolator. Preferred method of the IMRR phase correction.
8	LODRV_IMRR_PHCAL_P OLCTRL	R/W	X	IMRR Phase polarity control using the slew control driver.
7-0	RESERVED	R	0x0	

**7.6.33 R103 Register (Address = 0x67) [reset = X]**

 R103 is shown in [Figure 84](#) and described in [Table 41](#).

 Return to [Summary Table](#).

**Figure 84. R103 Register**

7	6	5	4	3	2	1	0
RESERVED							
R-0x0							

**Table 41. R103 Register Field Descriptions**

Bit	Field	Type	Reset	Description
13-10	LO_POLY_MODE2	R/W	X	Selects configurations between Poly and DIV2 Mode
9-0	RESERVED	R	0x0	

**7.6.34 R110 Register (Address = 0x6E) [reset = X]**

 R110 is shown in [Figure 85](#) and described in [Table 42](#).

 Return to [Summary Table](#).

**Figure 85. R110 Register**

7	6	5	4	3	2	1	0
rb_VCO_SEL			RESERVED				
R-0x0			R-0x0				

**Table 42. R110 Register Field Descriptions**

Bit	Field	Type	Reset	Description
10-9	rb_LD_VTUNE	R	X	Readback word for the PLL lock status 0x0 = Unlock (Fvco Low) 0x1 = Invalid 0x2 = PLL Locked 0x3 = Unlock (Fvco High)
8	RESERVED	R	X	
7-5	rb_VCO_SEL	R	0x0	Reads back the VCO core selected. 0x0 = Invalid 0x1 = VCO1 0x2 = VCO2 0x3 = VCO3 0x4 = VCO4 0x5 = VCO5 0x6 = VCO6 0x7 = VCO7
4-0	RESERVED	R	0x0	

**7.6.35 R111 Register (Address = 0x6F) [reset = 0x0]**

R111 is shown in [Figure 86](#) and described in [Table 43](#).

Return to [Summary Table](#).

**Figure 86. R111 Register**

7	6	5	4	3	2	1	0
rb_VCO_CAPCTRL							
R-0x0							

**Table 43. R111 Register Field Descriptions**

Bit	Field	Type	Reset	Description
7-0	rb_VCO_CAPCTRL	R	0x0	Readback word for the actual value of VCO_CAPCTRL chosen by the VCO frequency calibration.

**7.6.36 R112 Register (Address = 0x70) [reset = 0x0]**

R112 is shown in [Figure 87](#) and described in [Table 44](#).

Return to [Summary Table](#).

**Figure 87. R112 Register**

7	6	5	4	3	2	1	0
rb_VCO_DACISSET							
R-0x0							

**Table 44. R112 Register Field Descriptions**

Bit	Field	Type	Reset	Description
8-0	rb_VCO_DACISSET	R	0x0	Readback word for the actual value of VCO_DACISSET chosen by the VCO amplitude calibration.

**7.6.37 R121 Register (Address = 0x79) [reset = 0x0]**

 R121 is shown in [Figure 88](#) and described in [Table 45](#).

 Return to [Summary Table](#).

**Figure 88. R121 Register**

7	6	5	4	3	2	1	0
RESERVED		BIAS_LNA_CUR_CONFIG_2		RESERVED			
R-0x0		R/W-0x0		R-0x0			

**Table 45. R121 Register Field Descriptions**

Bit	Field	Type	Reset	Description
7	RESERVED	R	0x0	
6-5	BIAS_LNA_CUR_CONFIG_2	R/W	0x0	
4-0	RESERVED	R	0x0	

**7.6.38 R123 Register (Address = 0x7B) [reset = 0x3]**

 R123 is shown in [Figure 89](#) and described in [Table 46](#).

 Return to [Summary Table](#).

**Figure 89. R123 Register**

7	6	5	4	3	2	1	0
RESERVED						EXTLO_INT_MATCH_RES	
R-0x0						R/W-0x3	

**Table 46. R123 Register Field Descriptions**

Bit	Field	Type	Reset	Description
7-2	RESERVED	R	0x0	
1-0	EXTLO_INT_MATCH_RES	R/W	0x3	Control internal resistor termination at EXTLO input pin 0x0 = No termination 0x1 = 200 Ohms differential termination 0x2 = Same as 1 0x3 = 100 Ohms differential termination

**7.6.39 R126 Register (Address = 0x7E) [reset = X]**

 R126 is shown in [Figure 90](#) and described in [Table 47](#).

 Return to [Summary Table](#).

**Figure 90. R126 Register**

7	6	5	4	3	2	1	0
RESERVED							
R-0x0							

**Table 47. R126 Register Field Descriptions**

Bit	Field	Type	Reset	Description
15	IMRR_PHCAL_EXTEND	R/W	X	Increase the range of the IMRR phase interpolator DAC by 2x
14-9	RESERVED	R	X	
8	DCOC_FSM_RST	R/W	X	Reset DC offset
7-0	RESERVED	R	0x0	

## 8 Application and Implementation

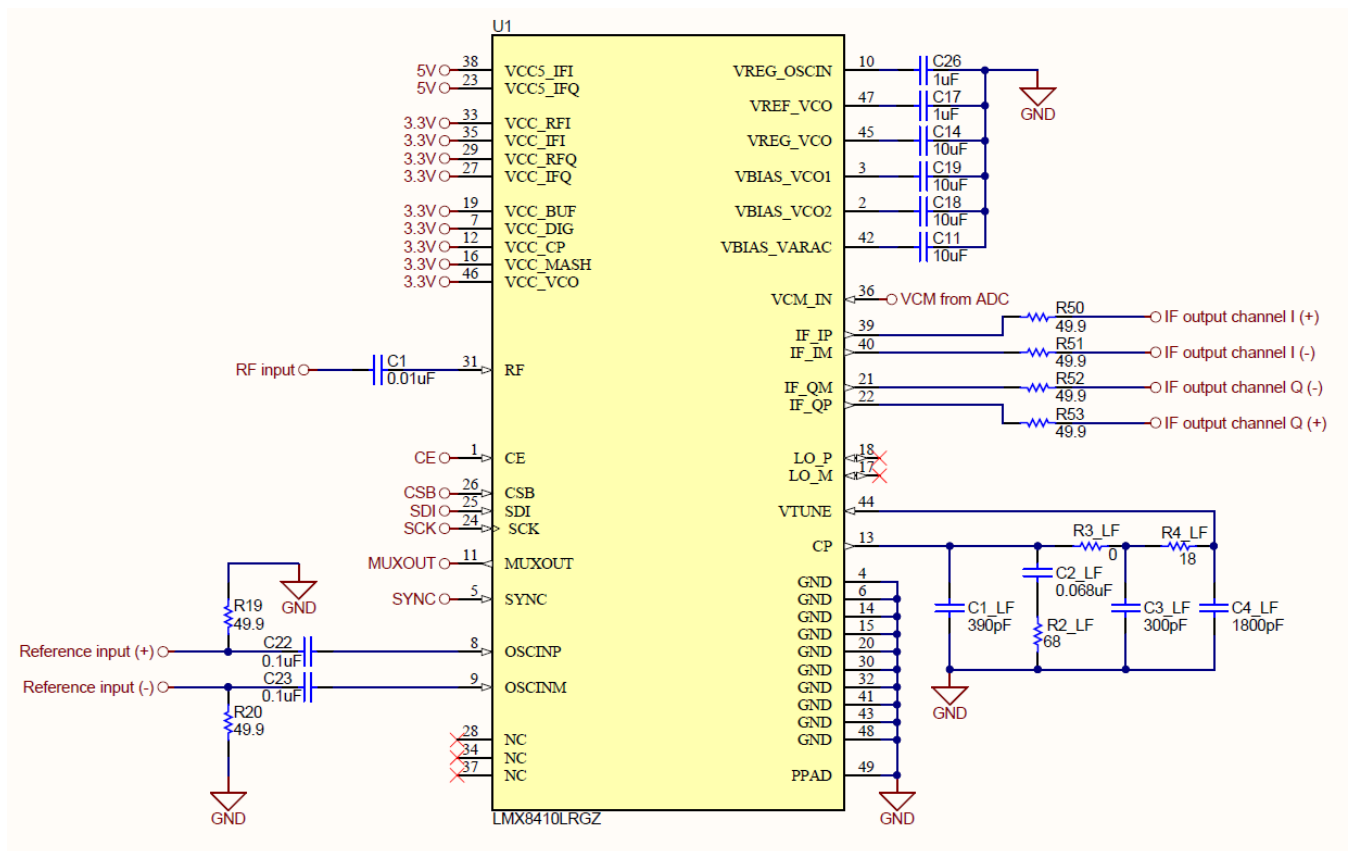
### 注

Information in the following applications sections is not part of the TI component specification, and TI does not warrant its accuracy or completeness. TI's customers are responsible for determining suitability of components for their purposes. Customers should validate and test their design implementation to confirm system functionality.

### 8.1 Application Information

*Typical Application* shows a typical usage of the LMX8410L with internal synthesizer and shows the basic components needed for the operation of the device. There is also guidance on how to design the loop external loop filter which is part of the LMX8410L synthesizer. The PLLatinum Sim is a tool that allows users to enter the information regarding the input reference and target LO frequency they need and simulate the expected phase noise and performance parameters for the synthesizer.

### 8.2 Typical Application



91. Typical Application Schematic

#### 8.2.1 Design Requirements

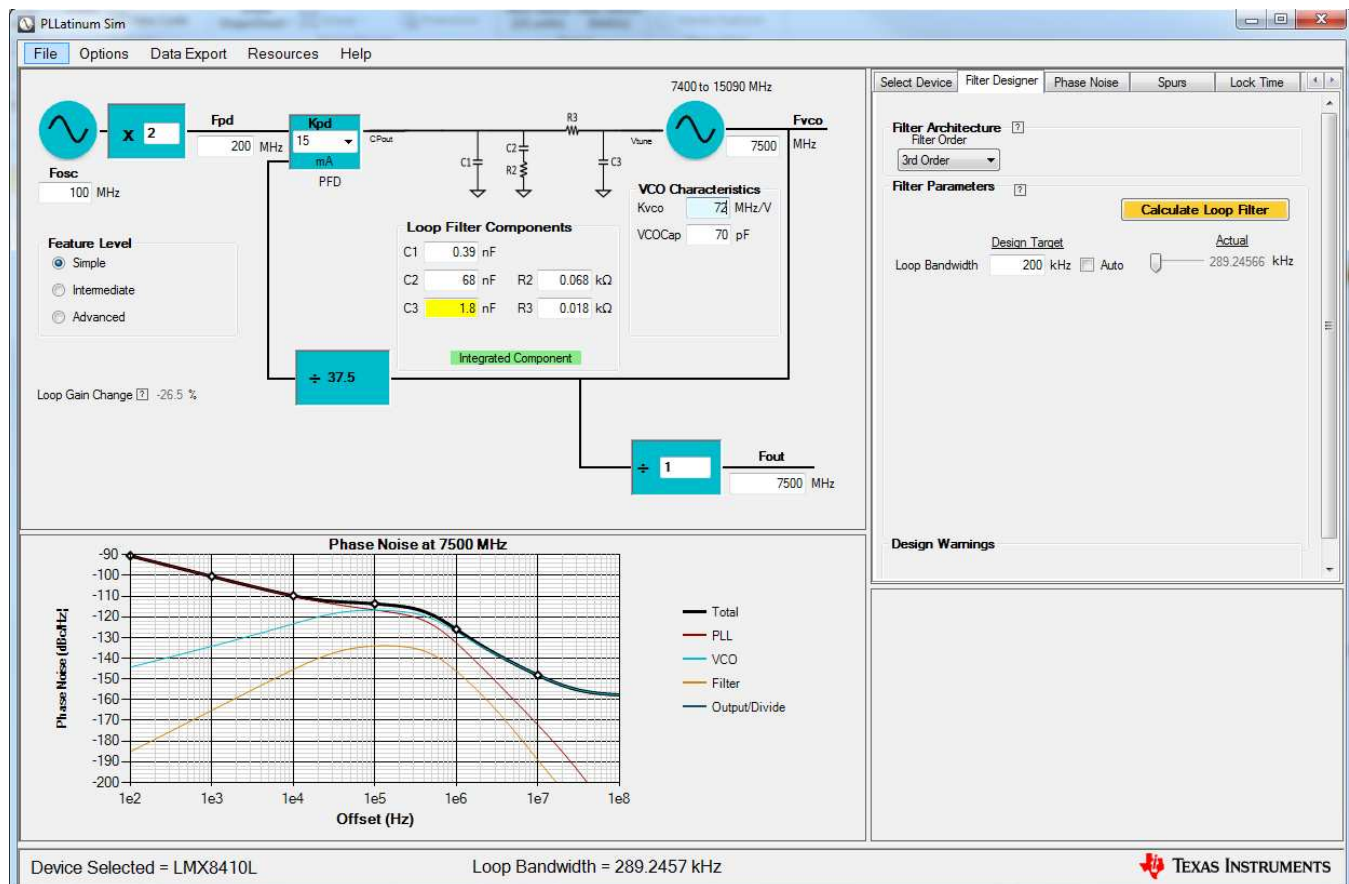
The design of the loop filter is complex and is typically done with software. The PLLatinum Sim software is an excellent resource for doing this and the design is shown in the following figure. For those interested in the equations involved, the PLL Performance, Simulation, and Design Handbook listed in the end of this document goes into great detail as to theory and design of PLL loop filters. PLLatinum Sim does not model the mixers and LNAs in this device, but it can be used for the PLL. To use this tool, it can be modeled as the LMX2594 PLL.

## Typical Application (continued)

### 8.2.2 Detailed Design Procedure

The integration of phase noise over a certain bandwidth (jitter) is an performance specification that translates to signal-to-noise ratio. Phase noise inside the loop bandwidth is dominated by the PLL, while the phase noise outside the loop bandwidth is dominated by the VCO. Generally, jitter is lowest if loop bandwidth is designed to the point where the two intersect. A higher phase margin loop filter design has less peaking at the loop bandwidth and thus lower jitter. The tradeoff with this is that longer lock times and spurs must be considered in design as well.

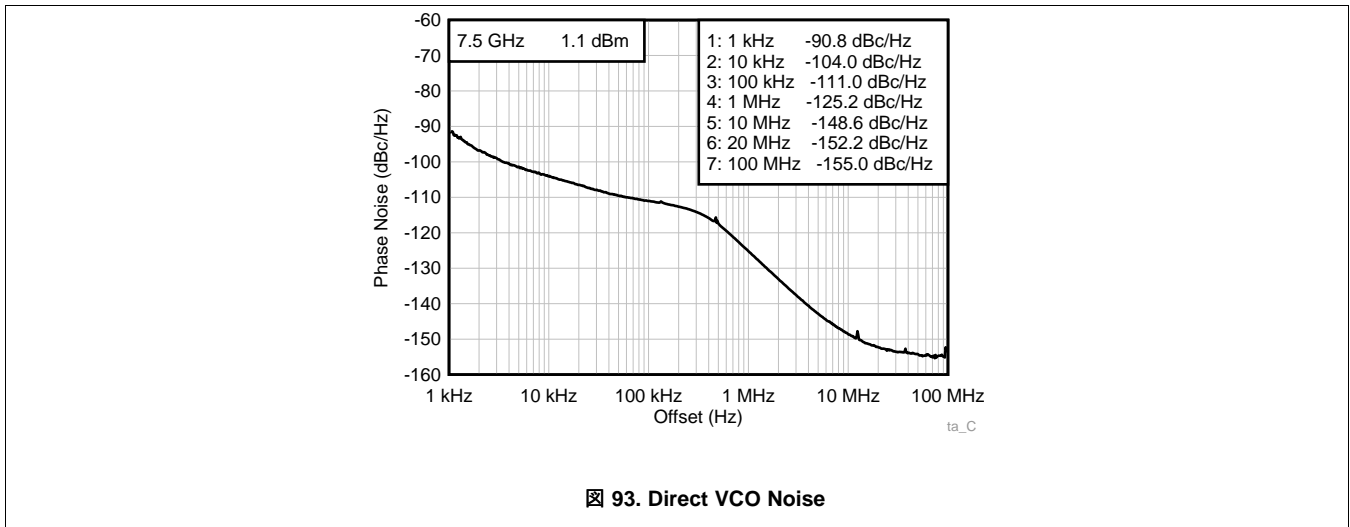
As for software programming, it is highly recommended to use the TICSPRO software. In addition to simplifying the process, it also gives the user recommended programming default values for the undisclosed registers not mentioned in the datasheet.



92. PLLatinum Sim Design Example

**Typical Application (continued)**

**8.2.3 Application Curve**



## 9 Power Supply Recommendations

1. Design 5-V supply to be capable of greater than 200 mA.
2. Design 3.3-V supply to be capable of greater than 800 mA.
3. Supply to channel I and Q sides must be well matched and isolated from one another. Recommend using ferrite beads in series to the pin. The I and Q supplies are for IF amplifier (at pin 38 and 23), for RF input (at pin 33 and 29), and for IF path circuitry (at pin 35 and 27).
4. Pins 7 and 16 are supplies for digital circuitry, and they can have extra isolation in this path (TI recommends using ferrite bead in series to the pin).
5. Pins 12, 19, and 46 are supplies for the internal synthesizer; designer must take care not to have noise sources that can couple to it nearby.
6. Typically use 0.1- $\mu$ F capacitors near the pins. Add extra capacitance values at specific frequencies if known interfering frequencies in system. See [Pin Configuration and Functions](#) for more recommendations on component value recommendations.

## 10 Layout

### 10.1 Layout Guidelines

Generally, there are two major focuses of layout guidelines: high frequency signals and power routing.

#### 10.1.1 High Frequency Trace Routing

- Design all traces for matched impedance. The single-ended RF trace must be controlled for 50- $\Omega$  impedance, while the differential OSCIN, LO, and IF traces must be controlled for 100- $\Omega$  differential impedance.
- Run an uninterrupted ground plane beneath all impedance-controlled traces. No other currents should flow directly under the controlled impedance traces.
- Keep high-frequency traces as short as possible to minimize losses, or potential for cross-coupling.
- Controlled impedance can be challenging in materials not designed for RF applications. For example, standard FR-4 has a wide range of acceptable dielectric constants in practice. Although the constants seen in boards from the same panel or material lot code may match very well, this does not ensure that the constants match between different lots or different dielectric manufacturers. Furthermore, FR-4 has a high loss tangent compared to many other materials, which can result in much greater attenuation of high frequency signals across the same distances. TI recommends the use of materials designed specifically for high-frequency use, such as RO4350B or RO4003C from Rogers Corporation.
- The RF pin is surrounded on three sides by ground pins to assist in the creation of a coplanar waveguide structure. Design the coplanar waveguide to minimize current flow on the ground traces around the pins.
- The IF outputs are low impedance, and require resistors to set the output impedance.
- The LO pins are capacitively coupled as inputs, with internal 50- $\Omega$  termination. Use 50- $\Omega$  pullup resistors to VCC\_BUF to bias these pins as inputs, if driven through external capacitors. The LO pins require 50- $\Omega$  pullup resistors to VCC\_BUF as outputs.
- The LO pins are located very close to the Q-channel IF pins, and the LO buffer supply is located between these two ports. Placing a bypass capacitor as close as possible to the LO buffer is recommended for proper operation, but this presents a potential problem: vias to VCC and GND must be routed between the differential pairs. Because the high frequency currents in the bypass capacitor and the LO buffer circuit tend to follow the loop with the lowest inductance, and since the VCC via interrupts the path from capacitor ground to IC ground on the plane layer immediately below the top, ground currents tend to travel around this via, in the path of the LO and IF coupling to the plane layer. To maintain the signal integrity of both the LO and IF differential traces, no other currents should be flowing immediately below them on the plane layer. Therefore, the LO bypass capacitor ground via must not connect to the plane layer immediately below the capacitor. TI recommends connecting through the subsequent layer. See the Layout Example section on how this is done.

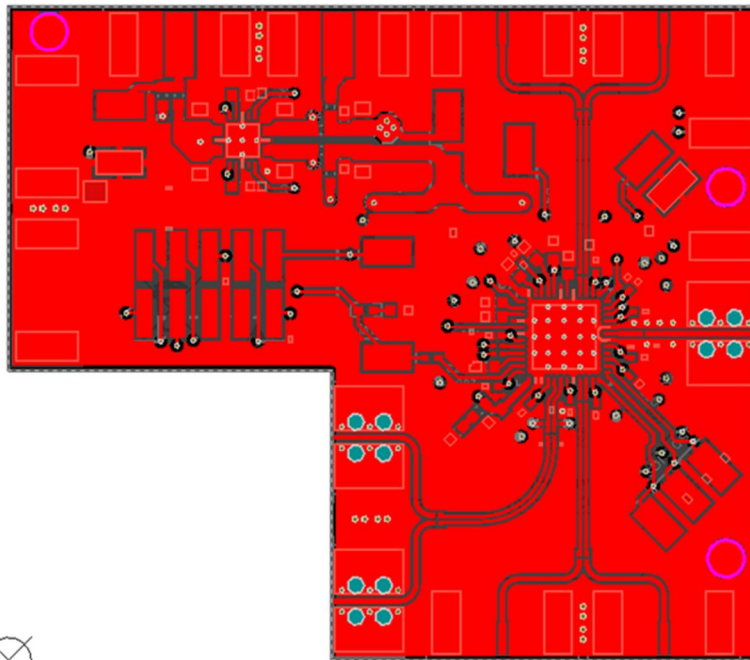


## Layout Guidelines (continued)

### 10.1.2 Power Trace Routing

- Regardless of whether the part is used in internal or external LO mode, all synthesizer VCC and GND pins must be connected properly. If VCC and GND pins are not connected on the synthesizer, the internal power-up procedure may not execute properly. Noise may also be coupled into the mixer from the synthesizer circuitry if power and ground are not properly connected.
- Place bypass capacitors, whenever possible, to minimize the inductance of the current loop formed by the capacitor and the IC. Placing the bypass capacitors on the same surface as the IC allows one terminal to be connected closely to the IC, minimizing this loop. The ground connection can also be made low-inductance by placing a ground via to a plane layer immediately below. Placing capacitors on the opposite surface substantially limits the effective frequencies they can bypass, since the current must travel through two vias. The loop area formed by placing a capacitor on the opposite surface is almost always larger than the loop area formed by placing a capacitor on the same surface.
- Consider the path that ground currents will take. For optimal performance, supply and bypass capacitor currents must not flow underneath high-frequency traces.
- Use as many ground vias as possible to connect the IC pad to the ground plane. This is required for optimal thermal performance.
- Connect ground pins back to the pad. Aside from routing convenience, the inductance through the bond wires tends to be very high, and the inductance through the ground pad tends to be very low.
- Avoid connecting different VCC pins in such a way that the current paths overlap. Overlapping current paths can inject common-mode noise into the supply pins, degrading performance.

## 10.2 Layout Examples



✕ 94. Top Layer

**Layout Examples (continued)**

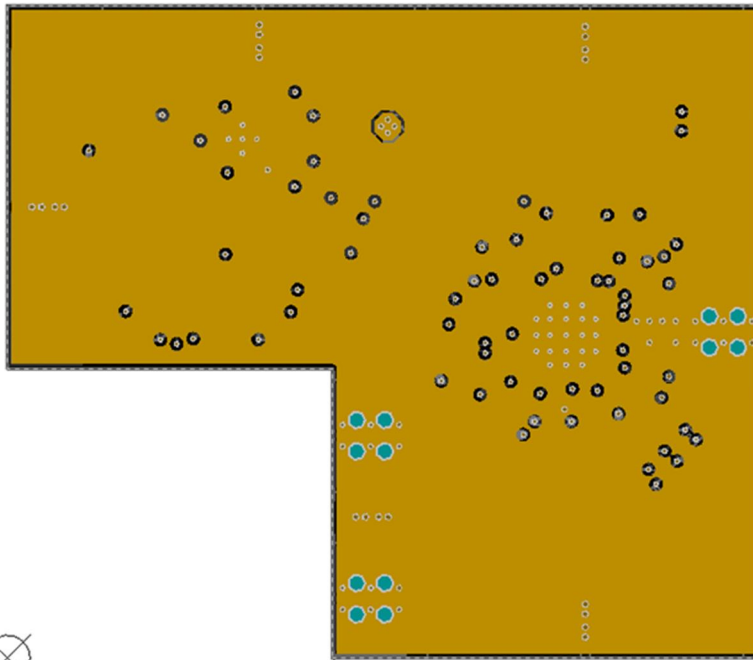


图 95. Ground Layer 1

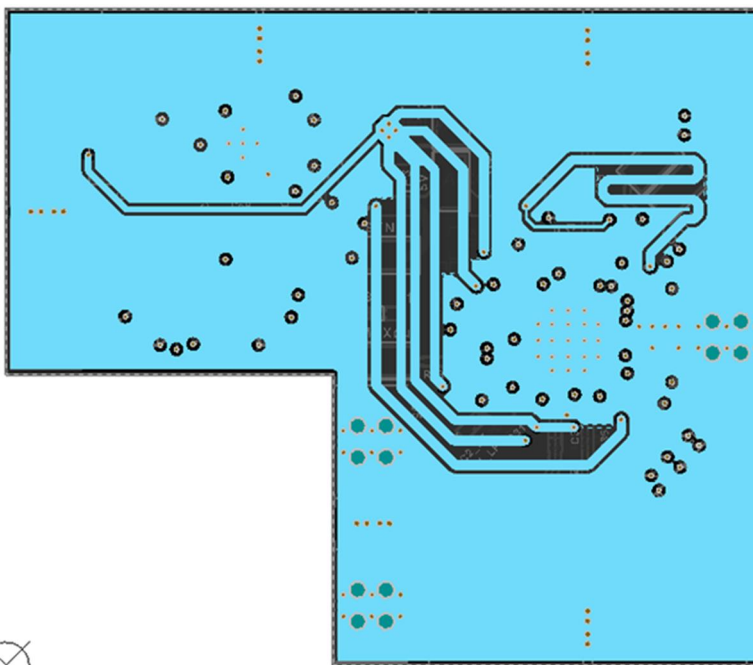


图 96. Mid Layer 1

### Layout Examples (continued)

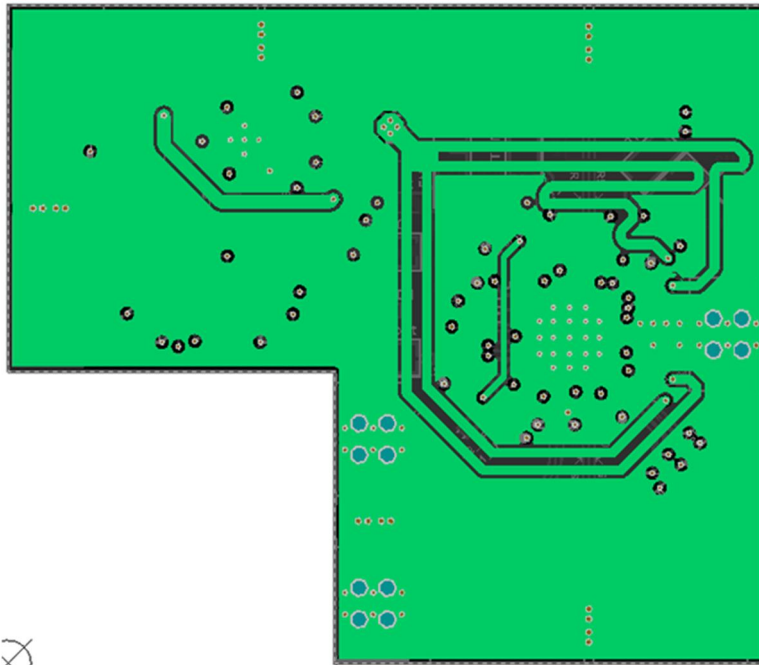


图 97. Mid Layer 2

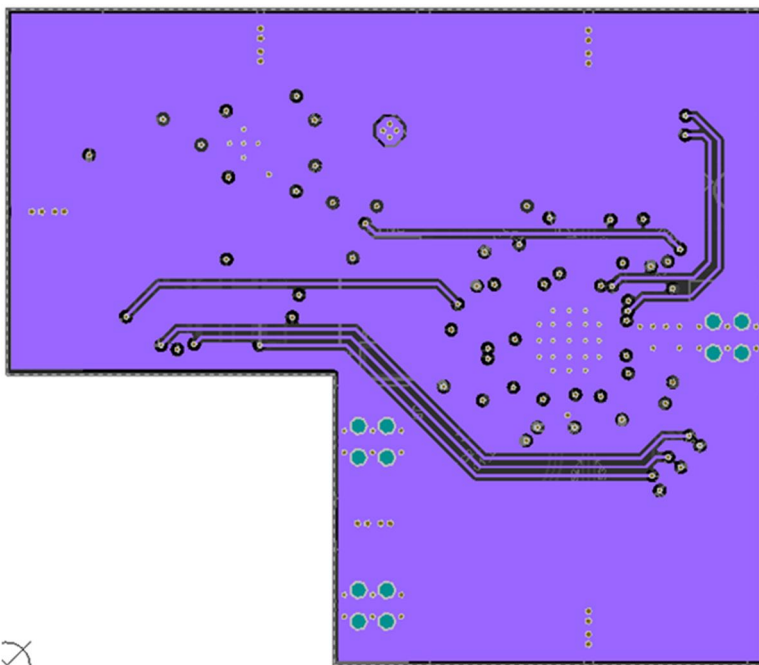


图 98. Mid Layer 3

Layout Examples (continued)

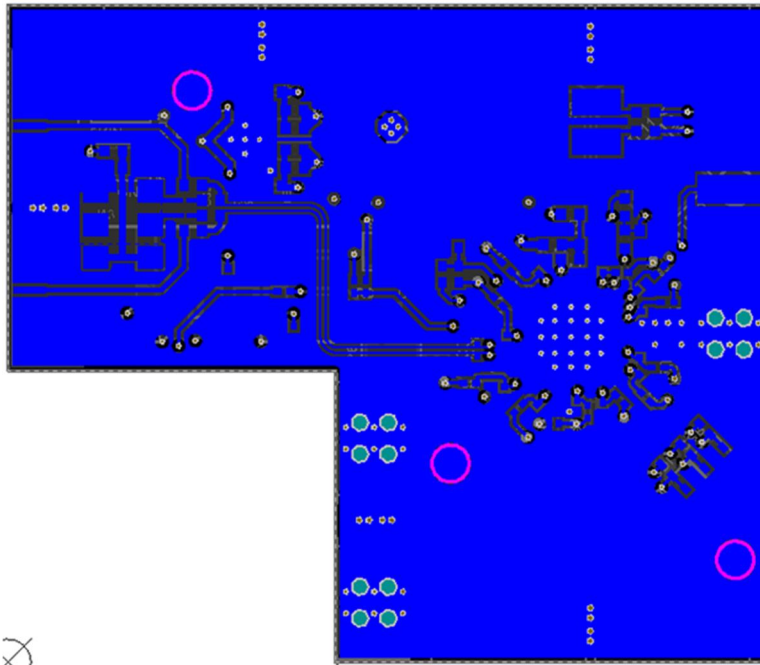


图 99. Bottom Layer

## 11 デバイスおよびドキュメントのサポート

### 11.1 ドキュメントのサポート

#### 11.1.1 関連資料

関連資料については、以下を参照してください。

[『LMX8410LEVMユーザー・ガイド』](#)

### 11.2 ドキュメントの更新通知を受け取る方法

ドキュメントの更新についての通知を受け取るには、[ti.com](http://ti.com)のデバイス製品フォルダを開いてください。右上の隅にある「通知を受け取る」をクリックして登録すると、変更されたすべての製品情報に関するダイジェストを毎週受け取れます。変更の詳細については、修正されたドキュメントに含まれている改訂履歴をご覧ください。

### 11.3 コミュニティ・リソース

The following links connect to TI community resources. Linked contents are provided "AS IS" by the respective contributors. They do not constitute TI specifications and do not necessarily reflect TI's views; see TI's [Terms of Use](#).

**TI E2E™オンライン・コミュニティ** *TIのE2E ( Engineer-to-Engineer )* コミュニティ。エンジニア間の共同作業を促進するために開設されたものです。e2e.ti.comでは、他のエンジニアに質問し、知識を共有し、アイデアを検討して、問題解決に役立てることができます。

**設計サポート** *TIの設計サポート* 役に立つE2Eフォーラムや、設計サポート・ツールをすばやく見つけることができます。技術サポート用の連絡先情報も参照できます。

### 11.4 商標

E2E is a trademark of Texas Instruments.  
 Narda-MITEQ is a trademark of L3 Narda-MITEQ.  
 Mini-Circuits is a trademark of Mini-Circuits.  
 PPM-Test is a trademark of Pulse Power & Measurement Ltd..  
 All other trademarks are the property of their respective owners.

### 11.5 静電気放電に関する注意事項



すべての集積回路は、適切なESD保護方法を用いて、取扱いと保存を行うようにして下さい。

静電気放電はわずかな性能の低下から完全なデバイスの故障に至るまで、様々な損傷を与えます。高精度の集積回路は、損傷に対して敏感であり、極めてわずかなパラメータの変化により、デバイスに規定された仕様に適合しなくなる場合があります。

### 11.6 Glossary

**SLYZ022** — *TI Glossary*.

This glossary lists and explains terms, acronyms, and definitions.

## 12 メカニカル、パッケージ、および注文情報

以降のページには、メカニカル、パッケージ、および注文に関する情報が記載されています。この情報は、そのデバイスについて利用可能な最新のデータです。このデータは予告なく変更されることがあり、ドキュメントが改訂される場合もあります。本データシートのブラウザ版を使用されている場合は、画面左側の説明をご覧ください。

**PACKAGING INFORMATION**

Orderable Device	Status (1)	Package Type	Package Drawing	Pins	Package Qty	Eco Plan (2)	Lead finish/ Ball material (6)	MSL Peak Temp (3)	Op Temp (°C)	Device Marking (4/5)	Samples
LMX8410RGZR	ACTIVE	VQFN	RGZ	48	1000	RoHS & Green	NIPDAUAG	Level-3-260C-168 HR	-40 to 85	LMX8410	<a href="#">Samples</a>
LMX8410RGZT	ACTIVE	VQFN	RGZ	48	250	RoHS & Green	NIPDAUAG	Level-3-260C-168 HR	-40 to 85	LMX8410	<a href="#">Samples</a>

(1) The marketing status values are defined as follows:

**ACTIVE:** Product device recommended for new designs.

**LIFEBUY:** TI has announced that the device will be discontinued, and a lifetime-buy period is in effect.

**NRND:** Not recommended for new designs. Device is in production to support existing customers, but TI does not recommend using this part in a new design.

**PREVIEW:** Device has been announced but is not in production. Samples may or may not be available.

**OBSOLETE:** TI has discontinued the production of the device.

(2) **RoHS:** TI defines "RoHS" to mean semiconductor products that are compliant with the current EU RoHS requirements for all 10 RoHS substances, including the requirement that RoHS substance do not exceed 0.1% by weight in homogeneous materials. Where designed to be soldered at high temperatures, "RoHS" products are suitable for use in specified lead-free processes. TI may reference these types of products as "Pb-Free".

**RoHS Exempt:** TI defines "RoHS Exempt" to mean products that contain lead but are compliant with EU RoHS pursuant to a specific EU RoHS exemption.

**Green:** TI defines "Green" to mean the content of Chlorine (Cl) and Bromine (Br) based flame retardants meet JS709B low halogen requirements of <=1000ppm threshold. Antimony trioxide based flame retardants must also meet the <=1000ppm threshold requirement.

(3) MSL, Peak Temp. - The Moisture Sensitivity Level rating according to the JEDEC industry standard classifications, and peak solder temperature.

(4) There may be additional marking, which relates to the logo, the lot trace code information, or the environmental category on the device.

(5) Multiple Device Markings will be inside parentheses. Only one Device Marking contained in parentheses and separated by a "~" will appear on a device. If a line is indented then it is a continuation of the previous line and the two combined represent the entire Device Marking for that device.

(6) Lead finish/Ball material - Orderable Devices may have multiple material finish options. Finish options are separated by a vertical ruled line. Lead finish/Ball material values may wrap to two lines if the finish value exceeds the maximum column width.

**Important Information and Disclaimer:**The information provided on this page represents TI's knowledge and belief as of the date that it is provided. TI bases its knowledge and belief on information provided by third parties, and makes no representation or warranty as to the accuracy of such information. Efforts are underway to better integrate information from third parties. TI has taken and continues to take reasonable steps to provide representative and accurate information but may not have conducted destructive testing or chemical analysis on incoming materials and chemicals. TI and TI suppliers consider certain information to be proprietary, and thus CAS numbers and other limited information may not be available for release.

In no event shall TI's liability arising out of such information exceed the total purchase price of the TI part(s) at issue in this document sold by TI to Customer on an annual basis.



**TAPE AND REEL INFORMATION**

**QUADRANT ASSIGNMENTS FOR PIN 1 ORIENTATION IN TAPE**


\*All dimensions are nominal

Device	Package Type	Package Drawing	Pins	SPQ	Reel Diameter (mm)	Reel Width W1 (mm)	A0 (mm)	B0 (mm)	K0 (mm)	P1 (mm)	W (mm)	Pin1 Quadrant
LMX8410RGZR	VQFN	RGZ	48	1000	330.0	16.4	7.3	7.3	1.3	12.0	16.0	Q2
LMX8410RGZT	VQFN	RGZ	48	250	178.0	16.4	7.3	7.3	1.3	12.0	16.0	Q2



**TAPE AND REEL BOX DIMENSIONS**


\*All dimensions are nominal

Device	Package Type	Package Drawing	Pins	SPQ	Length (mm)	Width (mm)	Height (mm)
LMX8410RGZR	VQFN	RGZ	48	1000	356.0	356.0	36.0
LMX8410RGZT	VQFN	RGZ	48	250	208.0	191.0	35.0

## GENERIC PACKAGE VIEW

**RGZ 48**

**VQFN - 1 mm max height**

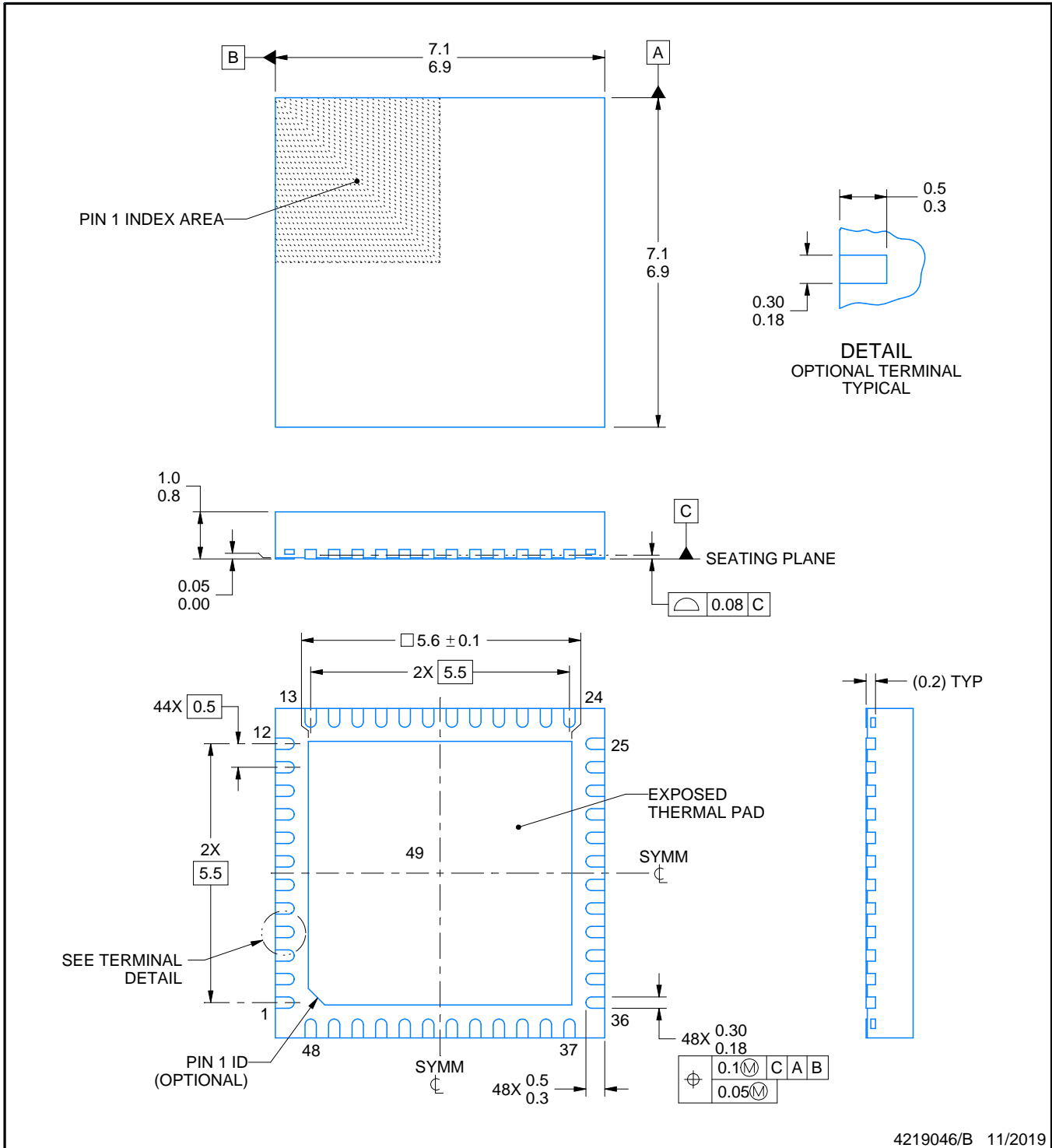
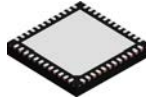
7 x 7, 0.5 mm pitch

PLASTIC QUADFLAT PACK- NO LEAD



Images above are just a representation of the package family, actual package may vary.  
Refer to the product data sheet for package details.

4224671/A



4219046/B 11/2019

NOTES:

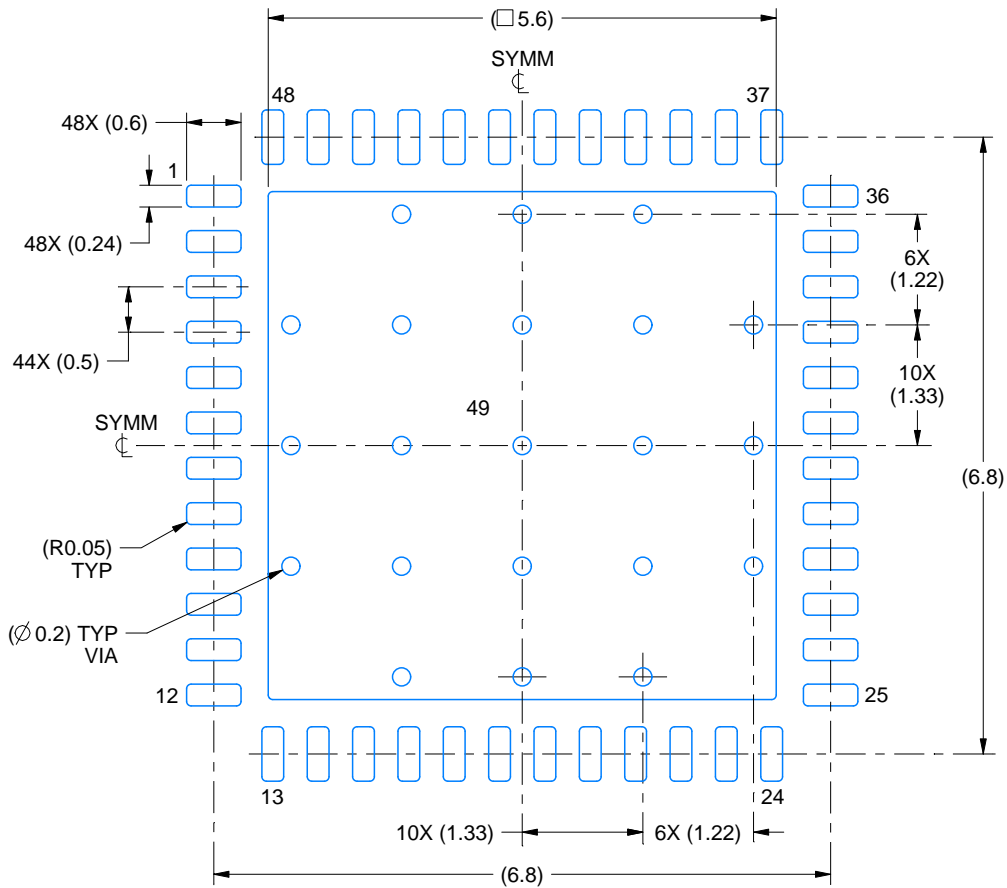
1. All linear dimensions are in millimeters. Any dimensions in parenthesis are for reference only. Dimensioning and tolerancing per ASME Y14.5M.
2. This drawing is subject to change without notice.
3. The package thermal pad must be soldered to the printed circuit board for thermal and mechanical performance.

# EXAMPLE BOARD LAYOUT

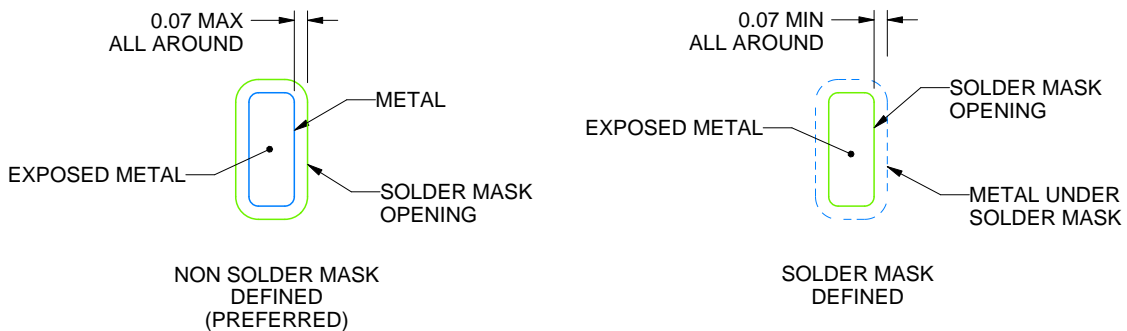
**RGZ0048D**

**VQFN - 1 mm max height**

PLASTIC QUAD FLATPACK - NO LEAD



**LAND PATTERN EXAMPLE**  
EXPOSED METAL SHOWN  
SCALE:12X



**SOLDER MASK DETAILS**

4219046/B 11/2019

NOTES: (continued)

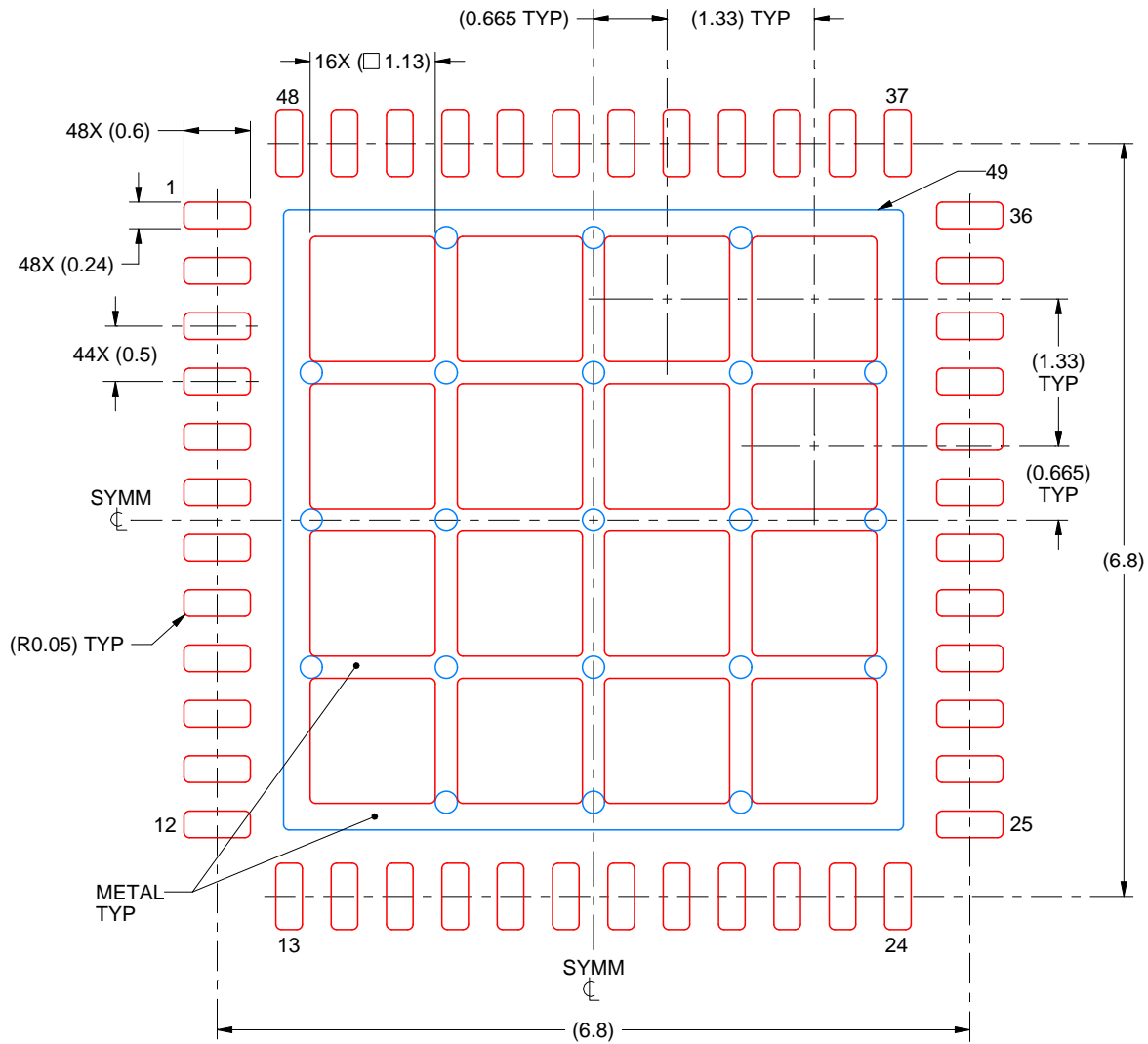
4. This package is designed to be soldered to a thermal pad on the board. For more information, see Texas Instruments literature number SLUA271 ([www.ti.com/lit/sluea271](http://www.ti.com/lit/sluea271)).
5. Vias are optional depending on application, refer to device data sheet. If any vias are implemented, refer to their locations shown on this view. It is recommended that vias under paste be filled, plugged or tented.

# EXAMPLE STENCIL DESIGN

RGZ0048D

VQFN - 1 mm max height

PLASTIC QUAD FLATPACK - NO LEAD



**SOLDER PASTE EXAMPLE**  
 BASED ON 0.125 mm THICK STENCIL

EXPOSED PAD 49  
 66% PRINTED SOLDER COVERAGE BY AREA UNDER PACKAGE  
 SCALE:15X

4219046/B 11/2019

NOTES: (continued)

- 6. Laser cutting apertures with trapezoidal walls and rounded corners may offer better paste release. IPC-7525 may have alternate design recommendations.

## 重要なお知らせと免責事項

TI は、技術データと信頼性データ (データシートを含みます)、設計リソース (リファレンス・デザインを含みます)、アプリケーションや設計に関する各種アドバイス、Web ツール、安全性情報、その他のリソースを、欠陥が存在する可能性のある「現状のまま」提供しており、商品性および特定目的に対する適合性の黙示保証、第三者の知的財産権の非侵害保証を含むいかなる保証も、明示的または黙示的にかかわらず拒否します。

これらのリソースは、TI 製品を使用する設計の経験を積んだ開発者への提供を意図したものです。(1) お客様のアプリケーションに適した TI 製品の選定、(2) お客様のアプリケーションの設計、検証、試験、(3) お客様のアプリケーションに該当する各種規格や、その他のあらゆる安全性、セキュリティ、規制、または他の要件への確実な適合に関する責任を、お客様のみが単独で負うものとし、

上記の各種リソースは、予告なく変更される可能性があります。これらのリソースは、リソースで説明されている TI 製品を使用するアプリケーションの開発の目的でのみ、TI はその使用をお客様に許諾します。これらのリソースに関して、他の目的で複製することや掲載することは禁止されています。TI や第三者の知的財産権のライセンスが付与されている訳ではありません。お客様は、これらのリソースを自身で使用した結果発生するあらゆる申し立て、損害、費用、損失、責任について、TI およびその代理人を完全に補償するものとし、TI は一切の責任を拒否します。

TI の製品は、[TI の販売条件](#)、または [ti.com](#) やかかる TI 製品の関連資料などのいずれかを通じて提供する適用可能な条項の下で提供されています。TI がこれらのリソースを提供することは、適用される TI の保証または他の保証の放棄の拡大や変更を意味するものではありません。

お客様がいかなる追加条項または代替条項を提案した場合でも、TI はそれらに異議を唱え、拒否します。

郵送先住所 : Texas Instruments, Post Office Box 655303, Dallas, Texas 75265  
Copyright © 2024, Texas Instruments Incorporated