

TLV7081 Nano-Power、4バンプWCSPの小型コンパレータ

1 特長

- 広い電源電圧範囲: 1.7V ~ 5.5V
- 静止消費電流: 370nA
- 短い伝搬遅延: 4μs
- オープン・ドレイン出力
- 最高5.6Vの独立した入力電圧範囲
- 内部ヒステリシス: 10mV
- 温度範囲: -40°C ~ +125°C
- パッケージ
 - 0.7mmx0.7mm WCSP (4)

2 アプリケーション

- スマートフォン
- ノートPCおよびタブレット
- 光モジュール
- デジタル・カメラ
- リレーおよびサーキット・ブレーカ
- ポータブル医療機器
- ドアまたは窓のセンサ
- ビデオゲーム・コントローラ

3 概要

TLV7081はシングル・チャンネルのnano-powerコンパレータで、最低1.7Vで動作します。このコンパレータは超小型の0.7mmx0.7mm WCSPパッケージで供給されるため、TLV7081はスマートフォンや他の携帯用またはバッテリー駆動アプリケーションのような、スペースに制約のある設計に適しています。

TLV7081は、電源電圧と独立した広い入力電圧範囲が特長です。入力範囲が電源電圧と独立しているため、TLV7081の電源がオフのときでもアクティブであるソースにも直接接続可能です。

TLV7081にはオープン・ドレインの出力段があり、 V_+ を超える出力レベルが可能であるため、レベル変換器やバイポーラからシングルエンドへのコンバータに適切です。

製品情報 (1)

型番	パッケージ	本体サイズ (公称)
TLV7081	WCSP (4)	0.7mmx0.7mm

小型、低消費電力のコンパレータ・ファミリ

ファミリ	I_Q /チャンネル	t_{PD}	出力方式	パッケージ
TLV7081	370nA	4μs	オープンドレイン	WCSP
TLV7031	335nA	3μs	プッシュプル	X2SON
TLV7041	335nA	3μs	オープンドレイン	X2SON
TLV7011	5μA	260ns	プッシュプル	X2SON
TLV7021	5μA	260ns	オープンドレイン	X2SON

(1) 利用可能なすべてのパッケージについては、このデータシートの末尾にあるパッケージ・オプションについての付録を参照してください。

低電圧の検出

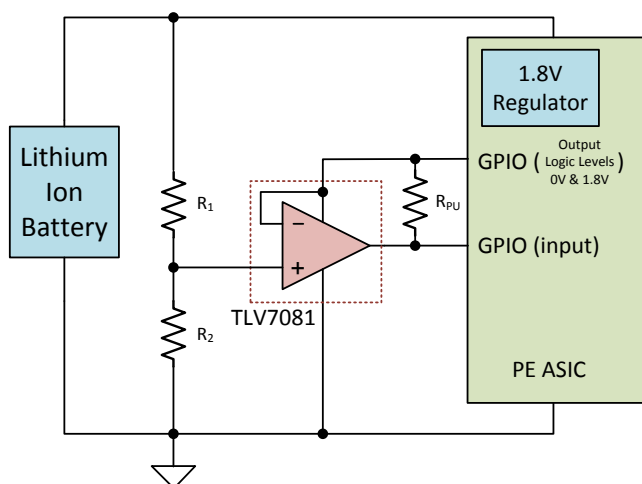

I_S と電源電圧との関係

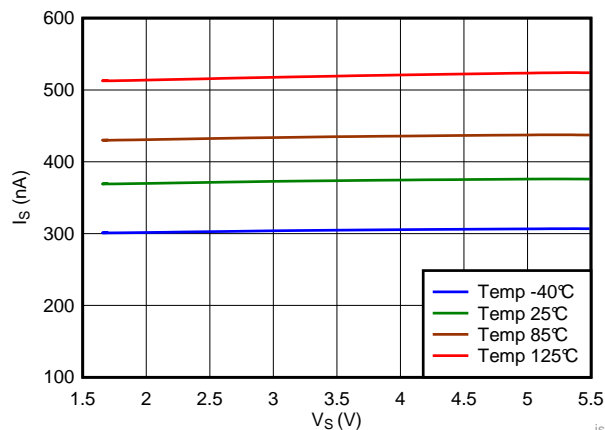

目次

1	特長	1	7.3	Feature Description.....	10
2	アプリケーション	1	7.4	Device Functional Modes.....	10
3	概要	1	8	Application and Implementation	12
4	改訂履歴	2	8.1	Application Information.....	12
5	Pin Configuration and Functions	3	8.2	Typical Applications	12
6	Specifications	4	9	Layout	14
6.1	Absolute Maximum Ratings	4	9.1	Layout Guidelines	14
6.2	ESD Ratings.....	4	9.2	Layout Example	14
6.3	Recommended Operating Conditions.....	4	10	デバイスおよびドキュメントのサポート	15
6.4	Thermal Information	4	10.1	ドキュメントのサポート	15
6.5	Electrical Characteristics.....	5	10.2	ドキュメントの更新通知を受け取る方法	15
6.6	Switching Characteristics	5	10.3	コミュニティ・リソース.....	15
6.7	Timing Diagrams	6	10.4	Trademarks	15
6.8	Typical Characteristics	7	10.5	Electrostatic Discharge Caution.....	15
7	Detailed Description	10	10.6	Glossary	15
7.1	Overview	10	11	メカニカル、パッケージ、および注文情報	15
7.2	Functional Block Diagram	10			

4 改訂履歴

2017年12月発行のものから更新

Page

•	事前情報から量産データに変更	1
•	Added note to the <i>Timing Diagrams</i> section	6

5 Pin Configuration and Functions

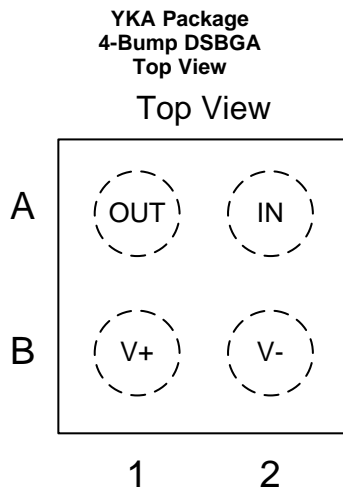

Pin Functions

PIN		I/O	DESCRIPTION
NAME	Number		
OUT	A1	O	Comparator output: OUT is open-drain.
V+	B1	P	Positive (highest) power supply; functions as an external reference voltage
V-	B2	P	Negative (lowest) power supply
IN	A2	I	Comparator input: IN is the noninverting input

6 Specifications

6.1 Absolute Maximum Ratings

over operating free-air temperature range (unless otherwise noted)⁽¹⁾

	MIN	MAX	UNIT
Supply voltage $V_S = (V+) - (V-)$	- 0.3	6	V
Input (IN) to (V-) ⁽²⁾	- 0.3	6	V
Current into input (IN)		±10	mA
Output (OUT) to (V-)	- 0.3	6	V
Output short-circuit duration ⁽³⁾		10	s
Junction temperature, T_J		150	°C
Storage temperature, T_{stg}	- 65	150	°C

- (1) Stresses beyond those listed under *Absolute Maximum Ratings* may cause permanent damage to the device. These are stress ratings only, which do not imply functional operation of the device at these or any other conditions beyond those indicated under *Recommended Operating Conditions*. Exposure to absolute-maximum-rated conditions for extended periods may affect device reliability.
- (2) Input signals that can swing more than 0.3 V below (V-) must be current-limited to 10 mA or less.
- (3) Short-circuit to ground, one comparator per package.

6.2 ESD Ratings

		VALUE	UNIT
$V_{(ESD)}$	Electrostatic discharge	Human-body model (HBM), per ANSI/ESDA/JEDEC JS-001 ⁽¹⁾	±1500
		Charged-device model (CDM), per JEDEC specification JESD22-C101 ⁽²⁾	±500

- (1) JEDEC document JEP155 states that 500-V HBM allows safe manufacturing with a standard ESD control process.
- (2) JEDEC document JEP157 states that 250-V CDM allows safe manufacturing with a standard ESD control process.

6.3 Recommended Operating Conditions

over operating free-air temperature range (unless otherwise noted)

	MIN	MAX	UNIT
Supply voltage $V_S = (V+) - (V-)$	1.7	5.5	V
Open-Drain PULL-UP voltage $V_{PULL-UP}$		5.5	V
Ambient temperature, T_A	-40	125	°C

6.4 Thermal Information

THERMAL METRIC ⁽¹⁾		TLV7081	UNIT
		YKA (DSBGA)	
		4 PINS	
$R_{\theta JA}$	Junction-to-ambient thermal resistance	207	°C/W
$R_{\theta JC(top)}$	Junction-to-case (top) thermal resistance	1.8	°C/W
$R_{\theta JB}$	Junction-to-board thermal resistance	73.2	°C/W
Ψ_{JT}	Junction-to-top characterization parameter	1	°C/W
Ψ_{JB}	Junction-to-board characterization parameter	73.3	°C/W

- (1) For more information about traditional and new thermal metrics, see the [Semiconductor and IC Package Thermal Metrics](#) application report.

6.5 Electrical Characteristics

Over the operating temperature range of $T_A = -40^\circ\text{C}$ to $+125^\circ\text{C}$, $V_S = 3.3\text{ V}$, and $V_{\text{PULL-UP}} = V+$ (unless otherwise noted). Typical values are at $T_A = 25^\circ\text{C}$. Voltage at input pin (IN) is referenced to (V-).

PARAMETER	TEST CONDITIONS	MIN	TYP	MAX	UNIT
V_{IO}	Input Offset Voltage $V_S = 1.8\text{ V}$ and 3.3 V , $T_A = -40^\circ\text{C}$ to $+125^\circ\text{C}$	-10	± 1	10	mV
dV_{IO}/dT	Input Offset Voltage Drift $T_A = -40^\circ\text{C}$ to $+125^\circ\text{C}$		± 3		$\mu\text{V}/^\circ\text{C}$
V_{HYS}	Input Hysteresis Voltage		10		mV
V_{IN}	Input Voltage Range ⁽¹⁾	0		5.6	V
I_{BIAS}	Input bias current IN = 5.6 V, positive value means current entering pin (IN)		3		μA
I_{LEAK}	Input leakage current IN = 5.6 V, $V_S = 0\text{ V}$, positive value means current entering pin (IN)		4		μA
C_{I}	Input Capacitance		1.9		pF
V_{OL}	Low-Level Output Voltage Sinking 200 μA , measured relative to (V-)			0.1	V
	Sinking 2 mA, measured relative to (V-)			0.4	V
$I_{\text{O-SC}}$	Short-circuit sink current $V_S = 5\text{ V}$		45		mA
$I_{\text{O-LKG}}$	Output Leakage Current IN = (V+) + 0.1V (output high), $V_{\text{PULL-UP}} = (V+)$		130		μA
PSRR	Power Supply Rejection Ratio $V_S = 1.8\text{ V}$ to 5 V		75		dB
I_{S}	Supply Current no load, IN = (V+) – 0.1V (output low), $T_A = 25^\circ\text{C}$		370	470	nA
	no load, IN = (V+) – 0.1V (output low), $T_A = -40^\circ\text{C}$ to $+125^\circ\text{C}$			630	

(1) Over Operating Supply Voltage Range (V_S): 1.7 V to 5.5 V

6.6 Switching Characteristics

Typical values are at $T_A = 25^\circ\text{C}$, $V_S = 3.3\text{ V}$; $C_L = 15\text{ pF}$, (unless otherwise noted)

PARAMETER	TEST CONDITIONS	MIN	TYP	MAX	UNIT
t_{PHL}	High-to-low propagation delay ⁽¹⁾ Input overdrive = -100 mV		4		μs
t_{PLH}	Low-to-high propagation delay ⁽¹⁾ Input overdrive = +100 mV, $R_{\text{PULL-UP}} = 4.99\text{ k}\Omega$		4		μs
t_{F}	Output fall time Measured from 20% to 80%		7		ns
t_{ON}	Start-up delay ⁽²⁾		1		ms

(1) High-to-low and low-to-high refers to the transition at the input pin (IN).

(2) During power on, V_S must exceed 1.7 V for 1 ms before the output is in a correct state.

6.7 Timing Diagrams

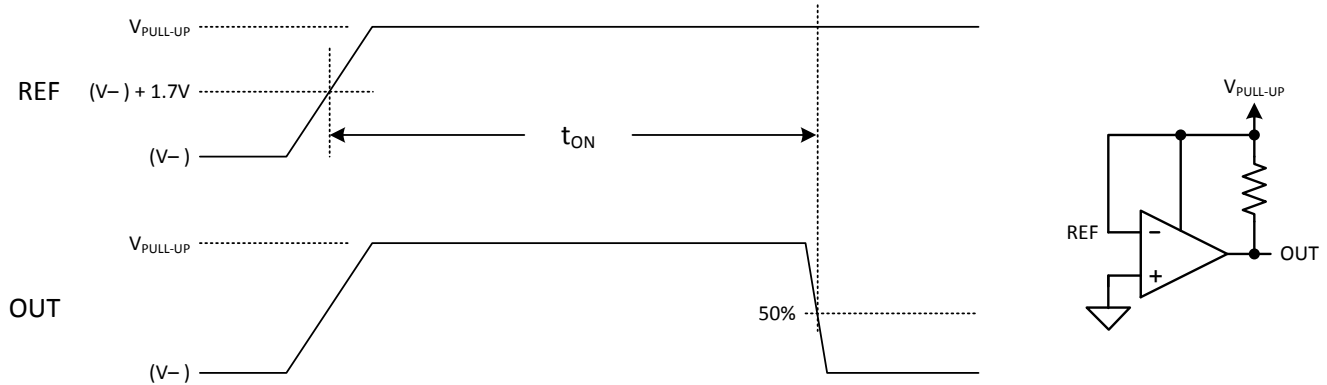

Figure 1. Start-up Delay

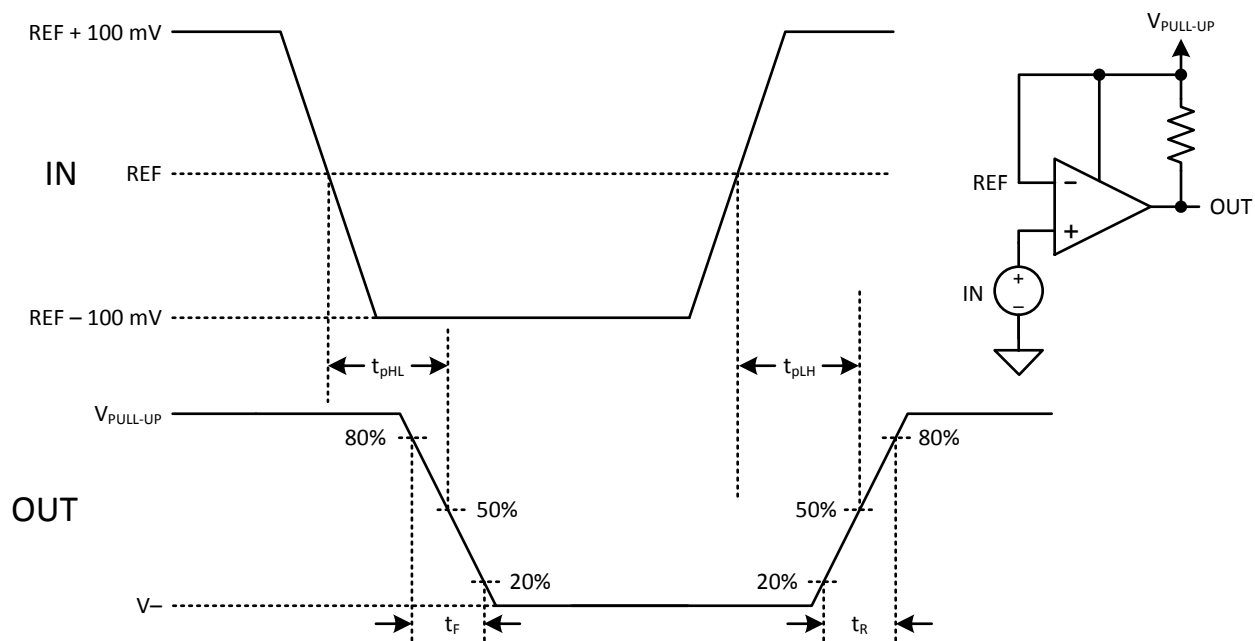

Figure 2. Timing Diagram

NOTE

The propagation delays t_{pLH} and t_{pHL} include the contribution of input offset and hysteresis.

6.8 Typical Characteristics

$T_A = 25^\circ\text{C}$, $V_S = 3.3\text{ V}$, $R_{\text{PULL-UP}} = 4.99\text{ k}\Omega$, $C_L = 15\text{ pF}$

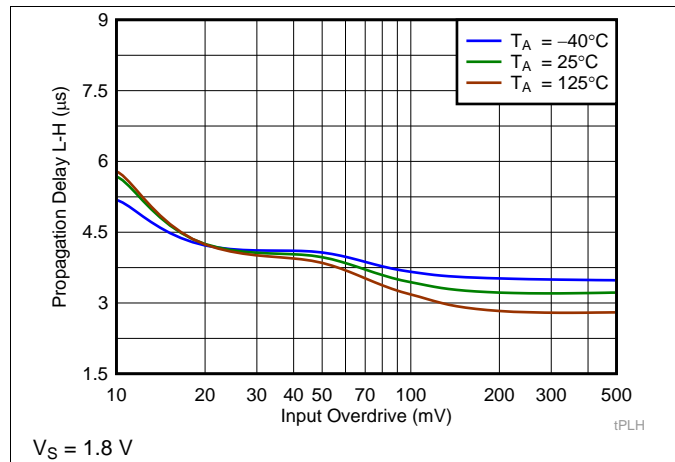

Figure 3. Propagation Delay (L-H) vs. Input Overdrive

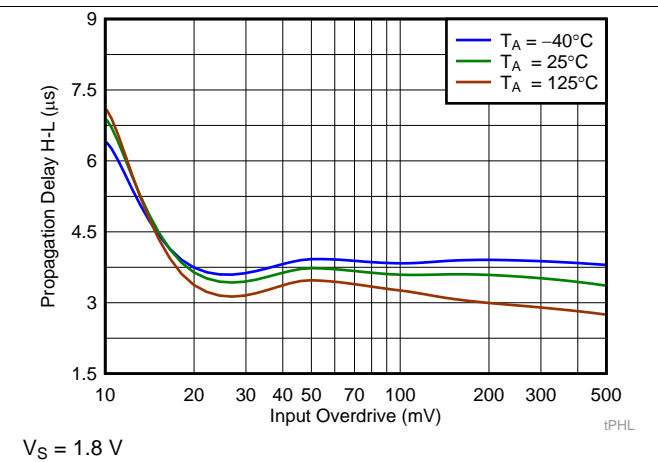

Figure 4. Propagation Delay (H-L) vs. Input Overdrive

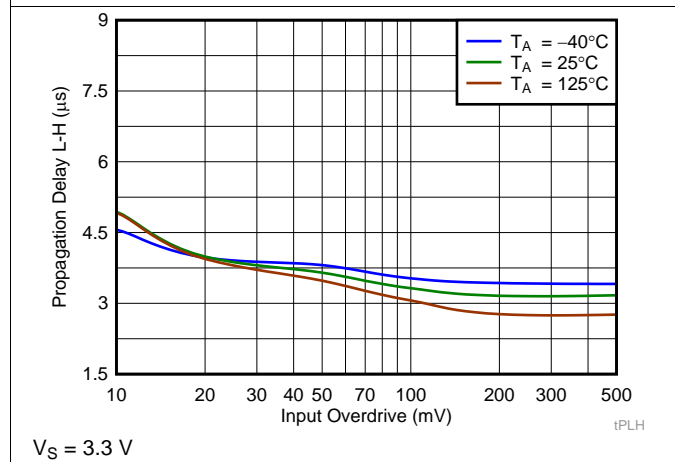

Figure 5. Propagation Delay (L-H) vs. Input Overdrive

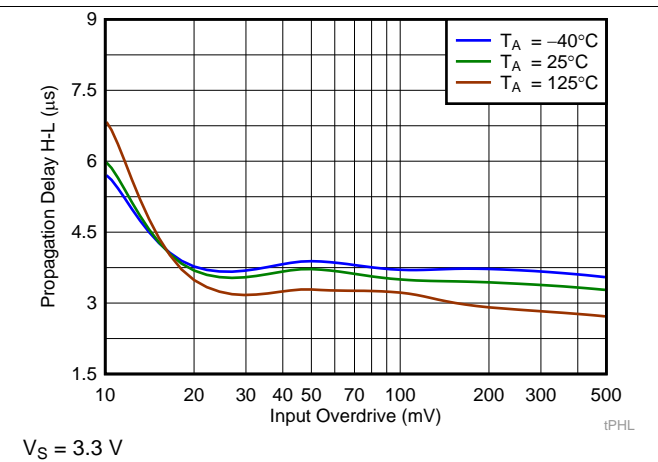

Figure 6. Propagation Delay (H-L) vs. Input Overdrive

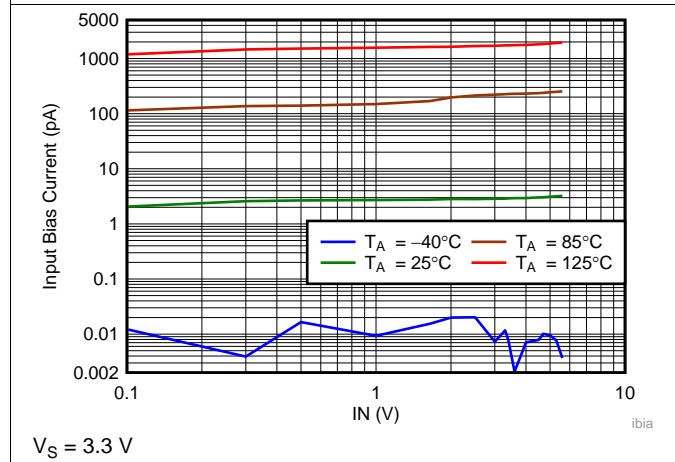

Figure 7. Input Bias Current vs. I_N

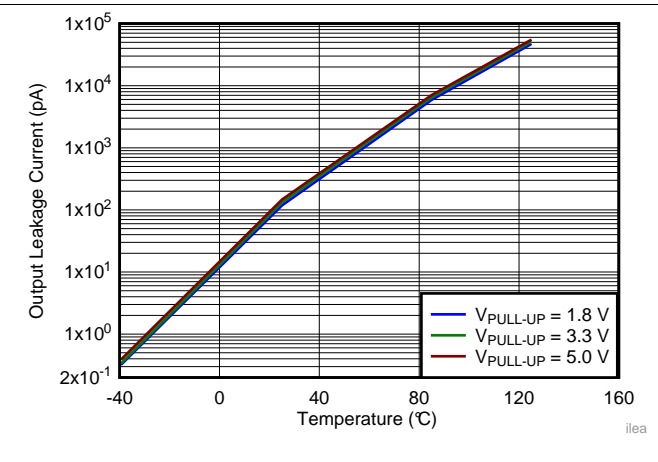

Figure 8. Output Leakage Current vs. Temperature

Typical Characteristics (continued)

$T_A = 25^\circ\text{C}$, $V_S = 3.3\text{ V}$, $R_{\text{PULL-UP}} = 4.99\text{ k}\Omega$, $C_L = 15\text{ pF}$

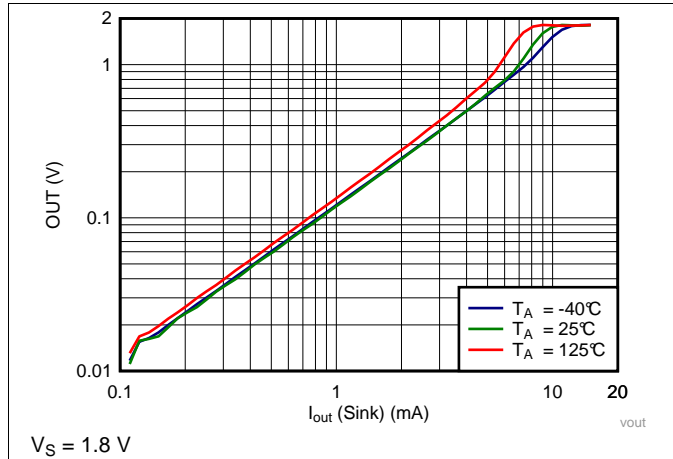

Figure 9. Output Voltage Low vs. Output Sink Current

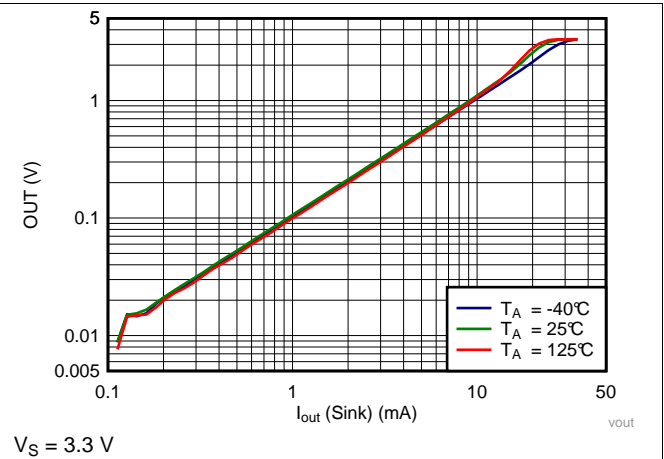

Figure 10. Output Voltage Low vs. Output Sink Current

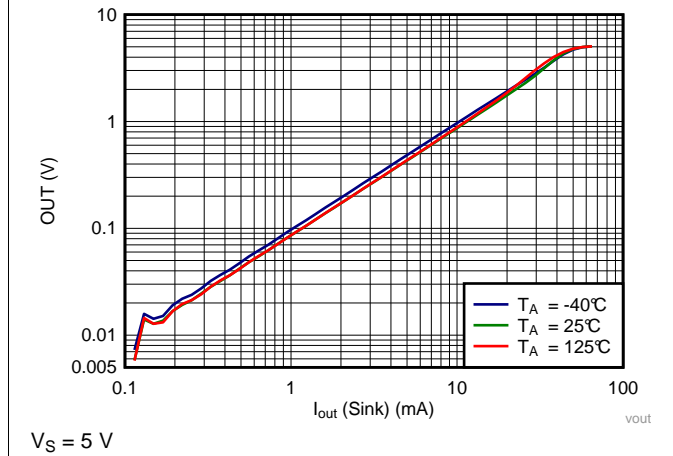

Figure 11. Output Voltage Low vs. Output Sink Current

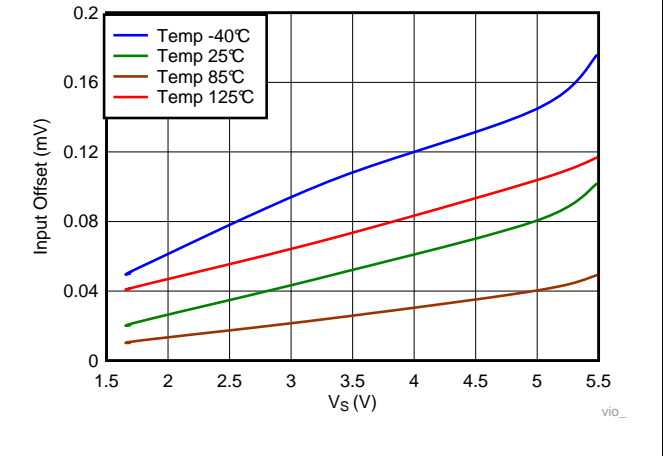

Figure 12. Input Offset vs. V_S

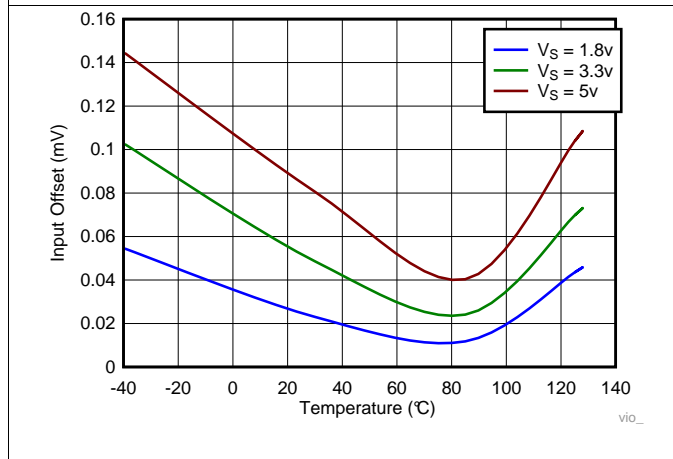

Figure 13. Input Offset vs. Temperature

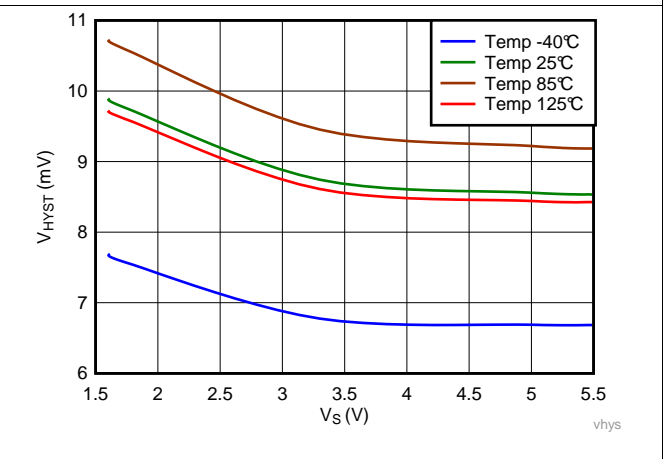

Figure 14. Hysteresis vs V_S

Typical Characteristics (continued)

$T_A = 25^\circ\text{C}$, $V_S = 3.3\text{ V}$, $R_{\text{PULL-UP}} = 4.99\text{ k}\Omega$, $C_L = 15\text{ pF}$

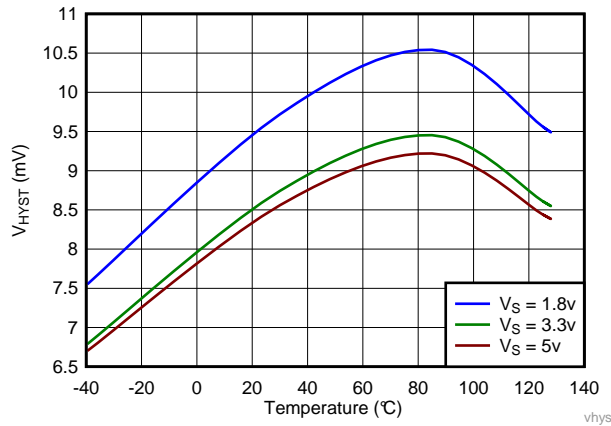
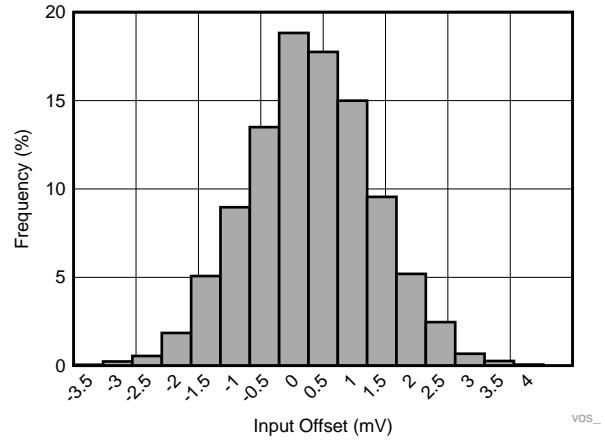
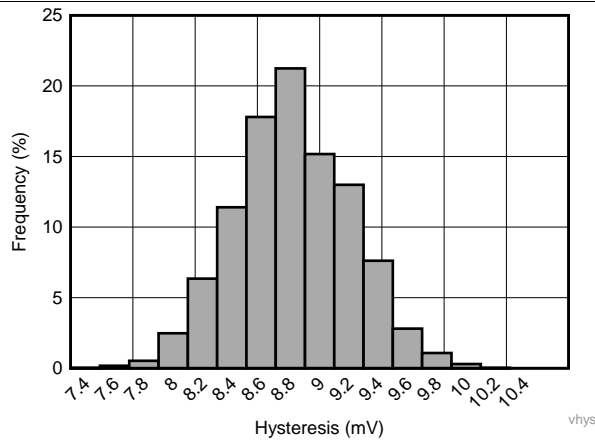

Figure 15. Hysteresis vs. Temperature



Distribution Taken from 7,990 Comparators

Figure 16. Input Offset Histogram



Distribution Taken from 7,990 Comparators

Figure 17. Hysteresis Histogram

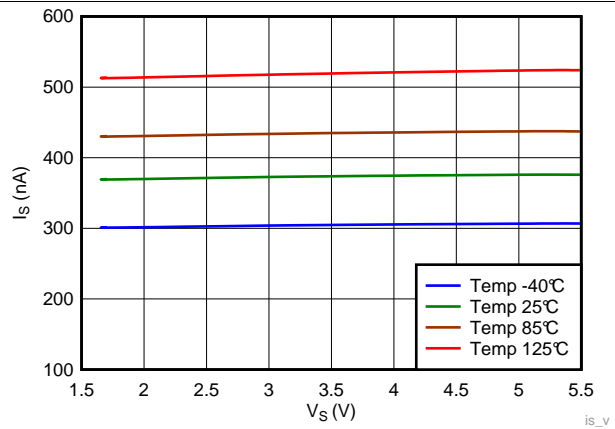

$I_N = (V_+) - 0.1\text{V}$ (output low), No load.

Figure 18. Supply Current vs. V_S

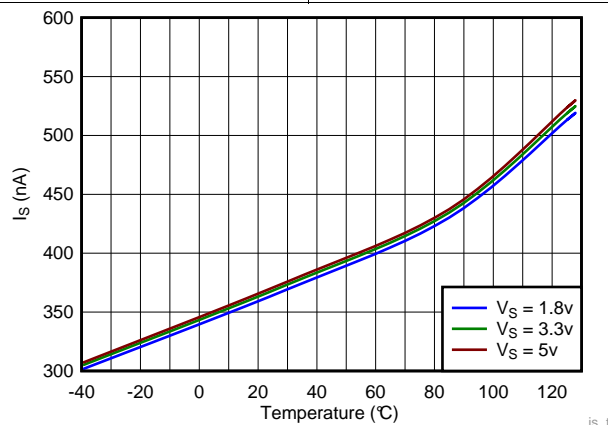

$I_N = (V_+) - 0.1\text{V}$ (output low), No load.

Figure 19. Supply Current vs. Temperature

7 Detailed Description

7.1 Overview

The TLV7081 is a single-channel, nano-power comparator that does not need a dedicated power supply connection, and can operate down to 1.7 V. The comparator is available in an ultra-small, WCSP package measuring 0.7 mm × 0.7 mm, making the TLV7081 applicable for space-critical designs like smartphones and other portable or battery-powered applications.

The TLV7081 features a wide input-voltage range that is independent of supply voltage. Having an input range that is independent of supply voltage allows the TLV7081 to be directly connected to sources that are active even if the TLV7081 is not powered.

The TLV7081 has an open-drain output stage that can be pulled beyond $V+$, making it appropriate for level translators and bipolar to single-ended converters.

7.2 Functional Block Diagram

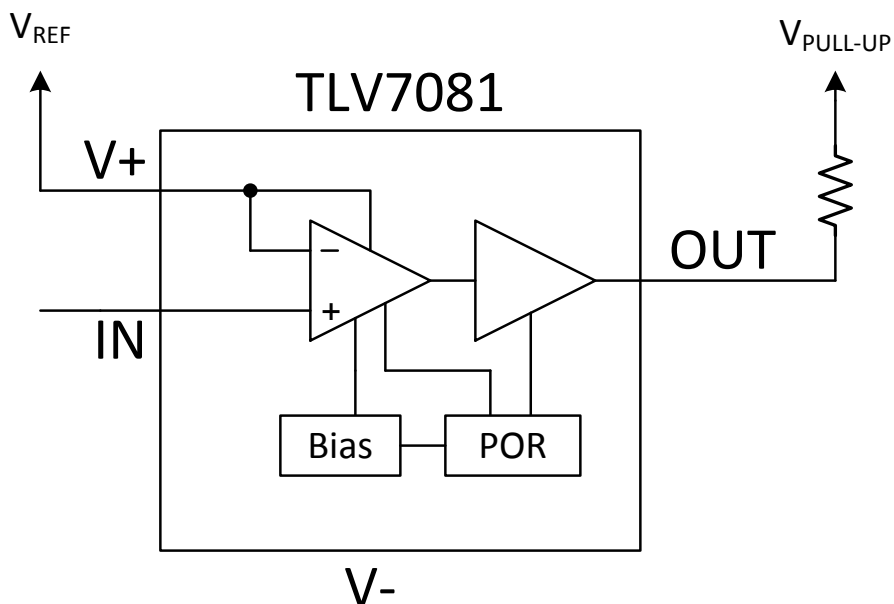

7.3 Feature Description

The TLV7081 is a single-channel, nano-power comparator that operates down to 1.7 V. The inverting input is internally tied to $V+$ which helps to streamline applications which use supply as the reference. The non-inverting input IN extends to 5.6 V which is independent of the power supply $V+$ (1.7 V - 5.5 V) and it's available in an ultra-small, WCSP package measuring 0.7 mm × 0.7 mm.

7.4 Device Functional Modes

The TLV7081 has a power-on-reset (POR) circuit. While the power supply (V_S) is greater than V_{POR} (typically 1V) and less than the minimum operating supply voltage, either upon ramp-up or ramp-down, the POR circuitry is activated.

The POR circuit keeps the output high impedance (logical high) while activated.

When the supply voltage is greater than, or equal to, the minimum supply voltage, the comparator output reflects the state of the input IN.

Device Functional Modes (continued)

7.4.1 Inputs

The TLV7081 input extends from V_- to 5.6 V which is independent of supply. The input IN can be any voltage within these limits and no phase inversion of the comparator output occurs.

The input of TLV7081 is fault tolerant. It maintains the same high input impedance when V_+ is unpowered or ramping up. The input can be safely driven up to the specified maximum voltage (5.6 V) with $V_+ = 0$ V or any value up to the maximum specified.

The input bias current is typically 3 pA for input IN voltages between 0 and 5.6 V. The comparator inputs are protected from undervoltage by internal diodes connected to V_- . As the input voltage goes under V_- , the protection diodes become forward biased and begin to conduct causing the input bias current to increase exponentially. Input bias current typically doubles for every 10°C temperature increase.

7.4.2 Internal Hysteresis

The device hysteresis transfer curve is shown in Figure 20. This curve is a function of three components: V_{TH} , V_{OS} , and V_{HYST} :

- V_{TH} is the actual set voltage or threshold trip voltage.
- V_{OS} is the internal offset voltage between IN and V_+ . This voltage is added to V_{TH} to form the actual trip point at which the comparator must respond to change output states.
- V_{HYST} is the internal hysteresis (or trip window) that is designed to reduce comparator sensitivity to noise (10 mV typical).

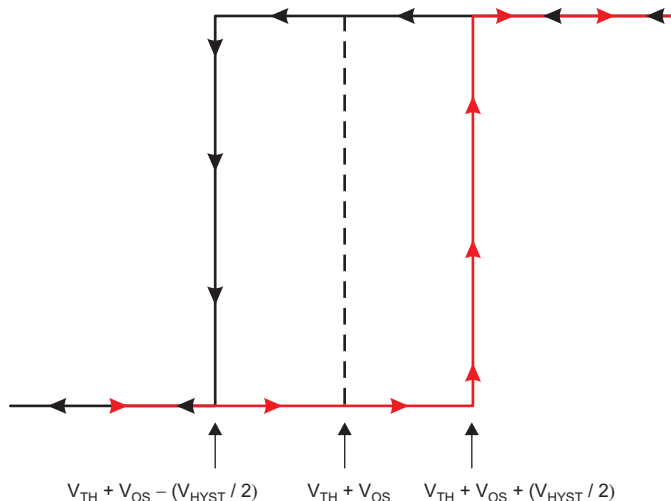

Figure 20. Hysteresis Transfer Curve

7.4.3 Output

The TLV7081 features an open-drain output stage enabling the output logic levels to be pulled up to an external source up to 5.5 V independently of the supply voltage.

8 Application and Implementation

NOTE

Information in the following applications sections is not part of the TI component specification, and TI does not warrant its accuracy or completeness. TI's customers are responsible for determining suitability of components for their purposes. Customers should validate and test their design implementation to confirm system functionality.

8.1 Application Information

The TLV7081 is a 4-pin, nano-power comparator with open-drain output that is well suited for monitoring battery voltages. The TLV7081's benefits include a small package footprint and a unique input stage that allows the comparator input to be driven by a voltage source even when the operating voltage for the comparator is turned-off (zero volts).

8.2 Typical Applications

8.2.1 Nano-Power Battery Monitor

The application of the TLV7081 for an under-voltage detection circuit is shown in [Figure 21](#).

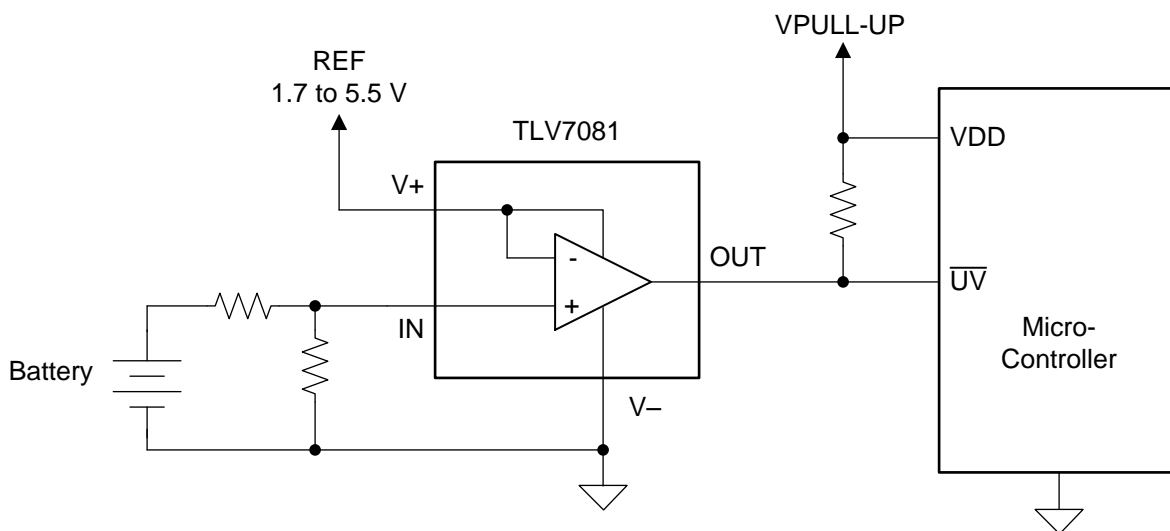

Copyright © 2017, Texas Instruments Incorporated

Figure 21. Under-Voltage Detection

8.2.1.1 Design Requirements

For this design, follow these design requirements:

- The supply voltage connected to pin (V+) serves as the reference voltage for the comparator and can be any voltage between 1.7 V and 5.5 V.
- The voltage applied to the input pin (IN) can be any voltage in the range of 0 V to 5.6 V. This voltage range is uniquely independent of the supply voltage applied to pin (V+).
- The comparator output pin (OUT) requires a pull-up resistor that sets the output-high logic level (V_{OH}) for the comparator. $V_{PULL-UP}$ should be connected to the supply voltage of the microcontroller which is monitoring the comparator output and serves as the level-shifting block for the logic levels in the application.

Typical Applications (continued)

8.2.1.2 Detailed Design Procedure

Instead of being powered directly from the battery, the TLV7081 is powered directly from a voltage reference that exists in the system. The input to the comparator (IN) is allowed to operate above and below the reference voltage due to the unique analog front end of the TLV7081. When the battery voltage is above the reference threshold, the output of the comparator is high and when the battery drops below the threshold of the reference, the output of the comparator goes low (see Figure 22 for details). For simplicity, the integrated hysteresis of the comparator is not shown in the timing diagram. Integrated hysteresis is helpful in avoiding glitches at the comparator output when operating in noisy environments or when the input voltage changes thresholds very slowly. An open-drain output configuration allows the output logic level of the comparator to be level-shifted to match the logic level of the receiving device.

8.2.1.3 Application Curve

When the voltage applied to the input pin (IN) falls below the reference threshold (REF), the output pin (OUT) is pulled low to ground (V-). Moreover, when the input voltage rises above REF, the output of the comparator goes into a high impedance state and the OUT pin is pulled high by the pull-up resistor and $V_{PULL-UP}$ supply voltage.

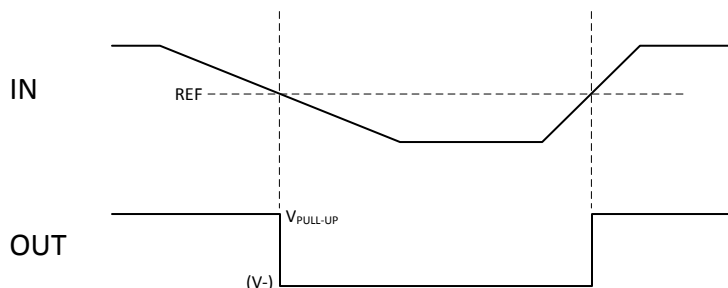

Figure 22. Under-Voltage Timing Results

8.2.2 Battery Monitoring in Portable Electronics

A recommended circuit diagram for monitoring a battery voltage in a personal electronic device is shown in Figure 23. In this diagram, the GPIO pin of an application specific integrated circuit (ASIC) serves as the supply voltage and the voltage reference for the TLV7081. Using a GPIO pin to power the TLV7081 is possible because of the low quiescent current of the TLV7081. In systems where power consumption needs to be further reduced, the GPIO pin can be used to power-cycle the TLV7081.

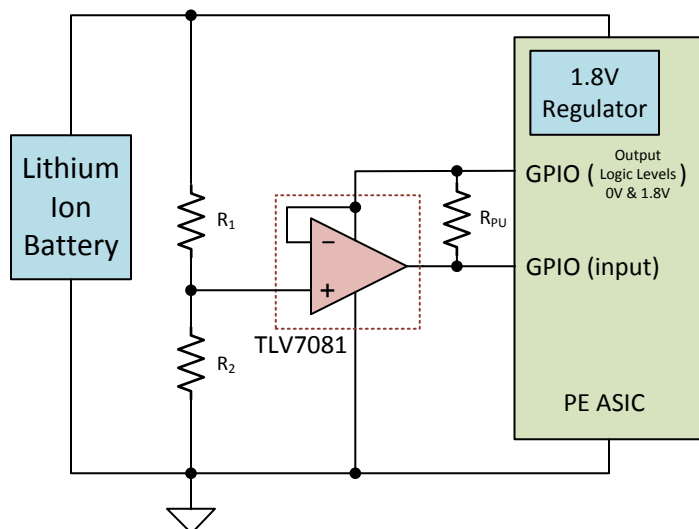

Figure 23. Battery Monitor

9 Layout

9.1 Layout Guidelines

A power supply bypass capacitor of 100 nF is recommended when supply output impedance is high, supply traces are long, or when excessive noise is expected on the supply lines. Bypass capacitors are also recommended when the comparator output drives a long trace or is required to drive a capacitive load. Due to the fast rising and falling edge rates and high-output sink and source capability of the TLV7081 output stages, higher than normal quiescent current can be drawn from the power supply. Under this circumstance, the system would benefit from a bypass capacitor across the supply pins.

9.2 Layout Example

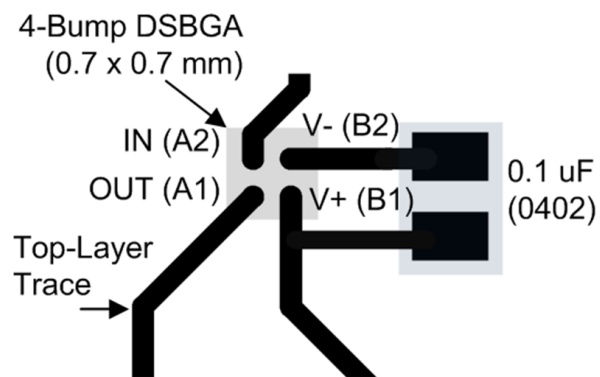

Figure 24. Layout Example

10 デバイスおよびドキュメントのサポート

10.1 ドキュメントのサポート

10.1.1 関連資料

関連資料については、以下を参照してください。

- [TLV7081](#)
- [TLV7031](#)
- [TLV7041](#)
- [TLV7011](#)
- [TLV7021](#)

10.2 ドキュメントの更新通知を受け取る方法

ドキュメントの更新についての通知を受け取るには、ti.comのデバイス製品フォルダを開いてください。右上の隅にある「通知を受け取る」をクリックして登録すると、変更されたすべての製品情報に関するダイジェストを毎週受け取れます。変更の詳細については、修正されたドキュメントに含まれている改訂履歴をご覧ください。

10.3 コミュニティ・リソース

The following links connect to TI community resources. Linked contents are provided "AS IS" by the respective contributors. They do not constitute TI specifications and do not necessarily reflect TI's views; see TI's [Terms of Use](#).

TI E2E™オンライン・コミュニティ *TIのE2E (Engineer-to-Engineer) コミュニティ*。エンジニア間の共同作業を促進するために開設されたものです。e2e.ti.comでは、他のエンジニアに質問し、知識を共有し、アイデアを検討して、問題解決に役立てることができます。

設計サポート *TIの設計サポート* 役に立つE2Eフォーラムや、設計サポート・ツールをすばやく見つけることができます。技術サポート用の連絡先情報も参照できます。

10.4 Trademarks

E2E is a trademark of Texas Instruments.

All other trademarks are the property of their respective owners.

10.5 Electrostatic Discharge Caution



This integrated circuit can be damaged by ESD. Texas Instruments recommends that all integrated circuits be handled with appropriate precautions. Failure to observe proper handling and installation procedures can cause damage.

ESD damage can range from subtle performance degradation to complete device failure. Precision integrated circuits may be more susceptible to damage because very small parametric changes could cause the device not to meet its published specifications.

10.6 Glossary

[SLYZ022](#) — *TI Glossary*.

This glossary lists and explains terms, acronyms, and definitions.

11 メカニカル、パッケージ、および注文情報

以降のページには、メカニカル、パッケージ、および注文に関する情報が記載されています。この情報は、そのデバイスについて利用可能な最新のデータです。このデータは予告なく変更されることがあり、ドキュメントが改訂される場合もあります。本データシートのブラウザ版を使用されている場合は、画面左側の説明をご覧ください。

PACKAGING INFORMATION

Orderable Device	Status (1)	Package Type	Package Drawing	Pins	Package Qty	Eco Plan (2)	Lead finish/ Ball material (6)	MSL Peak Temp (3)	Op Temp (°C)	Device Marking (4/5)	Samples
TLV7081YKAR	ACTIVE	DSBGA	YKA	4	3000	RoHS & Green	SAC396 SNAGCU	Level-1-260C-UNLIM	-40 to 125	W	Samples

(1) The marketing status values are defined as follows:

ACTIVE: Product device recommended for new designs.

LIFEBUY: TI has announced that the device will be discontinued, and a lifetime-buy period is in effect.

NRND: Not recommended for new designs. Device is in production to support existing customers, but TI does not recommend using this part in a new design.

PREVIEW: Device has been announced but is not in production. Samples may or may not be available.

OBSOLETE: TI has discontinued the production of the device.

(2) **RoHS:** TI defines "RoHS" to mean semiconductor products that are compliant with the current EU RoHS requirements for all 10 RoHS substances, including the requirement that RoHS substance do not exceed 0.1% by weight in homogeneous materials. Where designed to be soldered at high temperatures, "RoHS" products are suitable for use in specified lead-free processes. TI may reference these types of products as "Pb-Free".

RoHS Exempt: TI defines "RoHS Exempt" to mean products that contain lead but are compliant with EU RoHS pursuant to a specific EU RoHS exemption.

Green: TI defines "Green" to mean the content of Chlorine (Cl) and Bromine (Br) based flame retardants meet JS709B low halogen requirements of <=1000ppm threshold. Antimony trioxide based flame retardants must also meet the <=1000ppm threshold requirement.

(3) MSL, Peak Temp. - The Moisture Sensitivity Level rating according to the JEDEC industry standard classifications, and peak solder temperature.

(4) There may be additional marking, which relates to the logo, the lot trace code information, or the environmental category on the device.

(5) Multiple Device Markings will be inside parentheses. Only one Device Marking contained in parentheses and separated by a "-" will appear on a device. If a line is indented then it is a continuation of the previous line and the two combined represent the entire Device Marking for that device.

(6) Lead finish/Ball material - Orderable Devices may have multiple material finish options. Finish options are separated by a vertical ruled line. Lead finish/Ball material values may wrap to two lines if the finish value exceeds the maximum column width.

Important Information and Disclaimer:The information provided on this page represents TI's knowledge and belief as of the date that it is provided. TI bases its knowledge and belief on information provided by third parties, and makes no representation or warranty as to the accuracy of such information. Efforts are underway to better integrate information from third parties. TI has taken and continues to take reasonable steps to provide representative and accurate information but may not have conducted destructive testing or chemical analysis on incoming materials and chemicals. TI and TI suppliers consider certain information to be proprietary, and thus CAS numbers and other limited information may not be available for release.

In no event shall TI's liability arising out of such information exceed the total purchase price of the TI part(s) at issue in this document sold by TI to Customer on an annual basis.

TAPE AND REEL INFORMATION



QUADRANT ASSIGNMENTS FOR PIN 1 ORIENTATION IN TAPE



*All dimensions are nominal

Device	Package Type	Package Drawing	Pins	SPQ	Reel Diameter (mm)	Reel Width W1 (mm)	A0 (mm)	B0 (mm)	K0 (mm)	P1 (mm)	W (mm)	Pin1 Quadrant
TLV7081YKAR	DSBGA	YKA	4	3000	180.0	8.4	0.8	0.8	0.47	4.0	8.0	Q1
TLV7081YKAR	DSBGA	YKA	4	3000	180.0	8.4	0.8	0.8	0.47	4.0	8.0	Q1

TAPE AND REEL BOX DIMENSIONS



*All dimensions are nominal

Device	Package Type	Package Drawing	Pins	SPQ	Length (mm)	Width (mm)	Height (mm)
TLV7081YKAR	DSBGA	YKA	4	3000	182.0	182.0	20.0
TLV7081YKAR	DSBGA	YKA	4	3000	182.0	182.0	20.0

YKA0004



PACKAGE OUTLINE

DSBGA - 0.4 mm max height

DIE SIZE BALL GRID ARRAY

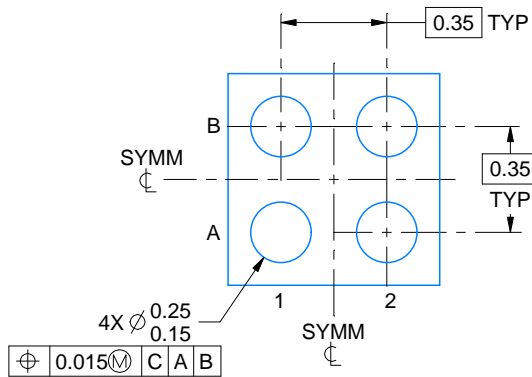
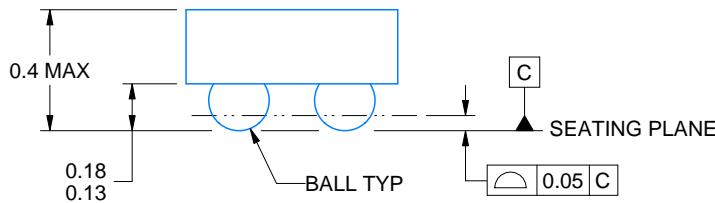
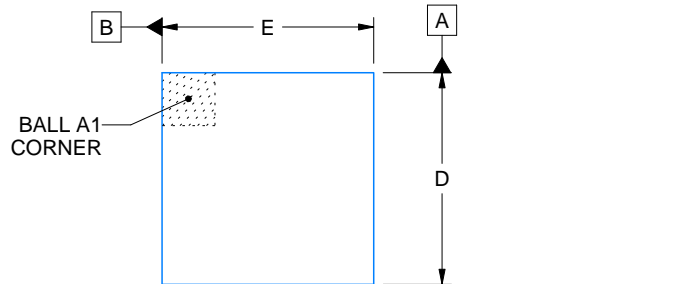

D: Max = 0.73 mm, Min = 0.67 mm
E: Max = 0.73 mm, Min = 0.67 mm

4221909/B 08/2018

NOTES:

1. All linear dimensions are in millimeters. Any dimensions in parenthesis are for reference only. Dimensioning and tolerancing per ASME Y14.5M.
2. This drawing is subject to change without notice.

EXAMPLE BOARD LAYOUT

YKA0004

DSBGA - 0.4 mm max height

DIE SIZE BALL GRID ARRAY

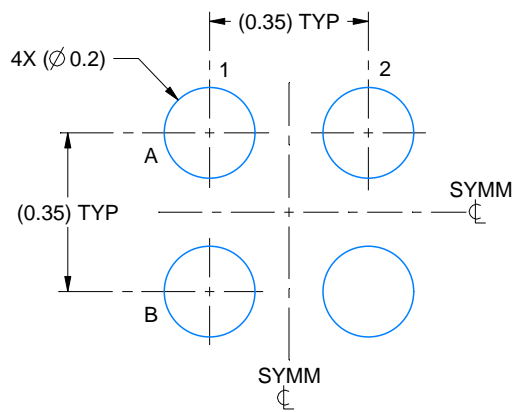

LAND PATTERN EXAMPLE
EXPOSED METAL SHOWN
SCALE:60X

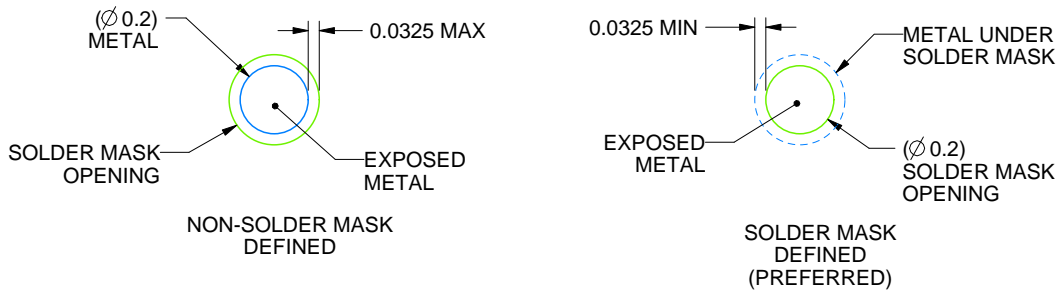

SOLDER MASK DETAILS
NOT TO SCALE

4221909/B 08/2018

NOTES: (continued)

- Final dimensions may vary due to manufacturing tolerance considerations and also routing constraints. For more information, see Texas Instruments literature number SNVA009 (www.ti.com/lit/snva009).

EXAMPLE STENCIL DESIGN

YKA0004

DSBGA - 0.4 mm max height

DIE SIZE BALL GRID ARRAY

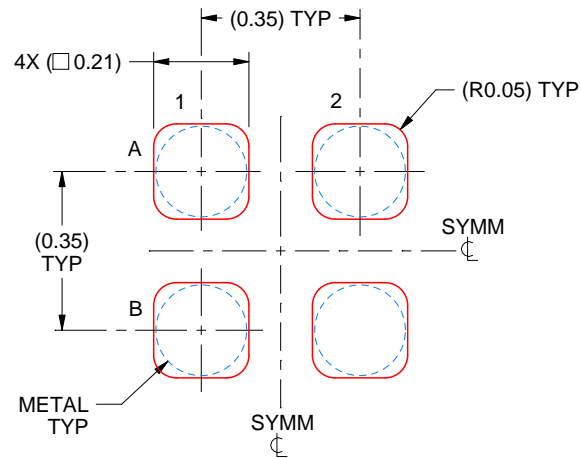

SOLDER PASTE EXAMPLE
BASED ON 0.075 mm - 0.1 mm THICK STENCIL
SCALE:60X

4221909/B 08/2018

NOTES: (continued)

4. Laser cutting apertures with trapezoidal walls and rounded corners may offer better paste release.

重要なお知らせと免責事項

TI は、技術データと信頼性データ (データシートを含みます)、設計リソース (リファレンス・デザインを含みます)、アプリケーションや設計に関する各種アドバイス、Web ツール、安全性情報、その他のリソースを、欠陥が存在する可能性のある「現状のまま」提供しており、商品性および特定目的に対する適合性の黙示保証、第三者の知的財産権の非侵害保証を含むいかなる保証も、明示的または黙示的にかかわらず拒否します。

これらのリソースは、TI 製品を使用する設計の経験を積んだ開発者への提供を意図したものです。(1) お客様のアプリケーションに適した TI 製品の選定、(2) お客様のアプリケーションの設計、検証、試験、(3) お客様のアプリケーションに該当する各種規格や、その他のあらゆる安全性、セキュリティ、規制、または他の要件への確実な適合に関する責任を、お客様のみが単独で負うものとし、

上記の各種リソースは、予告なく変更される可能性があります。これらのリソースは、リソースで説明されている TI 製品を使用するアプリケーションの開発の目的でのみ、TI はその使用をお客様に許諾します。これらのリソースに関して、他の目的で複製することや掲載することは禁止されています。TI や第三者の知的財産権のライセンスが付与されている訳ではありません。お客様は、これらのリソースを自身で使用した結果発生するあらゆる申し立て、損害、費用、損失、責任について、TI およびその代理人を完全に補償するものとし、TI は一切の責任を拒否します。

TI の製品は、[TI の販売条件](#)、または [ti.com](#) やかかる TI 製品の関連資料などのいずれかを通じて提供する適用可能な条項の下で提供されています。TI がこれらのリソースを提供することは、適用される TI の保証または他の保証の放棄の拡大や変更を意味するものではありません。

お客様がいかなる追加条項または代替条項を提案した場合でも、TI はそれらに異議を唱え、拒否します。

郵送先住所 : Texas Instruments, Post Office Box 655303, Dallas, Texas 75265
Copyright © 2024, Texas Instruments Incorporated