

TI Designs: TIDA-01102

防水でノイズ耐性のあるHMIアプリケーション用の、誘導性タッチ、ステンレス・スチール・キーパッドのリファレンス・デザイン



概要

TIDA-01102は、今日のHMIアプリケーション用に、ステンレス・スチール・パネル上に16個の誘導性タッチ・ボタンを実装します。誘導性タッチ・ソリューションは、他のセンシング・テクノロジーでは問題が発生するような、泥、湿気、油、または温度変化などがある環境でも、高い信頼性で動作できます。このソリューションは、一般的に使用されている、可動部品を持つ機械式ボタンの理想的な代替品で、より強固な非接触式のボタンのソリューションとして、高い信頼性と長い寿命を実現します。

リソース

TIDA-01102	デザイン・フォルダ
LDC1614EVM	EVMプロダクト・フォルダ
LDC1614	プロダクト・フォルダ
LDC1614-Q1	プロダクト・フォルダ
MSP430F5528	プロダクト・フォルダ
DRV2605	プロダクト・フォルダ
LP2985-N	プロダクト・フォルダ
TS3A5017	プロダクト・フォルダ
TPD4E004	プロダクト・フォルダ



E2Eエキスパートに質問

特長

- 機械式ボタンを、平らな金属表面上の非可動式の誘導性タッチ・ボタンで代替
- 1つの連続した金属シートを使用するため、環境に対して自然な密封となり、接地またはフローティング状態が可能のためシステムの柔軟性が増大
- 手袋をはめた状態や、水中(密封されている場合)、および雨、氷、泥、油などの過酷な環境でも動作可能、防水でIP67等級のボタンを実現可能
- 単純なオン/オフ・ボタンとしても、圧力に対応するボタン・アプリケーションとしても使用可能
- 金属の歪み測定精度: 1µm未満
- CISPR 22およびCISPR 24 EMC規格を満たすために役立つよう設計

アプリケーション

- 産業用および白物家電: 冷蔵庫、レンジ・フード、食器洗浄機、電子レンジ、洗濯機、サーモスタット、秤、EPOS/POS、乾燥機、コーヒーメーカー、ブレンダー、ミキサー
- 車載用HMI: センター・スタックやハンドルの制御パネルやフェイスプレートでの機械式スイッチの代替品、多機能ディスプレイのタッチ圧力検出(LDC1614-Q1が利用可能)
- 消費者向け: プリンタ、モバイル・デバイス、スピーカ、スマート・ウォッチ、ウェアラブル

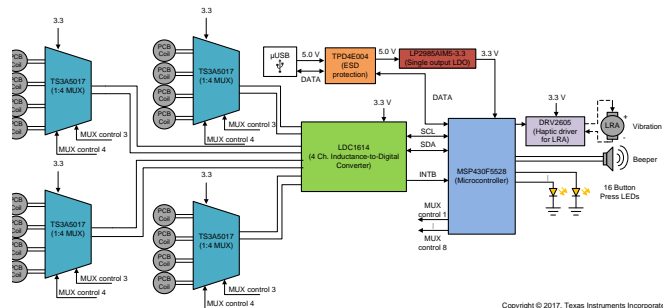

Copyright © 2017, Texas Instruments Incorporated



使用許可、知的財産、その他免責事項は、最終ページにあるIMPORTANT NOTICE(重要な注意事項)をご参照くださいますようお願いいたします。英語版のTI製品についての情報を翻訳したこの資料は、製品の概要を確認する目的で便宜的に提供しているものです。該当する正式な英語版の最新情報は、www.ti.comで閲覧でき、その内容が常に優先されます。TIでは翻訳の正確性および妥当性につきましては一切保証いたしません。実際の設計などの前には、必ず最新版の英語版をご参照くださいますようお願いいたします。

1 System Overview

Today, keypads are predominantly implemented using mechanical and electrical contact-based systems. These systems are prone to mechanical failure breaking down and consequently require expensive replacements over their lifetimes due to moving parts and dependence on electrical contact.

Inductive sensing is a contactless sensing technology that offers a more durable keypad implementation. Furthermore, this technology is extremely resistant to harsh environments and eases design of water resistance and dirt proof implementations. Using a standard 0.6-mm thick sheet of stainless steel 304, the 16-button keypad offers a low-cost, robust, and scalable keypad implementation that can be used in various industrial, consumer, and automotive applications.

To learn more about inductive sensing, go to www.ti.com/LDC.

1.1 System Description

The 16-button keypad is an example of inductive touch buttons using TI's LDC1614 inductance-to-digital converter (LDC). Inductive touch buttons can be created using a metal sheet and high-resolution LDC, such as the LDC1614. The LDC detects the microscopic metal deflections that occur when the button is pressed.  1 shows a simplified system diagram of a touch-on-metal implementation of an inductive touch button. When even a light force is applied to a button, the inner surface of the metal sheet deflects towards the PCB sensor. The metal sheet does not contact the sensors but the small amount of deflection from the press causes a shift in the sensor inductance that can be detected by the LDC and then interpreted as a button press by a microcontroller (MCU). The MCU then triggers button acknowledgment through haptic vibration, audible beeping, and LED illumination to give the user an indication of a valid button press. For more information on inductive touch, see the *Inductive Sensing Touch-On-Metal Buttons Design Guide*[1].

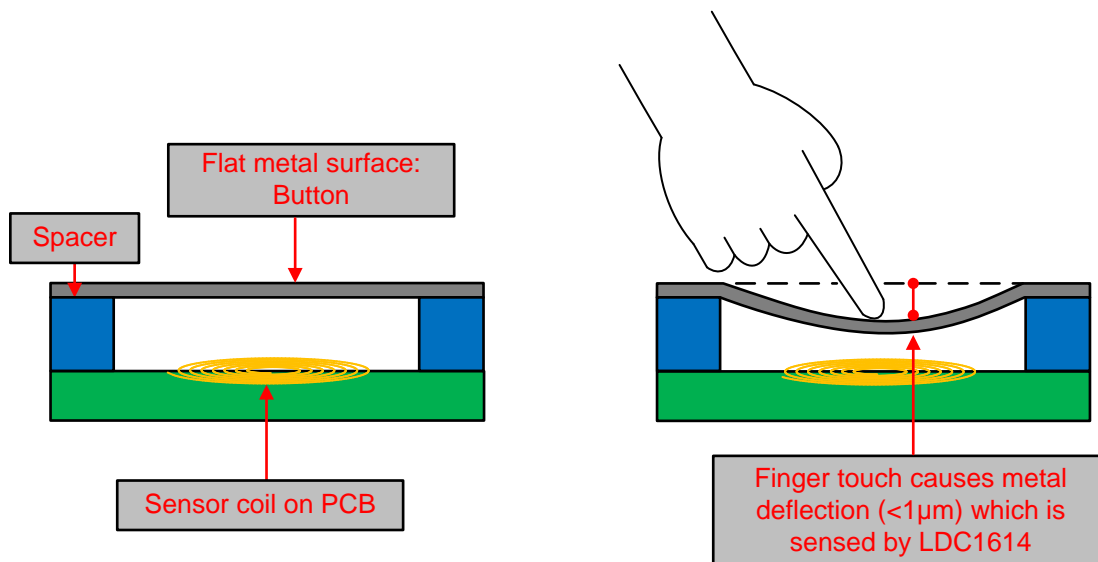

 1. Inductive Touch Diagram

1.2 Key System Specifications

The 16-button keypad consists of a flat sheet of metal attached to an inductive sensing board with standalone user feedback through haptic vibration, audible beeps, and visual LED illumination to indicate which button has been pressed to support GUI-less operation. The key specifications include the following:

表 1. Key Mechanical System Specifications

PARAMETER	SPECIFICATIONS	DETAILS
Physical dimensions	1028.7 × 1028.7 × 0.6 mm	—
Metal panel material	304 annealed stainless steel, #4 finish	2.1.2
Number of buttons	16	—
Button diameter	20.7 mm	2.1.2
Button center-to-center spacing	35.4 mm	—
Indication of button location	Etched pattern with paint fill on metal faceplate	2.1.2
Depth of etching prior to paint fill	0.2 mm	2.1.2
Depth of etching with paint fill	0.089 mm	2.1.2
Acknowledgment of button press	Provided by haptic vibration, audio beeper, and LED	2.4.4
Approximate force to actuate button	1.5 N (150 g); software adjustable	2.4.3
Simultaneous key press	Supported	—

表 2. Key Inductive Sensor Specifications

PARAMETER	SPECIFICATIONS	DETAILS
Inductive sensing product	LDC1614	1.4.1
Keypad scan rate	33 Hz	2.3.4
Spacer thickness (Sensor coil to metal surface spacing)	0.4 mm	2.1.6
Sensor coil diameter	16 mm	2.2.1
Sensor coil trace width and trace spacing	0.127 mm (5 mils)	2.2.1
Number of sensor coil layers	2	2.2.1
Sensor coil inductance (free space)	21 µH	2.2.1
Sensor coil inductance (installed in system)	8 µH	2.2.1
Sensor capacitance	1000 pF	2.2.1
Sensor operating frequency (installed in system)	1.78 MHz	2.2.1
Sensor Q factor (installed in system)	8	2.2.1
Sensor Amplitude (installed in system)	500 mVpk	2.2.1
Power supply	5 V (from USB)	1.4.5
Designed to enable meeting EMC standards	CISPR 22 and CISPR 24	2.2.2 2.2.3

1.3 Block Diagram

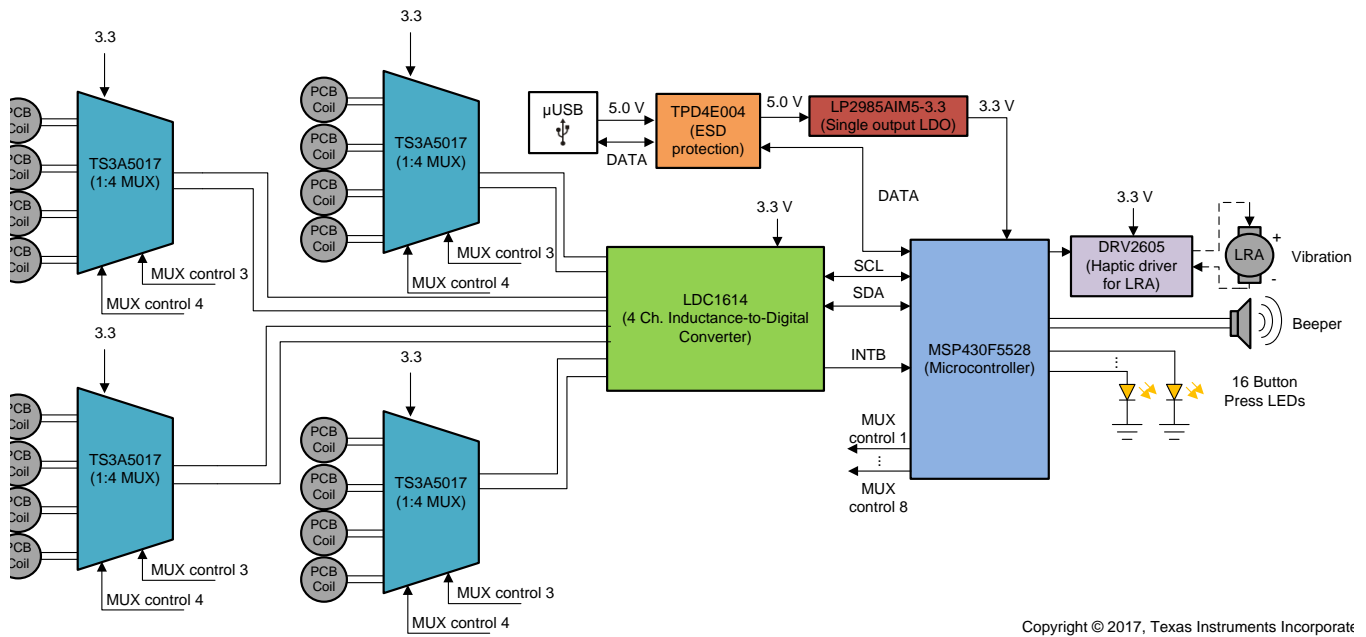

Copyright © 2017, Texas Instruments Incorporated

☒ 2. System Block Diagram

1.4 Highlighted Products

1.4.1 LDC1614 Inductance-to-Digital Converter

The LDC1614 is a four-channel, 28-bit inductance-to-digital converter. An internal multiplexer connects the sensor driver to one of the four channels per the register settings. In the keypad demo, each channel is connected to a 1:4 MUX so that 16 buttons can be realized. The converter is set to the continuous conversion mode and put into sleep during the MUX transitions. An external 40-MHz oscillator is used for improved accuracy to detect sub-micrometer changes in metal deflection. The LDC1614 is also available as a AEC-Q100 Grade 1 automotive qualified version, which is the LDC1614-Q1.



図 3. LDC1614 Functional Block Diagram

1.4.2 TS3A5017 Analog Multiplexer

The TS3A5017 device is a dual single-pole quadruple-throw (4:1) analog MUX. The device is bidirectional and has 165 MHz of bandwidth, which is sufficient to maintain stable oscillation from the LDC1614.

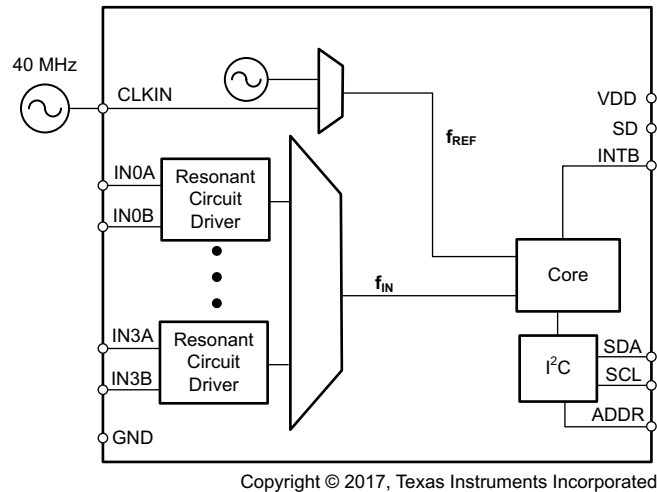
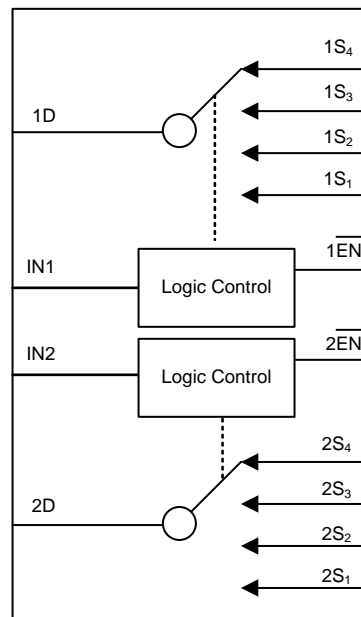

Copyright © 2017, Texas Instruments Incorporated

図 4. TS3A5017 Functional Block Diagram

1.4.3 DRV2605 Haptic Driver

The DRV2605 is a compact, haptic driver designed for linear resonant actuators (LRA) and eccentric rotating mass (ERM) motors. The DRV2605 provides flexible haptic feedback control over the I²C interface.

1.4.4 MSP430F5528 MCU

An MSP430™ MCU provides the processing for the LDC1614 to determine when a button was pressed. It also serves as a bridge between the LDC1614 and the USB port when data logging is desired.

1.4.5 LP2985 Low Dropout Regulator

The LP2985 low-dropout linear regulator is used to step down the 5-V USB power to the 3.3 V used by the LDC1614 and the MSP430.

1.4.6 TPD4E004 ESD Protection

To protect the demo board circuit from possible ESD surge through the USB interface, the demo board uses a TPD4E004, an ESD protection device for high-speed data lines. Note that a grounded metal target surface will also provide a high level of ESD protection against the external environment.

2 System Design Theory

In order to construct an inductive touch system with the optimal performance, consider the following:

1. Mechanical system design: The metal properties such as thickness, material type, quantity of buttons, size, shape, and arrangement of buttons as well as the optimal target-to-sensor spacing can influence the response of the system. Additionally, the rigidity of the standoffs, back stiffener, and mounting techniques will affect the response.
2. Sensor design: Best practice to LDC sensor design and shape is to ensure that the LDC can detect microscopic deflections in metal.
3. Other considerations include sampling rate, multiplexing multiple buttons, power consumption, detection algorithms to automatically adjust for long-term drift or permanent mechanical changes, and EMI.



図 5. System Functional Diagram

2.1 Mechanical System Design

2.1.1 Button Design

The shape and style of the metal button varies from application to application and can influence not only the look and feel, but the amount of force required to actuate the button. Simple shapes like circular buttons and rectangular buttons are a good starting point because the deflection can be easily calculated for a given force, while more complex button styles may require advanced simulations to accurately determine the metal deflection. For circular buttons, larger diameters require less force to deflect the metal, while for rectangular buttons the narrower dimension sets force versus deflection. Forces on the button can be thought of as either a uniform load distributed across the surface or a concentrated load such as the tip of a finger. In this design guide, force is evaluated with a concentrated loading condition as shown in 図 6.

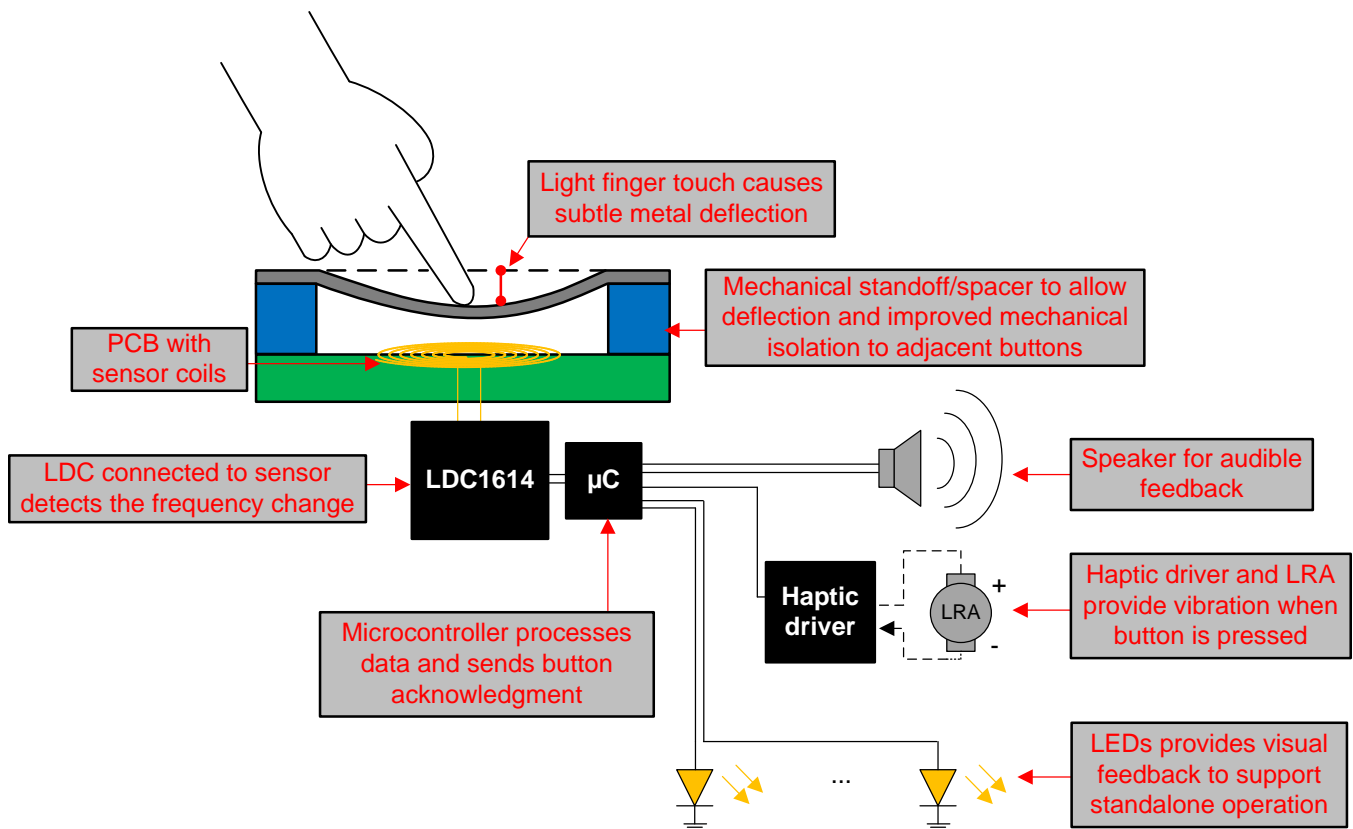

図 6. Common Button Shapes and Load Conditions

2.1.2 Metal Properties

For a detailed discussion on how metal type, thickness, and button diameter affect the amount of deflection for a given force, see the "Mechanical System Design" section of the *Inductive Sensing Touch-On-Metal Buttons Design Guide*[1]. The key material specifications for this TI Design are shown in 表 3.

表 3. Metal Panel Properties

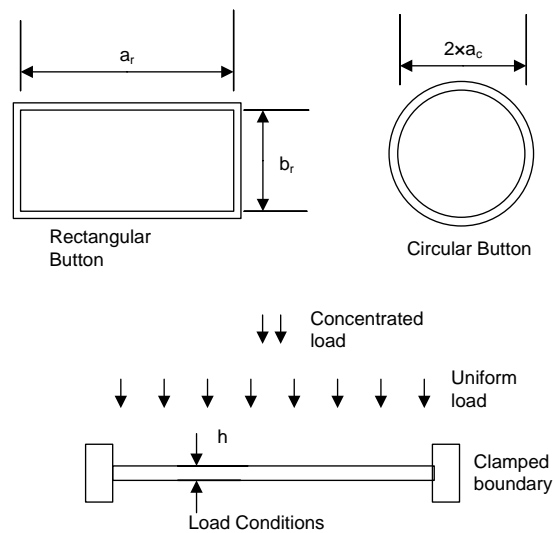
PARAMETER	VALUE
Metal material	Stainless Steel 304 #4 finish
Young's modulus	197 GPa
Poisson ratio	0.27
Thickness	0.6 mm
Button shape	Circular
Button diameter	20.7 mm
Indication of button location	Etched pattern with paint fill on metal faceplate
Depth of etching prior to paint fill	0.2 mm
Depth of etching with paint fill	0.089 mm
Conductivity	1.37×10^6 Siemens/m

2.1.3 Designing Button Press Force for Natural Feel

When designing a button, the button shape, metal type, and metal thickness determine how much force is required to deflect the metal by a sufficient amount. A typical mechanical button, such as those implemented with snap domes, may require anywhere between 5 to 8 N of force to actuate the button. Buttons with non-moving parts such as capacitive touch screens are typically pressed with a much lighter touch. This concept is the same for inductive touch applications where non-moving button with a force of 0.5 to 2 N provides a more natural button feel. This reference design was calculated to achieve 0.28 μm of deflection with a force of 0.5 N, which is easily detectable by the LDC1614 with proper sensor design. The calculations can be performed with the "Metal Deflection" calculator tab from the LDC tools spreadsheet[5]. The input parameters and calculation outputs used for this TI Design are shown in 表 4.

表 4. Input Parameters and Calculation Outputs

PARAMETER	DESCRIPTION	VALUE	UNIT
BUTTON DIMENSIONS			
Shape	Circular	—	—
$2 \times a_c$	Button diameter (circular button)	20.7	mm
h	Material thickness	0.6	mm
mat	Button material (304 stainless steel)	—	—
E	Young's Modulus for selected material	197	GPa
ν	Poisson ration for selected material	0.27	—
BUTTON FORCE			
force	Type of button force (concentrated)	—	—
Q	Force magnitude	0.5	N
wmax	Deflection at button center	0.279	μm

Note that for inductive touch applications, the amount of deflection per given force is linear as shown in 図 7.



図 7. Force versus Deflection for TIDA-01102

The amount of deflection can also be verified by simulation as shown in 図 8 where a 0.5-N force corresponds to a peak deflection of 0.27 μm .

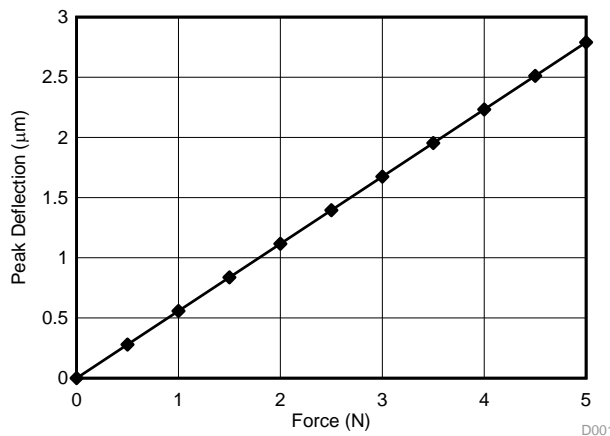

図 8. Simulation of Button Deflection for TIDA-01102

2.1.4 Importance of Controlling Sensor-to-Metal Distance

For a robust interface, it is necessary to control the distance between the sensor and the target so that random movements are not interpreted as a button press. 図 9 shows how sensors are mounted onto the inside surface so that only touch forces cause a deflection towards the sensor while any other forces will not produce an effective deflection towards the sensor.

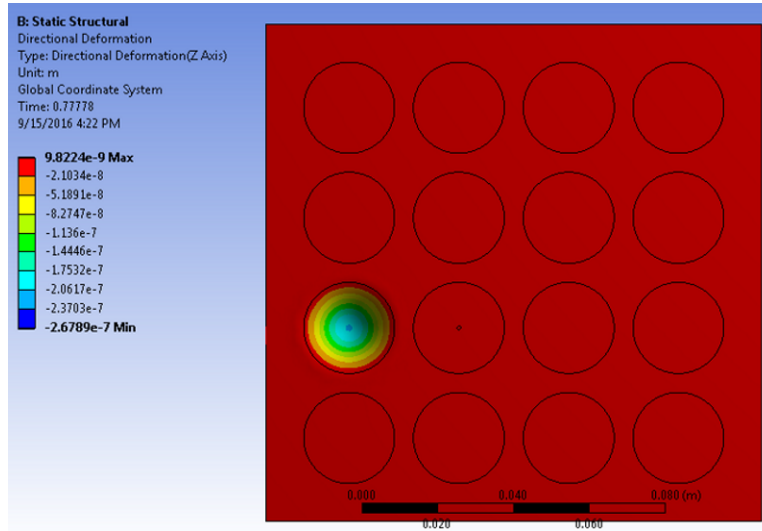

図 9. Mechanical Isolation Between Buttons

Additionally, for large metal surfaces or where buttons need to be placed close to one another, mechanical crosstalk may exist and should be reduced as much as possible to prevent false detections. Adding standoffs between buttons provides mechanical isolation between the buttons so that only a force above the intended button is detected. The standoffs should be as rigid as possible and can be made of FR4, plastic, or recesses right above the sensor in the metal surface. For more information, see the "Mounting Techniques" section of the *Inductive Sensing Touch-On-Metal Buttons Design Guide*[1]. The TIDA-01102 uses an FR4 standoff epoxied to the sensor PCB by the board manufacturer using the same flow as a standard FR4 PCB. This concept is known as an integrated spacer and greatly improves the consistency of the mechanical performance of the system.

2.1.5 Adding Stiffeners for Structural Rigidity

A system with large metal surfaces may bend in undesired places on the surface when pressed. A stiffener can be added behind the structure to provide mechanical support, but it should not cover the sensor PCB directly underneath the buttons to prevent inconsistencies in the amount of force required to press a given button. For example, when a button is pressed with a lot of force, if the adhesive is placed directly underneath the button, the adhesive will compress and take some time to recover back to its original thickness. During the recovery time, the adhesive will pull the sensor coil away from the metal such that the spacing between the sensor and metal surface will be further away than the nominal height. This added separation requires more force from the user to achieve the same metal-to-sensor spacing to trigger the button as the previous press. A recommended stiffener needs cutouts beneath the buttons to prevent the stiffener from unintentionally triggering a button press. Alternatively, the cutouts can be made in the adhesive between the stiffener and the sensor PCB. The TIDA-01102 design uses a double sided PSA, 9492MP made from 3M, which allows custom patterns to be cutout during manufacturing.

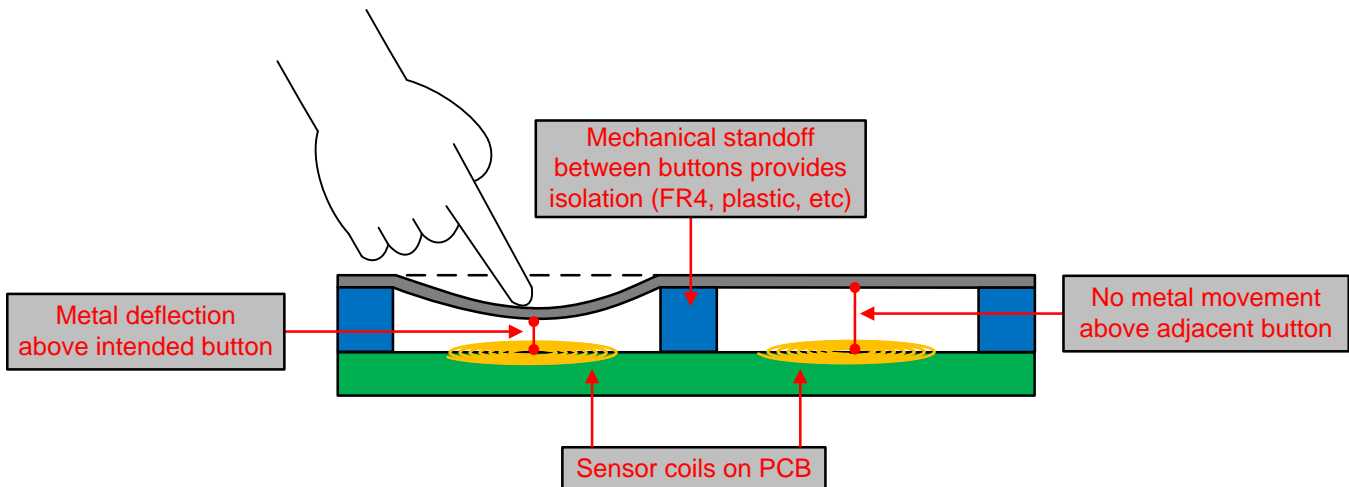
2.1.6 Full Mechanical Stackup

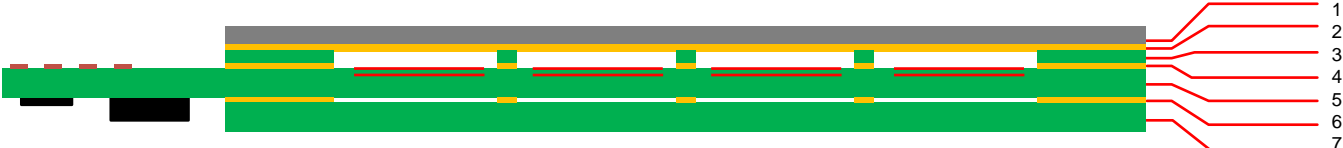
A robust inductive touch system requires a stable mechanical assembly, which starts with the mechanical stackup.  10 shows the mechanical stackup for the TIDA-01102 reference design.



1. Stainless Steel, type 304, annealed, finished #4, thickness 0.61mm
2. Double-sided PSA with microchannels, 3M 367MC, thickness 0.05mm
3. Spacer, FR4, thickness 0.4mm
4. Epoxy, thickness 0.01mm
5. Sensor PCB, FR4, 4-copper layers, 1.6mm
6. Double-sided PSA with button cutouts, 3M 9492MP, thickness 0.06mm
7. Stiffener, FR4, 1.6mm

Total thickness = 4.33mm

 10. Mechanical Stackup for TIDA-01102

2.2 Sensor Design

2.2.1 Key Sensor Characteristics

For inductive touch applications, the LC resonator is formed with a multi-layer PCB spiral inductor and parallel capacitor. A simplified PCB spiral coil with the important terminology is shown in [Fig 11](#).



図 11. PCB Coil Parameters

The size and shape of the coil relative to the button geometry has a large influence on the response of the system. For a detailed discussion on the key sensor characteristics for Inductive Touch applications, see the "Sensor Design" section of the *Inductive Sensing Touch-On-Metal Buttons Design Guide*[\[1\]](#). The TIDA-01102 has the following sensor characteristics shown in [Table 5](#).

表 5. Inductive Sensor Specifications

PARAMETER	VALUE
Outer coil diameter (d_{OUT})	16 mm (630 mils)
Inner coil diameter (d_{IN})	0.762 mm (30 mils)
Width of trace (W)	0.127 mm (5 mils)
Spacing between traces (S)	0.127 mm (5 mils)
Number of sensor coil turns	30
Number of sensor coil layers	2
Dielectric thickness (Layer 1 to Layer 2 thickness)	0.127 mm (5 mils)
Sensor coil inductance (free space)	21 μ H
Sensor coil inductance (installed in system)	8 μ H
Sensor capacitance	1000 pF
Sensor operating frequency (installed in system)	1.78 MHz
Sensor Q factor (installed in system)	8
Sensor amplitude (installed in system)	500 mVpk

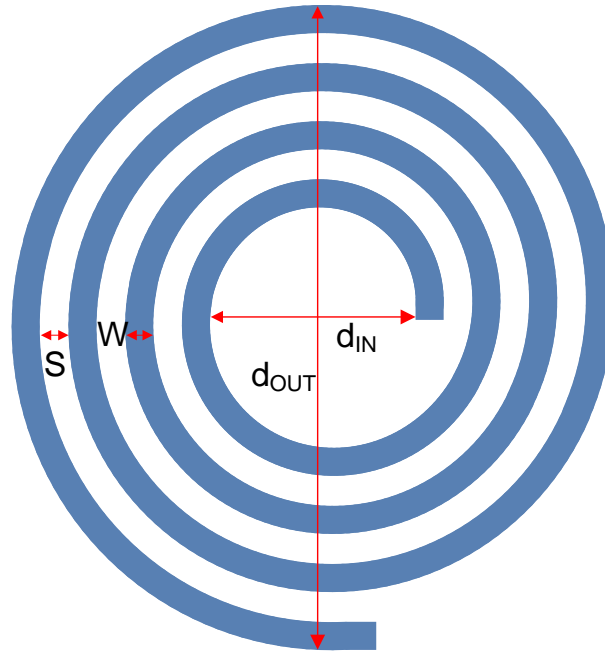
2.2.2 Grounded or Ungrounded Metal Panels

An inductive touch system may have a metal surface that is connected to circuit ground or left floating, which is common in many applications. While a grounded connection provides excellent immunity against ESD events and capacitive coupling, a floating metal panel may be required for safety reasons. Both configurations are supported by an LDC-based solution, but ungrounded metal panels may have a capacitive effect with an approaching hand, which decreases the frequency as the user approaches or worse increases the frequency as the hand is removed, potentially triggering a false button press. This effect can be modeled as shown in 図 12.



図 12. Capacitive Effect of Floating Metal Surface

The capacitive effect is undesirable and can be mitigated by increasing the sensor capacitance such that the capacitor formed by the LC tank is the dominant source of capacitance. A value of 1000 pF was chosen for this reference design, which is large enough to dampen the capacitive effect of an approaching hand while still providing a Q factor of greater than 5, which is recommended for noise immunity. Additionally, the unused surface area of the sensor PCB is filled with ground copper to form an AC grounded connection to the metal plate, which further reduces any unwanted capacitive effects in the system. The additional capacitance can be approximated with a simple parallel plate capacitor formula:

$$C_G = \frac{(\epsilon_0 \times \epsilon_r \times A)}{d} \tag{1}$$

Where:

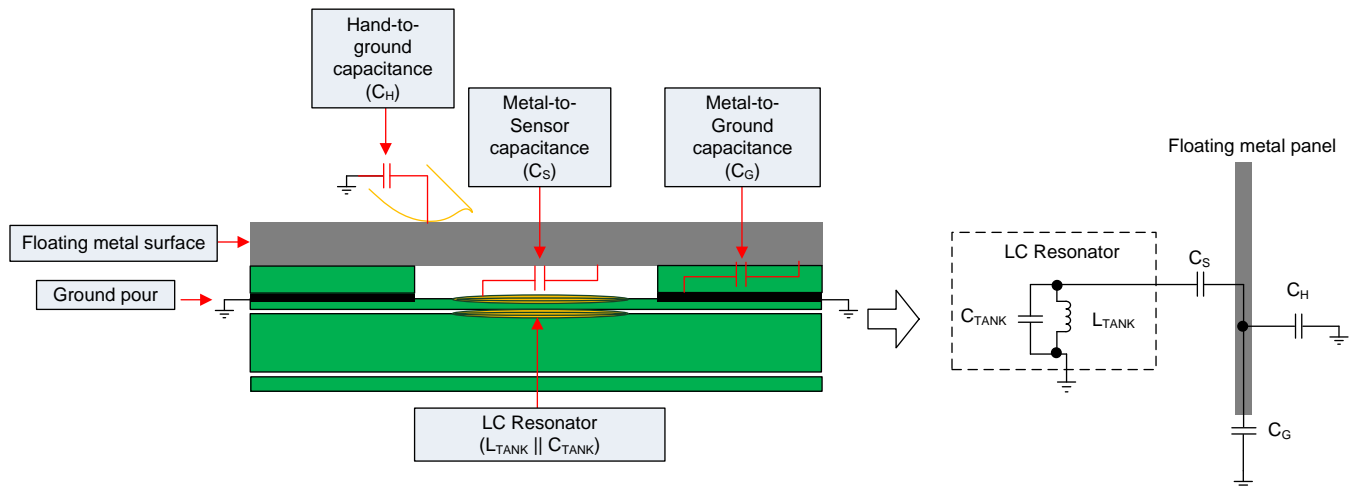
- C_G is the additional capacitance to ground from the ground copper pour on the top layer of the PCB
- ϵ_0 is the dielectric constant in free space approximately 8.854×10^{-12} F/m
- ϵ_r is the dielectric constant of the FR4 spacer, approximately equal to 4.1
- A is the total surface area of the copper pour with sensor cutouts considered, which is approximately 0.005 m^2 (Note the diameter of the sensor cutouts is 0.0207 m)
- d is the thickness of the FR4 spacer, equal to 0.0004 m

For this reference design, based on the dielectric thickness, the surface area is approximately 450 pF, which further enhances the robustness against capacitive effects.

2.2.3 Guidelines for Remote Sensors

For many inductive touch systems it is difficult to place the LDC directly next to sensors, which results in long trace lengths. It is generally recommended to keep the trace lengths as short as possible to avoid poor Q factor, inductance dividers, or transmission line effects, which can hurt EMI performance. When long traces must be used, one technique to mitigate the transmission line effect is to add additional capacitors close to the device to act as an EMI filter. For this reference design, the 900 pF is distributed so that 680 pF is placed next to the sensor for the primary LC oscillation path and 220 pF near the device for EMI filtering.

2.3 Sampling and Data Collection

When the LDC1614 is collecting data, the sensor input channels are time domain multiplexed so that only one channel is active at any given time. The length of time for a single channel to complete a conversion is called conversion time (t_{Cx}) and can be adjusted with the CHx_RCOUNT register. Find more information on page 13 of the LDC1614 datasheet (SNOSCY9) .

The conversion time can be directly calculated with 式 2:

$$t_{Cx} = \frac{(CHx_RCOUNT \times 16 + 4)}{f_{REFx}} \tag{2}$$

Where:

- t_{Cx} is the conversion time for a given channel x
- CHx_RCOUNT is the decimal value of the RCOUNT register for a given channel x
- f_{REFx} is the reference frequency for a given channel x

A full scan is complete once all four channels have finished their respective conversions, taking a total time known as t_{SCAN} . Once a scan is complete, the DATA_MSB_CHx and DATA_LSB_CHx registers are updated and the INTB pin is asserted to alert the MCU that new data is available. Once the data has been read by the MCU, the INTB flag is deasserted and the sampling process continues as shown in 図 13.



図 13. LDC1614 Scanning and Data Ready Timing Diagram

Note that the next conversion begins immediately after the INTB is asserted and is not gated by the MCU reading the data. The INTB function can be enabled by setting CONFIG.INTB_DIS to 0.

When all four channels are set to the same conversion time (t_{CX}), the total time it takes for a single LDC1614 to scan all four channels (t_{SCAN}) can be approximated as simply $4 \times t_{CX}$. The switching delay between channels is less than 1 μ s and is considered negligible for this computation.

2.3.1 Inductive Touch Implementation for More Than Four Buttons

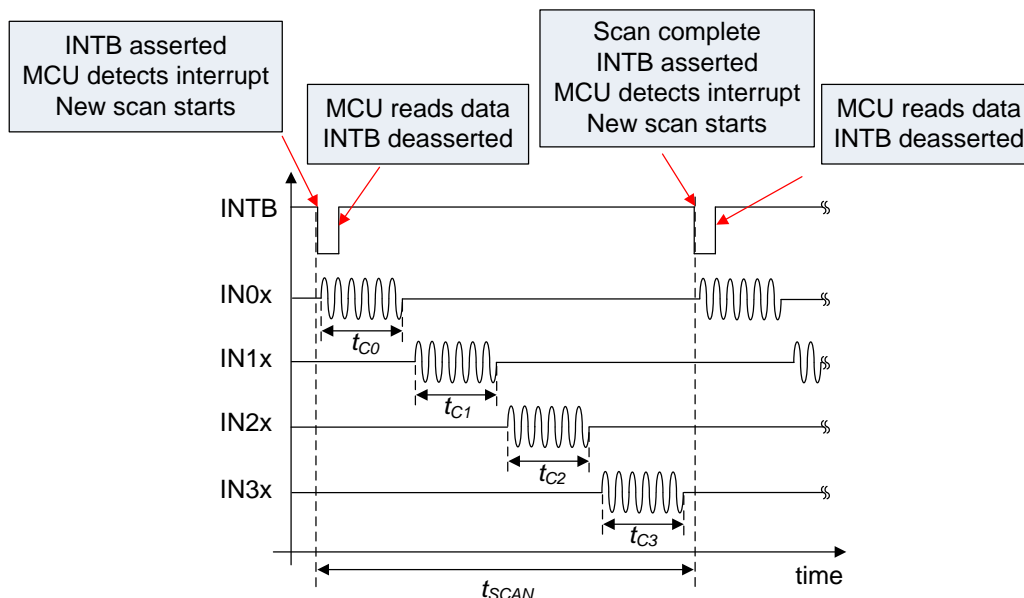
Inductive touch applications with four or less buttons can be easily implemented with a single LDC1614 device. When the number of buttons exceeds four, the designer has the option to use multiple LDC1614 devices or a single LDC1614 device plus analog multiplexers (MUX) such as the TS3A5017. While there are advantages for both, systems that employ the multiple LDC approach have better performance due to less parasitic capacitances and faster sampling rate, but require multiple I²C lines for device communication or an I²C MUX if more than two LDC devices are used.

2.3.2 Data Collection Approach With Multiple LDCs

The LDC1614 features an I²C interface with two available addresses that can be configured as either 0x2A or 0x2B by setting the ADDR pin low or high, respectively. In order to implement a system with 16 buttons that uses four LDC1614 devices an MCU with two I²C interfaces such as the MSP430F5528 or an I²C MUX is required for communication with all four LDC1614 devices.

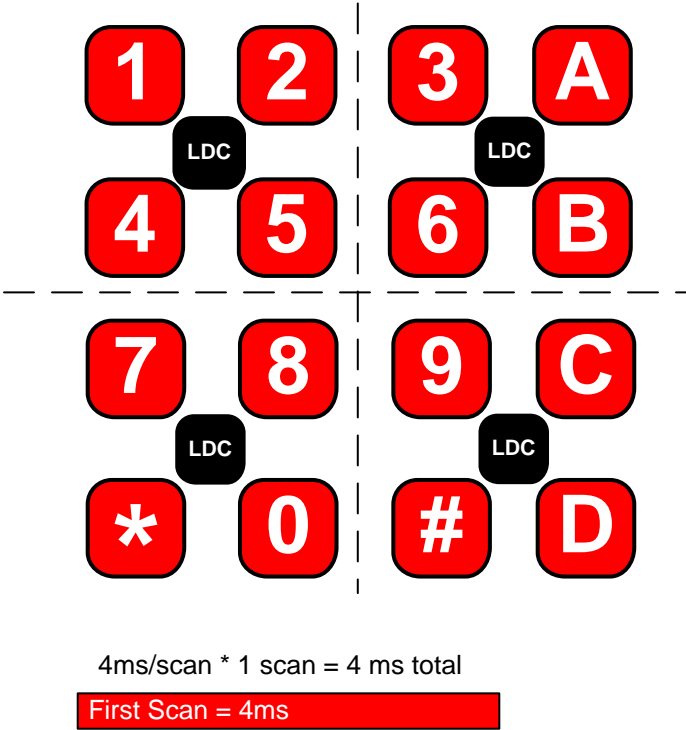
For the fastest scan rate, all LDC1614 devices can be set for channel sequence mode such that each device is taking a measurement in parallel, which results in a total scan time of $4 \times t_{cx}$. For example, if t_{cx} is set to 1 ms, then the total scan time for all 16 buttons is 4 ms as shown in  14.

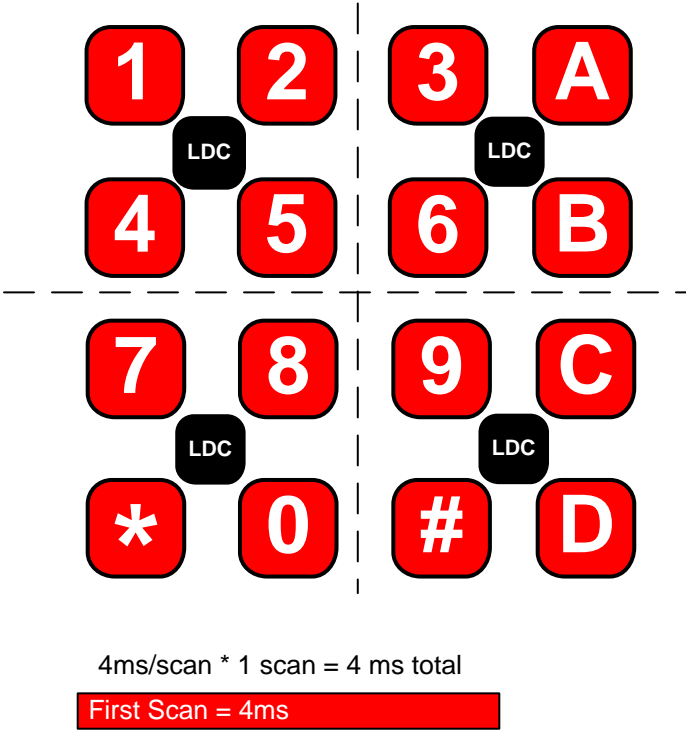

 14. Scan Diagram With Four LDC1614 Devices Approach

When implementing this technique, it is recommended to set the nominal sensor frequencies of each LDC group at least 10% apart from other adjacent LDC groups to avoid an increase in noise due to sensor-to-sensor coupling. Note that for a given LDC group, the sensor inputs are time domain multiplexed so all four sensors in the same LDC group can be set to the same nominal frequency. A bench check showed that 10% separation between LDC groups is sufficient to avoid an increase in noise. When all the frequencies were set equal and two adjacent coils were active at the same time, then the peak noise increased by a factor of 3.

2.3.3 Data Collection Approach With Single LDC and Analog MUXes

One alternative method towards implementing a 16-button inductive touch interface is to use a single LDC1614 with four TS3A5017 analog MUXes. Only a single I²C interface is needed for the LDC and 8 GPIOs to control the MUXes, which enables the use of low-cost MCUs. However, using MUXes in the sensor path adds additional parasitic capacitances that now contributes to the system, reduces the Q factor of the sensor, and increases overall system noise. Additionally, as each LDC1614 channels now services four buttons instead of one button, it takes approximately four times as long for a single scan cycle for the entire array of 16 buttons.

This TIDA-01102 reference design uses a single LDC1614 device and four TS3A5017 devices to demonstrate the feasibility of a single I²C interface and to show the performance can be very robust with sufficient response time to be used in HMI button applications. With this approach, the data collection is done as shown in [Figure 15](#).

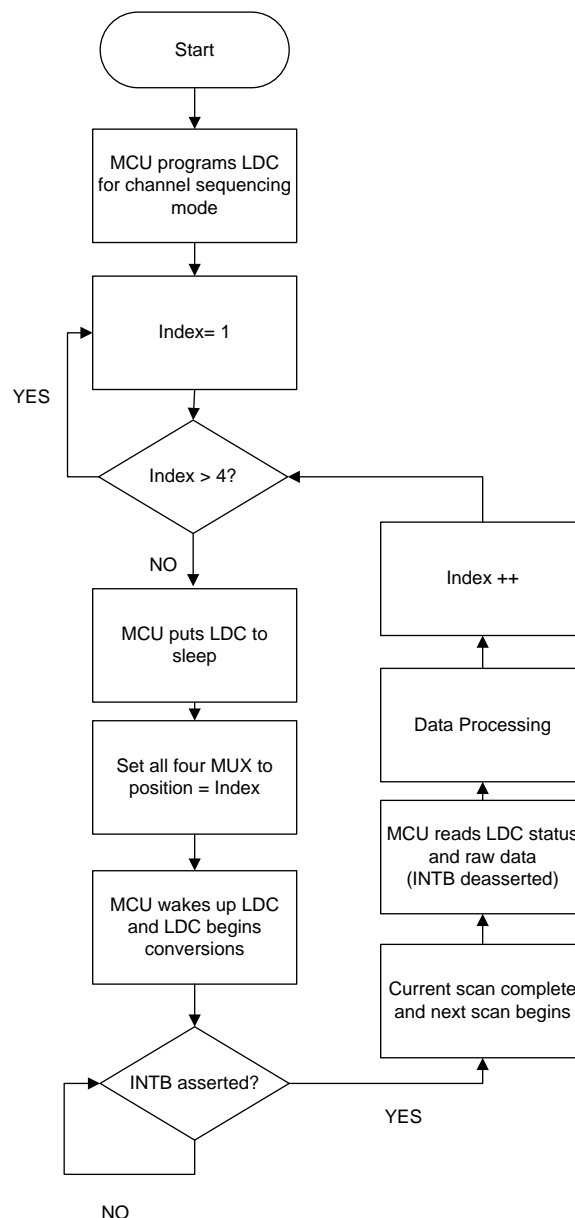
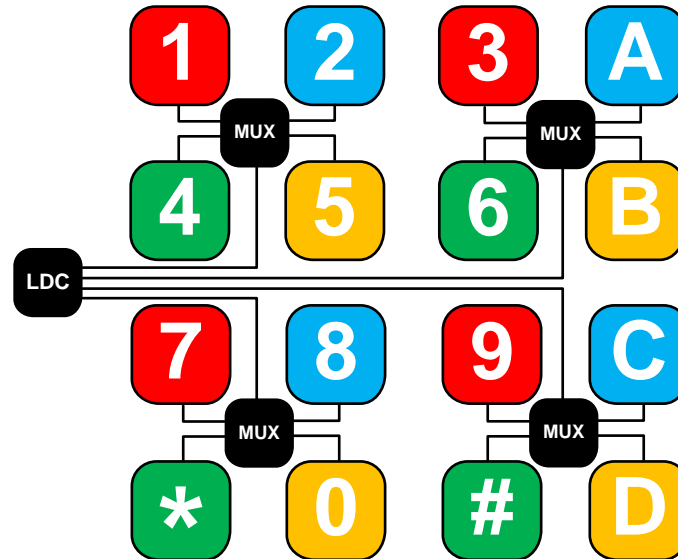

Figure 15. Data Collection Flow Chart for Single LDC1614 Device and Four TS3A5017 Devices

This process is visualized in [Figure 16](#), where it takes four complete scans (denoted by the different colors) of the LDC to complete capturing data for all 16 buttons. For a 1-ms conversion time per channel, the total time required is 16 ms. Note that the I²C read and write times using a 400-kHz I²C clock are less than 1 ms and are ignored for the purposes of this approximation.



$$1\text{ms/ch} * 4\text{ ch} * 4\text{ scans} = 16\text{ ms total}$$

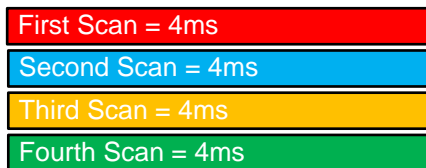

Figure 16. Scan Diagram With Single LDC1614 and Four MUX Approach

2.3.4 User Experience and Latency

For the best user experience, there should be no detectable delay between when the user presses the button and when it was registered and acknowledged. The average person cannot easily press a button more than 15 times per second. Therefore, a system that scans all 16 buttons at twice this rate, or 30 times per second, is sufficient to never miss a button press.

The TIDA-01102 uses a 40-MHz external oscillator for the reference frequency with a divider setting of 1, such that fREFx is equal to 40 MHz for all channels. Each channel is set for a 1-ms conversion time, which translates to an RCOUNT setting of 09C3 in hex. There is a trade-off between conversion speed and resolution, so choosing this number in the design can be an iterative process. For more information, see the application note *Optimizing L Measurement Resolution for the LDC161x and LDC1101*[\[4\]](#).

The additional time it takes for I²C reads and writes as well as the sequencing of the MUXes adds a negligible amount of latency (typically a few microseconds); however, the TIDA-01102 design uses RTOS framework to make the code compatible with any MCU, but introduces a significant amount of overhead delay. The overhead of the RTOS in this TI Design is 14 ms, which drops the effective sampling rate down to 30 ms. If a higher sampling rate is required, the RTOS can be removed for an optimized sample rate of 16 ms.

2.4 Sensor Data Processing

The LDC1614 records the raw frequency shift from the moving metal and sends this data in the form of a 28-bit value to the MCU. The MCU analyzes the data and determines if a button has been pressed. A simplified processing algorithm is shown in [Figure 17](#).

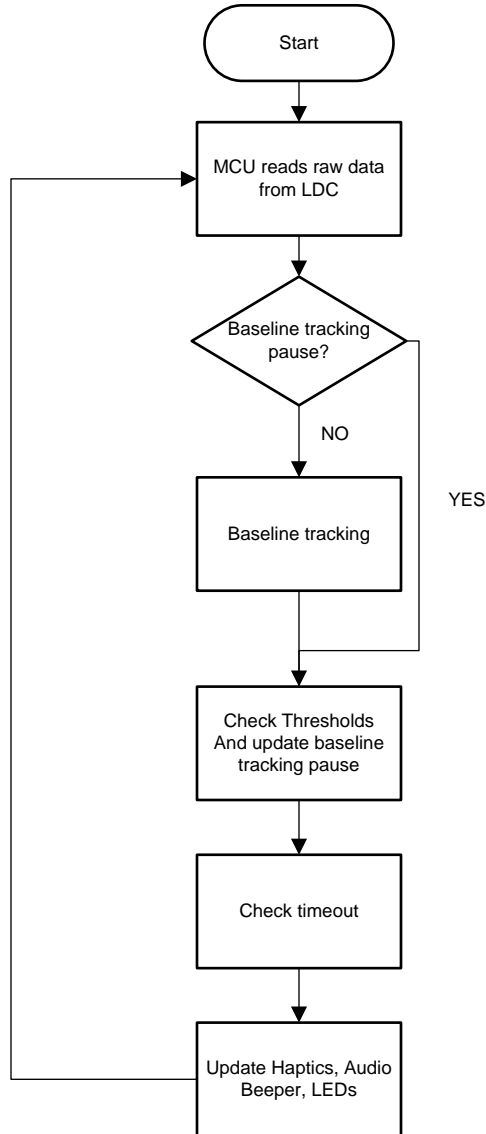

Figure 17. Simplified Algorithm Flow Chart

2.4.1 Baseline Tracking

As the LDC is sampling, environmental factors such as temperature change can cause the sensor frequency to drift. These changes in frequency are undesired but are typically much slower than the frequency shift due to a button press and can therefore be easily compensated for. A simple moving average is implemented on the raw data by the MCU to track the slow frequency drifts that may exist in the system. This value can be subtracted from the raw data on all channels to provide only the relative frequency shifts from a button press. This concept is known as baseline tracking. Additionally, the use of a baseline tracking algorithm removes the need for any factory calibration. A simplified flow chart of baseline tracking used in TIDA-01102 is shown in [Figure 18](#).



図 18. Baseline Tracking

While baseline tracking is important for a robust inductive touch system, it should be temporarily paused in some cases. For example, a long button press with baseline tracking enabled will eventually decay enough that it turns off the button as shown in [Figure 19](#).

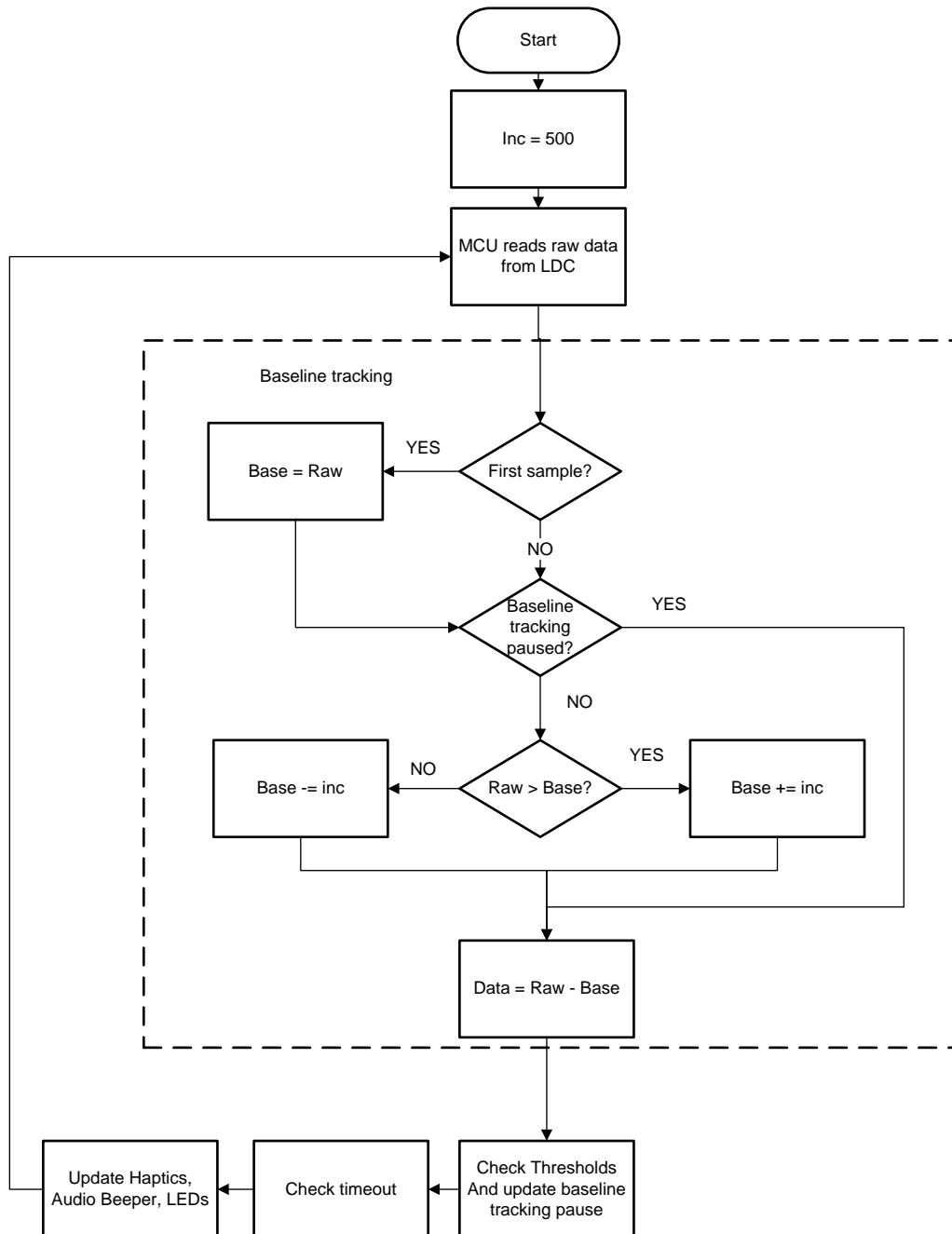
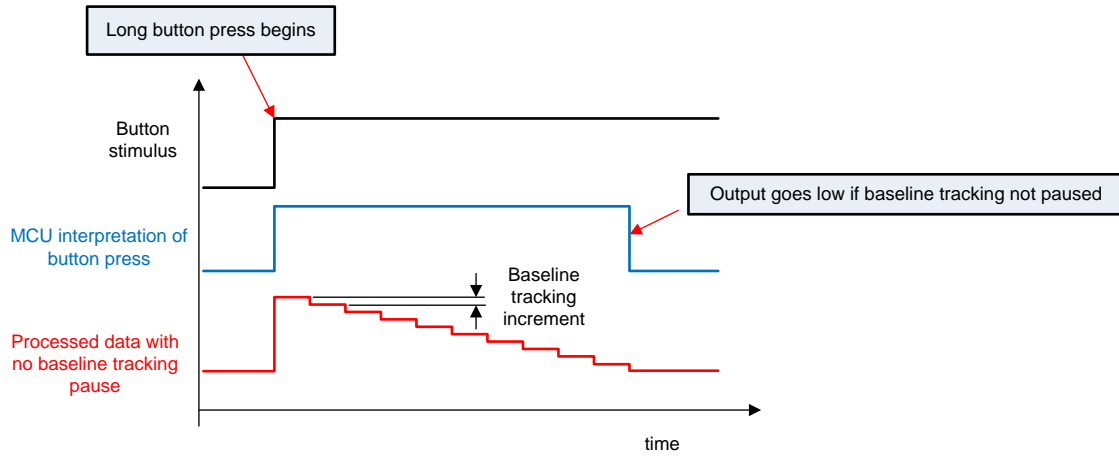

Figure 19. Button Response With No Baseline Tracking Pause

This decay can be remedied by implementing a baseline tracking pause during a button press event as shown in [Figure 20](#).

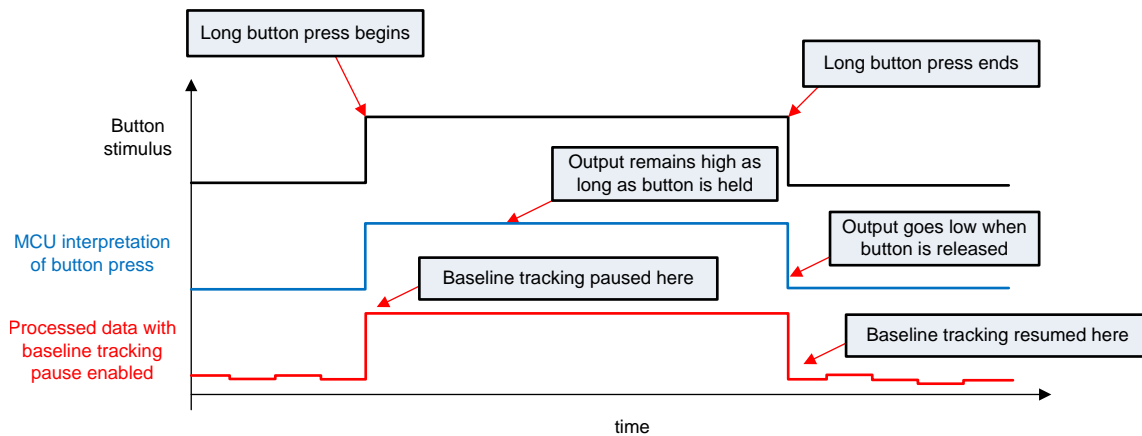

Figure 20. Button Response With Baseline Tracking Pause Enabled

2.4.2 Hysteresis

A user will often press a button with an inconsistent amount of force, which could cause the output to flicker on and off if a fixed threshold is used. This flicker can be remedied by adding hysteresis for the button detection threshold so that there is a different value for switch ON and switch OFF thresholds. An example of hysteresis being used to prevent such force variations near the switching threshold is shown in [Fig 21](#).



図 21. Hysteresis on Button Threshold Prevents Flickering Output State

2.4.3 Threshold Setting

In order to determine the minimum threshold setting that can be supported, look at the peak noise in the system, which requires a fully assembled prototype. This concept is known as signal-to-noise ratio (SNR); for inductive touch applications, it is typically recommended to have an SNR > 10. More information can be found in the *Inductive Sensing Touch-On-Metal Buttons Design Guide*[1].

2.4.4 Button Acknowledgment

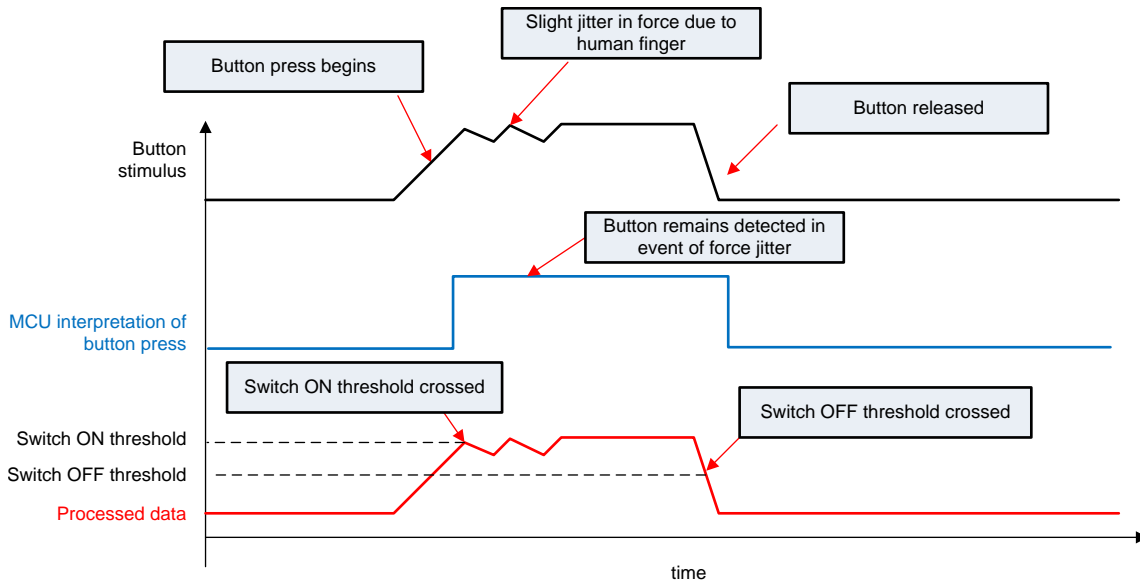
Once the MCU detects a value from the LDC that crosses the threshold setting, the MCU can then toggle the LEDs, haptics, and audio beeper to alert the user that a button has been pressed. In this way, pressing a button feels very natural and the user can clearly detect that this button press has been acknowledged.

3 Getting Started Hardware and Software

3.1 Integrated PCB Spacer

The sensor PCB and the spacer can be manufactured together with an epoxy as shown in [Figure 22](#).

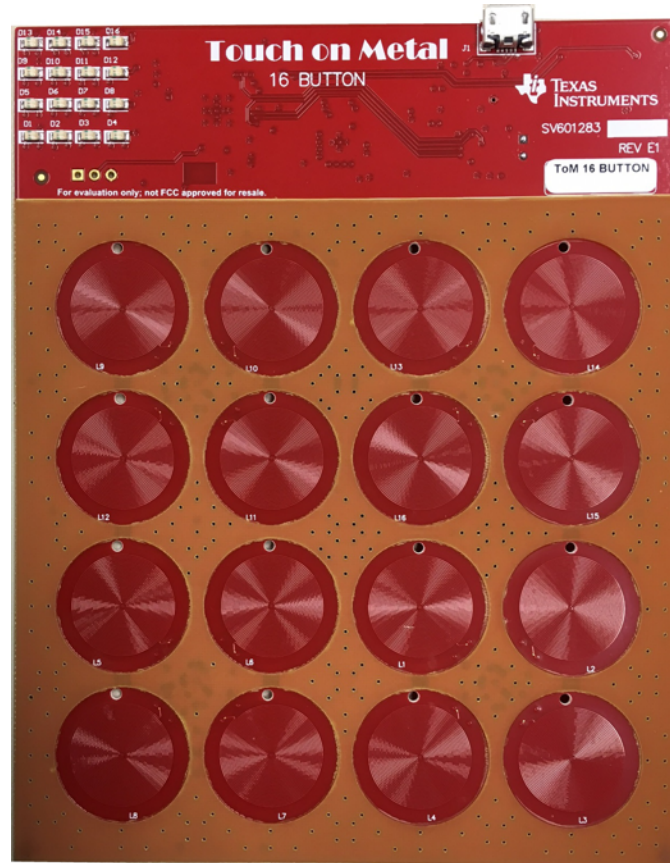

Figure 22. Integrated PCB Spacer

Manufacturing the sensor PCB and spacer is the recommended method to simplify the assembly process as well as enhance the performance for flat metal panels; however, other systems may mill out holes into the metal (see the "Mounting Techniques" section of the *Inductive Sensing Touch-On-Metal Buttons Design Guide*[1]). Many PCB manufacturers will accommodate this extra step and ship a fully assembled sensor PCB with integrated spacer. It is important that no components be placed on the top layer; otherwise, this may interfere with the pick-and-place machine during the assembly process. It is also important to include non-plated holes through both the spacer and the sensor PCB are added so that any air pockets that may form during the assembly process can be alleviated through the holes.

3.2 Applying Pressure-Sensitive Adhesive (PSA)

A double-sided PSA is the preferred method for joining the individual pieces in an inductive touch system due to its durability and ease of application. It is recommended to apply the PSA to the underside of the metal plate as well as the top side of the stiffener. Before application, inspect the metal panel and stiffener for bumps or large uneven surfaces spots. A flat and even surface is be critical to ensuring reliable performance. The surface of the metal should also be cleaned and dried before applying a laminate. A PSA such as 3M 467MC is selected for the adhesive due to its excellent bonding abilities and micro-channels to prevent air bubbles from building up. The laminate can be applied with a roller as shown in [Figure 23](#).



図 23. Lamination Technique

It is important the roller does not have a concave, convex, or canted surface; these defects cause problems such as poor adhesion, adhesive picking, lifting, wrinkling, trapped air bubbles, or web steering difficulty. The roller should be smooth, clean, parallel, and properly adjusted for pressure as shown in [Figure 24](#). For more information, see the application note, *Lamination Techniques for Converters of Laminating Adhesives* (<http://multimedia.3m.com/mws/media/131108O/lamination-techniques-for-converters-of-laminating-adhesives.pdf>).

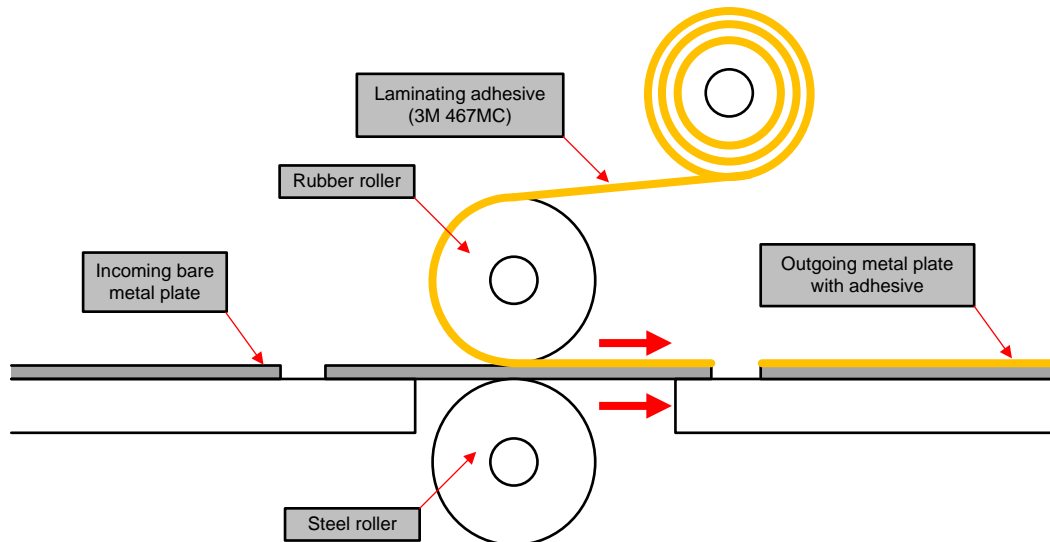

図 24. Parallel Roller Implementation

3.3 Mechanical Assembly Sequence

The assembly of the TIDA-01102 requires three individual pieces: a stainless steel panel with 467MC pre-applied, a sensor PCB with integrated spacer, and an FR4 stiffener with 9492MP pre-applied. These three pieces are shown in [Figure 25](#), [Figure 26](#), and [Figure 27](#), respectively.

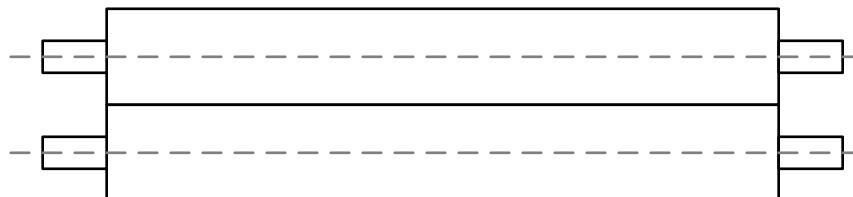
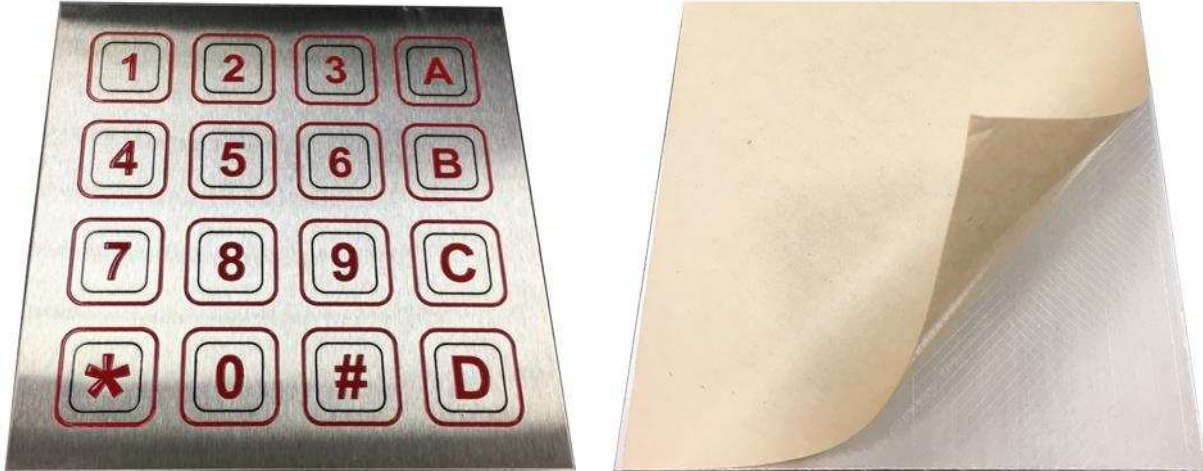

Figure 25. Stainless Steel Panel With 467MC Pre-Applied (Front and Back)

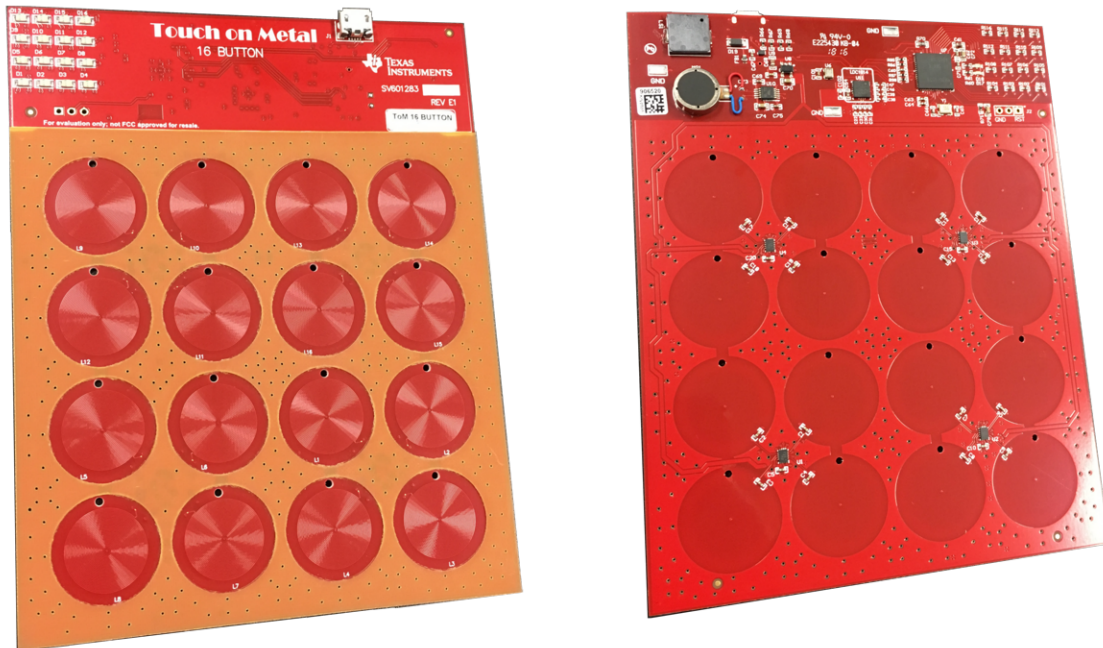

Figure 26. Sensor PCB With Integrated Spacer (Front and Back)



図 27. FR4 Stiffener With 9492MP Pre-Applied (Front and Back)

Assembly is performed in the following sequence:

1. For all three pieces shown in 図 25, 図 26, and 図 27, thoroughly clean, expose adhesive, and inspect for defects. Stray dirt and other particles can build up and cause false triggers when fully assembled.
2. Peel the sticker off the 467MC PSA that is pre-installed on the stainless steel metal plate.
3. Align the metal panel to the sensor PCB with integrated spacer. Note that the metal plate is slightly larger than the sensor PCB on all sides in case there are burrs on the edges of the metal panel from the cutting process. An overhang of 0.025" should be ensured on each side to prevent burrs from touching the PCB.
4. Peel the sticker off the 9492MP PSA that is pre-installed on the FR4 stiffener.
5. Align the stiffener to the sensor PCB and compress the whole structure. If sufficient force, temperature, or duration of compression is not applied, then there may be uneven mounting problems or air bubbles that result in mechanical crosstalk or false touches. It is best to consult with the manufacturer of the PSA for the recommended force, temperature, and time requirements. For the materials used in the TIDA-01102, 15 lbs per square inch for 3 seconds at room temperature is recommended for permanent adhesion.



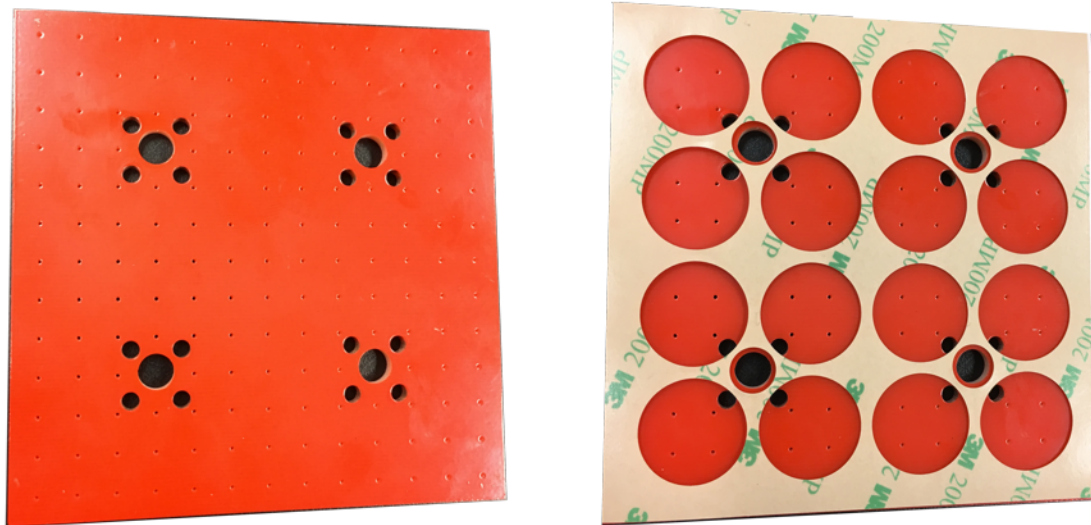

図 28. Assembly Process

With all three pieces aligned and pressed together, the TIDA-01102 resembles  29.

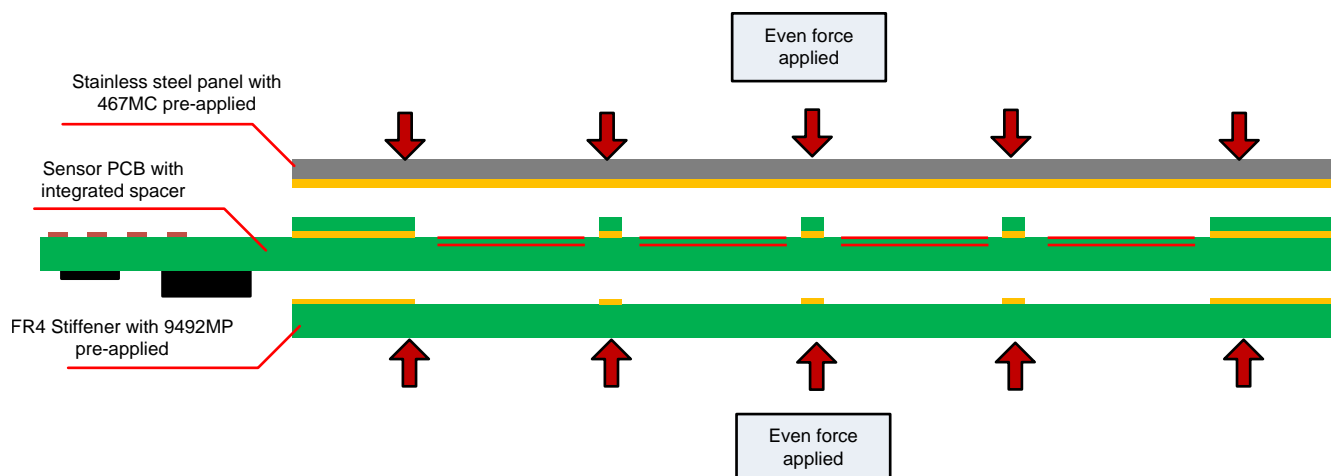

 29. TIDA-01102 After Assembly (Front and Back)

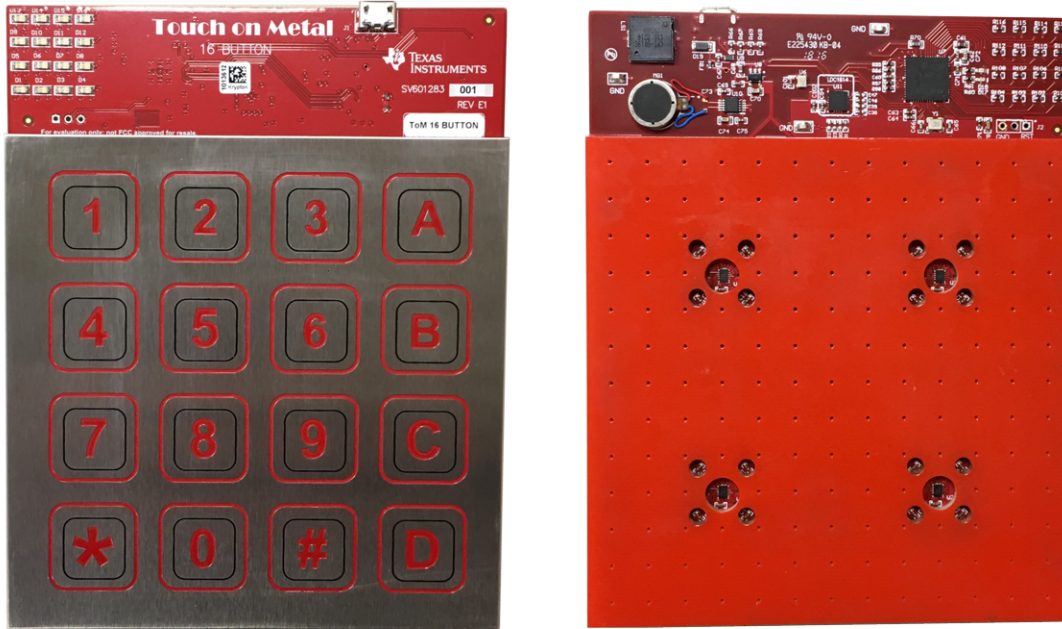
 30 shows the location of the PCB spacer cutouts relative to the surface overlay.

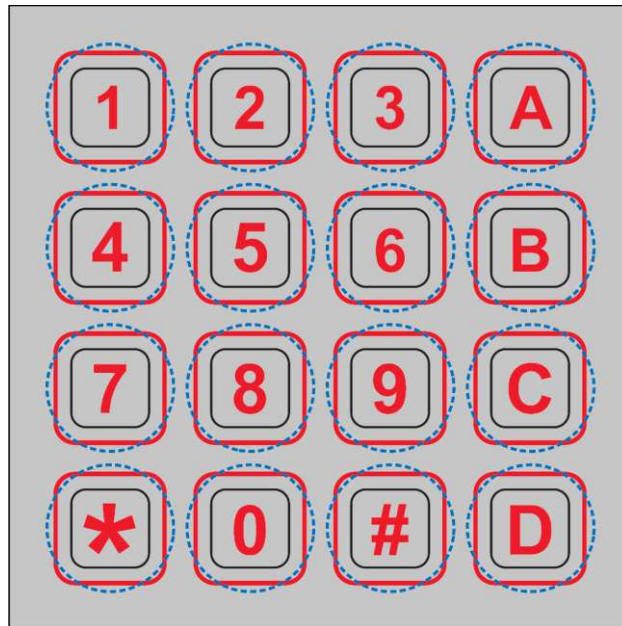

 30. PCB Spacer Cutouts Relative to Surface Overlay

3.4 Heat Compression Technique

One advanced technique to improve the assembly process is to use a heat press. Heat reduces both the required force and duration of compression to create a permanent bond. Consult with a PSA manufacturer such as 3M for the recommendations for a specific material. [Figure 31](#) shows an example of a heat compression technique to evenly compress the surface of the TIDA-01102 reference design to reduce the amount of force during assembly.



図 31. Example Compression Technique Using Heat Press

4 Testing and Results

With a fully assembled and programmed system, the TIDA-01102 is subjected to a variety of tests to check the performance and reliability.

4.1 Raw Data versus Force

One of the key specifications for a button panel is how much force is required to trigger a button press and the lightest reliable force that can be detected. As shown in [Figure 32](#), an analog force gauge with output in Newtons is used to press the metal surface at the indicated button locations of the TIDA-01102 and correlate the output readings to known forces. The TIDA-01102 reference design is connected to the computer through the USB cable, which is running the GUI for data streaming and data logging during the testing to record the data for analysis.



Figure 32. Test Setup With Newton Meter to Check TIDA-01102 Response to Known Forces

The analog force gauge has a rubber tip that acts like a concentrated load, similar to the tip of a finger. During this test, button 8 was pressed directly in the center of the button overlay, as shown in [図 33](#).



図 33. Button Press Location With Concentrated Load

With the TIDA-01102 powered on and connected to the GUI for data streaming, varying amounts of force were applied to button 8 and the response was recorded on all channels, as shown in [図 34](#).

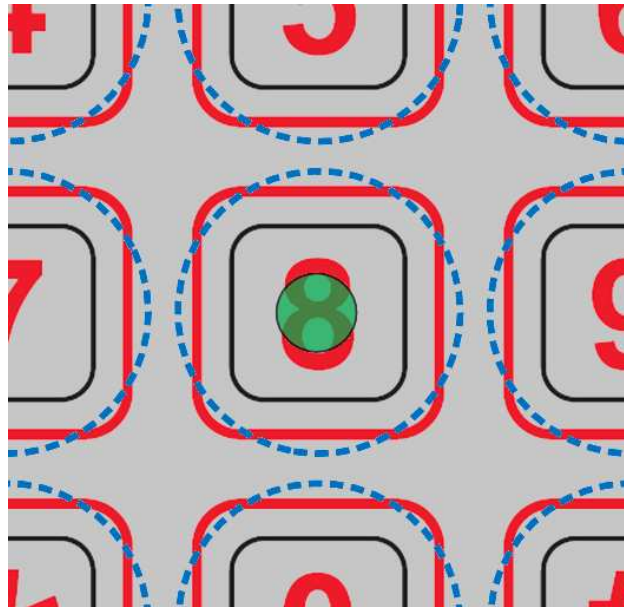

図 34. TIDA-01102 Output Response With 2-, 4-, 8-, and 16-N Force

The results are recorded in the time domain where the x-axis is real time samples and y-axis is the processed output using the algorithms outlined in 2.4. The data shows a very clear and repeatable signal above the noise floor and almost no positive crosstalk. Some negative crosstalk occurs for very strong button presses, which indicates that the surrounding metal is rising similar to a teeter totter as shown in 35.

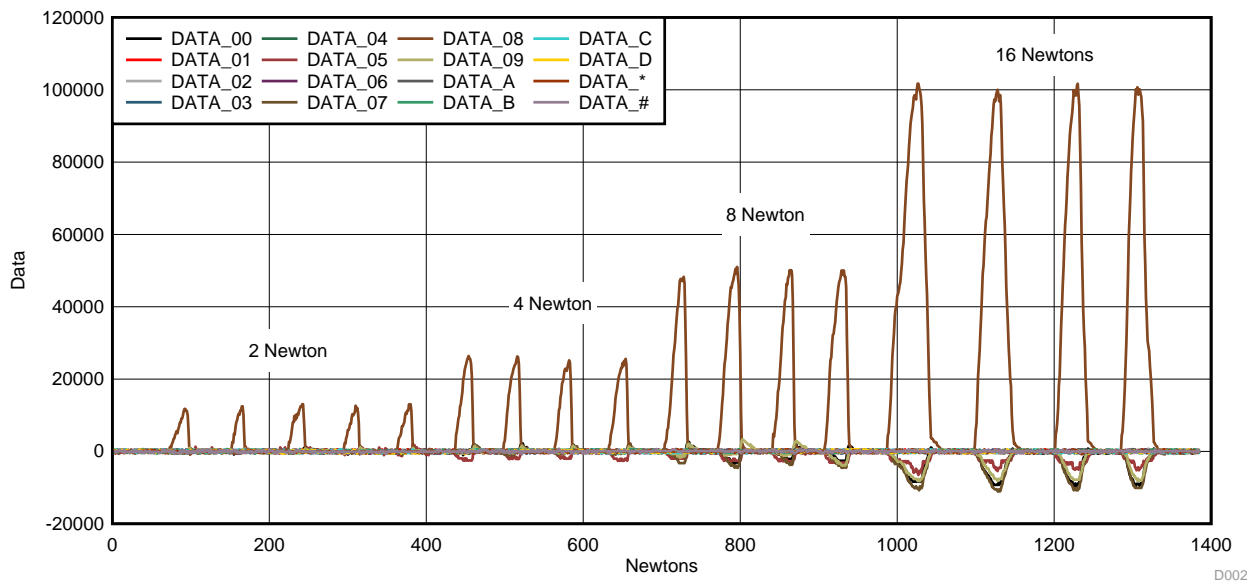

図 35. Extremely Strong Force Causing Teeter Totter Effect

The teeter totter effect can be eliminated if the standoff or spacer is constructed together with the metal surface. An example of this may be to use a single sheet of metal and mill out the metal underneath the button to create a recessed area that provides room for deflection as well as mechanical isolation between channels. For more information on this approach, see the "Mounting Techniques" section of the *Inductive Sensing Touch-On-Metal Buttons Design Guide*[1].

4.2 Measured Noise

The noise level of an inductive touch system determines how accurately the LDC can measure a response due to a button press. Therefore, to give the designer the most flexibility on mechanical and system level constraints, the noise level should be optimized. The noise level can be reduced in a number of ways including increasing the RCOUNT setting of the LDC1614 or by providing a stable reference clock oscillator to the CLKIN pin of the LDC1614.

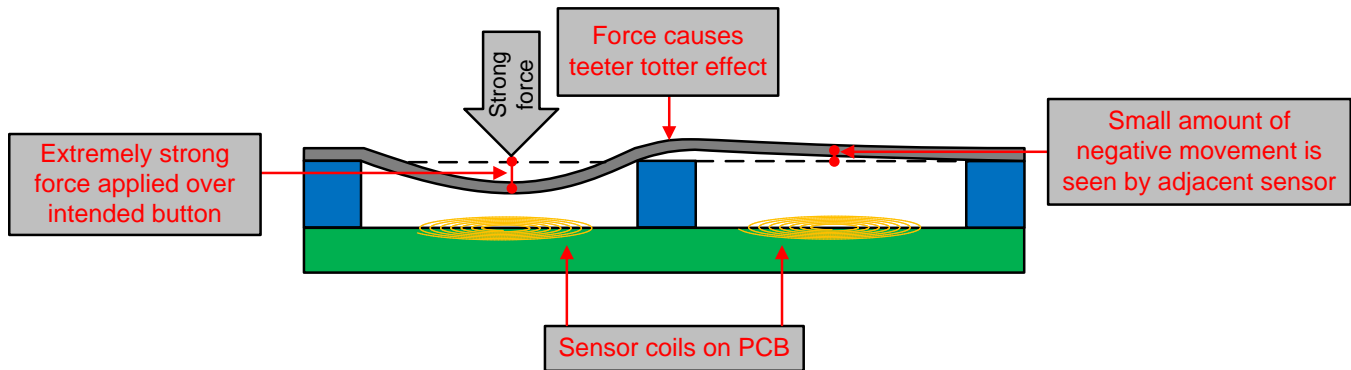
4.2.1 Effect of RCOUNT on Noise

By increasing the RCOUNT setting, the conversion time is increased, which effectively allows the LDC1614 to take a longer and more accurate measurement[4]. Typically, the maximum RCOUNT setting is dictated by the desired sample rate. The TIDA-01102 uses a 1-ms conversion time per channel, which means the maximum RCOUNT setting is 09C3.

4.2.2 Effect of Reference Clock Quality on Noise

By providing a frequency-stable external oscillator, the LDC1614 can minimize the low frequency drift of the reference oscillator, which shows up as noise from measurement to measurement. The LDC1614 also has an internal oscillator that can be used in cost-sensitive systems at the tradeoff of increased noise. [Figure 36](#) shows the noise level of a fully assembled TIDA-01102 design measured over one minute using the internal oscillator and an RCOUNT setting of 09C3. The measured noise standard deviation (σ_{noise}) is on average about 477 codes across all channels.

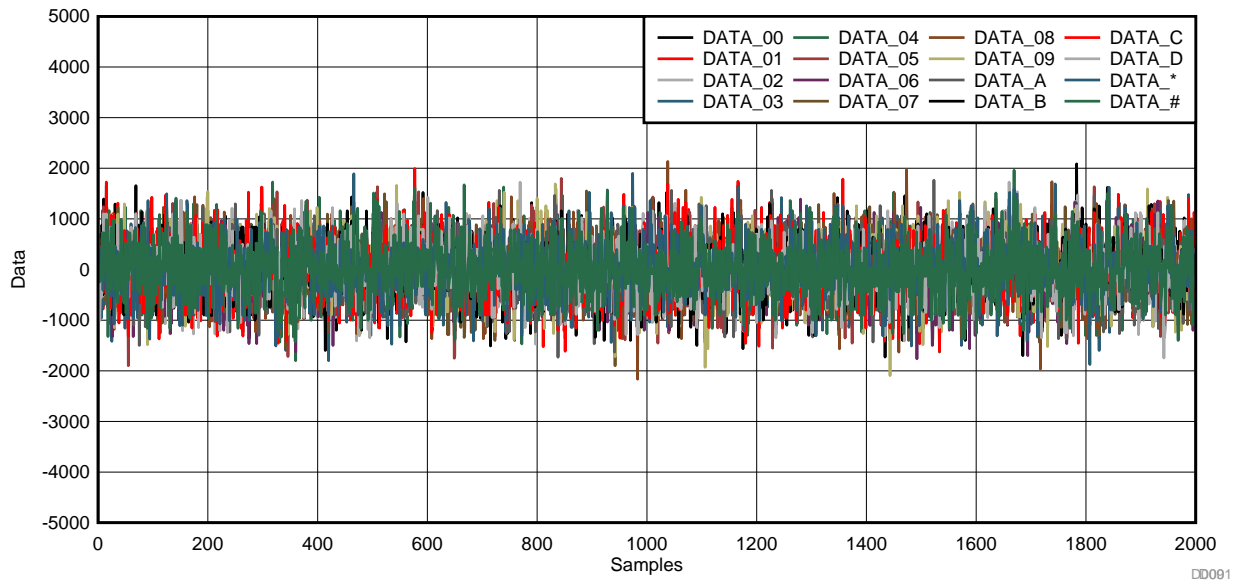

Figure 36. Noise Level Recorded Over 1 Minute With Internal Reference Clock

[Figure 37](#) shows the same measurement but with a 40-MHz external oscillator with a 50-ppm frequency stability, which is included on the BOM (see [5.2](#)). The measured noise standard deviation (σ_{noise}) is on average about 214 codes across all channels. The effect of using an external oscillator has improved the noise level by a factor of 2.2 times.

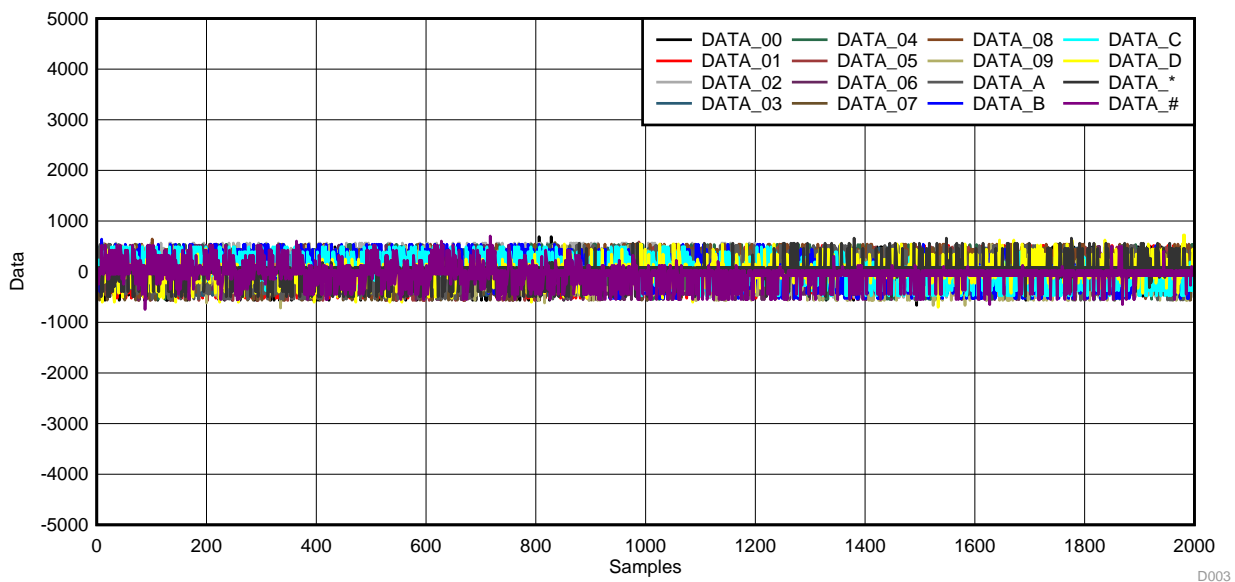
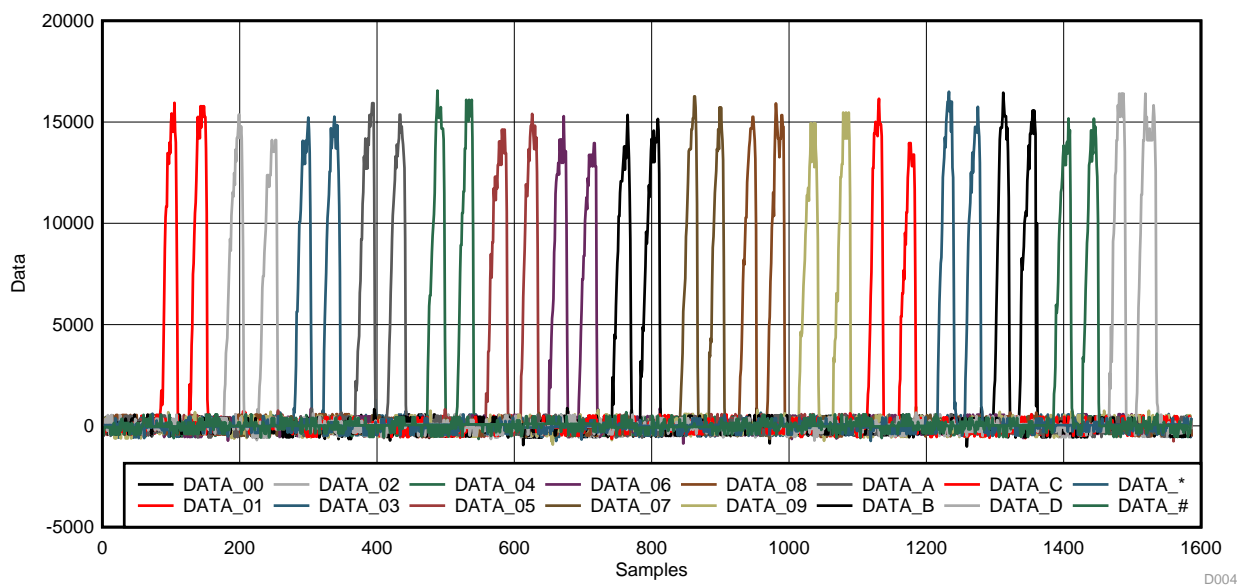

Figure 37. Noise Level Recorded Over 1 Minute With External Reference Clock

4.3 Signal-to-Noise Ratio (SNR)

A very important factor in determining a reliable threshold setting is how large the button press signal is compared to the system noise. This concept is known as SNR. The SNR is dependent on many system level factors including the sensor characteristics, device settings, measurement time, reference oscillator quality, proximity to metal, and so on. Therefore, it is important to measure the SNR with a fully assembled system. From 4.2.2, the σ_{noise} of the TIDA-01102 is measured to be 214 across all channels. To account for worst case noise (peak noise), a $6 \times \sigma_{noise}$ noise level is considered. This means that the button detection threshold setting should not be set lower than 1,284 for this TI Design. Typically, a value that is 10x greater than $6 \times \sigma_{noise}$ is chosen to ensure system robustness, which occurs for an output code of 12,840.

It is also important to record the response across all channels to see if calibration is required. 38 shows the response on all channels for a button force of 2 N.



38. Time Domain TIDA-1102 Response With 2-N Force Applied to Each Button Twice

This test was repeated for several forces to gather the force versus average output code response for all channels, as shown in 39 along with the peak noise level.

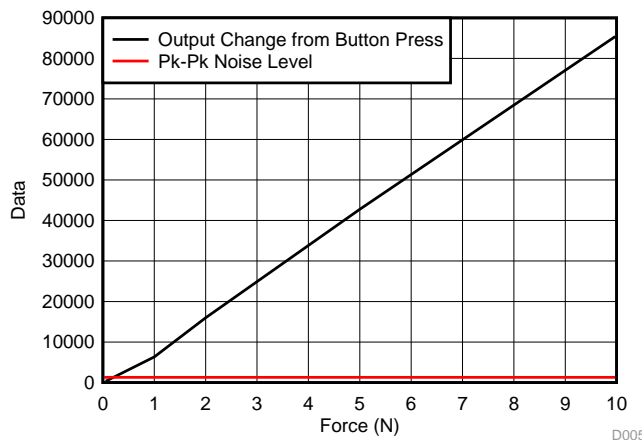

39. Code Change versus Force

The minimum detectable force occurs at the crossing point of the peak noise level of 1284 at a force level of 0.25 N. For system robustness, a threshold setting of 12,840 is chosen for the TIDA-01102 which is 10x the peak noise and occurs at a force level of 1.6 N.

The SNR is simply the output code response for a given force over the peak noise. SNR can be expressed in decibels (dB) with 式 3:

$$SNR = 20 \times \log_{10} \left(\frac{\Delta_{Code}}{(6 \times \sigma_{noise})} \right) \tag{3}$$

Where:

- SNR is calculated the signal-to-noise ratio
- Δ_{Code} is the measured delta in codes between the raw data and the baseline
- σ_{noise} is the standard deviation of the measured noise

図 40 shows the SNR response of the system and the threshold setting at 10 occurring at 1.6 N of force.



図 40. SNR in dB versus Force

4.4 Output Response versus Button Press Location

The location of the button press relative to the center of the button has an impact on how much code change is seen at the output. During this testing, the location of the button press was varied with respect to the radius of the button as shown in 図 41.

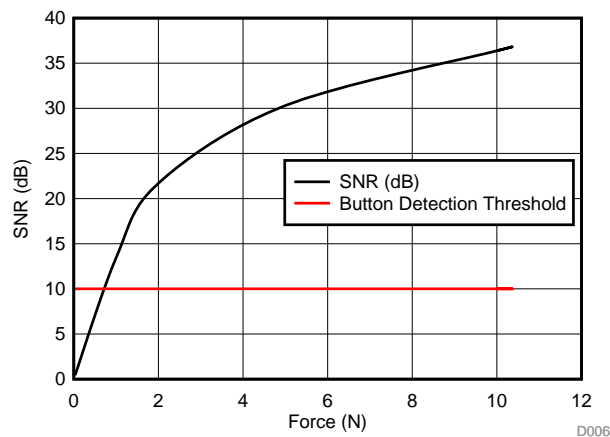

図 41. Sweep Location of Button Press

図 42 shows the corresponding output in processed codes for a fixed force as it is swept along the path. The maximum response is seen when the button is pressed directly in the center and has a reduced response near the edges.

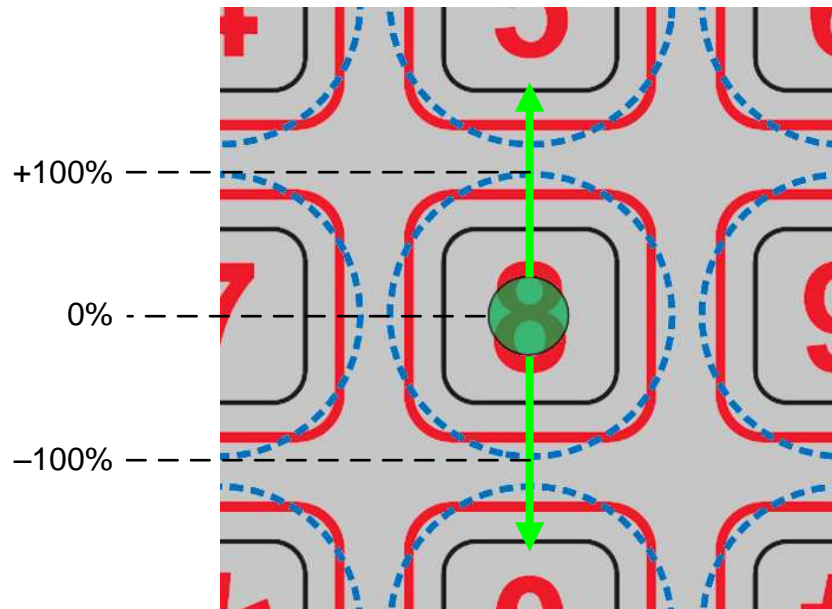

図 42. Output Code versus Button Press Location

4.5 EMI Radiated Test Report (CISPR 22)

This TIDA-01102 reference design was submitted to EMI radiated emissions testing according to the CISPR 22 standard. The test setup included an antenna to scan for radiated emissions from 30 MHz to 1 GHz. The antenna can rotate 90 degrees to check both the electric field and magnetic field emissions. Additionally, the TIDA-01102 was rotated 360 degrees to ensure that all orientations were covered. A photo of the test setup is shown in 図 43.

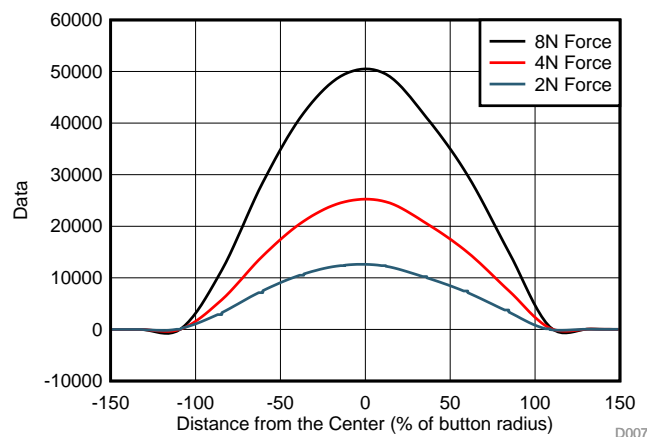

図 43. EMI Setup for CISPR22 Emissions Testing

The test conditions are called out in [44](#).

FC-3
Radiated Emissions 30-1000MHz
Highest Generated Frequency:
Temperature: 21.1C
Humidity: 50%
Atmospheric Pressure: 101.0kPa
Laptop with LDC1614-4LDC

Test Equipment:

ID	Asset #/Serial #	Description	Model	Calibrated Date	Cal Due Date
T1	AN00852	Biconilog Antenna	CBL 6111C	11/24/2014	11/24/2016
T2	ANP00880	Cable	RG214U	5/10/2016	5/10/2018
T3	ANP06691	Cable	PE3062-180	8/8/2014	8/8/2016
T4	AN00971A	Preamp	8447D	2/5/2016	2/5/2018
T5	ANP01187	Cable	CNT-195	12/30/2014	12/30/2016
	AN03471	Spectrum Analyzer	E4440A	1/4/2016	1/4/2018

44. EMI Radiated Emissions Test Conditions

[45](#) shows the output spectrum of the TIDA-01102 in the vertical antenna position.

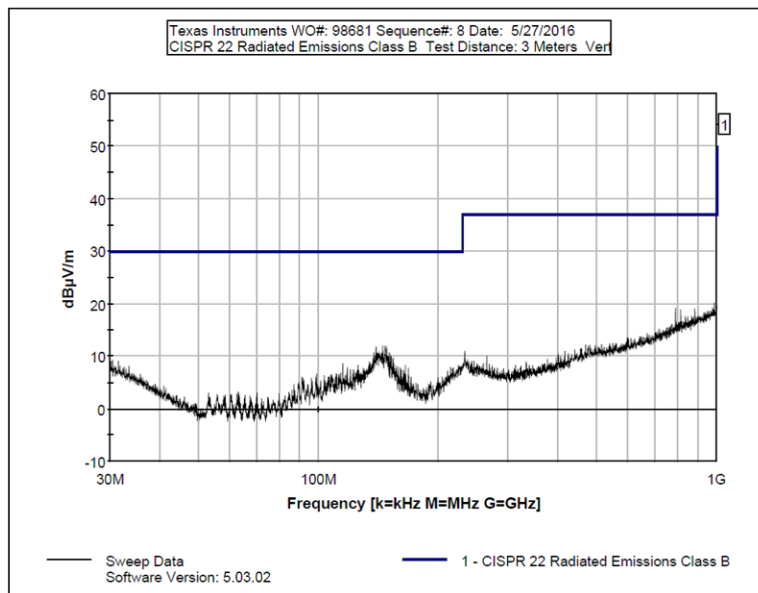

45. TIDA-01102 CISPR 22 Results for Vertical Orientation

☒ 46 shows the output spectrum of the TIDA-01102 in the horizontal antenna position.

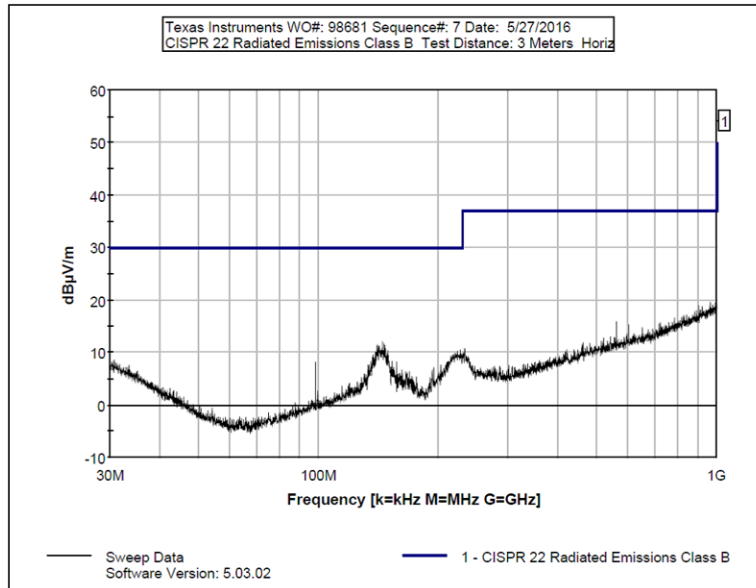

☒ 46. TIDA-01102 CISPR 22 Results for Horizontal Orientation

4.6 EMI Susceptibility Test Report (CISPR 24)

This TIDA-01102 reference design was submitted to EMI susceptibility testing according to the CISPR 24 standard. The test setup included an antenna to radiate frequencies from 80 MHz to 1 GHz at a level of 3 V/m. The antenna can rotate 90 degrees to check both the electric field and magnetic field susceptibility. Additionally, the TIDA-01102 was rotated 360 degrees to ensure that all orientations were covered. The TIDA-01102 was connected to a computer to log the raw data output to examine the EMI susceptibility. A photo of the test setup is shown in ☒ 47.



図 47. EMI Setup for CISPR 24 Susceptibility Testing

During all phases of the testing, the TIDA-01102 was fully powered and recording data. The worst case results are shown in 図 48. Note that the threshold to trigger a button press in this setup is set to 12,000.

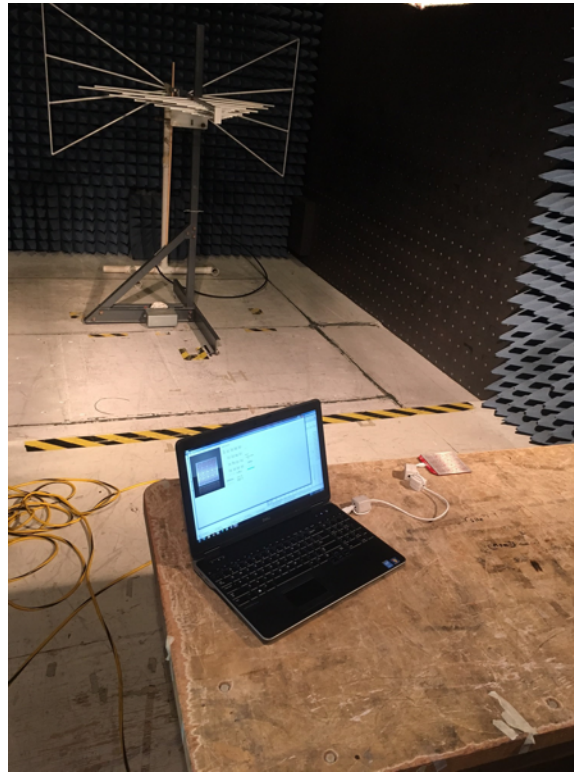

図 48. TIDA-01102 CISPR 24 EMI Susceptibility Raw Output

This testing shows that the TIDA-01102 design passes CISPR susceptibility for all frequencies 80 MHz to 1 GHz with over 11,000 codes of margin.

5 Design Files

5.1 Schematics

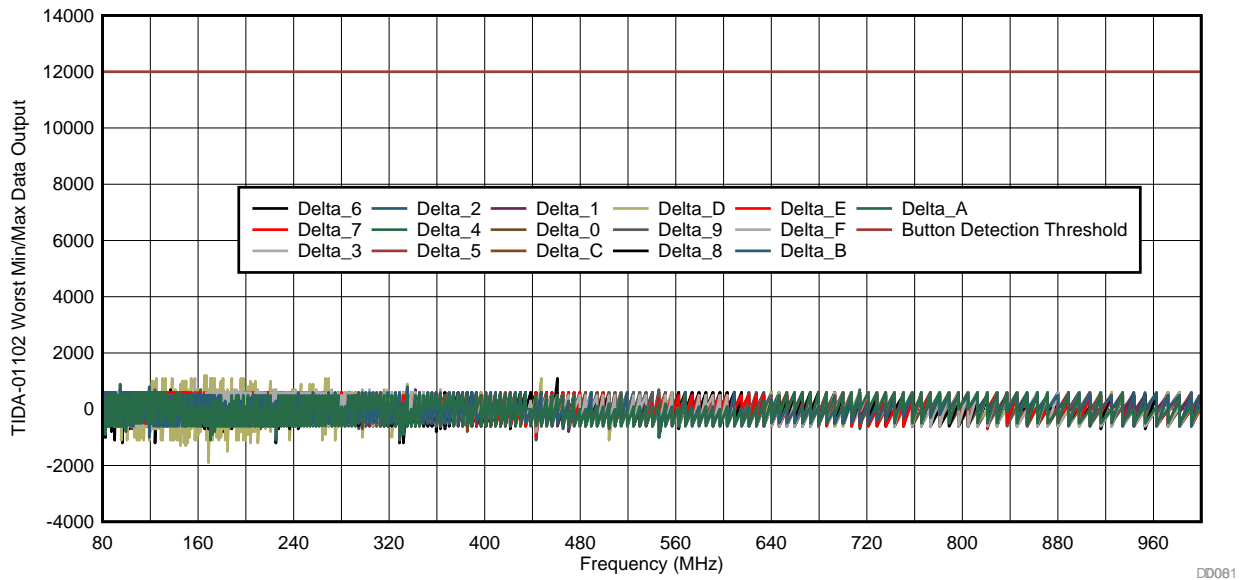
To download the schematics, see the design files at [TIDA-01102](#).

5.2 Bill of Materials

To download the bill of materials (BOM), see the design files at [TIDA-01102](#).

5.3 PCB Layout Recommendations

5.3.1 Layout Prints

To download the layer plots, see the design files at [TIDA-01102](#).

5.4 Altium Project

To download the Altium project files, see the design files at [TIDA-01102](#).

5.5 Gerber Files

To download the Gerber files, see the design files at [TIDA-01102](#).

5.6 Assembly Drawings

To download the assembly drawings, see the design files at [TIDA-01102](#).

5.7 Mechanical Design Files

To download the mechanical design files, see the design files at [TIDA-01102](#)

6 Software Files

To download the software files, see the design files at [TIDA-01102](#).

7 Related Documentation

1. Texas Instruments, [Inductive Sensing Touch-On-Metal Buttons Design Guide](#) (SNOA951)
2. Texas Instruments, [Touch on Metal Buttons With Integrated Haptic Feedback Reference Design](#), TIDA-00314 Design Guide (TIDU613)
3. Texas Instruments, [LDC1314 Inductance-to-Digital Converter Evaluation Module](#), LDC1314 Product Page (<http://www.ti.com/tool/LDC1314KEYPAD-EVM>)
4. Texas instruments, [Optimizing L Measurement Resolution for the LDC161x and LDC1101](#), LDC1614 Application Report (SNOA944)
5. Texas instruments, [Inductive Sensing Design Calculator Tool](#) (SLYC137)
6. Azo Materials, [Stainless Steel - Grade 304 \(UNS S30400\)](#), Product Page (<http://www.azom.com/properties.aspx?ArticleID=965>)
7. [Properties table of Stainless steel, Metals and other Conductive materials](#) (<http://www.tibtech.com/conductivity.php>)

7.1 商標

MSP430 is a trademark of Texas Instruments.

すべての商標および登録商標はそれぞれの所有者に帰属します。

8 About the Author

LUKE LAPOINTE is an applications engineer at Texas Instruments, where he supports inductive sensing applications, developing reference designs and new products. Luke earned a bachelor of science in electrical engineering and a bachelor of science in computer engineering from Michigan State University.

TIの設計情報およびリソースに関する重要な注意事項

Texas Instruments Incorporated ("TI")の技術、アプリケーションその他設計に関する助言、サービスまたは情報は、TI製品を組み込んだアプリケーションを開発する設計者に役立つことを目的として提供するものです。これにはリファレンス設計や、評価モジュールに関する資料が含まれますが、これらに限られません。以下、これらを総称して「TIリソース」と呼びます。いかなる方法であっても、TIリソースのいずれかをダウンロード、アクセス、または使用した場合、お客様(個人、または会社を代表している場合にはお客様の会社)は、これらのリソースをここに記載された目的にのみ使用し、この注意事項の条項に従うことに合意したものとします。

TIによるTIリソースの提供は、TI製品に対する該当の発行済み保証事項または免責事項を拡張またはいかなる形でも変更するものではなく、これらのTIリソースを提供することによって、TIにはいかなる追加義務も責任も発生しないものとします。TIは、自社のTIリソースに訂正、拡張、改良、およびその他の変更を加える権利を留保します。

お客様は、自らのアプリケーションの設計において、ご自身が独自に分析、評価、判断を行う責任がお客様にあり、お客様のアプリケーション(および、お客様のアプリケーションに使用されるすべてのTI製品)の安全性、および該当するすべての規制、法、その他適用される要件への遵守を保証するすべての責任をお客様のみが負うことを理解し、合意するものとします。お客様は、自身のアプリケーションに関して、(1) 故障による危険な結果を予測し、(2) 障害とその結果を監視し、および、(3) 損害を引き起こす障害の可能性を減らし、適切な対策を行う目的で、安全策を開発し実装するために必要な、すべての技術を保持していることを表明するものとします。お客様は、TI製品を含むアプリケーションを使用または配布する前に、それらのアプリケーション、およびアプリケーションに使用されているTI製品の機能性を完全にテストすることに合意するものとします。TIは、特定のTIリソース用に発行されたドキュメントで明示的に記載されているもの以外のテストを実行していません。

お客様は、個別のTIリソースにつき、当該TIリソースに記載されているTI製品を含むアプリケーションの開発に関連する目的でのみ、使用、コピー、変更することが許可されています。明示的または黙示的を問わず、禁反言の法理その他どのような理由でも、他のTIの知的所有権に対するその他のライセンスは付与されません。また、TIまたは他のいかなる第三者のテクノロジーまたは知的所有権についても、いかなるライセンスも付与されるものではありません。付与されないものには、TI製品またはサービスが使用される組み合わせ、機械、プロセスに関連する特許権、著作権、回路配置利用権、その他の知的所有権が含まれますが、これらに限られません。第三者の製品やサービスに関する、またはそれらを参照する情報は、そのような製品またはサービスを利用するライセンスを構成するものではなく、それらに対する保証または推奨を意味するものでもありません。TIリソースを使用するため、第三者の特許または他の知的所有権に基づく第三者からのライセンス、あるいはTIの特許または他の知的所有権に基づくTIからのライセンスが必要な場合があります。

TIのリソースは、それに含まれるあらゆる欠陥も含めて、「現状のまま」提供されます。TIは、TIリソースまたはその仕様に関して、明示的か暗黙的にかかわらず、他のいかなる保証または表明も行いません。これには、正確性または完全性、権原、続発性の障害に関する保証、および商品性、特定目的への適合性、第三者の知的所有権の非侵害に対する黙示的保証が含まれますが、これらに限られません。

TIは、いかなる苦情に対しても、お客様への弁護または補償を行う義務はなく、行わないものとします。これには、任意の製品の組み合わせに関連する、またはそれらに基づく侵害の請求も含まれますが、これらに限られず、またその事実についてTIリソースまたは他の場所に記載されているか否かを問わないものとします。いかなる場合も、TIリソースまたはその使用に関連して、またはそれらにより発生した、実際の、直接的、特別、付随的、間接的、懲罰的、偶発的、または、結果的な損害について、そのような損害の可能性についてTIが知らされていたかどうかにかかわらず、TIは責任を負わないものとします。

お客様は、この注意事項の条件および条項に従わなかったために発生した、いかなる損害、コスト、損失、責任からも、TIおよびその代表者を完全に免責するものとします。

この注意事項はTIリソースに適用されます。特定の種類の資料、TI製品、およびサービスの使用および購入については、追加条項が適用されます。これには、半導体製品(<http://www.ti.com/sc/docs/stdterms.htm>)、評価モジュール、およびサンプル(<http://www.ti.com/sc/docs/sampterm.htm>)についてのTIの標準条項が含まれますが、これらに限られません。