

TI Designs: TIDA-01424 車載用超音波キック・オープンのリファレンス・デザイン



概要

このリファレンス・デザインは、キック動作を検出します。これは、ユーザーが自動車のパワー・リフト・ゲート、パワー・トランク、またはパワー・スライド・ドアを動作させるという意思を示すものです。このデザインは分解能が高く、消費電力が低いため、ジェスチャ検出とバッテリーからの低消費電流が非常に重要な、車載用のハンズフリー開閉システムに応用できます。

2つの独立した超音波トランスデューサ・チャンネルにより、2つのセンサからの入力が可能のため、精巧なジェスチャ検出アルゴリズムが可能になり、広い範囲のジェスチャを検出できます。このリファレンス・デザインは、LaunchPad™ フォーマットの小さな2レイヤのボードとして実装され、単純なインターフェイスにより任意の3.3Vマイクロコントローラ (MCU)へ接続できます。

12Vの車載用バッテリー・システムから、外部のMCUや、オンボード・コンポーネント用の安定した3.3V電源が直接供給されます。このデザインは、バッテリーの逆極性の接続などのフォルトから保護されており、最大40Vまでの入力電圧に耐えられます。オンボードの手動スイッチは、車両用セキュリティ・システムからのキー・フォブ検出信号の機能をエミュレートします。

リソース

- TIDA-01424
- PGA460-Q1
- TPS1H100-Q1
- TPS7B6933-Q1
- TPS3700-Q1

- デザイン・フォルダ
- プロダクト・フォルダ
- プロダクト・フォルダ
- プロダクト・フォルダ
- プロダクト・フォルダ



E2Eエキスパートに質問

特長

- 2つの超音波センサ・チャンネル
- 12Vの車載用バッテリーで動作
- 最大50cmの距離からキックを検出
- 低い静止電流
- バッテリ逆極性保護
- MCUへの単純なインターフェイス
 - UARTシリアル通信
 - キー・フォブ信号
 - パワー・イネーブル信号
- オンボードの3.3V電源

アプリケーション

- 車両トランクのキック・オープン
- 車両リフト・ゲートのキック・オープン
- 車両スライド・ドアのキック・オープン
- その他ハンズフリーの車載用途

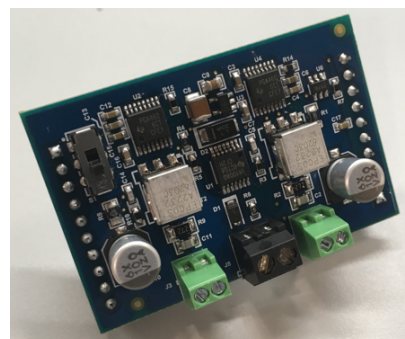
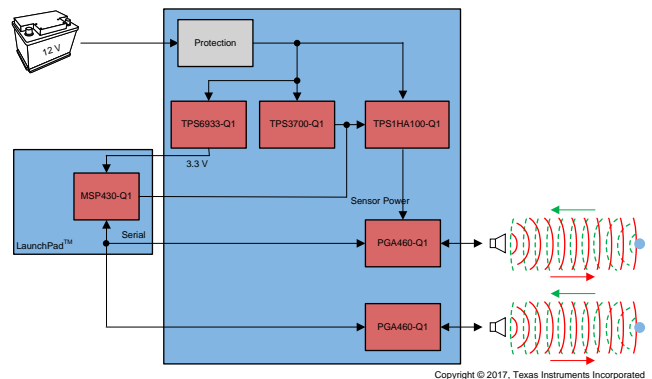



使用許可、知的財産、その他免責事項は、最終ページにあるIMPORTANT NOTICE(重要な注意事項)をご参照くださいますようお願いいたします。英語版のTI製品についての情報を翻訳したこの資料は、製品の概要を確認する目的で便宜的に提供しているものです。該当する正式な英語版の最新情報は、www.ti.comで閲覧でき、その内容が常に優先されます。TIでは翻訳の正確性および妥当性につきましては一切保証いたしません。実際の設計などの前には、必ず最新版の英語版をご参照くださいますようお願いいたします。

1 System Description

The TIDA-01424 ultrasonic, kick-to-open reference design provides a simple implementation of gesture recognition using two PGA460-Q1 automotive, ultrasonic signal processor and transducer driver integrated circuits. When connected to two external ultrasonic transducers, this design provides all the analog signal processing to excite the ultrasonic transmitter structure of each sensor circuit and to detect the ultrasonic echos reflected from objects in the path of the transducers.

This sensed data is processed and compared to user-optimized threshold levels to determine the distance to each detected object. The system is flexible to allow for optimization of the gesture detection algorithm based on the digital data from the PGA460-Q1, which is available as serial data over the UART communications link.

This design is implemented as a small BoosterPack™ board with only two layers to keep the design cost effective. The simple, 20-pin interface to an external MCU with a UART serial port and a few general purpose input-output (GPIO) signals, conforms to the LaunchPad 20-pin standard; the testing described in this document was performed using an MSP430F5529 LaunchPad with code based on examples already available on the TI website. The reference design is powered by a standard, 12-V, automotive, battery system and is protected against reverse battery conditions and high voltage up to 40 V that may be experienced during a load dump event on the input supply. When placed in shutdown mode, the entire design has an input current less than 100 μ A, which allows this design to be connected directly to the battery system without excessive battery current drain. The components selected for this design are rated for automotive applications.

1.1 Key System Specifications

表 1. Key System Specifications

PARAMETER	SPECIFICATIONS
Number of ultrasonic transducers	Two
Type of ultrasonic transducer	Closed top (transformer driven)
Power supply voltage range (operational)	6 V to 18 V
Power supply voltage range (survivable)	-20 V (reverse battery) up to 40 V (load dump)
Power supply current (operational)	40 mA
Power supply current (shutdown)	50 μ A (maximum)
Sense range (minimum)	200 mm
Sense range (maximum)	500 mm
Kick gesture duration	1 s to 4 s
Sense sampling rate	5 to 40 samples per second
Board layers	Two
Board form factor	BoosterPack

2 System Overview

2.1 Block Diagram



図 1. TIDA-01424 Block Diagram

The block diagram in 図 1 shows the reference design components in the blue central block along with the external ultrasonic transducers, the external 12-V automotive battery power supply, and the external MSP430™ LaunchPad MCU board.

2.2 Design Considerations

To simplify this reference design and make the design more adaptable to a variety of MCUs, the board was implemented in the BoosterPack format. This board format has a simple connector interface to the external LaunchPad MCU board, which allows evaluation of the ultrasonic kick-to-open reference design with a wide selection of MCUs. The LaunchPad plus BoosterPack implementation also has the advantage that code development and design testing are facilitated by existing tools such as Code Composer Studio™ or Energia, thus speeding up optimization of the design for any specific operating conditions. While the BoosterPack format does allow flexibility in using different MCU boards, the format also creates constraints on the size and layout of the ultrasonic kick-to-open board. In a production version of this design, the MCU would likely be installed on the same board with the PGA460-Q1 chips and other components with a possible reduction in board size.

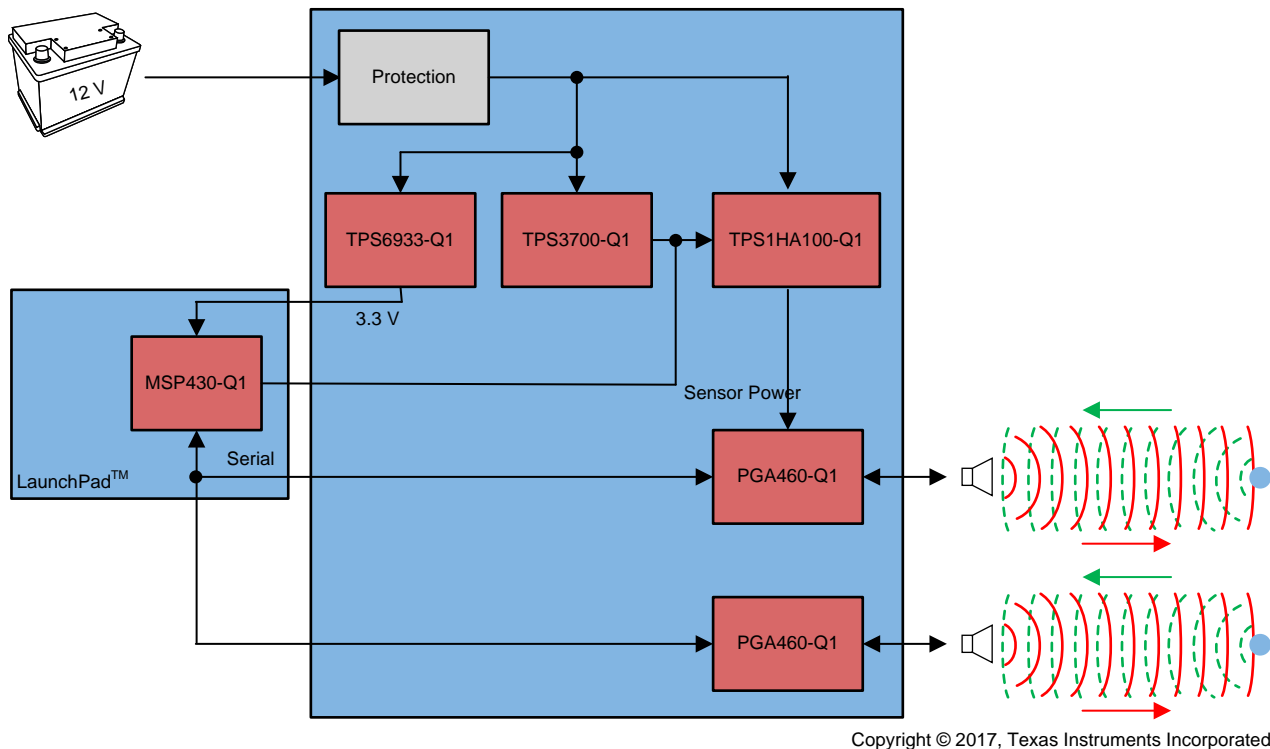
Another consideration is selection of the passive components. In general, components were selected based on the performance requirements of the expected applications. Where practical, components with automotive ratings were selected. For active components, the components selected are AEC-Q100 qualified to either temperature grade 0 or temperature grade 1.

Capacitors are generally X7R grade (-55°C to 125°C) or higher with size and value selected for the expected extremes of operation conditions. The voltage rating of the capacitors must be greater than the maximum voltage they could experience and two times the typical operating voltage to avoid DC bias effects. The amount of output capacitance used depends on output ripple and transient response requirements, and many equations and tools are available online to help estimate these values.

2.3 Highlighted Products

2.3.1 PGA460-Q1

The PGA460-Q1 device is a highly-integrated, system on-chip (SoC), ultrasonic transducer driver and signal conditioner with an advanced DSP core. The device has a complimentary low-side driver pair that can drive a transducer either in a transformer-based topology using a step-up transformer or in a direct-drive topology using external high-side FETs. The device can receive and condition the reflected echo signal for reliable object detection. This feature is accomplished using an analog front-end (AFE) consisting of a low-noise amplifier followed by a programmable, time-varying, gain stage feeding into an analog-to-digital converter (ADC). The digitized signal is processed in the DSP core for both near-field and far-field object detection using time-varying thresholds.

The main communication with an external controller is achieved by either a time-command interface (TCI) or a one-wire, USART, asynchronous interface on the IO pin or a CMOS-level, USART interface on the RXD and TXD pins. The PGA460-Q1 can be put in ultra-low quiescent current, low-power mode to reduce power consumption when not in use and can be woken up by commands on the communication interfaces.

The PGA460-Q1 also includes on-chip system diagnostics that monitor transducer voltage during burst, frequency, and decay time of transducer to provide information about the integrity of the excitation as well as supply-side and transceiver-side diagnostics for overvoltage, undervoltage, overcurrent, and short-circuit scenarios.

- AEC-Q100-qualified with the following results:
 - Device temperature grade 2: -40°C to 105°C ambient operating temperature
 - Device HBM ESD classification level 2
 - Device CDM ESD classification level C4B
- Complimentary low-side drivers with configurable current limit supporting both transformer-based and direct-drive topology for transducer excitation
- Single transducer for both burst-listen or a transducer pair, one for burst and other for listen operation
- Low-noise receiver with programmable 6-point, time-varying, gain (32 dB to 90 dB) with DSP (BPF, demodulation) for echo envelope detection
- Two presets of 12-point, time-varying, threshold for object detection
- Timers to measure multiple echo distance and duration
- Integrated temperature sensor
- Record time for object detection up to 11 m
- 128 bytes of RAM for echo recording
- 42 bytes of user EEPROM to store configuration for fast initialization
- One-wire, high-voltage, time-command interface or USART asynchronous interface

- CMOS level USART interface
- Sensor diagnostics (decay frequency and time, excitation voltage), supply, and transceiver diagnostics

Figure 2 shows a block diagram of the PGA460-Q1.

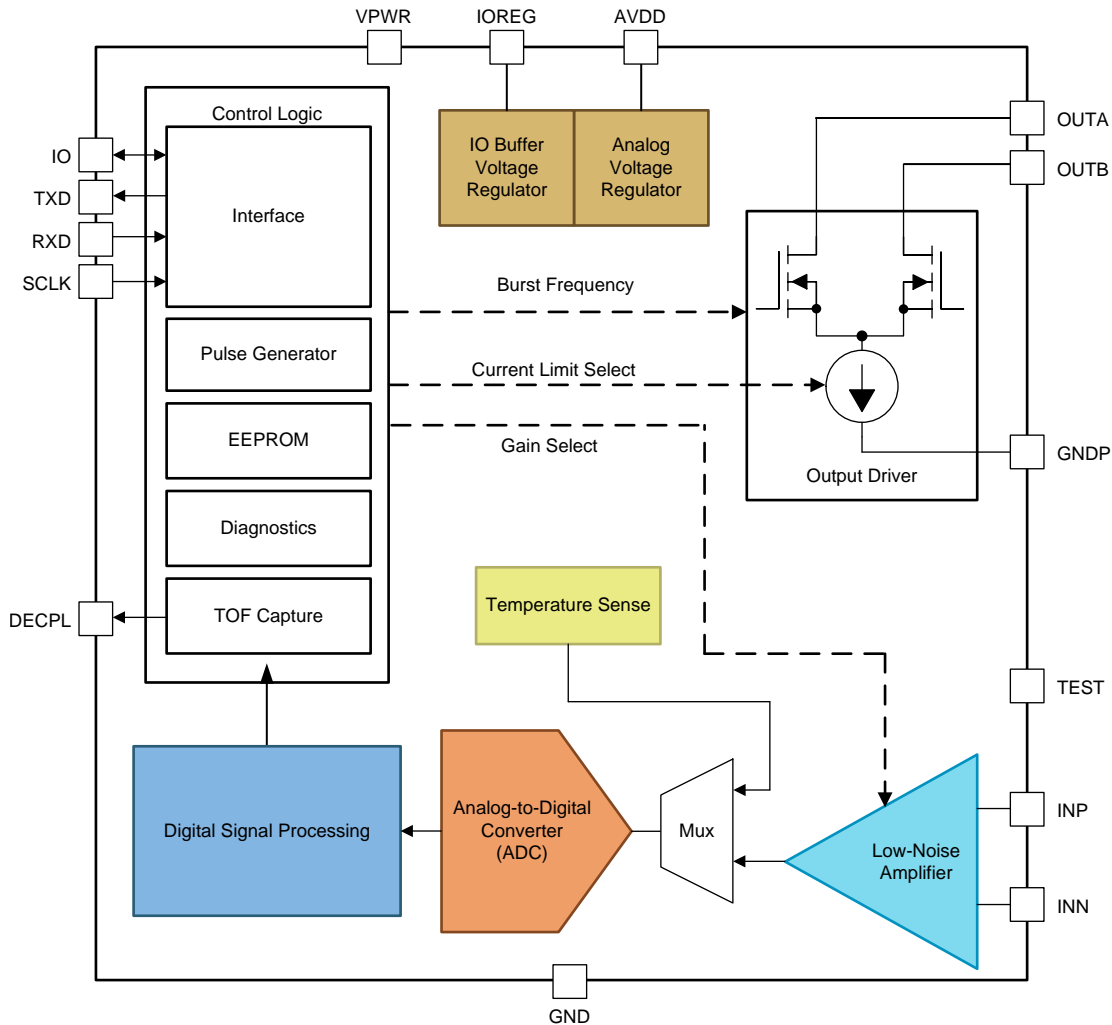

Copyright © 2017, Texas Instruments Incorporated

Figure 2. Functional Block Diagram of PGA460-Q1

2.3.2 TPS1H100-Q1

The TPS1H100-Q1 is a fully-protected, high-side power switch with integrated NMOS power FET and charge pump, targeted for the intelligent control of the variable kinds of resistive, inductive, and capacitive loads. Accurate current sense and programmable current limit features differentiate it from the market.

- Qualified for automotive applications
- AEC-Q100-qualified with the following results:
 - Device temperature grade 1: -40°C to 125°C ambient operating temperature range
 - Device HBM ESD classification level H3A
 - Device CDM ESD classification level C4B
- Single-channel smart high-side power switch with full diagnostics
- Wide operating voltage 3.5 V to 40 V
- Very-low standby current, <0.5 μ A

- Operating junction temperature, -40°C to 150°C
- Input control, 3.3-V and 5-V logic compatible
- Programmable current limit with external resistor, $\pm 20\%$ at 0.5 A
- Tested according to AECQ100-12 grade A, 1 million times short to GND test

☒ 3 shows a block diagram of the TPS1H100-Q1.

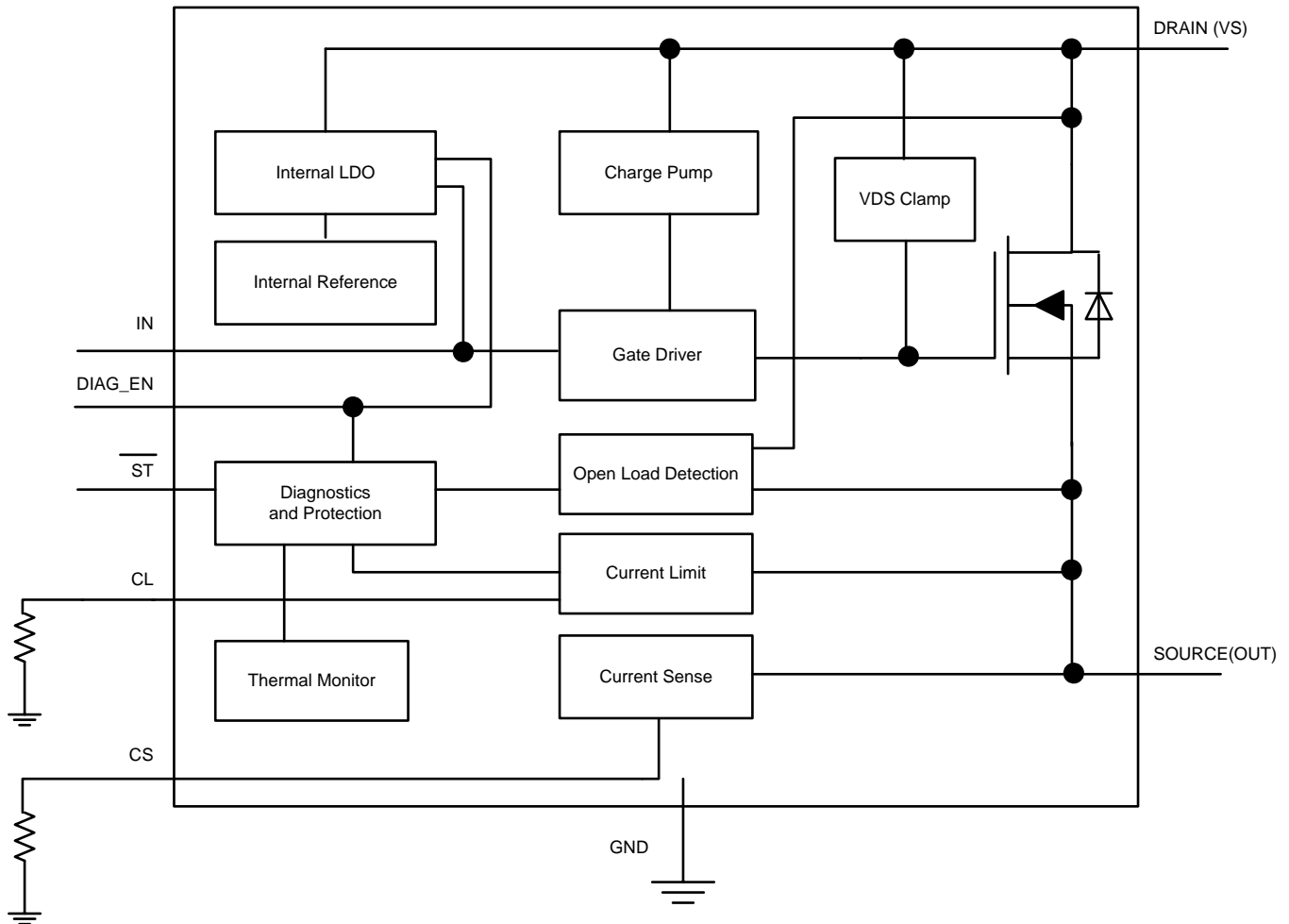

☒ 3. Functional Block Diagram of TPS1H100-Q1

2.3.3 TPS7B6933-Q1

The TPS7B6933-Q1 device is a low-dropout, linear regulator designed for up to up to 40-V operations. With only 15- μA (typical) quiescent current at light load, the device is suitable for standby MCU-unit systems especially in automotive applications. The devices feature an integrated short-circuit and overcurrent protection. The TPS7B6933-Q1 device operates over a -40°C to 125°C temperature range. Because of these features, the device is well suited in power supplies for various automotive applications.

- Qualified for automotive applications
- AEC-Q100 qualified with the following results:
 - Device temperature grade 1: -40°C to 125°C ambient operating temperature range
 - Device HBM ESD classification level 2

- Device CDM ESD classification level C4B
- 4-V to 40-V wide VI input voltage range with up to 45-V transient
- Maximum output current: 150 mA
- Low quiescent current (IQ):
 - 15- μ A typical at light loads
 - 25- μ A maximum under full temperature
- 450-mV typical low dropout voltage at 100-mA load current
- Stable with low ESR ceramic output capacitor (2.2 μ F to 100 μ F)
- Integrated fault protection:
 - Thermal shutdown
 - Short-circuit protection
- 5-Pin SOT-23 package

図 4 shows a block diagram of the TPS7B6933-Q1.



図 4. TPS7B6933-Q1 Functional Block Diagram

2.3.4 TPS3700-Q1

The TPS3700-Q1 wide-supply voltage window comparator operates over a 1.8-V to 18-V range. The device has two high-accuracy comparators with an internal 400-mV reference and two open-drain ambient operating temperature range outputs rated to 18 V for overvoltage and undervoltage detection. The TPS3700-Q1 device can be used as a window comparator or as two independent voltage monitors; the monitored voltage can be set with the use of external resistors.

The OUTA terminal is driven low when the voltage at the INA+ terminal drops below $(VIT+ - V_{hys})$ and goes high when the voltage returns above the respective threshold ($VIT+$). The OUTB terminal is driven low when the voltage at the INB- terminal rises above $VIT+$ and goes high when the voltage drops below the respective threshold ($VIT+ - V_{hys}$). Both comparators in the TPS3700-Q1 device include built-in hysteresis for filtering to reject brief glitches, thereby ensuring stable output operation without false triggering.

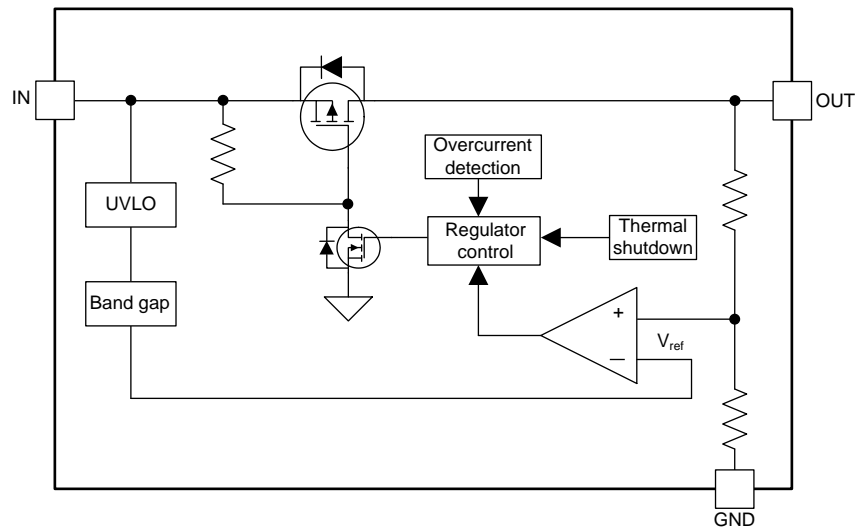
The TPS3700-Q1 device is available in a ThinSOT23-6 package and is specified over the junction temperature range of -40°C to 125°C .

- Qualified for automotive applications
- AEC-Q100-qualified with the following results:
 - Device temperature grade 1: -40°C to 125°C
 - Device HBM ESD classification level H2
 - Device CDM ESD classification level C6
- High threshold accuracy:
 - 1% overtemperature
 - 0.25% (typ)
- Wide supply voltage range: 1.8 V to 18 V
- Open-drain outputs for overvoltage and undervoltage detection
- Low quiescent current: $5.5\ \mu\text{A}$ (typ)

Figure 5 shows a block diagram of the TPS3700-Q1.

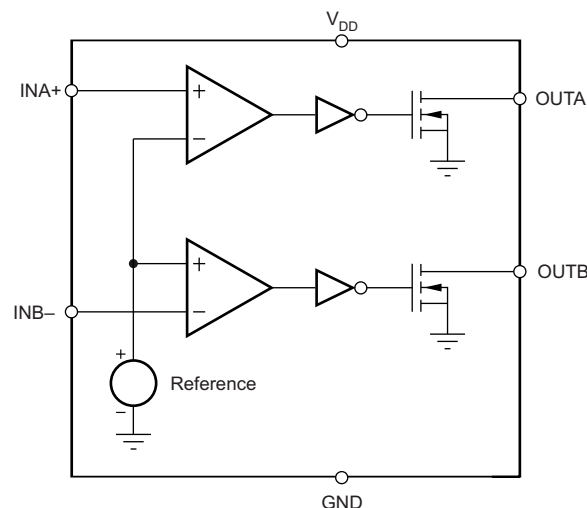

Figure 5. Functional Block Diagram of TPS3700-Q1

2.4 System Design Theory

2.4.1 Power Management

The purpose of the power management section of the design is to provide power to the onboard and external circuits, protect against faults on the input power supply, and implement a low-power mode to keep the input current below $100\ \mu\text{A}$ during periods when the ultrasonic kick-to-open module is not active.

2.4.1.1 3.3-V Power Supply

The TPS7B6933-Q1 provides regulation of a fixed 3.3-V supply and has a wide survivable input voltage range up to 45 V. To improve the load transient performance, an output capacitor, such as a ceramic capacitor with low ESR, is recommended. The device is stable with ceramic output capacitors, which is preferred for automotive applications. For stable operation over the full temperature range and with load currents up to 150 mA, capacitor C9 has a value of 4.7 μ F, which is within the range recommended (2.2 μ F to 100 μ F). The capacitor has an effective series resistance (ESR) of less than 1 Ω ; an ESR smaller than 2 Ω is recommended.

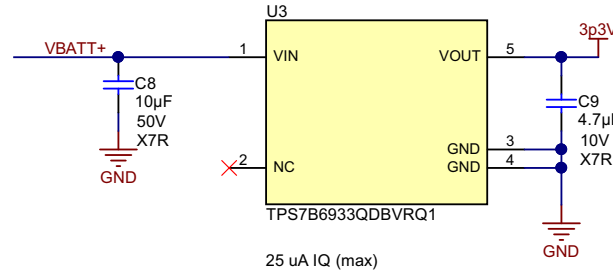

Copyright © 2017, Texas Instruments Incorporated

図 6. Electrical Schematic of 3.3-V Supply Regulator Circuit

2.4.1.2 Input Power Protection

図 7 shows the circuit that protects the TIDA-01424 board from faults on the VBATT input power, such as reverse battery conditions, or overvoltage conditions due to load dump. Diode D1 provides protection against reverse-battery conditions. The SS24FL Schottky barrier rectifier was selected because it has a low-forward voltage of less than 500 mV (at 25°C) and a reverse breakdown voltage of 40 V. The Schottky barrier rectifier is also AEC-Q101 qualified for automotive applications.

The TPS3700-Q1 (U6) is configured to detect when the input power (VBATT+) is experiencing an overvoltage condition. Under normal conditions, the TPS3700-Q1 sets the OUTB open-drain output to high-impedance, which allows the resistor R7 to pull the HS_SW_ON signal high. When an overvoltage fault occurs, the TPS3700-Q1 pulls HS_SW_ON signal to a logic low by turning on the OUTB open-drain output.

Resistors R4 and R5 set the threshold level of VBATT+ for the TPS3700-Q1 to detect an overvoltage condition. The sensed voltage VBATT+SENSE at INB- is compared to the internal positive-going threshold of 400 mV \pm 4 mV. With a value of 976 k Ω for R4 and 22 k Ω for R5, these resistors have a ratio which forms a 45:1 voltage divider. Therefore the 400-mV threshold corresponds to a value of 18 V at VBATT+ or about 18.5 V at VBATT on the input connector. The current through the voltage divider is about 12 μ A when VBATT is at the nominal 12-V level, thus a high current draw is not caused during periods of low-power mode.

R7 and C17 form a pull-up for the HS_SW_ON signal with an R-C time constant of 3.3 ms. This time constant allows the external MCU to pull the HS_SW_ON signal to a low (low-power mode) state periodically without having to continuously maintain a logic low output on the MCU output pin. This process facilitates the MCU being in a low-power mode with periodic wake-up to monitor the state of the key fob and refreshing the low state of the HS_SW_ON signal as necessary.

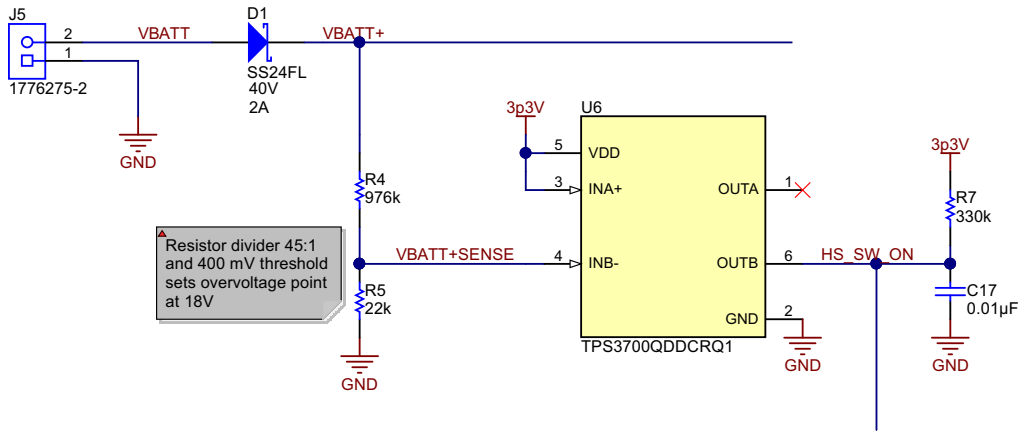

Copyright © 2017, Texas Instruments Incorporated

図 7. Electrical Schematic of Input Power Protection Circuit

2.4.1.3 Low-Power Switch

Figure 8 shows the electrical schematic of the TPS1H100A-Q1 circuit, which is used to apply or remove 12-V power to the PGA460-Q1 devices and the associated ultrasonic transducer driver circuits. The HS_SW_ON signal controls whether the high-side switch between VBATT+ and VPWR is connected or not. The HS_SW_ON signal is by default pulled to a logic high, which enables the connection from VBATT+ to VPWR, thus applying 12-V power to the PGA460-Q1 devices and the associated circuitry. The connection between VBATT+ and VPWR is disconnected under two conditions:

1. When the input voltage VBATT+ is in an overvoltage condition (refer to 2.4.1.2). In the case of an overvoltage condition, the TPS3700-Q1 pulls the HS_SW_ON signal to a logic low.
2. When the ultrasonic kick-to-open module is put in a low-power mode. In the case of low-power mode, the external MCU pulls the HS_SW_ON signal to a logic low state.

The individual shutdown currents of the various components on the board are listed in Table 2.

Table 2. Current From VBATT With TIDA-01424 Board in Shutdown Mode

CIRCUIT	DESCRIPTION	SHUTDOWN CURRENT (μA)
R4, R5	Resistor divider for VBATT+ sense	12 (at 12 V)
U6	TPS3700-Q1 window comparator	6 (typ), 12 (maximum)
U3	TPS7B6933-Q1 voltage regulator	15 (typ), 25 (maximum)
U1	TPS1H100A-Q1 high-side switch	5 (maximum)
—	Total	38 (typ), 54 (maximum)

The diode D2 is used to assure that no fast transients or surges in the input voltage VBATT+ are allowed to propagate to the PGA460-Q1 circuits, where voltages above the 30-V absolute maximum rating on VPWR might cause damage. The SMA6J18A diode is rated for working voltages up to 18 V with a lowest breakdown voltage of 20 V. Any voltage surges that may occur before the TPS3700-Q1 protection occurs will be clamped by the Zener breakdown of D2. For any longer-term overvoltages, the TPS3700-Q1 protection circuit will disconnect VBATT+ from VPWR by turning off the U1 high-side switch.

The resistor R6 sets a current limit for the current through the U1 high-side switch. For this reference design, the current limit resistor of 1 kΩ is relatively high, which allows for flexibility in the transducer selection and total ultrasonic drive current. For any specific application, if the total current for the ultrasonic transducers is known, designers may choose to reduce the current limit by selecting a different (larger) value of R6.

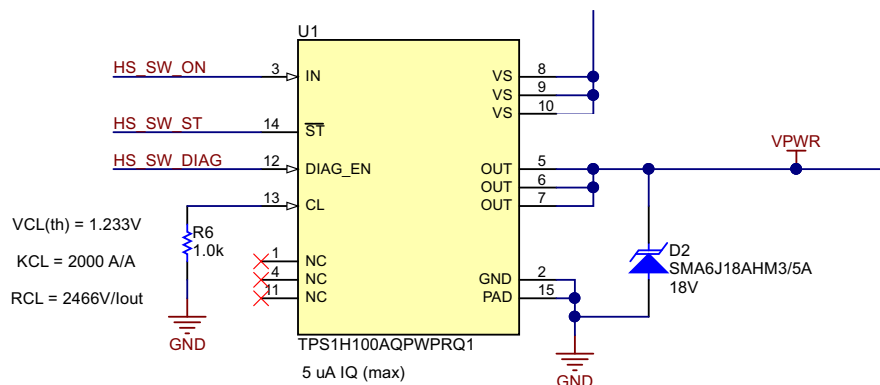

Copyright © 2017, Texas Instruments Incorporated

Figure 8. Electrical Schematic of High-Side Switch for Applying Power to Ultrasonic Transducer Circuits

2.4.2 Ultrasonic Driver and Receiver

Figure 9 shows the ultrasonic transducer driver and receiver circuit. Each channel is identical with the exception of R12, which provides a method to disconnect U4 from the USART communication. The PGA460-Q1 devices (U2 and U4) are each paired with a transducer, which is external to the board, connected to two-position terminal blocks J3 and J6. The PGA460-Q1 device drives the transducer and then filters and processes the returned echo signal sensed by the transducer. The transducer should be chosen based on the resonant frequency, input voltage requirements, sensitivity, beam pattern, and decay time.

Closed-top transducers are transducers that hermetically seal the piezoelectric membrane from exposure to air or destructive particles. Closed-top transducers are favorable in applications that are subject to harsh environmental conditions, such as exposure to outdoor elements, extreme temperature changes, and debris; therefore, closed-top transducers are suitable for automotive kick-to-open applications. As a result of the additional protection offered by closed-top transducers, a transformer-driven method is typically required to maximize distance performance. The voltage step-up transformers T1 and T2 are chosen to meet the input voltage requirements of the transducer and have a saturation current rated equal to or greater than the configured driving current limit of the PGA460-Q1 device.

Transformers T1 and T2 are center-tapped transformers with a turn ratio of 1:8.42 between each of the primary phases and the secondary output. For a nominal 12-V supply on VPWR, this ratio gives an output potential of up to about 100 V. The two low-side driver outputs OUTA and OUTB alternately switch to an ON state, with typical RDS(ON) of 4.8 Ω and a maximum pulse current of 500 mA. Capacitors C1 and C10 (100 μF) provide a reservoir of voltage, and these capacitors are tied to VPWR through resistors R1 and R8. The value of C1 and C10 (100 μF) is chosen to be sufficient to supply several pulses of ultrasonic energy without creating current surges on the 12-V power supply.

The PGA460-Q1 device can be tailored to the specific transducer being used by adjusting the driving frequency, driving current limit, band-pass filtering coefficients, and low-pass filtering coefficients. After the burst-and-listen cycle is complete, the PGA460-Q1 device can be called to return the distance, amplitude, and width of the echo through the USART communication interface.

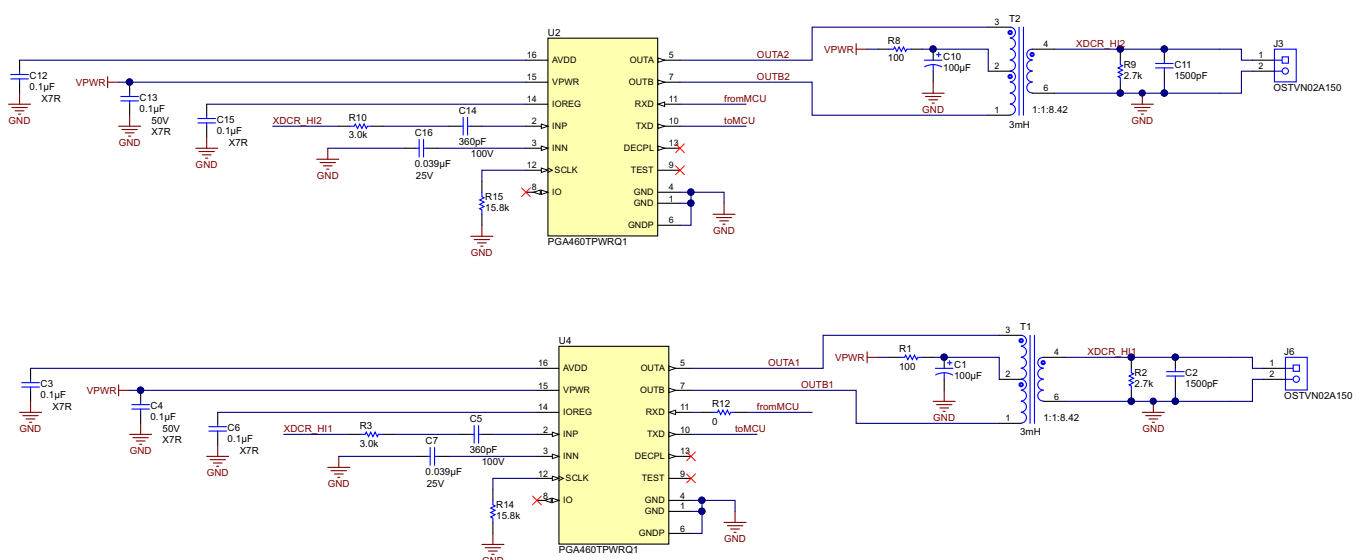

Copyright © 2017, Texas Instruments Incorporated

Figure 9. Electrical Schematic, Ultrasonic Transducer Driver and Echo Receiver Circuit

The resistors R2 and R9 and capacitors C2 and C11 provide tuning to help shape the ultrasonic waveform in conjunction with the parametric adjustments made to the PGA460-Q1 registers. In general, C2 and C11 should match the secondary inductance of the transformer to the resonant frequency of the transducer. The damping resistors R2 and R9 help to reduce the transducer ringing decay time. Further discussion of transducer circuit tuning component optimization can be found in 3.2.2.2.1.

The factory preprogrammed address for the PGA460-Q1 device is 0. In order to communicate independently with both devices U2 and U4, one or both devices must be programmed with a different USART address, and this new address stored in EEPROM. To accomplish this, resistor R12 can be temporarily removed, which disconnects U4 from the shared USART communication link. With R12 removed, U2 can be programmed with a new 3-bit USART address, which is stored in EEPROM. R12 can then be installed, and each PGA460-Q1 can be addressed independently on the USART communications link.

2.4.3 MCU Interface

The design board has a simple interface to an external MCU board, which is configured to meet the 20-pin LaunchPad standard. Figure 10 shows the MCU interface connectors and the onboard switch. The UART signals on J1-3 (toMCU) and J1-4 (fromMCU) provide serial communication with the PGA460-Q1 devices. The KEY signal (J1-5) comes from the onboard slide switch S1, which allows setting the KEY signal to indicate that a key fob has been detected. The external MCU will then control the high-side switch by activating the HS_SW_ON signal (J2-3) to apply power to the PGA460-Q1 circuits. The two signals HS_SW_DIAG (J2-1) and HS_SW_ST (J2-2) provide an enable for the high-side switch diagnostic features and a status indicator, respectively. A regulated, 3.3-V supply is available on pin J1-1 with respect to the GND pin (J2-10) to power the external MCU board with current capability up to 150 mA.

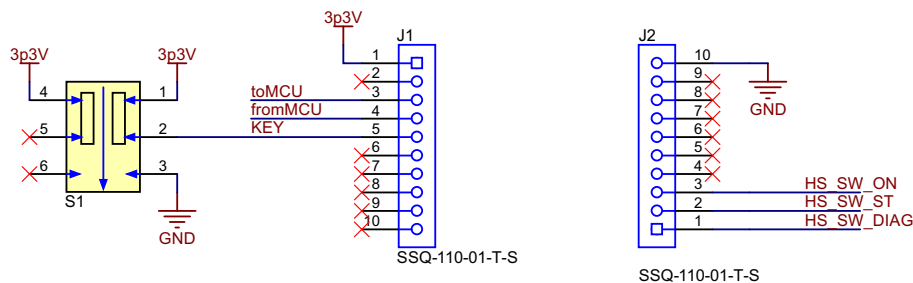

Copyright © 2017, Texas Instruments Incorporated

Figure 10. Electrical Schematic of MCU Interface

3 Hardware, Software, Testing Requirements, and Test Results

3.1 Required Hardware and Software

3.1.1 Hardware

The design board provides the drive stages and echo receiver for two ultrasonic transducers. Closed-top transducers, such as in [Figure 11](#) and [Figure 12](#), are typically used in automotive kick-to-open applications to prevent dirt or water from causing performance issues with the transducer action. The transducer is typically mounted in a flexible sleeve made of rubber or similar material, which tends to isolate the vibration of the transducer from the surrounding vehicle structure.



Figure 11. Closed-Top Murata Ultrasonic Transducer in Rubber Mounting Sleeve

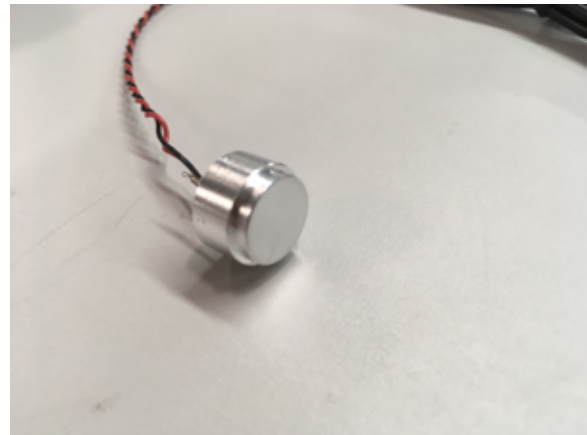

Figure 12. Closed-Top PUI Ultrasonic Transducer

Parameters for these two transducers are listed in [Table 3](#). Both transducers were tested with the TIDA-01424, as described in later sections.

Table 3. Ultrasonic Transducer Specifications

PARAMETER	MURATA	PUI
Part number	MA58MF14-7N	UTR-1440K-TT-R
Resonant frequency	58 kHz	40 kHz
Drive voltage	120 Vpp	140 Vpp
Directivity	80° x 35°	70° ± 15°
Capacitance	1400 pF	1800 pF
Operating temperature	-40 to 85 °C	-40 to 80 °C

The design board is installed as a BoosterPack on a LaunchPad MCU board to form a complete, kick-to-open sensor module. The connectors J1 and J2 are 10-pin, female connectors installed on the bottom side of the board. These connectors connect to the standard LaunchPad connectors, which align with the two 10-pin, male connector pins on boards, such as the MSP430G2553 LaunchPad, or with the two outside rows of the two 20-pin, male connectors on the LaunchPad XL interface on boards, such as the MSP430F5529 LaunchPad.

☒ 13 shows the design board correctly mounted on an MSP430F5529 LaunchPad board with closed-top transducers (Murata) connected to the each of the connectors J3 and J6 and input power (VBATT) on J5. In ☒ 13, the ultrasonic transducers are not mounted in their flexible mounting sleeves.

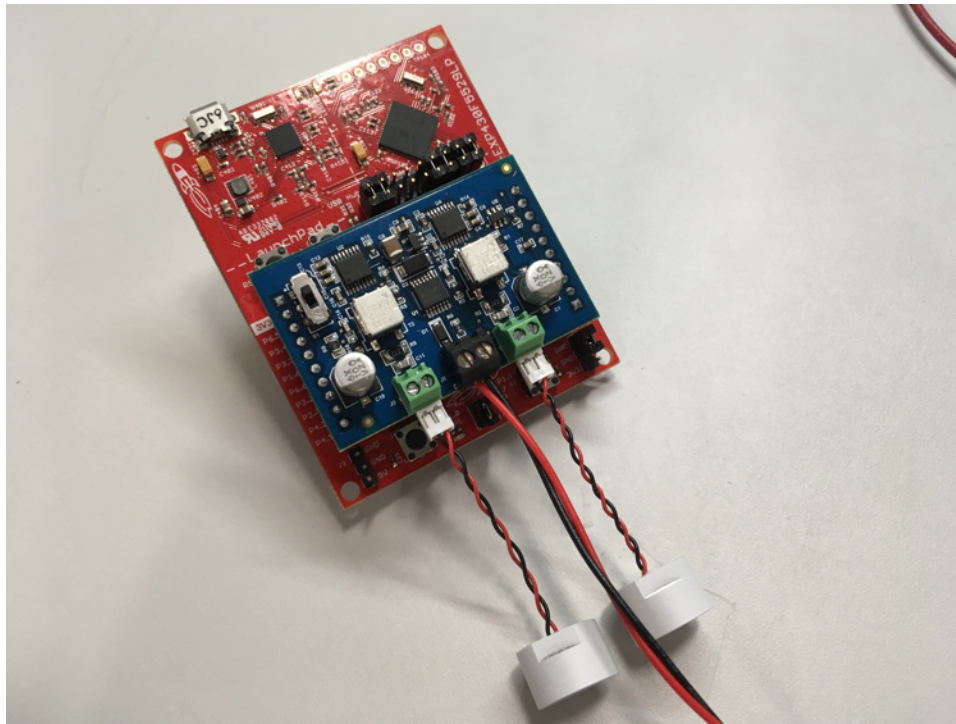

☒ 13. TIDA-01424 Board Mounted on MSP430™ LaunchPad™ Board

3.1.2 Software

Software must be loaded to the LaunchPad MCU board to control the function of the design board. For the purposes of testing, the example code given in was used as the basis of software routines for this kick-to-open design.  14 shows a simplified flow chart for the reference design. Designers will tailor these functional blocks to best fit the requirements of the specific applications they are addressing.

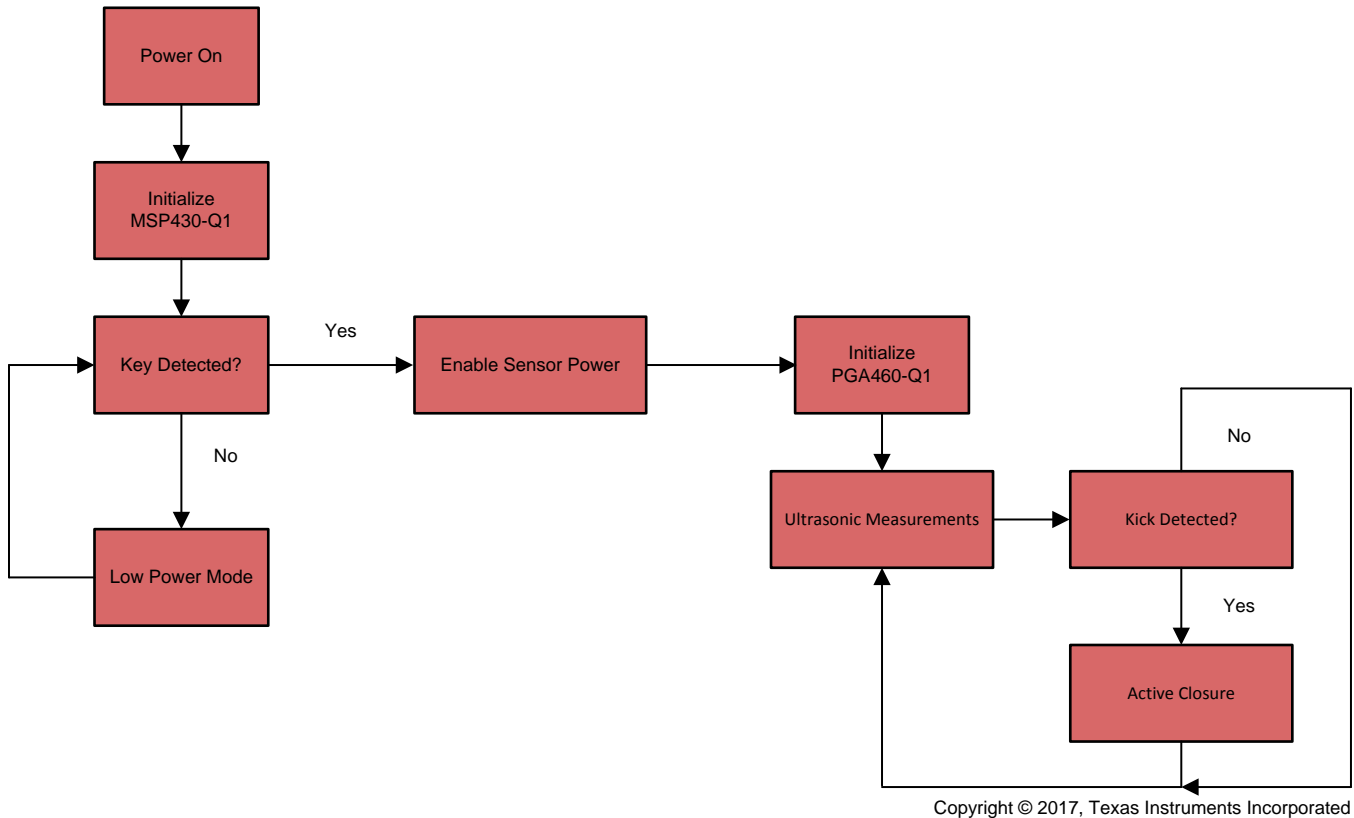

 14. Simplified Software Flow for Ultrasonic Kick-to-Open Design

3.1.2.1 Power On

When 12-V power is applied to VBATT (J5-2) with respect to GND (J5-1), the TPS7B6933-Q1 will regulate the input voltage to produce a 3.3-V output voltage; no enable or signal is required. The 3.3-V supply (3p3V) is then applied to the components on the design board as well as to the MSP430 LaunchPad board through connectors J1 and J2.

3.1.2.2 Initialize MSP430-Q1

After 3.3-V power is applied to the LaunchPad, the MCU must be configured. Configuration involves setting up the GPIO ports to the appropriate input and output conditions and enabling USART communication with the PGA460-Q1 devices. The GPIO pins corresponding to the MSP430F5529 LaunchPad are noted on the TIDA-01424 electrical schematic. 表 4 also lists these pins. If a different MCU board is used, similar signal connections are required, but the specific port and GPIO assignments may be different. As part of the MCU initialization step, these GPIO and USART pins must be configured for the proper function and direction. Refer to the user's guide for the specific LaunchPad board used.

表 4. MCU Connections for MSP430F5529 LaunchPad™

SIGNAL	TIDA-01424 PIN	MSP430F5529 LAUNCHPAD	SIGNAL DIRECTION
USART toMCU	J1-3	P3.4	from TIDA-01424 board to LaunchPad
USART fromMCU	J1-4	P3.3	from LaunchPad to TIDA-01424 board
KEY	J1-5	P1.6	from TIDA-01424 board to LaunchPad
HS_SW_ON	J2-3	P2.6	from LaunchPad to TIDA-01424 board
HS_SW_ST	J2-2	P2.3	from TIDA-01424 board to LaunchPad
HS_SW_DIAG	J2-1	P8.1	from LaunchPad to TIDA-01424 board

3.1.2.3 Low-Power Mode

In low-power mode, the current drawn from VBATT is reduced to avoid long-term drain on the automotive battery system. Until a key fob is detected, as indicated by the KEY signal, the MCU will keep the PGA460-Q1 devices turned off by deasserting the HS_SW_ON signal, which controls the function of the TPS1H100-Q1 high-side switch. The MCU can remain in one of its low-power modes for a majority of the time and periodically check for an assertion of the KEY signal.

3.1.2.4 Enable Sensor Power

When the vehicle security system detects a valid key fob, the kick-to-open system will activate. When the KEY signal transitions to a high signal, the MCU will assert the HS_SW_ON signal, which causes the TPS1H100-Q1 high-side switch to connect 12-V power from VBATT+ to VPWR. This applies power to the two PGA460-Q1 devices.

3.1.2.5 Initialize PGA460-Q1

After being enabled by application of VPWR, the PGA460-Q1 devices will have register settings as loaded from the non-volatile EEPROM. If changes to the stored settings are desired, the PGA460-Q1 registered may be updated by communication through the UART communication link.

3.1.2.6 Ultrasonic Measurements

The PGA460-Q1 UART interface is able to record up to eight objects with echos that exceed the assigned threshold. The result is expressed as a 1- μ s interval time value from the time the burst stage is complete and the echo signal drops below the assigned threshold to the moment any of the detected objects cut the assigned threshold again. Additionally, the width of the echo signal that cuts the threshold and the peak amplitude of the object is also measured and reported. If the object is detected at the end of record time, object width is reported as 0xFF. The width of the echo that cuts the threshold is expressed as 4- μ s interval-time values. When a LISTEN ONLY command is used, the object detection starting point is at the start time of the record interval.

The echo and threshold comparison is done between the assigned threshold and the amplitude of the signal at the output of the DSP data path. If the threshold level is higher in value than the signal amplitude then no object is detected. If the signal amplitude is higher in value than the threshold level which denotes an echo reflection, then an object is detected, and the time-mark is captured. When the record time reaches the end of the record defined by the Px_REC parameters and the number of objects to be detected is still not achieved, the record interval is complete, and the undetected object locations are assigned a value of 0xFF.

3.1.2.7 Kick Detected?

After a sequence of measurements has been read from the PGA460-Q1, the MCU will determine if a kick gesture has been detected or not. The criteria for whether to declare a valid kick will depend on the specifics of the actual vehicle and sensor configuration. In general, several factors should be considered when making the determination of a valid kick:

- Background measurement to ground before kick
- Variation in repeated measurements before kick
- Direction of gesture distance (increase or decrease) in measurements during kick
- Amplitude of gesture motion between no-kick and kick measurements
- Duration of kicking gesture
- Difference between multiple sensors located at different points on the vehicle

3.1.2.8 Activate Closure

If it is determined that a valid kick gesture has been detected, the ultrasonic kick-to-open system sends a signal to the associated closure system (lift-gate, trunk, sliding door) to activate the desired motor, and opens or closes the mechanism. After the mechanism has moved, the design continues to make ultrasonic measurements until another kick is detected, the key fob is no longer present, or power to this subsystem is turned off.

3.2 Testing and Results

Unless otherwise noted, the following tests were performed at room temperature with a 12-V nominal supply. The ultrasonic sensor measurement data (when applicable) was read from the PGA460-Q1 registers through the serial port. In some cases, the graphical user interface (GUI) with the PGA460EVM collected the comparison data for different environmental conditions.

3.2.1 Test Setup

3.2.1.1 Power Supply Testing

The reference design board operates from a typical, automotive, 12-V, battery electrical system. As such, the board survives events, such as high voltage due to load dump, and faults, such as reverse battery voltage. The board operates over a wide range of input voltages.

3.2.1.2 Ultrasonic Transducer Testing

Several factors affect the amplitude, duration, and shape of the ultrasonic pulse from the transducer. These factors include the transducer characteristics, the tuning components on the design board, and register settings of the PGA460-Q1. Selection of the hardware transducer, hardware components, and PGA460-Q1 settings are discussed in .

3.2.1.2.1 Default Settings for Transducer Drive

Unless otherwise noted, the tests in the following sections used the parameter settings listed in 表 5. The default transducer during testing was the Murata closed-top transducer described in 表 3.

表 5. PGA460-Q1 Register Settings Used For Testing

PARAMETER	PULSE	CURR_LIM	NUMBER OF PULSES	CURRENT LIMIT (mA)
Preset 1	0x04	0x55	4	197
Preset 2	0x10	0x55	16	197

3.2.1.3 Kick Detection

In order to evaluate the function of the capacitive, kick-to-open design, a series of tests used hardware similar to the actual application conditions with the reference design board. Data for these tests is presented in the following sections. These tests are not intended to be complete as there are many variables that would affect any particular vehicle and situation. The test data is intended to illustrate the feasibility of this hardware to implement the basic functions of a kick-to-open system.

3.2.1.3.1 Kick Testing Hardware Setup

In addition to the design board and the LaunchPad MCU board, testing requires a 12-V power supply to take the place of the automotive battery system; this reference design operates over a wide range of input voltages and requires less than 40 mA of current from the external supply, so the requirements for a power supply are not very restrictive. Testing also requires appropriate ultrasonic transducers, a structure to emulate the automotive body, and a method to provide kicking gestures.

To simulate the body of the vehicle, a bumper cover (TY04112BBQ) was mounted at a height and orientation similar to that found on a vehicle. For the purposes of initial testing, the bumper cover is kept separate from any objects that would affect the ultrasonic measurements.

Each ultrasonic transducer was mounted in the bumper cover with a rubber insert, as discussed in 3.1.1.

☒ 15 shows an ultrasonic transducer mounted in the bumper cover using the flexible rubber insert.



図 15. Bumper Cover With Ultrasonic Sensor

In order to make the kicking gesture more repeatable during testing, a mechanical kicking machine, shown in [Figure 16](#), provides the kick for each test. This mechanism provides a controlled and repeatable motion in terms of duration of kick, speed of motion, and angle of approach. The pivot point on this mechanism is about 20 in (500 mm) above the ground, similar to the knee joint of an adult who might make the kicking gesture in the actual application. The approach of the kicking gesture is roughly a path along the circumference of an arc about the pivot point approaching the sensor as determined by the relative placement of the sensor and the kicking mechanism. The duration of the kicking gesture made by the kicking mechanism was about 1.5 s in each direction extending towards the bumper and then moving away from the bumper.

A variety of shoes and materials can be attached to the kicking mechanism to evaluate the response to different shoe's construction and material properties on the ultrasonic sensing. The structure of the mechanism is away from the sensors (except for the drive mechanism), so that the effect of the structure on the measurements is minimized.



図 16. Kicking Mechanism Used for Testing

The tests using the entire bumper cover, sensors, and kicking mechanism were on a concrete floor in the loading dock area of the TI plant in Dallas, which was in a lab area as close as possible to the actual conditions of a garage or parking lot.

3.2.2 Test Results

3.2.2.1 Power Supply Test Results

3.2.2.1.1 Input Current During Operation

Figure 17 shows the input current from the VBATT supply as the VBATT voltage is varied over a range of positive voltages. For voltages below 4 V, the 3.3-V supply is not active, and the current consumption is very low. When VBATT is increased to 4 V, the TPS7B6933-Q1 supplies the 3.3-V regulated supply to the TPS3700-Q1 and to the MCU interface. For the voltage range of 6 V to 15 V, the supply is within the recommended operating range of the PGA460-Q1 devices, and all of the onboard circuits are all active. When the VBATT voltage is above 18 V, the overvoltage threshold of the TPS3700-Q1 is exceeded, and the device sets the HS_SW_ON signal to logic low by turning on the low-side driver, OUTB. This setting causes the TPS1H100-Q1 high-side switch to remove power from the PGA460-Q1 devices, and the current consumption is drastically reduced. This change also prevents voltages above 18 V from damaging the PGA460-Q1, which has an absolute maximum rating of 30 V on its VPWR supply input.

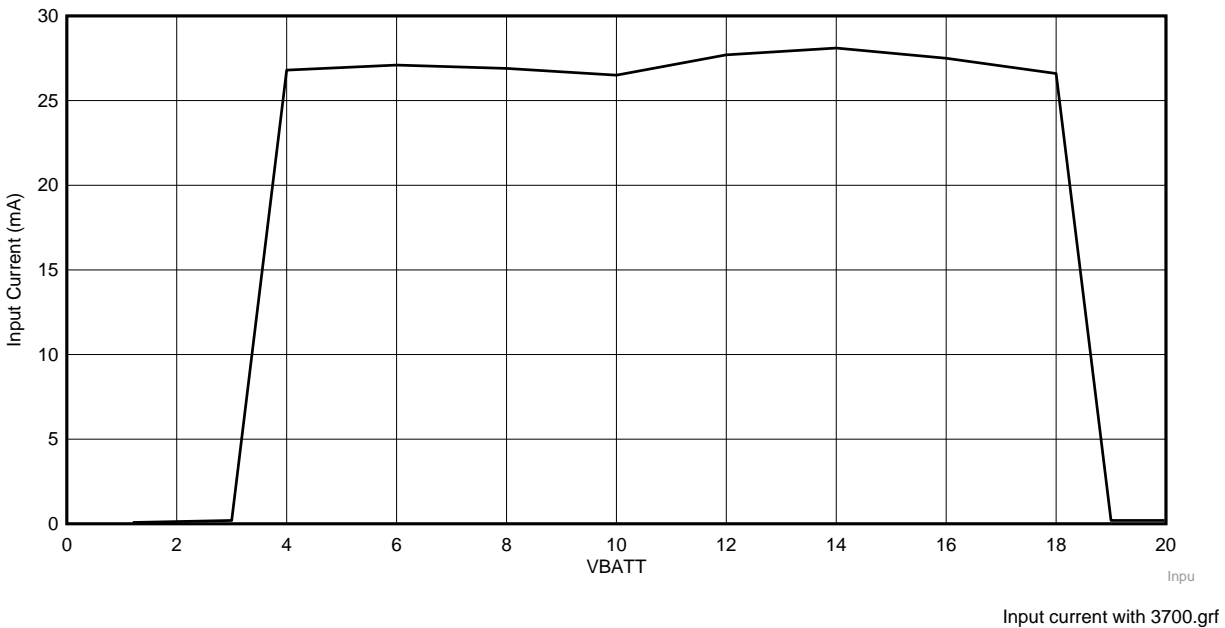

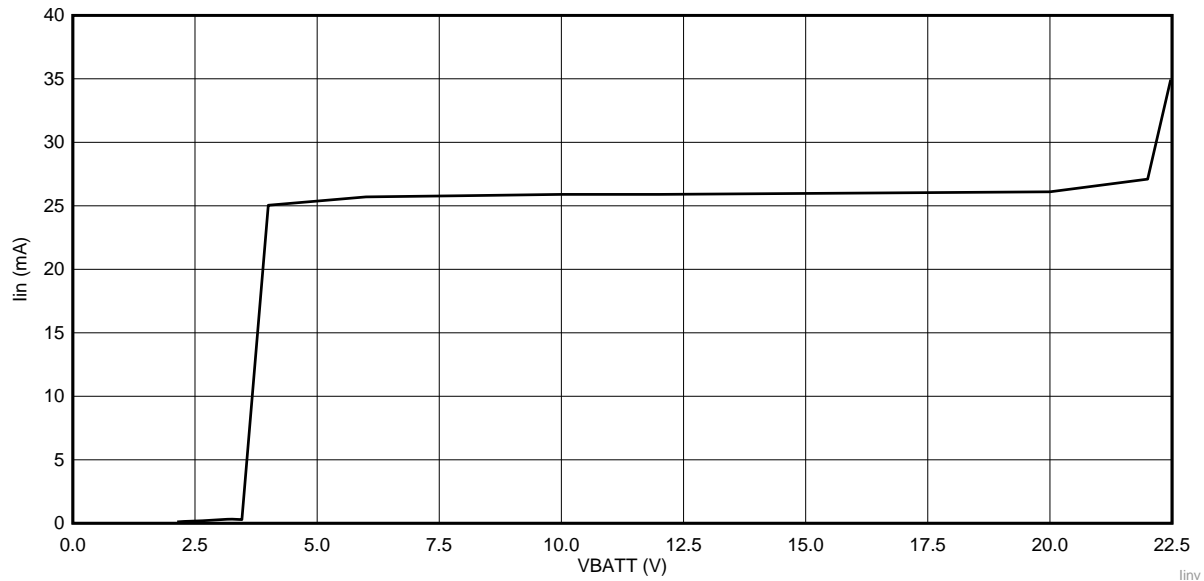



Figure 17. Input Current Versus VBATT Voltage, Showing TPS3700-Q1 Threshold at 18 V, TIDA-01424 Board Only

In order to demonstrate the effect of the Zener diode D2, which clamps any short-term voltage transients before reaching the PGA460-Q1, the overvoltage threshold of the TPS3700-Q1 was raised to 25 V by changing resistor R5 to 15 kΩ.  18 shows the input current at J5 over a wide range of applied voltage at J5-2 (VBATT) with respect to J5-1 (GND). This current is for the TIDA-01424 board itself without the accompanying MSP430 LaunchPad board. For voltages above 22 V, the input current increases significantly as the Zener diode reached its breakdown voltage.



lin vs Vin Zener.grf

 18. Input Current Versus Input Voltage, TPS3700-Q1 Overvoltage Threshold at 25 V, TIDA-01424 Board Only

3.2.2.1.2 Input Current During Standby

Figure 19 shows the input current at J5 versus input voltage (VBATT) with the board put into standby mode by connecting HS_SW_ON to GND. For input voltages up to 20 V, the standby input current from VBATT is less than 50 μA . As predicted by Table 2, the standby current is about 40 μA when VBATT is set to 12 V. The linear increase in the current as VBATT increases above 4 V is about 10 μA or 9 V, which is equivalent to a resistance of 900 $\text{k}\Omega$. Most of this increase can be accounted for by the resistor divider formed by R4 and R5, which has a total resistance of 998 $\text{k}\Omega$.

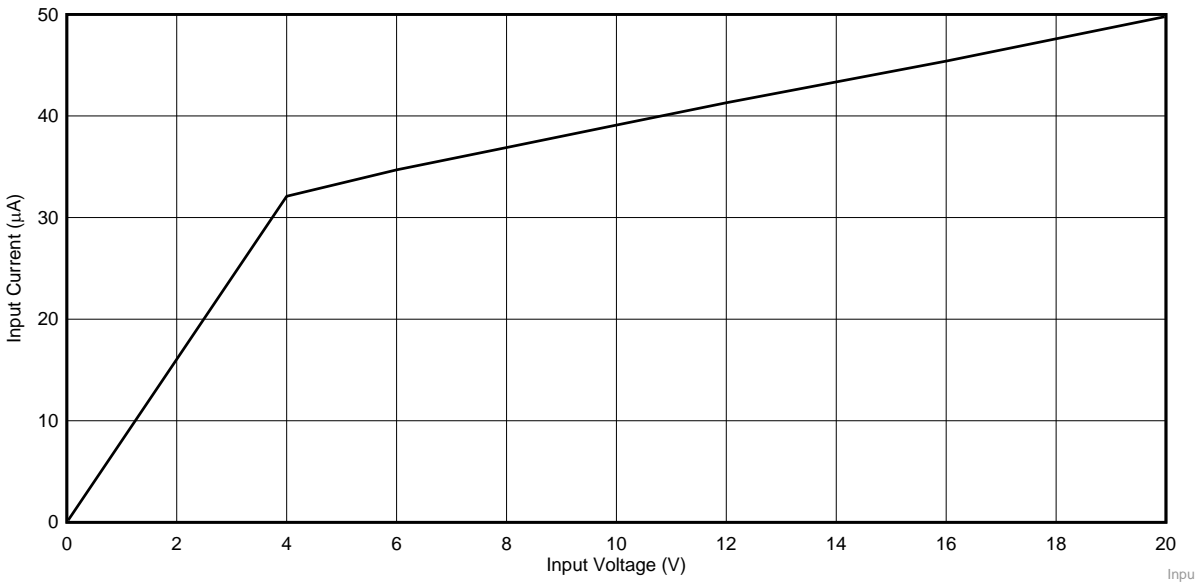

Input Current vs Voltage Standby.grf

Figure 19. Input Current Versus Input Voltage, Standby Mode

3.2.2.1.3 3.3-V Supply Regulation

Figure 20 shows the voltage of the 3.3-V supply as the input voltage at J5-2 (VBATT) is varied with respect to J5-1 (GND). For input voltages on VBATT between 4 V and 20 V, the 3.3-V supply is stable with a measured voltage of 3.29 V. This stability indicates the design will provide a consistent 3.3-V supply over the intended operational range of VBATT voltages.

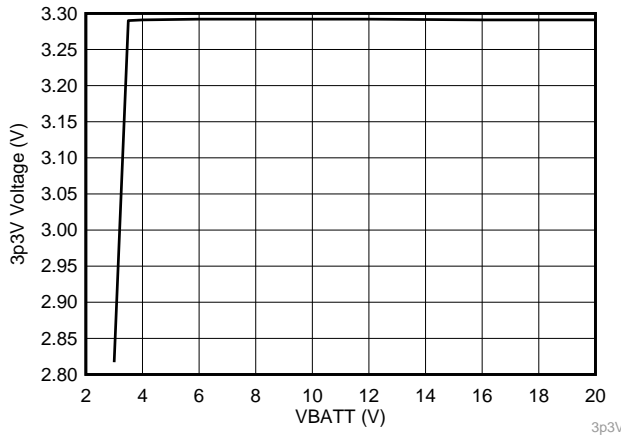
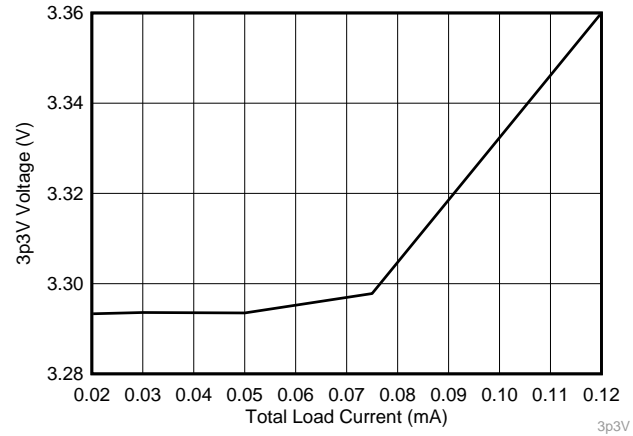

Figure 20. 3.3-V Supply Voltage Versus Input Voltage



3p3Vloadregulation.grf

Figure 21. 3.3-V Supply Voltage Versus Load Current

Figure 21 shows the variation in the 3.3-V supply voltage as the load current is varied. This variation demonstrates the load regulation is stable for a range of load currents—from a light load of 20 mA to a heavy load of 120 mA. The regulated 3p3V supply is always within 2% of the nominal value of 3.3 V; therefore, this design is suitable for supplying external loads, such as MCUs, over a wide range of output currents.

3.2.2.1.4 Reverse Battery Condition

Reverse polarity voltages up to 20 V were applied to J5-2 (VBATT) with respect to J2-1 (GND) with input current results as shown in Figure 22. The small input current, less than 3 μ A, shows that no significant leakage current is allowed under reverse battery conditions.

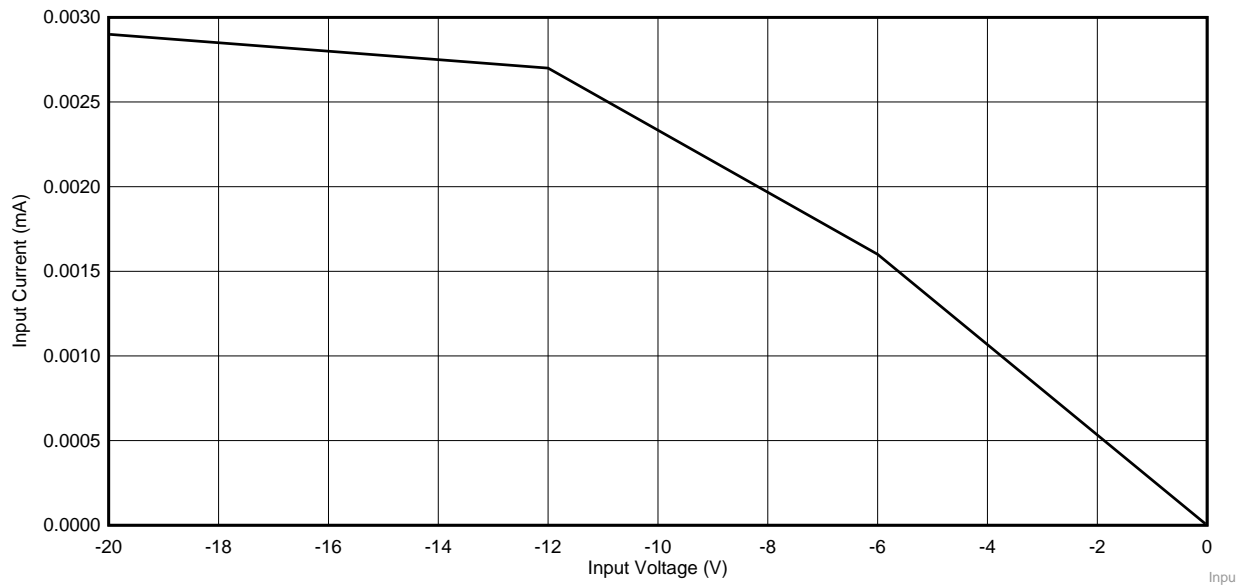

Input Current vs Voltage Reverse.grf

Figure 22. Input Current Versus Input Voltage, Reverse Battery Condition

3.2.2.2 Ultrasonic Transducer Test Results

3.2.2.2.1 Effects of Tuning Capacitor and Damping Resistor

Figure 23 and Figure 24 show the effect of changing the tuning capacitor and damping resistor for one of the circuits coupling the PGA460-Q1 to the ultrasonic transducer. A microphone sensitive in the ultrasonic range captured the acoustical waveform of the ultrasonic pulse, which includes the influence of the PGA460-Q1 settings, the onboard tuning components, and the transducer characteristics. Figure 23 has a damping resistor value of 2.7 kΩ and tuning capacitor value of 1.5 nF, and the duration of the pulse is about 300 μs with an amplitude of 500 mV. When these component values are changed to 10 kΩ and 700 pF, as shown in Figure 24, the maximum amplitude and duration of oscillation both increase.

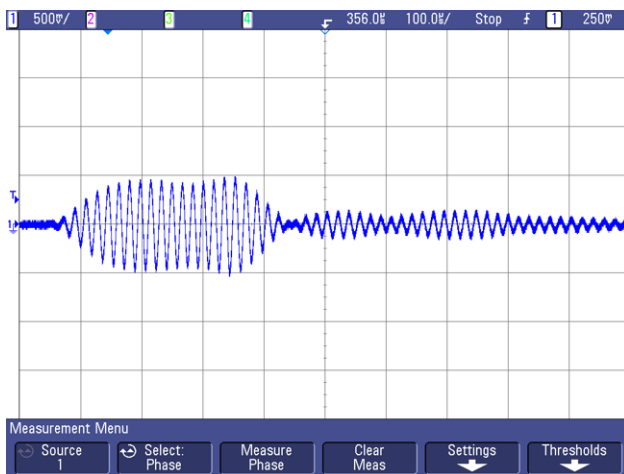

Figure 23. Ultrasonic Acoustic Waveform, R = 2.7 kΩ, C = 1500 pF

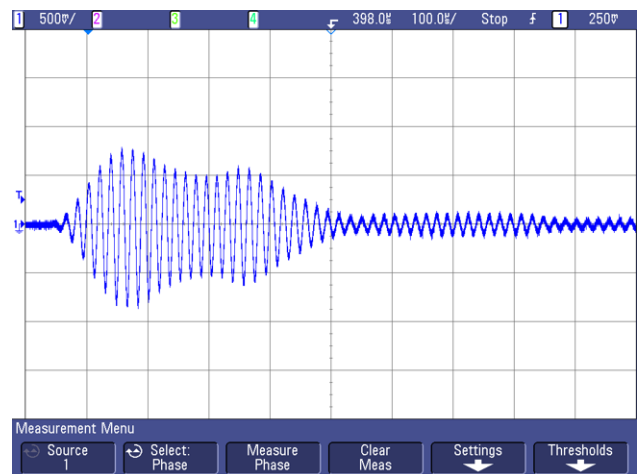

Figure 24. Ultrasonic Acoustic Waveform, R = 10 kΩ, C = 700 pF

3.2.2.2 Effect of Adjusting Number of Drive Pulses

Another adjustable parameter that affects the ultrasonic measurement is the number of pulses the PGA460-Q1 drives the transducer to excite the resonant frequency. To generate a strong ultrasonic pulse, the number of pulses must be sufficient to cause a large amplitude of vibration in the transducer structure. However, the *blind zone* created by the self-resonance of the transducer also increases as the number of applied pulses is increased. This blind zone hides any echo reflections until the self resonance decays. This decay sets the minimum detectable distance for the ultrasonic echo measurement.

Figure 25 shows how the minimum measurable distance increases as the number of pulse is adjusted. For this plot, the Murata transducer was used with a PGA460-Q1 current limit setting of 200 mA. With only one pulse applied, the self-resonance of the transducer quickly decays, which potentially allows measurements at a distance of 14 cm. However, the amplitude and power of the ultrasonic vibration would be relatively low, and therefore the echo signal would be likewise reduced. As the number of pulses is increased, the minimum measurement distance increases up to 24 cm when 30 pulses are applied. Users should balance the desired minimum measurement distance required against the requirement for a strong ultrasonic echo when deciding how many pulses to apply.

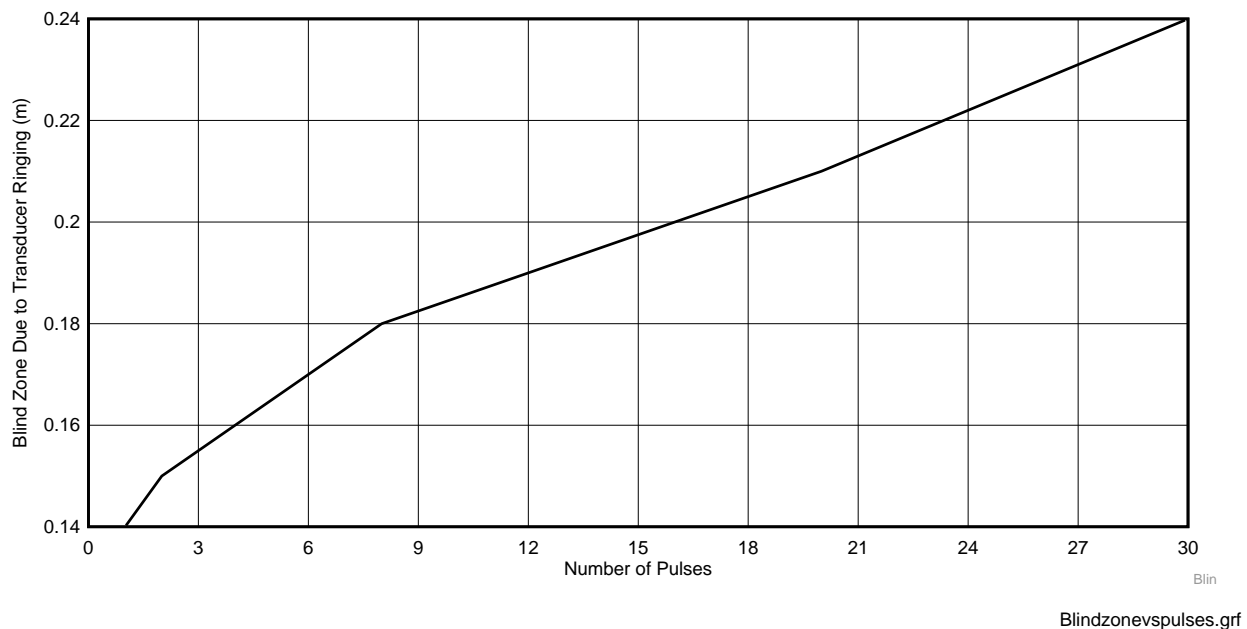
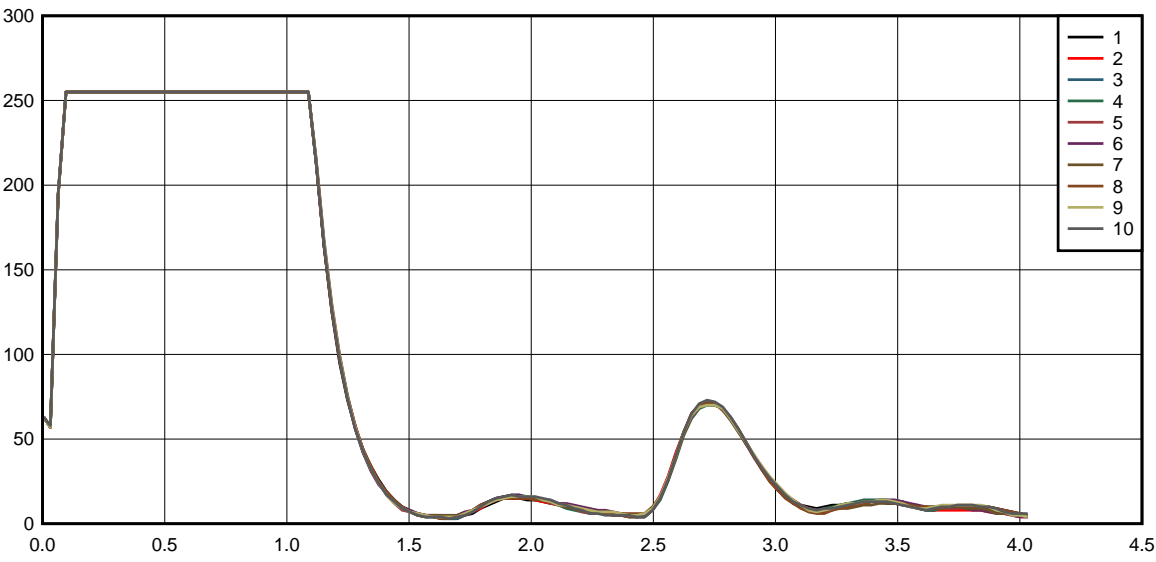

Figure 25. Effect of Increasing Number of Applied Pulses on Minimum Measurable Distance

3.2.2.3 Kick Detection Test Results

3.2.2.3.1 Baseline Measurements

Initial repeated measurements with no kicking gesture give a baseline by which to compare subsequent results. The traces in  26 show the responses for ten subsequent measurements from the PGA460-Q1 and the Murata transducer. The variation in response among these ten traces indicates the response is highly repeatable. The dominant reflection occurs at about 2.7 ms, which corresponds to a distance of 460 mm (about 18 in) and agrees with the measured distance along the transducer axis to the ground.

The time-varying gain (TVG) for these measurements was set to a uniform low value, so there is no discontinuity in the measured response across the duration displayed. In real applications, designers may want to increase the time-varying gain, so the weaker echos from more distance objects are amplified more than the echos from nearby objects.

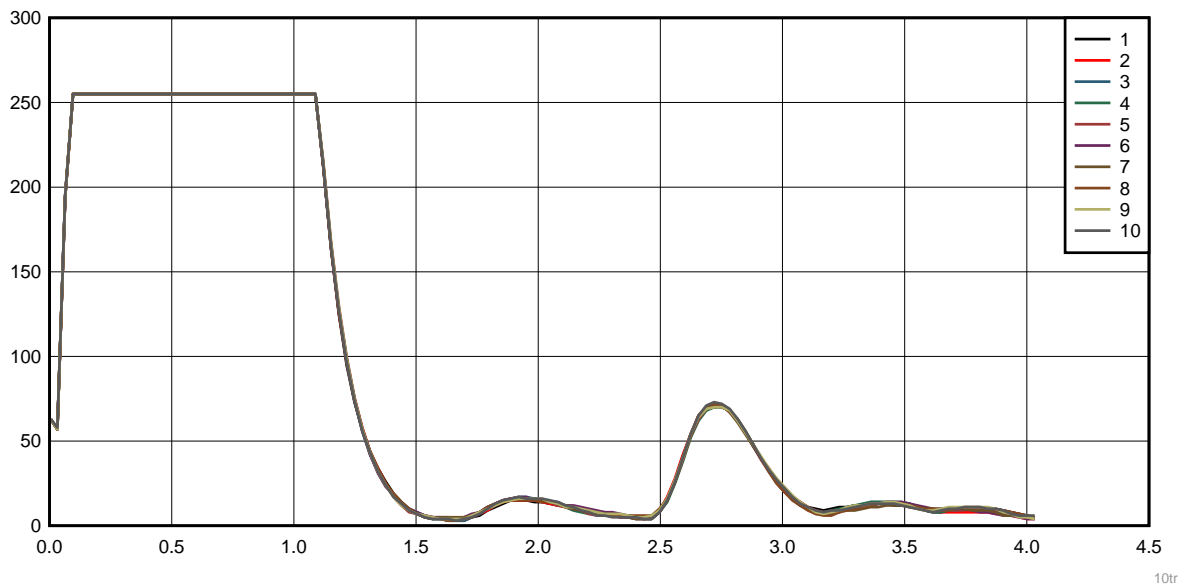

10tracesnofootuniformlowgain.grf

 26. Ten Sequential Traces With No Foot, Uniform Low TVG Setting

3.2.2.4 Static Distance Measurements

The distance from the transducer to a target (typical shoe and simulated leg) was measured repeatedly to determine the repeatability of the measurement. The distance from the outside face of the transducer to the closest part of the shoe is given as a reference. [Fig 27](#) illustrates the distance.



図 27. Vertical Distance Measurement From Ultrasonic Transducer to Shoe

[表 6](#) shows one example of the data collected during these tests. For each of the ten samples, the reported distance is given to a precision of 1 mm. The duration when the echo was above the threshold is given in microseconds, and the peak of the echo is also given. The standard deviation for each reported measurement is given; the standard deviation of the distance measurement is less than 0.5 mm for these ten samples.

表 6. Repeated Measurements to a Non-Moving Shoe

SAMPLE	DISTANCE (mm)	DURATION ABOVE THRESHOLD (us)	PEAK ECHO AMPLITUDE
1	224	300	112
2	225	304	114
3	225	296	111
4	225	308	110
5	224	228	115
6	224	284	117
7	225	296	116
8	225	296	116
9	225	288	112
10	225	308	111
Average	224.7	296.8	112.9
Standard Deviation	0.483	8.4	2.4

3.2.2.4.1 Static Measurements of Varying Distance, Rubber Shoe

The following figures show the echo response with the foot covered with a rubber material used as the outer surfaces of waterproof boots. The measured distance from the transducer to the ground is 434 mm as shown in [Figure 28](#). When the shoe is relatively far from the transducer, the echo does not exceed the threshold, which is indicated by *P2 Threshold* in the figures. As the shoe comes closer, the echo amplitude increases and eventually exceeds the threshold, as shown in [Figure 29](#) where the measured distance to the shoe is 325 mm. As the distance between the transducer and the shoe decreases, the amplitude of the echo increases, and the measured distance decreases, as shown in [Figure 30](#) through [Figure 32](#)

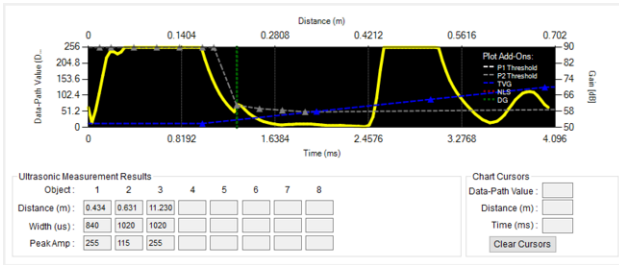

Figure 28. Echo With Rubber Top Shoe, Ground Detection

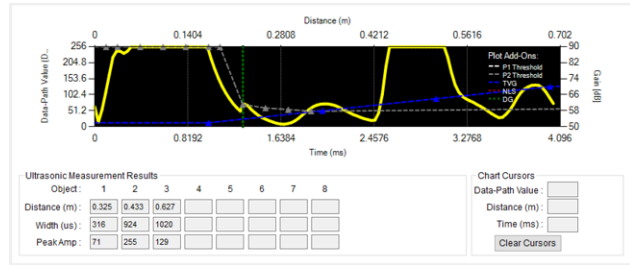

Figure 29. Echo With Rubber Top Shoe, Detection of Shoe at 325 mm

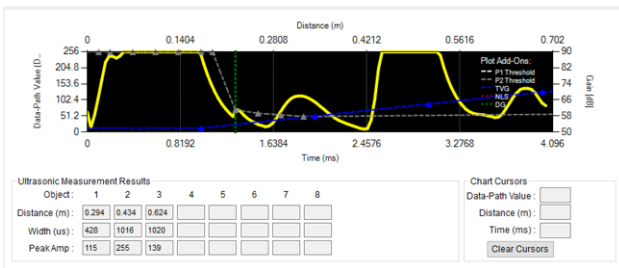

Figure 30. Echo With Rubber Top Shoe, Detection of Shoe at 294 mm

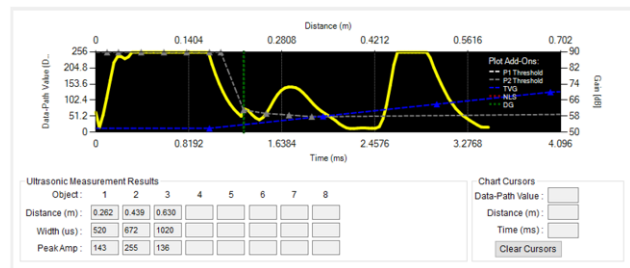

Figure 31. Echo With Rubber Top Shoe, Detection of Shoe at 262 mm

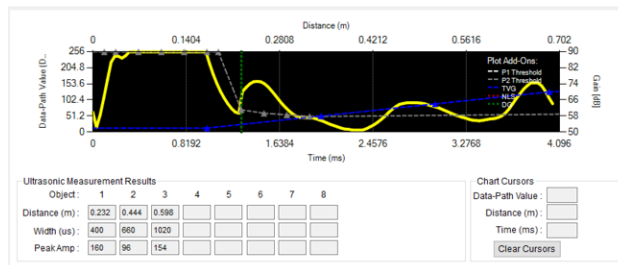

Figure 32. Echo With Rubber Top Shoe, Detection of Shoe at 232 mm

As the shoe gets closer than about 220 mm, the echo begins to merge with the *blind zone* caused by the decay profile of the ultrasonic transducer. Therefore, detection of the shoe at distances shorter than 230 mm is problematic for this particular combination of transducer and driver settings.

3.2.2.4.2 Static Measurements of Varying Distance, Sports Shoe

A more complex situation is shown in [33] through [42]. The shoe for these figures is a sports shoe with a variety of materials used on the upper surface. As shown in [33], the shoe is detected at a distance of 380 mm, but the echo falls beneath the threshold as the shoe moves slightly closer, as shown in [34] when the ground is detected at a distance of 431 mm. As the shoe moves closer, the echo increases in amplitude, and the shoe is detected in [35] through [38] at decreasing distances each time. At a distance between 280 mm and 260 mm, the echo again falls below the threshold, and the shoe is not detected, as shown in [39]. The echo is again above the threshold for distances between 255 mm and 205 mm, and the shoe is detected as shown in [40] through [42].

Several factors may contribute to the echo decreasing below the threshold at certain distances. One factor is that the angle of the top surface of the shoe is changing as the leg mechanism rotates upward. Another factor is that the top surface of the sports shoe is made up of several different types of material, including nylon webbing, rubberized canvas, and cotton and polyester laces. The acoustic reflection properties of these different materials may affect the amplitude of the ultrasonic echo.

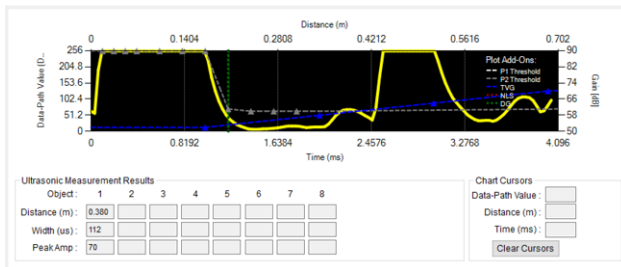

[33]. Sports Shoe Detected at 380 mm

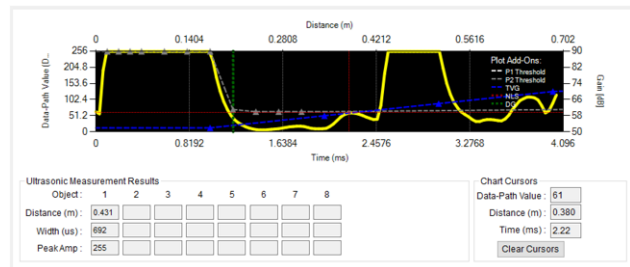

[34]. Sports Shoe Echo Below Threshold, Ground Detected at 431 mm

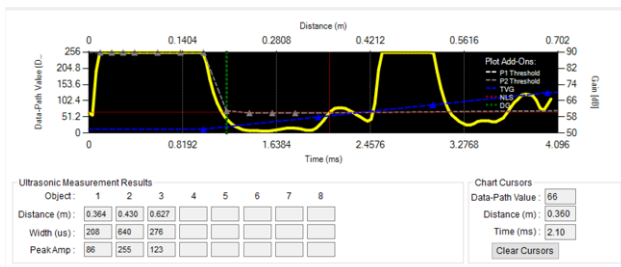

[35]. Sports Shoe Detected at 364 mm

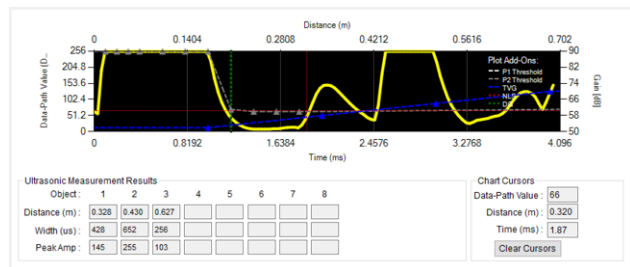

[36]. Sports Shoe Detected at 328 mm

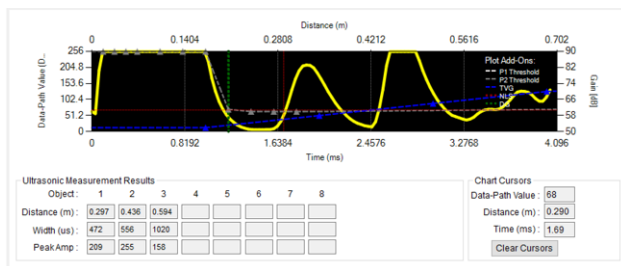

[37]. Sports Shoe Detected at 297 mm

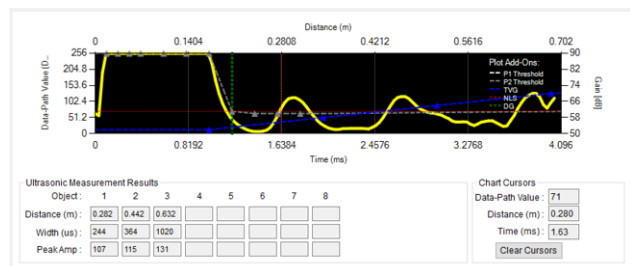

[38]. Sports Shoe Detected at 282 mm

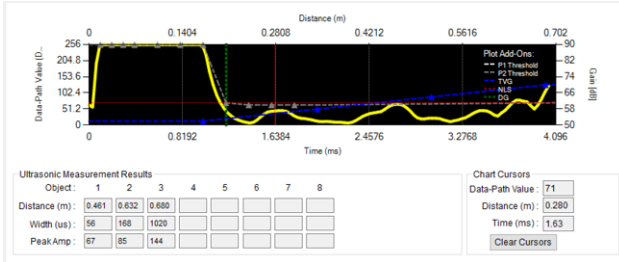

☒ 39. Sports Shoe Echo Below Threshold at 260 mm, Ground Detected at 461 mm

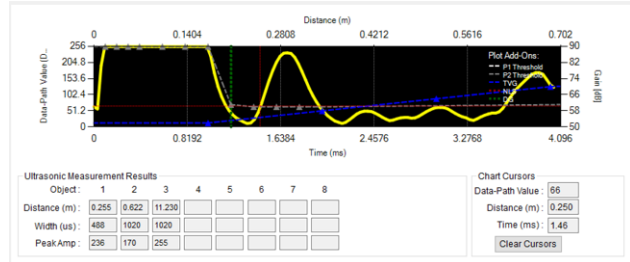

☒ 40. Sports Shoe Detected at 255 mm



☒ 41. Sports Shoe Detected at 238 mm

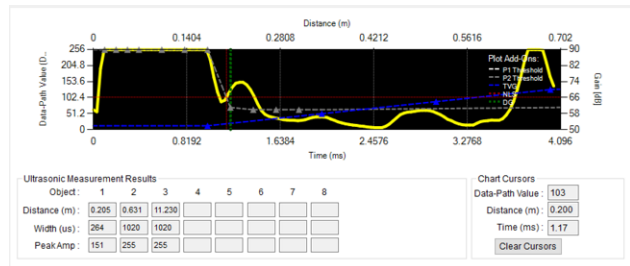

☒ 42. Sports Shoe Detected at 205 mm

Another observation about these results is that the distance measured to the ground can be affected by the shoe obstructing the most direct path. In ☒ 38 the shoe is relatively far from the transducer, and the echo from the ground is strong at about 430 cm. However in ☒ 39, the shoe is closer to the transducer and blocks the most direct path between the transducer and the ground. This blockage explains why the distance to the ground is measured as 461 mm, which is due to the longer path the ultrasonic energy must take to the side of the shoe and echoes back with much lower amplitude due to the non-orthogonal angles involved.

3.2.2.4.3 Static Measurements With Alternate Transducer

Use of more than one type of ultrasonic transducer gives more confidence that the design is adaptable for use with sensors from various manufacturers. The PUI audio transducer has a resonant frequency of 40 kHz and is a closed-top configuration. Several static measurements show typical response curves in [43](#) through [48](#) with the transducer mounted in the bumper cover.

[43](#) shows the response curve with a direct path to the ground, which is detected at 442 mm. Comparing the near-distance response to that shown in [28](#), the self-resonance with the PUI transducer does not begin to decay until about 1.5 ms, which is somewhat longer than the 1 ms of the Murata sensor. The settings for the Murata and PUI transducers may be adjusted to get a quicker near-distance decay time, but this adjustment may reduce the overall level of echo response.

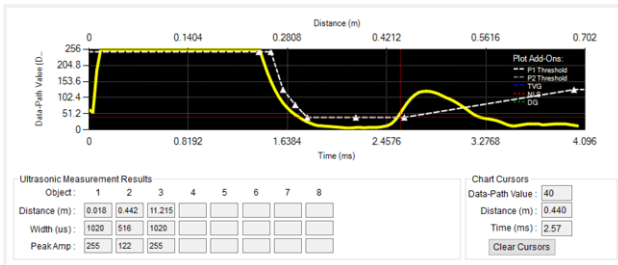

[43](#). Detection of Ground at 442 mm Using PUI Transducer

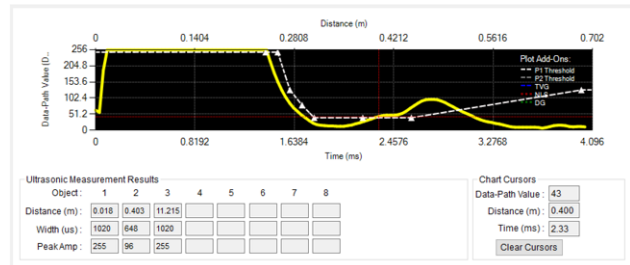

[44](#). Detection of Foot at 403 mm Using PUI Transducer

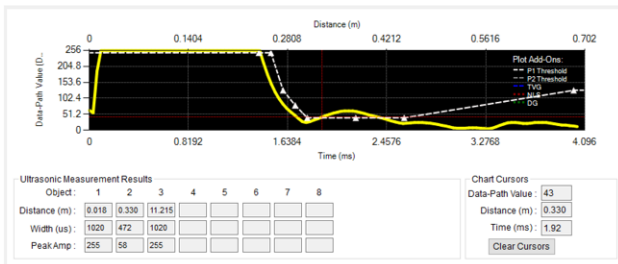

[45](#). Detection of Foot at 330 mm Using PUI Transducer

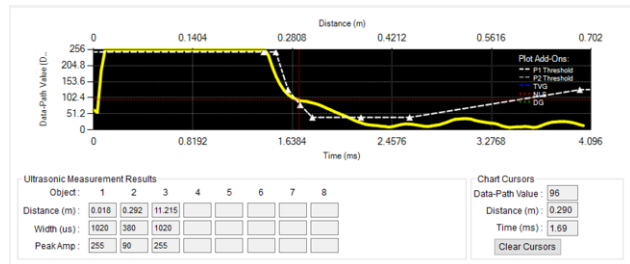

[46](#). Detection of Foot at 292 mm Using PUI Transducer

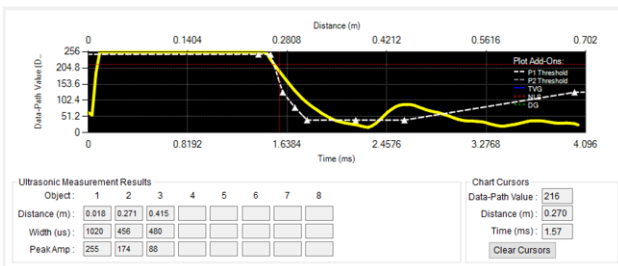

[47](#). Detection of Foot at 271 mm Using PUI Transducer

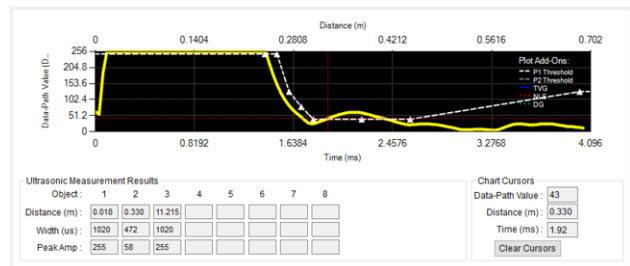

[48](#). Foot Not Detected Closer Than 270 mm, Secondary Surface Detected at 330 mm, Using PUI Transducer

3.2.2.5 Dynamic Kick Measurements

In the following figures, the effect of kicking towards the bumper with varying horizontal offsets shows how the ultrasonic sensor performance depends on making a kicking gesture in the correct location. In [Figure 49](#) through [Figure 52](#), a standard kicking gesture is made perpendicular to the bumper using a rubber boot on the kicking mechanism. Each scatter plot shows ten echo vectors with 128 samples in time for each plot. The echo vectors are recorded every 0.5 s, so the total time for all samples in each scatter plot is 5 s. The horizontal axis is the time between ultrasonic pulse and echo in ms, and the vertical axis is echo response in counts (256 maximum). In each of these figures, the Murata transducer ringing begins to decay at about 0.9 ms, and the ground reflection occurs at about 2.5 ms. The sample points between 0.9 ms and 2.5 ms represent a composite overlay of the echos for the foot, which include the period when the foot is coming towards the transducer, and the period when the foot is moving away from the transducer.

[Figure 49](#) shows the ten response vectors with the foot mechanism centered directly towards the ultrasonic transducer. Several peaks in the response reach amplitudes of around 100 counts at 1.8 ms to 2.2 ms from the transducer. As the foot moves closer to the transducer, the peaks reach the 255 maximum amplitude between 1 ms and 1.8 ms.

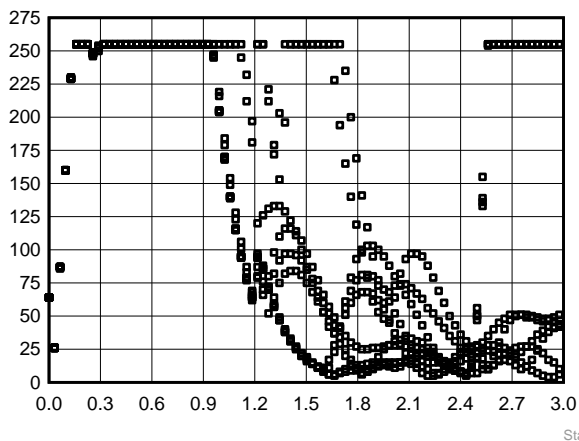

StandardkickP2MurataRubberfootcentered.grf

Figure 49. Scatter Plot of Samples With Kick Centered Towards Transducer

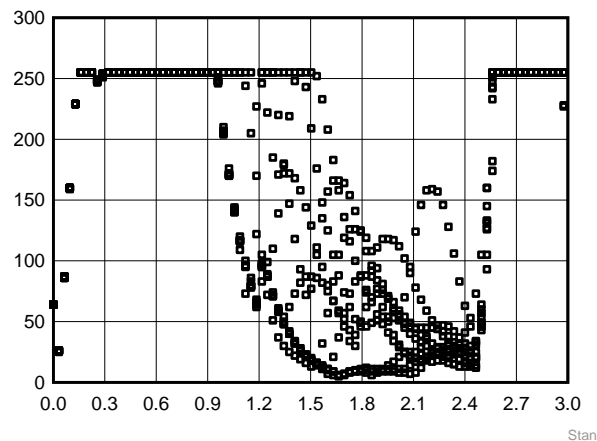

StandardkickP2MurataRubberfoot4inchesleft.grf

Figure 50. Scatter Plot of Samples With Kick Directed 4 inches to Left of Transducer

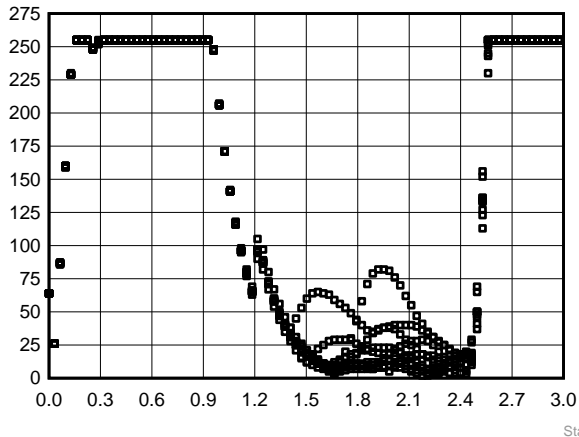

StandardkickP2MurataRubberfoot7inchesleft.grf

☒ 51. Scatter Plot of Samples With Kick Directed 7 inches to Left of Transducer

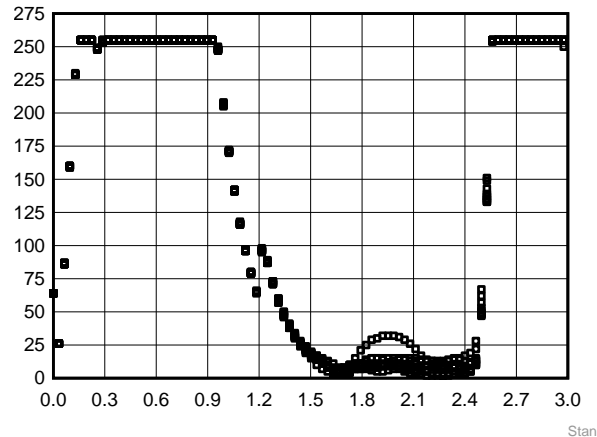

StandardkickP2MurataRubberfoot10inchesleft.grf

☒ 52. Scatter Plot of Samples With Kick Directed 10 inches to Left of Transducer

☒ 50 shows the response vectors with the kicking mechanism positioned such that the kick is directed towards a point about 4 in (100 mm) to the left of the transducer. While the response, especially at the longer distances (times), is still strong, the point where the response is saturated drops off at about 1.5 ms, which is sooner than in ☒ 49.

☒ 51 shows the response vectors with the kicking mechanism positioned such that the kick is directed towards a point about 7 in to the left of the transducer. In this case, the response echo no longer reaches a saturated value at any time (distance) between the self-resonance of the transducer at 0.9 ms and the ground echo at 2.5 ms. ☒ 52 shows this trend continues as the kicking mechanism is moved to direct the kick towards a point 10 inches to the left of the transducer. Under these conditions, the echo of the foot does not exceed an amplitude of 50.

As expected, the sensitivity of response is dependent on the horizontal offset between the kicking gesture and the transducer, especially at distances near the bumper where a large horizontal offset puts the kicking foot outside the angle of sensitivity of the transducer. This effect is summarized in ☒ 53, which shows the average amplitude of echo between 1.8 ms and 2.1 ms versus the longitudinal offset of the kicking gesture with respect to the transducer location. Of course, different transducers have wider or narrower angles of sensitivity, so a tradeoff can be made between allowable gesture offset and greater sensitivity at nominal offset.

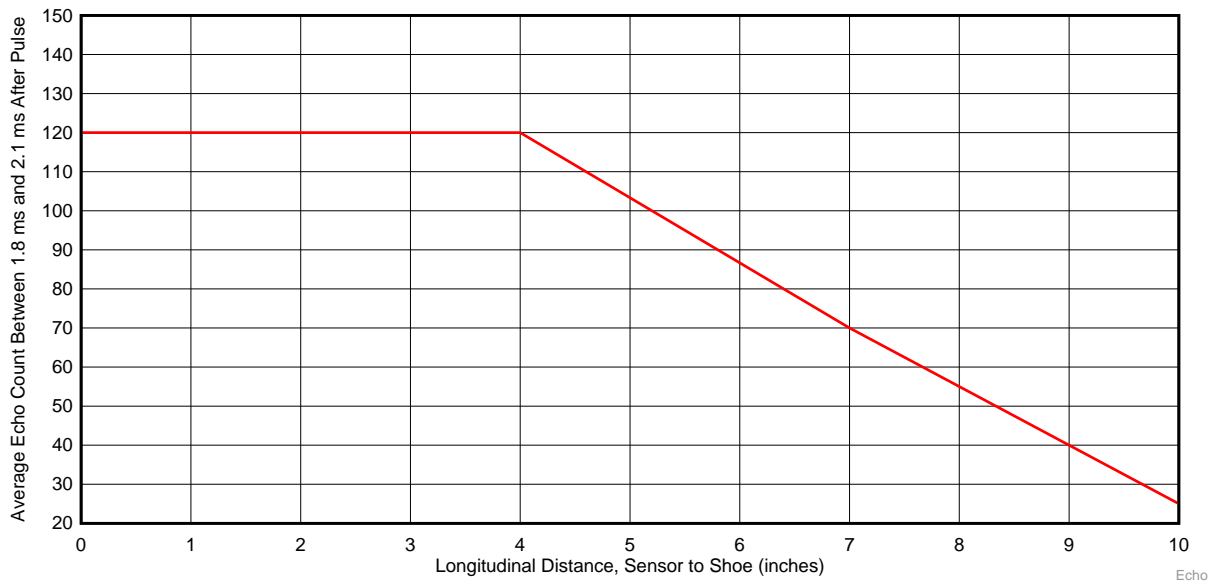

Echovslongitudinaldistance.grf

53. Effect of Kicking Gesture Directed at Point Displaced From Ultrasonic Transducer

3.2.2.6 Effects of Wet Transducer

One environmental condition that should be considered for an ultrasonic kick-to-open system is the effect of water, due to rain, snow, or road wetness, on the performance of the sensors. In order to determine whether water on the sensor has a significant effect, the ultrasonic sensor and bumper were sprayed with water, and the measurements were compared the echo response with and without the coating of water. [Figure 54](#) shows the bumper and one of the ultrasonic transducers coated with a spray of water.



Figure 54. Water Applied to Bumper Cover and Ultrasonic Sensor

[Figure 55](#) through [Figure 58](#) show the ultrasonic measurement results with the wet transducer. In each case, the measurement was made with the shoe in a static location.

Comparing the results with a rubber shoe, in the case of a dry transducer, [Figure 55](#) shows the maximum amplitude of the echo response for the shoe echo (between 1.5 ms and 2 ms after the source pulse) is 66 counts. The maximum amplitude of the echo response with a wet transducer is also 66 counts, as shown in [Figure 56](#). Therefore, the condition of water on the transducer does not exhibit any significant degradation in the performance of the ultrasonic sensor design.

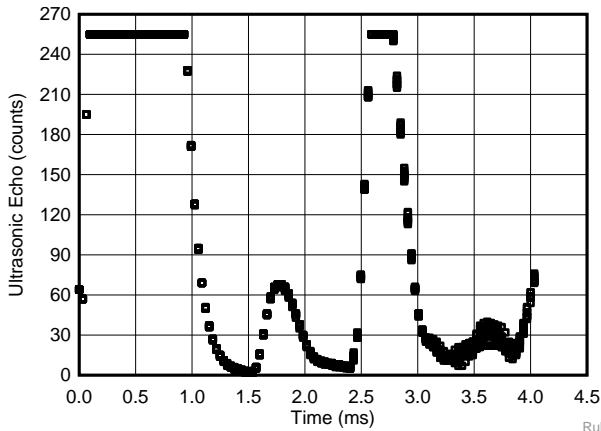

Rubbershoedrytransducer.grf

☒ 55. Rubber Shoe Dry Transducer

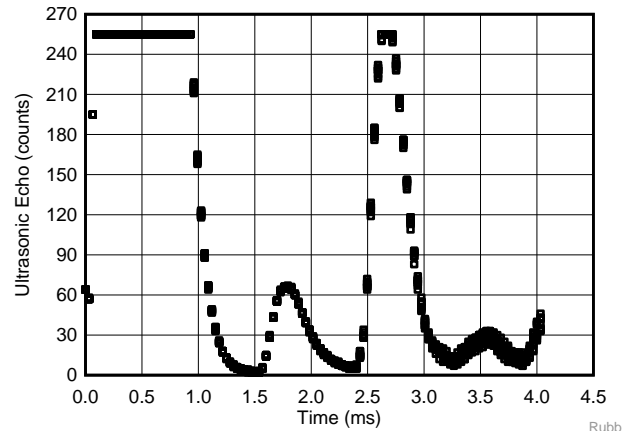

RubbershoeWetTransducer.grf

☒ 56. Rubber Shoe Wet Transducer

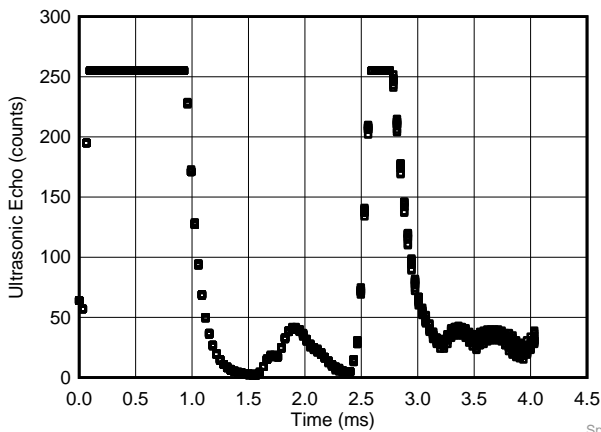

Sportshoedrytransducer.grf

☒ 57. Sports Shoe Dry Transducer

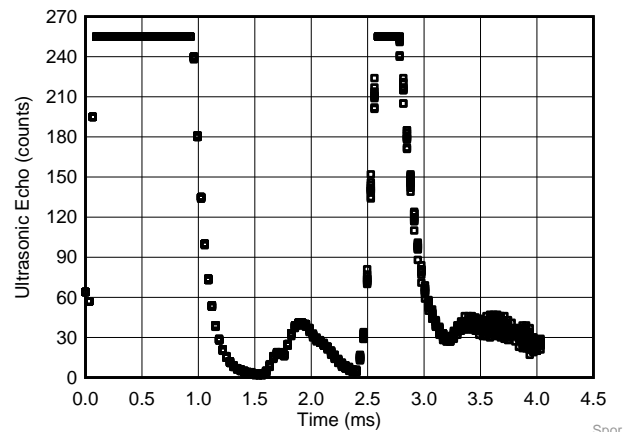

Sportshoewettransducer.grf

☒ 58. Sports Shoe Wet Transducer

Comparing the results of a dry transducer and a wet transducer with a sports shoe, in the case of a dry transducer, ☒ 57 shows the maximum amplitude of the echo response for the shoe echo (between 1.5 ms and 2 ms after the source pulse) is 41 counts. The maximum amplitude of the echo response with a wet transducer is also 41 counts, as shown in ☒ 58. Therefore, the condition of water on the transducer does not exhibit any significant degradation in the performance of the ultrasonic sensor design when either the rubber shoe or the sports shoe is used as a kicking object.

3.2.2.7 Effects of Mud on Transducer

Because the ultrasonic transducer is exposed to the elements and is in the rear of the car on the underside, the effect of mud on ultrasonic performance is of interest. ☒ 59 shows the ultrasonic transducer mounted on the bumper cover with a coating of mud covering much of the closed face of the transducer. For reference, compare this setup to the clean conditions shown in ☒ 15.



☒ 59. Mud on Ultrasonic Transducer

☒ 60 and ☒ 61 show the effect of this mud on the transducer. With the clean transducer shown in ☒ 60, there is a strong echo response of the rubber shoe, which starts at about 1.6 ms and peaks at about 90 counts. The case with mud on the transducer, ☒ 61, does not show any significant echo for the rubber shoe. Therefore, this coating of mud on the transducer had seriously degraded the performance of the ultrasonic sensor. Comparing the self-resonant period of these two cases, the dry transducer has a self-resonance that decays at about 1 ms, which drops to the noise floor by about 1.5 ms. The muddy transducer decay begins at about 0.65 ms, and by 1 ms, the self-resonance amplitude is negligible. This test indicates that the mud on the transducer not only impairs reception of returned echos but is also affecting the resonant properties of the transducer itself.

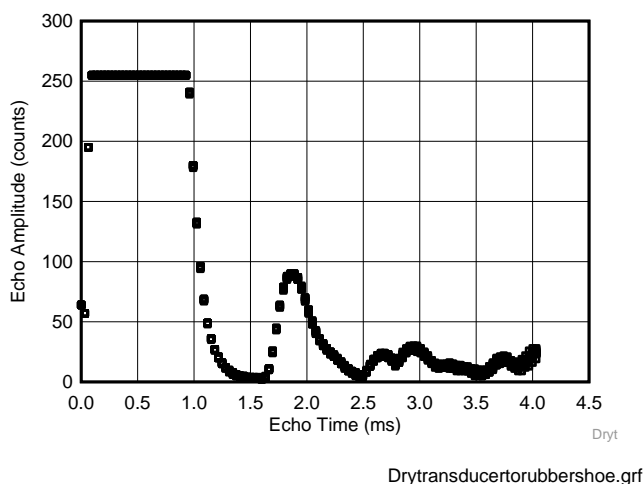

☒ 60. Response With Normal Transducer to Rubber Shoe

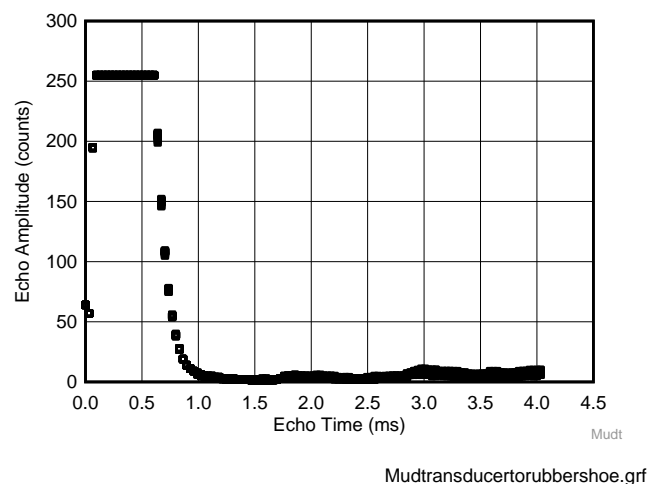

☒ 61. Response With Muddy Transducer to Rubber Shoe

3.2.2.8 Echos From Other Objects

The response of the sensor to objects that may move under the bumper, such as small animals, toys and balls, or rolling dropped objects, such as groceries, is of interest in kick-to-open systems. In these cases, the kick-to-open system would ideally be able to discriminate between these objects moving under the bumper and a valid kicking gesture.

Figure 62 through Figure 65 show the response of the ultrasonic kick-to-open design from the bumper-mounted ultrasonic transducer to a few foreign objects moving under the test bumper setup. For a basis of comparison, Figure 62 shows the output of the sensor system when no object is under the bumper. The echo from the concrete floor under the bumper starts at about 2.4 ms.

Figure 63 shows the echo profile with a stuffed animal under the bumper to simulate a small animal that might move under the vehicle. Although the echo from the furry exterior of the stuffed animal is very low, the system can detect that the echo directly from the ground is no longer present; therefore, it can be determined that some object is underneath the car in the path of the ultrasonic transducer.

Figure 64 shows the echo profile with a soccer ball under the bumper. As with the case with the stuffed animal, the direct path to the concrete floor is blocked, but in this case, the echo from the top of the ball is seen beginning at a time of 1.3 ms. In general the echo from the ball is similar to the echo from a rubber shoe, so other factors, such as duration of object detection and key fob presence, would be used to discriminate a ball rolling under the car from a valid kicking gesture.

Figure 65 shows the echo profile for the case of a metal soup can under the bumper to demonstrate the case when a dropped object rolls under the vehicle. In this case the echo of the can starts at about 1.9 ms. The echo of the ground beneath the can begins at about 2.4 ms, which indicates the can does not totally block the path directly from the transducer to the concrete floor.

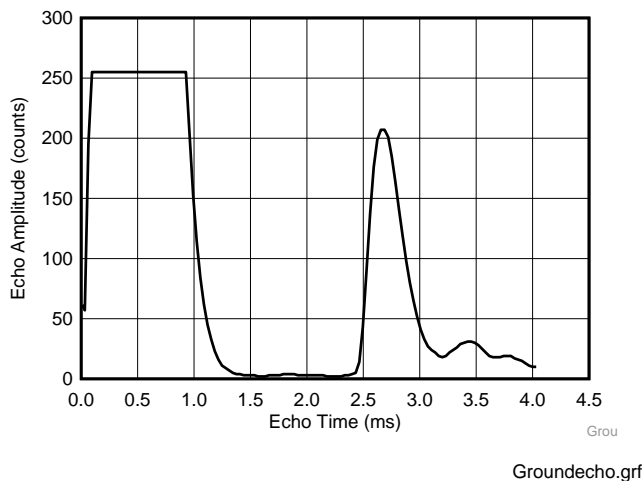

Figure 62. Echo From Ground Beneath Bumper

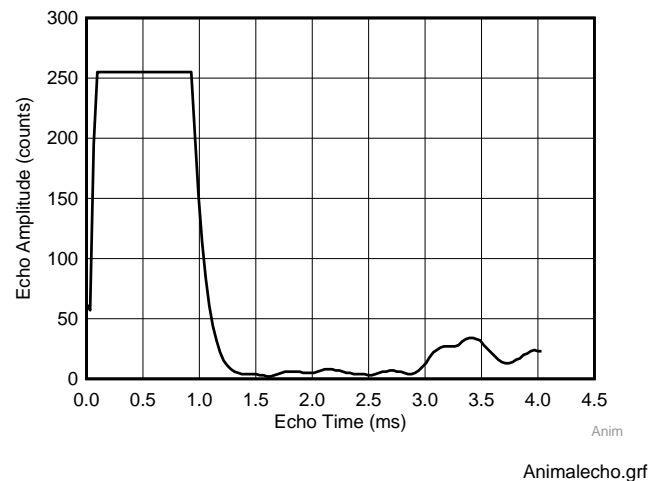
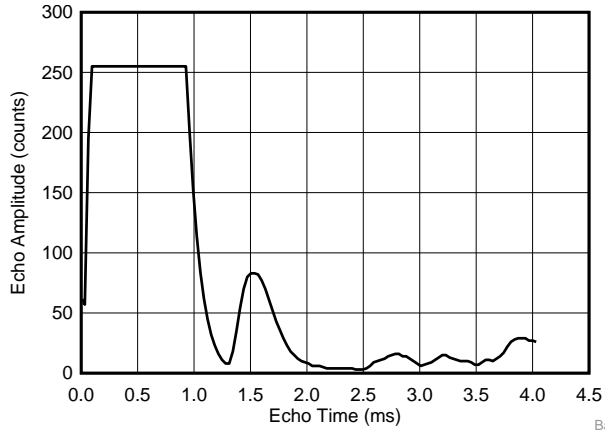
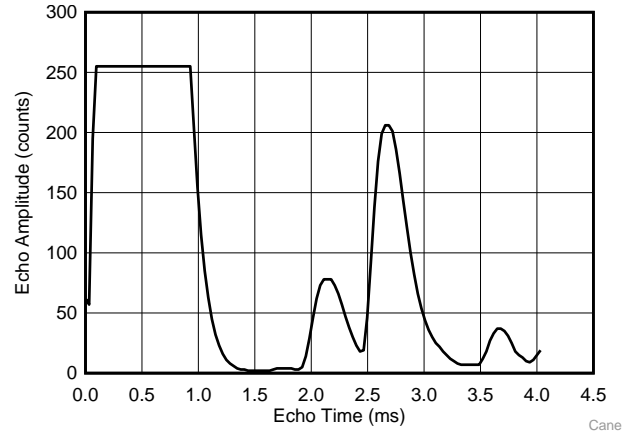

Figure 63. Echo From Stuffed Animal Beneath Bumper



Ballecho.grf

☒ 64. Echo From Ball Beneath Bumper



Canecho.grf

☒ 65. Echo From Can Beneath Bumper

4 Design Files

4.1 Schematics

To download the schematics, see the design files at [TIDA-01424](#).

4.2 Bill of Materials

To download the bill of materials (BOM), see the design files at [TIDA-01424](#).

4.3 PCB Layout Recommendations

4.3.1 Component Placement

☒ 66 shows a top view of the TIDA-01424 board. All components are on the top of the board with the exception of connectors J1 and J2, which connect to the LaunchPad connectors when the design board is assembled with a LaunchPad MCU board.

The arrangement of components is constrained by the location of the LaunchPad connectors and is designed to facilitate signal flow for the ultrasonic transducer driver and receiver circuitry. With the exception of the connectors to the LaunchPad board, all electrical interface to external components are made through the connectors J3, J5, and J6, which are all located on one edge of the board.

The location of the two channels of PGA460-Q1 ultrasonic transducer driver and receiver and associated circuitry is roughly symmetric around the vertical centerline of the board. In the center section of the board, between the two PGA460-Q1 circuits, are the power protection, conversion, and switching circuits. This arrangement allows distribution of the power supplies to sensor circuits on either side of the middle section.

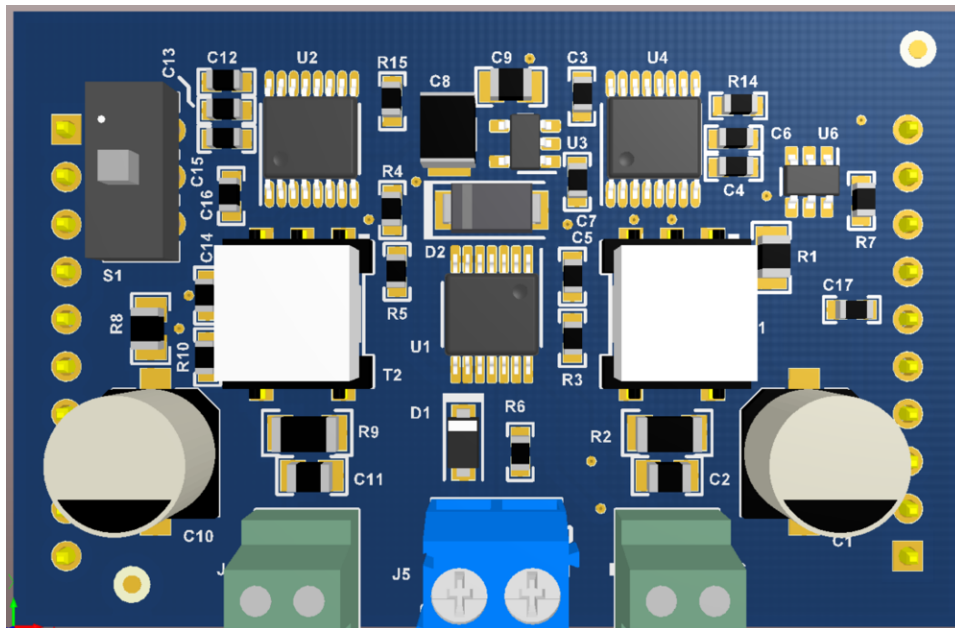

☒ 66. Top View of TIDA-01424 Board

4.3.2 Signal Routing

 67 shows the signal routing on the top layer of the TIDA-01424 board with the surrounding ground plane removed for clarity. As with the component placement, the signal routing for the two PGA460-Q1 devices and their associated circuitry is similar and symmetric on either side of the center of the board.

For each channel the signal from is fairly linear from the PGA460-Q1 (for example, U2) to the center-tap transformer (for example, T2), past the parallel combination of the damping resistors (for example, R9), and the tuning capacitor (for example, C11) to the 2-position terminal block (for example, J3), which connects to the external ultrasonic transducer. In all cases, the ultrasonic signal trace lengths are kept short to reduce undesirable signal reflections, which might affect distance measurements.

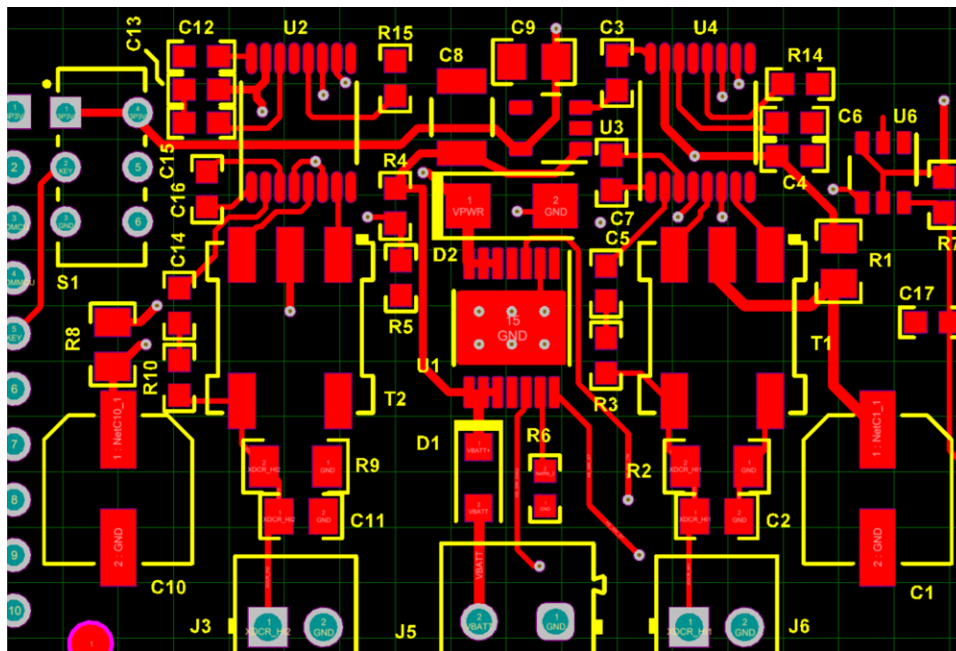

 67. Top Layer Routing of TIDA-01424 Board, With GND Plane Hidden

Figure 68 shows a detail of the routing of the XDCR_HI2 signal, which is the path for sending the pulse and receiving the acoustical echo signal from the ultrasonic transducer. The signal path is kept short and relatively straight to reduce electrical noise. The received echo signal is coupled back to the PGA460-Q1 through a series resistor and capacitor (for example, R10 and C14); the location of these components is also designed to reduce the signal path length.





図 68. XDCR_HI2 Signal Trace

4.3.3 VPWR Routing

 69 shows the routing of the VPWR signal, which is the switched power to the PGA460-Q1 ultrasonic driver and receivers and the associated circuitry. Because each transducer can drive up to 500 mA of current, the trace width of VPWR is kept at least 20 mils wide. This width reduces the effect of any trace impedance, thus allows relatively high current surges with low-voltage loss.

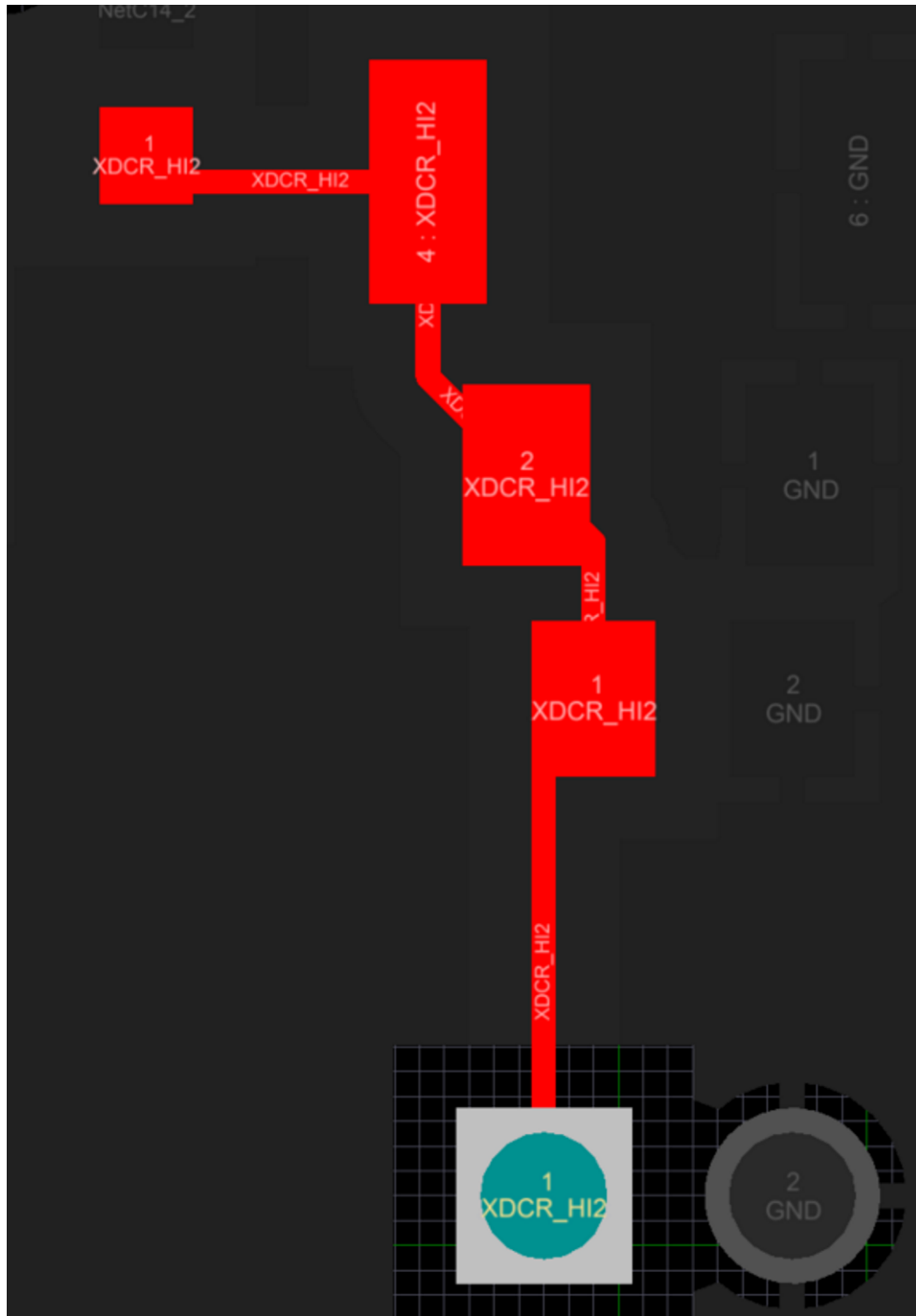

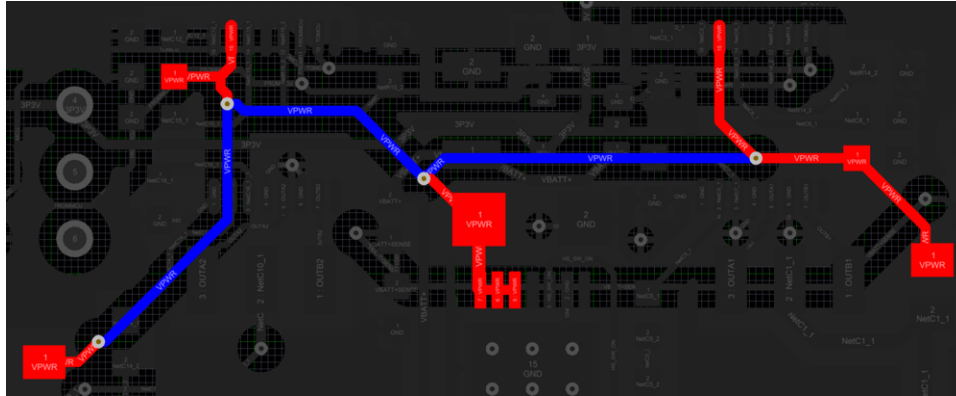
 69. Routing of VPWR Routing From High-Side Switch to PGA460-Q1 Devices and Transformers

4.3.4 Layout Prints

To download the layer plots, see the design files at [TIDA-01424](http://www.ti.com/sc/techlit/TIDA01424).

4.4 Altium Project

To download the Altium project files, see the design files at [TIDA-01424](http://www.ti.com/sc/techlit/TIDA01424).

4.5 Gerber Files

To download the Gerber files, see the design files at [TIDA-01424](http://www.ti.com/sc/techlit/TIDA01424).

4.6 Assembly Drawings

To download the assembly drawings, see the design files at [TIDA-01424](http://www.ti.com/sc/techlit/TIDA01424).

5 Software Files

To download the software files, see the design files at .

6 Related Documentation

1. Texas Instruments, [PGA460-Q1 Automotive Ultrasonic Signal Processor and Transducer Driver](#), Datasheet (SLASEC8)
2. Texas Instruments, [TPS3700-Q1 Window Comparator for Over- and Undervoltage Detection](#), Datasheet (SLVSC17)
3. Texas Instruments, [TPS1H100-Q1 40-V, 100-mΩ Single-Channel Smart High-Side Power Switch](#), Datasheet (SLVSCM2)
4. Texas Instruments, [TPS7B69xx-Q1 High-Voltage Ultra-Low IQ Low-Dropout Regulator](#), Datasheet (SLVSCJ8)
5. Texas Instruments, [PGA460 Ultrasonic Module Hardware and Software Optimization](#), Application Report (SLAA732)
6. Texas Instruments, [PGA460 Energia Library and Code Examples](#), Software (SLAC741)

7. *Approximate Material Properties in Isotropic Materials*, *IEEE Transactions On Sonics and Ultrasonics*, Alan R.Selfridge, Vol. SU-32, No.3, May 1985. Pages 381-394.
8. *Acoustic Properties of Solids*, Onda Corporation
9. [Murata Automotive-Grade Ultrasonic Transmitter/Receiver](#)
10. [PUI Audio Ultrasonic Transmitter/Receiver UTR-1440K](#)

6.1 商標

LaunchPad, BoosterPack, MSP430, Code Composer Studio are trademarks of Texas Instruments Incorporated.

すべての商標および登録商標はそれぞれの所有者に帰属します。

7 About the Author

CLARK KINNAIRD is a systems applications engineer at Texas Instruments. As a member of the Automotive Systems Engineering team, Clark works on various types of end equipment, especially in the field of body electronics, creating reference designs for automotive manufacturers. Clark earned his Bachelor of Science and Master of Science in Engineering from the University of Florida, and his Ph.D. in Electrical Engineering from Southern Methodist University.

TIの設計情報およびリソースに関する重要な注意事項

Texas Instruments Incorporated ("TI")の技術、アプリケーションその他設計に関する助言、サービスまたは情報は、TI製品を組み込んだアプリケーションを開発する設計者に役立つことを目的として提供するものです。これにはリファレンス設計や、評価モジュールに関する資料が含まれますが、これらに限られません。以下、これらを総称して「TIリソース」と呼びます。いかなる方法であっても、TIリソースのいずれかをダウンロード、アクセス、または使用した場合、お客様(個人、または会社を代表している場合にはお客様の会社)は、これらのリソースをここに記載された目的にのみ使用し、この注意事項の条項に従うことに合意したものとします。

TIによるTIリソースの提供は、TI製品に対する該当の発行済み保証事項または免責事項を拡張またはいかなる形でも変更するものではなく、これらのTIリソースを提供することによって、TIにはいかなる追加義務も責任も発生しないものとします。TIは、自社のTIリソースに訂正、拡張、改良、およびその他の変更を加える権利を留保します。

お客様は、自らのアプリケーションの設計において、ご自身が独自に分析、評価、判断を行う責任がお客様にあり、お客様のアプリケーション(および、お客様のアプリケーションに使用されるすべてのTI製品)の安全性、および該当するすべての規制、法、その他適用される要件への遵守を保証するすべての責任をお客様のみが負うことを理解し、合意するものとします。お客様は、自身のアプリケーションに関して、(1) 故障による危険な結果を予測し、(2) 障害とその結果を監視し、および、(3) 損害を引き起こす障害の可能性を減らし、適切な対策を行う目的で、安全策を開発し実装するために必要な、すべての技術を保持していることを表明するものとします。お客様は、TI製品を含むアプリケーションを使用または配布する前に、それらのアプリケーション、およびアプリケーションに使用されているTI製品の機能性を完全にテストすることに合意するものとします。TIは、特定のTIリソース用に発行されたドキュメントで明示的に記載されているもの以外のテストを実行していません。

お客様は、個別のTIリソースにつき、当該TIリソースに記載されているTI製品を含むアプリケーションの開発に関連する目的でのみ、使用、コピー、変更することが許可されています。明示的または黙示的を問わず、禁反言の法理その他どのような理由でも、他のTIの知的所有権に対するその他のライセンスは付与されません。また、TIまたは他のいかなる第三者のテクノロジーまたは知的所有権についても、いかなるライセンスも付与されるものではありません。付与されないものには、TI製品またはサービスが使用される組み合わせ、機械、プロセスに関連する特許権、著作権、回路配置利用権、その他の知的所有権が含まれますが、これらに限られません。第三者の製品やサービスに関する、またはそれらを参照する情報は、そのような製品またはサービスを利用するライセンスを構成するものではなく、それらに対する保証または推奨を意味するものでもありません。TIリソースを使用するため、第三者の特許または他の知的所有権に基づく第三者からのライセンス、あるいはTIの特許または他の知的所有権に基づくTIからのライセンスが必要な場合があります。

TIのリソースは、それに含まれるあらゆる欠陥も含めて、「現状のまま」提供されます。TIは、TIリソースまたはその仕様に関して、明示的か暗黙的にかかわらず、他のいかなる保証または表明も行いません。これには、正確性または完全性、権原、続発性の障害に関する保証、および商品性、特定目的への適合性、第三者の知的所有権の非侵害に対する黙示的保証が含まれますが、これらに限られません。

TIは、いかなる苦情に対しても、お客様への弁済または補償を行う義務はなく、行わないものとします。これには、任意の製品の組み合わせに関連する、またはそれらに基づく侵害の請求も含まれますが、これらに限られず、またその事実についてTIリソースまたは他の場所に記載されているか否かを問わないものとします。いかなる場合も、TIリソースまたはその使用に関連して、またはそれらにより発生した、実際の、直接的、特別、付随的、間接的、懲罰的、偶発的、または、結果的な損害について、そのような損害の可能性についてTIが知らされていたかどうかにかかわらず、TIは責任を負わないものとします。

お客様は、この注意事項の条件および条項に従わなかったために発生した、いかなる損害、コスト、損失、責任からも、TIおよびその代表者を完全に免責するものとします。

この注意事項はTIリソースに適用されます。特定の種類の資料、TI製品、およびサービスの使用および購入については、追加条項が適用されます。これには、半導体製品(<http://www.ti.com/sc/docs/stdterms.htm>)、評価モジュール、およびサンプル(<http://www.ti.com/sc/docs/sampterm.htm>)についてのTIの標準条項が含まれますが、これらに限られません。