

TI Designs: TIDA-01546

バッテリー駆動スマート流量計のバッテリーおよびシステム状態監視のリファレンス・デザイン



概要

このリファレンス・デザインでは、バッテリー駆動スマート流量計のバッテリーおよびシステム状態監視用の革新的なソリューションを紹介します。バッテリー監視サブシステムは、精度の高いエネルギー測定とSOH (State-Of-Health)推定を行い、バッテリーの寿命を予測できます。システム監視サブシステムは、バッテリー寿命の大幅な短縮につながる過電流状況からの保護を行います。

ここで紹介する手法は、バッテリー駆動のメータの実効寿命を伸ばし、施設運用業者の総保有コストを最適化するため役立ちます。

リソース

TIDA-01546	デザイン・フォルダ
bq35100	プロダクト・フォルダ
ADS7142	プロダクト・フォルダ
LPV521	プロダクト・フォルダ
TPS22860	プロダクト・フォルダ

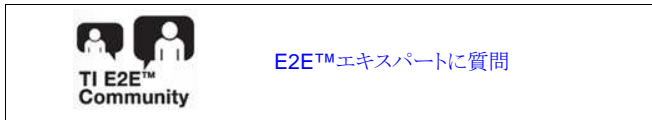

特長

- bq35100により、充電不可のリチウム一次バッテリーのSOHを監視
- 充電不可のリチウム・バッテリーの寿命(EOS)を正確に予測
- ADS7142 Nanopowerセンサ・モニタとLPV521オペアンプによる、低消費電力のシステム監視
- シングル・チャンネルの負荷スイッチによりシステム負荷を接続および切断
- リチウム塩化チオニル(LiSOCl2)とリチウム二酸化マンガン(LiMnO2)に対応
- 低いスタンバイ時消費電力: 1μAでシステムの状態を監視し、1μAでバッテリーの状態を監視

アプリケーション

- ガス・メータ
- 水道メータ
- 熱量メータ

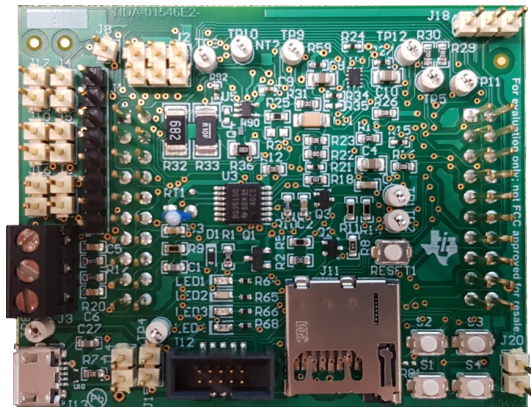
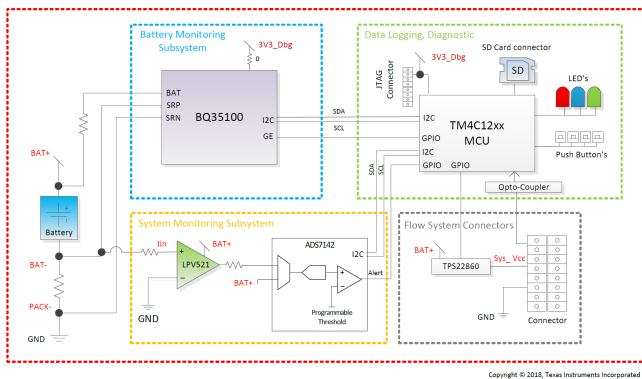

使用許可、知的財産、その他免責事項は、最終ページにあるIMPORTANT NOTICE (重要な注意事項)をご参照くださいますようお願いいたします。

1 System Description

Smart water, gas, and heat meters continue to evolve and add new features and capabilities but must still have an operational life of at least 10 years. This standard increases pressure on battery performance. Whether due to hardware or software issues, any malfunction of the system can impact battery life and therefore product life. The battery and system monitoring solutions in this reference design help protect against such issues and provide service operators greater insight into projected product life expectancy. This insight helps the operators optimize meter replacement and service costs.

The battery monitoring circuitry accurately monitors the battery state of non-rechargeable LiSOCl₂ and LiMnO₂ batteries used in smart flow meters. The functionality of primary battery monitoring is achieved by using a bq35100 battery fuel gauge monitor, which provides the State-Of-Health (SOH) and End-Of-Service (EOS) data. The data provided by the bq35100 can be correlated with the flow meter power consumption to accurately schedule the service replacement.

The circuitry for system health monitoring monitors the health of flow meters. Any malfunctioning of the flow meter due to software or hardware issues can lead to excess current consumption and negatively impact the battery life. The system health monitoring functionality is achieved by using a ADS7142 nanopower system monitor and LPV521 op amp. The ADS7142 provides programmable threshold settings to autonomously monitor the changes in battery current and to ensure the flow meter is functioning within the operating limits.

1.1 Key System Specifications

表 1. Key System Specifications

PARAMETER	SPECIFICATIONS
Input voltage source	Lithium battery (3.6-V nominal voltage)
Active state current consumption	400 μ A (battery monitoring), 80 μ A (system health monitoring)
Average standby-state current consumption	1 μ A (battery monitoring), 1 μ A (system health monitoring)
Estimated battery life	Greater than 10 years
Working environment	Indoor and outdoor
Form factor	50 mm \times 63 mm

2 System Overview

The system is designed to accurately monitor the battery state of non-rechargeable lithium batteries and control the overcurrent conditions in smart flow meters. The TM4C1294 MCU is programmed to control the bq35100 gauge monitor, ADS7142 sensor monitor, and TPS22860 load switch. The load switch provides the ability to connect or disconnect the system load (smart flow meter) and also apply a load to the battery. A microSD card is connected to the SD card slot for recording the battery monitoring data.

The battery monitoring section of the design accurately monitors the battery state of lithium non-rechargeable battery. The main battery monitoring functionality is achieved by using the bq35100 battery gauge fuel monitor. The TM4C1294 MCU communicates with the bq35100 through I²C™. The bq35100 monitor is a configurable device and can be used in three different modes based on the battery chemistry:

- SOH mode measures Lithium Manganese Dioxide (LiMnO₂) cell voltage and temperature.
- EOS mode determines depth of discharge of Lithium Thionyl Chloride (LiSOCl₂) batteries.
- Accumulator mode is chemistry-independent, but provides cell voltage, temperature, and accumulated discharged coulombs. This mode does not provide gauging data such as remaining SOH and EOS indication.

The system health monitoring section of the design monitors the health of the flow meter for overcurrent conditions and is implemented with the ADS7142 monitor and LPV521 op amp. The host MCU TM4C1294 communicates with the ADS7142 device through I²C. The ADS7142 device includes a digital comparator with a dedicated output pin, which is used to alert the host when a programmed high or low threshold is crossed.

2.1 Block Diagram

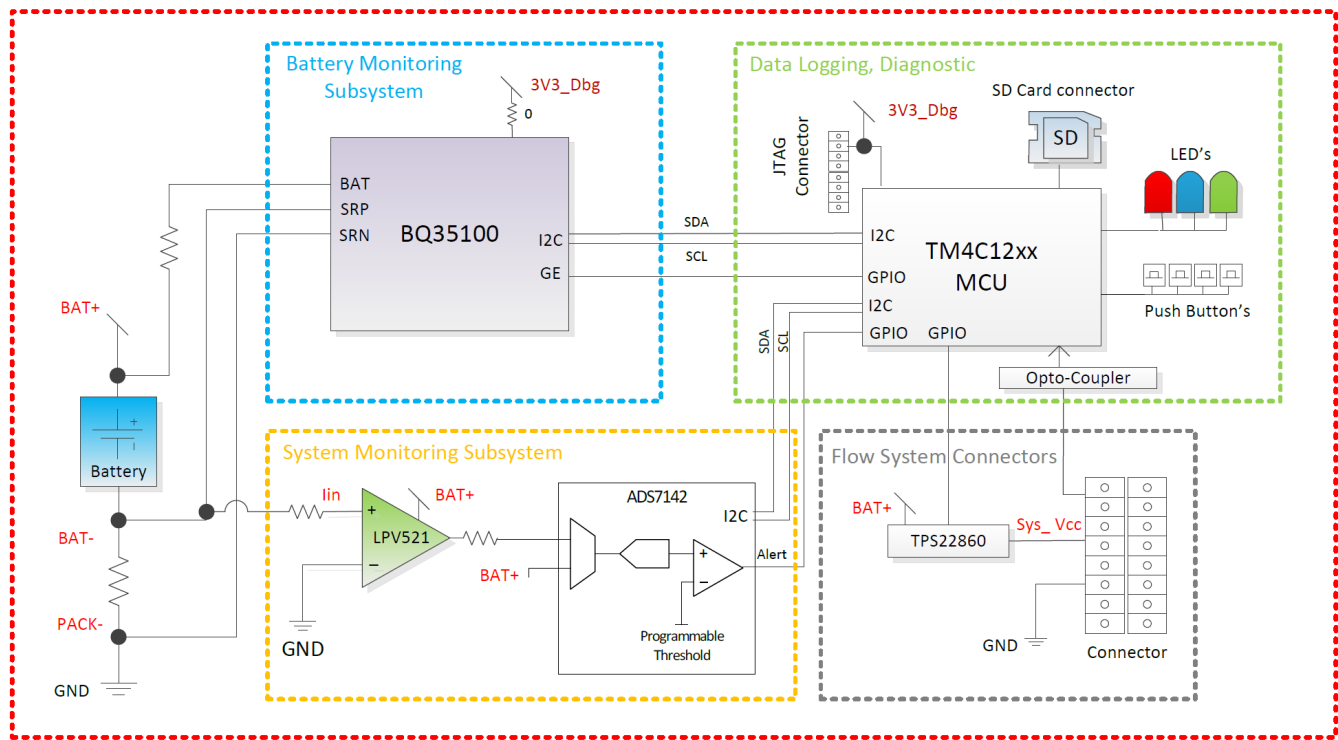

Copyright © 2018, Texas Instruments Incorporated

図 1. TIDA-01546 Block Diagram

2.2 Highlighted Products

2.2.1 bq35100

The bq35100 battery fuel gauge and EOS monitor provides highly configurable fuel gauging for non-rechargeable lithium batteries—without requiring any forced discharge of the battery. Built so that optimization is not necessary, the patented TI gauging algorithms support replaceable batteries and enable accurate results with ultra-low average power consumption through host control using the GAUGE ENABLE (GE) pin.

The fuel gauging functions use measured voltage, current, and temperature information to provide SOH and EOS data. The bq35100 device is only required to be powered long enough to gather data and to make calculations to support the selected algorithm and the frequency of updates required by the system.

The host can read the gathered data through a 400-kHz I²C bus. An ALERT output is also available to interrupt the host, based on a variety of configurable options.

2.2.2 ADS7142

The ADS7142 is a nanopower, dual-channel sensor monitor. The device consumes only 900 nW at a 1.8-V operation and includes an integrated digital windowed comparator with channel-independent, programmable, high and low thresholds and hysteresis for generating an ALERT output. The device supports an I²C serial interface and includes digital features such as offset calibration, a data buffer, and an accumulator.

The ADS7142 is available in a 10-pin 1.5-mm × 2.0-mm QFN package and is specified for operation from –40°C to +125°C. The miniature form-factor and extremely low power consumption make this device suitable for space-constrained and battery-powered applications.

2.2.3 LPV521

The LPV521 is a single nanopower 552-nW amplifier designed for ultra-long life battery applications. The operating voltage range of 1.6 V to 5.5 V coupled with typically 351 nA of supply current make it well suited for smart flow meter applications. The device has input common-mode voltage 0.1 V over the rails, ensured TC_{V_{OS}} and voltage swing to the rail output performance. The LPV521 has a carefully designed CMOS input stage that outperforms competitors with typically 40 fA I_{BIAS} currents. This low input current significantly reduces I_{BIAS} and I_{OS} errors introduced in megohm resistance, high impedance photodiode, and charge sense situations.

The LPV521 is a member of the PowerWise™ family and has an exceptional power-to-performance ratio.

The wide input common-mode voltage range, ensured 1 mV V_{OS}, and 3.5 μV/°C TC_{V_{OS}} enable accurate and stable measurement for both high-side and low-side current sensing.

EMI protection is designed into the device to reduce sensitivity to unwanted RF signals from cell phones or other RFID readers.

2.2.4 TPS22860

The TPS22860 is a small, ultra-low leakage current, single channel load switch. The device requires a VBIAS voltage and can operate over an input voltage range of 0 V to VBIAS. It can support a maximum continuous current of 200 mA.

The switch is controlled by an on/off input (ON), which is capable of interfacing directly with low-voltage control signals. The TPS22860 is available in two small, space-saving 6-pin SOT-23 and SC70 packages. The device is characterized for operation over the free-air temperature range of -40°C to 85°C .

2.2.5 CSD13383F4 N-Channel FemtoFet™

This 37-m Ω , 12-V N-channel FemtoFET™ MOSFET technology is designed and optimized to minimize the footprint in many handheld and mobile applications. This technology is capable of replacing standard small signal MOSFETs while providing at least a 60% reduction in footprint size.

2.2.6 TPD1E10B06 Single-Channel ESD

The TPD1E10B06 device is a single-channel electrostatic discharge (ESD) transient voltage suppression (TVS) diode in a small 0402 package. This TVS protection product offers $\pm 30\text{-kV}$ contact ESD, $\pm 30\text{-kV}$ IEC air-gap protection, and has an ESD clamp circuit with a back-to-back TVS diode for bipolar or bidirectional signal support. The 12-pF line capacitance of this ESD protection diode is suitable for a wide range of applications supporting data rates up to 400 Mbps. The 0402 package is an industry standard and is convenient for component placement in space-saving applications.

2.3 System Design Theory

The system is designed for both accurately monitoring the battery state of lithium non-rechargeable batteries, and system health monitoring of battery-powered smart flow meters. With smart flow meters expected to last for over 10 years in the field, the battery monitoring and system health monitoring implementation helps extend the lifetime of the battery. The TM4C1294 MCU included in the system aids in testing by controlling the bq35100 gauge monitor, the ADS7142 sensor monitor, and TPS22860 load switch and log the battery data onto an SD card. The load switch provides the ability to connect or disconnect the system load (smart flow meter), and apply a load to the battery.

2.3.1 Battery Monitoring

The bq35100 gauge monitor provides highly configurable fuel gauging for non-rechargeable lithium batteries. The fuel gauging functions uses measured voltage, current, and temperature information to provide SOH and EOS data. The bq35100 device is only required to be powered long enough to gather data and to make calculations to support the selected algorithm and the frequency of updates required by the system.

The host can read the gathered data through a 400-kHz I²C bus. An ALERT output is also available to interrupt the host, based on a variety of configurable options.

The device has extended capabilities, including the following:

- Fuel gauge for single- and multi-cell primary (non-rechargeable) batteries
- Supports Lithium Thionyl Chloride (LiSOCl₂) and Lithium Manganese Dioxide (LiMnO₂)
- Provides four configurable algorithm options:
 - Coulomb accumulation (ACC)
 - SOH
 - EOS
- Ultra-low average power consumption supported through gauge-enable control and mode control modes

- Accurate coulomb counter, voltage, and temperature measurement options
- I²C host communication, providing battery parameter and status access
- Data logging options

The bq35100 device uses voltage, current, and temperature parameters to provide the amount of energy remaining in the battery, which can be correlated with the system power consumption to accurately schedule the service replacement.

In addition, several battery condition warnings are available such as:

- Battery Low
- Temperature Low
- Temperature High
- Battery Low SOH
- Battery EOS

The bq35100 device can be configured in data collection mode to collect the battery in-service data, including min and max cell voltages, discharge current, and temperature, which can be used for maintenance purposes when the product reaches the end of its life cycle. For example, such information can help to optimize the software running in the MCU by correlating the code with voltage, current, and temperature conditions.

The basic measurement systems and bq35100 configurations details are provided in the following subsections.

2.3.1.1 Voltage

The bq35100 device measures the BAT input, which is scaled by an internal translation network, through the ADC. In systems where the battery voltage is greater than the maximum specified value of $V_{IN(BAT)}$ (for example, 2-series cell or more), an external voltage scaling circuit is required. If [EXTVCELL] is set, then the voltage is measured using the VIN pin. The input to VIN must be scaled to a maximum of 1 V.

The VEN pin can be used to enable and disable the external divider to conserve power. The firmware then scales this < 1-V value to reflect an average cell value, and then again by the number of series cells to reflect the full battery voltage value.

2.3.1.2 Temperature

The device can measure temperature through an integrated temperature sensor or an external NTC thermistor. Only one source can be used, and the selection is made by setting Operation A [TEMPS] appropriately. The resulting measured temperature is available through the Temperature() command. The internal temperature sensor result is also available through the InternalTemperature() command.

When an external thermistor is used, REG25 (pin 7) is used to bias the thermistor, and TS (pin 11) is used to measure the thermistor voltage (a pulldown circuit is implemented inside the device and is only enabled when measurements are required). The device then correlates the voltage to temperature, assuming the thermistor is a Semitec 103AT or similar device.

A configurable option allows the host to write the temperature to the Temperature() command when [WRTEMP] = 1. This option is disabled by default.

2.3.1.3 **Coulombs**

The integrating delta-sigma ADC in the device measures the discharge flow of the battery by measuring the voltage drop across a small-value sense resistor between the SRP and SRN pins.

The 15-bit integrating ADC measures bipolar signals from -0.125 V to $+0.125$ V. The device continuously monitors the measured current and integrates this value over time using an internal counter.

2.3.1.4 **Current**

For the primary battery current, the standard delta-sigma ADC in the device measures the discharge current of the battery by measuring the voltage drop across a small-value sense resistor between the SRP and SRN pins, and is available through the Current() command. The measured current also includes the current consumed by the device.

2.3.1.5 **Battery Gauging**

The bq35100 device can operate in three distinct modes: Accumulator (ACC) mode, SOH mode, and EOS mode. The device can be configured and used for only one of these modes in the field. because the bq35100 is not intended to be able to actively switch between modes when in normal use.

2.3.1.5.1 **Accumulator Mode**

In this mode, the bq35100 device measures and updates cell voltage, cell temperature, and load current every 1 s. This data is provided through the I²C interface while ControlStatus() [GA] is set. When in Accumulator mode, the bq35100 device tracks and then can store the total accumulated capacity to its internal data flash.

When the GE pin is asserted, the device updates AccumulatedCapacity() from the value stored in data flash. When ControlStatus() [GA] is set, the device adds each coulomb counter measurement to the value of AccumulatedCapacity().

Sending the GAUGE_STOP command prior to the GE pin being pulled low initiates the latest value of AccumulatedCapacity() to be written to data flash memory. As this operation takes a finite amount of time, the gauge asserts [G_DONE] in ControlStatus() and can optionally trigger the ALERT pin to inform the host when the operation is complete.

2.3.1.5.2 **SOH Mode**

This mode is enabled when [GMSEL1:0] in Operation Config A = 01. This mode is suitable for determining SOH for Lithium Manganese Dioxide (LiMnO₂) chemistry. In this mode, cell voltage and temperature are precisely measured immediately after the GE pin is asserted. The gauge uses this data to compute SOH.

$SOH = DOD(TermV) - DOD(OCV, temperature)$, where TermV is a DF constant determined by the manufacturer to be discharge voltage below which the cell cannot provide the power required by the device. A Battery Low SOH warning can optionally trigger the ALERT pin when the primary battery SOH falls below a programmable threshold.

2.3.1.5.3 EOS Mode

This mode is enabled when [GMSEL1:0] in Operation Config A = 10. This mode is suitable for gauging Lithium Thionyl Chloride (LiSOC12) cells. The EOS gauging algorithm uses voltage, current, and temperature data to determine the resistance (R) and rate of change of resistance of the battery. The resistance data is then used to find Depth of Discharge (DOD) = DOD(R). As described in 2.3.1.5.2, SOH is determined and in turn is used to determine the EOS condition.

When in EOS mode, issue a GAUGE_START() command prior to any major discharge activity. This command ensures that any major discharge pulses are used in the determination of the battery's condition. When any major discharge completes, send the GAUGE_STOP() command to the device. The gauge continues to collect data in a low power state for the number of seconds determined by *R Data Seconds*. The device then completes any calculations and flash writes. Once these tasks are completed, then [G_DONE] is set and the device can be powered down.

For optimal accuracy, the first event where the device updates its impedance value is required to be when the battery is full (a fresh battery). If the battery is partially discharged, then the accuracy of the EOS detection is compromised. When a new battery is inserted, send the NEW_BATTERY() command to the device to ensure the initial learned resistance RNEW is refreshed correctly.

In some cases, it is necessary to compensate for anode passivation effects if there is a delay between when the battery is conditioned for use and when the device is put into service. Several initial impedance readings can be discarded to remove passivation effects by setting an appropriate value for New Batt R Scale Delay.

2.3.2 System Health Monitoring

The size of the energy source is usually scaled to meet the system energy consumption and expected lifetime in the field. This size is not always accurate due to unforeseen issues that can occur, which prevent the smart flow meter from operating as expected. A malfunction of the flow meter due to hardware, software, or unplanned environmental issues can lead to excess current consumption and impact battery life. The system health monitoring solution monitors for overcurrent conditions and triggers a signal when an issue occurs. This signal allows for maintenance actions to be taken in a timely manner without impacting consumer service.

Current consumption of smart flow meters can vary widely depending on its mode of operation. 表 2 lists typical meter load profiles.

表 2. Typical Meter Load Profiles

MODE	CURRENT CONSUMPTION
Low-power standby	100 nA to 10 μA
Active mode	1 mA to 12 mA
Active mode with RF transmission	> 100 mA

The system monitoring circuitry is designed to detect if some fault condition is causing any of these modes to operate outside of the expected current consumption range. To implement system monitoring circuitry, a single nanopower LPV521 amplifier is used to amplify the current. The amplified current is fed to the ADS7142 nanopower sensor monitor, which can be configured with voltage thresholds corresponding to current limits for each mode of operation by the host MCU. The ADS7142 autonomously monitors the current and provides a signal on the ALERT pin when the current limits are exceeded.

3 Hardware, Software, Testing Requirements, and Test Results

3.1 Required Hardware and Software

3.1.1 Hardware

Figure 2 shows the hardware details.

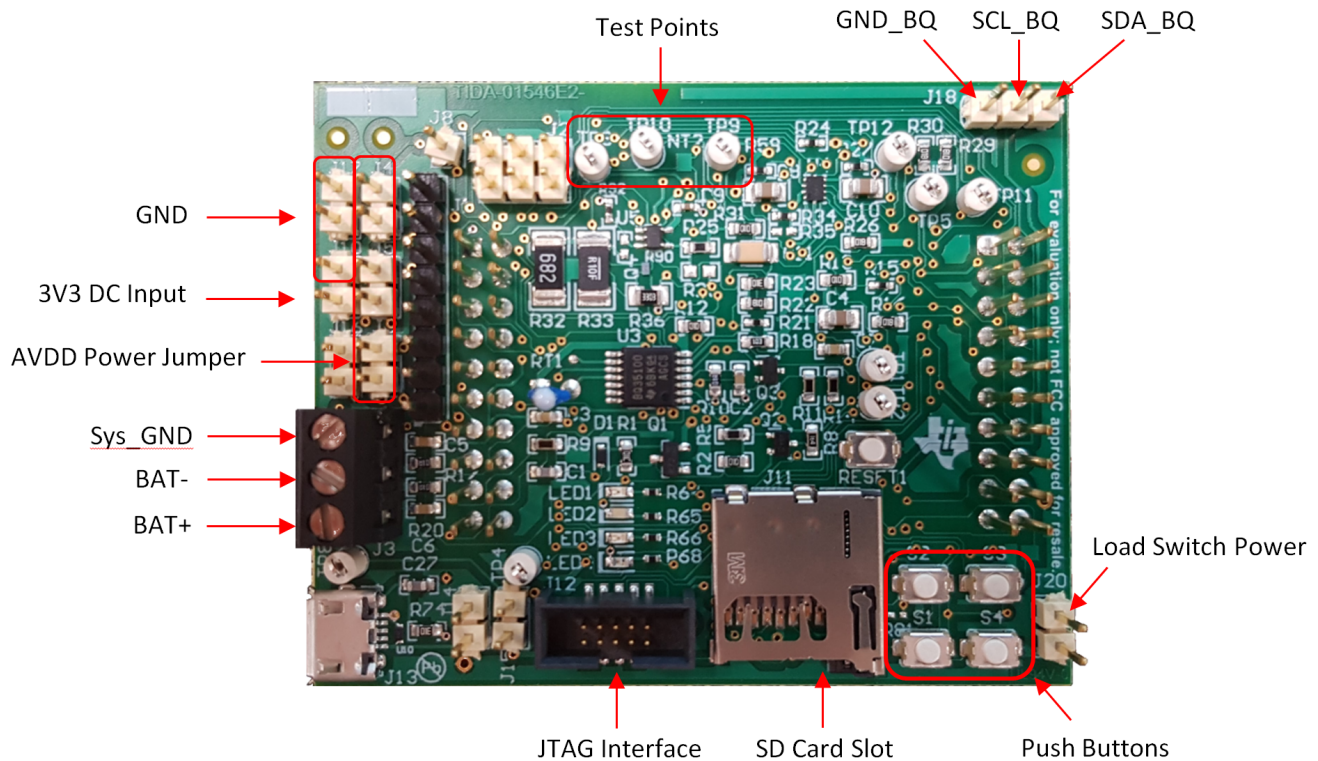

Figure 2. TIDA-01546 Hardware Description

The jumpers and battery input terminal block are located to the left side of the board. Several test points, the JTAG header, SD card connector, push-buttons, LEDs, and circuitry for battery and system health monitoring are located on the top side of the PCB.

3.1.1.1 Jumper Configuration

To facilitate measuring critical parameters and debugging the reference design, there are several jumpers included. However, to operate the design properly, the jumpers must be installed correctly. The jumper configuration for normal operation is J1 (pins 1,2): Shorted, J16: Shorted, and J5: Shorted. J20 can be shorted to use the optional load switch available on the board.

The following table describes the main configuration used during the tests:

Configurations	J1	J2	J4	J5	J6	J14	J15	J16	J20
Single Cell + ADS7142 power from supply (default)	1-2 shorted	not shorted	not shorted	shorted	not shorted	Can be used with J15	Can be used with J14	shorted	Can be used for load simulation
Single Cell + ADS7142 power from battery	1-2 shorted	not shorted	shorted	not shorted	not shorted	Can be used with J15	Can be used with J14	shorted	Can be used for load simulation
Multi Cell + ADS7142 power from supply	3-4 and 5-6 shorted	1-2 = 2S, 3-4 = 3S, 5-6 = 4S	not shorted	shorted	not shorted	Can be used with J15	Can be used with J14	shorted	Can be used for load simulation
Multi Cell + ADS7142 power from battery	3-4 and 5-6 shorted	1-2 = 2S, 3-4 = 3S, 5-6 = 4S	shorted	not shorted	not shorted	Can be used with J15	Can be used with J14	shorted	Can be used for load simulation

The following table describes how the different jumpers can be used on the PCB:

Jumper	Action
J1	bq35100 configuration (single cell or multi cell)
J2	bq35100 configuration (multi cell configuration)
J3	Battery and Load connector
J4	Power ADS7142 from the battery if shorted
J5	Power ADS7142 from the 3V3 power supply if shorted
J6	Power ADS7142 from the load switch output if shorted
J7	Booster pack connector
J9	Booster pack connector
J10	Power supply connector, do not short
J14	Connect BAT+ to Vbus of the micro USB plug
J15	Connect BAT+ to Ground of the micro USB plug
J16	Power bq35100 from the 3V3 power supply if shorted
J17	Ground connector
J18	bq35100 I ² C connector
J20	Connect BAT+ to the load switch input

3.1.2 Software

3.1.2.1 State-of-Health (SOH) Mode

The SOH mode is suitable for determining SOH for Lithium Manganese Dioxide (Li-MnO₂) chemistry. In this mode, cell voltage and temperature are precisely measured immediately after the GE pin is asserted. The gauge uses this data to compute SOH. Once the initial update occurs and the host reads the updated SOH, the device can be powered down.

Figure 3 describes the operation of the battery monitoring software in State of Health mode.

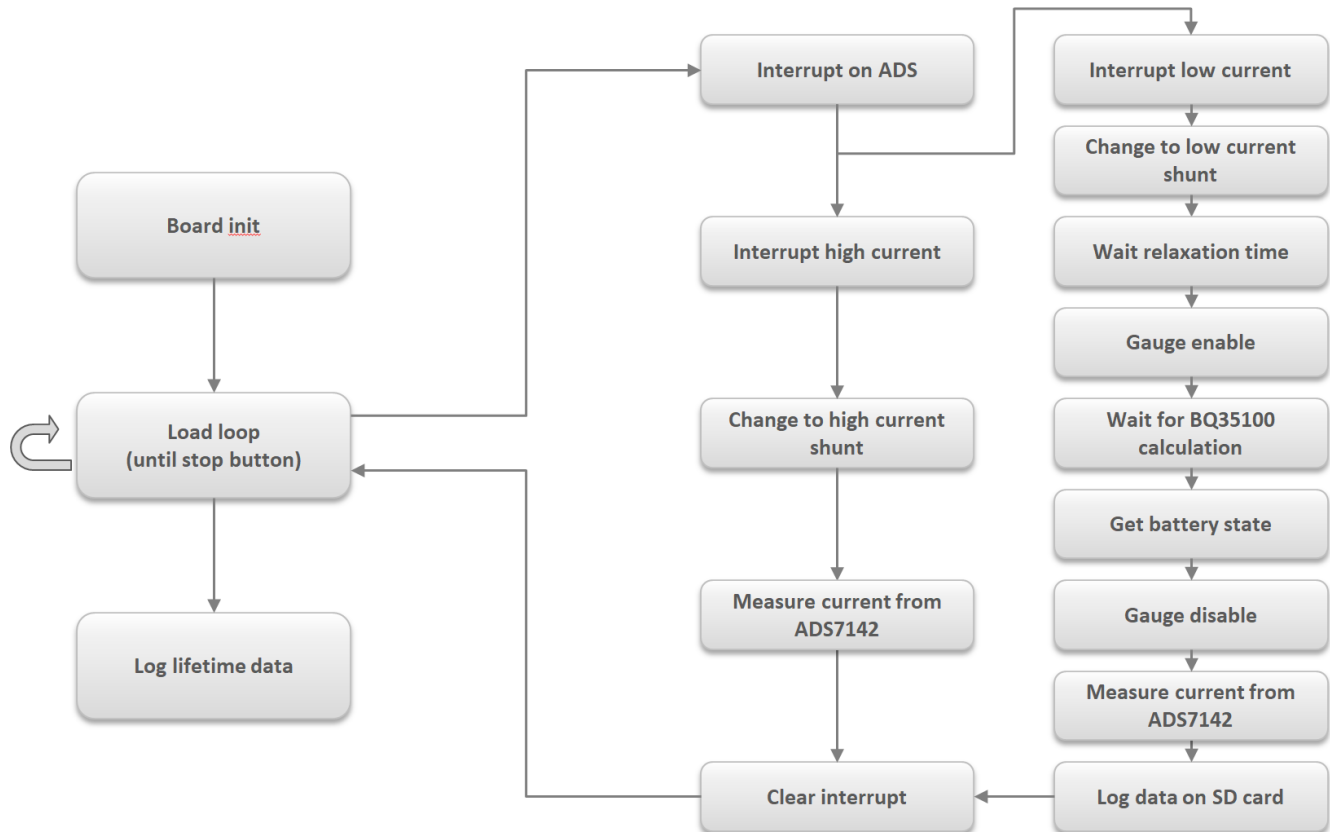

Figure 3. Flow Chart of SOH Mode Software

To configure the bq35100 gauge to use the SOH mode, the following data flash configuration variables must be configured correctly. For more details, including information on Operation Config A [GMSEL], see the bq35100 Technical Reference Manual (SLUUBH1).

The following steps show how to use the SOH mode:

- Step 1. Set GE high to power up the bq35100 gauge and wait for ALERT to go low due to INITCOMP=1.
- Step 2. Clear ALERT (read BatteryStatus()).
- Step 3. Read any required data such as State-Of-Health() for the latest battery data.
- Step 4. Optional: Send GAUGE_START().
- Step 5. Optional: Send GAUGE_STOP(). At this point, Lifetime Data can be stored and any Threshold detection checks are run. This is only needed if these features are desired.
- Step 6. Set GE low to power down the bq35100 device.

3.1.2.2 End-of-Service (EOS) Mode

This mode is suitable for gauging Lithium Thionyl Chloride (Li-SOCl₂) cells. The End-of-Service (EOS) gauging algorithm uses voltage, current, and temperature data to determine the resistance (R) and rate of change of resistance of the battery. The resistance data is then used to find Depth of Discharge (DOD) = DOD(R). As stated previously, SOH is determined and in turn used to determine the EOS condition.

☒ 4 describes the operation of the battery monitoring software in EOS mode.

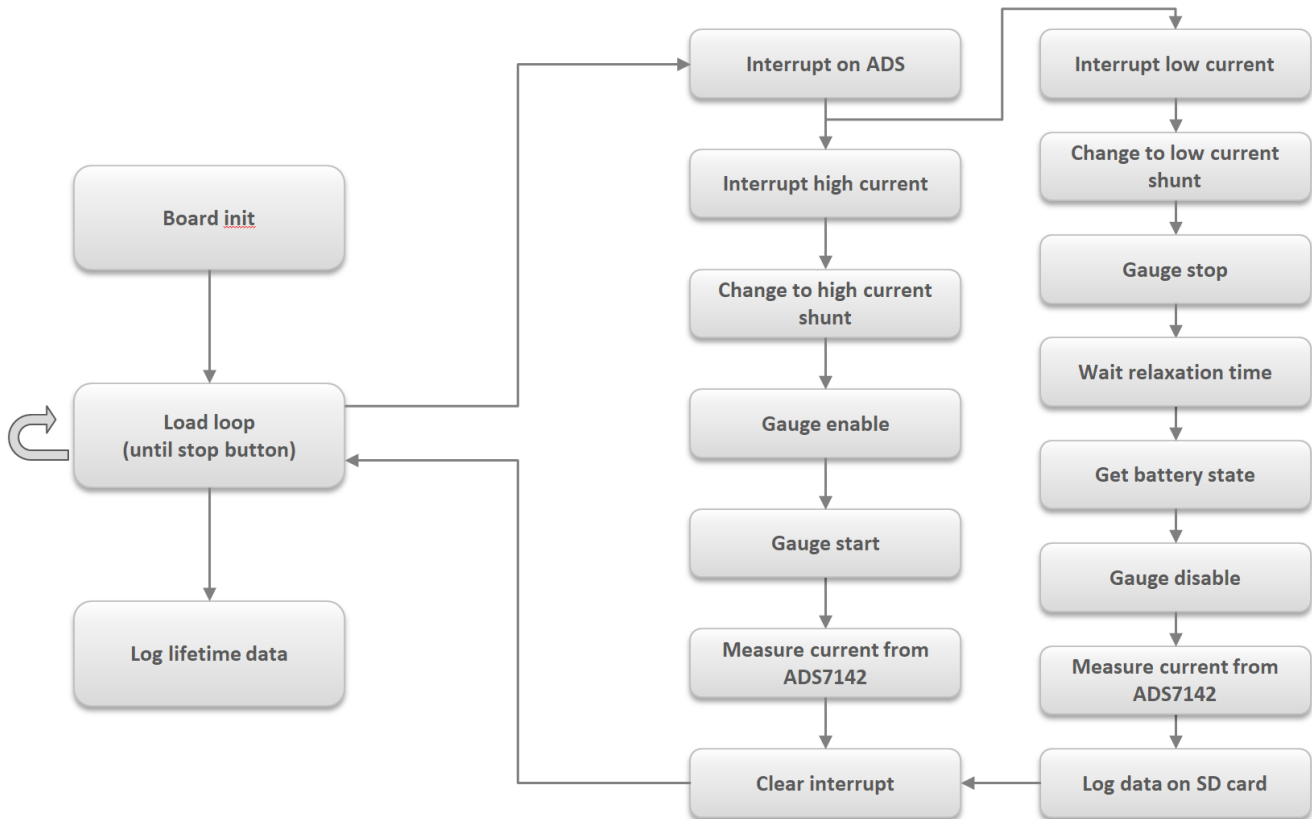

☒ 4. Flow Chart of EOS Mode Software

To configure the bq35100 device to use EOS mode, the following data flash configuration variables must be configured correctly. For more details, including information on Operation Config A [GMSEL], R Data Seconds, see the bq35100 Technical Reference Manual (SLUUBH1).

The following steps show how to use the EOS mode:

- Step 1. Set GE high to power up the bq35100 device and wait for ALERT to go low due to INITCOMP=1.
- Step 2. Clear ALERT (read BatteryStatus()).
- Step 3. Send GAUGE_START() 1 s prior to the high load pulse starting.
- Step 4. Send GAUGE_STOP() directly after the high load pulse has stopped. During the time between Step4 and Step 5 there should be no other pulse load. A low current DC load is acceptable.
- Step 5. Wait for ALERT to go low due to G_DONE = 1.
- Step 6. Read BatteryStatus() for an [EOS] decision and other data, such as State-Of-Health().
- Step 7. Set GE low to power down the bq35100 device.

3.2 Testing and Results

3.2.1 Test Setup

The following section describes the setups for measurements including the equipment used.

3.2.1.1 Steps to Calibrate bq35100

3.2.1.1.1 Requirements

1. Use the following equipment:
 - EV2300 or EV2400 communications interface adapter
 - USB cable
 - PC
 - Access to internet to install the bqStudio software setup program
2. Find the latest version of the software on the [bqStudio tool page](#). Search by part number for the bq35100 to access the tool folder for the device. To install bq35100 bqStudio software:
 - a. Ensure that the EV2300 or EV2400 is not connected to the personal computer (PC) through the USB cable before starting this procedure.
 - b. Open the archive containing the installation package, and copy its contents into a temporary directory.
 - c. Open the bqStudio installer file downloaded from the TI Web site.
 - d. Follow the instructions on the screen until completion of the software installation.
 - e. Before starting the evaluation software, connect the EV2300 or EV2400 to the computer using the USB cable.
 - f. If the EV2300 is connected, wait until the system prompt New Hardware Found appears. Choose Select Location Manually, and use the Browse button to point to the subdirectory TIUSBWin2K-XP-1.
 - g. Click Continue when the warning that drivers are not certified with Microsoft® appears.
 - h. If the EV2300 is connected, after the previous installation finishes, another system prompt New Hardware Found appears. Repeat steps 1 through 5, but specify the directory as TIUSBWin2K-XP-2.
 - i. Click Continue when the warning that drivers are not certified with Microsoft appears. Driver installation is now finished.
 - j. For the EV2400, the driver should be installed along with the software installation.

3.2.1.1.2 Hardware Connections

1. Ensure that the Jumper configuration is the same as specified in 3.1.1.1.
2. Connect the battery to J3 terminal block (BAT+, BAT-).
3. Connect the load to J3 terminal block (BAT+, SYS_GND).
4. Connect I2C SCL, SDA, and GND from J18 to the I2C port on EV2300 or EV2400 using wire leads.
5. Connect the PC USB cable to EV2300 or EV2400 and the PC USB port.

The bq35100 is now set up for calibration.

3.2.1.1.3 Calibration

The bq35100 must be calibrated to ensure accurate value reporting. Calibrate the device by going to the Calibration window in bqStudio (see  5).

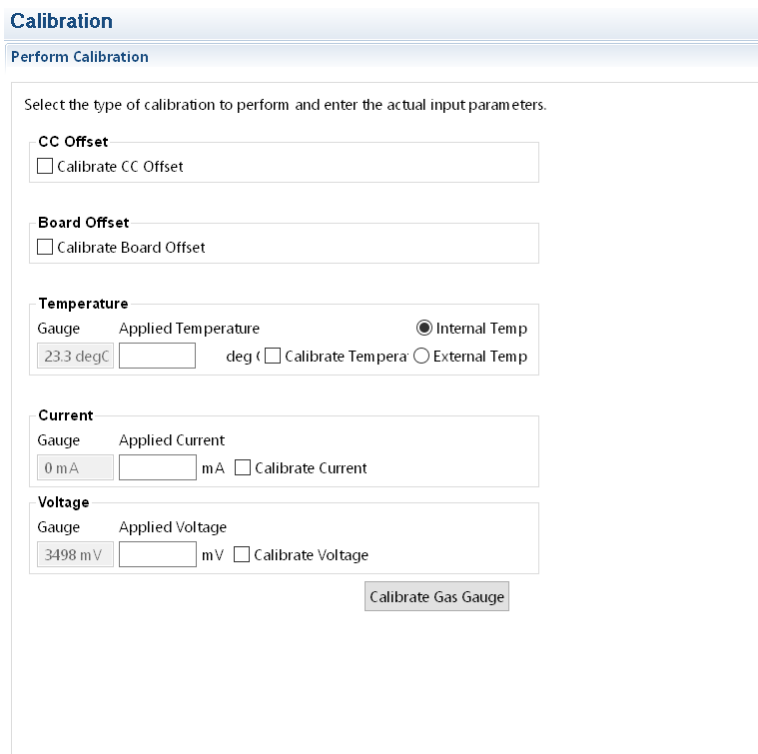

 5. Calibration Screen

3.2.1.1.3.1 Voltage Calibration

1. Measure the voltage from BAT+ to BAT-.
2. Enter this value in the Applied Voltage field.
3. Select the Calibrate Voltage box.
4. Press the Calibrate Gas Gauge button to calibrate the voltage measurement system.
5. Deselect the Calibrate Voltage boxes after voltage calibration has completed.

3.2.1.1.3.2 Current Calibration

The gauge offers CC Offset and Board Offset calibration options to zero any residual current that may be reported by the gauge. These calibrations are only required if the gauge does not report a current of 0 mA when no current should be present.

1. Select the CC Offset calibration option.
2. Press the Calibrate Gas Gauge button to calibrate.
3. Verify whether the current reports 0 mA. Proceed with the Board Offset Current calibration if current is reported.
4. Select CC Offset calibration option.
5. Press the Calibrate Gas Gauge button to calibrate.
6. Verify whether the current reports 0 mA.
7. Connect a 1-A load from BAT+ to PACK-.
8. Enter '-1000' in the Applied Current field and select the Calibrate Current box.
9. Press the Calibrate Gas Gauge button to calibrate.
10. Deselect the Calibrate Current box after current calibration has completed.

3.2.1.1.3.3 Chemistry Screen

The chemistry file contains parameters that the simulations use to model the cell and its operating profile. It is critical to program a Chemistry ID that matches the cell into the device. Some of these parameters can be viewed in the Data Flash section of bqStudio.

Press the Chemistry button to select the Chemistry window (see [Figure 6](#)).

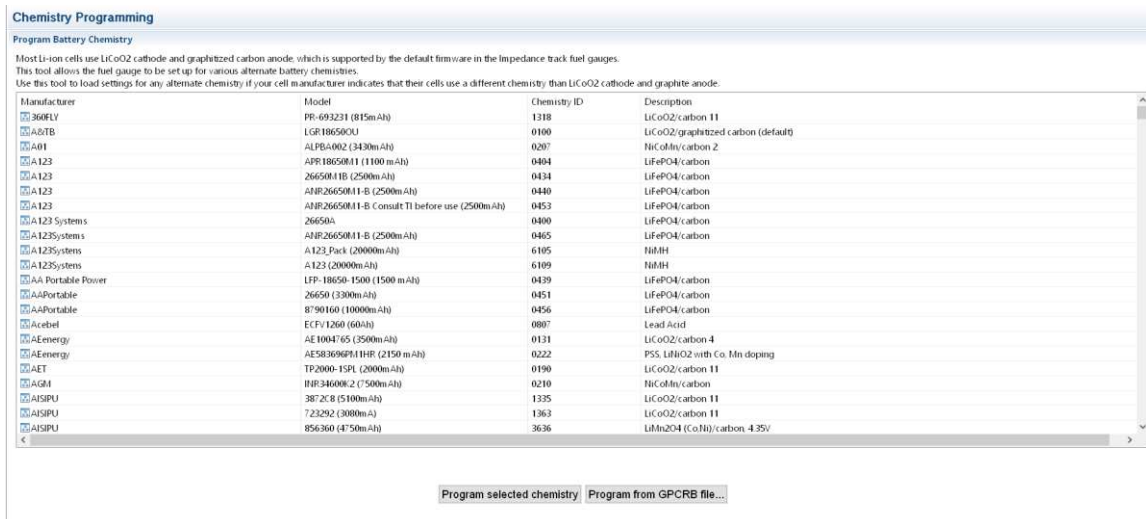

Figure 6. Chemistry Screen

1. Sort the table by clicking the desired column (for example, click on the Chemistry ID column header).
2. Select the Chemistry ID that matches the cell from the table (see [Figure 6](#)).
3. Press the Update Chemistry in the Data Flash button to update the chemistry in the device.

3.2.2 Setup Guide

This section describes the steps to program and test the PCB.

3.2.2.1 Reprogram TIDA-01546

This subsection describes how to reprogram the entire board. The board is already programmed by default, but this section might be useful in optimizing the board for a particular system. Therefore, this subsection is optional.

First, the software project must be open in Code Composer Studio. This procedure has been tested with CCS 7.3 ([Download CCS](#)). TivaWare™ 2.1.3.156 ([TivaWare™ for C Series](#)) must be installed as well in order to compile the software.

Once the software is loaded on CCS and compiled, it can be loaded into the board. Any XDS110 debugger can be used to debug the board. The following examples use the [CC-Debugger Devpack](#) or the MSP432 XDS110 debugger part. A 3.3-V power supply must be provided to the board by using the J10 header as shown in [Figure 7](#) (red: 3.3 V, black: ground).

Figure 7.

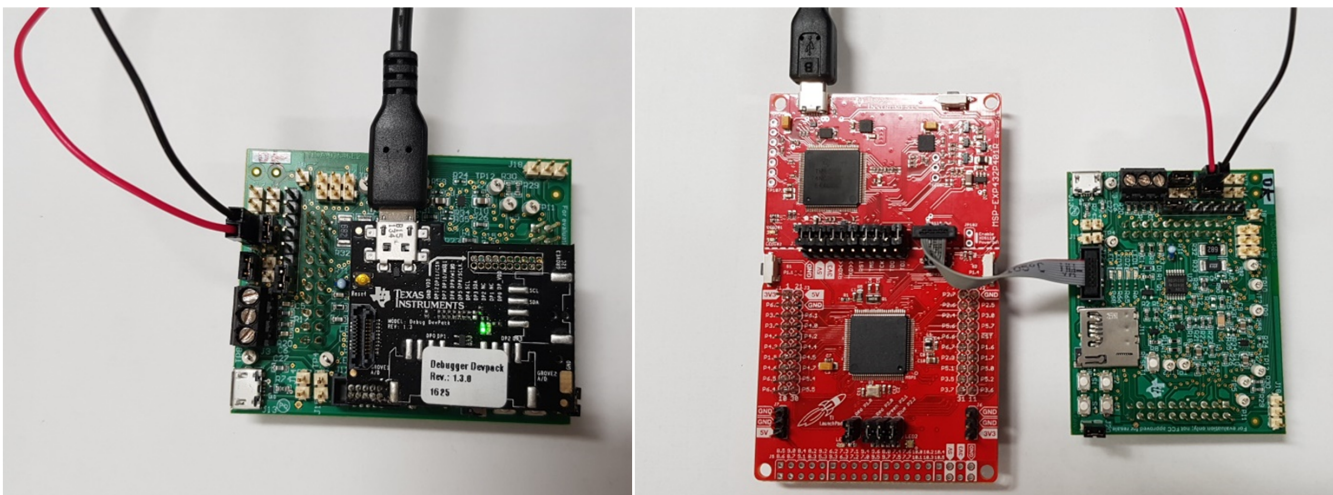

Figure 8. Debugger Connection Example

Load the program on the board by clicking Run and then Debug. Once the program is loaded, the Resume button must be pressed to start the program.

Configure the bq35100 by connecting an EV2300, or EV2400, to bq35100 by I²C. The I²C pins of the EV2300 must be connected to the J18 header. Refer to [3.1.1](#) for more information. The board also requires a 3.3-V supply on J10, and the jumper must be configured as described in [3.1.1.1](#). Lastly, connect the battery to the BAT+/BAT– pin of the J3 connector. [Figure 9](#) shows an example of the connections.

図 9.



図 10. EV2300 and Battery Connection

Once everything is connected, [Battery Management Studio](#) must be open to configure the bq35100. The software should automatically detect the bq35100. If the software is not automatically detected, the software can still be selected in the Target Selection Wizard under Gauge.

Under the Chemistry tab, choose the appropriate chemistry for the battery. To update the chemistry profile in the bq35100, select the appropriate chemistry in the list and click on the Update chemistry button.

Under the Data Memory tab, it is possible to change every parameter of the gauge. The most important is Operation Config A under Configuration. The value must be set to 11 for SOH mode and 12 for EOS mode. Then, the battery characteristics can also be configured under Gas Gauging. For more details about the different registers, please refer to the [bq35100 Technical Reference Manual](#).

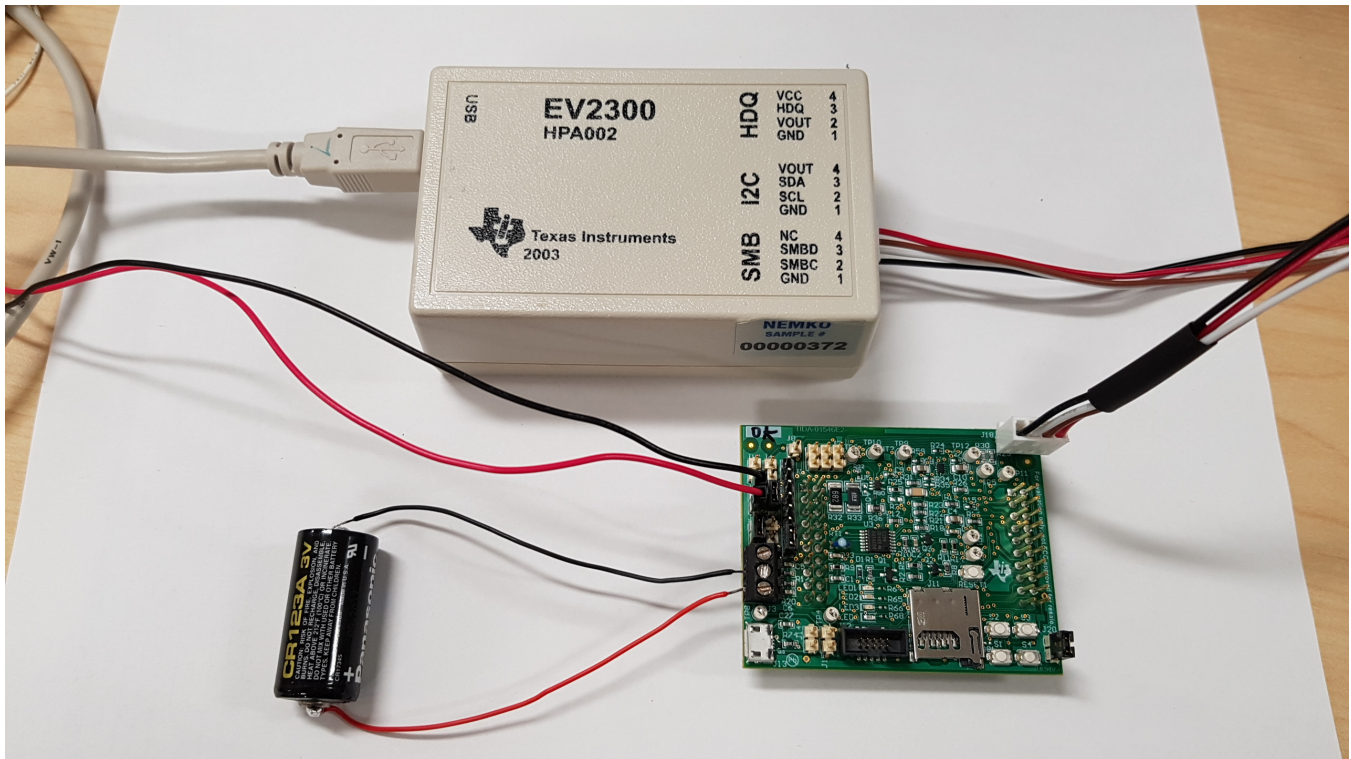
3.2.2.2 Testing the Board

By default, the board is configured for a 3-V Lithium Manganese Dioxide battery, and the software is optimized for the SOH mode. The current detection threshold is set for a 3-uA standby current and a 30-mA active current. When the current is above 6 uA, the transistor will switch on to connect the 0.1-Ω shunt resistor. When the current is below 6 mA, the transistor will switch off because the load is returning to standby mode. The MCU will then wait 10 minutes to allow time for the battery to relax (relaxation time configurable in the software) and then log the data on the SD Card.

To test the board, the battery must be connected to the BAT+/BAT- pins of the J3 connector. The supply must also be connected to J10 and the jumper configuration. Then, the micro SD card can be inserted into the SD slot. The load must be connected between the BAT+ and Sys_GND pins of the J3 connector.

図 11.



図 12. Battery and Load Connection

The load must be a square wave alternating between the thresholds of the ADS7142. By default, the standby current of the board must be between 300 nA and 5 uA, and the active current must be between 10 mA and 300 mA. These settings can be changed in the software.

The frequency of the load change depends of the relaxation time of the battery. This demo is optimized for a system that is active only a few times per day. By default, the relaxation time is set to 10 minutes so that the next load spike can be applied a minimum of 10 minutes after the end of the previous load spike. The duration of the load spike is irrelevant because the board will automatically detect when the load is applied and when the load goes back to standby mode.

A dynamic load or an MCU that alternates between Standby and Active mode can be used to draw very low current. Even without the necessary equipment, the load switch is also populated on the board and can alternate between two resistors to simulate the load behavior.

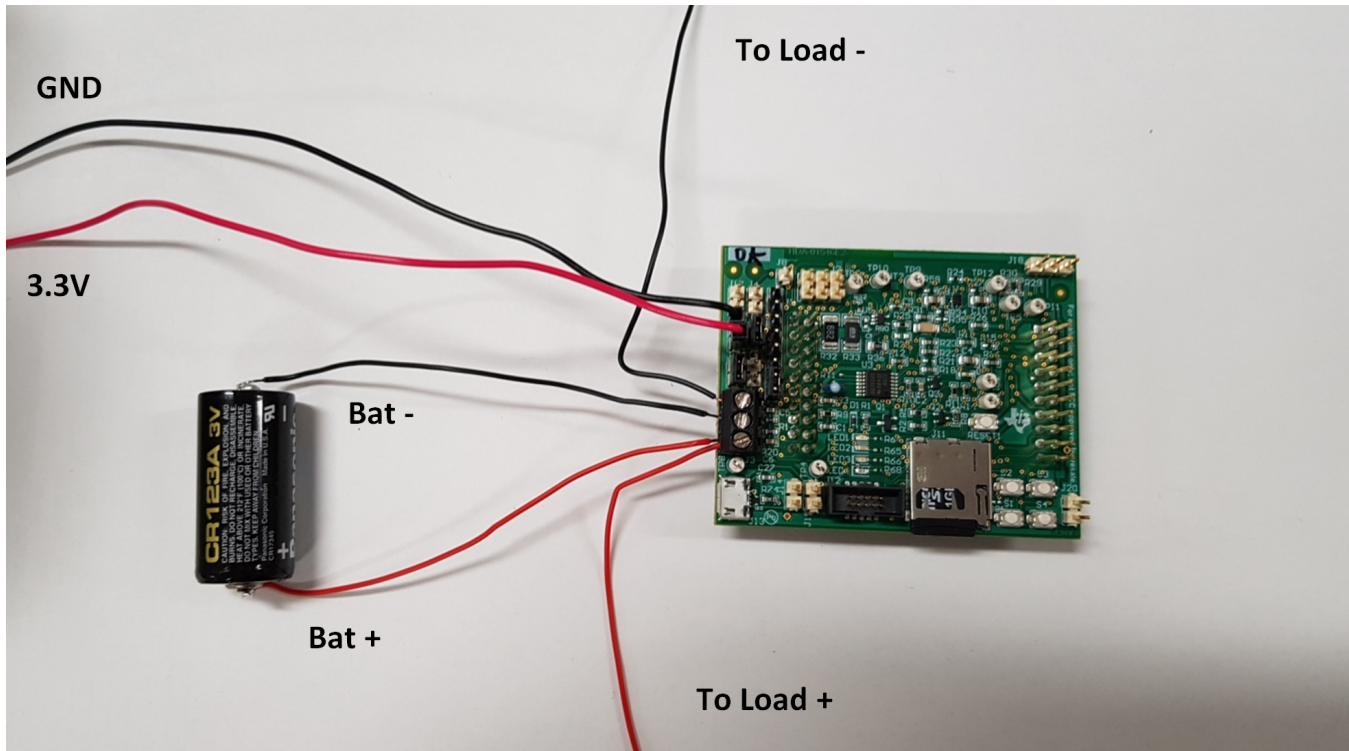
The load switch frequency and duty cycle can also be configured in the software. By default, the load is active for 2 seconds every 10 minutes. To use the load switch, R94 and R95 must be populated. See [Figure 13](#). The J20 jumper must be placed. R94 will simulate the standby current and R95 the active current. To work properly with the default threshold settings, TI recommends using 10 M Ω for R94 and 100 Ω for R95.

図 13.



図 14. Load Switch Resistance Placement

Once the setup is ready, reset the program by pressing the Reset button. To use the load switch, press the S4 button. A blue LED will light up and stay on. If the battery is new, press button S3 to send the New Battery command to the bq35100 and to reset the log file on the SD Card. A green LED will light up when the button is pressed.

To start the monitoring, press button S1. The red LED shows when a high current is detected. The green LED shows when the load spike is over and will stay on during relaxation time. The orange LED represents the active state of the load switch if used. To stop the monitoring, press the Reset button and take out the SD Card to read the data on a computer.

3.2.2.3 Modifying the Software

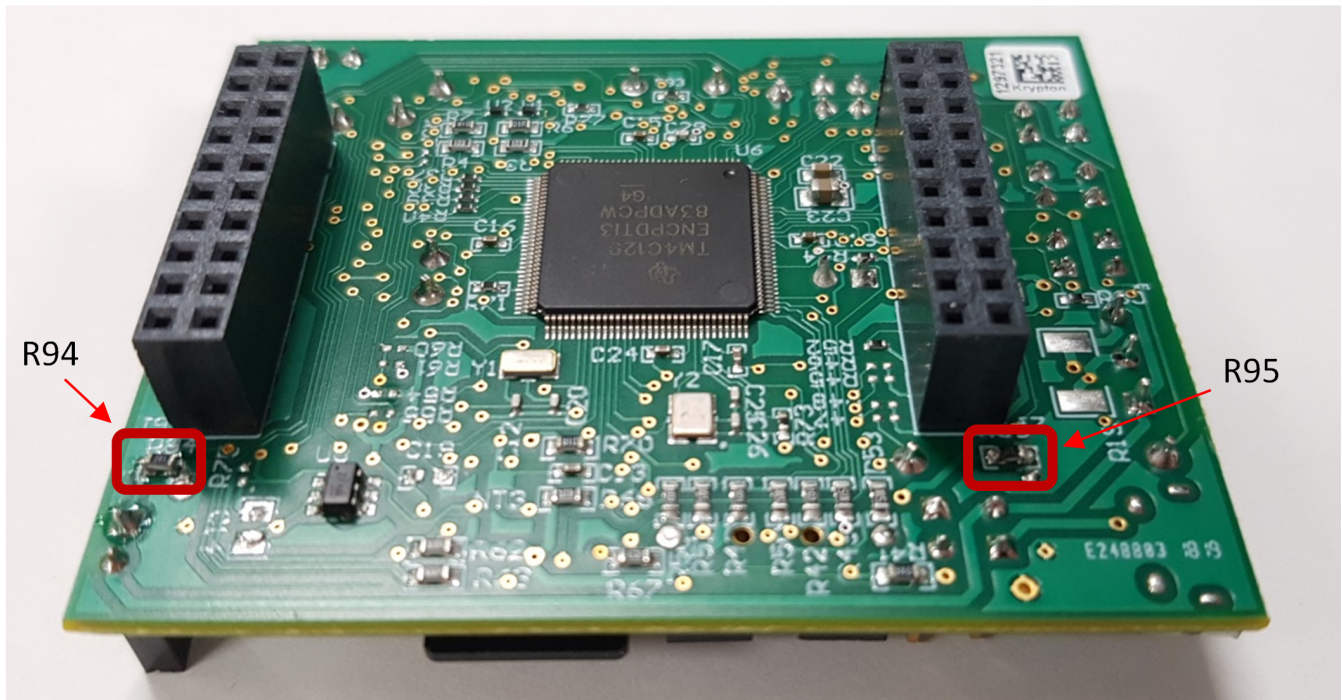
The TM4C software can be easily modified to fit a particular system need. First, there is a simple configuration file (config.h) that allows for changing the monitoring mode (SOH or EOS), the monitoring thresholds, and the relaxation time. To change the thresholds, please refer to the [ADS7142 Nanopower, Dual-Channel, Programmable Sensor Monitor Data Sheet](#).

In the software, there are two main functions that are used for monitoring. First, the main function (in main.c) will initialize the board and then go to an infinite loop. This loop will handle the load switch if used, or it will wait if not.

The second main function is AlertStatusIntHandler in cycle.c. This function will handle every interrupt signal received by the TM4C. According to the type of interruption, this function will take care of switching on and off the bq35100 and logging the data on the SD card.

3.2.2.4 Switching to EOS Mode

To switch to EOS mode, first set SOH_MODE to 0 and EOS_MODE to 1 in config.h. Then, recompile and load the program on the board by following the instructions in 3.2.2.1. Once that has been completed, the bq35100 must be configured as well.







By following the instructions in 3.2.2.1, connect the EV2300 and open Battery Management Studio. Under the data memory tab, Operation Config A (under Configuration) must be changed to 12 to set configured the bq35100 as EOS mode.

3.2.3 Test Results

3.2.3.1 Battery Monitoring Results

Battery life for this reference design varies based on the application, load currents, and use conditions.

For the purpose of testing battery monitoring circuitry, system loads with 0.3 mA, 0.5 mA, 1 mA, and 4 mA are connected to the design board. Voltage (V), current consumption (mA), and average current consumption (μAh) data of non-rechargeable battery are logged in a .csv file onto the SD card. The test results show the performance of battery gauge to accurately monitor the battery state of non-rechargeable batteries for loads $> 0.3 \text{ mA}$, and is plotted in the following figures.

In , , and , the number of cycles represents the cycle time ($\approx 2.5 \text{ s}$) between each data capture. In , the battery voltage measured is an unsigned integer value in mV with a range of 0 mV to 65535 mV. In , the average current measured is a signed integer value with units in 1 mA. In , the accumulated current provides an unsigned integer value with a range of 0 to 0.42E9 μAh .

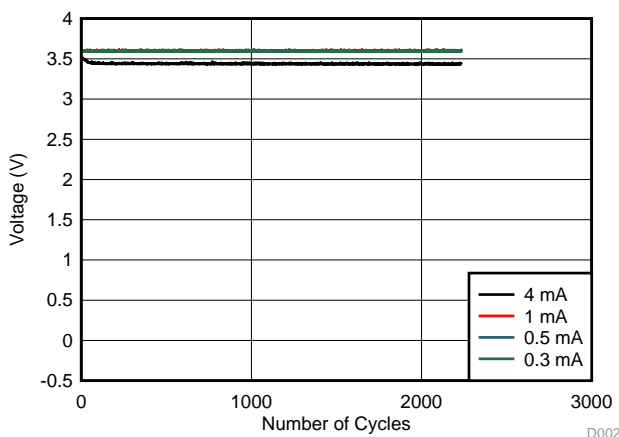

 15. Battery Voltage Measured by Gauge

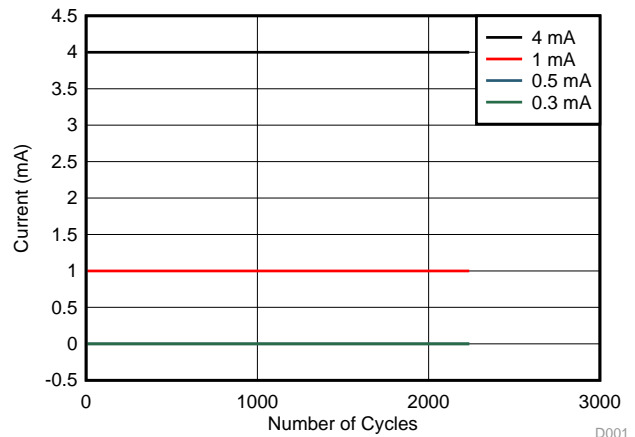

 16. Current Discharge (mA) Measured by Gauge



図 17. Accumulated Discharge Coulombs (µAh) Measured by Gauge

3.2.3.2 System Health Monitoring Results

System health monitoring tracks overcurrent conditions in flow meters and triggers a signal when current consumption exceeds the programmed threshold level. The programmable threshold level varies with the application, based on features, use conditions, and load currents. To cover load currents with low current inputs (µA) and high current inputs (mA), testing is conducted by setting the threshold at 0.1 V for low currents and at 1 V for high currents (mA). LED3 is turned ON if the current input exceeds the programmed threshold voltage to indicate overcurrent condition.

注:

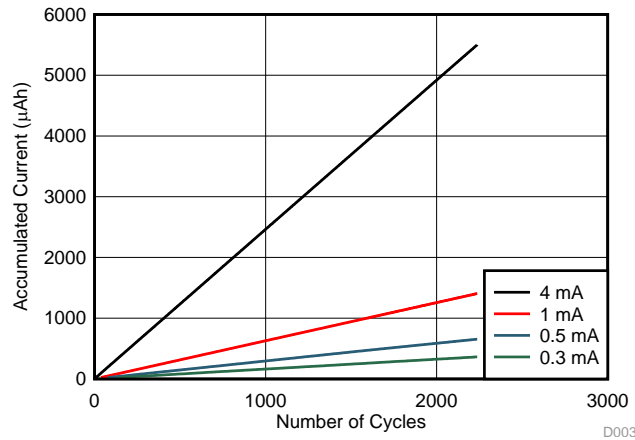
1. For low current (µA) testing, transistor Q4 is in off state.
2. Q4 is turned ON in the software to measure high currents (mA).

表 3 provides the threshold levels set in the software to test current inputs from 1 µA to 200 mA.

表 3. Results of System Health Monitoring

CURRENT INPUT	THRESHOLD SET IN SOFTWARE	LED3 STATUS
0.2 µA	0.1 V	OFF
0.4 µA	0.1 V	ON (overcurrent detected)
1.0 µA	0.1 V	ON (overcurrent detected)
1 mA	1 V	OFF
200 mA	1 V	ON (overcurrent detected)

3.2.3.3 Power Consumption

This section provides the power consumption numbers of battery monitoring and system monitoring circuitry.

3.2.3.3.1 Battery Monitoring

The power consumption of battery monitoring system is measured with the following configuration:

- J1 (pins 1–4) shorted
- BAT+ and BAT– battery input (Tadiran Lithium 3.6-V AA battery) applied to terminal block J3
- 3.3-V input applied to J10
- In standby mode, with GE low, the average current consumption is < 1 µA.

In active mode, with the gauge started to monitor battery state, the average current consumption measured is 400 μA .

3.2.3.3.2 System Health Monitoring

The power consumption of the system health monitoring system is measured with the following configuration:

- J4 shorted
- BAT+ and BAT– battery input applied to terminal block J3
- 3.3-V input applied to J10

表 4 shows the power consumption numbers for test conditions in normal mode and when overcurrent condition occurs.

表 4. Current Consumption Results of System Health Monitoring

TEST CONDITION	CURRENT CONSUMPTION
Normal load operation with no activity on I ² C lines	1 μA
Overcurrent condition detected with activity on I ² C lines	80 μA

4 Design Files

4.1 Schematics

To download the schematics, see the design files at [TIDA-01546](#).

4.2 Bill of Materials

To download the bill of materials (BOM), see the design files at [TIDA-01546](#).

4.3 PCB Layout Recommendations

4.3.1 Layout Prints

To download the layer plots, see the design files at [TIDA-01546](#).

4.4 Altium Project

To download the Altium project files, see the design files at [TIDA-01546](#).

4.5 Gerber Files

To download the Gerber files, see the design files at [TIDA-01546](#).

4.6 Assembly Drawings

To download the assembly drawings, see the design files at [TIDA-01546](#).

5 Software Files

To download the software files, see the design files at [TIDA-01546](#).

6 Related Documentation

1. Texas Instruments, [ADS7142 Nanopower, Dual-Channel, Programmable Sensor Monitor Data Sheet](#)
2. Texas Instruments, [bq35100 Lithium Primary Battery Fuel Gauge and End-Of-Service Monitor Data Sheet](#)
3. Texas Instruments, [LPV521 NanoPower, 1.8-V, RRIO, CMOS Input, Operational Amplifier Data Sheet](#)
4. Texas Instruments, [TPS22860 Ultra-Low Leakage Load Switch Data Sheet](#)
5. Texas Instruments, [MSP430FR604x\(1\), MSP430FR603x\(1\) Ultrasonic Sensing MSP430™ Microcontrollers for Water-Metering Applications Data Sheet](#)

6.1 商標

E2E, PowerWise, TivaWare are trademarks of Texas Instruments.

Microsoft is a registered trademark of Microsoft Corporation.

I²C is a trademark of NXP B.V. Corporation.



すべての商標および登録商標はそれぞれの所有者に帰属します。

改訂履歴

資料番号末尾の英字は改訂を表しています。その改訂履歴は英語版に準じています。

2018年1月発行のものから更新

Page

• 「リソース」で、プロダクト・フォルダ・リンクをTPS22918からTPS22860へ 変更	1
• 「特長」で、TLV521をLPV521に 変更	1
• TPS22918 to TPS22860 in 2 変更	3
• 2.2.4 title from TPS22918 to TPS22860 変更	5
• paragraph regarding TPS22860 to 2.2.4 追加	5
• paragraph regarding TPS22918 from 2.2.4 削除	5
• 2.2.6 追加	5
• information in first paragraph of 3.1.1.1 変更	9
• tables to 3.1.1.1 追加	10
• 3.1.2.1 title from <i>Battery Monitoring</i> to <i>State-of-Health (SOH) Mode</i> 変更	11
• paragraph to the beginning of 3.1.2.1 追加	11
• information regarding the MCU from 3.1.2.1 削除	11
•  3 title to <i>Flow Chart of SOH Mode Software</i> from <i>Flow Chart of Battery Monitoring Software</i> 変更	11
• instructions regarding use of the State-of-Health (SOH) mode to 3.1.2.1 追加	11
• 3.1.2.2 title from <i>System Health Monitoring</i> to <i>End-of-Service (EOS) Mode</i> 変更	12
• information regarding system health monitoring and the MCU in 3.1.2.2 削除	12
• information regarding End-of-Service (EOS) mode to 3.1.2.2 追加	12
•  4 title from <i>Flow Chart of System Health Monitoring</i> to <i>Flow Chart of EOS Mode Software</i> 変更	12
• instructions regarding use of the End-of-Service (EOS) Mode to 3.1.2.2 追加	12
• steps 1, 2, 3, and 4 in 3.2.1.1.2 変更	14
• 3.2.2 追加	16

TIの設計情報およびリソースに関する重要な注意事項

Texas Instruments Incorporated ("TI")の技術、アプリケーションその他設計に関する助言、サービスまたは情報は、TI製品を組み込んだアプリケーションを開発する設計者に役立つことを目的として提供するものです。これにはリファレンス設計や、評価モジュールに関係する資料が含まれますが、これらに限られません。以下、これらを総称して「TIリソース」と呼びます。いかなる方法であっても、TIリソースのいずれかをダウンロード、アクセス、または使用した場合、お客様(個人、または会社を代表している場合にはお客様の会社)は、これらのリソースをここに記載された目的にのみ使用し、この注意事項の条項に従うことに合意したものとします。

TIによるTIリソースの提供は、TI製品に対する該当の発行済み保証事項または免責事項を拡張またはいかなる形でも変更するものではなく、これらのTIリソースを提供することによって、TIにはいかなる追加義務も責任も発生しないものとします。TIは、自社のTIリソースに訂正、拡張、改良、およびその他の変更を加える権利を留保します。

お客様は、自らのアプリケーションの設計において、ご自身が独自に分析、評価、判断を行う責任がお客様にあり、お客様のアプリケーション(および、お客様のアプリケーションに使用されるすべてのTI製品)の安全性、および該当するすべての規制、法、その他適用される要件への遵守を保証するすべての責任をお客様のみが負うことを理解し、合意するものとします。お客様は、自身のアプリケーションに関して、(1) 故障による危険な結果を予測し、(2) 障害とその結果を監視し、および、(3) 損害を引き起こす障害の可能性を減らし、適切な対策を行う目的での、安全策を開発し実装するために必要な、すべての技術を保持していることを表明するものとします。お客様は、TI製品を含むアプリケーションを使用または配布する前に、それらのアプリケーション、およびアプリケーションに使用されているTI製品の機能性を完全にテストすることに合意するものとします。TIは、特定のTIリソース用に発行されたドキュメントで明示的に記載されているもの以外のテストを実行していません。

お客様は、個別のTIリソースにつき、当該TIリソースに記載されているTI製品を含むアプリケーションの開発に関連する目的でのみ、使用、コピー、変更することが許可されています。明示的または黙示的を問わず、禁反言の法理その他どのような理由でも、他のTIの知的所有権に対するその他のライセンスは付与されません。また、TIまたは他のいかなる第三者のテクノロジーまたは知的所有権についても、いかなるライセンスも付与されるものではありません。付与されないものには、TI製品またはサービスが使用される組み合わせ、機械、プロセスに関連する特許権、著作権、回路配置利用権、その他の知的所有権が含まれますが、これらに限られません。第三者の製品やサービスに関する、またはそれらを参照する情報は、そのような製品またはサービスを利用するライセンスを構成するものではなく、それらに対する保証または推奨を意味するものでもありません。TIリソースを使用するため、第三者の特許または他の知的所有権に基づく第三者からのライセンス、もしくは、TIの特許または他の知的所有権に基づくTIからのライセンスが必要な場合があります。

TIのリソースは、それに含まれるあらゆる欠陥も含めて、「現状のまま」提供されます。TIは、TIリソースまたはその仕様に関して、明示的か暗黙的にかかわらず、他のいかなる保証または表明も行いません。これには、正確性または完全性、権原、続発性の障害に関する保証、および商品性、特定目的への適合性、第三者の知的所有権の非侵害に対する黙示的保証が含まれますが、これらに限られません。

TIは、いかなる苦情に対しても、お客様への弁済または補償を行う義務はなく、行わないものとします。これには、任意の製品の組み合わせに関連する、またはそれらに基づく侵害の請求も含まれますが、これらに限られず、またその事実についてTIリソースまたは他の場所に記載されているか否かを問わないものとします。いかなる場合も、TIリソースまたはその使用に関連して、またはそれらにより発生した、実際の、直接的、特別、付随的、間接的、懲罰的、偶発的、または、結果的な損害について、そのような損害の可能性についてTIが知らされていたかどうかにかかわらず、TIは責任を負わないものとします。

お客様は、この注意事項の条件および条項に従わなかったために発生した、いかなる損害、コスト、損失、責任からも、TIおよびその代表者を完全に免責するものとします。

この注意事項はTIリソースに適用されます。特定の種類の資料、TI製品、およびサービスの使用および購入については、追加条項が適用されます。これには、半導体製品(<http://www.ti.com/sc/docs/stdterms.htm>)、評価モジュール、およびサンプル(<http://www.ti.com/sc/docs/sampterms.htm>)についてのTIの標準条項が含まれますが、これらに限られません。