

TI Designs: TIDA-01374

EMC準拠の車載用ストップ・ライトおよびテール・ライトのリファレンス・デザイン



概要

この車載用リファレンス・デザインでは、ストップ・ライトおよびテール・ライト用のソリューションについて詳説します。車載用バッテリーから、このデザインに使用されるTPS92830-Q1リニアLEDコントローラへ直接電力を供給することで、設計者は両方の機能に同じLEDを使用できます。また、このリファレンス・デザインには堅牢なEMC (電磁環境適合性)特性、完全な保護、診断機能などの特長があります。

リソース

[TIDA-01374](#)
[TPS92830-Q1](#)

デザイン・フォルダ
プロダクト・フォルダ

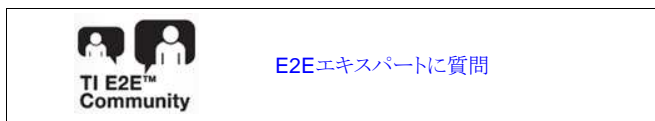

特長

- 車載用バッテリー電源
- CISPR 25伝導性および放射性エミッションの標準に準拠し、ISO11452-4バルク電流注入(BCI)テストに合格
- デバイス内部のパルス幅変調(PWM)ジェネレータを使用して、ストップ・ライトおよびテール・ライトにLEDを再利用
- LEDストリングの開路、グラウンドへの短絡、バッテリーへの短絡診断と、自動回復
- フォルト・バスを、1か所の障害で全体を不良とするか、障害の発生したチャンネルのみをオフにするか設定可能
- アナログ調光入力ピンによるLEDビニング機能

アプリケーション

- 車載用後部ライト(ストップおよびテール・ライト)

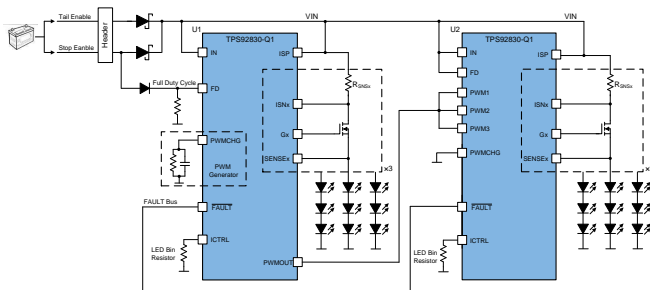

使用許可、知的財産、その他免責事項は、最終ページにあるIMPORTANT NOTICE (重要な注意事項)をご参照くださいますようお願いいたします。

1 System Description

Automotive stop lights and tail lights often reuse the same LEDs with two levels of brightness. This reference design offers a dual-brightness solution for stop- and tail-light reuse applications, using the integrated PWM generator of the TPS92830-Q1 controller. Two devices are cascaded by a synchronization PWMOUT output.

Using linear devices, this design has a satisfactory EMC performance that meets CISPR 25 Class-5 conducted emission and radiated emission standards and passes the ISO11452-4 BCI test.

This design provides the LEDs and devices with protection from LED string short-to-ground and open-circuit faults, with auto recovery. The LED open-circuit detection is disabled to avoid false diagnostics on an output channel resulting from a low supply voltage. By using different FAULT bus configurations, the designer can configure the system as one-fails-all-fail or only-failed-channel-off.

In the design, by using bin-setting resistors for analog dimming, the device can realize LED-bin brightness correction. In addition, the LED current can be reduced when the input voltage is higher than 18 V, to protect the MOSFETs from overheating.

1.1 Key System Specifications

表 1. Key System Specifications

PARAMETER	SPECIFICATION
Input voltage range	9 V to 16 V
Output current (tail light)	150 mA/CH with 20% duty cycle
Output current (stop light)	150 mA/CH
LED number	3s6p
LED type	LR H9GP, OSRAM

2 System Overview

2.1 Block Diagram



図 1. TIDA-01374 Block Diagram

2.2 Highlighted Products

2.2.1 TPS92830-Q1

The TPS92830-Q1 device is an advanced, automotive-grade, high-side, constant-current, linear LED controller, which delivers high current using external N-channel MOSFETs. The device has a full set of features for automotive applications. Each channel of the TPS92830-Q1 device independently sets the channel current using the sense resistor value. An internal, precision, constant-current, regulation loop senses the channel current by the voltage across the sense resistor and controls the gate voltage of the N-channel MOSFET accordingly. The device also integrates a two-stage charge pump for low-dropout operation. The charge-pump voltage is high enough to support a wide selection of N-channel MOSFETs. PWM dimming allows multiple sources for flexibility: internal PWM generator, external PWM inputs, or power-supply dimming. Various diagnostic and protection features specially designed for automotive applications help to improve the system robustness and ease of use. A one-fails-all-fail FAULT bus supports TPS92830-Q1 operation, together with the TPS92630-Q1, TPS92638-Q1, and TPS9261x-Q1 family of devices, to fulfill various fault-handling requirements.

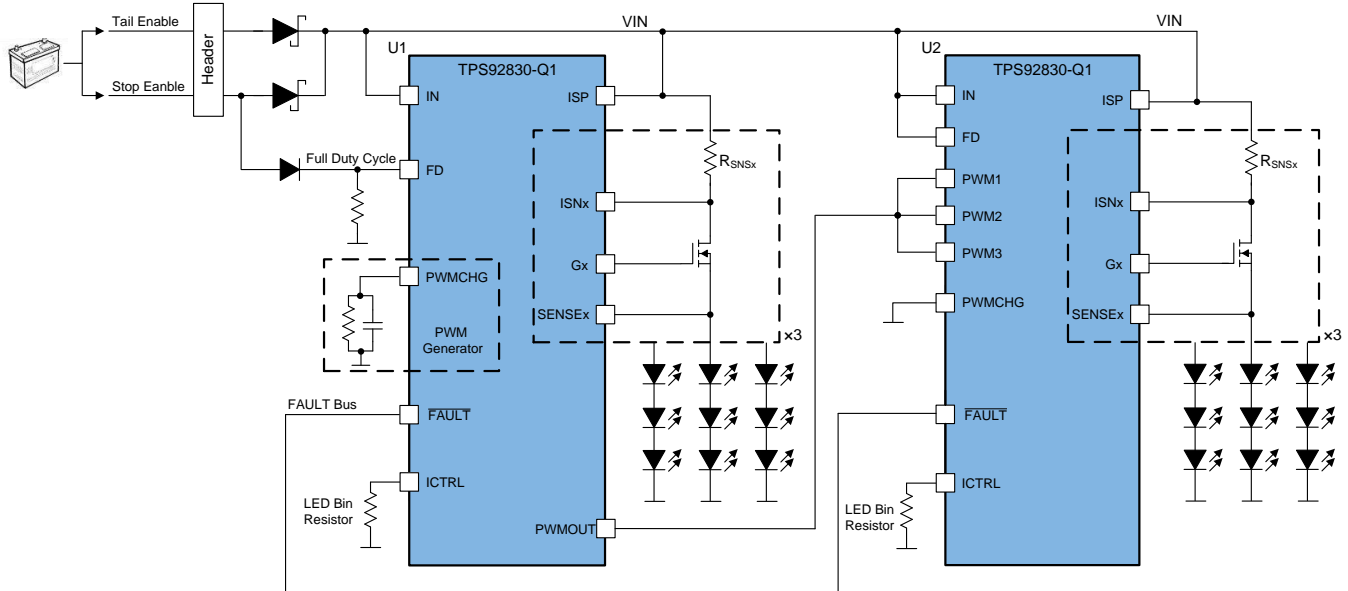
For more information on the TPS92830-Q1 device used in this reference design, see the [TPS92830-Q1 product folder](#).

3 System Design Theory

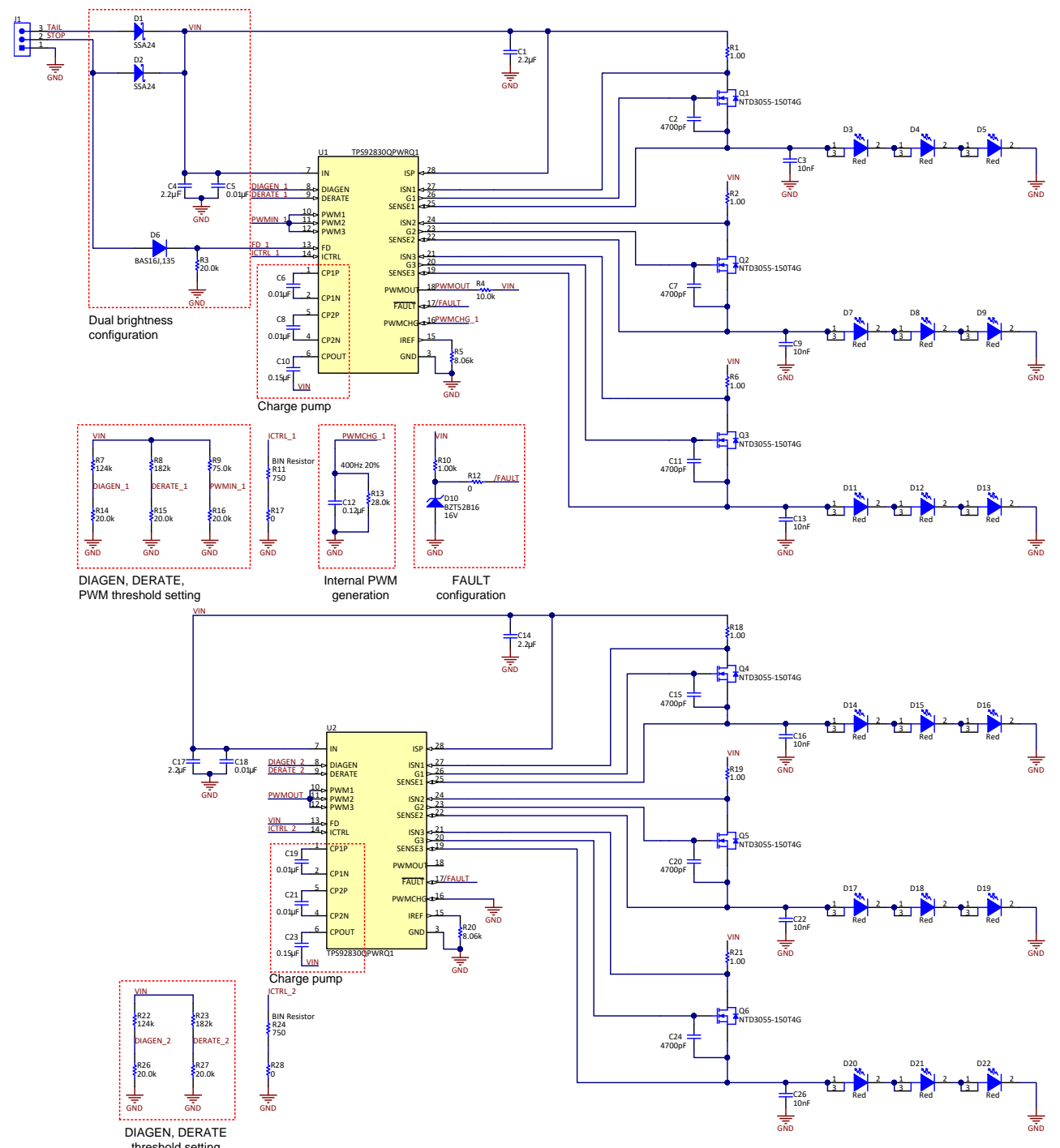
This reference design uses two TPS92830-Q1, linear LED controllers to drive six red LED strings. The TPS92830-Q1 device provides a precision PWM generator to realize the dual-brightness output control for automotive stop and tail light applications. Two devices are cascaded by a synchronization PWMOUT output. With a full set of features from the TPS92830-Q1, the design can realize various functions with simple external circuits.  2 shows the schematic of the design. The following subsections provide details on the design.



図 2. TIDA-01374 Schematic

3.1 Dual-Brightness Design

3.1.1 Dual-Brightness Control

This reference design uses the same set of LEDs to illuminate both automotive stop and tail lights. The LEDs can operate at two different brightness levels. One way to set the brightness level is through analog dimming, which means the LEDs always operate at a 100% duty cycle, and the maximum current through the LEDs varies to the required level of brightness. However, differing levels of LED current may affect the LED color temperature. The other option is to use PWM dimming, which can achieve the desired dimming ratio with the same color temperature.

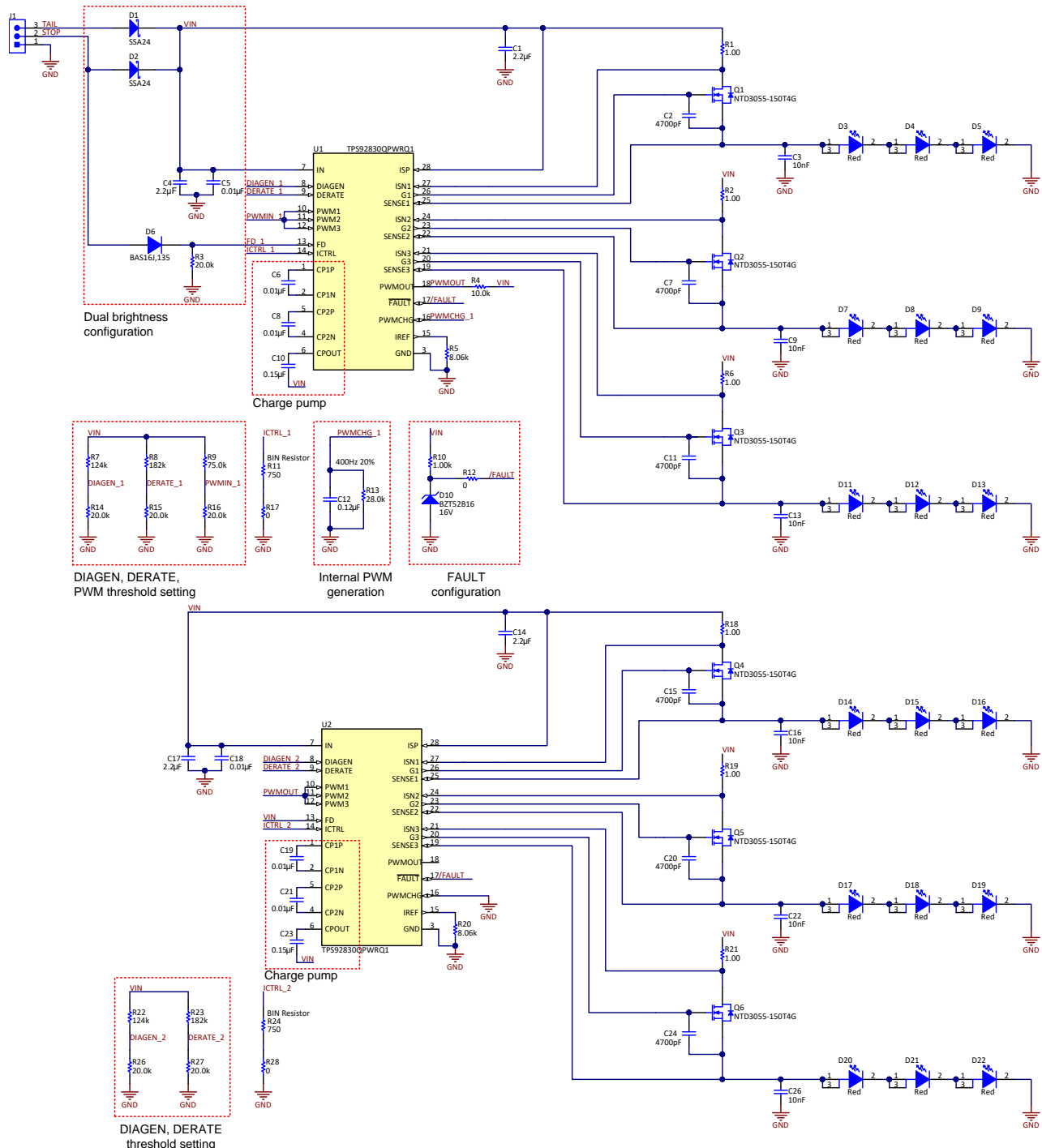
The TPS92830-Q1 device provides an integrated precision-PWM generator for on-chip PWM dimming. An external RC circuit sets the duty cycle and frequency of the PWM signal, as shown in [Figure 2](#). The device can flexibly switch between the internal PWM modulation mode and the 100% duty cycle mode by using the FD input. When the FD pin is low, the channel PWM depends on the internal PWM generator. When the FD pin is high, the internal PWM generator is bypassed, and the PWM inputs take complete control of the output. Moreover, the device supports open-drain PWMOUT for synchronization between devices. Each device can be connected as a master, which generates PWM, or as a slave, which relies on external PWM sources.

In this design, by connecting PWMOUT of U1 (TPS92830-Q1) to three PWM inputs of U2 (TPS92830-Q1), the two devices are in a master-slave configuration. When the STOP terminal is connected to the battery, the FD input of U1 is high. The output current of U1 is 150 mA per channel at a 100% duty cycle. Also, PWMOUT of U1 is high, so the output current of U2 is also at full duty cycle. The LED strings work in stop mode. When the TAIL terminal is connected to the battery, the FD input of U1 is low. The output current of U1 and U2 is at a 20% duty cycle and 400 Hz, as the external RC circuit sets. The LED strings work in tail light mode.

3.1.2 LED Current Design

The TPS92830-Q1 device has three independent, constant, current-driving channels. Each channel sets the channel current with an external, high-side, current-sense resistor, R_{SNSx} . The channel current is set as $V_{(\text{CS_REG})} / R_{\text{SNSx}}$.

Considering the analog dimming pin, ICTRL, is used for LED-bin brightness correction, the current-sense voltage, $V_{(\text{CS_REG})}$, is reduced using a dimming ratio, $k_{(\text{ICTRL_DIM})}$. The voltage across the sense resistor and the output current are reduced if the ICTRL voltage, $V_{(\text{ICTRL})}$, decreases. [Figure 3](#) shows the analog dimming ratio versus the $V_{(\text{ICTRL})}$ voltage. In the linear region, the analog dimming ratio can be calculated using [Equation 1](#).



図 3. Analog Dimming Ratio

$$k_{(ICTRL_DIM)} = \frac{V_{(ICTRL)}}{1.475 \text{ V}} \times 100\% = \frac{I_{(ICTRL_pullup)} \times R_{Bin}}{1.475 \text{ V}} \times 100\%$$

where

- $I_{(ICTRL_pullup)}$ is the ICTRL, internal pull-up current (typically 0.985 mA).
 - R_{Bin} is the bin-setting resistor connected between ICTRL and GND.
- (1)

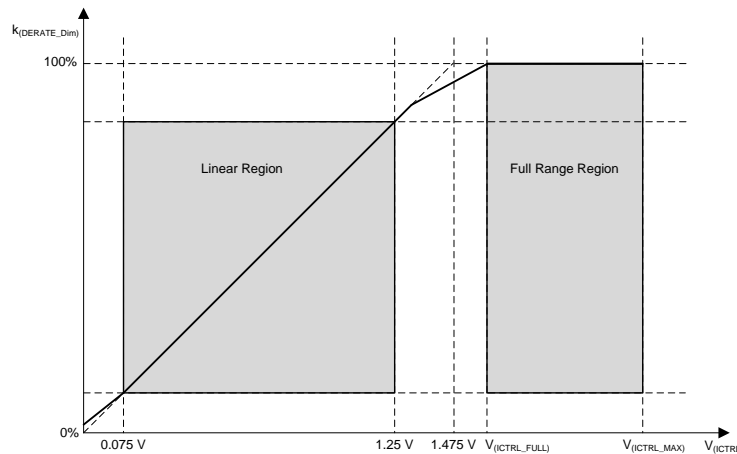
In this design, the current for each LED string is set at 150 mA, so the current-sense resistors can be calculated using 式 2.

$$R1(R18) = R2(R19) = R6(R21) = \frac{V_{(CS_REG)} \times k_{(ICTRL_DIM)}}{I_{(CH)}} = \frac{0.295 \times 0.985 \times R_{Bin}}{150 \times 1.475}$$

where

- $V_{(CS_REG)}$ is the current-sense resistor-regulation voltage (typically 295 mV).
 - $I_{(CH)}$ is the channel current.
- (2)

In this design, use 750-Ω resistors for R_{Bin} , R11 and R24. Use 1.0-Ω resistors for R1 (R18), R2 (R19) and R6 (R21). Designers can use bin-setting resistors of different value to adjust the output current if using LEDs from different bins, while the current-sense resistors can remain unchanged.

3.1.3 PWM Generator Design

As 3.1.1 describes, the designer must generate a 20% duty cycle and 400-Hz frequency PWM output to implement the tail light function. The PWM generator uses reference current $2 \times I_{(IREF)}$ as the internal charge current, $I_{(PWMCHG)}$. The recommended value of the reference resistors R5 and R20 in 図 2 is 8 kΩ. Select 8.06-kΩ resistors in this design.

Use external resistor R13 and C12 to set the PWM cycle time and duty cycle as required (see 式 3 and 式 4).

$$D_{(Tail)} = \frac{\ln \left(\frac{V_{(PWMCHG_th_falling)} - I_{(PWMCHG)} \times R13}{V_{(PWMCHG_th_rising)} - I_{(PWMCHG)} \times R13} \right)}{\ln \left(\frac{V_{(PWMCHG_th_falling)} - I_{(PWMCHG)} \times R13}{V_{(PWMCHG_th_rising)} - I_{(PWMCHG)} \times R13} \right) + \ln \left(\frac{V_{(PWMCHG_th_rising)}}{V_{(PWMCHG_th_falling)}} \right)}$$
(3)

$$f_{(\text{Tail})} = \frac{1}{R13 \times C12 \times \left[\ln \left(\frac{V_{(\text{PWMCHG_th_falling})} - I_{(\text{PWMCHG})} \times R13}{V_{(\text{PWMCHG_th_rising})} - I_{(\text{PWMCHG})} \times R13} \right) + \ln \left(\frac{V_{(\text{PWMCHG_th_rising})}}{V_{(\text{PWMCHG_th_falling})}} \right) \right]} \quad (4)$$

R13 can be derived as follows in 式 5.

$$R13 = \frac{V_{(PWMCHG_th_falling)} \times \left(\frac{V_{(PWMCHG_th_falling)}}{V_{(PWMCHG_th_rising)}} \right)^{\frac{D_{(Tail)}}{1-D_{(Tail)}}} - V_{(PWMCHG_th_rising)}}{I_{(PWMCHG)} \left[\left(\frac{V_{(PWMCHG_th_falling)}}{V_{(PWMCHG_th_rising)}} \right)^{\frac{D_{(Tail)}}{1-D_{(Tail)}}} - 1 \right]}$$

where

- $D_{(Tail)} = 0.2$
 - $f_{(Tail)} = 400$
 - $V_{(PWMCHG_th_rising)}$ is typically 1.48 V.
 - $V_{(PWMCHG_th_falling)}$ is typically 0.8 V (1).
 - $I_{(PWMCHG)}$ is typically 200 μ A (1).
- (1) Data sheet value; see the data sheet for a detailed calculation description. (5)

C12 can be derived as follows in 式 6.

$$C12 = \frac{1 - D_{(Tail)}}{R13 \times f_{(Tail)} \times \ln \left(\frac{V_{(PWMCHG_th_rising)}}{V_{(PWMCHG_th_falling)}} \right)}$$

(6)

式 3 shows that the duty cycle is only dependent on R13 and has nothing to do with C12, so the capacitance variation of C12 has no impact on the precision of the duty cycle.

According to the calculation, use $R13 = 28 \text{ k}\Omega$ and $C12 = 0.12 \text{ }\mu\text{F}$ in the design.

Because U2 is connected as a slave, the PWM input of U2 is connected to PWMOUT of U1 for synchronization. FD of U2 is pulled up to VIN and the PWM-generator oscillation stops. PWMCHG of U2 is connected to ground directly.

3.2 Charge Pump Design

The TPS92830-Q1 device uses a two-stage charge pump to generate the high-side gate-drive voltage, as shown in 図 2. The charge pump is a voltage tripler using external flying capacitors C6 (C19) and C8 (C21) and storage capacitor C10 (C23). The charge-pump voltage is high enough to support a wide selection of N-channel MOSFETs. Recommended capacitance for C6 (C19) and C8 (C21) and C10 (C23) is 10 nF, 10 nF and 150 nF.

3.3 MOSFET Driving Circuits

To ensure control-loop stability, the drive circuit requires sufficient gate-to-source capacitance (C_{GS}) on the MOSFETs. TI recommends the minimum total gate-to-source capacitance on the MOSFETs is 4 nF. For the NVD3055-150 MOSFET, TI recommends placing additional capacitors across the gate and source terminals, because C_{GS} is smaller than 1 nF. Use $C2 (C15) = C7 (C20) = C11 (C24) = 4.7 \text{ nF}$.

3.4 LED Fault Design

The TPS92830-Q1 device provides advanced diagnostics and fault protection methods for this design. The device can detect and protect the system from LED output short-to-GND, LED output open-circuit, and device overtemperature scenarios.

The TPS92830-Q1 supports flexible, FAULT bus diagnostic, which can be configured as one-fails-all-fail or only-failed-channel-off, based on legislative requirements and application conditions. Setting resistor R12 enables and disables the one-fails-all-fail function.

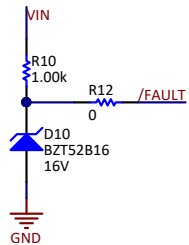
In , when R12 is not mounted, the $\overline{\text{FAULT}}$ pin is floating. During normal operation, an internal pull-up current source weakly pulls up the $\overline{\text{FAULT}}$ pin. If any fault scenario occurs, an internal pulldown current source strongly pulls the $\overline{\text{FAULT}}$ pin low. All outputs shut down for protection, which effectively realizes the one-fails-all-fail function. The faulty channel continually retries until the fault condition is removed. The designer can also connect the FAULT bus to an MCU for fault reporting.

If R12 is mounted, the $\overline{\text{FAULT}}$ pin is externally pulled up. The one-fails-all-fail function is disabled and only the faulty channel is turned off. A 16-V Zener diode (D10) is used to prevent the $\overline{\text{FAULT}}$ pin from overvoltage, because the recommended maximum operating voltage for the $\overline{\text{FAULT}}$ pin is 20 V.



図 4. Fault Bus Configuration of TPS92830-Q1

3.5 DIAGEN, DERATE, and PWM Threshold Setting

 shows a schematic of the DIAGEN, DERATE, and PWM threshold setting.



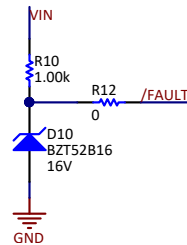
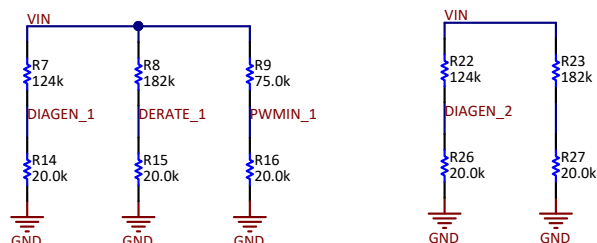

図 5. DIAGEN, DERATE, and PWM Threshold Setting

3.5.1 DIAGEN Setting

When the input voltage is not high enough to keep the external N-channel MOSFET in the constant-current saturation region, the TPS92830-Q1 device works in low-dropout mode. In low-dropout mode, the LED open-circuit detection must be disabled through the DIAGEN input. Otherwise, the dropout mode would be treated as an LED open-circuit fault.

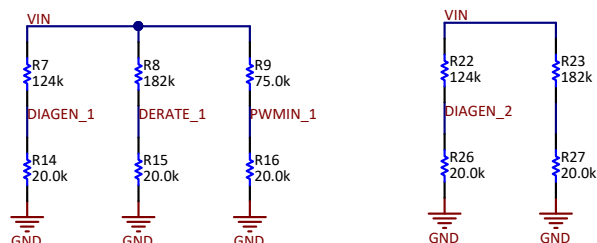
In this design, LED open detection is enabled when $V_{IN} > 9$ V. Use  to set the resistor dividers R7 (R22) and R14 (R26).

$$K_{(\text{RES_DIAGEN})} = \frac{R14(R26)}{R7(R22) + R14(R26)} = \frac{V_{IH(\text{DIAGEN, max})}}{9}$$

where

- $V_{IH(\text{DIAGEN, max})}$ is the maximum-input logic-high voltage for the DIAGEN pin in the data sheet (1.255 V). (7)

Set R7 (R22) = 124 k Ω and R14 (R26) = 20 k Ω .

3.5.2 DERATE Setting

The TPS92830-Q1 device has an integrated output-current derating function. Voltage across the sense resistor is reduced if the DERATE pin voltage ($V_{(\text{DERATE})}$) increases, so that the output current is reduced as well. [Fig 6](#) shows the output-current derating profile.

With an external resistor divider, R8 (R23) and R15 (R27), connected from V_{IN} to set the $V_{(\text{DERATE})}$ voltage, as shown in [Fig 5](#), the current is reduced when V_{IN} rises above the set level. Therefore, the current derating function can be used to limit power dissipation in external MOSFETs and LEDs, to prevent thermal damage at a high-input voltage.

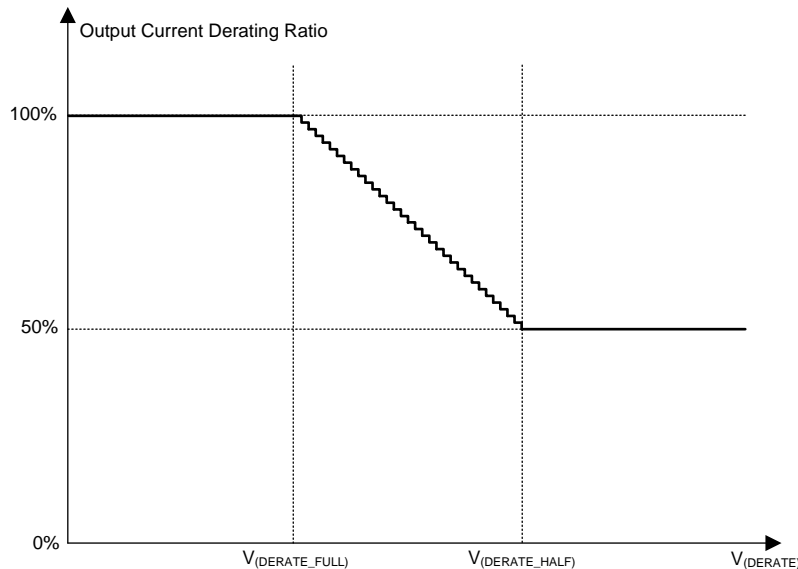

Fig 6. Output-Current Derating Profile

In this design, the output current is configured to be reduced when $V_{IN} > 18$ V, with the output-current derating feature. Use [Eq 8](#) to set the resistor divider ratio.

$$K_{(\text{RES_DERATE})} = \frac{R15(R27)}{R8(R23) + R15(R27)} = \frac{V_{(\text{DERATE_FULL})}}{18}$$

where

- $V_{(\text{DERATE_FULL})}$ is the full-range DERATE voltage in the data sheet (1.83 V). (8)

Set R8 (R23) = 182 k Ω and R15 (R27) = 20 k Ω .

3.5.3 PWM Threshold Setting

With the wide range of battery voltages in modern automotive systems, a common requirement among car OEMs is to turn LEDs off when the battery voltage is below the minimal voltage threshold. In this design, the three channels are designed to be enabled when $V_{IN} > 6$ V. PWM1 to PWM3 are connected together with a resistor divider, R9 and R16. Use 式 9 to set the resistor-divider ratio.

$$K_{(RES_PWM)} = \frac{R16}{R9 + R16} = \frac{V_{IH}(PWMx, \max)}{6}$$

where

- $V_{IH}(PWMx, \max)$ is the maximum-input logic-high voltage for PWM in the data sheet (1.248 V). (9)

Set R9 = 75 k Ω and R16 = 20 k Ω .

4 Getting Started Hardware

The following steps outline the hardware setup (see [Figure 7](#)).

1. Connect a 12-V DC power supply across terminals TAIL and GND, to enable the tail-light function.
2. Connect a 12-V DC power supply across terminals STOP and GND, to enable the stop-light function.



図 7. TIDA-01374 Board

5 Testing and Results

5.1 System-Input Current Tested Under Different Brightness Levels

With supply voltage applied to stop light input and tail light input, the device operates at 100% duty cycle and 20% duty cycle, respectively, achieving different brightness levels. [Table 2](#) lists the system-input currents tested under two different brightness levels.

表 2. System Input Current

FUNCTION	BRIGHTNESS	INPUT VOLTAGE	INPUT AVERAGE CURRENT
Stop light	100%	9 V	903 mA
		12 V	903 mA
		16 V	902 mA
Tail light	20%	9 V	188 mA
		12 V	188 mA
		16 V	188 mA

5.2 Waveforms

Figure 8 and Figure 9 show the input voltage and input-current waveforms for the stop and tail light function, respectively.

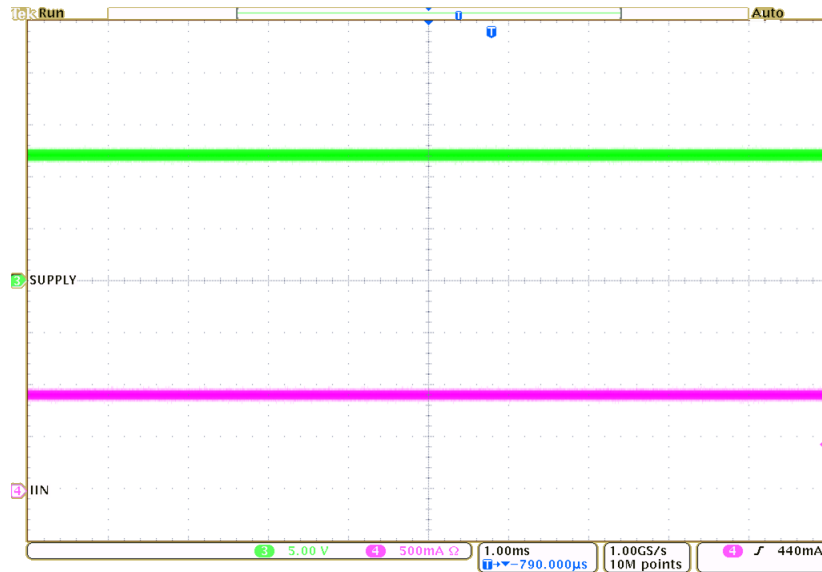

Figure 8. Stop-Function Waveform
CH3: Supply Voltage and CH4: Input Current

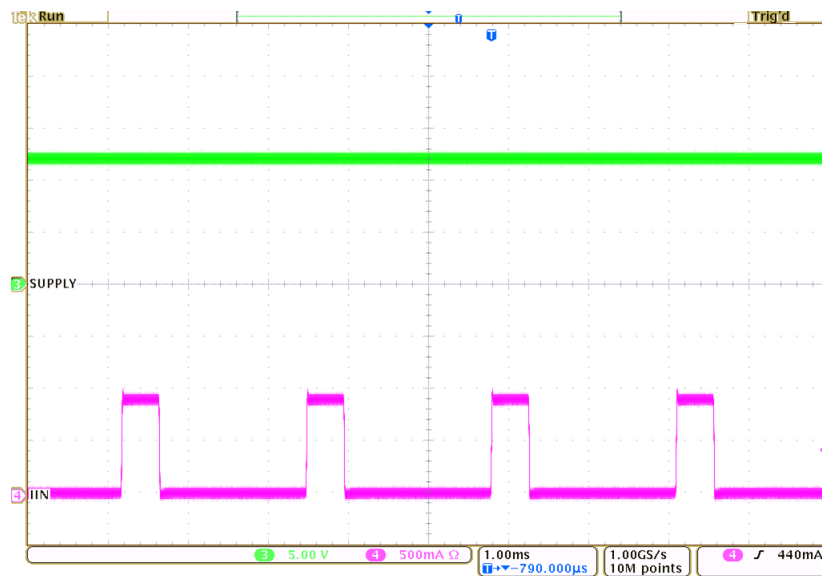

Figure 9. Tail-Light Function Waveform
CH3: Supply Voltage and CH4: Input Current

5.3 Thermal Results

Figure 10 and Figure 11 show the infrared thermal images of the design when operating as a stop and tail light, respectively. The input voltage is 12 V. The ambient temperature is 25°C.

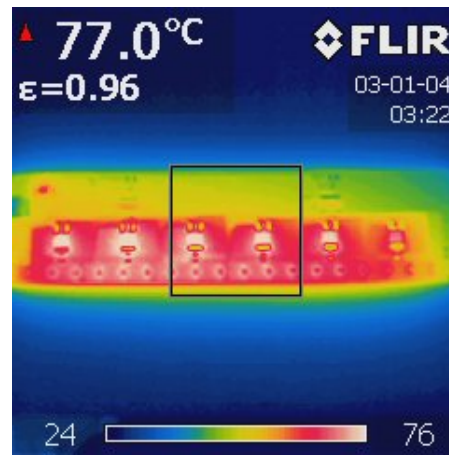

Figure 10. Thermal Image of Stop-Light Function at 25°C, 12-V Input Voltage

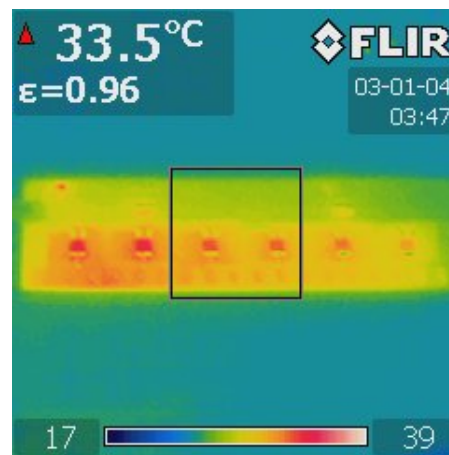

Figure 11. Thermal Image of Tail-Light Function at 25°C, 12-V Input Voltage

5.4 EMC Test Results

This reference design is compliant with several EMC standards that are important for automotive applications. The design has been tested against the CISPR 25 conducted and radiated emissions standard and ISO11452-4 BCI standard at a qualified third-party facility. The following subsections provide the test results.

5.4.1 Conducted and Radiated Emissions Test

CISPR 25 is the automotive EMI standard that most OEMs reference for requirements. Both conducted and radiated emissions tests for this design were completed against the CISPR 25 standards. The test was conducted at 13.5 V input when operating at the stop function mode.

表 3 lists the summarized results of both the conducted and radiated portions of the tests across different operating points and test conditions. For the test setup, test equipment, limits, and detailed test results, see the official test report at TIDA-01374.

表 3. Conducted and Radiated Emissions Test Results Summary

RADIATED EMISSION (ALSE METHOD) - CISPR25: 2008					
FREQUENCY BAND (MHz)	ANTENNA POLARIZATION	MEASUREMENT SYSTEM BANDWIDTH	DETECTION SCHEME	TEST LIMIT	TEST RESULT DESCRIPTION
0.15 to 30	V	9 kHz	PK/QP/AV	CISPR25: 2008 Class 5	Meets requirement
30 to 200	V	120 kHz	PK/QP/AV		Meets requirement
	H	120 kHz	PK/QP/AV		Meets requirement
200 to 1000	V	120 kHz	PK/QP/AV		Meets requirement
	H	120 kHz	PK/QP/AV		Meets requirement
1000 to 2500	V	9/120 kHz	PK/AV		Meets requirement
	H	9/120 kHz	PK/AV		Meets requirement
CONDUCTED EMISSION (VOLTAGE MODE) - CISPR25: 2008					
FREQUENCY BAND (MHz)	SUPPLY LINE POLARITY	MEASUREMENT SYSTEM BANDWIDTH	DETECTION SCHEME	TEST LIMIT	TEST RESULTS DESCRIPTION
0.15 to approximately 108	Positive	9/120 kHz	PK/QP/AV	CISPR25: 2008 Class 5	Meets requirement
	Negative	9/120 kHz	PK/QP/AV		Meets requirement

5.4.2 BCI Test

The BCI test for this design was conducted against the ISO11452-4 standard and at a 13.5-V input when operating in stop mode. 表 4 and 表 5 list the test requirement and acceptance criteria of the BCI test. 表 6 summarizes the test results. For the test setup, test equipment, limits, and detailed test results, see the official test report at [TIDA-01374](#).

表 4. BCI Test Requirement

BULK CURRENT INJECTION-ISO11452-4: 2011			
FREQUENCY (MHz)	FREQUENCY STEP SIZE (MHz)	DWELL TIME (sec)	TEST LEVEL (mA)
1 to 10	1	2	200
10 to 200	5	2	200
200 to 400	10	2	200

表 5. BCI Test Acceptance Criteria

WORKING MODE	MONITORING PARAMETERS	ACCEPTANCE	TEST LEVEL	STATUS
Mode 1	Brightness of light	No obvious phenomenon	200 mA	Class A

表 6. BCI Test Results Summary

FREQUENCY BAND (MHz)	INJECTION MODE	POSITION (mm)	MODULATION	TEST LEVEL	TEST RESULTS DESCRIPTION
1 to 400	CBCI	150	CW	200 mA	No obvious phenomenon
			AM		No obvious phenomenon
		450	CW		No obvious phenomenon
			AM		No obvious phenomenon
		750	CW		No obvious phenomenon
			AM		No obvious phenomenon

6 Design Files

6.1 Schematics

To download the schematics, see the design files at [TIDA-01374](#).

6.2 Bill of Materials

To download the bill of materials (BOM), see the design files at [TIDA-01374](#).

6.3 PCB Layout Recommendations

This design relies on external MOSFETs to dissipate heat. The thermal performance of the design is highly dependent on the cooling conditions of the MOSFETs and LEDs. A good printed-circuit board (PCB) design can optimize heat transfer, which is essential for long-term reliability. Consider the following PCB layout recommendations:

- Increase copper thickness or use metal-based boards if possible. Maximize the copper coverage on the PCB to increase the thermal conductivity of the board. Place thermal vias on the thermal dissipation area to further improve the thermal dissipation capability.
- The current path starts from IN through the sense-resistors, MOSFETs, and LEDs to GND. Wide traces are helpful to reduce parasitic resistance along the current path.
- Place capacitors, especially charge-pump capacitors, close to the device to make the current path as short as possible.

6.3.1 Layout Prints

To download the layer plots, see the design files at [TIDA-01374](#).

6.4 Altium Project

To download the Altium project files, see the design files at [TIDA-01374](#).

6.5 Gerber Files

To download the Gerber files, see the design files at [TIDA-01374](#).

6.6 Assembly Drawings

To download the assembly drawings, see the design files at [TIDA-01374](#).

7 Related Documentation

1. CISPR 25, Edition 3.0, 2008-03, *Vehicles, Boats and Internal Combustion Engines – Radio Disturbance Characteristics – Limits and Methods of Measurement for the Protection of On-Board Receivers*
2. ISO11452-4, Edition 4, 2011-12, *Road vehicles — Component test methods for electrical disturbances from narrowband radiated electromagnetic energy — Part 4: Harness excitation methods*
3. Texas Instruments, [TPS92830-Q1 3-Channel High-Current Linear LED Controller](#), data sheet

7.1 商標

All trademarks are the property of their respective owners.

TIの設計情報およびリソースに関する重要な注意事項

Texas Instruments Incorporated ("TI")の技術、アプリケーションその他設計に関する助言、サービスまたは情報は、TI製品を組み込んだアプリケーションを開発する設計者に役立つことを目的として提供するものです。これにはリファレンス設計や、評価モジュールに関係する資料が含まれますが、これらに限られません。以下、これらを総称して「TIリソース」と呼びます。いかなる方法であっても、TIリソースのいずれかをダウンロード、アクセス、または使用した場合、お客様(個人、または会社を代表している場合にはお客様の会社)は、これらのリソースをここに記載された目的にのみ使用し、この注意事項の条項に従うことに合意したものとします。

TIによるTIリソースの提供は、TI製品に対する該当の発行済み保証事項または免責事項を拡張またはいかなる形でも変更するものではなく、これらのTIリソースを提供することによって、TIにはいかなる追加義務も責任も発生しないものとします。TIは、自社のTIリソースに訂正、拡張、改良、およびその他の変更を加える権利を留保します。

お客様は、自らのアプリケーションの設計において、ご自身が独自に分析、評価、判断を行う責任がお客様にあり、お客様のアプリケーション(および、お客様のアプリケーションに使用されるすべてのTI製品)の安全性、および該当するすべての規制、法、その他適用される要件への遵守を保証するすべての責任をお客様のみが負うことを理解し、合意するものとします。お客様は、自身のアプリケーションに関して、(1) 故障による危険な結果を予測し、(2) 障害とその結果を監視し、および、(3) 損害を引き起こす障害の可能性を減らし、適切な対策を行う目的での、安全策を開発し実装するために必要な、すべての技術を保持していることを表明するものとします。お客様は、TI製品を含むアプリケーションを使用または配布する前に、それらのアプリケーション、およびアプリケーションに使用されているTI製品の機能性を完全にテストすることに合意するものとします。TIは、特定のTIリソース用に発行されたドキュメントで明示的に記載されているもの以外のテストを実行していません。

お客様は、個別のTIリソースにつき、当該TIリソースに記載されているTI製品を含むアプリケーションの開発に関連する目的でのみ、使用、コピー、変更することが許可されています。明示的または黙示的を問わず、禁反言の法理その他どのような理由でも、他のTIの知的所有権に対するその他のライセンスは付与されません。また、TIまたは他のいかなる第三者のテクノロジーまたは知的所有権についても、いかなるライセンスも付与されるものではありません。付与されないものには、TI製品またはサービスが使用される組み合わせ、機械、プロセスに関連する特許権、著作権、回路配置利用権、その他の知的所有権が含まれますが、これらに限られません。第三者の製品やサービスに関する、またはそれらを参照する情報は、そのような製品またはサービスを利用するライセンスを構成するものではなく、それらに対する保証または推奨を意味するものでもありません。TIリソースを使用するため、第三者の特許または他の知的所有権に基づく第三者からのライセンス、もしくは、TIの特許または他の知的所有権に基づくTIからのライセンスが必要な場合があります。

TIのリソースは、それに含まれるあらゆる欠陥も含めて、「現状のまま」提供されます。TIは、TIリソースまたはその仕様に関して、明示的か暗黙的にかかわらず、他のいかなる保証または表明も行いません。これには、正確性または完全性、権原、続発性の障害に関する保証、および商品性、特定目的への適合性、第三者の知的所有権の非侵害に対する黙示的保証が含まれますが、これらに限られません。

TIは、いかなる苦情に対しても、お客様への弁済または補償を行う義務はなく、行わないものとします。これには、任意の製品の組み合わせに関連する、またはそれらに基づく侵害の請求も含まれますが、これらに限られず、またその事実についてTIリソースまたは他の場所に記載されているか否かを問わないものとします。いかなる場合も、TIリソースまたはその使用に関連して、またはそれらにより発生した、実際の、直接的、特別、付随的、間接的、懲罰的、偶発的、または、結果的な損害について、そのような損害の可能性についてTIが知らされていたかどうかにかかわらず、TIは責任を負わないものとします。

お客様は、この注意事項の条件および条項に従わなかったために発生した、いかなる損害、コスト、損失、責任からも、TIおよびその代表者を完全に免責するものとします。

この注意事項はTIリソースに適用されます。特定の種類の資料、TI製品、およびサービスの使用および購入については、追加条項が適用されます。これには、半導体製品(<http://www.ti.com/sc/docs/stdterms.htm>)、評価モジュール、およびサンプル(<http://www.ti.com/sc/docs/sampterms.htm>)についてのTIの標準条項が含まれますが、これらに限られません。