

# TI Designs: TIDA-060008 RS-232からRS-485への信号変換のリファレンス・デザイン



## 概要

このリファレンス・デザインは、RS-232信号をRS-485信号に変換する回路です。RS-232がサポートする伝送距離が通常50フィート(約15m)未満であるのに対して、RS-485の伝送距離は1000フィート(約300m)を超えることができるため、このリファレンス・デザインを使うと長距離通信が可能です。このデザインは、RS-232トランシーバ、RS-485トランシーバ、マルチバイブレータ、内蔵電源付きデジタル・アイソレータを搭載し、ソフトウェア干渉がない双方向半二重通信を実装しています。

2芯ツイスト・ペア・ケーブルを使用して、最大800フィート(約240m)でテスト済みであり、シリアル・ポートを介して2台のPC間で最大115200Baudの通信を達成しています。また、産業規格IEC 61000-4-2および61000-4-4に準拠した絶縁耐圧5000Vrmsの保護機能を備えています。

## リソース

<a href="#">TIDA-060008</a>	デザイン・フォルダ
<a href="#">TRS3232E</a>	プロダクト・フォルダ
<a href="#">THVD1410</a>	プロダクト・フォルダ
<a href="#">ISOW7842</a>	プロダクト・フォルダ
<a href="#">SN74LVC1G123</a>	プロダクト・フォルダ

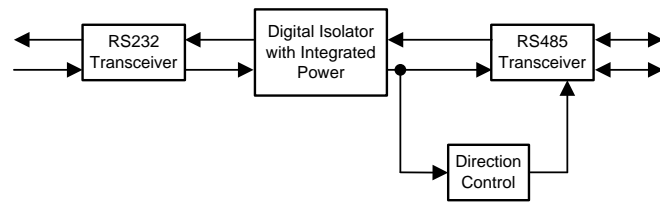
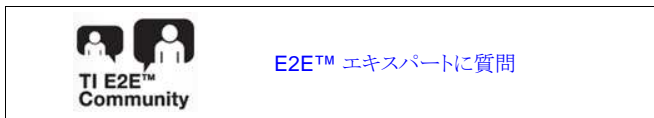

## 特長

- ホットプラグイン機能によりソフトウェア干渉なしにRS-232からRS-485に信号を変換して双方向半二重通信を実現
- 低電圧設計: 3.3V/5V電源で動作
- 産業水準のESD保護
  - RS-232ポート: IEC 61000-4-2 (±8kV接触、±15kV空気)
  - RS-485ポート: IEC 61000-4-2(±30kV接触、±30kV空気)、EFT IEC 61000-4-4 (50A)、サージ IEC 61000-4-5 (19A)
  - 絶縁耐圧: 5000Vrms
- ポイント・ツー・ポイントからマルチドロップにシステム方式を拡張
- ケーブル長: 最大1000フィート(約300m)

## アプリケーション

- POSシステム
- ファクトリ・オートメーション
- IPネットワーク・カメラ

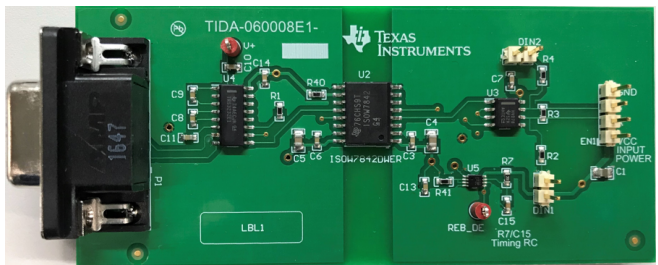

使用許可、知的財産、その他免責事項は、最終ページにあるIMPORTANT NOTICE (重要な注意事項)をご参照くださいますようお願いいたします。

## 1 System Description

RS-232 is a widely used interface. One example is the serial port (COM port) of a PC. One drawback is that it can only support short distance communication (up to 50 ft). Some industrial applications need to extend the distance with robust communication. Converting RS-232 to RS-485 is one of the options, since RS-485 is widely used in industrial applications for long distance transmission.

This TI design implements the conversion circuit via an RS-232 transceiver, an RS-485 transceiver, a digital isolator, and a multivibrator. The industrial-level ESD protection is also included. The simplified diagram is shown in [Figure 1](#).

The power of the system is provided from the RS-485 transceiver side. This supply is isolated by a digital isolator ISOW7842 and transferred to the RS-232 transceiver side. High speed RS-485 communication needs to be properly terminated and can take up to 50 mA current consumption depending on the bus loading conditions. The RS-232 transceiver TRS3232E is interfaced with the external device like a PC. The RS-232 signal is converted to the digital domain and then transferred to the other power domain by the digital isolator. In this isolated power domain, the received digital signal is converted to RS-485 signal by a RS-485 transceiver (THVD1410). In the meantime, the edge of the digital signal triggers the multivibrator SN74LVC1G123 to generate a pulse to enable the RS-485 transceiver's transmission. In the idle state, the receiver of the RS-485 transceiver is turned on and the driver is turned off. When a valid signal shows up, the RS-485 transceiver is set into transmitter mode. Therefore, a half-duplex communication is established.

## 2 System Overview

### 2.1 Block Diagram

図 1. TIDA-060008 Block Diagram

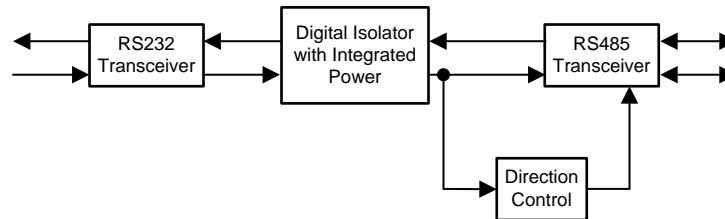

### 2.2 Design Considerations

The design goal is to support up to 256000 baud rate communication with either a 3.3-V or a 5-V supply. The isolation and industrial level ESD protection make the design robust under the noise and voltage surge of the harsh environment.

### 2.3 Highlighted Products

#### 2.3.1 THVD1410

The THVD1410 is used for RS-485 communication in this TI design. This device generates a compliant RS-485 standard output voltage with 3.3 V to 5 V supply and works for data transmission up to 500 kbps data rate. It has integrated ESD protection, such as  $\pm 18$  kV IEC 61000-4-2 Contact Discharge and  $\pm 4$  kV IEC 61000-4-4 Fast Transient Burst immunity.

See the [THVD14xx](#) product folder for a full description of this device.

#### 2.3.2 TRS3232E

The TRS3232E device consists of two RS-232 line drivers and two line receivers with  $\pm 15$ -kV IEC ESD protection. This device works with a 3.3V or a 5 V supply and up to 250 kbps data rate. It meets the requirements of TIA/EIA-232-F and provides the electrical interface between an asynchronous communication controller and the serial-port connector. In this TI design, one of each line driver and receiver is used for TxD and RxD signal. The other channel is left as “no connect” with the option of being used as RTS/CTS or DTR/DSR in other applications.

See the [TRS3232E](#) product folder for a full description of this device.

#### 2.3.3 ISOW7842

The ISOW7842 is a high-performance, quad-channel reinforced digital isolator with an integrated high-efficiency power converter. The integrated DC-DC converter works with 3.3 V and 5 V supplies and provides up to 650 mW of isolated power at high efficiency. Like the TRS3232E configuration, the unused channels have the option of future channel extension of the application.

See the [ISOW784x](#) product folder for a full description of this device.

### 3 Hardware, Software, Testing Requirements, and Test Results

#### 3.1 Required Hardware and Software

##### 3.1.1 Hardware

Two PCs with serial ports and one pair of this TI Design are needed for two-way half-duplex communication. A 10-foot unshielded twisted pair cable is used for the communication media.

##### 3.1.2 Software

The operating system for the PC is Microsoft Windows 9x, 2000, XP, Vista, or Win7. The RS-232 monitor software is used to supervise the communication. Other than monitoring the data exchange on a serial port, the software needs to be able to send and receive any data from a serial port to debug as well. The freeware used for testing is called AccessPort with version 1.37, which can be downloaded from this website <http://sudt.com/en/ap/index.html>. In the GUI of AccessPort (Figure 2), the top part is the terminal where you can monitor the actions on serial port, while the bottom part is where we can input data in hexadecimal or character format for transmitting data.

Figure 2. AccessPort GUI

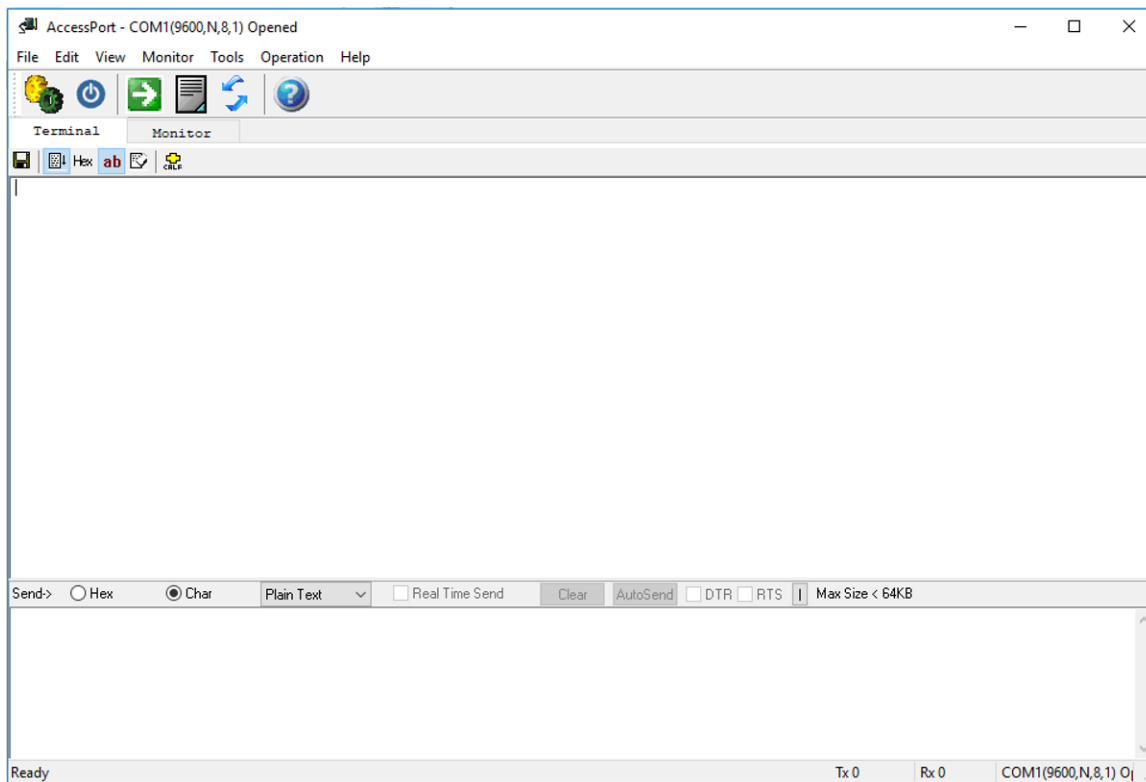

Another software tested was AGG serial port monitor (<http://www.aggsoft.com/serial-port-monitor/download.htm>). It also works for sending data and monitoring the serial port.



### 3.2 Testing and Results

#### 3.2.1 Test Setup

As shown in [Fig. 3](#), two pairs of this TI Design and two PCs were used to implement bi-directional half-duplex communication. The boards on the two sides are powered by a 5 V power supply separately. The software of one PC sends data by serial port. An RS-232 transceiver TRS3232E is interfaced with the PC to convert RS-232 signal to digital domain. The digital isolator transmits the digital signal into another power domain, where the digital data is converted to RS-485 signal by a RS-485 transceiver THVD1410. The edge of the digital signal triggers the multivibrator SN74LVC1G123 to enable the RS-485 transceiver's transmitter. The transmitted RS-485 signal goes through the cable and is converted back to RS-232 signal by another set of TI design TIDA-060008 hardware. The PC on the other end receives the signal and the software decodes the data. In the lab, two PCs are put side by side for test and debug ([Fig. 4](#)). This TI Design uses female DB9 connector for RS-232 interface, which can be directly attached to the PC serial port ([Fig. 5](#)).

**Fig. 3. The System Block Diagram**

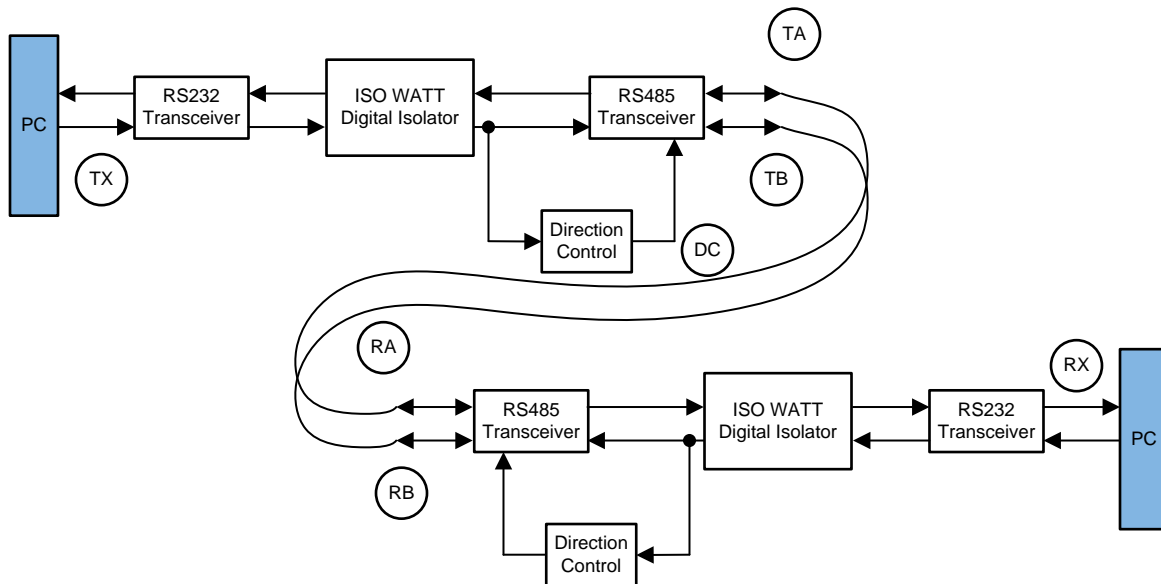

**図 4. The Two-way Half-duplex System Setup In Lab**

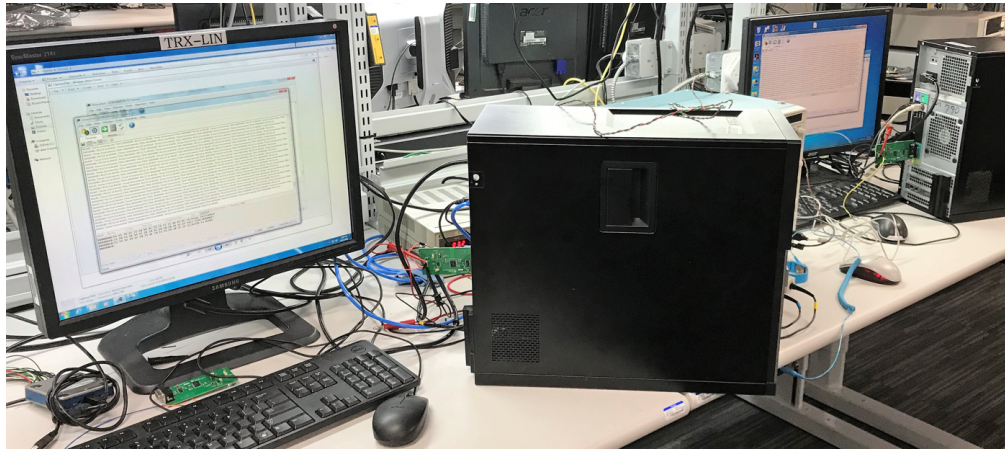

**図 5. This TI Design Plugs Into a Serial Port (Male DB9) On a PC**

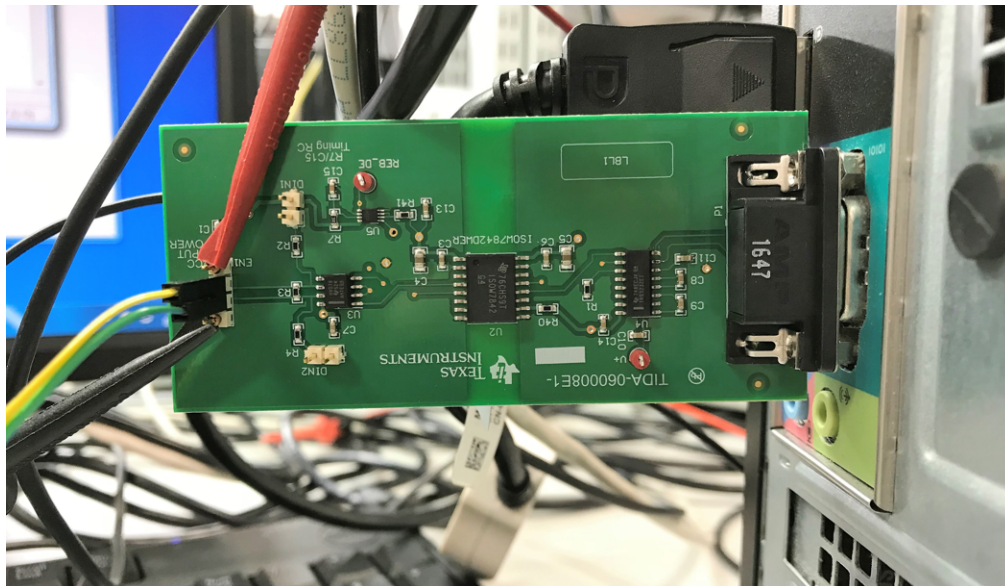

### 3.2.2 Test Results (Hardware)

The first test is to check the function of the circuit under room temperature. With a 5 V supply to both sides of the TI Designs, we check the supply voltage and the charge pump output voltage of the RS-232 transceivers of both boards to make sure the ICs work with normal supply conditions. The V+ voltage of the charge pump from both sides are above 5 V (図 6 and 図 7) showing the device supply is normal.



図 6. V+ Voltage of RS-232 Transceivers (TX Side)



図 7. V+ Voltage of RS-232 Transceivers (RX Side)

As 1 kHz clock RS-232 data generated by a signal generator is used as input signal (図 9), we check all the points in the signal chain for the signal quality. The converted RS-485 signal is shown at the A/B pins of the TX board. After 10 feet of unshielded twisted pair cable, the valid RS-485 signal is received at the RX board end (図 10). This RS-485 signal is converted to digital data and passes through the digital isolator. Then the RS-232 signal is generated by the RS-232 transceiver at the RX end (図 8).

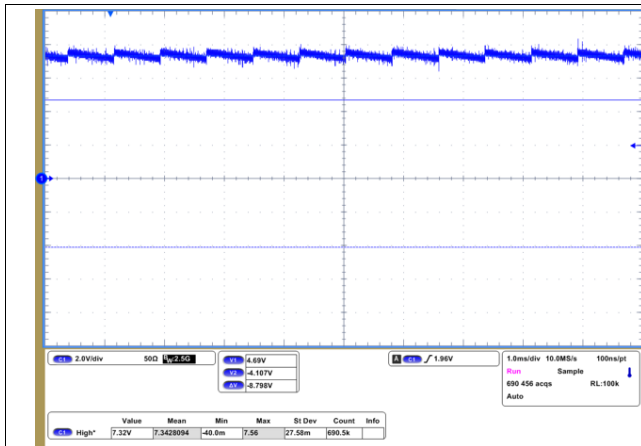

図 8. Input 1 kHz RS-232 clock data

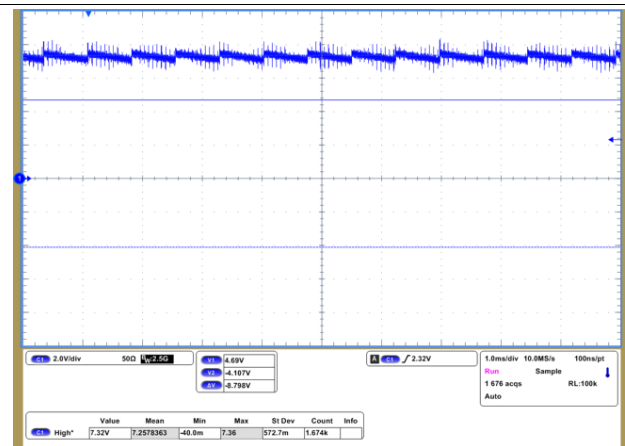

図 9. The Converted RS-485 Signal (TX Side)

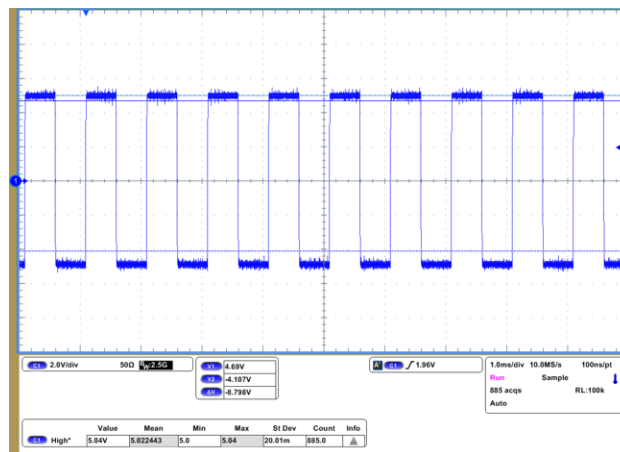

図 10. The Converted RS-485 Signal (RX Side)

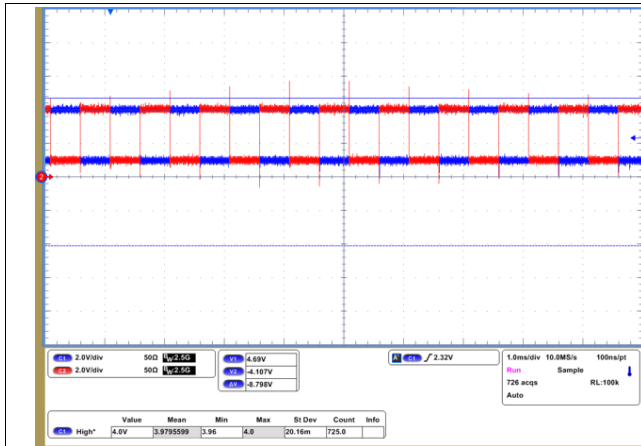

図 11. Received RS-485 Signal

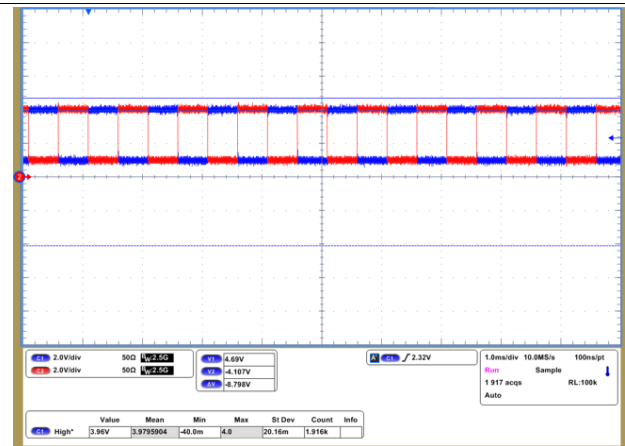

図 12. Received RS-232 Signal

With the same setup and to test the long distance communication capability, a character string generated by the PC is transmitted over an 800-foot CAT5 cable. The signal integrity over the whole system is checked as well. The waveforms in 図 13 show the RS-485 signal with 9600 baud rate before and after the cable. With 115200 baud rate, the received RS-485 signal suffers a little more distortion in amplitude and jitter (図 15). In real application, the maximum transmission distance is impacted by the media and loading of the system.

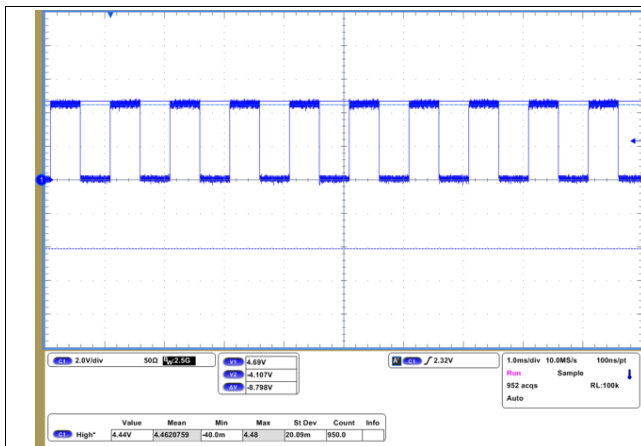

図 13. 9600 Baud Rate RS-485 Signal Before 800 feet Cable Transmission

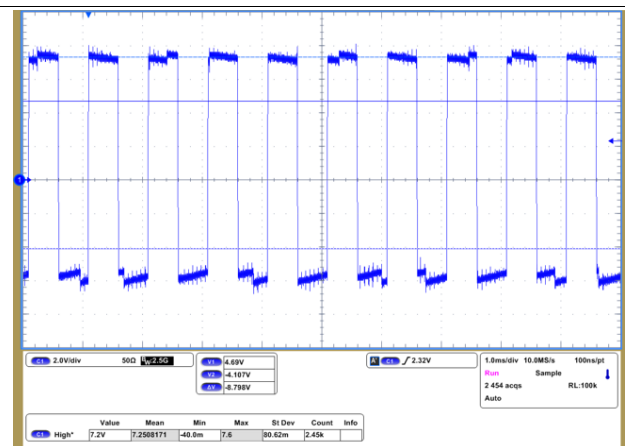

図 14. 9600 Baud Rate RS-485 Signal After 800 feet Cable Transmission



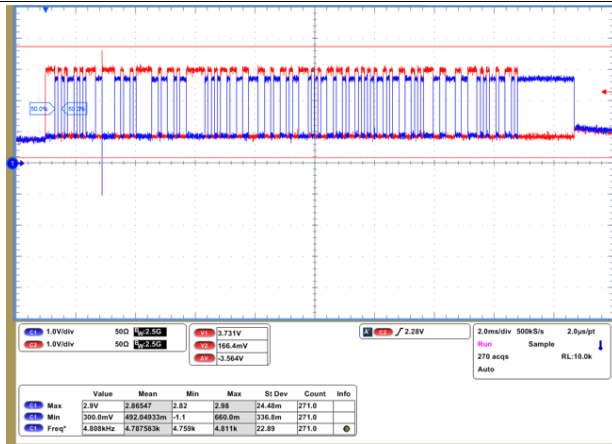

図 15. Received 115200 Baud Rate RS-485 Signal after 800 feet Cable Transmission

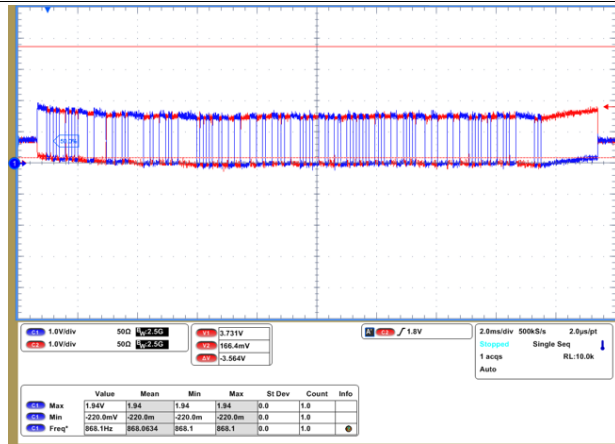
### 3.2.3 Test Results (Software)

After the functionality tests, the software AccessPort was used to build real time communication between two PCs via the serial ports.

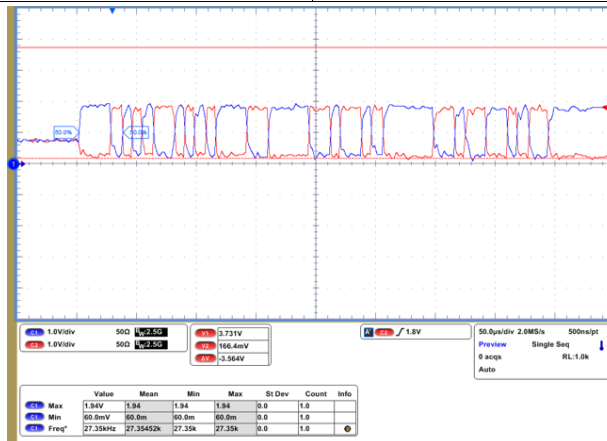
#### 3.2.3.1 9600 Baud Rate

First the communication configuration was set up as  16 on the PC of TX end. To make the setup simple, the data format was chosen to be a 7-bit UART data without parity bit. To make capturing the waveforms on the oscilloscope easier, the data were sent repeatedly every 100 ms.

 16. 9600 Baud Rate Communication Configuration in AccessPort

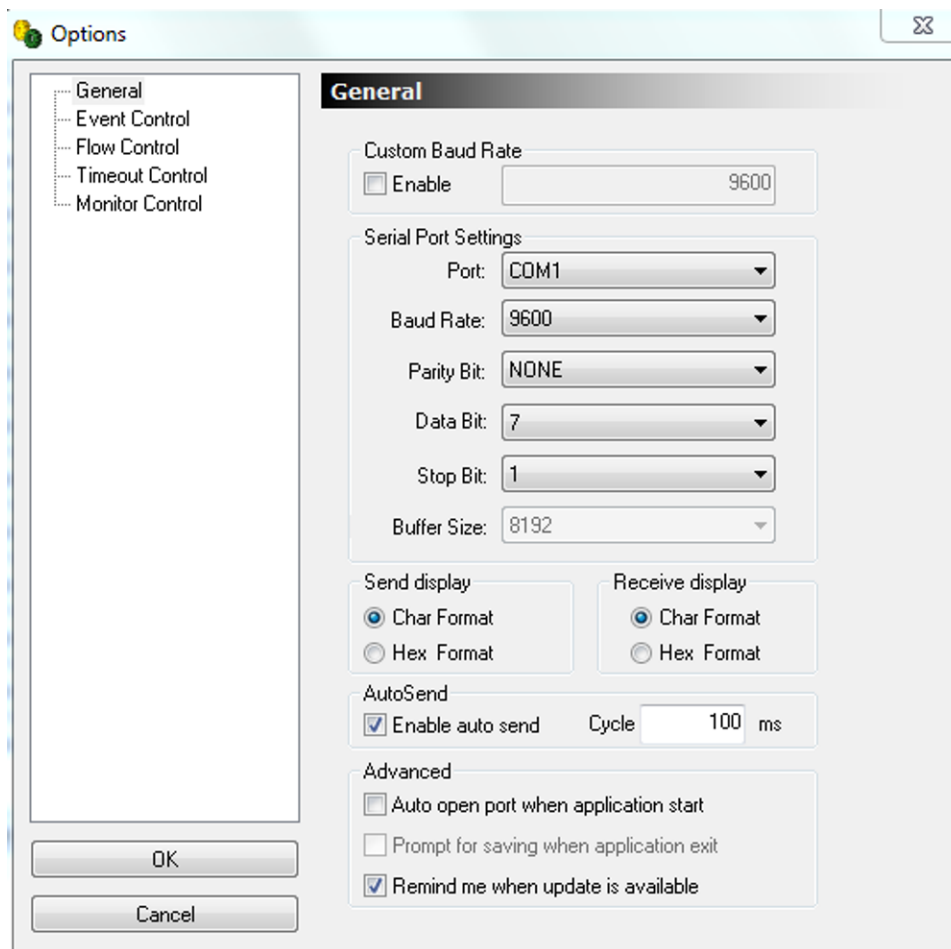

We do the same setting on the software of the receiver-end PC as well. A string of data is sent out by the software with the characters of “Texas Instruments TIDA-060008E1 RS232 to RS485”. The characters are transferred to binary ASCII code and sent to the serial port. On the receiver side, as the RS-232 signal is received on the serial port, the software detects the characters and shows them on the terminal. By comparison, the communication is successful and the same characters are shown repeatedly on the terminal ( 18).



**17. Transmitted (Upper) and Characters on Two PCs**

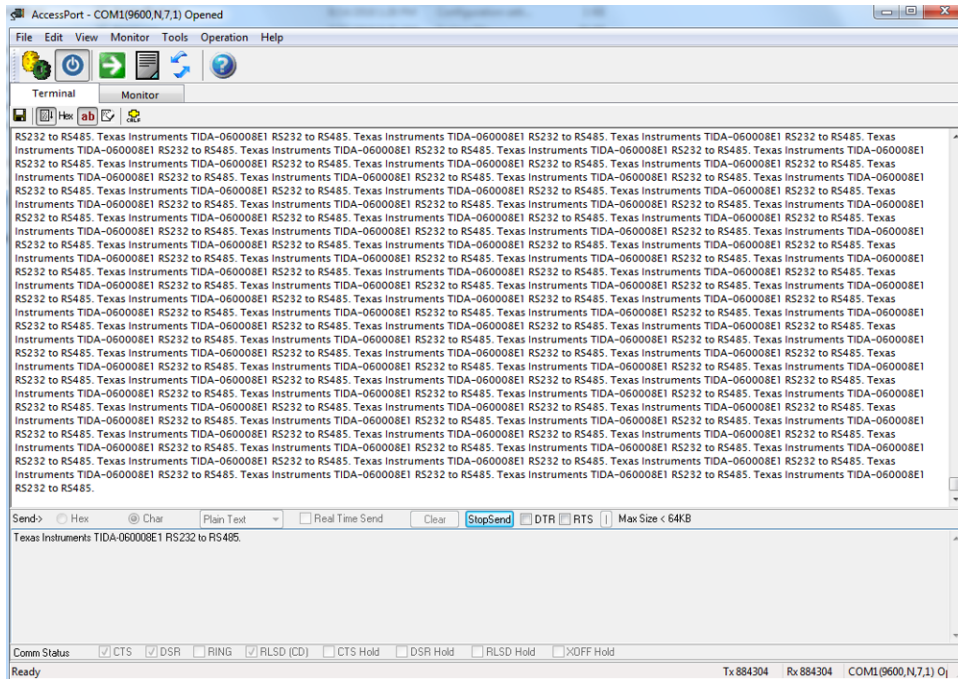

**18. Received (Lower) Characters on Two PCs**

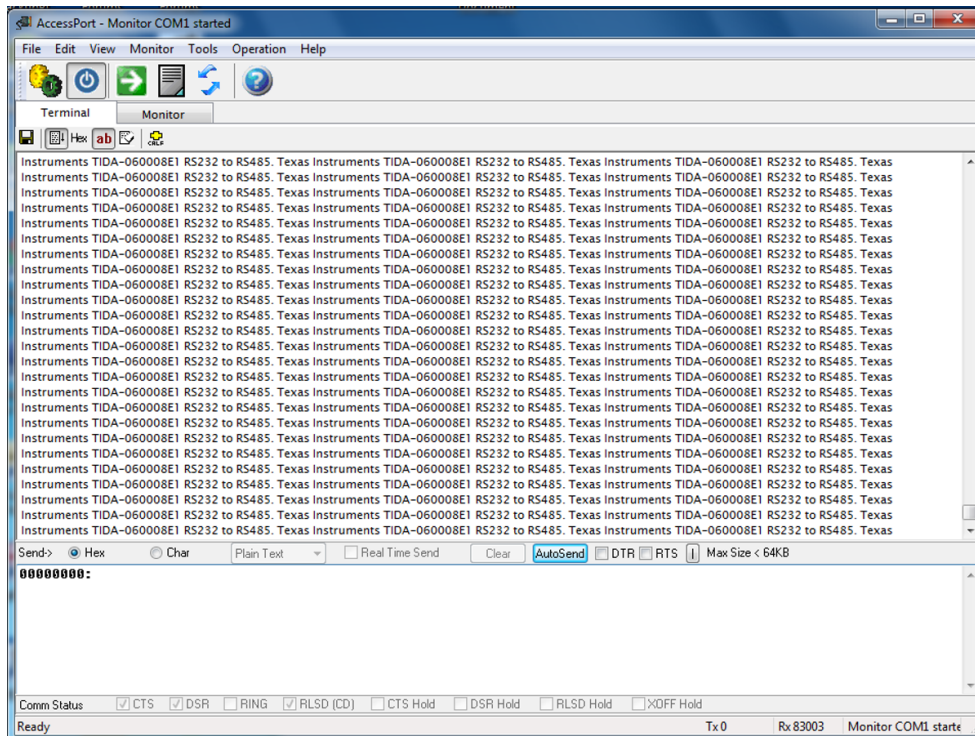

**3.2.3.2 115200 Baud Rate**

To test the limit, chose the maximum data rate the software can support – 115200 baud rate with an 800-foot CAT5 cable. The communication was also successful.

## 4 Design Files

### 4.1 Schematics

To download the schematics, see the design files at [TIDA-060008](#).

#### 19. TIDA-060008 Schematic

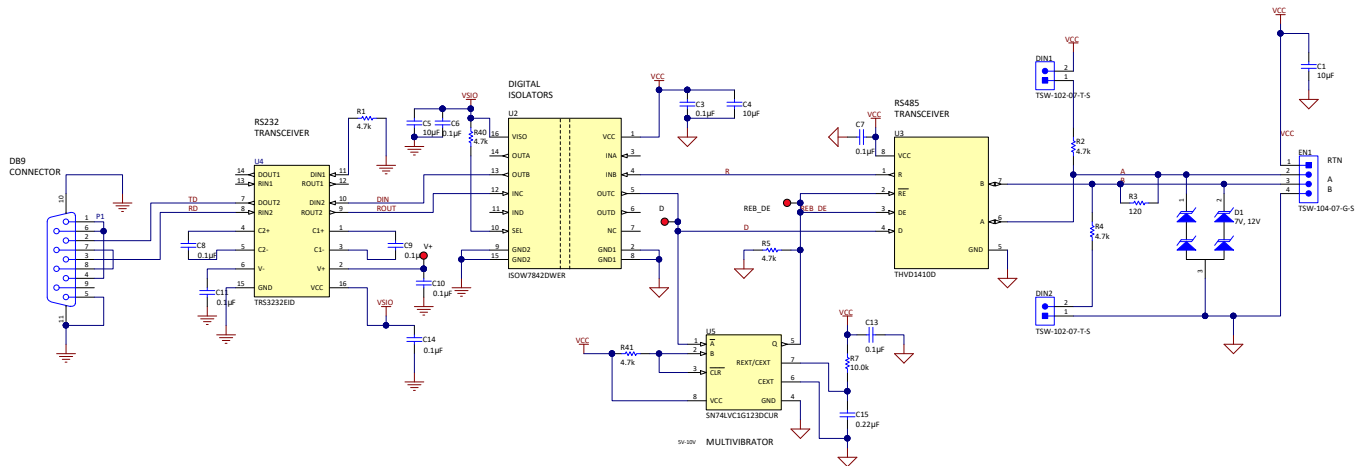

### 4.2 Bill of Materials

To download the bill of materials (BOM), see the design files at [TIDA-060008](#).

### 4.3 PCB Layout Recommendations

Place the flying capacitors and storage capacitors for the RS-232 charge pump close to the transceiver. Place decoupling capacitors close to the power pins of each device to help filter out noise.

- Use VCC and ground planes to provide low inductance.

注: High-frequency currents follow the path of least impedance and not the path of least resistance

- Ensure that enough copper is present on both GND pins of ISOW7842 to prevent the internal junction temperature of the device from rising to unacceptable levels.
- Use at least two vias for VCC and ground connections of bypass capacitors and protection devices to minimize effective via inductance.

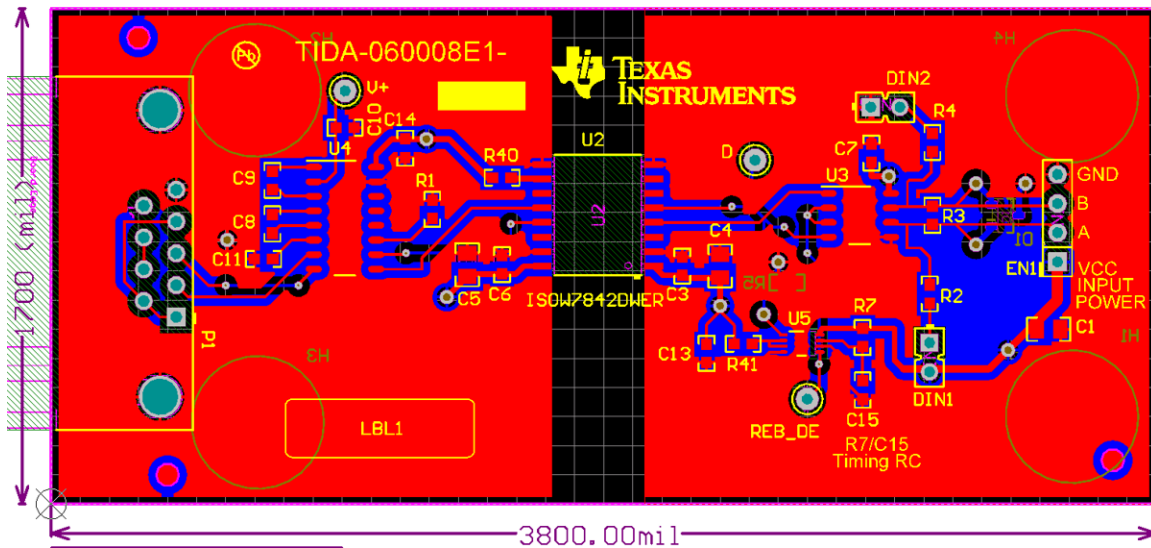

**図 20. TIDA-060008 Layout**

#### 4.3.1 Layout Prints

To download the layer plots, see the design files at [TIDA-060008](#).

#### 4.4 Altium Project

To download the Altium Designer® project files, see the design files at [TIDA-060008](#).

#### 4.5 Gerber Files

To download the Gerber files, see the design files at [TIDA-060008](#).

#### 4.6 Assembly Drawings

To download the assembly drawings, see the design files at [TIDA-060008](#).

### 5 Software Files

To download the software files, see the design files at [TIDA-060008](#).

### 6 Related Documentation

1. [RS-422 and RS-485 Standards Overview and System Configurations](#)
2. [The RS-485 Design Guide](#)
3. [Texas Instruments, How the RS-232 transceiver's regulated charge-pump circuitry works, blog](#)
4. [Self-Powered Isolated RS-232 to UART Interface Design Guide](#)
5. [Digitally Isolated, RS-232 Interface Module With Handshake Signals Design Guide](#)

#### 6.1 商標

E2E is a trademark of Texas Instruments.

Altium Designer is a registered trademark of Altium LLC or its affiliated companies.

すべての商標および登録商標はそれぞれの所有者に帰属します。

## 重要なお知らせと免責事項

TI は、技術データと信頼性データ(データシートを含みます)、設計リソース(リファレンス・デザインを含みます)、アプリケーションや設計に関する各種アドバイス、Web ツール、安全性情報、その他のリソースを、欠陥が存在する可能性のある「現状のまま」提供しており、商品性および特定目的に対する適合性の黙示保証、第三者の知的財産権の非侵害保証を含むいかなる保証も、明示的または黙示的にかかわらず拒否します。

これらのリソースは、TI 製品を使用する設計の経験を積んだ開発者への提供を意図したものです。(1) お客様のアプリケーションに適した TI 製品の選定、(2) お客様のアプリケーションの設計、検証、試験、(3) お客様のアプリケーションが適用される各種規格や、その他のあらゆる安全性、セキュリティ、またはその他の要件を満たしていることを確実にする責任を、お客様のみが単独で負うものとします。上記の各種リソースは、予告なく変更される可能性があります。これらのリソースは、リソースで説明されている TI 製品を使用するアプリケーションの開発の目的でのみ、TI はその使用をお客様に許諾します。これらのリソースに関して、他の目的で複製することや掲載することは禁止されています。TI や第三者の知的財産権のライセンスが付与されている訳ではありません。お客様は、これらのリソースを自身で使用した結果発生するあらゆる申し立て、損害、費用、損失、責任について、TI およびその代理人を完全に補償するものとし、TI は一切の責任を拒否します。

TI の製品は、TI の販売条件 ([www.tij.co.jp/ja-jp/legal/termsofsale.html](http://www.tij.co.jp/ja-jp/legal/termsofsale.html))、または [ti.com](http://ti.com) やかかる TI 製品の関連資料などのいずれかを通じて提供する適用可能な条項の下で提供されています。TI がこれらのリソースを提供することは、適用される TI の保証または他の保証の放棄の拡大や変更を意味するものではありません。

Copyright © 2018, Texas Instruments Incorporated  
日本語版 日本テキサス・インスツルメンツ株式会社

## 重要なお知らせと免責事項

TI は、技術データと信頼性データ(データシートを含みます)、設計リソース(リファレンス・デザインを含みます)、アプリケーションや設計に関する各種アドバイス、Web ツール、安全性情報、その他のリソースを、欠陥が存在する可能性のある「現状のまま」提供しており、商品性および特定目的に対する適合性の黙示保証、第三者の知的財産権の非侵害保証を含むいかなる保証も、明示的または黙示的にかかわらず拒否します。

これらのリソースは、TI 製品を使用する設計の経験を積んだ開発者への提供を意図したものです。(1) お客様のアプリケーションに適した TI 製品の選定、(2) お客様のアプリケーションの設計、検証、試験、(3) お客様のアプリケーションが適用される各種規格や、その他のあらゆる安全性、セキュリティ、またはその他の要件を満たしていることを確実にする責任を、お客様のみが単独で負うものとします。上記の各種リソースは、予告なく変更される可能性があります。これらのリソースは、リソースで説明されている TI 製品を使用するアプリケーションの開発の目的でのみ、TI はその使用をお客様に許諾します。これらのリソースに関して、他の目的で複製することや掲載することは禁止されています。TI や第三者の知的財産権のライセンスが付与されている訳ではありません。お客様は、これらのリソースを自身で使用した結果発生するあらゆる申し立て、損害、費用、損失、責任について、TI およびその代理人を完全に補償するものとし、TI は一切の責任を拒否します。

TI の製品は、TI の販売条件 ([www.tij.co.jp/ja-jp/legal/termsofsale.html](http://www.tij.co.jp/ja-jp/legal/termsofsale.html))、または [ti.com](http://ti.com) やかかる TI 製品の関連資料などのいずれかを通じて提供する適用可能な条項の下で提供されています。TI がこれらのリソースを提供することは、適用される TI の保証または他の保証の放棄の拡大や変更を意味するものではありません。

Copyright © 2018, Texas Instruments Incorporated  
日本語版 日本テキサス・インスツルメンツ株式会社