

TI Designs: TIDEP-0104

77GHzミリ波センサを使用した障害物検出のリファレンス・デザイン



概要

TIDEP-0104リファレンス・デザインでは、TIのDSPを内蔵したシングルチップのミリ波(mmWave)センサAWR1642の使い方を紹介します。本デバイスは、自動車のドアおよびトランク周りのさまざまな障害物を3D空間で高精度検出できる障害物検出センサ(ODS)です。C674x DSPで動作するリファレンス・ソフトウェア処理チェーンにより、水平 ± 70 度、垂直 ± 40 度の視野角(FOV)で水平面と垂直面の複数の物体を検出できます。物体検出を視覚化するGUIも備えています。

リソース

TIDEP-0104	デザイン・フォルダ
AWR1642	プロダクト・フォルダ
AWR1642BOOST-ODS	ツール・フォルダ
mmWave SDK	ツール・フォルダ



[E2E™エキスパートに質問](#)

特長

- 障害物検出用途(スマート・ドア・オープン機能、スマート・トランク・オープン機能、駐車支援)のシングルチップの周波数変調連続波(FMCW)レーダー(RADAR:電波探知測距)
- 車体およびシャーシの近くの各種の物体(トラフィック・コーン、網、金属/樹脂製ポール、木材、ワイヤなど)を検出
- 単一パッチ・アンテナにより水平 ± 70 度、垂直 ± 40 度のFOVを実現
- ミリ波ソフトウェア開発キット(SDK)に基づくリファレンス処理チェーンのソースコードを提供

アプリケーション

- 自動車のドアトランク周りの障害物検出
- 駐車支援
- 近接センシング

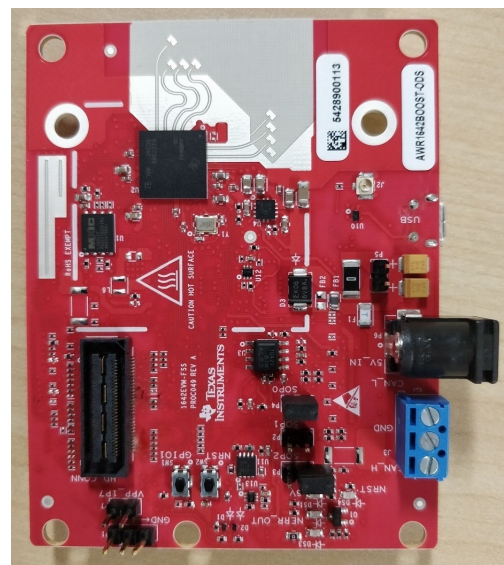
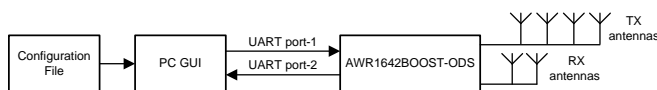

使用許可、知的財産、その他免責事項は、最終ページにあるIMPORTANT NOTICE (重要な注意事項)をご参照くださいますようお願いいたします。

1 System Description

The mmWave sensor is widely used in advanced driver-assistance systems (ADAS) applications such as blind-spot detection (BSD), lane-change assistance (LCA), and automatic-cruise control (ACC), which are mostly safety applications. The mmWave sensor is now being considered to be implemented in the doors and trunks of cars, to detect obstacles around them and avoid collision with these objects, which can cause damage. The 77-GHz AWR1642 mmWave sensor from TI is considered for this application, because of its single-chip solution to the door and small form factor. The programmable DSP core enables advanced signal-processing techniques for enhanced detections.

Other sensing technologies were considered in the past, but none of them could sense objects in 3D space with a wide FOV like an mmwave sensor. It can also sense objects in environmentally challenging conditions such as rain, night, glare, and so on. Because of the small form factor of mmwave sensors, they can be placed behind the cladding or plastic door handle or in the side mirrors. This feature also makes the sensors aesthetically pleasing. The mmWave sensors from TI are multimode, they can function as a side radar when the car is in motion and a door-opener sensor when the car is at rest. In this sense, the mmWave sensors are truly smart.

The design provided is an introductory application that is configured for near-range, 3-D obstacle detection, for a range up to 20 m (to detect objects as well as estimate their velocities and positions). The device can be used as a starting point to design a stand-alone sensor for a variety of obstacle detection and proximity sensing uses in both automotive and industrial applications.

1.1 Key System Specifications

表 1. Key System Specifications

PARAMETER	SPECIFICATIONS	DETAILS
Maximum range	20 m	This value represents the maximum distance that the radar can detect an object, representing an RCS of approximately 10 m ² .
Range resolution	4 cm	The ability of a radar system to distinguish between two or more targets on the same bearing, but at different ranges. This value is a theoretical value, the actual value depends on implementation.

2 System Overview

The ODS reference design from TI is built around the AWR1642BOOST-ODS evaluation board and the mmWave SDK demo application. The system is optimized and built for ODS applications to detect objects within a 20-m range.

2.1 Block Diagram

2.1.1 Obstacle Detection Application Software Block Diagram

As described in [Figure 1](#), the implementation of the obstacle detection application example in the signal-processing chain consists of the following blocks implemented as DSP code executing on the C674x core in the AWR1642.

- Range processing:
 - For each antenna, 1D windowing, and 1D fast Fourier Transform (FFT)
 - Range processing is interleaved with the active chirp time of the frame
- Range-angle heat-map generation:
 - Generate angle spectrum for each range bin using covariance beamforming or Capon beamforming.
 - Outputs Range-Elevation angle heat-map and Range-Azimuth angle heat-map.
- Object Detection
 - On each range-angle heat-map, search a single peak cross angle for each range bin, then apply one dimension CFAR check on the peak angle cross the neighboring range bins.
 - Take the union (or interception) of the two peak sets detected from the two range-angle heat-maps.
- Doppler estimation:
 - For each detected range bin, estimate the Doppler output and apply non-coherent combination among all antennas. Find the peak index and used it as the Doppler index of the detected target.
 - Outputs the Range-Doppler output of this Doppler peak index and used later for angle estimation.
- Angle of arrival estimation
 - Calculate the two-dimensional angle spectrum using 2D FFT.
 - Single peak search on this two-dimensional angle spectrum and calculate azimuth and elevation angle associated with the peak location.
- Clustering:
 - Perform DBSCAN-based clustering algorithm every fixed number of frames and report the results.
 - Output the number of clustering and properties like clustering center and size.



図 1. Block Diagram

2.2 Highlighted Products

2.2.1 AWR1642 Single-Chip Radar Solution

The AWR1642 is an integrated, single-chip, FMCW sensor capable of operation in the 76 to 81 GHz band (see 図 2). The sensor is built with the low-power, 45-nm, RFCMOS process from TI and enables unprecedented levels of integration in an extremely small form factor. The AWR1642 is an ideal solution for low-power, self-monitored, ultra-accurate radar systems in the automotive and industrial space.

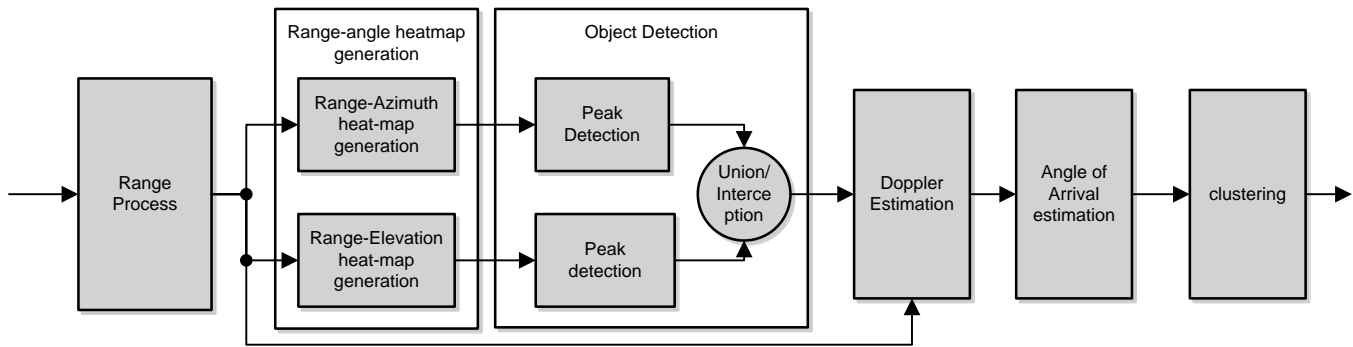
AWR1642 features:

- AWR1642 radar device
- Power management circuit, to provide all the required supply rails from a single 5-V input
- Two onboard, TX antennas and four RX antennas
- Onboard XDS110 provides:
 - JTAG interface
 - UART1 for loading the radar configuration on the AWR1642 device
 - UART2 for sending the object data back to the PC



図 2. AWR1642 EVM Block Diagram

For more details on the hardware, see the [AWR1642 Evaluation Module \(AWR1642BOOST-ODS\) Single-Chip mmWave Sensing Solution](#).

The schematics and design database are in the following documents:

- AWR1642 Evaluation Board Design Database
- AWR1642BOOST-ODS Schematic, Assembly, and BOM

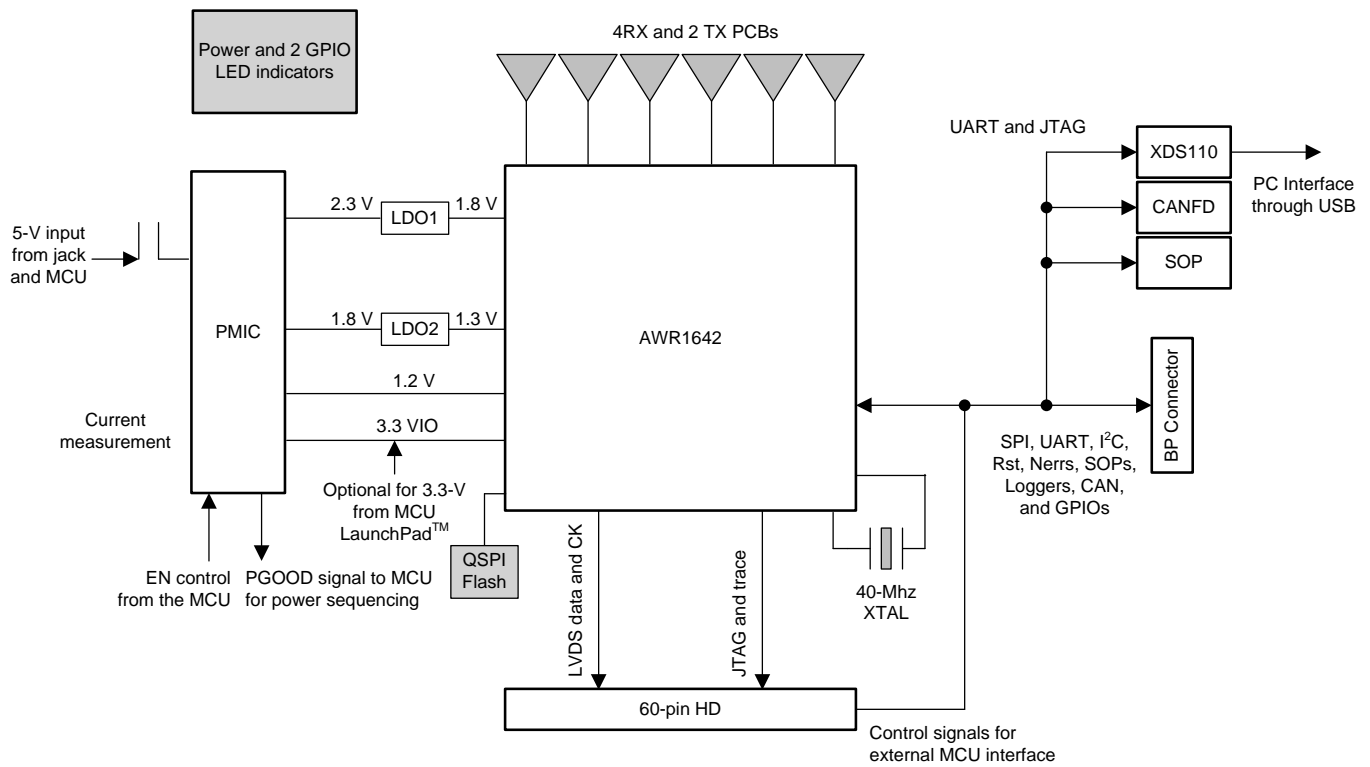
2.3 Design Considerations

2.3.1 System Design Theory

2.3.1.1 Usage Case Geometry and Sensor Considerations

The AWR1642 is a radar-based sensor that integrates a fast FMCW radar front end with both an integrated ARM R4F MCU and TI C674x DSP for advanced signal processing. The configuration of the AWR1642 radar front end depends on the configuration of the transmit signal and the configuration and performance of the RF transceiver, the design of the antenna array, and the available memory and processing power. This configuration influences key performance parameters of the system.

The key performance parameters at issue are listed with brief descriptions.

- Range
 - Range is estimated from a beat frequency in the de-chirped signal that is proportional to the round trip delay to the target. For a given chirp ramp slope, the maximum theoretical range is determined by the maximum beat frequency that can be detected in the RF transceiver. The maximum practical range is then determined by the SNR of the received signal and the SNR threshold of the detector.
- Range resolution
 - This is defined as the minimum range difference over which the detector can distinguish two individual point targets, which is determined by the bandwidth of the chirp frequency sweep. The higher the chirp bandwidth, the finer the range resolution.
- Range Accuracy
 - This is often defined as a rule of thumb formula for the variance of the range estimation of a single point target as a function of the SNR.
- Maximum velocity
 - Radial velocity is directly measured in the low-level processing chain as a phase shift of the dechirped signal across chirps within one frame. The maximum unambiguous velocity observable is then determined by the chirp repetition time within one frame. Typically this velocity is adjusted to be one-half to one-fourth of the desired velocity range to have better tradeoffs relative to the other parameters. Other processing techniques are then used to remove ambiguity in the velocity measurements, which will experience aliasing.
- Velocity resolution
 - This is defined as the minimum velocity difference over which the detector can distinguish two individual point targets that also happen to be at the same range. This is determined by the total chirping time within one frame. The longer the chirping time, the finer the velocity resolution.
- Velocity accuracy
 - This is often defined as a rule of thumb formula for the variance of the velocity estimation of a single-point target as a function of the SNR.
- Field of view
 - This is the sweep of angles over which the radar transceiver can effectively detect targets. This is a

function of the combined antenna gain of the transmit and receive antenna arrays as a function of angle and can also be affected by the type of transmit or receive processing, which may affect the effective antenna gain as a function of angle. The field of view is typically specified separately for the azimuth and elevation.

- Angular resolution
 - This is defined as the minimum angular difference over which the detector can distinguish two individual point targets that also happened to have the same range and velocity. This is determined by the number and geometry of the antennas in the transmit and receive antenna arrays. This is typically specified separately for the azimuth and elevation.
- Angular accuracy
 - This is often defined as a rule of thumb formula for the variance of the angle estimation of a single point target as a function of SNR.

2.3.1.2 Antenna Configuration

The TIDEP-0104 uses four receivers and two transmit antennas, as shown in [4]. When the system operates in time-division multiplexed (TDM) MIMO mode, a nonuniform, synthesized array of eight antennas is achieved, as shown in [4]. The TDM mode of operation is achieved by transmitting chirps using TX1 and TX2 in an alternate fashion. This antenna fashion has been designed for directional of arrival (DOA) detection in both azimuth and elevation.



図 3. ODS EVM-Antenna Configuration

2.3.1.3 Processing Chain

An example processing chain for obstacle detection is implemented on the AWR1642 EVM. The main processing elements involved in the processing chain consist of the following:

- Front end – Represents the antennas and the analog RF transceiver implementing the FMCW transmitter and receiver with the various hardware-based signal conditioning operations.
- ADC – The ADC is the main element that interfaces to the DSP chain. The ADC output samples are buffered in ADC output buffers for access by the digital part of the processing chain.
- EDMA controller – A user-programmed DMA engine employed to move data from one memory location to another without using another processor. The EDMA can be programmed to trigger automatically, and

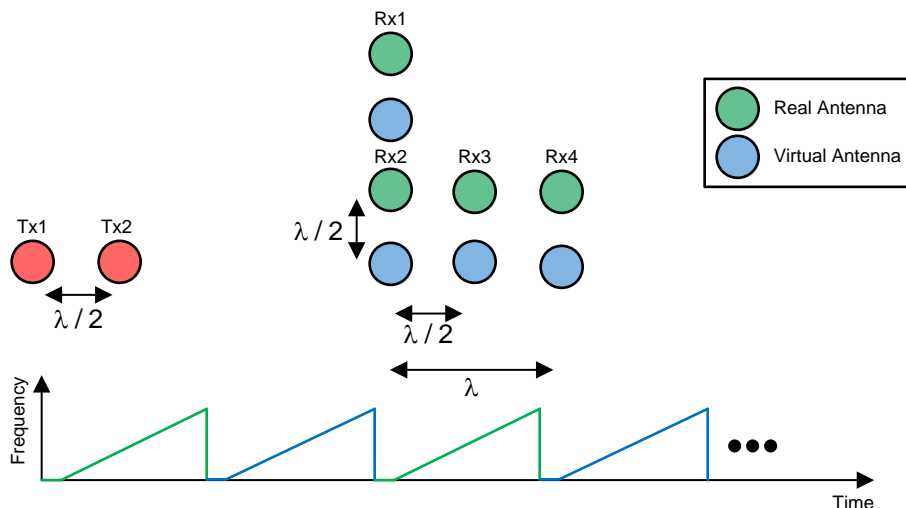
can be configured to reorder some of the data during the movement operations.

- C674 DSP – This is the digital signal processing core that implements the configuration of the front end and executes the main signal processing operations on the data. This core has access to several memory resources as noted further in the design description.
- ARM R4F – This ARM MCU can execute application code, including further signal processing operations and other higher level functions. In this application, the ARM Cortex R4F primarily relays target list data over the UART interface. There is a shared memory visible to both the DSP and the R4F.

The processing chain is implemented on the DSP and Cortex R4F together. There are several physical memory resources used in the processing chain, as described in 表 2.

表 2. Physical Memory Resources

Section Name	Size (KB) as Configured	Memory Used (KB)	Description
L1D SRAM	16	16	Layer one data static RAM is the fastest data access for DSP, and used for most time-critical DSP processing data that can fit in this section.
L1D Cache	16	16	Layer one data cache caches data accesses to any other section configured as cacheable. The LL2, L3, and HSRAM are configured as cacheable.
L1P SRAM	28	24	Layer one program static RAM is the fastest program access RAM for DSP, and used for most time-critical DSP program that can fit in this section.
L1P Cache	4	4	Layer one cache caches program accesses to any other section configured as cacheable. The LL2, L3, and HSRAM are configured as cacheable.
L2	256	176	Local layer two memory is lower latency than layer three for accessing and is visible only from the DSP. This memory is used for most of the program and data for the signal processing chain.
L3	640	600	Higher latency memory for DSP accesses primarily stores the radar cube and the range-Doppler power map. It is a less time-sensitive program. Data can also be stored here.
HSRAM	32		Shared memory buffer between the DSP and the R4F relays visualization data to the R4F for output over the UART in this design.

As described in 図 4, the implementation of the obstacle-detection example in the signal-processing chain consists of the following blocks implemented as DSP code executing on the C674x core in the AWR1642:



図 4. System Process Chain

- Range processing – For each antenna, EDMA is used to move samples from the ADC output buffer to DSP's local memory. A 16-bit, fixed-point 1D windowing and 16-bit, fixed-point 1D FFT are performed. EDMA is used to move output from DSP local memory to radar cube storage in layer three (L3) memory. Range processing is interleaved with active chirp time of the frame. All other processing happens each frame, except where noted, during the idle time between the active chirp time and the end of the frame.
- Range-angle heat-map calculation – Two heat maps are computed: Range-Elevation-Angle and Range-Azimuth-Angle Heatmaps. A linear antenna array is formed at the azimuth plane to compute the azimuth angle spectrum for each range bin, and another linear antenna array is formed at elevation plane to compute the elevation angle spectrum. For example, in the ODS EVM board TDD MIMO configuration, the visual antenna array is shown in 図 5. The Range-Elevation-Angle heat-map is computed using the 4-RX virtual horizontal antennae circled in 図 5. The Range-Azimuth-Angle heat-map is computed using the 3-RX virtual horizontal antennae circled in 図 6. A 3-RX signal can be formed as linear antenna array in elevation plane to compute range-elevation spectrum.



図 5. Virtual Antenna Array for Range-Elevation-Angle Heat-Map Calculation

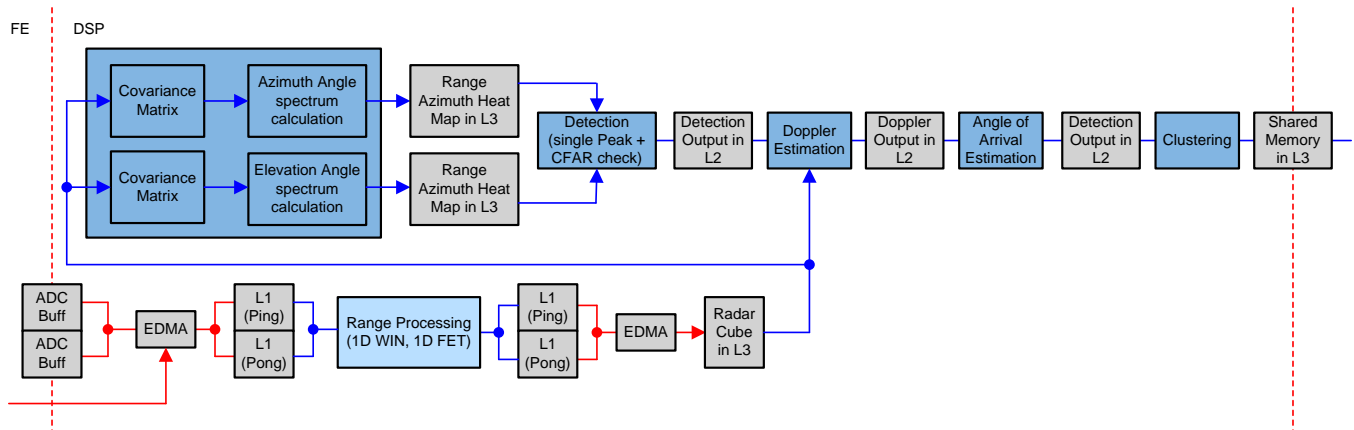

図 6. Virtual Antenna Array for Range-Azimuth-Angle Heat-Map Calculation

The angle spectrum is computed using the covariance BF approach, as shown in 式 1.

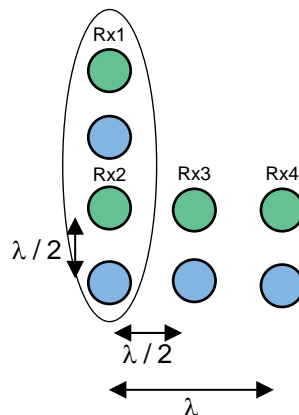
$$Spectrum(\theta) = abs[A(\theta) * R_n * A(\theta)^H] \tag{1}$$

- Object Detection – The detection is done in the range-angle domain. Due to the limited angle resolution in our antenna pattern, object detection is limited to single target per range bin. In each range bin, a single peak is found which indicates the best angle in this range bin. Then, a CFAR window is formed to check whether this [range, angle] pair stand out compare to its range neighbors. From range-azimuth heat-map and range elevation heat-map, two sets of peaks are found. Then configuration can choose to take the union or the interception of the two peak sets to form the final detection sets. The output is stored in the L2 memory
- Doppler estimation – For each detected point in range-angle space, Doppler is estimated using Doppler FFT. The output is stored in the L2 memory.
- Angle of arrival estimation – For each detected point, Doppler output for all the antenna is used to calculate the two-dimensional angle spectrum. Then the azimuth angle and elevation angle are then calculated from the single peak in the 2D angle spectrum. The output is stored in the L2 memory.

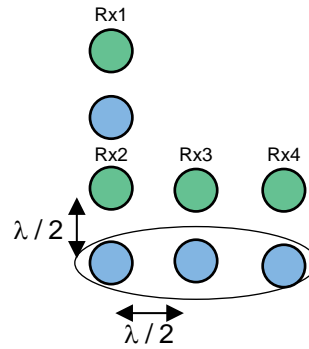

図 7. Angle Spectrum

2.3.2 Configuration Profile

The example in the mmWave SDK distribution that represents this design lets users push the Radar configuration, using a Profile Configuration file (see), over UART to the device.

The mmWave SDK user's guide (included in the mmWave SDK distribution) describes the semantics of the following commands in detail. The following sequence of commands represents the configuration choices described in previous sections representing the functionality of the ODS. The cfarCfg and dbscanCfg commands are described in more detail in the User's Guide included with the software release.

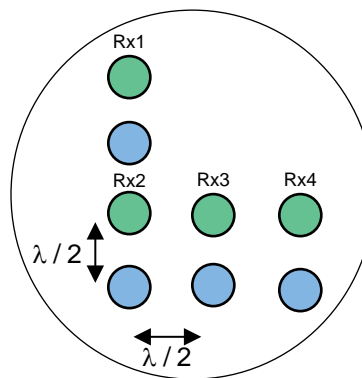
```

sensorStop
flushCfg
dfeDataOutputMode 1
channelCfg 15 3 0
adcCfg 2 1
adcbufCfg -1 0 0 1 1
profileCfg 0 77 7 7 58.0 0 0 67.978 1 256 5020 0 0 36
chirpCfg 0 0 0 0 0 0 0 1
chirpCfg 1 1 0 0 0 0 0 2
frameCfg 0 1 32 0 100 1 0
lowPower 0 1
guiMonitor 1 1 1 0
cfarCfg 1 4 12 4 2 8 2 350 30 2 0 5 20
dbscanCfg 4 4 13 20 3 256
sensorStart

```

図 8. ODS Profile Configuration

3 Hardware, Software, Testing Requirements, and Test Results

3.1 Required Hardware and Software

The AWR1642BOOST-ODS from TI is an easy-to-use evaluation board for AWR1642 mmWave-sensing devices. The ODS radar application runs on the AWR1642 EVM and connects to a visualization tool, which runs on a PC connected to the EVM over a USB.

For details regarding use of this board, see the AWR1642 Evaluation Module (AWR1642BOOST-ODS) Single-Chip mmWave Sensing Solution. For details regarding the visualization tool, see the software release User's Guide.

3.1.1 Hardware

The AWR1642 core design includes the following:

- AWR1642 device: a single-chip, 77-GHz, radar device with an integrated DSP
- Power management network, which uses a low-dropout (LDO) linear regulator and power management-integrated circuit (PMIC) DC/DC supply (TPS7A88, TPS7A8101-Q1, and LP87524B-Q1)
- EVM also hosts a device to assist with onboard emulation and UART emulation over a USB link with the PC

3.1.2 Software and GUI

- The ODS demo application is based on the mmWave SDK. The software of the ODS demo is available in the TI Resource Explorer at <http://dev.ti.com/tirex/#/>. It is located in the Software\mmWave Sensors\Automotive Toolbox\Labs\Obstacle Detection. The version of the Automotive Toolbox must be 2.4.3 or higher. The ODS demo application is also available under the resource explorer menu of Code Composer Studio™ (CCS).
- The GUI for the ODS reference design is at the same location previously mentioned. For detailed information about how to run the demo and GUI, see the User's Guide, located under the ODS demo directory of the resource explorer.

3.2 Testing and Results

3.2.1 Test Setup

The tests were performed in a lab environment. The sensor was placed at a height of 60 cm. For these specific tests, the range was configured 0 m to 2 m. Different types of objects were placed within the range 0 m to 2 m at various angles 0; $\pm 30^\circ$; $\pm 50^\circ$; $\pm 70^\circ$.

注: The AWR1642BOOST-ODS EVM must be placed with the antenna at the top to benefit from $\pm 70^\circ$ FOV in azimuth and $\pm 40^\circ$ FOV in elevation. See setup in [図 9](#).

3.2.2 Test Results

[表 3](#) summarizes the test results.

表 3. Test Results

Object Description	-70°	-50°	-30°	0°	30°	50°	70°
Metal Pole	√	√	√	√	√	√	√
Plastic Reflector	√	√	√	√	√	√	√
Wood Plank	√	√	√	√	√	√	√
Bicycle	√	√	√	√	√	√	√
Concrete Block (8"x8"x16")	√	√	√	√	√	√	√
Small Cone(14")	√	√	√	√	√	√	√

Following are some snapshots of the testing setup with associated GUI measurements.

The reflected points are clustered. A cluster is rendered as a cube. The size of the cube is computed based on the size of the cluster. Red is used to render objects within 1 m. Green is used to render objects at a distance larger than 1 m. In the GUI, the bright red square shows the location of the sensor.



図 9. Horizontal Concrete Block and Plastic Reflector

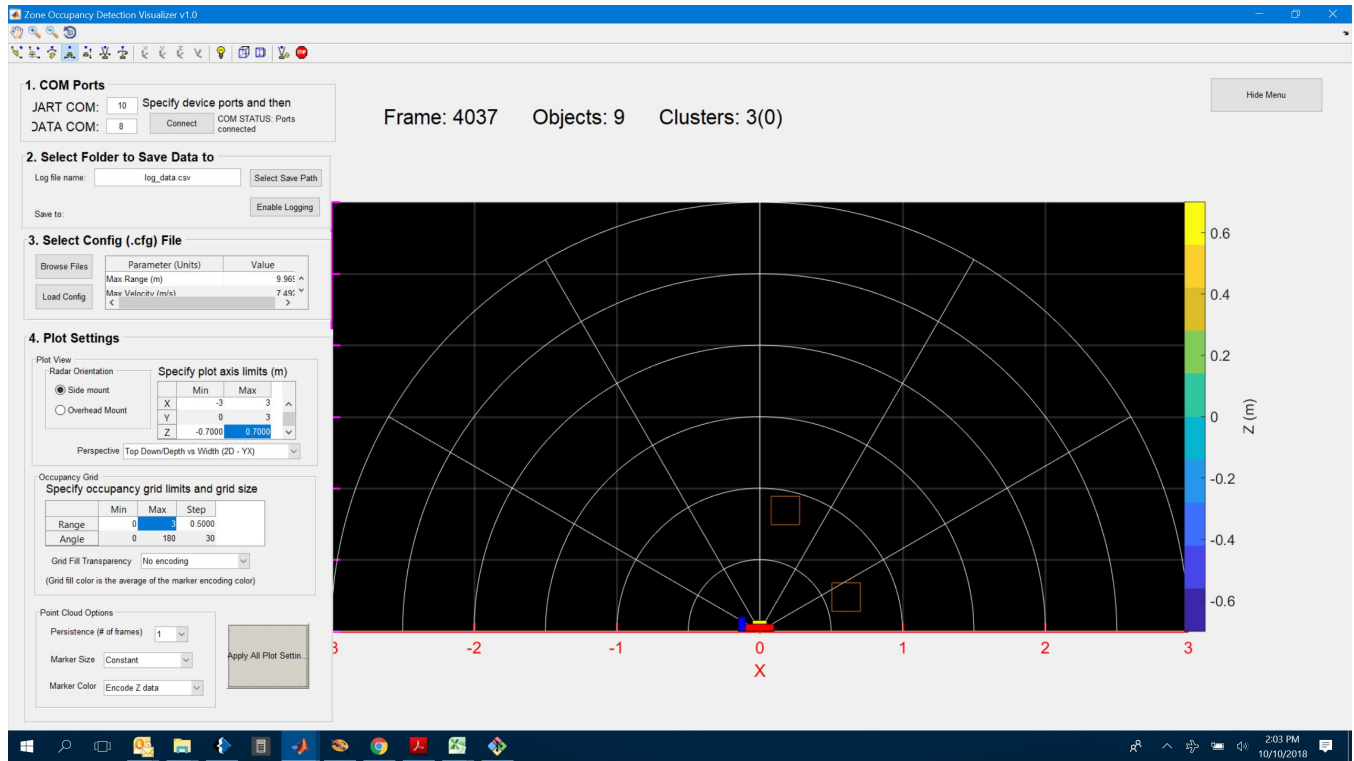

Figure 10. Horizontal Concrete Block and Plastic Reflector - 2D View

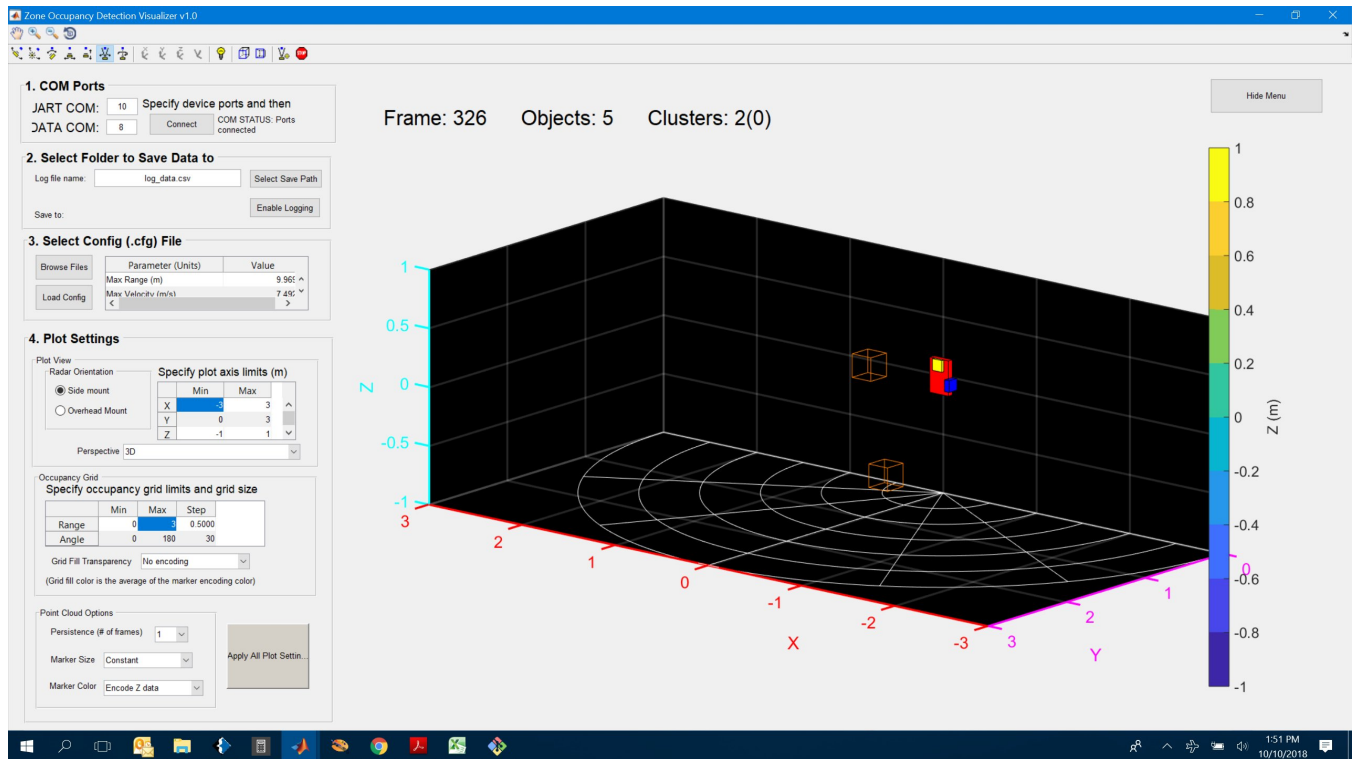

Figure 11. Horizontal Concrete Block and Plastic Reflector - 3D View



図 12. Vertical Concrete Blocks



図 13. Vertical Concrete Blocks- 2D View

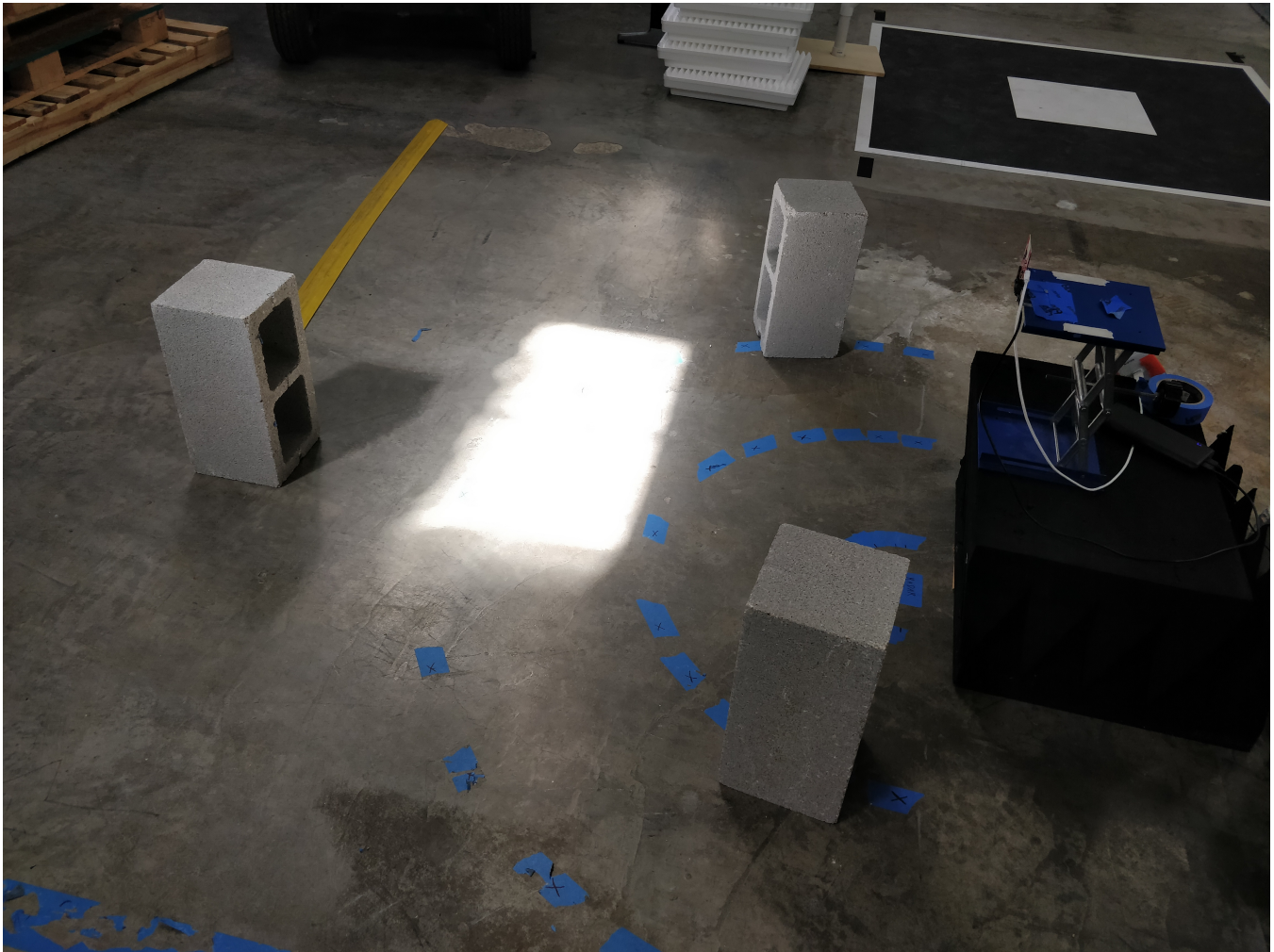

図 14. Vertical Concrete Blocks - 3D View

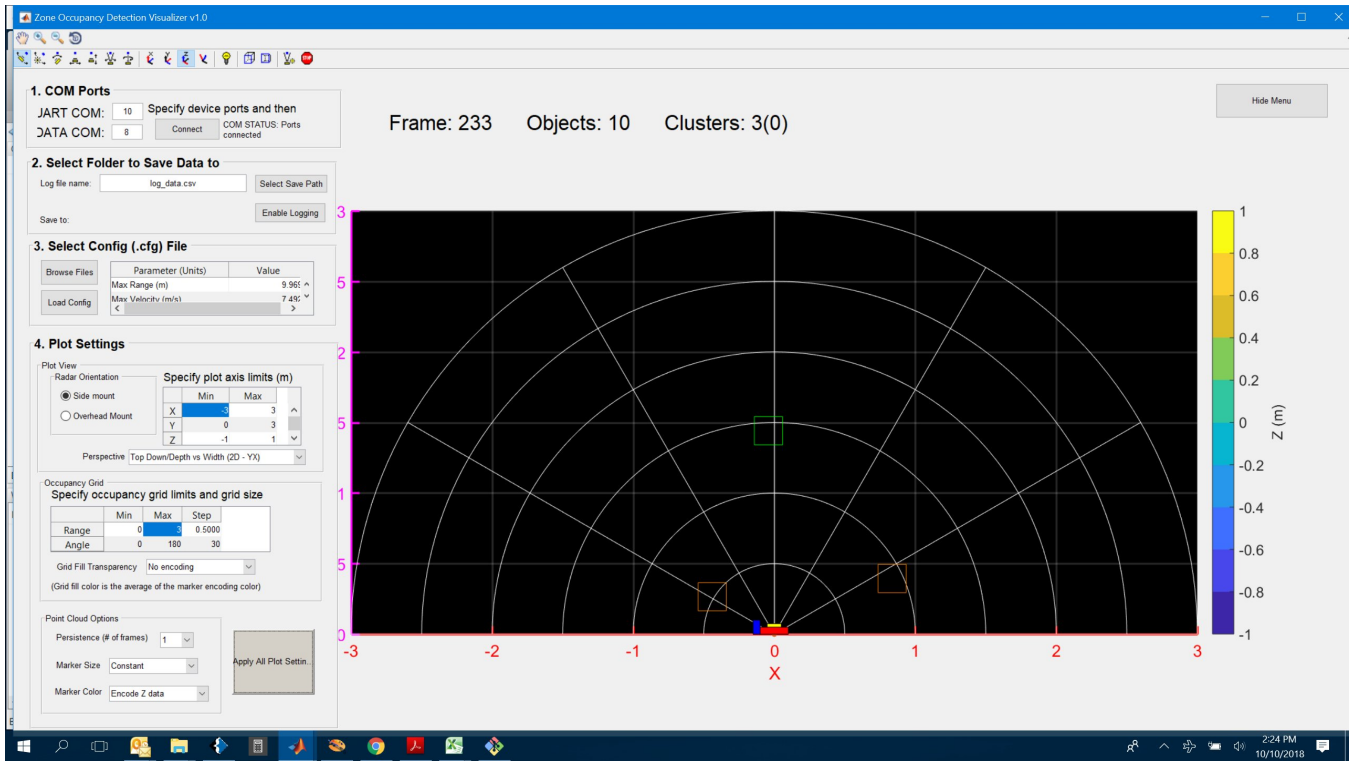

図 15. Wood Plank and Small Cone

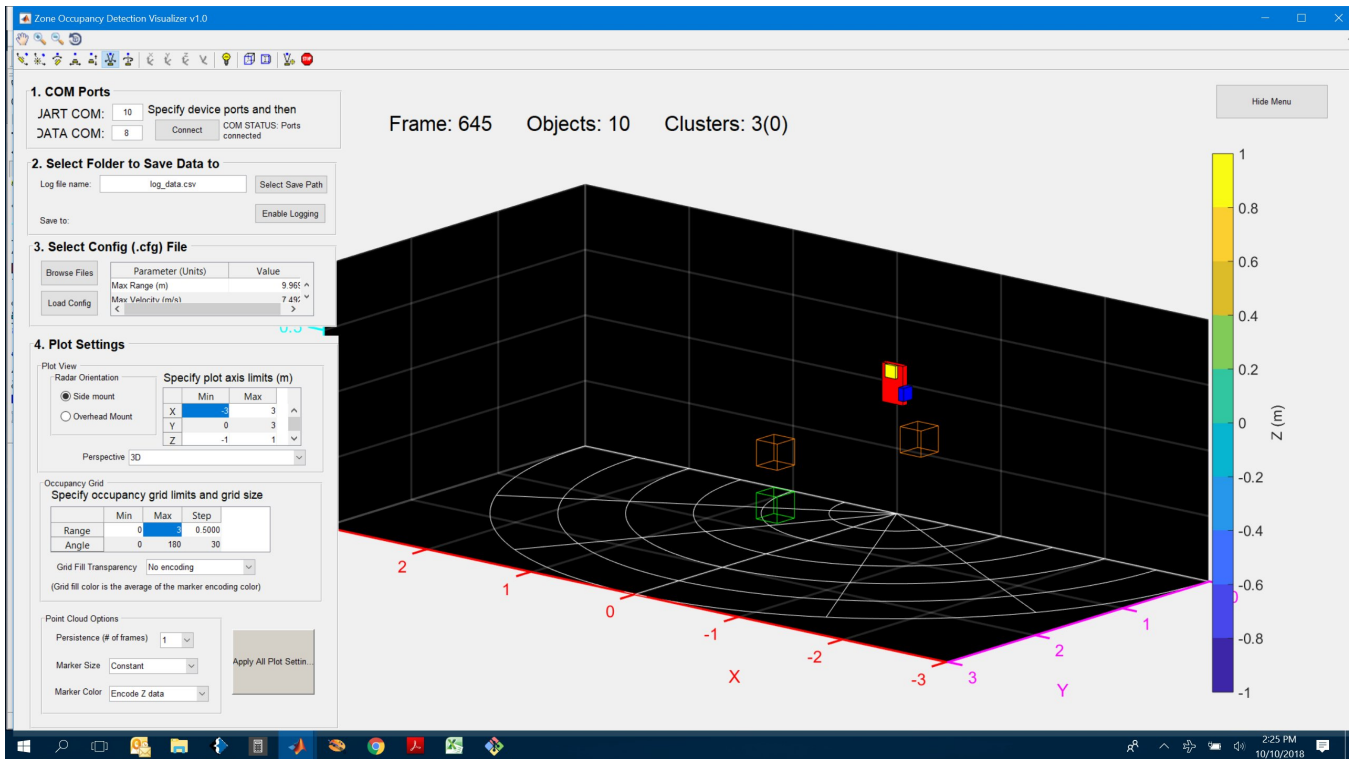

図 16. Wood Plank and Small Cone - 2D View

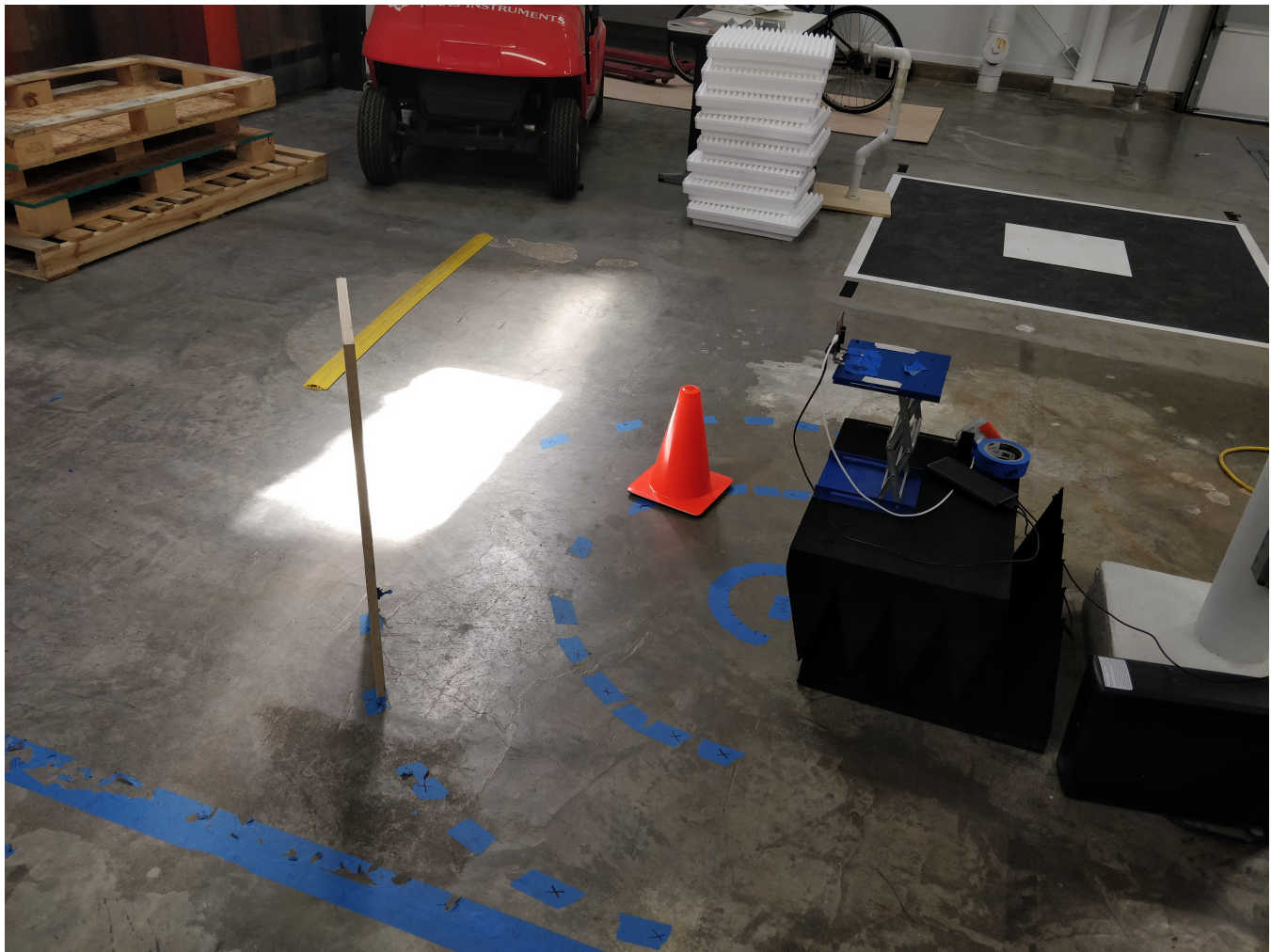

図 17. Wood Plank and Small Cone - 3D View

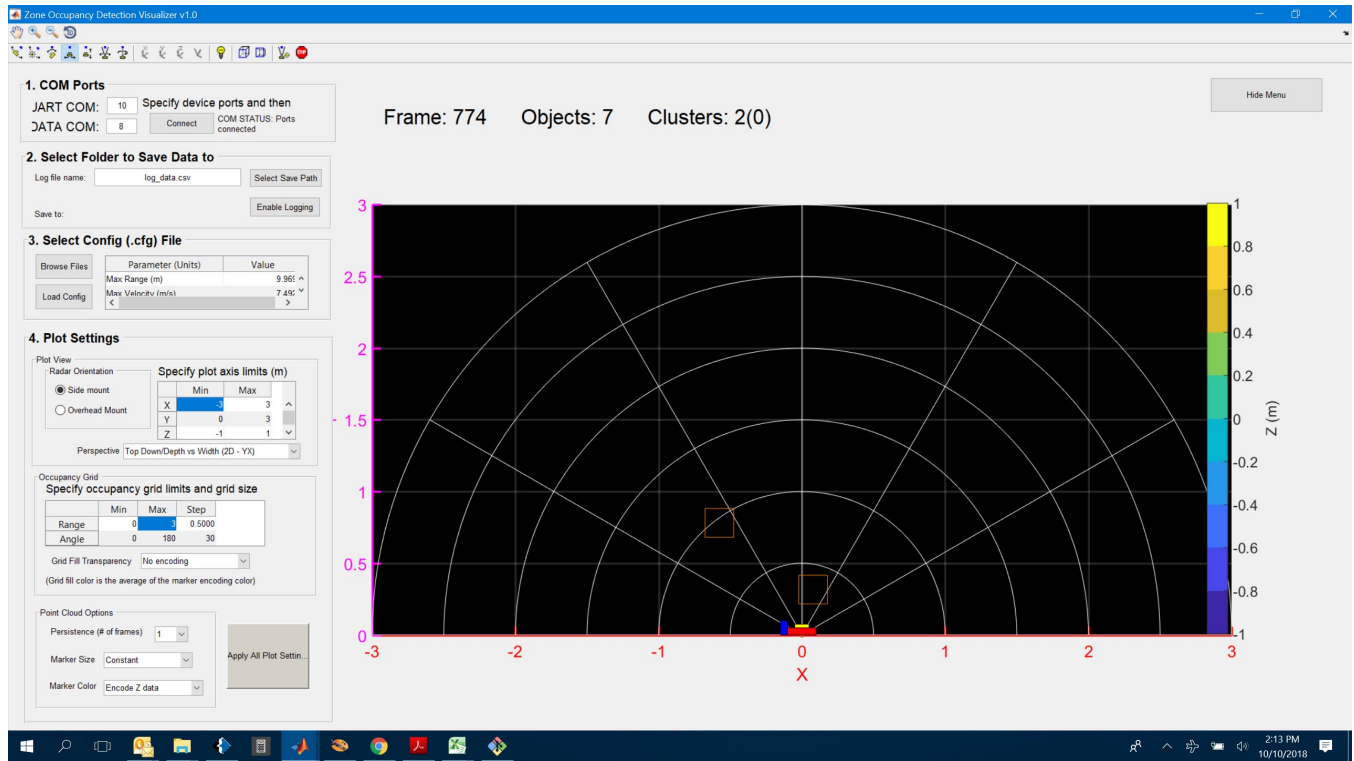

☒ 18. Bicycle

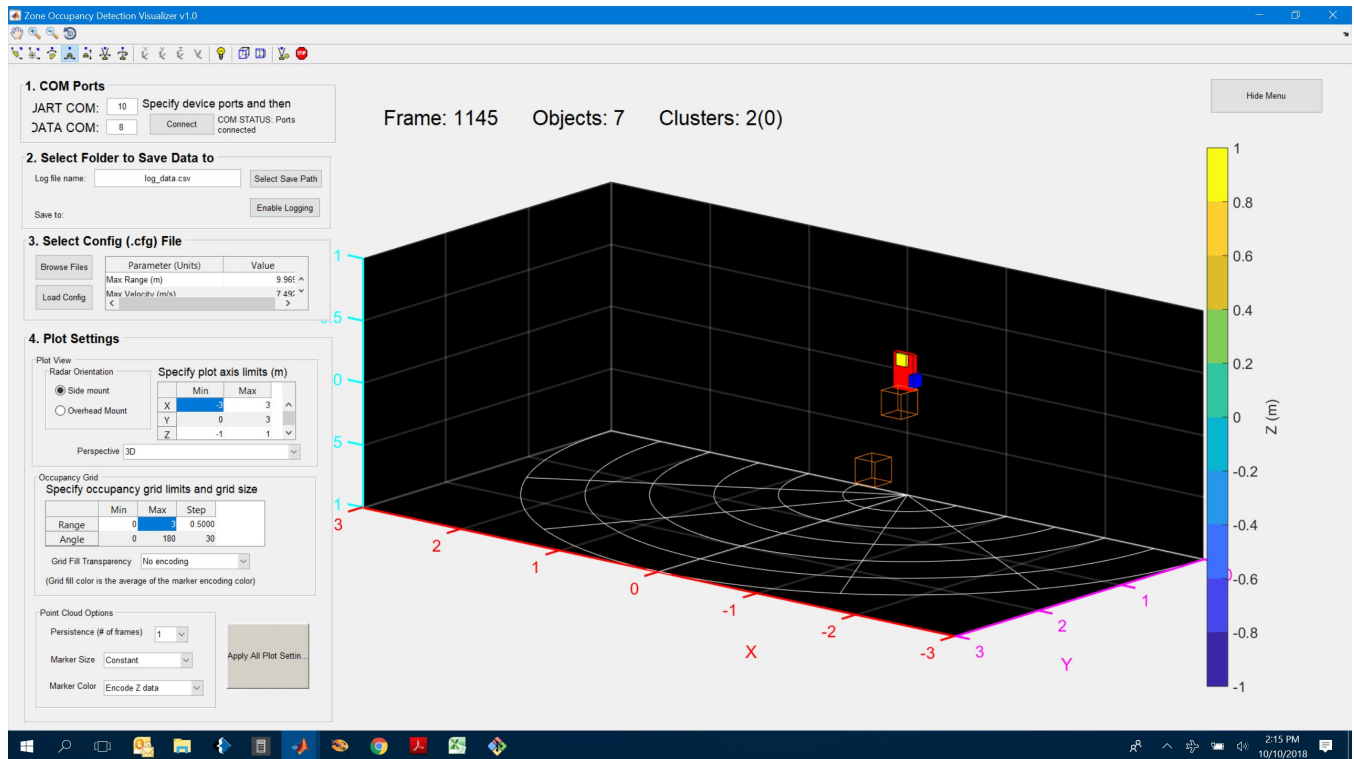

図 19. Bicycle -2D View



図 20. Bicycle - 3D View

4 Related Documentation

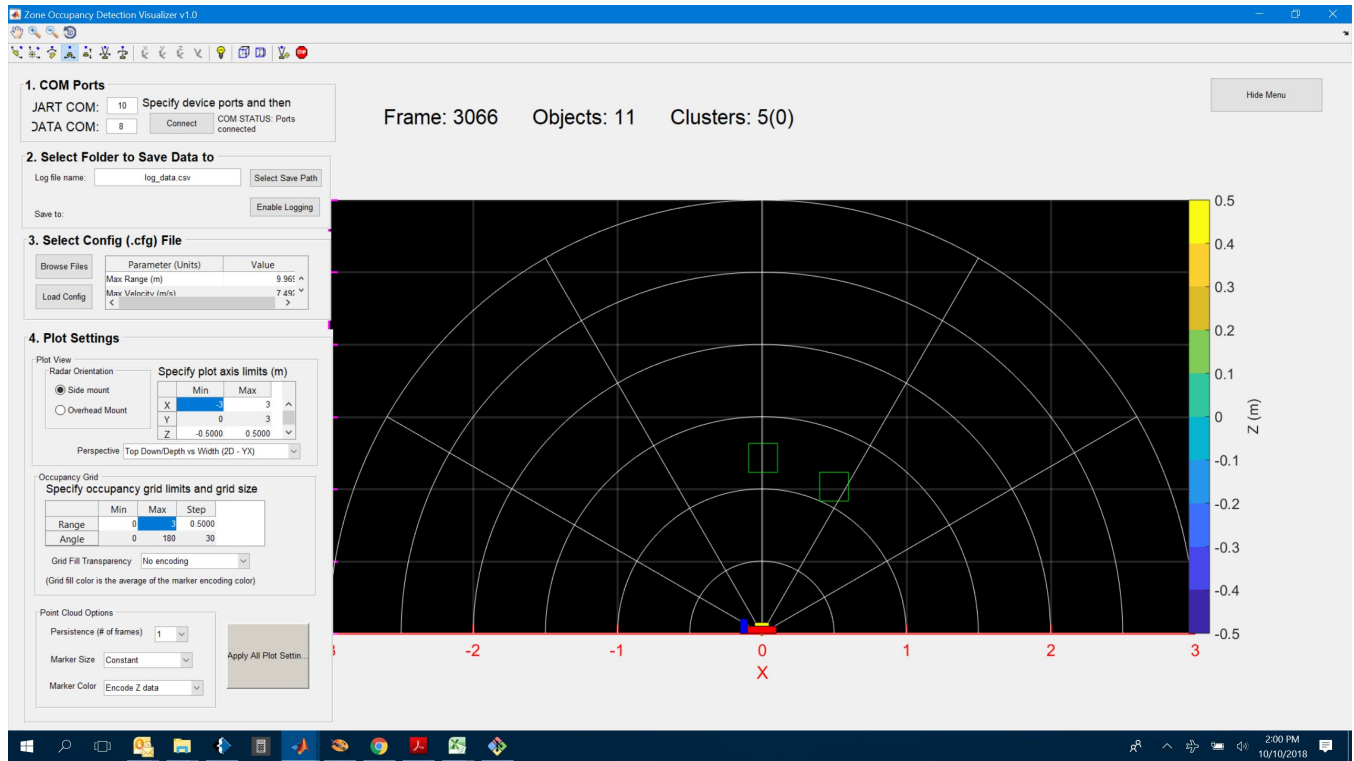
- Texas Instruments, [AWR1642 Evaluation Module \(AWR1642BOOST-ODS\) Single-Chip mmWave Sensing Solution](#)
- Texas Instruments, [Programming Chirp Parameters in TI Radar Devices](#)
- Texas Instruments, [AWR1642 Single-Chip 77- and 79-GHz FMCW Radar Sensor](#)
- Texas Instruments, [AR14xx/16xx Technical Reference Manual](#)
- Texas Instruments, [AWR1642 Evaluation Board Design Database](#)
- Texas Instruments, [AWR1642BOOST Schematic](#)
- Texas Instruments, [AWR1642BOOST Assembly Drawings](#)
- Texas Instruments, [AWR1642BOOST Bill of Materials \(BOM\)](#)
- Texas Instruments, [mmWave SDK User's Guide](#)
- Texas Instruments, [AWR1642 Technical Reference Manual](#)

4.1 商標

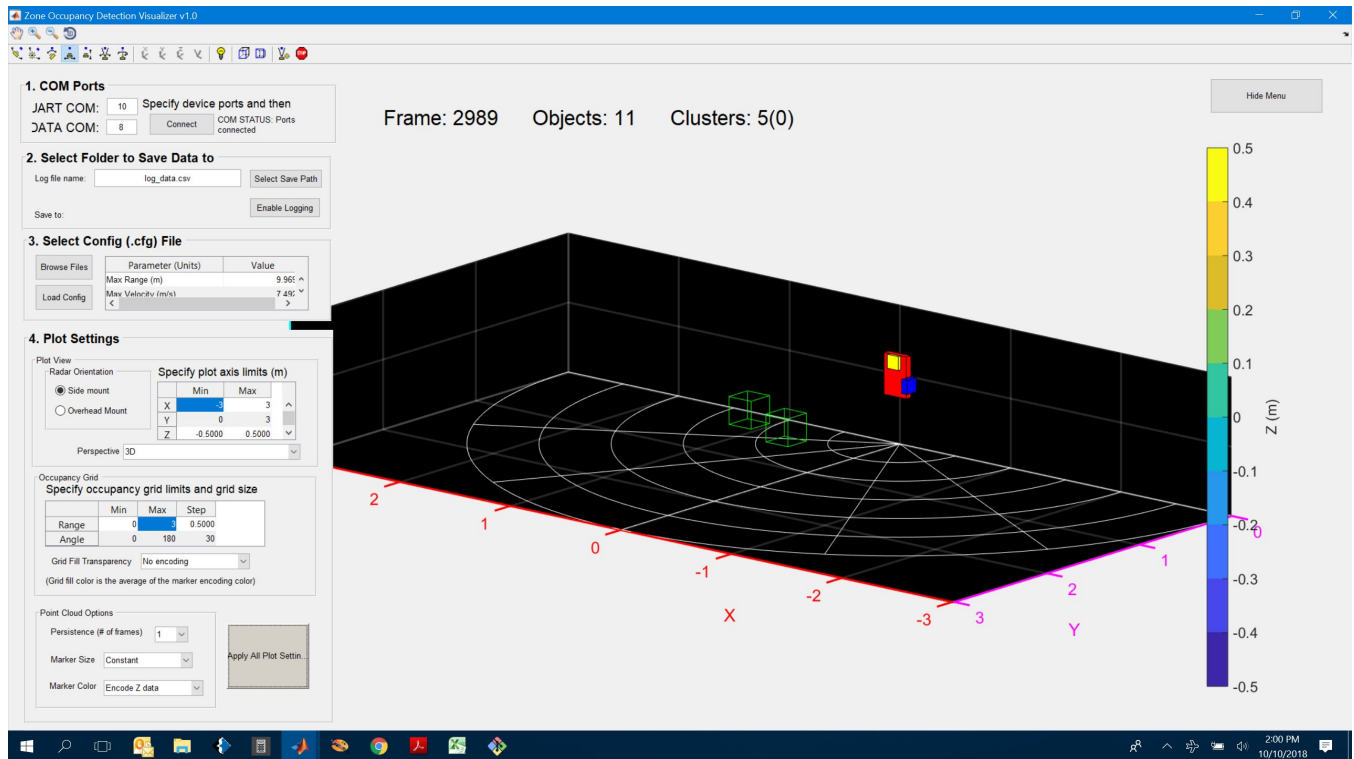
E2E, Code Composer Studio are trademarks of Texas Instruments.
すべての商標および登録商標はそれぞれの所有者に帰属します。

重要なお知らせと免責事項

TI は、技術データと信頼性データ(データシートを含みます)、設計リソース(リファレンス・デザインを含みます)、アプリケーションや設計に関する各種アドバイス、Web ツール、安全性情報、その他のリソースを、欠陥が存在する可能性のある「現状のまま」提供しており、商品性および特定目的に対する適合性の黙示保証、第三者の知的財産権の非侵害保証を含むいかなる保証も、明示的または黙示的にかかわらず拒否します。

これらのリソースは、TI 製品を使用する設計の経験を積んだ開発者への提供を意図したものです。(1) お客様のアプリケーションに適した TI 製品の選定、(2) お客様のアプリケーションの設計、検証、試験、(3) お客様のアプリケーションが適用される各種規格や、その他のあらゆる安全性、セキュリティ、またはその他の要件を満たしていることを確実にする責任を、お客様のみが単独で負うものとします。上記の各種リソースは、予告なく変更される可能性があります。これらのリソースは、リソースで説明されている TI 製品を使用するアプリケーションの開発の目的でのみ、TI はその使用をお客様に許諾します。これらのリソースに関して、他の目的で複製することや掲載することは禁止されています。TI や第三者の知的財産権のライセンスが付与されている訳ではありません。お客様は、これらのリソースを自身で使用した結果発生するあらゆる申し立て、損害、費用、損失、責任について、TI およびその代理人を完全に補償するものとし、TI は一切の責任を拒否します。

TI の製品は、TI の販売条件 (www.tij.co.jp/ja-jp/legal/termsofsale.html)、または ti.com やかかる TI 製品の関連資料などのいずれかを通じて提供する適用可能な条項の下で提供されています。TI がこれらのリソースを提供することは、適用される TI の保証または他の保証の放棄の拡大や変更を意味するものではありません。

Copyright © 2018, Texas Instruments Incorporated
日本語版 日本テキサス・インスツルメンツ株式会社

重要なお知らせと免責事項

TI は、技術データと信頼性データ(データシートを含みます)、設計リソース(リファレンス・デザインを含みます)、アプリケーションや設計に関する各種アドバイス、Web ツール、安全性情報、その他のリソースを、欠陥が存在する可能性のある「現状のまま」提供しており、商品性および特定目的に対する適合性の黙示保証、第三者の知的財産権の非侵害保証を含むいかなる保証も、明示的または黙示的にかかわらず拒否します。

これらのリソースは、TI 製品を使用する設計の経験を積んだ開発者への提供を意図したものです。(1) お客様のアプリケーションに適した TI 製品の選定、(2) お客様のアプリケーションの設計、検証、試験、(3) お客様のアプリケーションが適用される各種規格や、その他のあらゆる安全性、セキュリティ、またはその他の要件を満たしていることを確実にする責任を、お客様のみが単独で負うものとします。上記の各種リソースは、予告なく変更される可能性があります。これらのリソースは、リソースで説明されている TI 製品を使用するアプリケーションの開発の目的でのみ、TI はその使用をお客様に許諾します。これらのリソースに関して、他の目的で複製することや掲載することは禁止されています。TI や第三者の知的財産権のライセンスが付与されている訳ではありません。お客様は、これらのリソースを自身で使用した結果発生するあらゆる申し立て、損害、費用、損失、責任について、TI およびその代理人を完全に補償するものとし、TI は一切の責任を拒否します。

TI の製品は、TI の販売条件 (www.tij.co.jp/ja-jp/legal/termsofsale.html)、または ti.com やかかる TI 製品の関連資料などのいずれかを通じて提供する適用可能な条項の下で提供されています。TI がこれらのリソースを提供することは、適用される TI の保証または他の保証の放棄の拡大や変更を意味するものではありません。

Copyright © 2018, Texas Instruments Incorporated
日本語版 日本テキサス・インスツルメンツ株式会社