

TI Designs: TIDA-020004

デュアル CAN-FD 上で物体データを出力する車載用 RFCMOS 77GHz レーダー・モジュールのリファレンス・デザイン



概要

この車載用レーダーのリファレンス・デザインは、テスト済みの 76GHz~81GHz のレーダー・センサ・モジュール・ソリューションです。オンボードの電源により、車載用バッテリー入力が、レーダーのアナログ・フロント・エンド (AFE)、プロセッサ、および CAN-FD (Controller Area Networking with Flexible Data rate) トランシーバ用に必要なレールへと変換されます。処理後のオブジェクト・データは、内蔵の CAN-FD物理層(PHY)上で伝送されます。

リソース

TIDA-020004	デザイン・フォルダ
AWR1642	プロダクト・フォルダ
LP87702-Q1	プロダクト・フォルダ
TPS7A52-Q1	プロダクト・フォルダ
LM53625-Q1	プロダクト・フォルダ
TCAN4550-Q1	プロダクト・フォルダ
TCAN1042GV-Q1	プロダクト・フォルダ

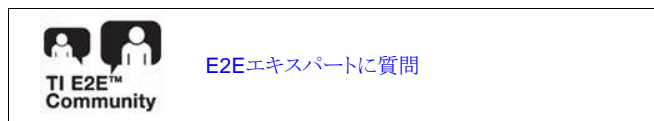

特長

- 1枚のPCB(約50mmx71mm)に搭載された省スペースのデザイン
- 小さなサイズと高効率に最適化された電源
- 単一チップの76~81GHz車載用レーダー・センサにDSPとMCUを統合し、CAN-FD上でオブジェクト・データを供給
- V_{IN} の範囲が広く、36Vのオフ・バッテリー電源をサポート、最高42Vまで許容
- ASIL Bアプリケーションの診断および監視機能

アプリケーション

- ADASレーダー・システム
- 死角検知 (BSD)
- 車線変更支援 (LCA)
- 前後クロス・トラフィック警告 (F/RCTA)
- 自律式緊急ブレーキ (AEB)
- アダプティブ・クルーズ・コントロール (ACC)

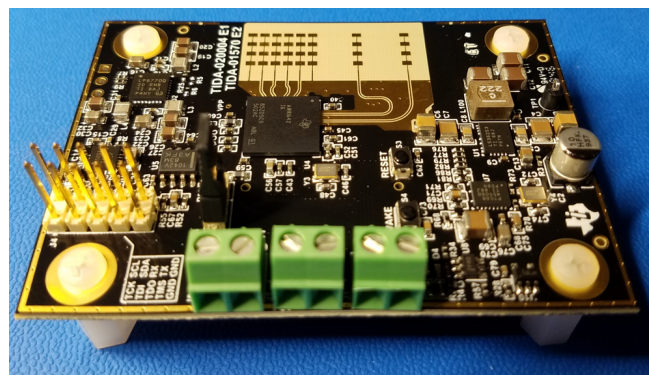
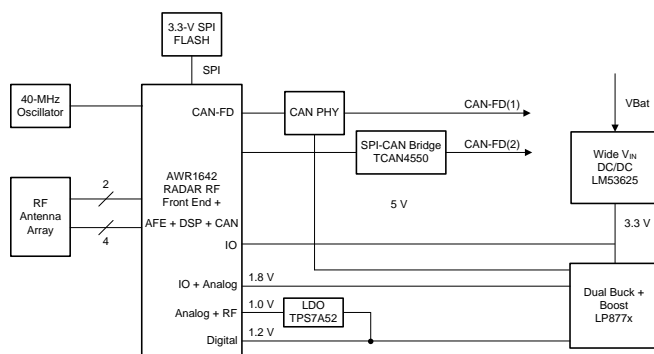



使用許可、知的財産、その他免責事項は、最終ページにあるIMPORTANT NOTICE (重要な注意事項)をご参照くださいますようお願いいたします。

1 System Description

Radar sensors are a requirement for many automotive safety systems. Locating these sensors in bumpers and side mirrors can be difficult. A very small sensor simplifies the process of meeting these market demands and provides a less expensive approach to meet such requirements. This reference design addresses these concerns by combining a single-chip, 76- to 81-GHz automotive radar sensor with two CAN-FD PHYs and providing the necessary power supply. All of this functionality is contained on a 50×71-mm circuit board. The only two connections that the system requires are the battery power in and CAN-FD out.

The battery power connects to the 12-V input terminal, J1. The wide V_{IN} buck, LM536253-Q1, is utilized to convert this 12-V input to a 3.3-V output. The LP87702-Q1 then takes the 3.3-V input and creates 5.0-V, 1.8-V, and 1.24-V rails. To ensure a low-noise supply, the TPS7A52-Q1 low-dropout linear regulator (LDO) creates a clean 1-V rail for the radio frequency (RF) section of the radar.

The radar section of this design utilizes a printed-circuit-board (PCB) etched antenna with two transmit elements and four receive elements. By using this antenna, a modulated chirp is transmitted and reflections are sampled into the onboard digital signal processor (DSP). With this information, the sensor can record distance, angle, and velocity measurements from objects within the antenna field of view.

The design offers a feature to write out the object data to a central electronic control unit (ECU) on the CAN-FD bus at a rate of 5 Mb/s. If needed, there is a second CAN-FD PHY that is connected to a SPI port on the AWR1642 RFCMOS Radar.

1.1 Key System Specifications

表 1. Key System Specifications

PARAMETER		COMMENTS	MIN	TYP	MAX	UNIT
V_{IN}	Supply voltage	Battery input	4	12	42	V
P_{TOTAL}	Total power consumption	$V_{IN} = 12\text{ V}$	—	2.6	—	W
CAN-FD	Data rate	—	—	—	5	Mb/s

2 System Overview

2.1 Block Diagram



図 1. Radar Module Block Diagram

2.2 Highlighted Products

This reference design uses the following TI products:

- AWR1642-Q1: This integrated, single-chip frequency-modulated continuous wave (FMCW) radar sensor is capable of operation in the 76- to 81-GHz band. The device is built with TI's low-power 45-nm RFCMOS process and enables unprecedented levels of integration in an extremely-small form factor (SFF). The AWR1642 is an ideal solution for low-power, self-monitored, ultra-accurate radar systems in the automotive space.
- LP87702-Q1: This automotive-qualified power device is optimized for radar applications with a dual high-current buck converter and 5-V boost. The high switching frequency of up to 4 MHz allows the use of small inductors and improves system performance because the second harmonic is out of the IF band of the AWR1642 sensor. The LP87702-Q1 includes diagnostics functions such as monitoring of the internal and two external rails, two programmable power-good outputs, and a window watchdog.
- TPS7A52-Q1: The TPS7A52-Q1 is an automotive-qualified, low-noise 2-A linear regulator with ultra-low dropout. This linear regulator filters any power supply noise that emanates from the upstream switching supplies while minimizing dissipation through ultra-low dropout operation.
- LM536253-Q1: The LM536253-Q1 synchronous buck regulator is optimized for automotive applications and provides an output voltage of 5 V, 3.3 V, or an adjustable output. Advanced high-speed circuitry allows the LM53625-Q1/LM53635-Q1 to regulate from an input of 18 V to an output of 3.3 V at a fixed frequency of 2.1 MHz. Innovative architecture allows this device to regulate a 3.3-V output from an input voltage of only 3.55 V. All aspects of the LM53625-Q1/LM53635-Q1 are optimized for automotive and performance-driven industrial customers. An input voltage range up to 36 V, with transient tolerance up to 42 V, eases input surge protection design.
- TCAN1042GV-Q1: This automotive CAN transceiver meets the ISO11898-2 (2016) high speed CAN physical layer standard.

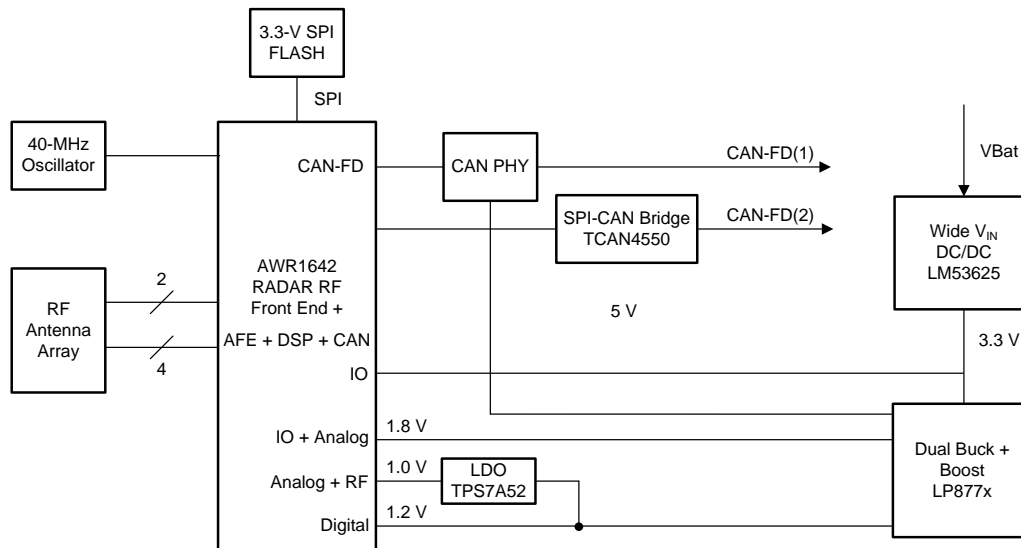
- TCAN4550-Q1: This automotive one-chip CAN-FD solution can connect to almost any processor or microcontroller with an SPI interface. The device also includes a CAN-FD controller, CAN-FD transceiver, and supports advanced features including watchdog, inhibit and wake functionality.

The following subsections provide more information on each device and why they have been chosen for this application.

2.2.1 AWR1642-Q1 CMOS RADAR

AWR1642 is a single-chip radar sensor built with four receivers and two transmitters. Built with RFCMOS technology, the device integrates the RF and analog subsystem with the digital subsystem to deliver low power in an SFF for ultra-short-range radar (USRR) and short-range radar (SRR) applications. The device is based on closed-loop phase-locked-loop (PLL) architecture for precise and linear chirp synthesis. The device includes a built-in radio processor (BIST) for RF calibration and safety monitoring. Based on complex baseband architecture, the sensor device supports an intermediate frequency (IF) bandwidth of 5 MHz with reconfigurable output sampling rates. Integration of an ARM® Cortex®-R4F processor and Texas Instruments C674x DSP (fixed and floating point), along with 1.5MB of on-chip RAM, enables high-level algorithm development.

2.2.2 LP87702-Q1

The LP87702x-Q1 contains two high-current (up to 3.5 A) buck converters and a 5-V boost for CAN supply. The device supports remote voltage sensing to compensate IR drop between the regulator output and the point-of-load (POL), which improves the accuracy of the output voltage. The device is either controlled by an I²C-compatible serial interface, enable signal, or both.

The 4-MHz high-switching frequency of the LP87702D-Q1 allows the use of small inductors and improves system performance by pushing the second harmonic out of the maximum IF band of the AWR1642 device. To further protect the system from electromagnetic interference (EMI), the buck and boost converters are programmed to forced pulse-width modulation (PWM) mode for a fixed switching noise spectrum. When an external clock is provided, the device automatically synchronizes buck and boost clocks to the external clock.

The integrated diagnostic functions of the LP87702D-Q1 help to reduce the radar solution size. The validity of the internal regulator output voltages, 3.3-V input, and two external rails can be monitored through two programmable power-good outputs. The device also includes a window watchdog with programmable open and close times and reset output.

2.2.3 TPS7A52-Q1

The combination of low-noise ($4.4 \mu\text{V}_{\text{RMS}}$), high power-supply rejection ratio (PSRR), and high output current capability makes the TPS7A52-Q1 ideal to power noise-sensitive components, such as the RF portion of an automotive radar sensor.

The RF supply rails (1.3 V) can be overridden and supplied with an external 1.0-V voltage regulator; however, this supply must be free of excessive noise, which can be detrimental to system performance. The TPS7A52-Q1 has high PSRR over an extended bandwidth to ensure that any upstream switching noise at or above 1 MHz is attenuated effectively. The TPS7A52-Q1 also has very low levels of intrinsic noise (as low as $4.4 \mu\text{V}_{\text{RMS}}$) through the use of a noise-reduction capacitor. Together, these qualities make this device a good choice to ensure a quiet power supply.

Additionally, this device is capable of low dropout operation with the use of a higher bias rail. Use of this rail limits the minimal power dissipated across the LDO that typically heats up the board and surrounding components. Rather than dissipate power with the internal LDO from 1.3 V to 1.0 V, using the TPS7A52-Q1 enables a 1.2-V to 1.0-V conversion and cuts the dissipation by 33%.

2.2.4 LM536253-Q1

The LM536253-Q1 is designed to support a smaller solution size and run at cooler temperatures in a application, which is a combination of package technology and higher overall efficiency in operation. Using several techniques to minimize switch noise and minimized parasitic impedance, this device offers low noise emission which helps to lower system electromagnetic compatibility (EMC) and assist with the ease of design. The DC/DC converter is optimized for out-of-standard regulation conditions, which can either be fault conditions or normal operation (like cold crank and load dump). The LM536253-Q1 offers the full capability to assist front-end automotive power supply designs.

2.2.5 TCAN1042GV-Q1

This automotive CAN transceiver meets the ISO11898-2 (2016) high-speed CAN physical layer standard. This PHY has a low power standby mode with remote wake request and many protection features to enhance device and network robustness. This PHY was chosen for its simplicity and small size.

2.2.6 TCAN4550-Q1

Through the SPI interface, this device provides all of the necessary components to implement CAN-FD into any system. Although classic CAN controllers are frequently available and integrated into numerous processing solutions, the same does not hold true for CAN-FD. The TCAN4550-Q1 allows users to simplify their processing solution to save additional cost and offload the processing requirements of CAN-FD to the integrated CAN-FD controller and CAN-FD transceiver. Available in a small, 20-pin, 4x4 package, the device can be utilized to implement CAN-FD or add additional CAN-FD ports.

2.3 Design Considerations

2.3.1 PCB and Form Factor

This reference design is not intended to fit any particular form-factor. The only goal of the design with regards to the PCB is to make a compact solution that serves as a fully-featured automotive radar sensor. With the mounting holes, the board measures roughly 50 mm x 71 mm (2 in x 2.8 in). [Figure 2](#) and [Figure 3](#) show the top view and bottom view of the PCB.



図 2. PCB Top View



図 3. PCB Bottom View

2.3.2 Power Supply Topology

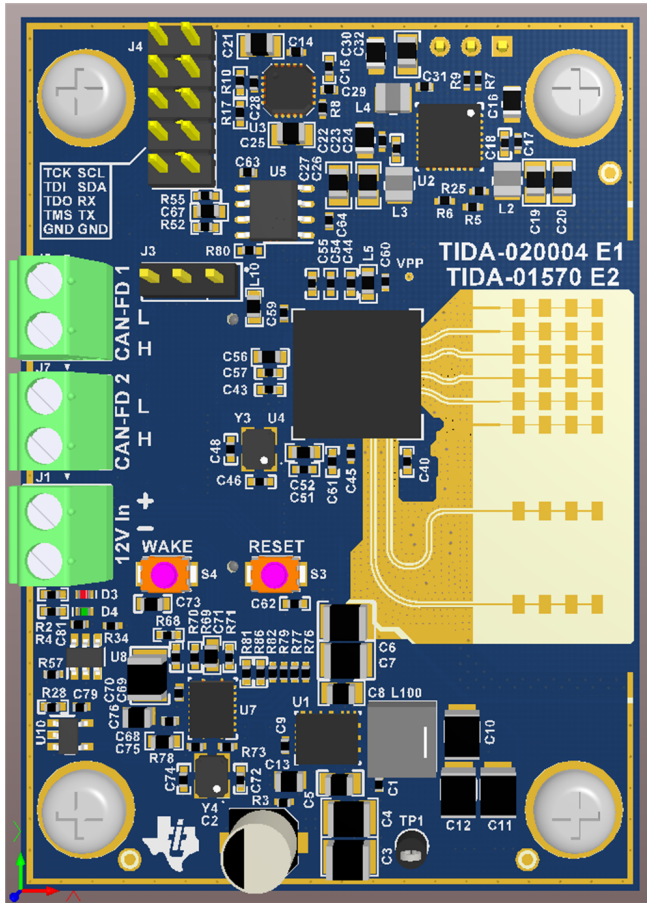
As the previous [Figure 1](#) shows, the radar sensor reference design is intended to connect directly to the vehicle battery. The voltages required for the design are:

- 5 V for CAN-FD PHY
- 3.3 V for radar I/O
- 1.8 V for radar analog, RF, VCO, and CMOS
- 1.2 V for radar digital and SRAM
- 1 V or 1.3 V for radar analog and RF

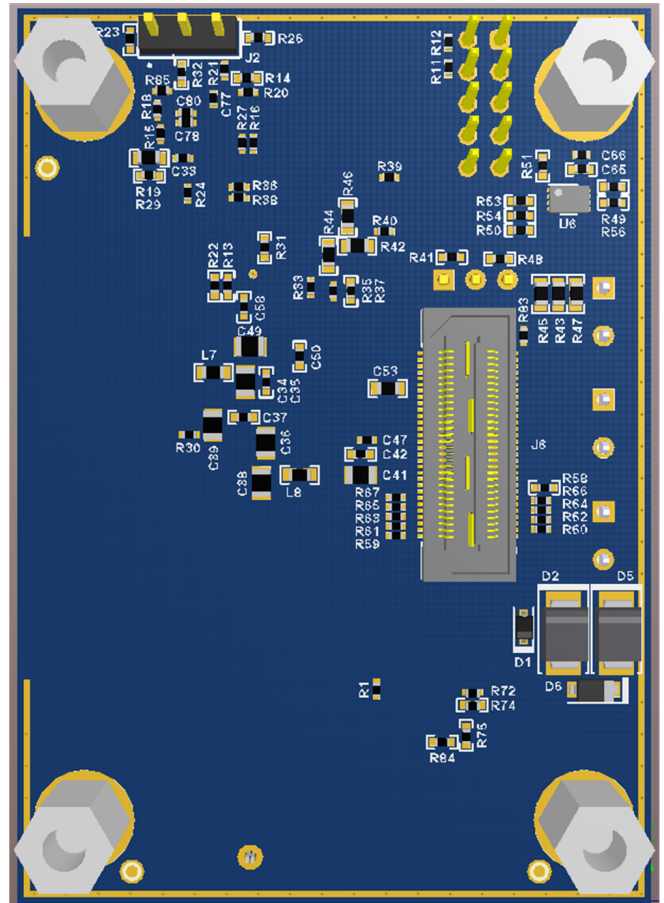
An automotive battery supplies the power input to this sensor; therefore, the design requires a wide V_{IN} buck that can tolerate up to 40 V as the first stage of the power supply. Use a multi-rail power supply, which has been specifically designed for this application, to create the 5-V, 1.8-V, and 1.2-V rails. The designer has the option to provide the radar analog and RF supply as a 1.3-V input to the LDO inside the AWR1642 device. Another option is to directly supply the radar analog and RF supply as a low noise 1-V rail. The latter option reduces the power dissipated by the AWR1642 device. This option may also reduce the total system power, depending on the system architecture. For this design, supply the radar analog and RF supply externally with a low-noise LDO. By raising the 1.2-V rail to 1.24 V, enough headroom becomes available to cover the dropout on the LDO that produces the 1-V output. This action also reduces the power dissipated in the LDO by using 1.24 V as the input to the LDO, rather than the next higher voltage rail, 1.8 V.

2.3.2.1 AWR1642 Power Supply Considerations

The AWR1642 device utilizes four power rails for its operation: a 1.2-V digital supply, 3.3-V IO supply, 1.8-V analog supply, and 1-V RF supply. [Table 2](#) lists the peak currents on each of the rails. The average current consumption depends on the chirp profile and frame configuration used; for example, a 1Tx, 4Rx use case with a 50% duty cycle and DSP processing consumes approximately 1.9 W of average power.

表 2. Power Rail Current Requirements

POWER RAIL	PEAK CURRENT
1.2 V	1000 mA
1.8 V	850 mA
1 V	2000 mA
3.3 V	Depends on the interfaces used on AWR1642

In a case where the 1-V supply is derived from the 1.2 V using a regulator (such as in this reference design), the 1.2 V (1.24 V) of available current must include both 1.2-V and 1-V rail currents. [Figure 4](#) shows a block diagram of the AWR1642 power supply filters.

One of the key concerns when using the switching regulators for the power supply is to prevent the switching frequency of the regulator from coupling onto the analog circuitry through the supply or ground. At a 4-MHz switching frequency, the AWR1642 can tolerate approximately 35.5- μ V_{RMS} ripple on the 1.8-V supply to keep the spur in the RX spectrum of less than -120 dBm (at the LNA input). The following steps offer ways to reduce the supply ripple level:

- Use LC filtering on the analog and RF supplies (1.8 V and 1 V).
- Some of the output voltage ripple of a switching buck regulator is caused by the inductor ripple current charging and discharging the output capacitor. Minimize this inductor ripple current by using a high

switching frequency, in this case 4 MHz. The recommended inductance for LP87702-Q1 buck regulators is 0.47 μ H.

- A higher output capacitance reduces the output voltage ripple and also improves load step behavior. Use ceramic capacitors with low to minimize ripple. The R_{ESR} is frequency dependent (as well as temperature dependent); make sure the value used for the selection process is at the switching frequency. Use the point-of-load capacitors to further decrease the ripple voltage and improve load transient performance.

- Use the LC filter to continue filtering the output from the regulator. Place a series ferrite bead on the supply path, along with the decoupling capacitors of the supply, so that they can act as an LC filter to reduce the ripple amplitude. Choose the values such that the corner frequency of the LC filter is much lower than the switching frequency. For example, in this design, the LP87702 switches at a 4-MHz frequency. The LC filter is designed with the part number BLM18KG121TH1 to provide a cutoff frequency of approximately 120 KHz with the decoupling capacitors on the 1.8-V supply rail.

注: The IR drop across the inductor must be kept as low as possible, for which TI recommends a very-low DC resistance inductor. From the data sheet, the BLM18KG121TH1 has a data capture record (DCR) of 25 mΩ.

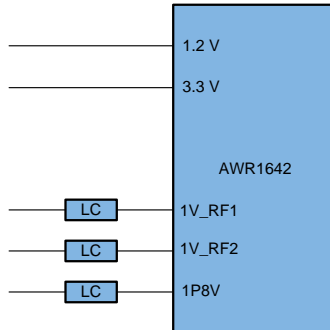

Copyright © 2017, Texas Instruments Incorporated

図 4. AWR1642 Power Supply Filters

- By providing ground cuts, the designer can reduce the interference of the switching currents for the regulator and the analog currents on the AWR1642 device (see 図 5). The circuits most vulnerable to ripple are the XTAL lines, VOUT_14SYNTH , VOUT_14APLL, VIN_18VCLK, and VIN_18VCO supplies.



図 5. Cuts in Layer 2 Ground Plane

2.3.2.1.1 Wide V_{IN} Buck

Under start-stop or cold-crank conditions, the voltage can drop quite dramatically—and to a level that causes the buck converter to go out of regulation. Some instances may require the designer to use a boost converter in the circuit to assist the system. If designing the power supply to support sudden voltage drops, the designer may be able to account for the cost of the boost, as well as the cost, space, and power consumption associated with the additional components.

A combination of a nearly 100% duty cycle, very-short minimum OFF-time, and a low $R_{DS(ON)}$ high-side field-effect transistor (FET) resistance enables the power supply to support a deep dropout of less than 0.6 V under a full load and full operating temperature range, all while maintaining regulation for downstream power supplies without adding additional design complexity. This feat is made possible by using the LM53625-Q1 under typical and extreme conditions in an automotive system.

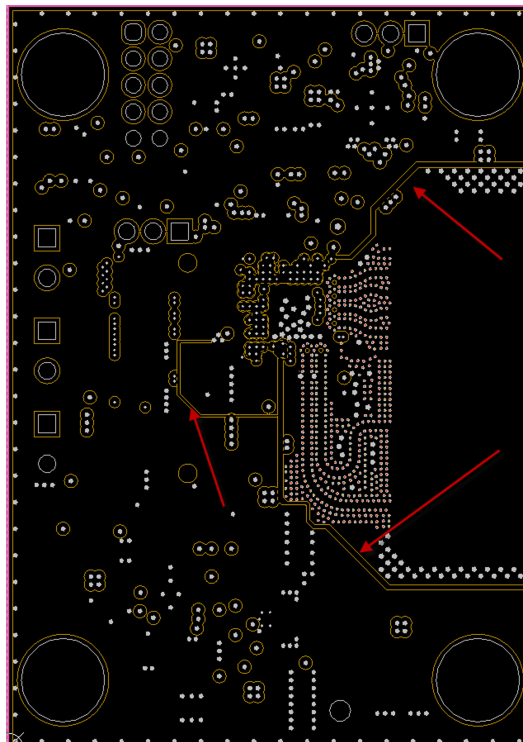
Maintaining regulation and stopping the power supply from becoming unstable is critical in automotive power supplies around the minimum drop-out and high V_{IN} conditions. System-related conditions like cold crank or even load dump from faulty alternators can affect the regulation and output power. Support for low dropout requires that the device output does not oscillate. This oscillation would translate into high-frequency noise and can cause disturbances elsewhere in the system. The LM53625-Q1 is used here because it is designed to support very-low T_{MIN-ON} and $T_{MIN-OFF}$ conditions. Stable control of the power supply is critical and smooth operation into and out of a desired regulation range is required, as this controls the noise that is generated.

2.3.2.1.2 Reducing EMI

The selection of available, low EMI power supplies is increasingly important due to many factors, including the progressively complex wire harnesses used in automobiles and the number of ECU nodes to add to the system. Each harness wire and each ECU has the ability to create noise that can be transmitted around the automobile and affect other applications. Given the increasing number of safety applications, the ability to offer low EMI is highly desirable. Several techniques can be used in the design of the power supply to minimize EMI.

One technique to lower the EMI is to choose a converter in a package that is optimized for layout placement and positioning of the passive components used in regulation and filtering. LM53625-Q1 uses a pinout that offers symmetrical placement of the high-frequency input capacitors, which are grounded on either side of the switch node. This placement creates reduced inductance between ground (GND) and the switch, which cancels any noise.

Additionally, by constructing the package in a certain manner, the designer can remove the parasitic loop inductance and capacitance inside the package and reduce the switch-node ringing, which is a major contributor to noise generation. The general idea is to reduce the noise at the source to avoid any problems caused by additional components. The LM53625-Q1 uses a flip chip package construction that removes the bond wires, which can, in some instances, add to the noise and degrade dropout and efficiency.

Another technique for reducing noise in the system is spread-spectrum technology, which modulates the central switching frequency and suppresses the harmonics and sub-harmonics. Spread-spectrum is very effective for reducing the overall noise peaks, but does not influence the noise floor due to the spreading of the noise, as the name suggests. However, because spread-spectrum helps with high-frequency harmonics, it can help meet the stringent original equipment manufacturer (OEM) standards for EMI, simplify printed-circuit board (PCB) designs, and reduce filtering component size and cost. The LM53625-Q1 offers a version with and without spread spectrum to provide flexible options to the customer across multiple designs and systems.

2.3.2.1.3 Antenna

This reference design includes onboard-etched antennas for the four receivers and two transmitters that enable tracking multiple objects with their distance and angle information. This antenna design utilizes the estimation of distance and elevation angle, which, in turn, enables object detection in a two-dimensional plane. [Fig 6](#) and [Fig 7](#) show the PCB antennas.



図 6. Altium Antenna Design



図 7. Antenna as Appears on PCB

The antenna peak gain is greater than 9 dBi across the operating frequency band of 76 GHz to 81 GHz. The peak output power with the antenna gain is less than 55 dBm equivalent isotropically radiated power (EIRP), as required by the European regulations. [Fig 8](#) shows the radiation pattern of the antenna in the horizontal plane (H-plane $\Phi = 0^\circ$) and elevation plane (E-plane $\Phi = 90^\circ$).

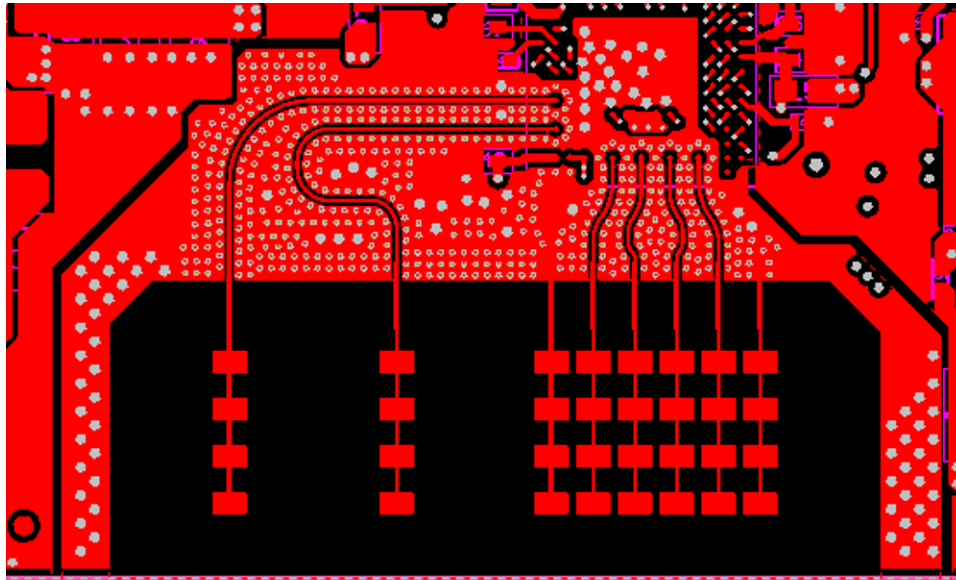

図 8. Antenna Pattern

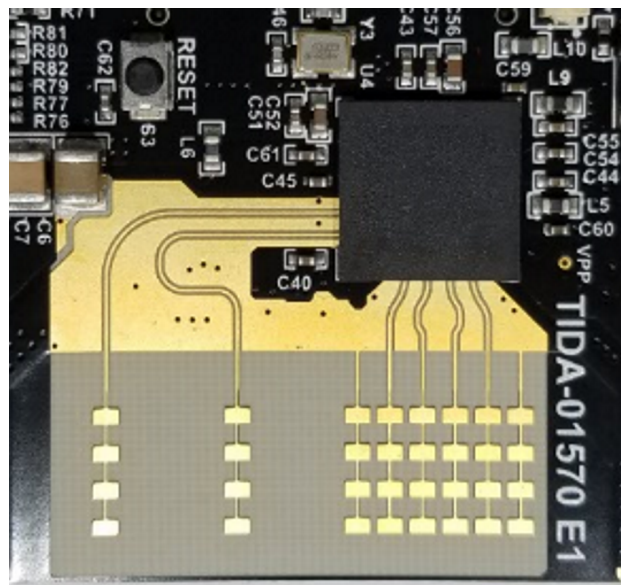
2.3.2.1.4 CAN Termination

The ISO 11898 standard specifies the interconnect as a twisted pair cable (shielded or unshielded) with 120-Ω characteristic impedance (Z_0). Resistors equal to the characteristic impedance of the line must be used to terminate both ends of the cable to prevent signal reflections. Unterminated drop lines (stubs) connecting nodes to the bus must be kept as short as possible to minimize signal reflections. The termination may be on the cable or in a node, but if nodes may be removed from the bus, the termination must be carefully placed so that two terminations always exist on the network. Termination may be a single 120-Ω resistor at the end of the bus, either on the cable or in a terminating node. If the designer wishes to filter and stabilize the common-mode voltage of the bus, then split termination may be used (see 図 9). Split termination improves the electromagnetic emissions behavior of the network.

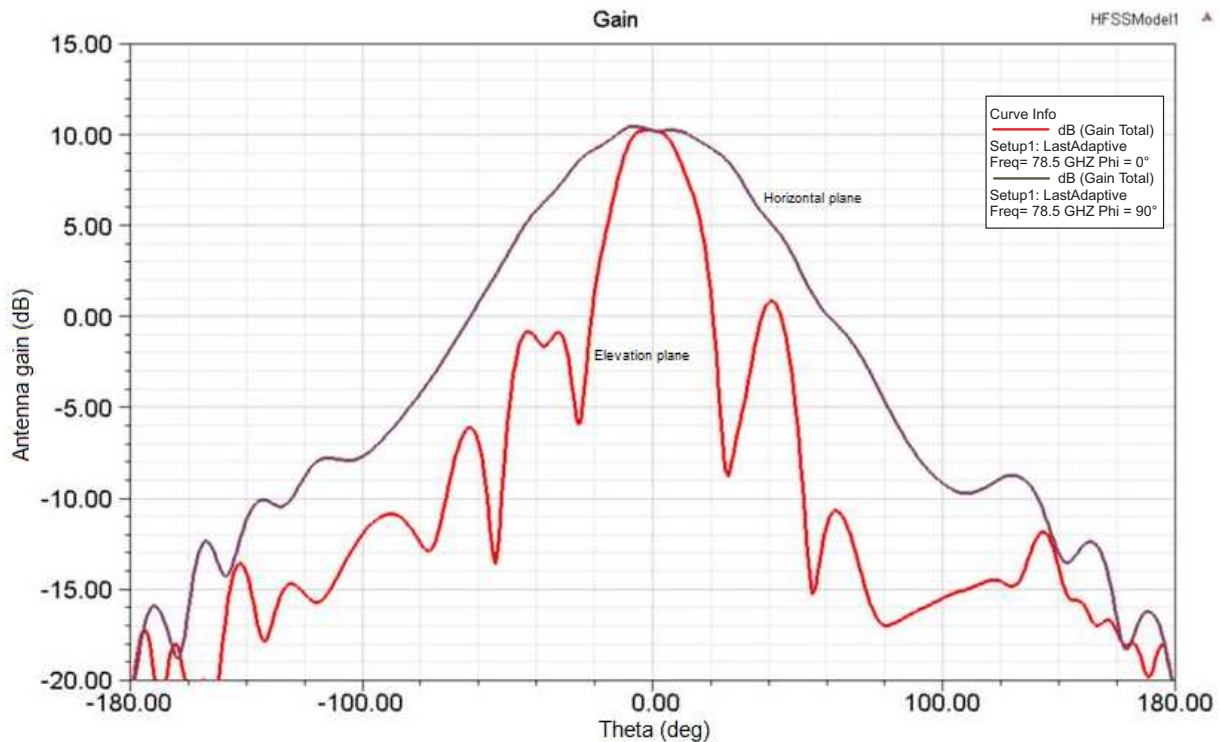
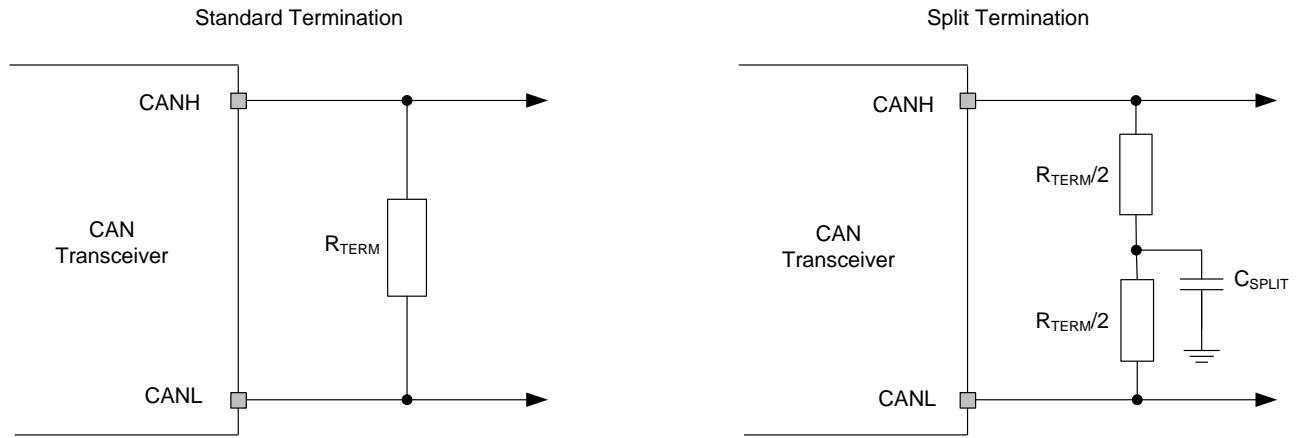

Copyright © 2016, Texas Instruments Incorporated

図 9. CAN Bus Termination Concepts

2.3.2.1.5 Board Startup

When power is first applied to the board, the TCAN4550-Q1 CAN-FD transceiver begins operation in STANDBY mode. See #1 in 図 9. The TCAN4550-Q1 then asserts 3V3_EN, allowing the LM536253-Q1 to begin operation (#2). Once the 3.3-V rail is operational, the LM536253-Q1 will assert the 3V3_PG line allowing the LP87702-Q1 to exit reset and begin operation. During startup, the LP87702-Q1 holds the AWR1642 in reset using the AWR_nRESET line until all of the power supply rails are within operating range. When the AWR1642 is released from reset, it boots and configures the TCAN4550-Q1 over I²C. This allows the TCAN4550-Q1 to begin operation in NORMAL mode and the board is up and running.

If the configuration of the TCAN4550-Q1 is not completed within a specified time, the TCAN4550-Q1 will enter SLEEP mode and de-assert the 3V3_EN line, causing the power supply to shut down. See block #7 in 図 9. Upon receiving a wake up pattern (WUP) over the CAN-FD bus, the TCAN4550-Q1 will return to STANDBY mode and assert 3V3_EN allowing the power supply to restart returning to state #1 in the diagram.

2.3.2.1.6 Diagnostics and Monitoring

For systems with additional safety requirements, diagnostic and monitoring features have been included in this reference design.

- **Window Watchdog:** The LP87702-Q1 includes a window watchdog. WDI is the watchdog function input pin and WD_RESET is the reset output. WDI pin needs to be pulsed within a certain timing window to avoid watchdog expiration. In this design, if the AWR1642 fails to pulse the WATCHDOG_INPUT net within the specified window, AWR_nWARM_RESET will be asserted to issue a warm reset command to the AWR1642. If the AWR1642 does not resume operation, then a hard reset will be issued using AWR_nRESET. The watchdog window parameters and the actions taken are fully programmable within the PMIC.
- **Voltage Monitors (VMON):** The voltage monitoring pins within the LP8770-Q1 have been connected to the VIOIN_18 and VDDIN rails for the AWR1642. In the event of an under voltage or over voltage event, this allows the PMIC to monitor these rails and using AWR_nRESET issue a hard reset to the AWR1642. These inputs are low pass filtered to eliminate ignore any short term events that would not adversely affect the operation for the AWR1642. The connection of these monitors is made directly at the

connection to the radar. This avoids the situation where the ferrite bead in the power filters could fail and not be detected. The VMON thresholds and the actions taken during an OV/UV condition are configured in the OTP of the PMIC, and are re-configurable over I2C.

- Additional Voltage Monitoring: To monitor the VIN_RF1 and VIN_RF2 rails, they are connected to ADC inputs on the AWR1642. If the rails monitored by the PMIC are functioning correctly, the AWR1642 will have enough rails for the internal ADC to monitor the RF rails. The action(s) taken by the AWR1642 are configurable in software.
- AWR1642 nERROR_OUT : This is an error signal that originates in the radar and is usually connected to a PMIC or MCU to indicate that some severe criticality fault has happened. In this design, the nERROR_OUT is connected through an inverter to the RST pin of the TUSB_4550-Q1. This causes the TCAN4550-Q1 to enter SLEEP mode and de-assert the INH pin. This is used for the 3V3_EN, and disables the LM536253-Q1. When the TUSB4550-Q1 re-enables the LM536253-Q1, this will cause the entire module to restart in the manner described above. This prevents erroneous CAN-FD transactions from being sent while the processor in the AWR1642 is in an unknown state. (if only one CAN-FD is needed, see [TIDA-01570](#))

3 Getting Started Hardware

Connect the TIDA-020004 reference design to a 12-V nominal "battery" supply using the screw terminals on J1 (see [Figure 10](#)). The object data output is available on the CAN-FD signals on J5.

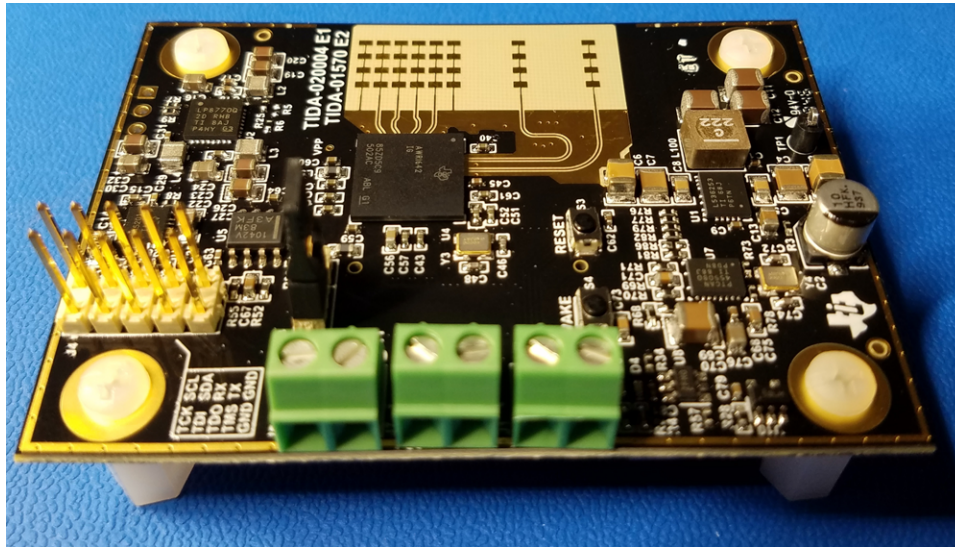

Figure 10. Getting Started With Board

3.1 AWR1642 Initialization: Board Programming

Now that the board is powered with the 12-V connection, a program must be loaded into the FLASH. This program executes each time the board boots and the AWR16 is released from RESET. TI provides a mmWave Software Development Kit (SDK). This SDK is a unified software platform for the AWR1x family of mmWave sensors, which enable evaluation and development. The use of this design environment is covered in the documentation for the mmWave SDK: [MMWAVE-DEVPACK](#) and [MMWave Demo Visualizer User's Guide](#). The following procedure is for loading a binary file.

- Use UniFlash with an FTDI cable to load the program.
- During the following procedure, the AWR1642 universal asynchronous receiver/transmitter (UART) RX/TX pins are connected to the PC through a USB cable using an FTDI cable. The specific cable used is the UART to USB: TTL-232R-RPI CABLE USB-SERIAL RASPBERRYPI. Be sure to install the correct PC drivers for the selected USB and UART cables.
- Install the UniFlash software, which is available for download at: <http://www.ti.com/tool/uniflash>. Proceed to the next step after installation.
- Move or install the jumper on J3, as [Figure 11](#) shows. This action puts the AWR16 device into "flash" mode. Connect the black (GND), yellow (RX), and orange (TX) wires of the FTDI cable to J4.



図 11. FTDI Cable Connection and J3 Setting

- Open the UniFlash software. Select *mmWave* from the *Category* header, select *AWR1642* from the field of available devices, and then click the *Start* button (see 図 12).

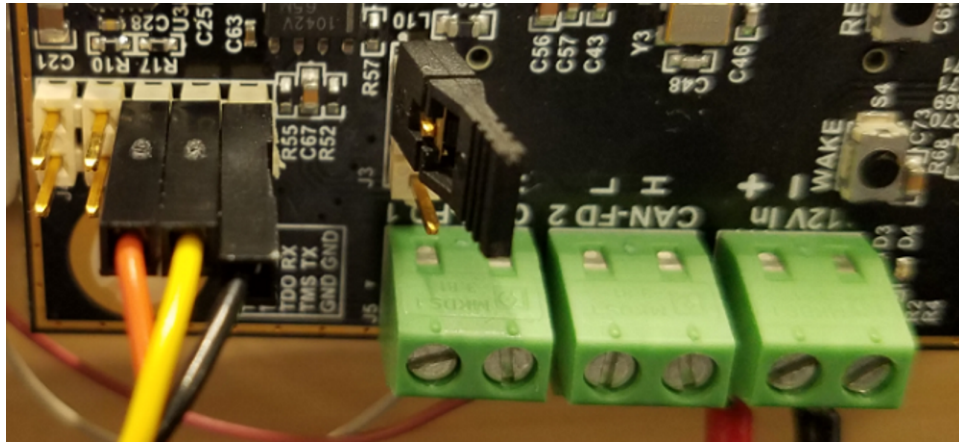

図 12. Uniflash Configuration

- Next, click the *Browse* button and navigate to the binary file to load. After the name of the file populates the field, click on the *Settings & Utilities* menu on the left side of the program (see [13](#)).

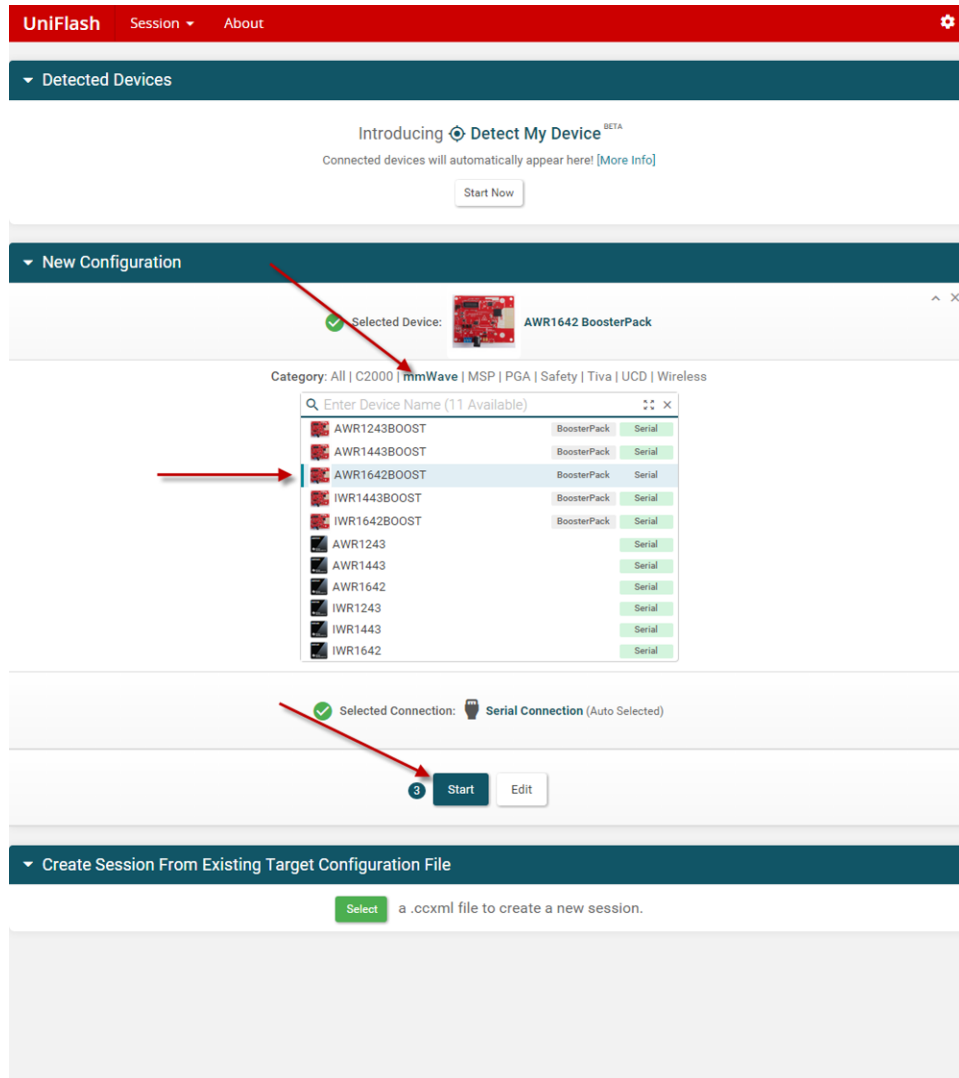
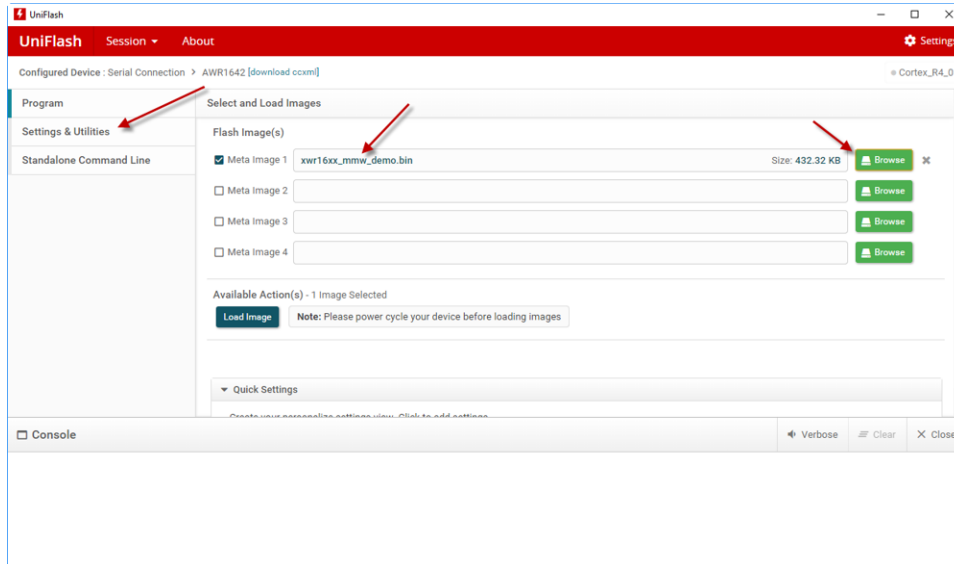

13. Uniflash Settings

- Now determine which COM port to use. After plugging the FTDI cable into a USB port, open up Windows Device Manager. Find the USB serial port and note which COM port is used to connect to the FTDI. The example in [14](#) shows this COM port to be COM3.

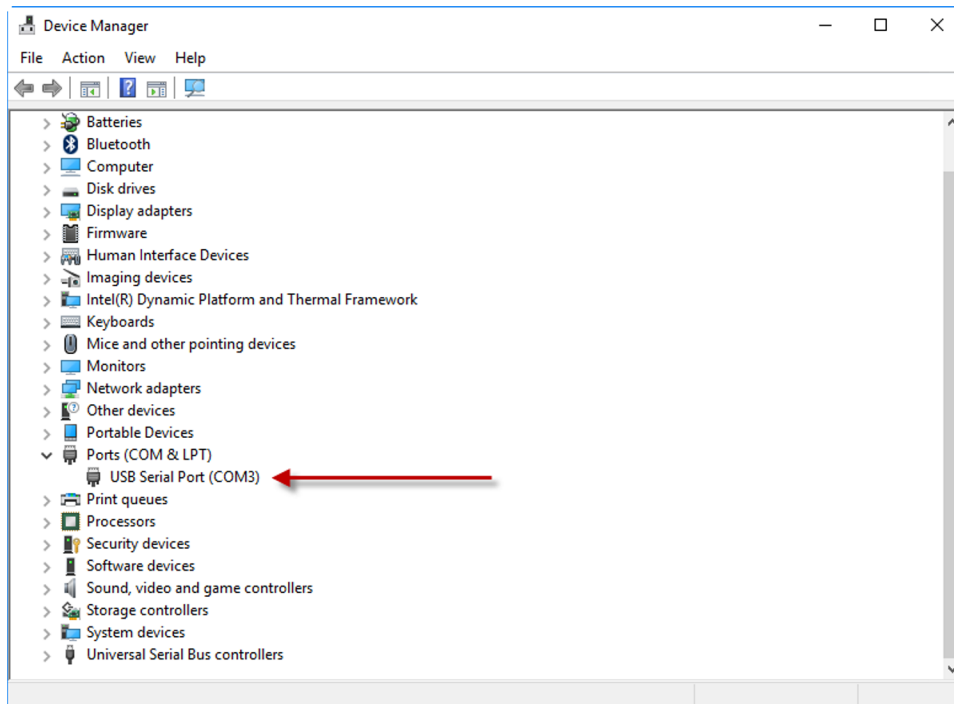

14. Determine COM Port

- Return to the UniFlash software and enter the COM port from the device manager. Then click the *Program* menu on the left side of the window to go back to the previous menu (see [Figure 15](#)).

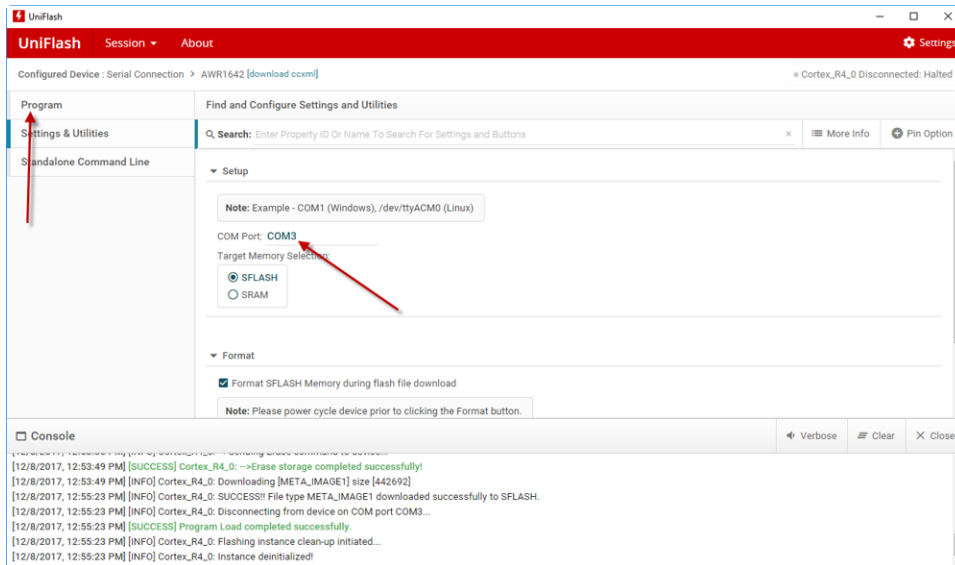

Figure 15. Enter COM Port

- Reset the ASR16 device by pressing the reset button on the board (S3). Then select *Load Image*. This action loads the program into the FLASH. To execute the program, move the jumper on J4 back to the pin 2/3 position and press the reset button. The program then runs. Note that the board draws more current from the 12-V supply.

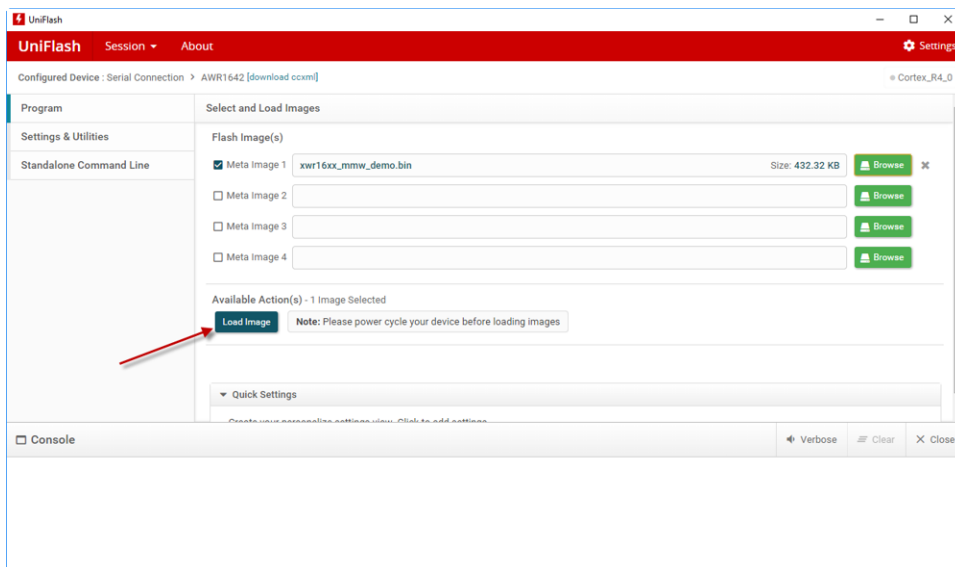

Figure 16. Load Image

3.2 Sense-on-Power (SOP) Jumpers

As the previous [図 11](#) shows, the J3 jumper is used to configure the device into FLASH programming mode. Two additional resistor dividers are used to configure the AWR1642 device at start-up. These SOP configuration options are shown at the bottom of sheet 2 of the schematic (available for download in [Schematics](#)). These lines are sensed only during boot up of the AWR device. [表 3](#) provides a description of the SOP modes. A "0" represents pulling the pin low and a "1" represents pulling the pin high.

表 3. SOP Modes

MODE	SOP2	SOP1	SOP0	MODE DESCRIPTION
1	0	0	1	Functional mode: The device bootloader loads the user application from the QSPI serial flash to the internal RAM and switches the control to it.
3	0	1	1	Debug mode: The bootloader is bypassed and the R4F processor is halted, which allows the user to connect the emulator at a known point.
5	1	0	1	Flashing mode: The device bootloader spins in a loop to allow flashing of the user application (or the device firmware patch, supplied by TI).

4 Testing and Results

4.1 Characterization Test Setup

TI has developed a PC application, TI CAN VISUALIZER, for use in demonstrating the performance of the TIDA-020004 radar sensor module. [Fig 17](#) shows a screenshot of the setup for using this application. The PC can control the module over the UART on pins N4 and N5 of the AWR1642 device. These pins are connected to pins 6 and 8 of the J4 connector. For the following examples, this UART is connected to the PC through a USB, using a FTDI cable. The CAN-FD output from the module is read into the PC using a CAN-FD to USB translator. The specific modules used here are:

- UART to USB: TTL-232R-RPI CABLE USB-SERIAL RASPBERRYPI
- CAN-FD to USB: PCAN-USB FD Adapter, IPEH-004022

To use the CAN-FD to USB adapter, connect the CAN 1_HI and CAN1_LOW pins on J5 to the appropriate pins on the adapter connector. After establishing this connection, start the PC program *PCANBasicExample.exe*. [Fig 17](#) shows the TI CAN VISUALIZER user interface. Click the *Initialize* button to begin logging the CAN data.

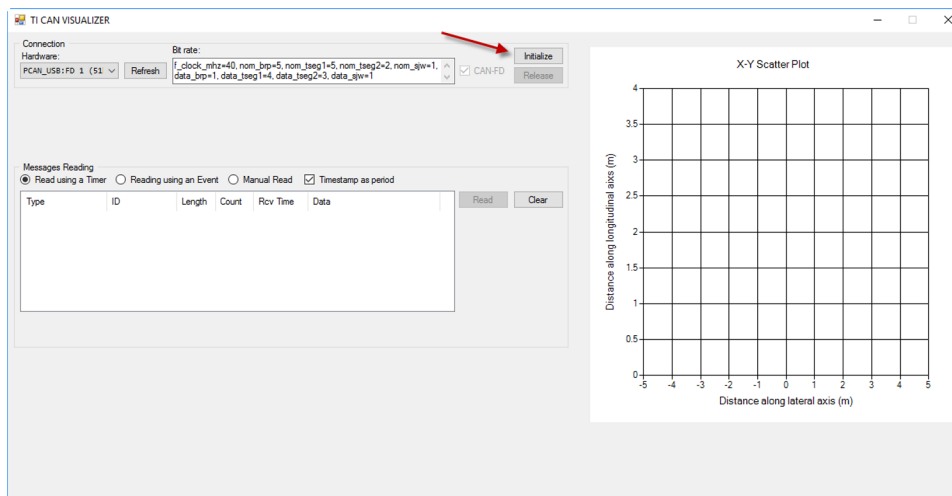

Fig 17. TI CAN VISUALIZER Start-Up

The object data that the CAN bus sends begins scrolling in the large white box (see [Fig 18](#)). The blue dots in the scatter plot represent the object information in graphical form.



図 18. TI CAN VISUALIZER Running

5 Design Files

5.1 Schematics

To download the schematics, see the design files at [TIDA-020004](#).

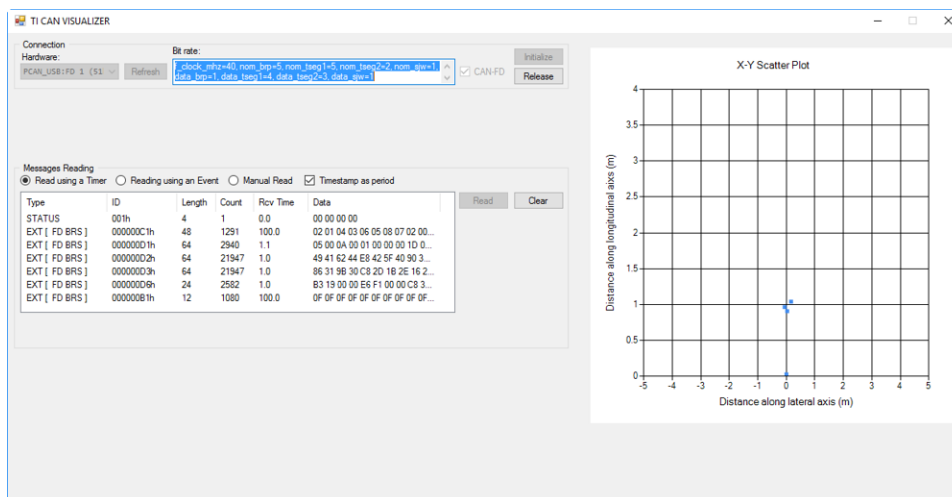
5.2 Bill of Materials

To download the bill of materials (BOM), see the design files at [TIDA-020004](#).

5.3 PCB Layout Recommendations

5.3.1 Switching DC-DC Converters

For optimal layout during placement and routing, be sure to always consider the path the current takes through the circuit.

For the main 3.3-V buck converter:

The yellow line in [Figure 19](#) shows the current path from the bulk input capacitor C2, across the ceramic input capacitors C3 and C4, and into the converter U1 or LM536253-Q1. The green line follows the 3.3-V output of the switcher to the output inductor L100 and output capacitors C10, C11, and C12. [Figure 19](#) shows how any return currents from the input capacitors or the output capacitor are joined together on the top layer and connected to the ground plane. This configuration allows much of the capacitor currents to cancel each other out in layer 1 and reduces the amount of return currents traveling in the internal ground planes, which, in turn, reduces voltage gradients in the ground plane that register as noise to other components. This optimization may not be noticeable in the performance of the converter, but it will reduce its coupled noise into other devices.



図 19. Current Paths Through Switching Converter

5.3.2 PCB Layer Stackup Recommendations

A normal FR4 board material results in unacceptable losses for the 77-GHz antenna included in the top two layers of this design. This design uses ceramic material from Rogers Corporation to meet the dielectric requirements. Additionally, the RO4000® LoPro® series of laminates from Rogers Corporation uses a reverse-treated foil for a smoother metal. This selection of material results in a lower variation in etched-feature dimensions. With wavelengths of less than 4 mm, these tolerances are very important.

☒ 20 shows the PCB layer stackup recommendations.

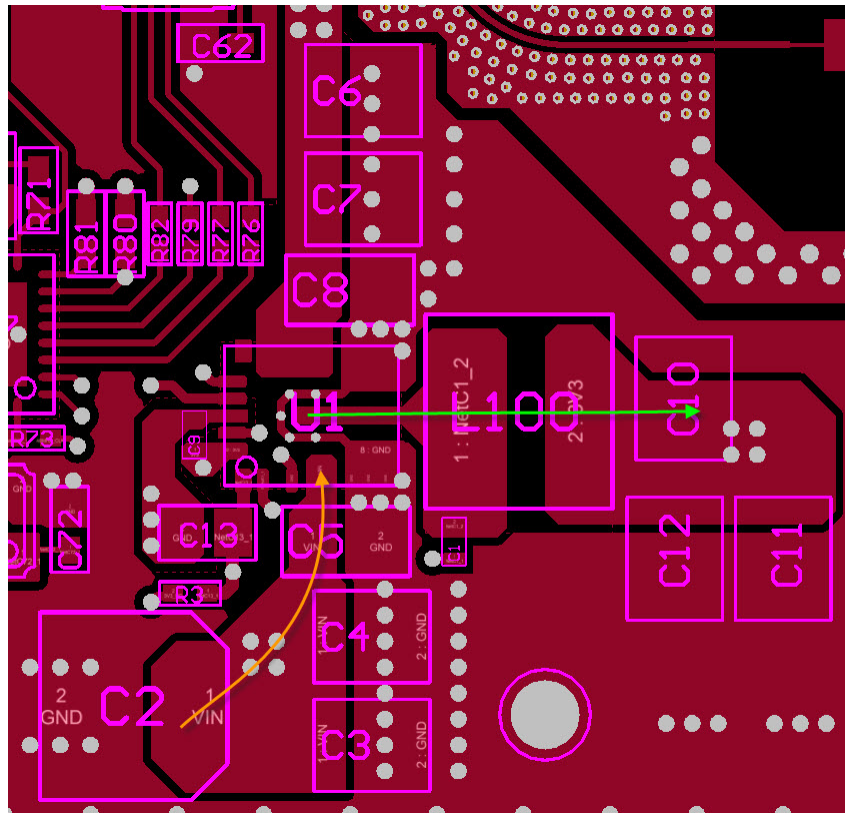
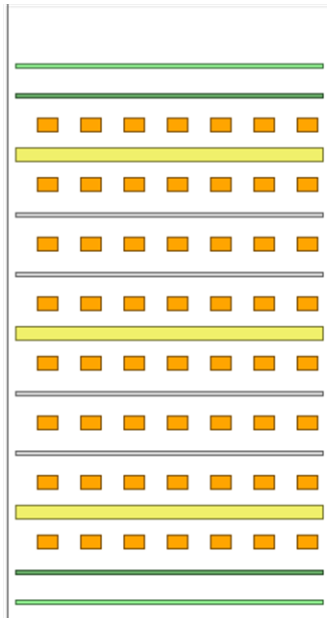

Layer Name	Type	Material	Thickness (mil)	Dielectric Material	Dielectric Constant
Top Overlay	Overlay				
Top Solder	Solder Mask/Co...	Surface Material	0.4	Solder Resist	3.5
Layer 1 - Top Layer	Signal	Copper	1.4		
Dielectric 1	Dielectric	Core	4	RO4835LowPro	3.38
Layer 2 - GND	Signal	Copper	1.4		
Dielectric 2	Dielectric	Prepreg	10	IT 180A	4.2
Layer 3 - Signal (...)	Signal	Copper	1.417		
Dielectric 3	Dielectric	Prepreg	6	IT 180A	4.2
Layer 4 - GND / ...	Signal	Copper	1.417		
Dielectric 4	Dielectric	Core	10	IT 180A	4.2
Layer 5 - Signal	Signal	Copper	1.417		
Dielectric 5	Dielectric	Prepreg	6	IT 180A	4.2
Layer 6 - GND	Signal	Copper	1.417		
Dielectric 6	Dielectric	Prepreg	10	IT 180A	4.2
Layer 7 - PWR / ...	Signal	Copper	1.4		
Dielectric 7	Dielectric	Core	4	IT 180A	4.2
Layer 8 - Bottom...	Signal	Copper	1.4		
Bottom Solder	Solder Mask/Co...	Surface Material	0.4	Solder Resist	3.5
Bottom Overlay	Overlay				

☒ 20. Layer Stackup

5.3.3 Layout Prints

To download the layer plots, see the design files at [TIDA-020004](#).

5.4 Altium Project

To download the Altium project files, see the design files at [TIDA-020004](#).

5.5 Gerber Files

To download the Gerber files, see the design files at [TIDA-020004](#).

6 Related Documentation

1. Texas Instruments, [Moving from legacy 24 GHz to state-of-the-art 77 GHz radar](#)
2. Texas Instruments, [Short-Range Radar \(SRR\) Reference Design Using AWR1642](#)
3. Texas Instruments, [AWR1642 mmWave sensor: 76-81-GHz radar-on-chip for short-range radar applications](#)
4. Texas Instruments, [TI's smart sensors ideal for automated driving applications](#)
5. Texas Instruments, [The fundamentals of millimeter wave sensors](#)

6.1 商標

ARM, Cortex are registered trademarks of ARM Ltd.
RO4000, LoPro are registered trademarks of Rogers Corporation.
すべての商標および登録商標はそれぞれの所有者に帰属します。

7 Third-Party Products Disclaimer

TI'S PUBLICATION OF INFORMATION REGARDING THIRD-PARTY PRODUCTS OR SERVICES DOES NOT CONSTITUTE AN ENDORSEMENT REGARDING THE SUITABILITY OF SUCH PRODUCTS OR SERVICES OR A WARRANTY, REPRESENTATION OR ENDORSEMENT OF SUCH PRODUCTS OR SERVICES, EITHER ALONE OR IN COMBINATION WITH ANY TI PRODUCT OR SERVICE.

重要なお知らせと免責事項

TI は、技術データと信頼性データ(データシートを含みます)、設計リソース(リファレンス・デザインを含みます)、アプリケーションや設計に関する各種アドバイス、Web ツール、安全性情報、その他のリソースを、欠陥が存在する可能性のある「現状のまま」提供しており、商品性および特定目的に対する適合性の黙示保証、第三者の知的財産権の非侵害保証を含むいかなる保証も、明示的または黙示的にかかわらず拒否します。

これらのリソースは、TI 製品を使用する設計の経験を積んだ開発者への提供を意図したものです。(1) お客様のアプリケーションに適した TI 製品の選定、(2) お客様のアプリケーションの設計、検証、試験、(3) お客様のアプリケーションが適用される各種規格や、その他のあらゆる安全性、セキュリティ、またはその他の要件を満たしていることを確実にする責任を、お客様のみが単独で負うものとします。上記の各種リソースは、予告なく変更される可能性があります。これらのリソースは、リソースで説明されている TI 製品を使用するアプリケーションの開発の目的でのみ、TI はその使用をお客様に許諾します。これらのリソースに関して、他の目的で複製することや掲載することは禁止されています。TI や第三者の知的財産権のライセンスが付与されている訳ではありません。お客様は、これらのリソースを自身で使用した結果発生するあらゆる申し立て、損害、費用、損失、責任について、TI およびその代理人を完全に補償するものとし、TI は一切の責任を拒否します。

TI の製品は、TI の販売条件 (www.tij.co.jp/ja-jp/legal/termsofsale.html)、または ti.com やかかる TI 製品の関連資料などのいずれかを通じて提供する適用可能な条項の下で提供されています。TI がこれらのリソースを提供することは、適用される TI の保証または他の保証の放棄の拡大や変更を意味するものではありません。

Copyright © 2019, Texas Instruments Incorporated
日本語版 日本テキサス・インスツルメンツ株式会社

重要なお知らせと免責事項

TI は、技術データと信頼性データ(データシートを含みます)、設計リソース(リファレンス・デザインを含みます)、アプリケーションや設計に関する各種アドバイス、Web ツール、安全性情報、その他のリソースを、欠陥が存在する可能性のある「現状のまま」提供しており、商品性および特定目的に対する適合性の黙示保証、第三者の知的財産権の非侵害保証を含むいかなる保証も、明示的または黙示的にかかわらず拒否します。

これらのリソースは、TI 製品を使用する設計の経験を積んだ開発者への提供を意図したものです。(1) お客様のアプリケーションに適した TI 製品の選定、(2) お客様のアプリケーションの設計、検証、試験、(3) お客様のアプリケーションが適用される各種規格や、その他のあらゆる安全性、セキュリティ、またはその他の要件を満たしていることを確実にする責任を、お客様のみが単独で負うものとします。上記の各種リソースは、予告なく変更される可能性があります。これらのリソースは、リソースで説明されている TI 製品を使用するアプリケーションの開発の目的でのみ、TI はその使用をお客様に許諾します。これらのリソースに関して、他の目的で複製することや掲載することは禁止されています。TI や第三者の知的財産権のライセンスが付与されている訳ではありません。お客様は、これらのリソースを自身で使用した結果発生するあらゆる申し立て、損害、費用、損失、責任について、TI およびその代理人を完全に補償するものとし、TI は一切の責任を拒否します。

TI の製品は、TI の販売条件 (www.tij.co.jp/ja-jp/legal/termssofsale.html)、または ti.com やかかる TI 製品の関連資料などのいずれかを通じて提供する適用可能な条項の下で提供されています。TI がこれらのリソースを提供することは、適用される TI の保証または他の保証の放棄の拡大や変更を意味するものではありません。

Copyright © 2019, Texas Instruments Incorporated

日本語版 日本テキサス・インスツルメンツ株式会社