

デザイン・ガイド: TIDEP-01013 ミリ波センサと Sitara™ プロセッサを搭載したジェスチャ制御 HMI のリファレンス・デザイン



概要

このリファレンス・デザインでは、AM335x Sitara™ プロセッサおよび IWR6843 ミリ波センサによる自然なジェスチャ認識と存在検出を紹介します。このリファレンス・デザインでは、ジェスチャ制御のヒューマン・マシン・インターフェイス (HMI) 機能を実証します。この HMI 機能では、ミリ波センサが存在を検出して手による自然なジェスチャを分類し、AM335x Sitara™ プロセッサに送ります。Sitara プロセッサはその情報を使用して、Linux® で動作するグラフィカル・ユーザー・インターフェイス (GUI) アプリケーションを駆動します。このリファレンス・デザインには、先進のプロセッサ・システム・オン・チップ (SoC) とセンサが統合されており、組み込み用のジェスチャ制御 HMI を構成しています。

リソース

TIDEP-01013	デザイン・フォルダ
IWR6843	プロダクト・フォルダ
IWR6843ISK-ODS	ツール・フォルダ
AM335x	プロダクト・フォルダ
BeagleBone Black	プロダクト・フォルダ
プロセッサ SDK Linux AM335x	ツール・フォルダ
mmWAVE-SDK	ツール・フォルダ

特長

- ジェスチャ制御の HMI
- 存在に加えて、左から右、上から下へのスワイプなど、複数のスワイプ・ジェスチャを認識
- 処理能力を備えた TI のシングルチップ 60~64 GHz インテリジェント・ミリ波センサ・テクノロジーを利用して、低コストの BeagleBone Black 上で動作
- GUI に Qt フレームワークを利用
- プロセッサ SDK-Linux およびミリ波 SDK の一部として保守

アプリケーション

- ビルディング・オートメーション
- 家電製品
- 医療用

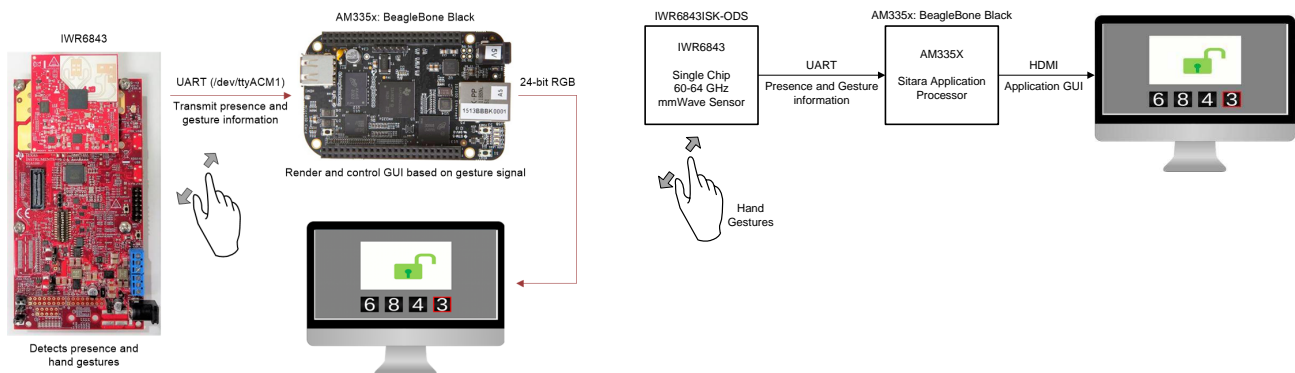
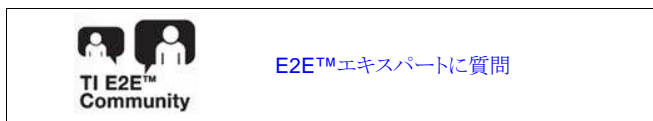

使用許可、知的財産、その他免責事項は、最終ページにあるIMPORTANT NOTICE (重要な注意事項)をご参照くださいますようお願いいたします。

1 System Description

Human Machine Interfaces (HMIs) provide users with a graphical way to interact with technological devices. Traditional HMIs use buttons or a touch screen which requires users to physically touch the device, but there may be cases where a physical touch is undesirable. For example, hands may get messy while cooking in the kitchen and leave food on appliances and other surfaces. A gesture-controlled oven or cooking hood would reduce the amount of unnecessary contact.

Gesture-controlled interfaces could also work in several medical situations. Sterile hands can use gestures to swipe between patient information, like x-rays and other test results. This can reduce the chances of spreading bacteria in a clean environment.

Additionally, gesture-controlled interfaces could work in building automation systems in the home or at the office. A smart thermostat could increase the temperature from a distance by recognizing an upward-swipe. This makes it more convenient than constantly walking up to the thermostat to make adjustments.

This TI reference design showcases a gesture-controlled HMI leveraging hardware and software components from Texas Instruments (TI); specifically, Linux®-based application processing with the AM335x Sitara™ processors and gesture recognition and presence detection with mmWave radar sensors.

Based on Frequency Modulated Continuous Wave (FMCW) radar technology, the IWR6843 single-chip mmWave sensor accurately senses distance, velocity, and angle of arrival of objects in front of it. Using on-chip signal processing, the sensor returns a point cloud of the scene with the range, velocity, and angle information associated with each point.

In this application, the range, velocity and angle information in the point cloud are used for two purposes:

1. **Presence detection:** Using a configuration which is sensitive to very fine motion (such as, human breathing, typing, arm movement, and so forth), the application running on the sensor signals presence detected or not-detected within a configured range.
2. **Gesture detection and classification:** The velocity and angle information in the point cloud is processed by a hand-trained neural network (running on the on-chip DSP core) to detect and classify different gestures.

The complete point cloud processing and gesture classification is performed on the IWR6843 single-chip mmWave sensor and the presence and classified gesture information is sent to the AM335x Sitara™ Evaluation Module (EVM) over UART, which runs the gesture Graphics user Interface (GUI) application under Linux®.

The AM335x Sitara™ processor is one of the most popular processors for HMI applications. It not only has the resources targeted for processing the user interface of an HMI application, but also its easy-to-use programming tools and portfolio of on-chip capabilities give designers a head start on HMI project development.

Based on the IWR6843 EVM and AM335x BeagleBone Black (BBB) board, this reference design is a quick starting point for customers who want to design a gesture-based HMI module or system.

The TI AM335x high-performance processors are based on the Arm® Cortex®-A8 core (see [Figure 3](#)). These enhanced processors have rich peripherals and an advanced display capability, including 2-D and 3-D acceleration, to help customers design cost-effective HMIs. The devices support High-Level Operating Systems (HLOS) such as Linux, which is available free of charge from TI. The devices offer an upgrade to systems based on lower-performance Arm cores, provide updated peripherals, and support the typical interfaces to connect to the mmWave sensor (for example, UART).

The AM335x supports 24-bit, Liquid-Crystal Display (LCD) controllers with a resolution up to 2048 × 2048, which allows system designers to select various screen sizes and resolutions based on use cases along with provides scalability from low- to mid-end.

1.1 Key System Specifications

The key system devices used in this TI reference design includes the AM335x processor and the IWR6843 mmWave sensor.

1.1.1 AM335x Processor

The AM335x is highly-integrated, pin-compatible, scalable, Sitara™ class processor. It has single-core Arm® Cortex®-A8 core and is enhanced with image, graphics processing, peripherals, and industrial interface options, such as EtherCAT® and PROFIBUS®. The devices support High-Level Operating Systems (HLOS). The Processor Software Development Kit (SDK) Linux® and TI-RTOS are available free of charge from TI. The AM335x is designed for embedded applications including HMI.

The AM335x processor contains the subsystems as shown in [Figure 1](#).

Figure 1. AM335x Processor Block Diagram

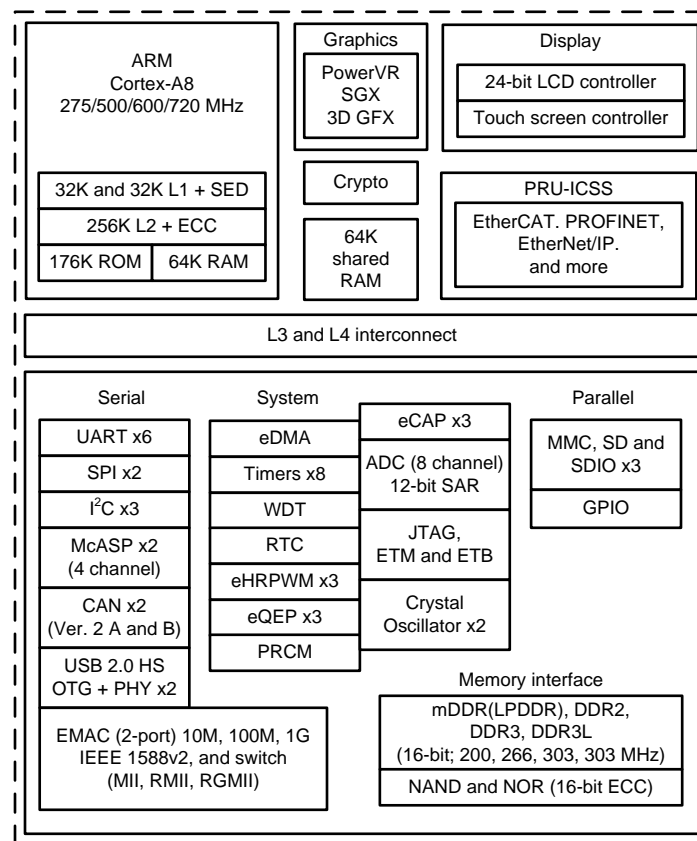

The microprocessor unit (MPU) subsystem is based on the Arm® Cortex®-A8 processor and the PowerVR SGX™ Graphics Accelerator subsystem provides 3D graphics acceleration to support display and gaming effects.

The Programmable Real-Time Unit Subsystem and Industrial Communication SubSystem (PRU-ICSS) is separate from the Arm core and allows independent operation and clocking for greater efficiency and flexibility. The PRU-ICSS enables additional peripheral interfaces and real-time protocols, such as EtherCAT®, PROFINET®, EtherNet/IP™, PROFIBUS, Ethernet Powerlink™, Sercos™, and others.

Additionally, the programmable nature of the PRU-ICSS, along with its access to pins, events, and all system-on-chip (SoC) resources, provides flexibility in implementing fast, real-time responses, specialized data handling operations, custom peripheral interfaces, and in offloading tasks from the other processor cores of an SoC.

1.1.2 IWR6843 mmWave Sensor

The IWR6843 device is an integrated single-chip mmWave sensor based on FMCW radar technology capable of operation in the 60-to 64-GHz band. The device is built with a Texas Instruments (TI) low power 45-nm RFCMOS process, and this solution enables unprecedented levels of integration in an extremely small form factor. The IWR6843 is an ideal solution for low-power, self-monitored, ultra-accurate radar systems in industrial applications (such as, building automation, factory automation, drones, material handling, traffic monitoring, and surveillance).

Key features of the IWR6843: (see [Figure 2](#))

- FMCW transceiver:
 - Integrated PLL, transmitter, receiver, baseband, and A2D
 - 60- to 64-GHz coverage with 4-GHz continuous bandwidth
 - Four receive channels
 - Three transmit channels
 - Ultra-accurate chirp engine based on Fractional-N PLL
 - TX power: 10 dBm
 - RX noise figure: 14 dB
 - Phase noise at 1 MHz: -92 dBc/Hz
- Built-in calibration and self-test:
 - Arm® Cortex®-R4F-Based Radio Control System (RCS)
 - Built-in firmware (ROM)
 - Self-calibrating system across frequency and temperature
- On-chip programmable core for embedded-user application:
 - Integrated Arm® Cortex®-R4F microcontroller clocked at 200 MHz
 - On-Chip boot loader supports autonomous mode (Loading User application from QSPI Flash memory)
- Integrated peripherals:
 - Internal memories with ECC
 - Radar hardware accelerator (FFT, Filtering, and CFAR processing)
 - I2C–two SPI ports
 - CAN-FD interface
 - Up to six general-purpose Analog-to-Digital Converter (ADC) ports

図 2. IWR6843 mmWave Sensor Functional Block

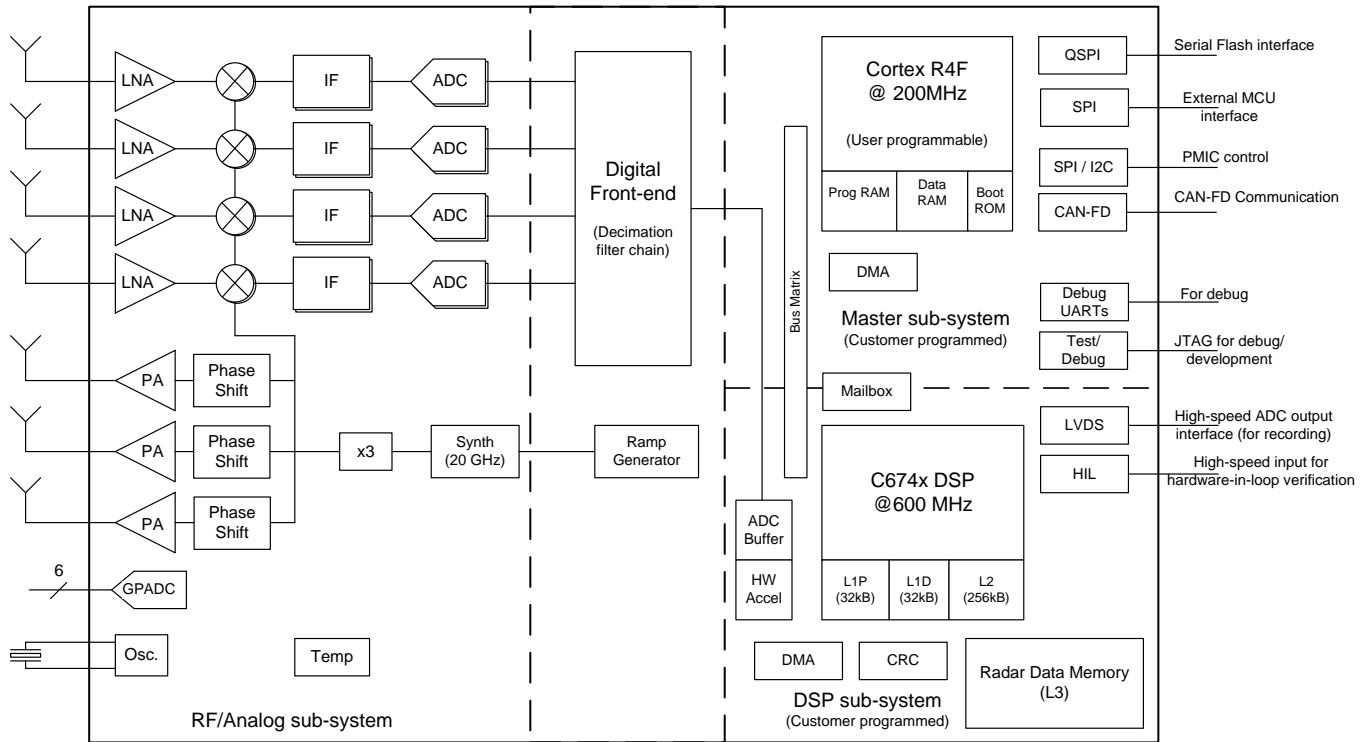

2 System Overview

2.1 Block Diagram

図 3. TIDEP-01013 Block Diagram

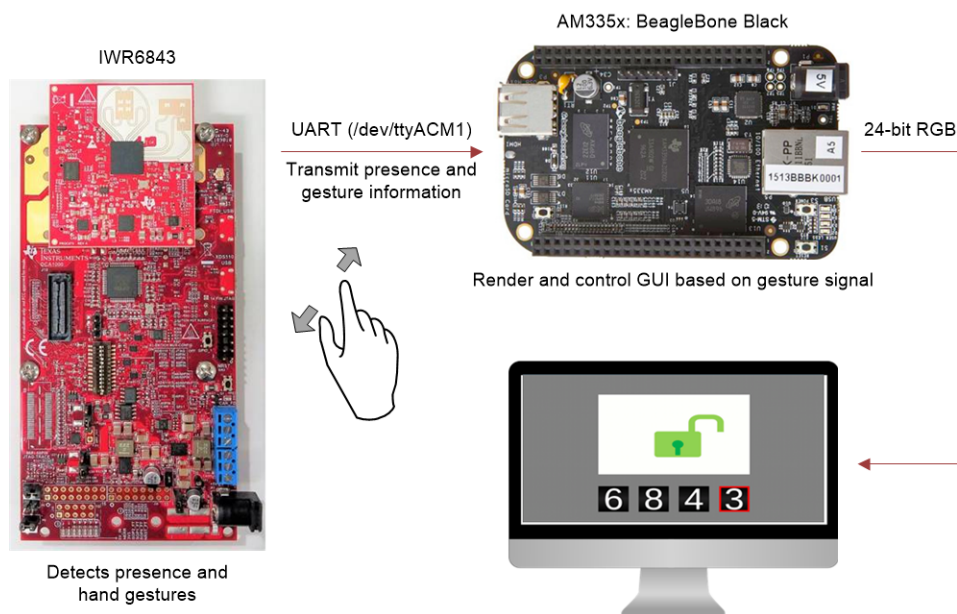

2.2 Design Considerations

TI's Processor SDK Linux provides a fundamental software platform for developing embedded applications on a TI Sitara™ processor running Linux. For the gesture-controlled HMI application, the AM335x BBB connects to the mmWave sensor over the UART. The mmWave sensor implements the presence detection and gesture recognition. While the AM335x BBB renders the HMI display and controls it per the gesture it receives over the UART from the mmWave sensor.

2.2.1 mmWave Sensor Chirp Design

For a general understanding of FMCW radar technology, TI mmWave sensors and FMCW processing chain (range, velocity, and angle of arrival), see the [mmWave Training Series](#). The gesture demo processing chain consists of Range (1D FFT), Doppler (2D FFT), CFAR and Angle of Arrival (azimuth and elevation). After this, a series of feature-vectors are computed which are passed through a small ANN (neural network) to infer gestures.

The demo also implements presence detection which detects if there is movement in front of the Radar within a configured range. This is done by thresholding the sum of energy in non-zero Doppler bins. The region in front of the radar is divided into four successive ranges and the energy is computed for each of these ranges separately. Using the energy sum for each range, the sensor is able to ascertain (coarsely) at what range the movement is taking place. Some amount of hysteresis is also added to prevent the presence detection output from changing too rapidly.

For this design, a hard-coded chirp design is used so the IWR6843 device immediately starts sensing on power-up without waiting for any communication from the host. The parameters for this chirp design were selected to detect relatively slow moving objects, such as, the hand motion for a swipe gesture. Hence this design has a fine range resolution (~5 cm), low maximum velocity (6 m/sec), and a high-velocity resolution (0.1 m/s). While the IWR6843 has three transmitters, only two of them are utilized in a TDM-MIMO fashion during a frame.

The application-level parameters used in this reference design are listed in [表 1](#) and [表 2](#).

表 1. Application-Level Parameters

Parameter	Value
Range Resolution	5 cm
Maximum Velocity	6 m/sec
Velocity Resolution	0.1 m/sec

The most important parameter for gesture recognition is velocity resolution. Having a high-velocity resolution helps distinguish fine movements, and resolve slow moving objects in the velocity dimension. Once these points are resolved in velocity, estimating the range, azimuthal angle, and elevation angle becomes simpler. Hence, the chirp design for this reference design is optimized for velocity resolution. [表 2](#) lists the chirp parameters configured on the device to achieve the application parameters listed in [表 1](#).

表 2. Chirp Parameters

Parameter	Value
Start Frequency	60.5 GHz
Ramp Bandwidth	2.9 GHz
Ramp Slope	103 MHz/μs
ADC Start Time	6 μs
Sampling Rate	2.35 Msps

表 2. Chirp Parameters (continued)

Parameter	Value
Chirp Cycle Time (Tc)	210 μ s
Number of Chirps	256
Frame Rate	33 FPS
No. of TX Channels used	2
No. of RX Channels used	4

2.2.2 AM335x Sitara™ processor HMI application

To design a GUI for HMI applications, there can be many choices like using Qt or GTK+ tools or directly programming the graphics accelerator (if using one) using the OpenGL APIs. Processor SDK Linux has integrated both Qt and GTK+ toolkit to enable the development of HMI applications.

This reference design uses Qt to develop the GUI. Qt is a cross-platform toolkit popular for creating GUIs and is the default tool in Processor SDK Linux to demonstrate the HMI application on Sitara Processors. The GUIs developed using Qt can be rendered using hardware graphics accelerator or they can also be rendered using software running on the host Arm processor. This is all taken care by the Qt back-end plugins called as Qt Platform Abstraction (QPA). Learn more about Qt at <https://www.qt.io>.

As shown in [Figure 3](#), the mmWave sensor on IWR6843 EVM detects the presence and hand gestures of the human being. The presence and classified gesture information is sent to the AM335x BBB over the UART. The serial port reader thread (inside the gesture-based HMI demonstration application running on Linux) reads the serial data as they become available and controls the HMI using the information it received.

2.3 Highlighted Products

This reference design leverages the mmWave EVM and the AM335x BeagleBone Black (BBB). The mmWave sensing is carried out with the IWR6843 Industrial Starter Kit (ISK)-ODS mounted on an MMWAVEICBOOST board.

2.3.1 IWR6843ISK-ODS antenna plug-in module

IWR6843ISK-ODS is an easy-to-use mmWave sensor evaluation kit with an on-board antenna that provides wide field of view and uniform angular resolution in azimuth and elevation. The module enables direct connectivity to the mmWave sensor card carrier (MMWAVEICBOOST) and enables access to point-cloud data through a USB interface, and raw ADC data through a 60-pin high-speed connector (see [Figure 4](#)).

Key features of the IWR6843ISK-ODS:

- 60- to 64-GHz mmWave sensor
- 4 receive (RX) 3 transmit (TX) antenna with 120° azimuth Field-of-View (FoV) and 120° elevation FoV
- Direct interface with MMWAVEICBOOST
- Supports 60-pin high-speed interface for host-controlling interface

図 4. IWR6843ISK-ODS Board View

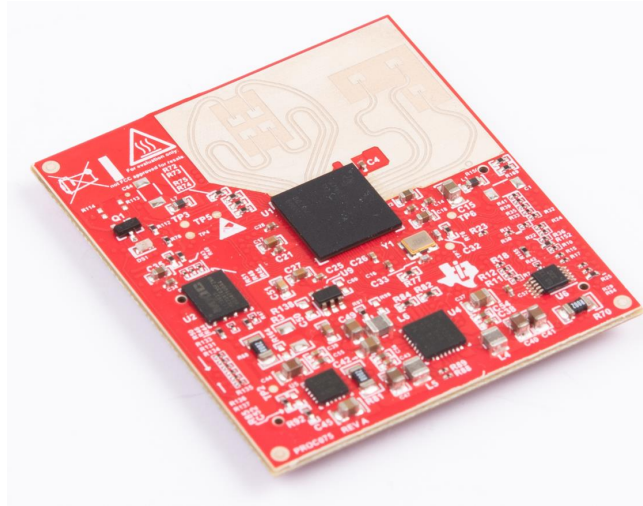

2.3.2 MMWAVEICBOOST carrier card platform

The MMWAVEICBOOST carrier card platform enables rapid evaluation of an mmWave sensor by providing modular interface to various sensor and antenna kits, for example, the IWR6843ISK-ODS antenna plug-in module (see 2.3.1). This carrier card enables debug, emulation, and direct interface to the mmWave tools through USB connectivity. Raw ADC data capture can be enabled by pairing with a DCA1000EVM real-time data capture adapter, a C67x DSP core, and low-power Arm-R4F controllers.

Key features of the MMWAVEICBOOST:

- Modular connectivity to mmWave antenna plug-in modules (for example, IWR6843ISK-ODS)
- BoosterPack™ plug-in module interface
- Debug and emulation through onboard XDS110
- Compatible with mmWave studio (MMWAVE-STUDIO) tools, including mmWave demo visualizer (MMWAVE-DEMO-VISUALIZER)

Figure 5 shows the IWR6843ISK-ODS board connected to the MMWAVEICBOOST as used in this reference design. This combined setup is referred to as the mmWave EVM kit throughout this document.

Figure 5. mmWave EVM: MMWAVEICBOOST + IWR6843ISK-ODS

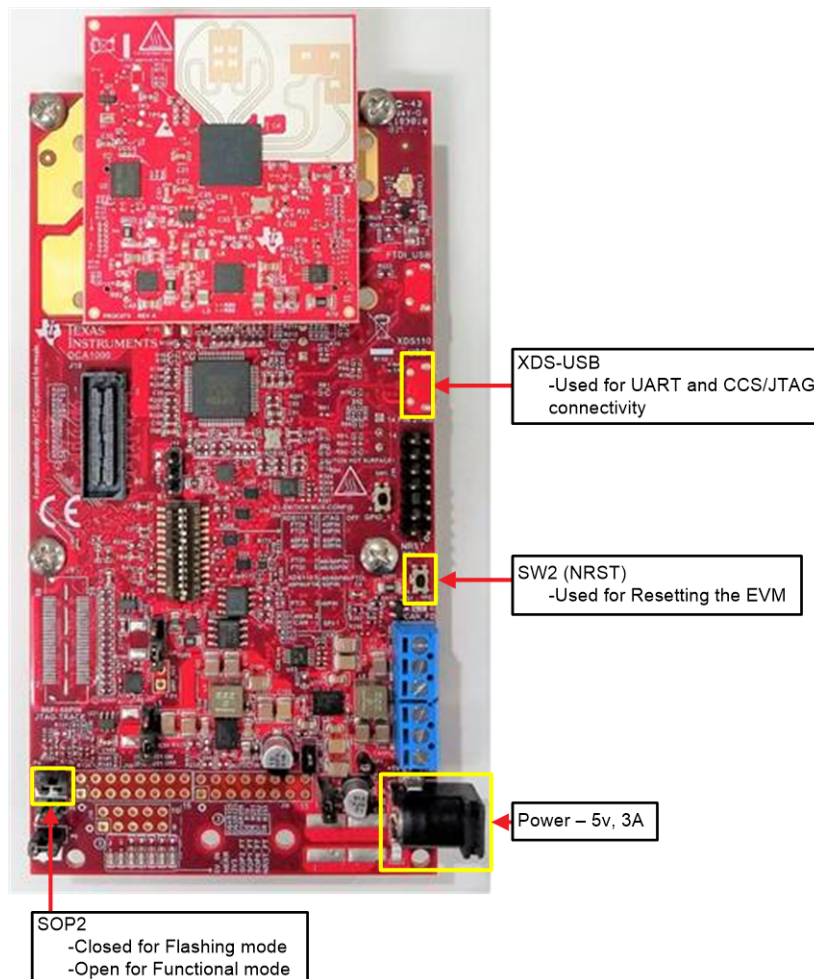

2.3.3 AM335x BeagleBone Black (BBB)

The AM335x BeagleBone Black (BBB) is a low-cost, community-supported development platform for developers and hobbyists. Boot Linux in under 10 seconds and get started on development in less than 5 minutes with just a single USB cable.

For more information, or to purchase a BBB from a vendor, see <http://www.beagleboard.org/black>.

3 Hardware, Software, Testing Requirements, and Test Results

3.1 Required Hardware and Software

This section provides the full list of hardware components required to build the presence detection and gesture recognition reference design. It also lists the software components required that need to be installed on the mmWave EVM and the AM335x BBB.

3.1.1 Hardware

The following hardware setup is needed to run the presence detection and gesture recognition reference design:

- AM335x BBB with micro SD card (at least 16 GB)
- IWR6843ISK-ODS module
- MMWAVEICBOOST board
- USB to microUSB cable: used for connecting the AM335x BBB to the mmWave EVM
- Standard FTDI-to-TTL debug cable (to connect BBB with a host machine using a serial connection) [see [Figure 6](#)]
- One micro HDMI cable
- One HDMI monitor
- Two 5-V, 3-A power supplies, one each for the AM335x BBB and mmWave EVM with 2.1-mm barrel plug (center positive).

Figure 6. Standard FTDI-to-TTL Debug Cable



3.1.2 Software

3.1.2.1 AM335x BBB

The gesture-based HMI demonstration application using the mmWave sensor is included in the AM335x BBB Processor SDK for Linux (PLSDK) starting from version 05.02.00.10. Download the [latest version](#), and refer to [Processor SDK Linux Getting Started Guide](#) to get started with the Processor SDK Linux, and create an SD card with PLSDK filesystem.

3.1.2.2 IWR6843 mmWave EVM

To download the presence detection and gesture classification application software for the mmWave EVM, see the software link at [TIDEP-01013](#). To get the latest version of the software, refer to the [mmWave Gesture Software](#).

Download the Multiple Gesture and Motion Detection lab package from [TIDEP-01013](#). To setup the IWR6843 mmWave EVM and flash the gesture application binary, follow the instructions provided in the user's guide at the following location:

```
[INSTALL_PATH]\lab\lab0023_multi_gesture_and_motion_det_68xx\docs
```

3.2 Testing and Results

This section provides details of the hardware and software setup for running the gesture-based HMI demonstration. Step-by-step testing procedures and results are also provided.

3.2.1 Test Setup

This subsection provides details of the test setup with the required hardware and software to run the gesture-based HMI application.

図 7. mmWave EVM Orientation



図 8. TIDUEP01013 Gesture HMI Hardware Setup

1. Follow the instructions provided in the `multi_gesture_and_motion_detection` lab user's guide (downloaded in [3.1.2.2](#)) to setup the IWR6843 mmWave sensor EVM and flash the lab binary onto it.
2. Mount the mmWave EVM in the orientation shown in (see [図 7](#)).
3. Follow the instructions outlined in [3.1.2.1](#), *AM335x BBB* to create a bootable microSD card with PLSDK image for the BBB.
4. Insert the now bootable microSD card into the BBB microSD card slot. (see [図 8](#)).
5. Connect the XDS110-USB port on the IWR6843 mmWave EVM to the BBB USB port using the micro USB cable.
6. Connect the HDMI monitor to the BBB using the micro HDMI cable (see [図 8](#)).
7. Connect the 5-V, 3-A power supply to the IWR6843 mmWave EVM and press the SW2 (NRST) switch.
8. Connect the BBB to the host computer (PC) using the FTDI-to-TTL debug cable.
9. While keeping S2 (boot button) on BBB board pressed, connect the 5-V power supply and release the S2 (switch), once the 5-V power supply is connected. This is required to boot up the BBB from the microSD card.
10. The BBB board should boot up and the Matrix GUI application should be seen on the screen (see [図 9](#)) (*the Matrix GUI to Start takes a few minutes*)
11. Open the BBB COM port in TeraTerm or any other terminal emulation software and login as root (*no password*).
12. Stop the Matrix GUI application and Weston scripts on the BBB board using the following command:

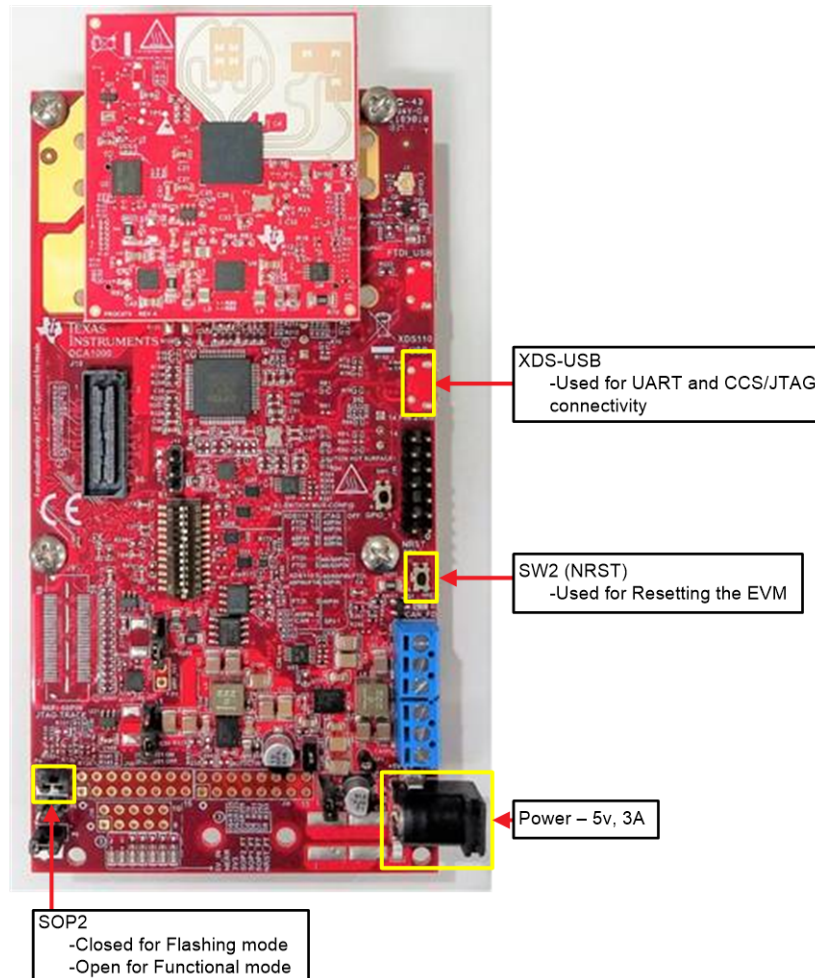
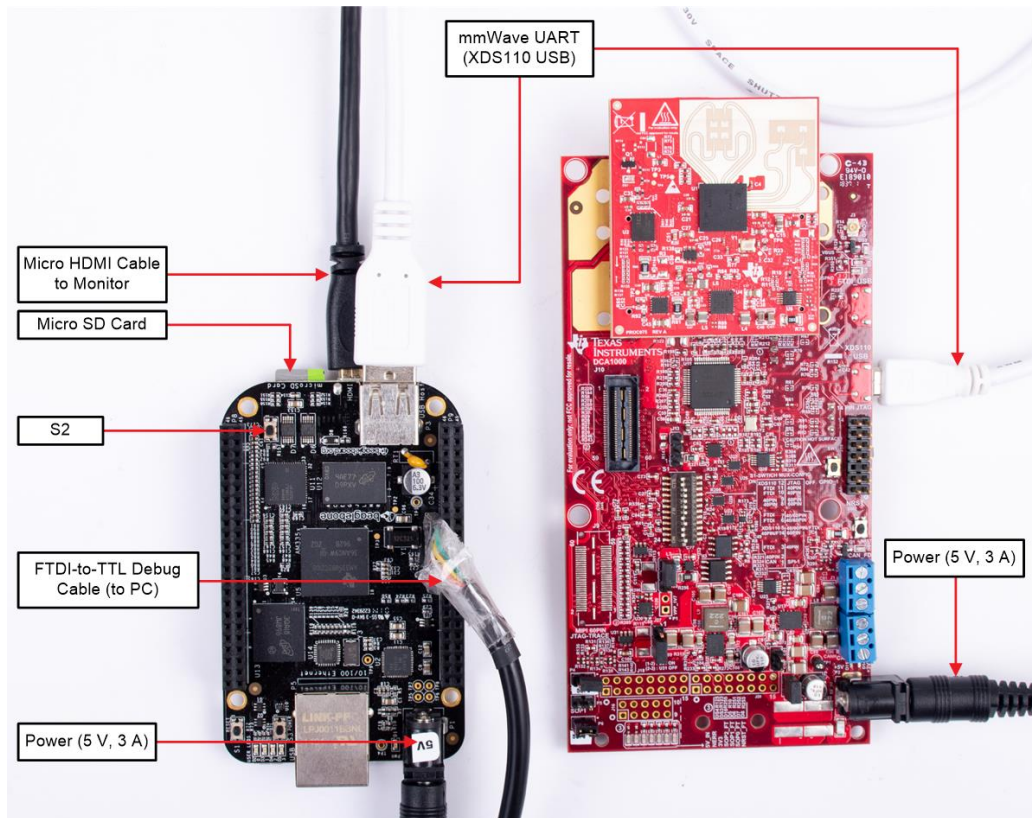

```
#/etc/init.d/weston stop
```
13. Run the `mmwavegesture_hmi` application by using following instruction:

```
#mmwavegesture_hmi 1 -platform eglfs
```

3.2.2 Test Results

1. On a successful start-up, a lock screen with a 4 digits and instructions to control the HMI application is seen on the monitor (see [図 9](#))

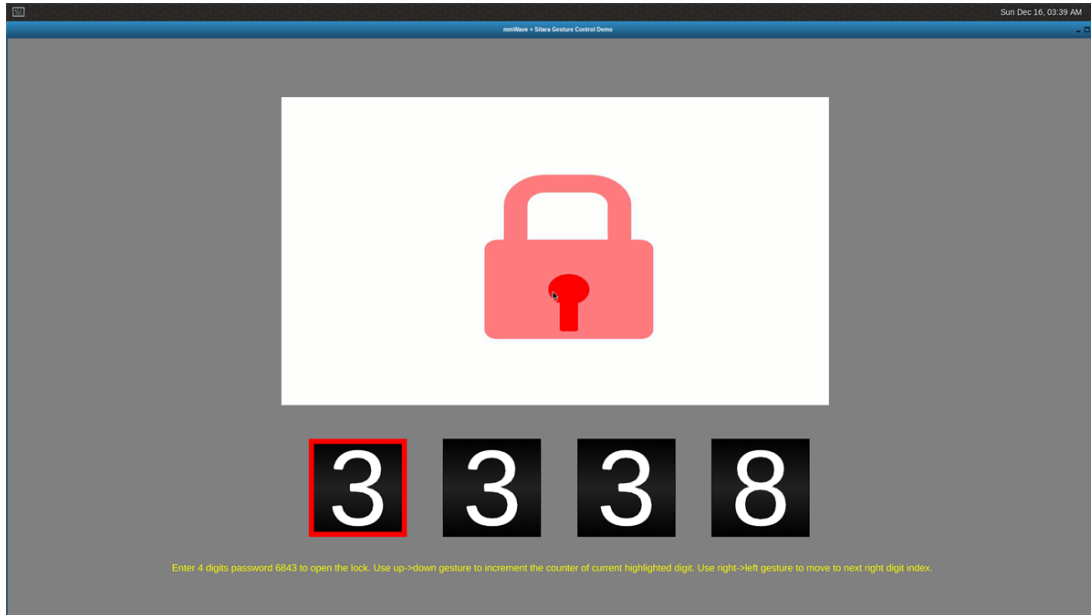
図 9. Gesture HMI lock screen



2. Within a maximum distance of about 40 cm from the mmWave EVM, move the palm of your hand in a right-to-left swiping motion or in an up-and-down swiping motion to interact with the GUI as described below.
3. **Left-Swipe Gesture:** Swing your hand from right to left in front of the mmWave sensor to move to the next digit, that is, change the active digit selection. Each right-to-left hand gesture moves the digit selection by 1 digit to the right (see [図 10](#)).

図 10. Left-Swipe Gesture

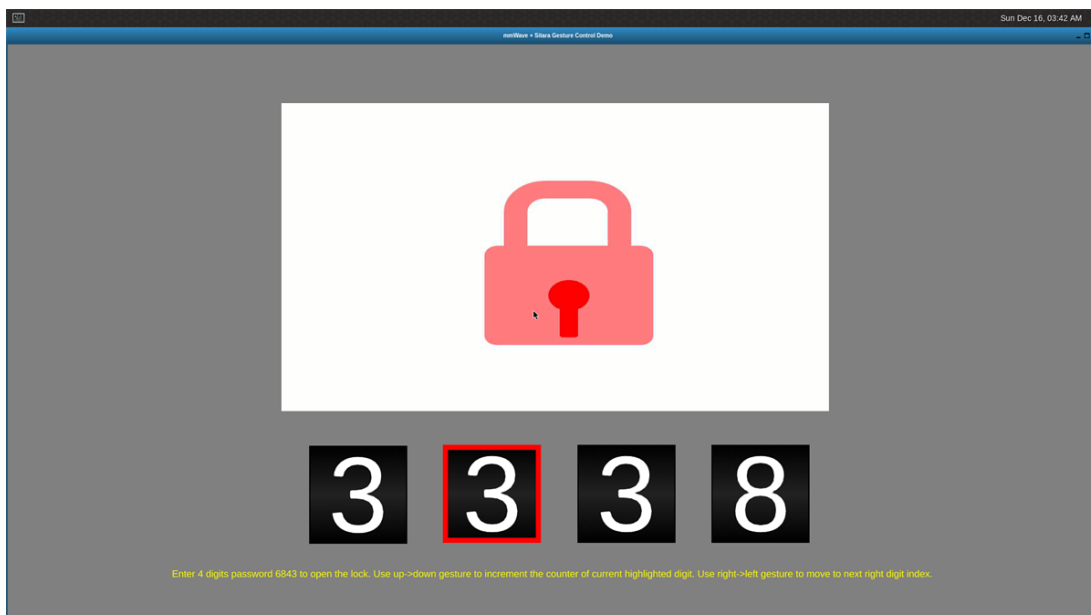

4. **Down-Swipe Gesture:** Swing your hand up and down in front of the mmWave sensor to change the value of the currently selected digit. The value of each digit cycles from 3 to 8. With each down-swipe hand gesture, the digit increases by 1 (see [Figure 11](#)).

Figure 11. Down-Swipe Gesture

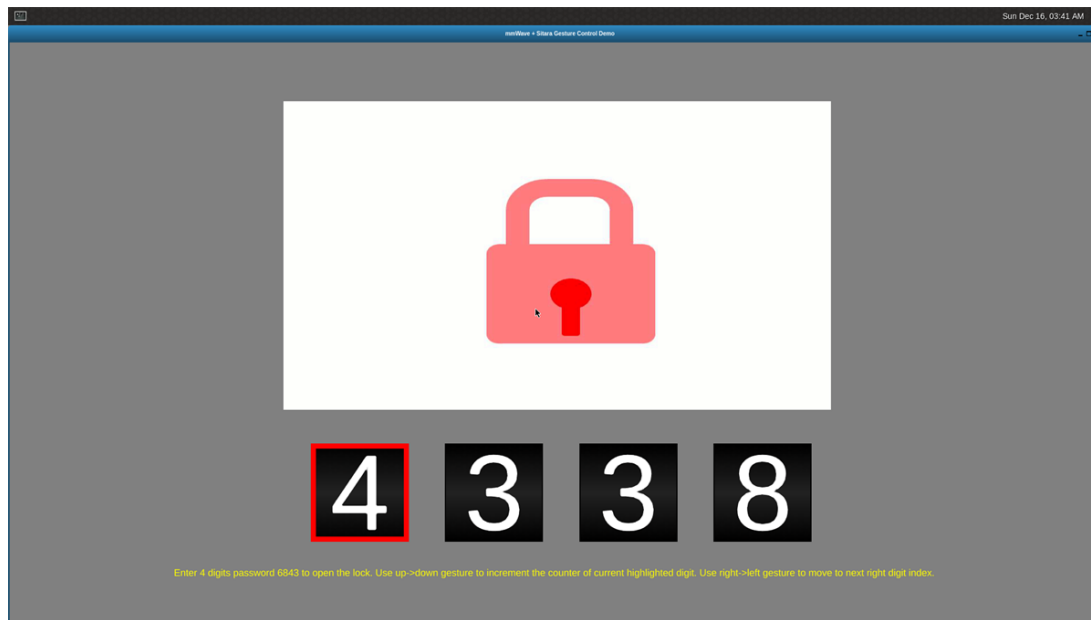

5. The unlock code is **6843**.
6. Use the left-swipe gesture to select the first digit from the left then, use the down-swipe gesture until the value of the digit changes to **6**.
7. Use the left-swipe gesture to move the digit selection 1 digit to the right.
8. Repeat [step 6](#) and [step 7](#) to change the digit combination to **6 8 4 3** which is the unlock code.
9. With the digit pattern matching the unlock code, the unlock image should be seen on the monitor (see [Figure 12](#)).

Figure 12. Gesture HMI unlock code

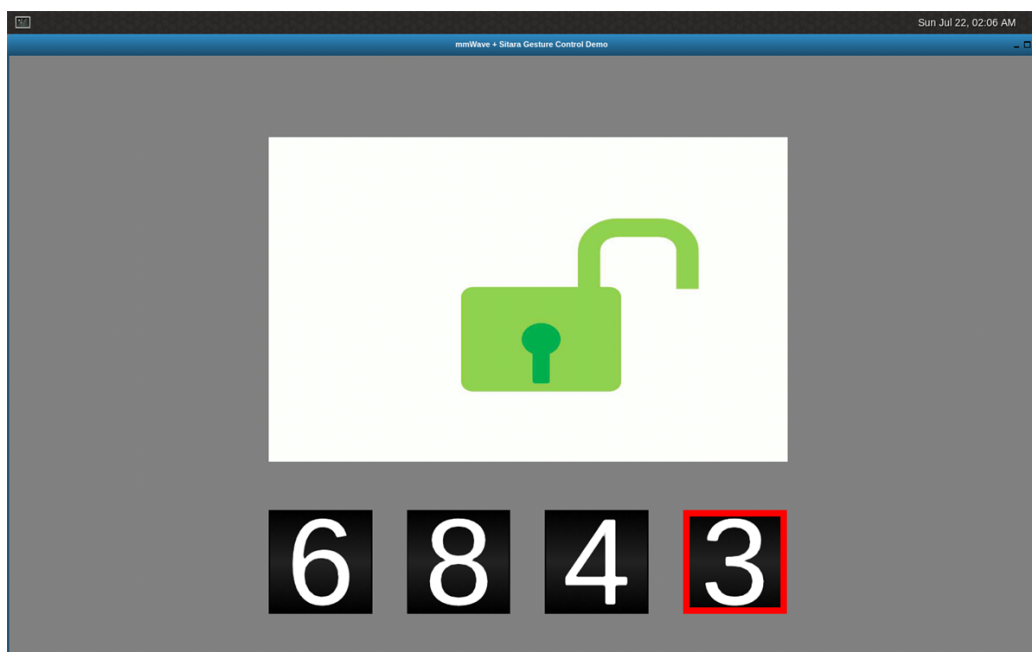

10. If no motion is detected in front of the sensor for a few seconds, the screen turns to black indicating Idle mode.

☒ **13. Gesture HMI idle mode**

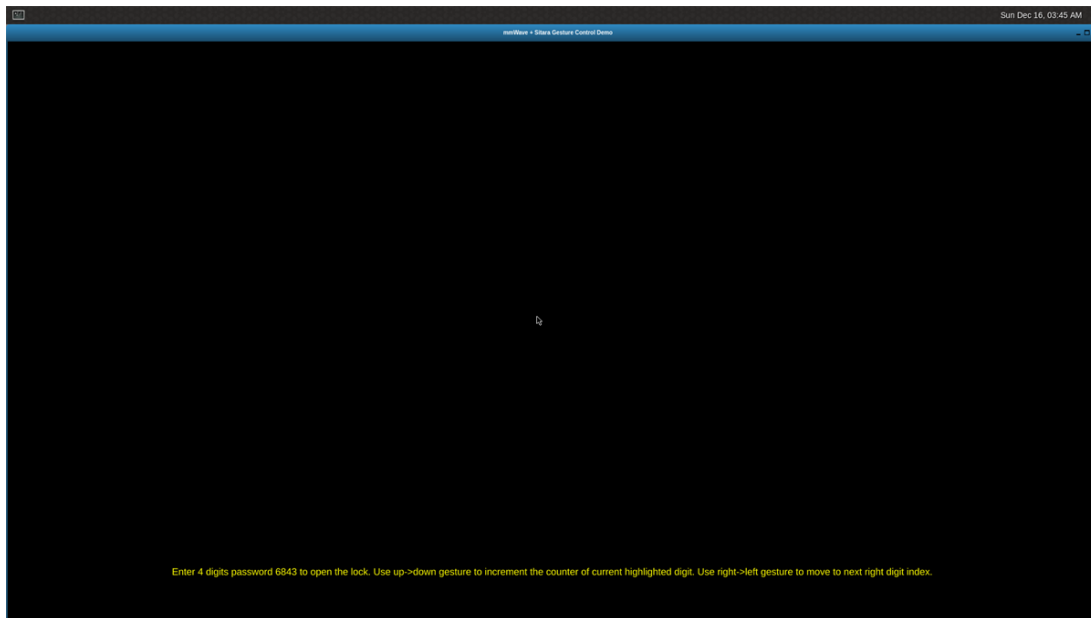

11. When motion is detected, a lock along with keys to enter the 4 digit password is displayed back on the monitor.

4 Design Files

4.1 Schematics

To download the schematics, see the design files at [TIDEP-01013](#).

4.2 Bill of Materials

To download the bill of materials (BOM), see the design files at [TIDEP-01013](#).

4.3 PCB Layout Recommendations

4.3.1 Layout Prints

To download the layer plots, see the design files at [TIDA-01013](#).

4.4 Altium Project

To download the Altium Designer® project files, see the design files at [TIDEP-01013](#).

4.5 Gerber Files

To download the Gerber files, see the design files at [TIDEP-01013](#).

4.6 Assembly Drawings

To download the assembly drawings, see the design files at [TIDEP-01013](#).

5 Software Files

Download the Processor SDK Linux for AM335x from the [AM335x software product page](#).

Download the [mmWave SDK](#).

Download the [mmWave Gesture Software](#).

6 Related Documentation

1. [Texas Instruments, Processor SDK Linux Software Developer's Guide](#), Wiki Page
2. [Texas Instruments, Sitara Linux Training: Hands on with QT](#), Wiki Page
3. [Texas Instruments, mmWave SDK](#)
4. [Texas Instruments, mmWave training series](#)

6.1 商標

Sitara, E2E, BoosterPack, OMAP, DaVinci, Keystone are trademarks of Texas Instruments.
 Altium Designer is a registered trademark of Altium LLC or its affiliated companies.
 Arm, Cortex are registered trademarks of Arm Limited (or its subsidiaries) in the US and/or elsewhere.
 EtherCAT is a registered trademark of EtherCAT Technology Group.
 PowerVR SGX is a trademark of Imagination Technologies Limited.
 Linux is a registered trademark of Linus Torvalds.
 PROFIBUS is a registered trademark of PROFIBUS and PROFINET International.
 すべての商標および登録商標はそれぞれの所有者に帰属します。

6.2 Third-Party Products Disclaimer

TI'S PUBLICATION OF INFORMATION REGARDING THIRD-PARTY PRODUCTS OR SERVICES DOES NOT CONSTITUTE AN ENDORSEMENT REGARDING THE SUITABILITY OF SUCH PRODUCTS OR SERVICES OR A WARRANTY, REPRESENTATION OR ENDORSEMENT OF SUCH PRODUCTS OR SERVICES, EITHER ALONE OR IN COMBINATION WITH ANY TI PRODUCT OR SERVICE.

7 Terminology

BBB	Beagle Bone Black
EVM	Evaluation Module
GUI	Graphical User Interface
HLOS	High-Level Operating Systems
HMI	Human Machine Interface
PLSDK	Processor SDK for Linux
SDK	Software Development Kit
SoC	System-on-Chip
SSH	Secure Socket Shell
UART	Universal Asynchronous Receiver/Transmitter

8 About the Authors

MANISHA AGRAWAL is Lead Applications Engineer with the Catalog Processor Group. She has worked at TI since 2006 on OMAP™, DaVinci™ and Sitara™ processor platforms. She is the Application lead for Machine Learning/Deep Learning applications, along with other applications that involve video and graphics IPs such as: capture, display, graphics, CODEC, and other video processing engines on these devices. Manisha earned her Master of Science in Digital Signal Processing from IIT, Kanpur, India.

NITIN SAKHUJA is a Software Applications Engineer with the Radar and Analytic Processors Group working on Industrial Applications for TI's single-chip millimeter wave sensors. He has worked at TI since 2009 and his prior roles at TI included working on the Keystone™ SoC family of communications infrastructure processors and wireless basestation software. Nitin holds a Masters in Computer Science from Guru Gobind Singh Indraprastha University, Delhi, India.

重要なお知らせと免責事項

TI は、技術データと信頼性データ(データシートを含みます)、設計リソース(リファレンス・デザインを含みます)、アプリケーションや設計に関する各種アドバイス、Web ツール、安全性情報、その他のリソースを、欠陥が存在する可能性のある「現状のまま」提供しており、商品性および特定目的に対する適合性の黙示保証、第三者の知的財産権の非侵害保証を含むいかなる保証も、明示的または黙示的にかかわらず拒否します。

これらのリソースは、TI 製品を使用する設計の経験を積んだ開発者への提供を意図したものです。(1) お客様のアプリケーションに適した TI 製品の選定、(2) お客様のアプリケーションの設計、検証、試験、(3) お客様のアプリケーションに該当する各種規格や、その他のあらゆる安全性、セキュリティ、規制、または他の要件への確実な適合に関する責任を、お客様のみが単独で負うものとし、

上記の各種リソースは、予告なく変更される可能性があります。これらのリソースは、リソースで説明されている TI 製品を使用するアプリケーションの開発の目的でのみ、TI はその使用をお客様に許諾します。これらのリソースに関して、他の目的で複製することや掲載することは禁止されています。TI や第三者の知的財産権のライセンスが付与されている訳ではありません。お客様は、これらのリソースを自身で使用した結果発生するあらゆる申し立て、損害、費用、損失、責任について、TI およびその代理人を完全に補償するものとし、TI は一切の責任を拒否します。

TI の製品は、[TI の販売条件](#)、または [ti.com](https://www.ti.com) やかかる TI 製品の関連資料などのいずれかを通じて提供する適用可能な条項の下で提供されています。TI がこれらのリソースを提供することは、適用される TI の保証または他の保証の放棄の拡大や変更を意味するものではありません。

お客様がいかなる追加条項または代替条項を提案した場合でも、TI はそれらに異議を唱え、拒否します。

郵送先住所：Texas Instruments, Post Office Box 655303, Dallas, Texas 75265

Copyright © 2022, Texas Instruments Incorporated