

デザイン・ガイド: TIDC-HYBRID-WMBUS-PLC 規格に準拠したプロトコルによるネットワーク・カバレッジおよび信頼性向上のリファレンス・デザイン



概要

先進メータ・インフラストラクチャ (AMI) および配電自動化ネットワークにおける適時の応答と監視の重要性から、信頼性の高い通信に対する要求が高まっています。サービスの事業者と規制機関が相互運用性を活用できるように、ほとんどのスマート・グリッド展開で、規格に準拠した通信が要件となりつつあります。このリファレンス・デザインでは、規格に準拠したワイヤレス M-Bus および G3-PLC 電力線通信 (PLC) を使用したソリューションを実装することで、この問題に対応しています。

このリファレンス・デザインは、ネットワークの性能、信頼性、容量、拡張性の向上に役立ちます。CC13xx ワイヤレス MCU は RF プロトコル・プロセッサとして動作するほか、PLC プロセッサのホストとしても動作するため、システム設計のコストも削減できます。このリファレンス・デザインは、G3-PLC によるワイヤレス M-Bus RF ソリューションに基づいています。TI 独自の RF ソリューションを使用したバージョンについては、[TIDC-HYBRID-RF-PLC Design](#) を参照してください。

リソース

TIDC-HYBRID-WMBUS-PLC	デザイン・フォルダ
CC310	プロダクト・フォルダ
F28PLC84	プロダクト・フォルダ
F28375S	プロダクト・フォルダ
F28M35H52C	プロダクト・フォルダ
AFE031	プロダクト・フォルダ
AFE032	プロダクト・フォルダ
TMDSPCLKITV4-CEN	ツール・フォルダ
LAUNCHXL-CC1310	ツール・フォルダ
TI-PLC-G3-CENELEC-SN	ツール・フォルダ
SIMPLELINK-CC13X0-SDK	ツール・フォルダ
WMBUS	ツール・フォルダ

特長

- ワイヤレス M-Bus ネットワークと PLC ネットワークで同時に送信することで、ネットワークの信頼性を向上
- ワイヤレス M-Bus ネットワークと PLC ネットワークを使用して独立したデータを同時に送信することで、空間多重化によりネットワーク容量を拡大
- ワイヤレス M-Bus ネットワークと PLC ネットワークの間のブリッジとして動作することで、ネットワークの拡張性を向上させ、地域内のカバー領域を拡大
- 完全にプログラム可能なプロトコル設計により、CENELEC、ARIB、FCC 周波数帯の PLC / ワイヤレス M-Bus 通信プロトコル (PRIME、G3-PLC、PLC-Lite) と、868MHz 周波数帯のワイヤレス M-Bus C/T/S モード TRX のサポートを幅広く選択可能

アプリケーション

- 配電自動化
- スマート・メーター
- スマート・プラグ
- スマート・グリッド通信



Search Our E2E™ support forums

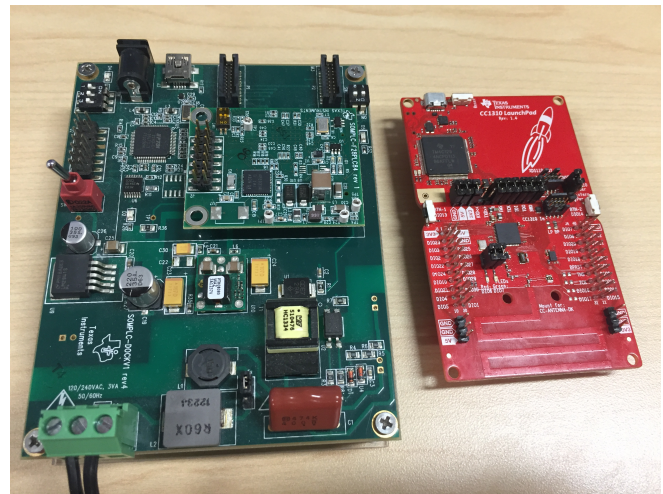
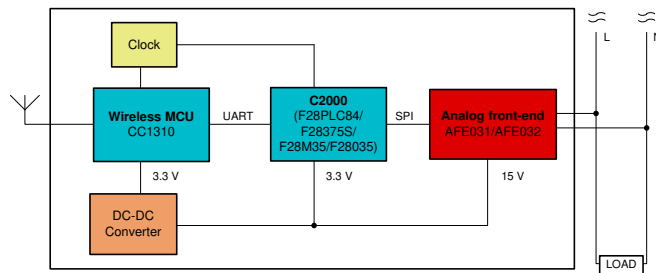

使用許可、知的財産、その他免責事項は、最終ページにあるIMPORTANT NOTICE (重要な注意事項)をご参照くださいますようお願いいたします。

1 System Description

This design provides a reliable communication system solution with standard-based wireless M-Bus and PLC communications for end equipment of smart grid applications. This design is built on top of the existing TI PLC and wireless M-Bus solutions, which improves network performance and provides more features by combining the communication modems and the inherited advantages from the existing PLC and wireless M-Bus solutions.

The ARM® Cortex™-M3 processor in the CC1310 Simplelink™ wireless microcontroller (MCU) is the CPU that controls the RF and PLC links. In this design, the CC1310 Wireless MCU is connected to the C2000 PLC MCU through UART and acts as the external host processor for the PLC modem. The PLC MCU is loaded with the G3-PLC stacks. The wireless MCU also runs the host applications for the system by simultaneously transmitting packets on both networks or acting as a bridge between the different physical networks. [Section 4](#) describes the hybrid wireless M-Bus PLC example project that uses this architecture.

☒ [1](#) shows the wireless M-Bus with a G3-PLC full-stack based system architecture.

図 1. System Architecture (Wireless M-Bus With PLC)

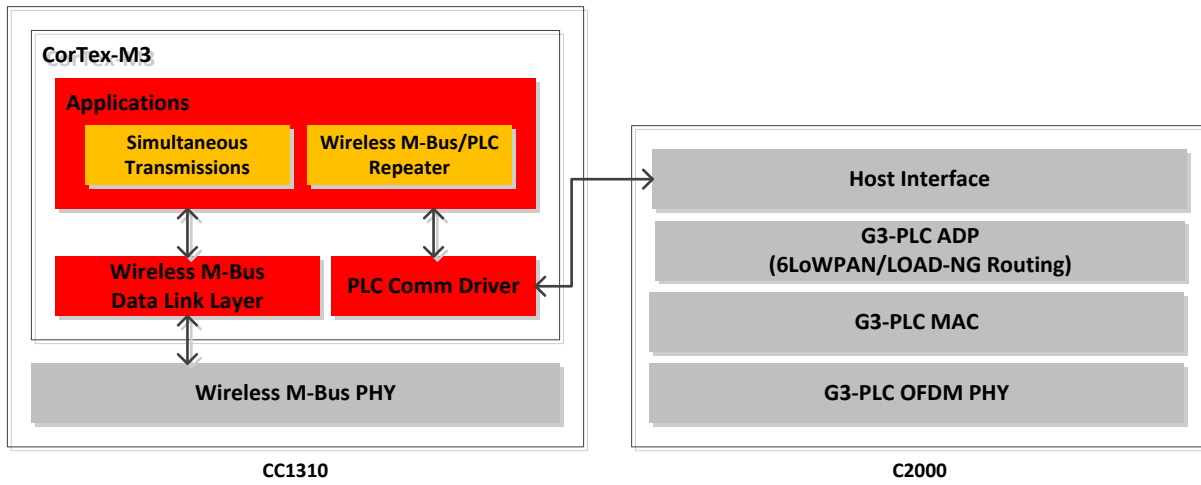

2 Block Diagrams

The primary devices for this design are CC1310, TMS320F28PLC84, and AFE031. The CC1310 includes two core processors: ARM™ Cortex-M0 for RF communication and ARM™ Cortex-M3 for applications, network stacks, and host-level RF/PLC communication drivers. The TMS320F28PLC84 with AFE031 (PLC analog front end) is for PLC communication.

Figure 2 shows the block diagram.

図 2. Block Diagram

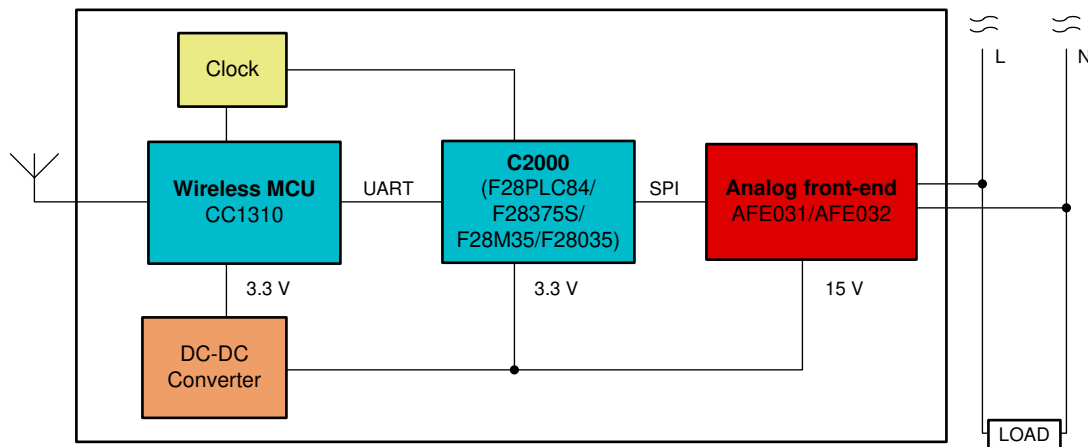

2.1 Highlighted Products

The Reference Design features the following devices:

- CC1310 combines a flexible, low-power RF transceiver with a powerful 48-MHz ARM™ Cortex-M3 microcontroller in a platform supporting wireless M-Bus stacks.
- TMS320F28PLC84 provides optimized PLC OFDM performance with VCU and allows programmable, flexible PLC design that may upgrade to different PLC solutions without hardware modification.
- AFE031 provides high reliability for PLC applications by using a monolithic integrated circuit with thermal and overcurrent protection.

For more information on each of these devices, refer to the [TIDC-HYBRID-WMBUS-PLC](#) product folders.

2.1.1 CC1310

The device is a member of the CC26xx and CC13xx families of cost-effective, ultra low-power, 2.4 GHz and sub 1-GHz RF devices. Low active RF, MCU current, and low-power mode current consumption provide excellent battery lifetime and allow operation on small coin-cell batteries and energy-harvesting applications. The CC1310 device is the first part in a Sub-1 GHz family of cost-effective, ultra low-power wireless MCUs. The CC1310 device combines a flexible, low-power RF transceiver with a powerful 48-MHz Cortex M3 MCU in a platform that supports multiple physical layers and RF standards. A dedicated radio controller (Cortex-M0) handles low-level RF protocol commands that are stored in ROM or RAM, which ensures ultra low-power and flexibility. The low-power consumption of the CC1310 device does not come at the expense of RF performance—the CC1310 device has excellent sensitivity, selectivity and blocking performance. The CC1310 device is a highly integrated, single-chip solution that incorporates a complete RF system and an on-chip DC-DC converter. Sensors may be handled in a low-power manner by a dedicated autonomous ultra low-power MCU that may be configured to handle analog and digital sensors, so the main MCU (Cortex-M3) may maximize sleep time. The CC1310 power, clock

management, and radio systems require specific configuration and software handling to operate correctly. This has been implemented in the TI RTOS, and TI recommends that this software framework is used for all application development on the device. The CC1310 includes an Advanced Encryption Standard (AES) engine with 128-bit key support. In addition, the source code offers the complete TI-RTOS and device drivers.

Figure 3 shows the block diagram.

図 3. CC1310 Functional Block Diagram

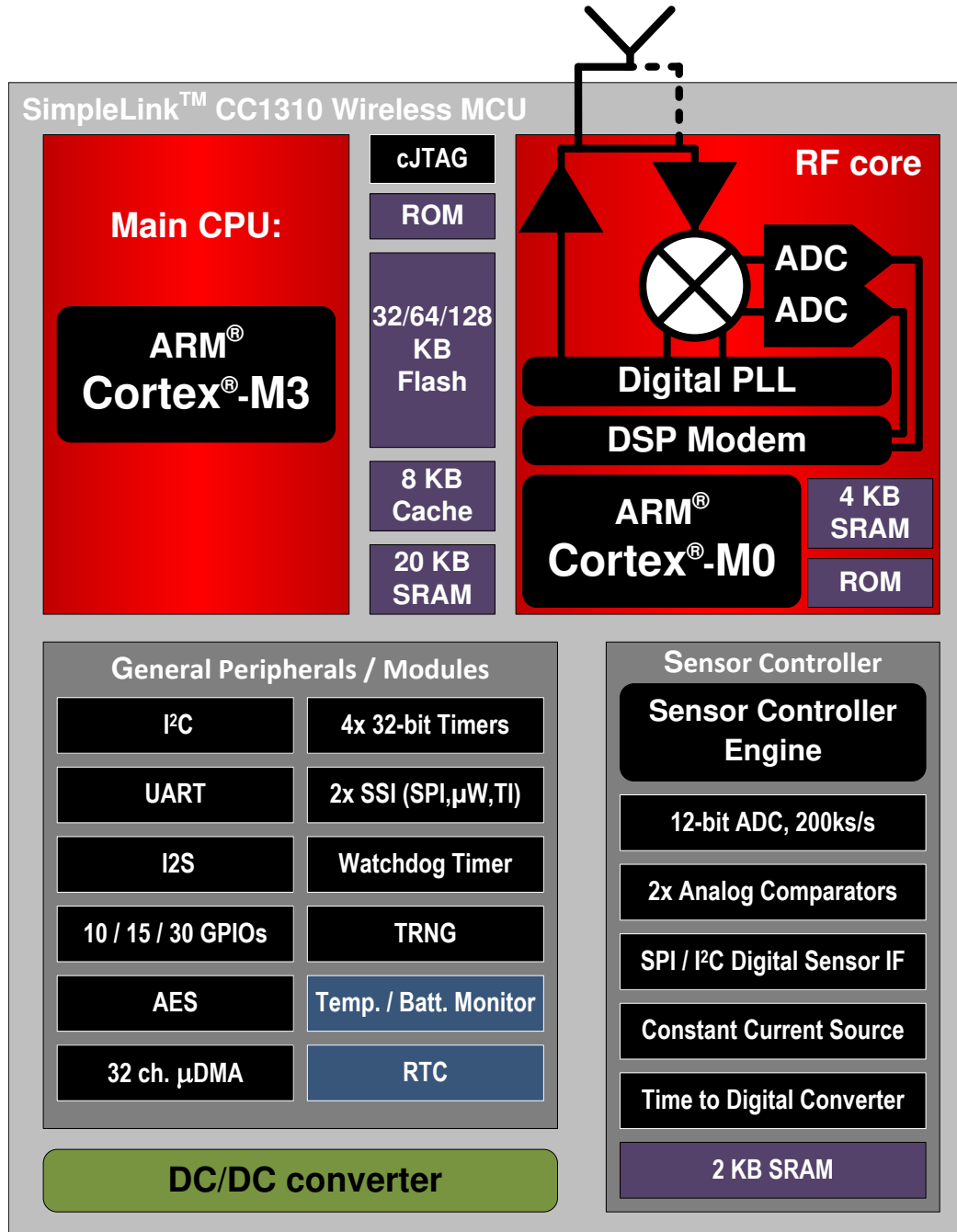

2.1.2 TMS320F28PLC84

The TMS320F28PLC84 PLC processors are optimized to meet the requirements for AMI networks in Smart Grid installations that will use narrowband PLC in the CENELEC frequency band. The CENELEC band is defined to range from 35 kHz to 90 kHz. The F28PLC84 processor is designed to execute the entire PLC protocol stack for the supported industry standards. TI supplies these firmware libraries to execute on the F28PLC84 processor with no additional license fees or royalties. The F28PLC84 processor is also used in PLC data concentrators, which act as neighborhood-area collectors of electricity usage information from multiple end nodes. The F28PLC84 processors are optimized to work with the AFE031 analog front end for the PLC. The AFE031 is an integrated analog front end for narrowband PLC that may drive a transformer-coupled connection to the AC Mains power line. It is ideal for driving high-current, low-impedance lines driving up to 1.9 A into reactive loads. The AFE031 is compliant with CENELEC A, B, C, and D (EN50065-1, -2, -3, -7) frequency bands.

Figure 4 shows the functional block diagram.

Figure 4. TMS320F28PLC Functional Block Diagram

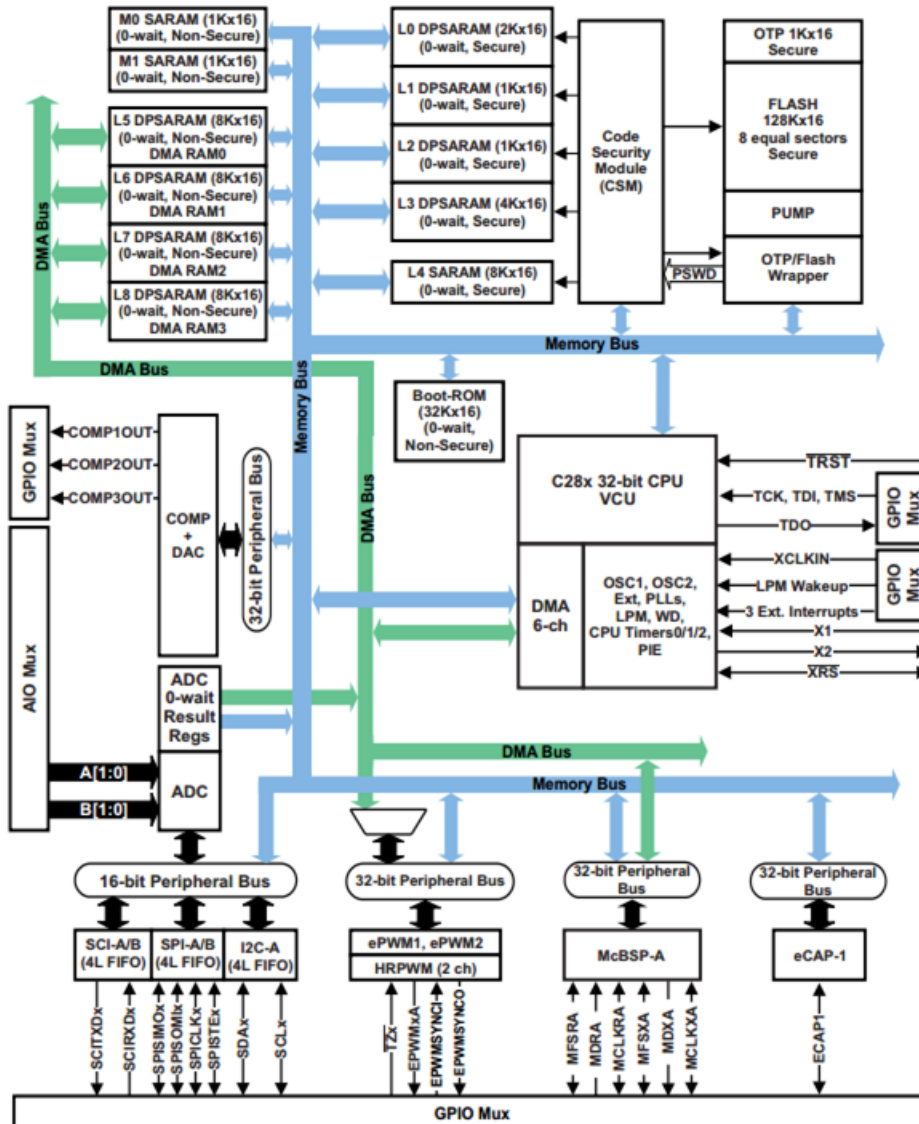

2.1.3 AFE031

The AFE031 is a low-cost, integrated, PLC analog front-end device that is capable of capacitive or transformer-coupled connections to the powerline while controlled by a DSP or microcontroller. It is ideal for driving low-impedance lines that require up to 1.5 A in reactive loads. The integrated receiver may detect signals down to 20 μ V_{RMS} and is capable of a wide range of gain options to adapt to varying input signal conditions. This monolithic integrated circuit provides high reliability in demanding powerline communications applications. The AFE031 transmit power amplifier operates from a single supply from 7 V — 24 V. At maximum output current, a wide output swing provides a 12-V_{PP} ($I_{OUT} = 1.5$ A) capability with a nominal 15-V supply. The analog and digital signal processing circuitry operates from a single 3.3-V power supply.

The AFE031 is internally protected against over temperature and short-circuit conditions. It also provides an adjustable current limit. The provided interrupt output indicates the current limit and thermal limit. There is also a shutdown pin that may quickly put the device into its lowest power state. Through the four-wire serial peripheral interface, or SPI™, each functional block may be enabled or disabled to optimize power dissipation. The AFE031 is housed in a thermally-enhanced, surface-mount Power PAD package (QFN-48). Operation is specified over the extended industrial junction temperature range of -40°C to 125°C.

Figure 5 shows the functional block diagram.

Figure 5. AFE031 Functional Block Diagram

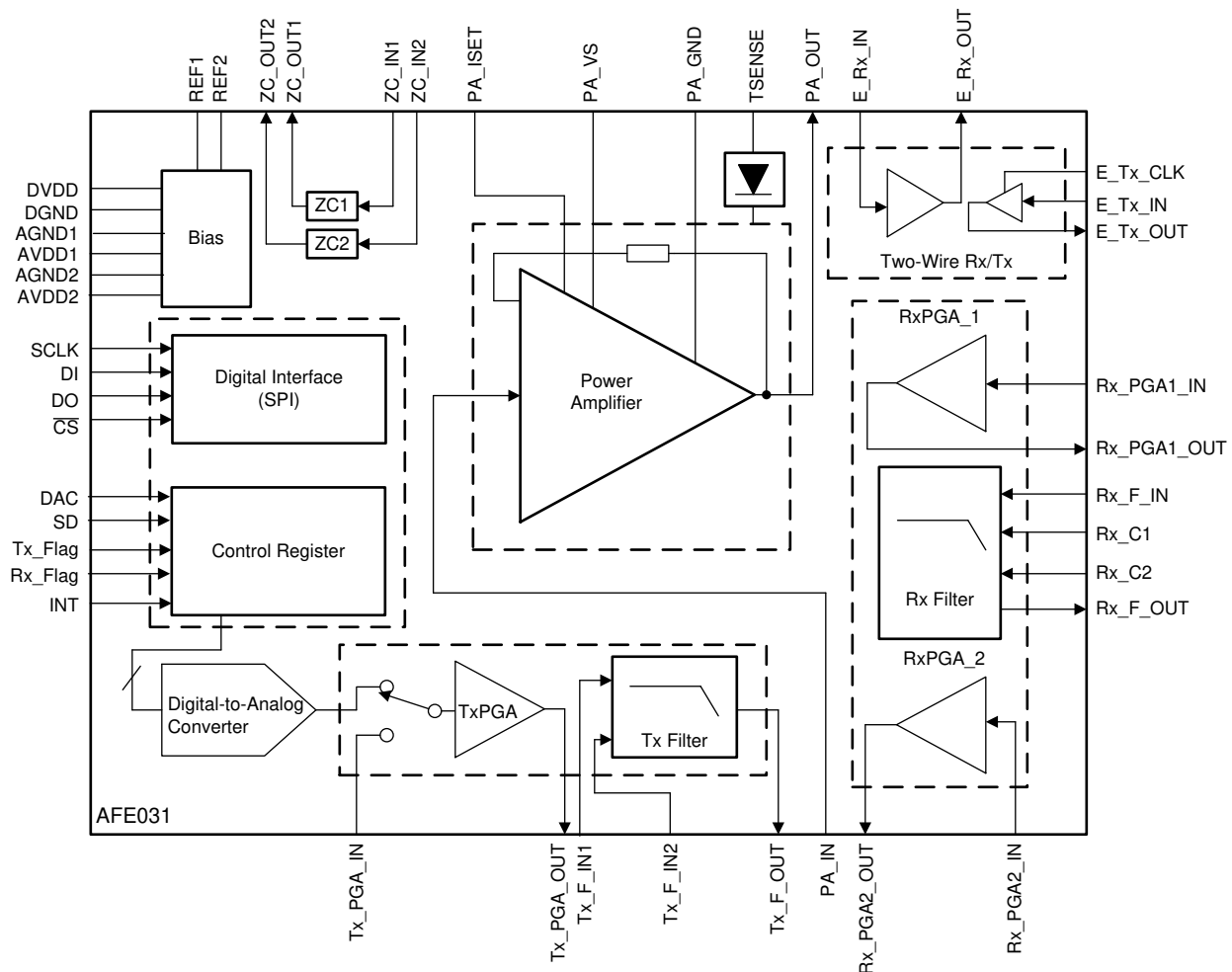

3 Getting Started Hardware

The hybrid wireless M-Bus and PLC communications design are built with two standard EVMs: [LAUNCHXL-CC1310](#) and [TMDSPCKITV4-CEN](#), as shown respectively in [Figure 6](#) and [Figure 7](#).

The reference design configures as CENELEC-A band in software with a TMDSPCKITV4-CEN platform for the PLC. Depending on user applications, [TIDM-SOMPLC-FCC](#) or [TMDSPCKITV4-ARIB](#) may work with the LAUNCHXL-CC1310.

図 6. LAUNCHXL-CC1310



図 7. TMDSPCKITV4-CEN



3.1 EVM Configuration

The major hardware modification on the hybrid wireless M-Bus or PLC system is to connect the UART pins (UART_TX, UART_RX and GND) between the LAUNCHXL-CC1310 and the TMDSPCKITV4 EVM.

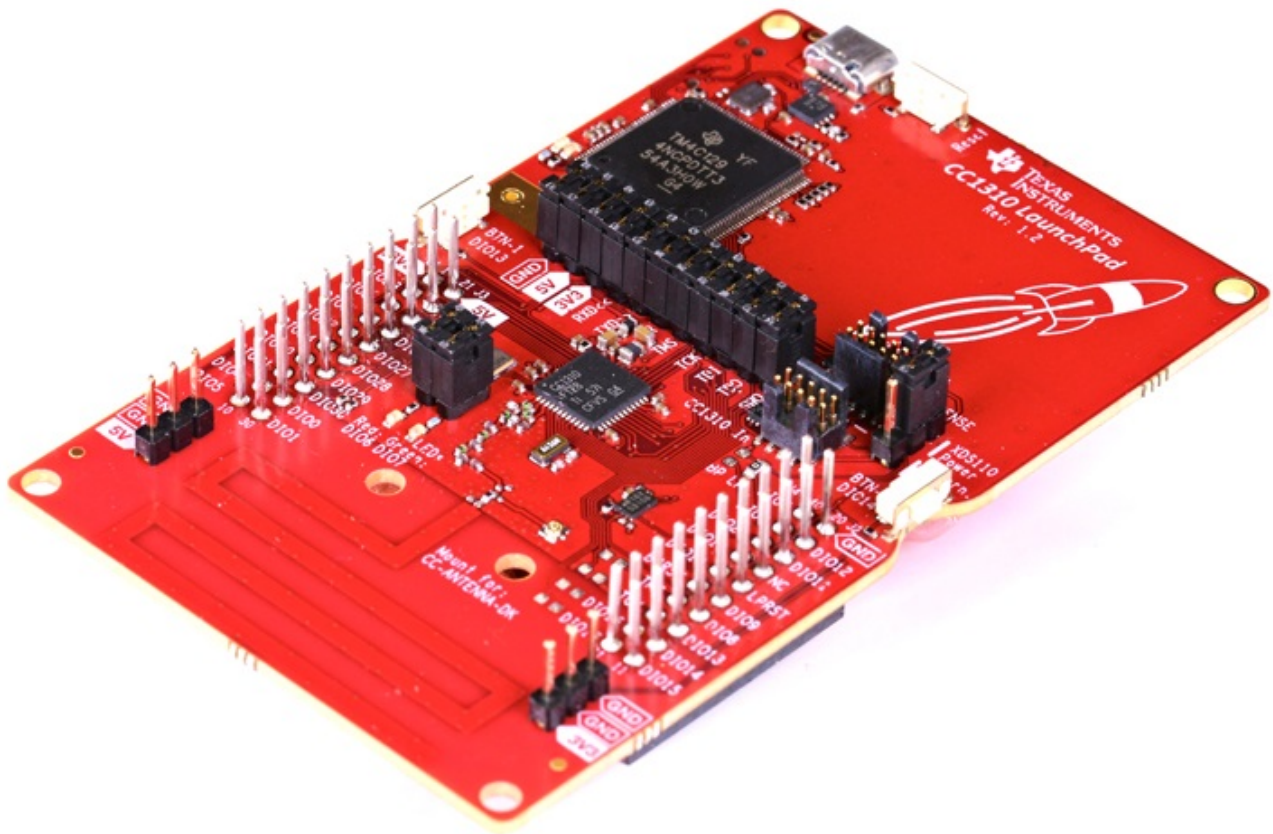
- Figure 8 shows UART pins on the TMDSPCKITV4 connected to the LAUNCHXL-CC1310.
- The M3:P2-12 (PLC_SCIA_TX) pin in Figure 8 is connected to UART RX pin (DIO 2) on the LAUNCHXL-CC1310.
- M3:P2-14 (PLC_SCIA_RX) (Figure 8) connects to UART TX pin (DIO 3) on the LAUNCHXL-CC1310.
- The GND pin in the TMDSPCKITV4 EVM, as shown in Figure 8, is connected to GND pin on the LAUNCHXL-CC1310.

図 8. UART Pins on TMDSPCKITV4

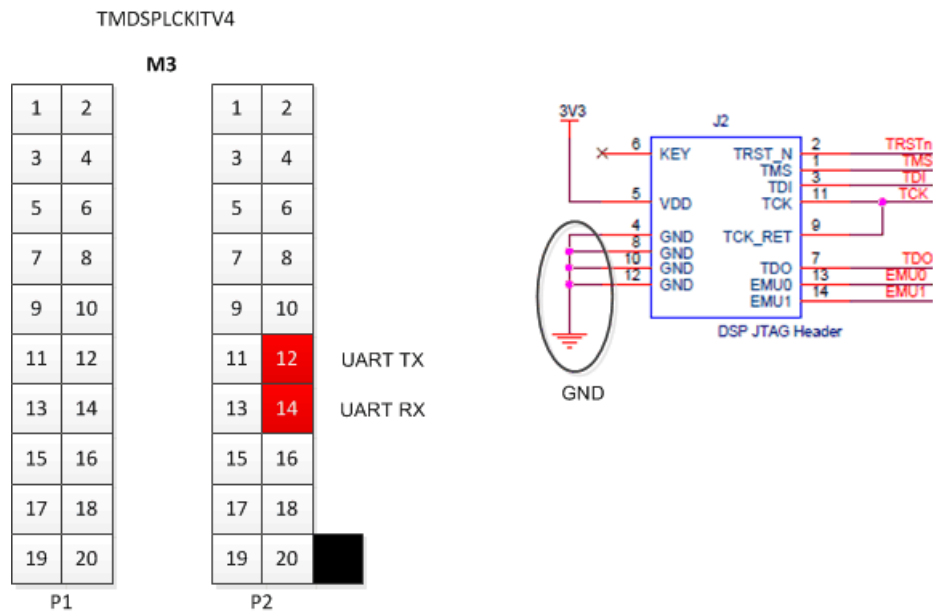

As [Figure 10](#) shows, an additional configuration change is to switch the SW2 position to OFF. Turning off the SW2 blocks UART communication with the mini-USB port in TMDSPCKITV4, which allows the M3 module to communicate with the external device through the UART without interruptions.

図 9. SW2 Position in TMDSPCKITV4 EVM

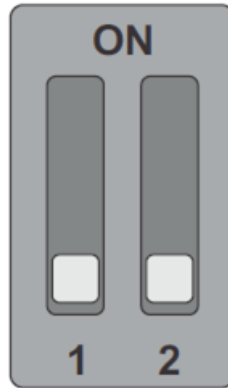

4 Getting Started Firmware

This reference design provides a HYBRID-WMBUS-PLC software example which includes applications for simultaneous transmissions, repeaters, wireless M-Bus lower-layer stacks and PLC communication host drivers. This section covers details of the example software architecture, and how to build and flash the example project using the TI Code Composer Studio™ (CCS) software.

The software example can be built with CCS v9.0.1 (or above). [Figure 10](#) and [Figure 11](#) show the compiler and CC13x0 SDK versions (SIMPLELINK-CC13X0-SDK v3.10.0.11) used to compile the software example.

Figure 10. Software Example Compiler Version

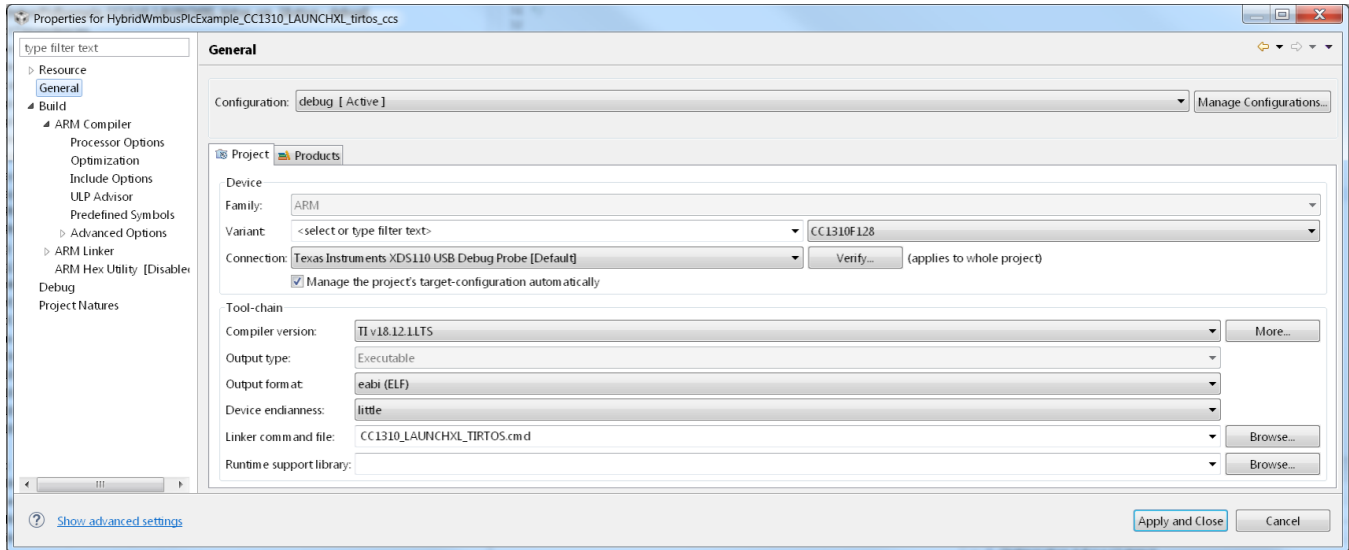
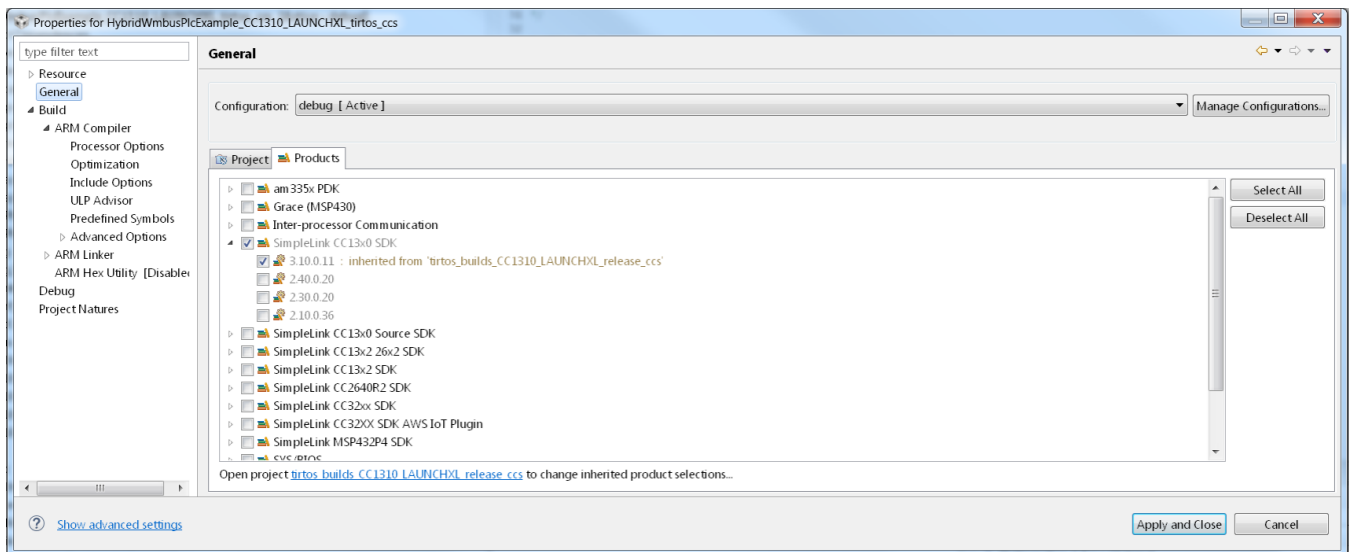

Figure 11. Software Example CC1310 SDK Version



4.1 TIDC-HYBRID-WMBUS-PLC Software Example

This example project is provided as a working example that may be used as baseline software for end-product development. The example runs on top of TI-RTOS in the ARM™ Cortex-M3. For PLC communication, the default configuration in the example is set to CENELEC-A, TMR ON and the TX level of 0x20 (maximum). The wireless M-Bus RF configuration is defined in `smartrf_setting.c`. The pre-compiled binaries are available in the directory of `debug`. The wireless M-Bus can be configured as one of three modes C-, T-, or S-mode) by enabling one of them in `application/config.h`. The `debug_RF_only` configuration run a standalone W-Mbus communication to test with the Hybrid W-Mbus and PLC solution. The `debug_RF_only` configuration enables `ECHO_BACK_MODE` macro to respond back to the Hybrid WMBUS-PLC node with the same data received from the node.

To run the software example with different PLC frequency bands of FCC or ARIB, change the following one-line code in the `init_plcHandler()` to `TONEMASK_FCC_FULL_BAND` or `TONEMASK_FCC_ARIB_54`. The TX power level and TMR configuration may also be changed in the same function.

Figure 13 shows the PLC frequency band.

Figure 12. PLC Frequency Band Configuration

```
plcHandle.g3ToneMaskSelection = TONEMASK_CENELEC_A_36;
```

The software example runs simultaneous transmissions (sending data to both RF and PLC channels). In addition, the RF-PLC repeater feature can be supported on top of the simultaneous transmissions by enabling `RF_PLC_REPEATER` macro definition in the software.

Figure 14 shows the overall software architecture that consists of five tasks shown in the following list:

- `uartRXTask`
- `PLCStateMachineTask`
- `RFTxTask`
- `PLCTxTask`
- `applicationTask`

図 13. Hybrid WMBUS/PLC Example Software Architecture

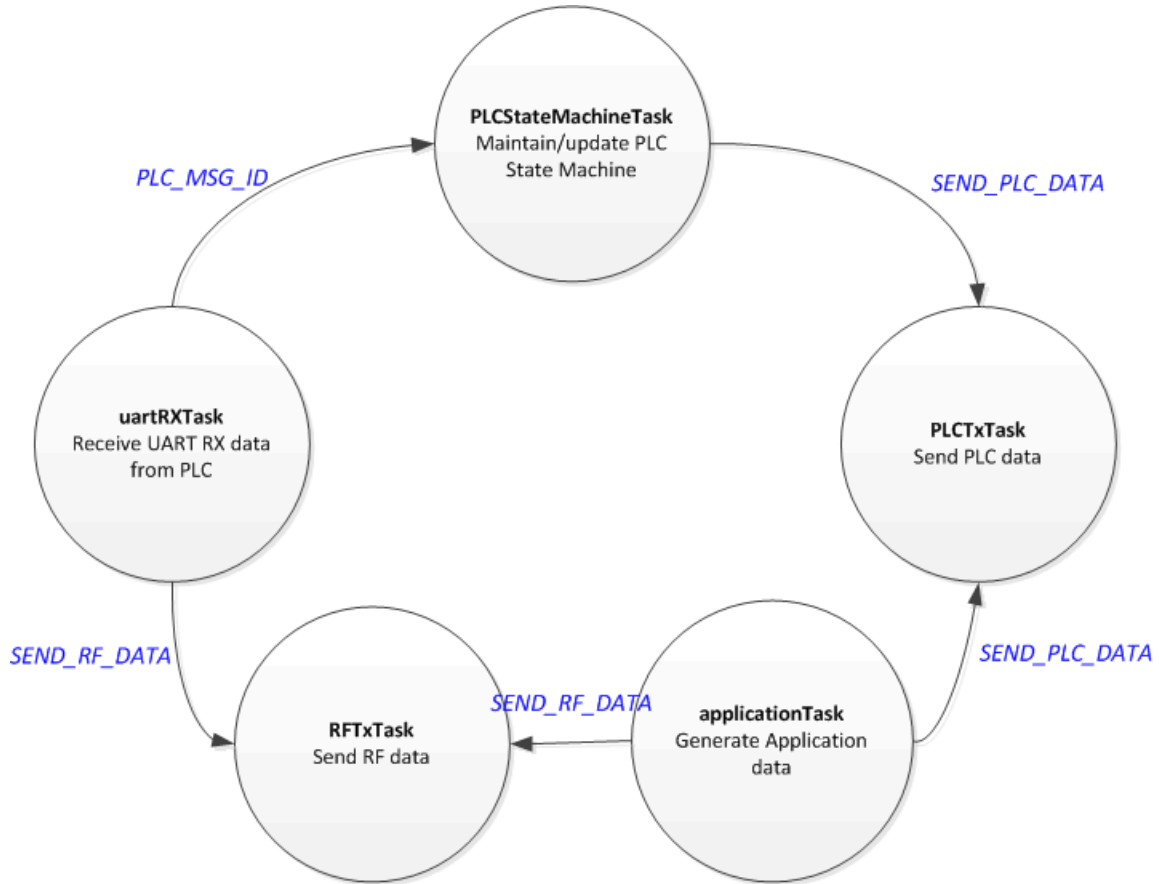

4.1.1 uARTRxTask

The uartRXTask processes PLC host messages that are received from the C2000 PLC device. The task waits for a 6-byte PLC host message header that contains a host message type, payload length, and header CRC. If the CRC passes, the task extracts the remaining bytes including payload CRC, payload sub-header, and payload. If the payload CRC passes and the message details confirmation information, then the task passes the message to the PLCStateMachineTask. If **RF_PLC_REPEATER** is enabled, and the received message contains application data, then this task passes the received data to RFTxTask.

4.1.2 PLCStateMachineTask

The PLCStateMachineTask maintains a G3-PLC service node state machine. When the power is on, the PLCStateMachine task starts to initialize G3-PLC with the default configuration and joins the G3-PLC network once the G3-PLC DC is detected. When all steps have completed, the task changes the state machine to a NORMAL state, which allows the PLCTxTask to start data transmissions.

The details of the G3-PLC host message sequences may be found in [Section 4.2](#). This example covers basic message sequences for G3-PLC operation.

4.1.3 RFTxTask

The RFTxTask waits for the mailbox message of **SEND_RF_DATA**. When the task receives the mailbox message, it constructs the application data in a wireless M-Bus packet and sends the wireless M-Bus packet to the wireless M-Bus PHY. The task then changes to the receive state. If the wireless M-Bus is working only for TX mode, the receive-related commands may be removed.

4.1.4 PLCTxTask

The PLCTxTask waits for the mailbox message of **SEND_PLC_DATA**. If the task receives the mailbox message, it sends the data over UART to the PLC C2000 device for PLC transmissions and then copies the data into PLC_HoldQueue to handle re-transmissions. When re-transmission happens, the task sends the data in the PLC_HoldQueue through UART.

4.1.5 ApplicationTask

The applicationTask emulates the application data source. This task creates 10B data, stores the data in the TX queue, and signals to both the RFTxTask and PLCTxTask for simultaneous transmissions. This event happens every five seconds with the default configuration. The application data size and interval can be configurable in application/app.c.

4.1.6 LED Configuration

The example project has two activated light-emitting diodes (LEDs) to trace software activities. The LED configuration only works for the LAUNCHXL-CC1310 EVM.

[Table 1](#) lists the LED number mapping to the specific software activity.

表 1. LED Mapping

LED NUMBER	BEHAVIOR MAPPING TO SOFTWARE ACTIVITY
DIO6	PLC TX/RX activities
DIO7	WMBus TX/RX activities

4.2 Build HYBRID-WMBUS-PLC Software Example Using CCS™

The software project can be built with CCS v9.0.1 (or above). The two project files of HybridWmbusPlcExample_CC1310_LAUNCHXL_tirtos_ccs and tirtos_builds_CC1310_LAUNCHXL_release_ccs need to be opened and the CCS project of HybridWmbusPlcExample_CC1310_LAUNCHXL_tirtos_ccs needs to be built. The screen capture of the CCS projects is shown in Figure 15. Once the compilation is successful, the binary file (HybridWmbusPlcExample_CC1310_LAUNCHXL_tirtos_ccs.out) will be generated under the directory of debug.

図 14. Build HYBRID-WMBUS-PLC CCS Project

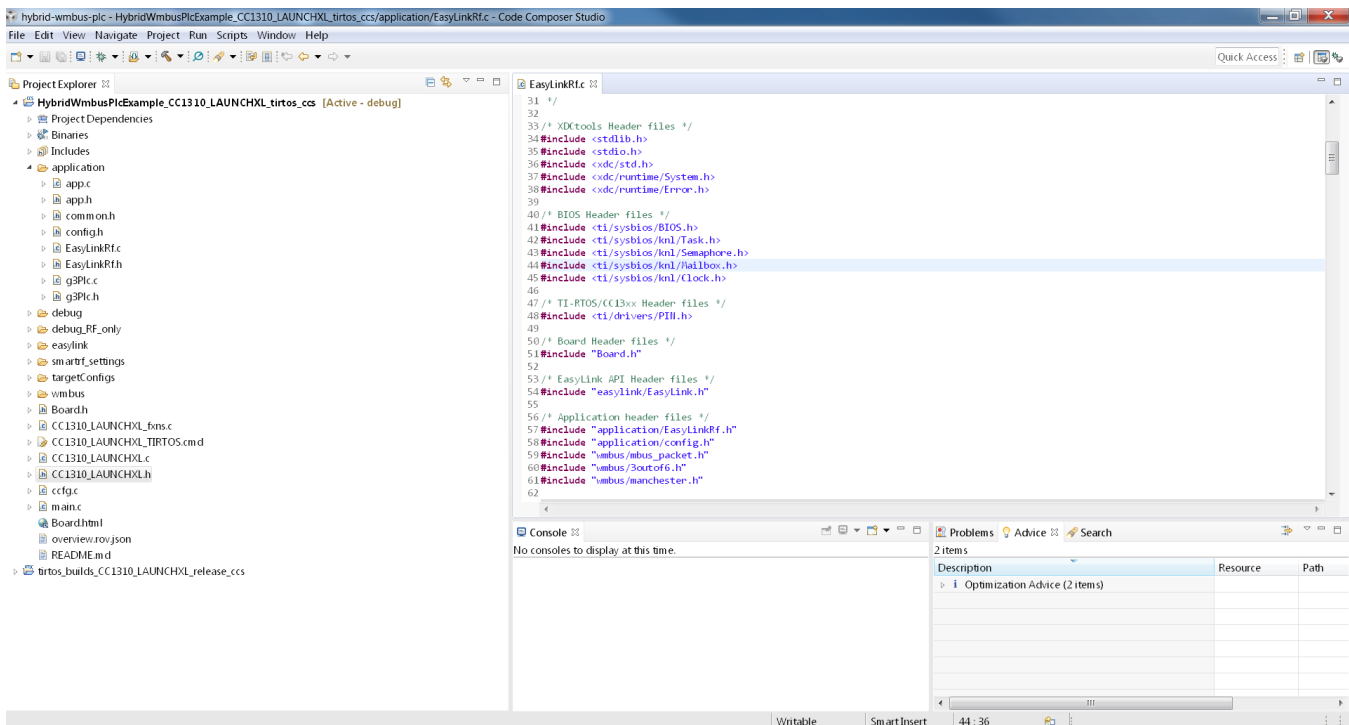

4.3 Flashing Binaries Using CCS™

This section explains the F28PLC84 (for G3-PLC) and CC1310 (for Hybrid wireless M-Bus/PLC application devices) flash software binary procedure.

4.3.1 Flashing Hybrid Wireless M-Bus/PLC Binary to CC1310 Using CCS™

This section explains how to flash the HYBRID-WMBUS-PLC software example binary on the CC1310 device using CCS. The instructions are in the following list:

1. Connect the USB cable to the LAUNCHXL-CC1310 EVM.
2. Launch the target configuration for CC1310 and connect to the device in the CCS debug mode
3. Select *Run* → *Load* → *Load Program* and flash **HybridWmbusPlcExample_CC1310_LAUNCHXL_tirtos_ccs.out** under the *debug* directory.

4.3.2 Flashing PLC Binary to TMS320F28PLC84

The step-by-step procedure may be found in Section 7.1 (with C2Prog tool) and Section 7.2 (with the CCS tool) in the *System on Module for G3 Power Line Communication (CENELEC Frequency Band)* design guide [4]. The latest G3-PLC software may be found in [TI-PLC-G3-CENELEC-SN-F28PLC84](#).

5 Hybrid Wireless M-Bus/PLC Test

The goal of the hybrid wireless M-Bus/PLC test is to prove the wireless M-Bus/PLC repeater functionality with a 3-node set up that includes one wireless M-Bus, one PLC and one hybrid wireless M-Bus/PLC node.

5.1 Test Setup

To run the Hybrid RF/PLC test, a [LAUNCHXL-CC1310](#) and [TMDSPCKITV4-CEN](#) is required. Both EVMs are available in the TI store at [TI.com](#).

[Table 2](#) lists the required tools and software to run the hybrid wireless M-Bus/PLC test.

表 2. Tools for Hybrid Wireless M-Bus/PLC Test Setup

DEVICE	EVM	HARDWARE MODIFICATION	FLASH FIRMWARE	GUI TOOL
Wireless M-Bus only	LAUNCHXL-CC1310	No	Yes ⁽¹⁾	No (Running as stand alone mode)
PLC only	TMDSPCKITV4-CEN	No	Yes (Section 4.3.2)	Yes (Zero-configuration GUI) ⁽²⁾
Hybrid wireless M-Bus with PLC	CC1310DK TMDSPCKITV4-CEN	No	Yes (4.3.1)	No (Running as stand alone mode)

⁽¹⁾ The pre-built wireless M-Bus standalone binary can be found in the *debug_RF_only* directory. Flashing instructions are given in [Section 4.3.1](#).

⁽²⁾ Zero-Configuration GUI is used to run PLC node as a mini-DC to start the G3-PLC network. [The G3-PLC software package](#) will install the GUI automatically.

5.2 Running Hybrid Wireless M-BUS/PLC Test

[Figure 19](#) shows a 3-node test set-up. The PLC-only node runs with the zero-configuration GUI tool. The hybrid wireless M-Bus/PLC node and wireless M-Bus echo-back node run in standalone mode.

図 15. Hybrid Wireless M-Bus/PLC Test Setup

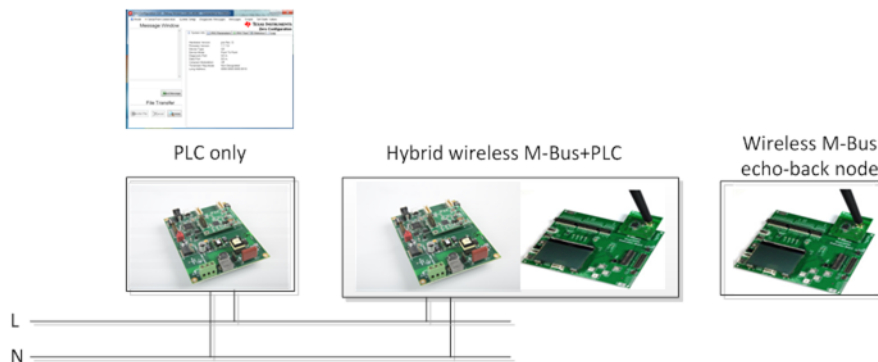

For the hybrid wireless M-Bus/PLC test, the PLC-only node is configured as G3-PLC mini-DC node. The wireless M-Bus echo-back node may run as an echo-back mode to send back the received wireless M-Bus packet to the hybrid node.

Once the power is on, the hybrid wireless M-Bus/PLC node starts to join to the PLC mini-DC (PLC only node) as the G3-PLC service node. The wireless M-Bus stacks in the hybrid node does not require a joining process. Once joined to the PLC network, the PLC-only node (running as mini-DC) may initiate echo-back data transfer.

注: To bridge echo-back data received from W-MBus node to the PLC mini-DC on the hybrid W-MBus/PLC node, the RF_PLC_REPEATER macro needs to be enabled on the hybrid node and then recompile the software example.

Figure 20 shows the details of the data flow.

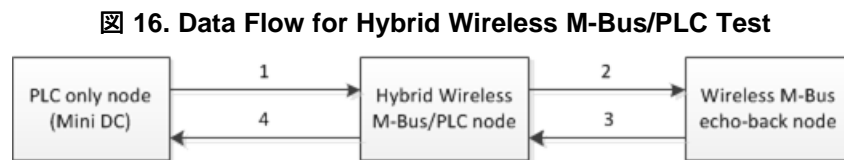

1. The PLC node sends UDP/IPv6 data through the power line.
2. The hybrid wireless M-Bus/PLC node receives the data, and passes the data to the wireless M-Bus echo-back node through the RF path.
3. The wireless M-Bus echo-back node takes the UDP/IPv6 header from the received data and then sends it back to the Hybrid wireless M-Bus/PLC node through the RF path
4. The hybrid node adds a UDP/IPv6 header on the received data because the G3-PLC only accepts IPv6 packets.
5. The hybrid node sends the data to the PLC node through the power line.

5.2.1 Test Procedure

This section covers the step-by-step procedure for running the hybrid wireless M-Bus/PLC testing.

1. Start the PLC only node as a mini-DC (Refer to Steps 1 – 4 in [Section 5.2.2](#)).
2. Turn on the Wireless M-Bus echo-back node and the hybrid wireless M-Bus/PLC node to start standalone mode
3. Start data transfer testing by clicking **Start Test** in the GUI window in the mini-DC (Refer to Step 6 in [Section 5.2.2](#)).

5.2.2 PLC Only Node Setup

This section covers how to run the PLC only node as a mini-DC with GUI.

1. Connect the PLC only node to the PC and open the intermediate GUI.
2. Set a unique long address for each device by using **Set System Config**.

図 17. Set System Configuration



図 18. G3-PLC System Configuration



3. Start a device as a mini-DC by selecting *Functions* → *Start Base Node*.

図 19. Start Base Node

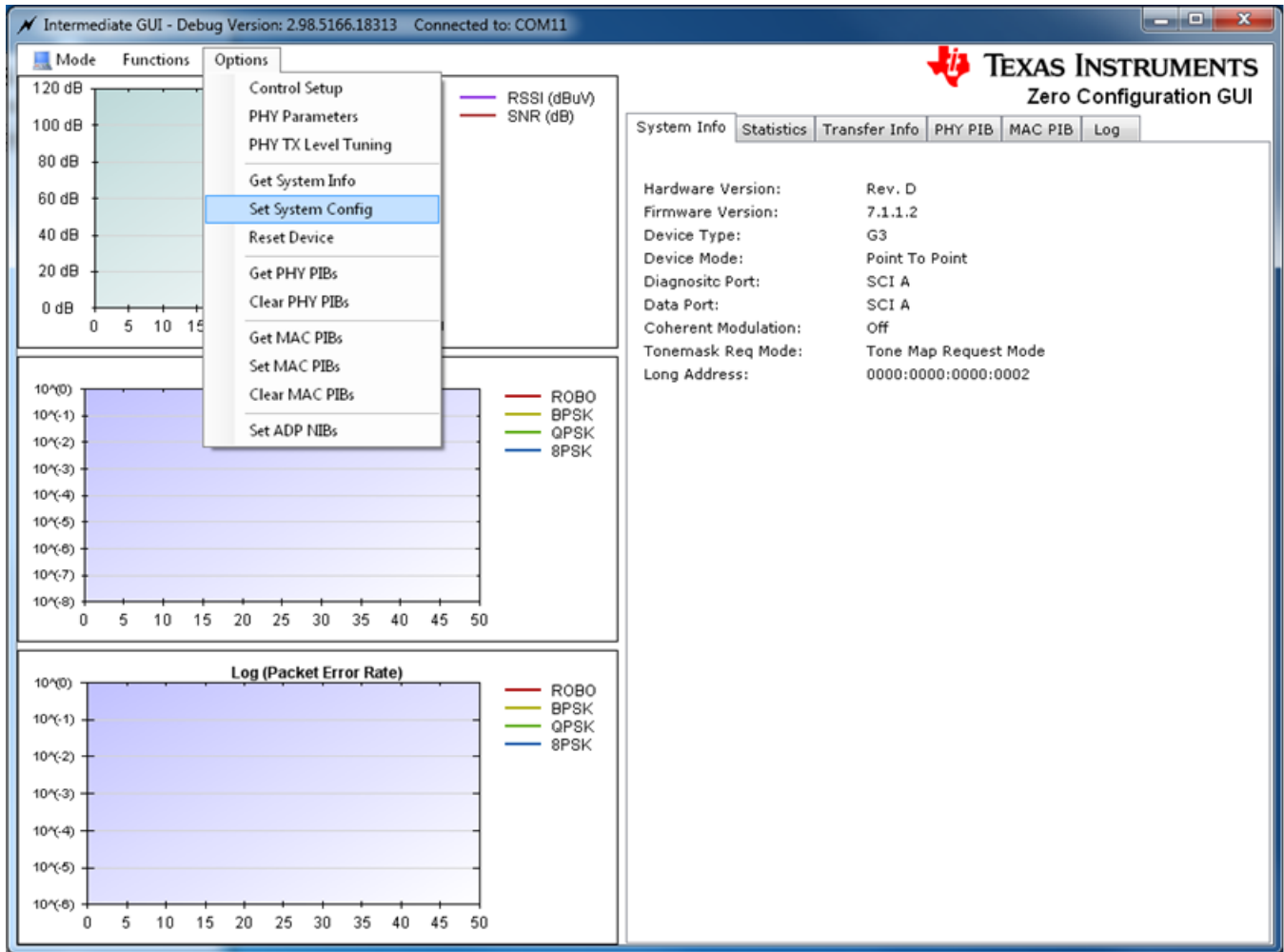
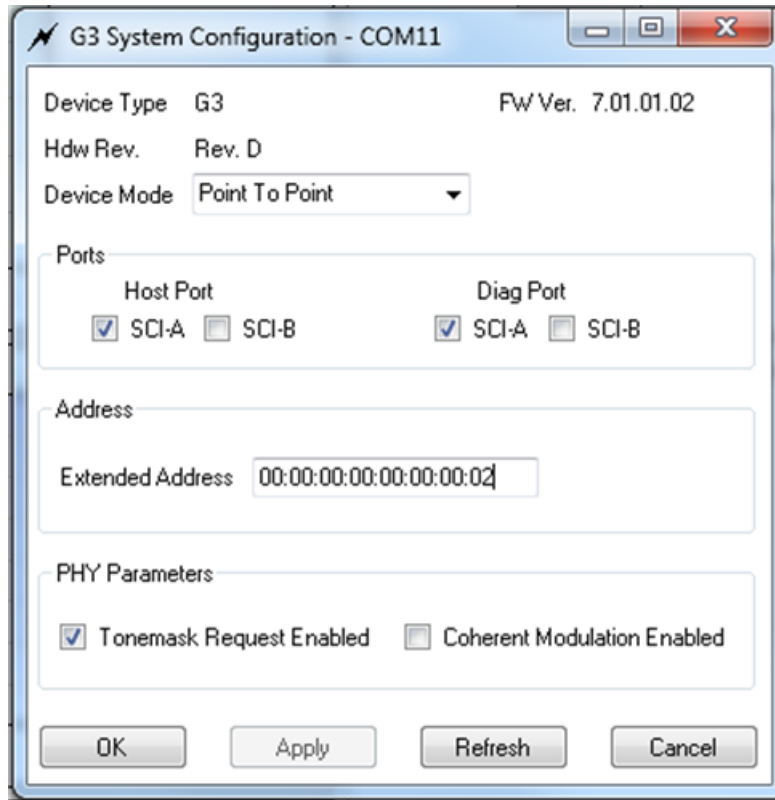
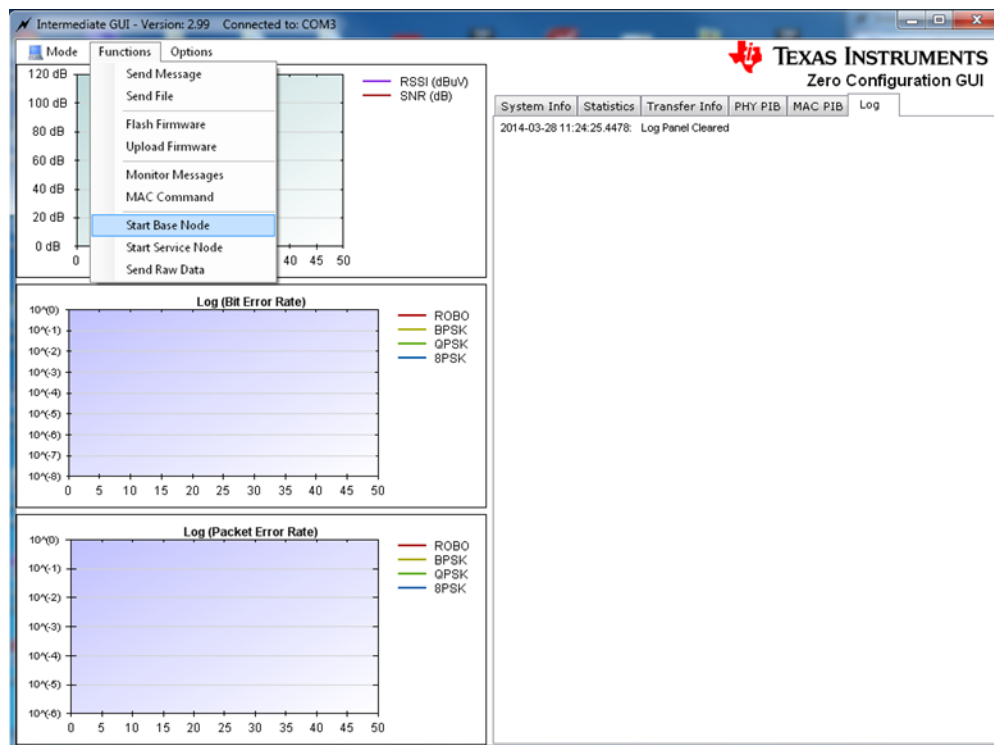

- In the pop-up window of the G3 Base Node, click **Start Network**.

20. G3-PLC Base Node Window

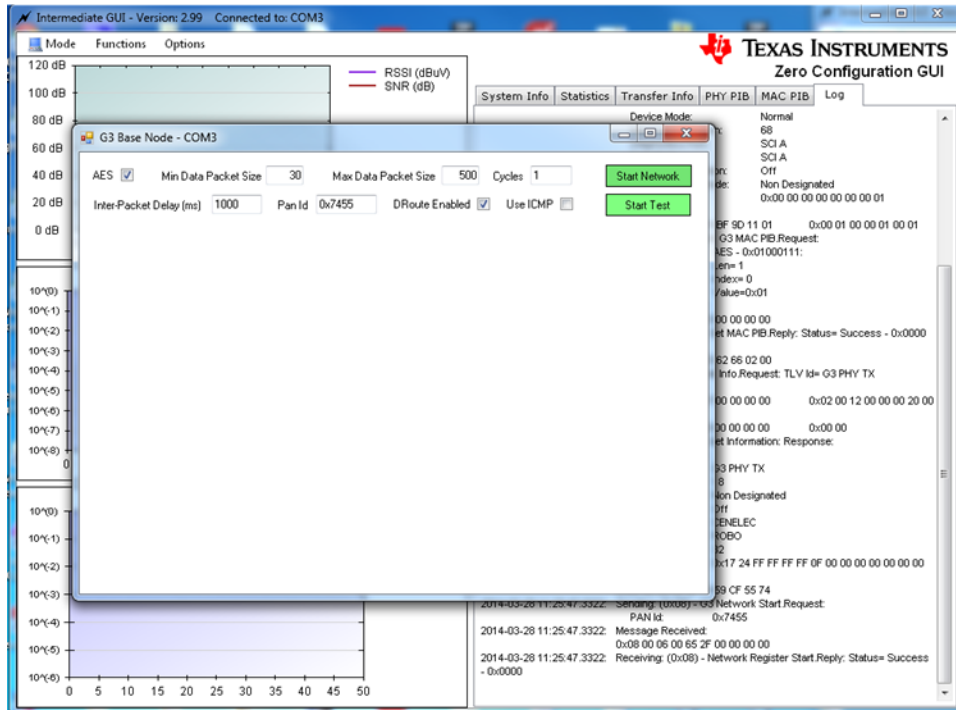

- Once the hybrid wireless M-Bus/PLC node is joined, the IPv6 information for the joined node will be available.

21. Joining Node Information

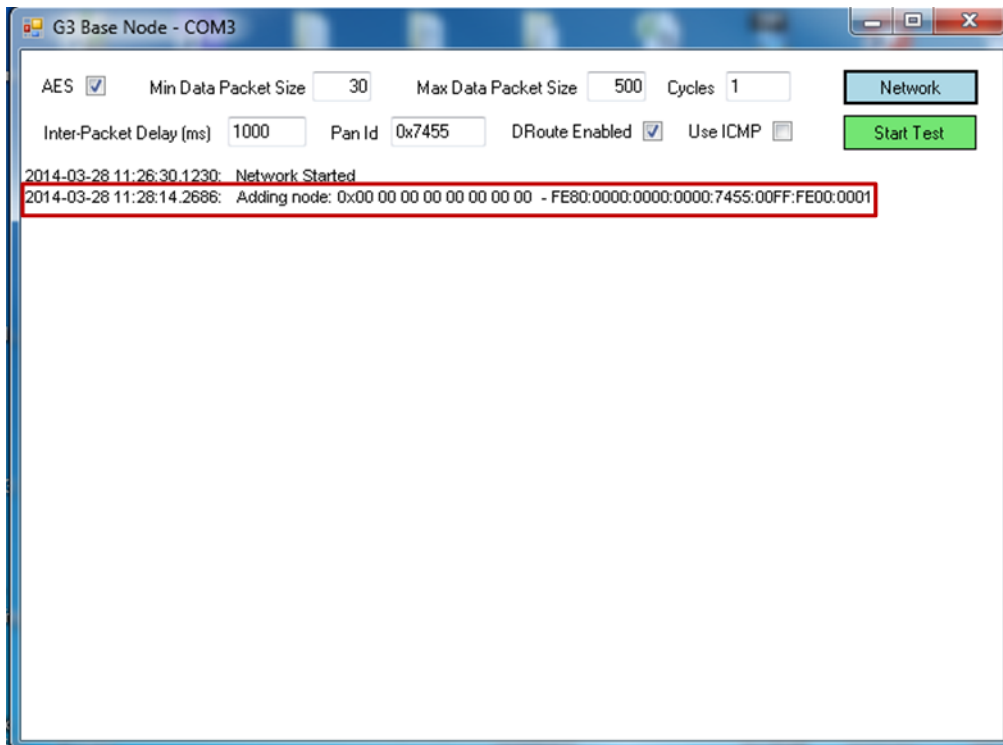

- Set the **Max Data Packet Size** to 184 due to the maximum size limitation of the wireless M-Bus specification. Then, start data echo-back testing by selecting **Start Test**.

☒ 22. Start Data Echo-Back Test

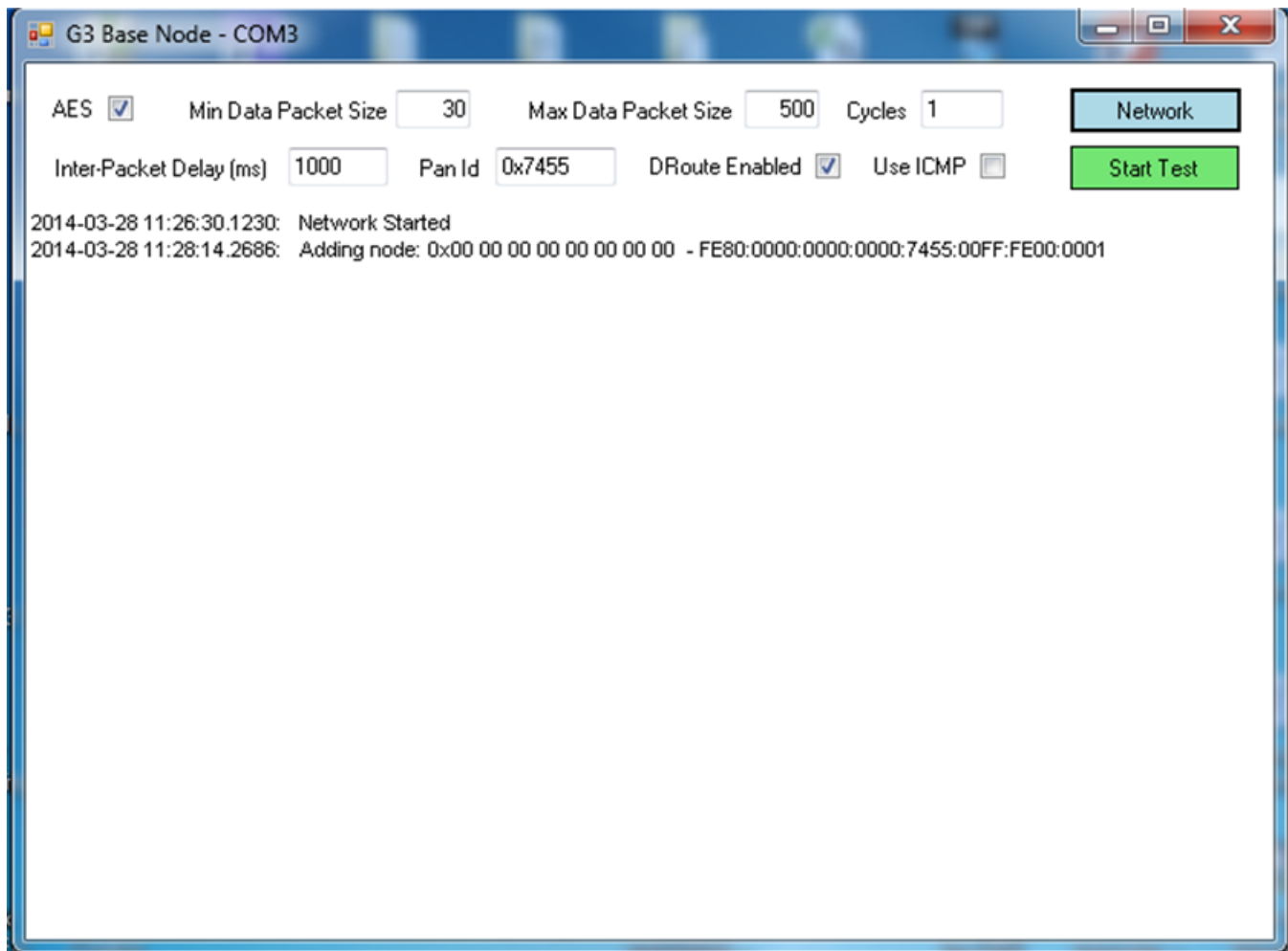

5.3 Hybrid Wireless M-Bus/PLC Test Results

This section shows the hybrid wireless M-Bus/PLC test results to verify wireless M-Bus/PLC repeater functionality.

Figure 27 shows the echo-back test results. For the testing, mini-DC configures minimum packet size to 6B, maximum packet size to 184B, test cycles to 1000 cycles, and the packet interval to 2000 msec. The packet size increases by 1B every transmission. As shown in the result, all the data is successfully echo-backed through the RF and PLC mixed paths, which proves that the hybrid wireless M-Bus/PLC routes the PLC and wireless M-Bus packets between the PLC only and wireless M-Bus only nodes.

図 23. Hybrid Wireless M-Bus and PLC Echo-Back Test Result

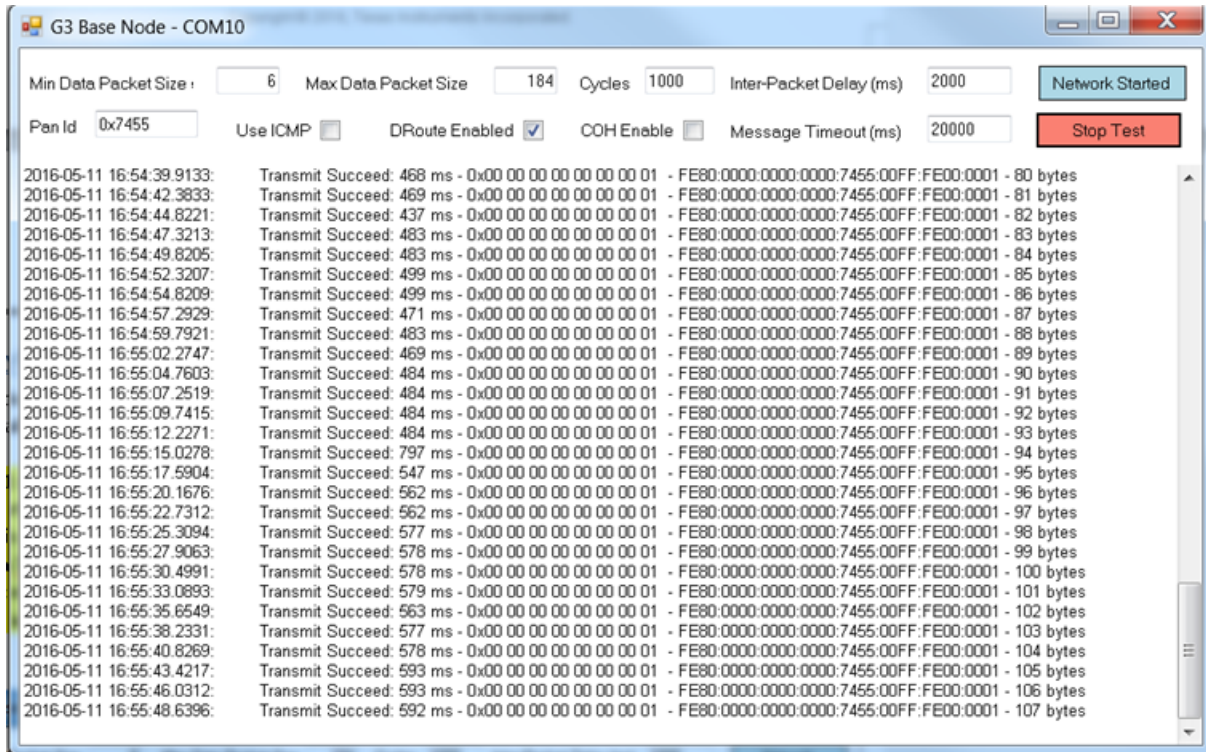

6 Design Files

6.1 Schematics

To download the schematics, refer to the [TIDC-HYBRID-WMBUS-PLC](#) design files.

6.2 Bill of Materials

To download the bill of materials (BOM), refer to the [TIDC-HYBRID-WMBUS-PLC](#) design files.

6.3 Layout Prints

To download the layout prints for each board, refer to the [TIDC-HYBRID-WMBUS-PLC](#) design files.

6.4 Gerber Files

To download the Gerber files, refer to the [TIDC-HYBRID-WMBUS-PLC](#) design files.

6.5 Assembly Drawings

To download the assembly drawings, refer to the [TIDC-HYBRID-WMBUS-PLC](#) design files.

7 Software Files

To download the software files, refer to the [TIDC-HYBRID-WMBUS-PLC](#) design files.

8 Related Documentation

1. Texas Instruments, *CC1310 SimpleLink™ Ultralow Power Sub-1-GHz Wireless MCU*, CC1310 Datasheet, [SWRS181](#)
2. Texas Instruments, *MS320F28PLC8x Power Line Communications (PLC) Processors*, TMS320F28PLC83/4 Datasheet, [SPRS802](#)
3. Texas Instruments, *Powerline Communications Analog Front-End*, TMS320F28PLC83/4 Datasheet, [SBOS531](#)
4. Texas Instruments, *System on Module for G3 Power Line Communication (CENELEC Frequency Band)*, TIDM-SOMPLC-G3-CENELEC Design Guide, [TIDU442](#)
5. Texas Instruments, *Hybrid RF and PLC Reference Design to Extend Network Coverage and Reliability*, TIDC-HYBRID-RF-PLC Design Guide, [TIDUBM3](#)

8.1 商標

E2E is a trademark of Texas Instruments.

9 Terminology

1. **PLC**: Power-line communication
2. **RF**: Radio frequency
3. **TMR**: Tone map request
4. **DC**: Data concentrator
5. **VCU**: Viterbi/complex math unit
6. **AMI**: Advanced metering infrastructure
7. **AFE**: Analog front end

10 About the Author

WONSOO KIM is a system engineer at Texas Instruments, where he is responsible for driving system solutions for Smart Grid applications, defining future requirements in the TI product roadmap, and providing system-level support and training focused on communication software and systems for Smart Grid customers. He received his Ph.D. in Electrical and Computer Engineering from the University of Texas at Austin in Austin, TX.

改訂履歴

資料番号末尾の英字は改訂を表しています。その改訂履歴は英語版に準じています。

2016年6月発行のものから更新	Page
• LAUNCHXL-CC1310DK を LAUNCHXL-CC1310 に変更	1
• TX/RX を TRX に変更	1
• LAUNCHXLCC1310DK TO LAUNCHXLCC1310 変更	9
• CC1310DK to LAUNCHXL-CC1310 変更	9
• CC1310DK to LAUNCHXL-CC1310 変更	9
• CC1310DK to LAUNCHXL-CC1310 変更	10
• text from and shows UART pins connections between TMDSPCLKITV4 and CC1310DK to shows UART pin on the TMDSPCLKITV4 connected to the LAUNCHXL-CC1310. 変更	10
• EM-UART_RX in P412 shown in the CC1310DK docking board to UART_RX pin (DIO 2) on the LAUNCHXL-CC1310 変更	10
• EM-UART_RX to UART_TX pin (DIO 3) on the LAUNCHXL-CC1310 変更	10
• one of the GND pins to The GND pin 変更	10
• GND in P412 () to GND pin on the LAUNCHXL-CC1310 変更	10
• software example (TI_Hybrid_WMBUS_PLC_example) to HYBRID-WMBUS-PLC software example 変更	12
• paragraph 追加	12
• Figure 10 and 11 追加	12
• title from Hybrid_WMBUS_PLC_Project to TIDC-HYBRID-WMBUS-PLC Software example. Changed paragraph text. 変更	13
• paragraph text 変更	13
• paragraph text 変更	13
• paragraph text 変更	15
• paragraph text 変更	15
• four to two 変更	15
• CC1310DK to LAUNCHXL-CC-1310 変更	15
• title and paragraph 変更	16
• title from Hybrid_WMBUS_PLC to HYBRID-WMBUS-LC CCS 変更	16
• hybrid wireless M Bus/PLC to HYBRID-WMBUS-PLC software 変更	16
• CC1310DK to LAUNCHXL-CC1310 EVM 変更	16
• paragraph text 変更	16
• paragraph text 変更	16
• paragraph text 変更	17
• CC1310DK to LAUNCHXL-CC1310 変更	17
• with 追加	17
• (and) 削除	17
• paragraph text 変更	17
• paragraph text 削除	17
• paragraph text 追加	18
• and deleted text 追加	18

重要なお知らせと免責事項

TI は、技術データと信頼性データ(データシートを含みます)、設計リソース(リファレンス・デザインを含みます)、アプリケーションや設計に関する各種アドバイス、Web ツール、安全性情報、その他のリソースを、欠陥が存在する可能性のある「現状のまま」提供しており、商品性および特定目的に対する適合性の黙示保証、第三者の知的財産権の非侵害保証を含むいかなる保証も、明示的または黙示的にかかわらず拒否します。

これらのリソースは、TI 製品を使用する設計の経験を積んだ開発者への提供を意図したものです。(1) お客様のアプリケーションに適した TI 製品の選定、(2) お客様のアプリケーションの設計、検証、試験、(3) お客様のアプリケーションに該当する各種規格や、その他のあらゆる安全性、セキュリティ、規制、または他の要件への確実な適合に関する責任を、お客様のみが単独で負うものとし、

上記の各種リソースは、予告なく変更される可能性があります。これらのリソースは、リソースで説明されている TI 製品を使用するアプリケーションの開発の目的でのみ、TI はその使用をお客様に許諾します。これらのリソースに関して、他の目的で複製することや掲載することは禁止されています。TI や第三者の知的財産権のライセンスが付与されている訳ではありません。お客様は、これらのリソースを自身で使用した結果発生するあらゆる申し立て、損害、費用、損失、責任について、TI およびその代理人を完全に補償するものとし、TI は一切の責任を拒否します。

TI の製品は、[TI の販売条件](#)、または [ti.com](https://www.ti.com) やかかる TI 製品の関連資料などのいずれかを通じて提供する適用可能な条項の下で提供されています。TI がこれらのリソースを提供することは、適用される TI の保証または他の保証の放棄の拡大や変更を意味するものではありません。

お客様がいかなる追加条項または代替条項を提案した場合でも、TI はそれらに異議を唱え、拒否します。

郵送先住所 : Texas Instruments, Post Office Box 655303, Dallas, Texas 75265

Copyright © 2022, Texas Instruments Incorporated