

## Design Guide: TIDA-010216

# 大容量アプリケーションに適したローサイド MOSFET 制御による 16s バッテリ・パックのリファレンス・デザイン



## 概要

このリファレンス・デザインは、消費電流が小さく、セル電圧の精度が高い、16S (16 個の直列) リチウムイオンまたは LiFePO4 バッテリ・パックです。各セルの電圧、パック電流、セルおよび MOSFET 温度を監視し、バッテリ・パックを保護して安全な使用を確保します。このリファレンス・デザインでは、5 対のローサイド N チャネル MOSFET を使うことで、放電電流を増やしています。このリファレンス・デザインはこれらの機能を通じて、大容量バッテリ・パック・アプリケーションへの高い適応性を実現しています。

## リソース

TIDA-010216	デザイン・フォルダ
BQ76952, LM5163	プロダクト・フォルダ
TPS54308, TPS7A24	プロダクト・フォルダ
ISO1042, ISO7731	プロダクト・フォルダ
THVD1400, MSP430FR2155	プロダクト・フォルダ
UCC27524, UCC27517	プロダクト・フォルダ
TMP61	プロダクト・フォルダ

## 特長

- スタンバイ・モードの消費電流: 100 $\mu$ A (MOSFET オフ)
- シップ・モードの消費電流: 10 $\mu$ A
- セル電圧誤差:  $\pm 5$ mV (25 $^{\circ}$ C、キャリブレーションなし)
- 電流精度:  $\pm 0.5\%$  (25 $^{\circ}$ C、電流 > 5A)
- 堅牢なセル保護機能とマルチシステム保護機能
- ローサイド N チャネル MOSFET による強力な駆動能力

## アプリケーション

- バッテリ・パック: 電動自転車、電動スクーター、軽電気自動車 (LEV)
- その他の産業用バッテリ・パック (10S 以上)
- ポータブル電源
- バッテリ・エネルギー・ストレージ・システム

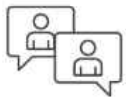

Ask our TI E2E™ support experts

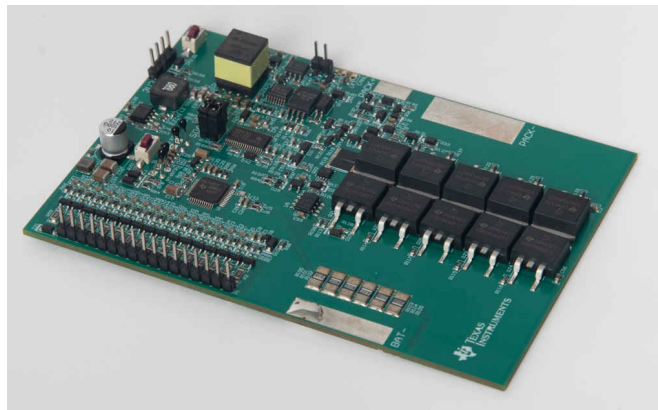
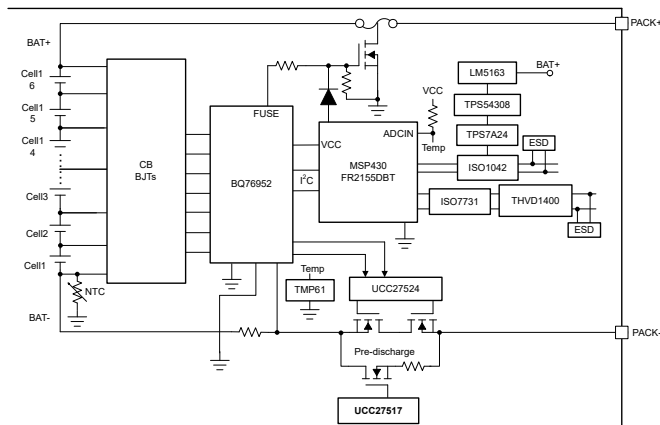

## 1 System Description

Li-ion and LiFePO<sub>4</sub> batteries are increasingly used in battery packs to achieve higher capacity and energy with equal or lower volumes and equal or lower weight for the following equipment:

- Telecom and servers battery backup unit (BBU)
- Energy Storage Systems (ESS)
- e-motorcycles
- Portable power stations

Each of these devices benefit from the higher power and energy density and safe and environmentally-friendly Li-ion and LiFePO<sub>4</sub> batteries. While this chemistry provides high energy density and thereby lower volume and weight as an advantage, these attributes are associated with safety concerns and a need more accurate and complicated monitoring and protections. These concerns include the following:

- Undervoltage (CUV)
- Cell overvoltage (COV)
- Overtemperature (OT)
- Both overcurrent in charge (OCC) and discharge (OCD)
- Short-circuit discharge (SCD)

All of these concerns contribute to accelerating cell degradation and can lead to thermal runaway and explosion.

Therefore, monitor the pack current, cell temperature, and the voltage of each cell in case of unusual situations. The battery pack must be protected against all these situations. Good measurement accuracy is always required, especially the cell voltage, pack current, and cell temperature. Precision is necessary for accurate protections and battery pack state of charge (SoC) and stage of health (SoH) calculations. This is especially true for LiFePO<sub>4</sub> battery pack applications because of the flat voltage. Another important feature for battery-powered applications is the current consumption, especially when in ship mode or standby mode. Lower current consumption saves more energy and gives longer storage time without discharging the battery too much.

This design focuses on very large capacity battery pack applications, such as BBU for telecommunications and servers, 48-V ESS, e-motorcycles, portable power station, and so forth. The design contains a BQ76952 battery monitor and protector to monitor each cell voltage, temperature, and pack current and protect the pack against all unusual situations. These situations include cell overvoltage, cell undervoltage, overtemperature, overcurrent in charge and discharge, and short-circuit discharge. Five pairs of N-channel MOSFETs are located in battery negative as switches to control the charge and discharge processes. With a 5-A sink and source current driver, this design has the capability to drive more MOSFETs to support larger battery capacity. This reference design supports isolated RS-485 communication to transfer battery pack data and receive commands and reserve isolated CAN transceiver to test the auxiliary power performance. This design does not support CAN communication since the MCU used in this design does not have an integrated CAN controller. This design carefully designs the auxiliary power architecture, which achieves very low ship mode (10  $\mu$ A) and standby mode (100  $\mu$ A) current consumption with a limited number of components and a simple control strategy.

## 2 System Overview

### 2.1 Block Diagram

Figure 2-1 shows the system diagram.

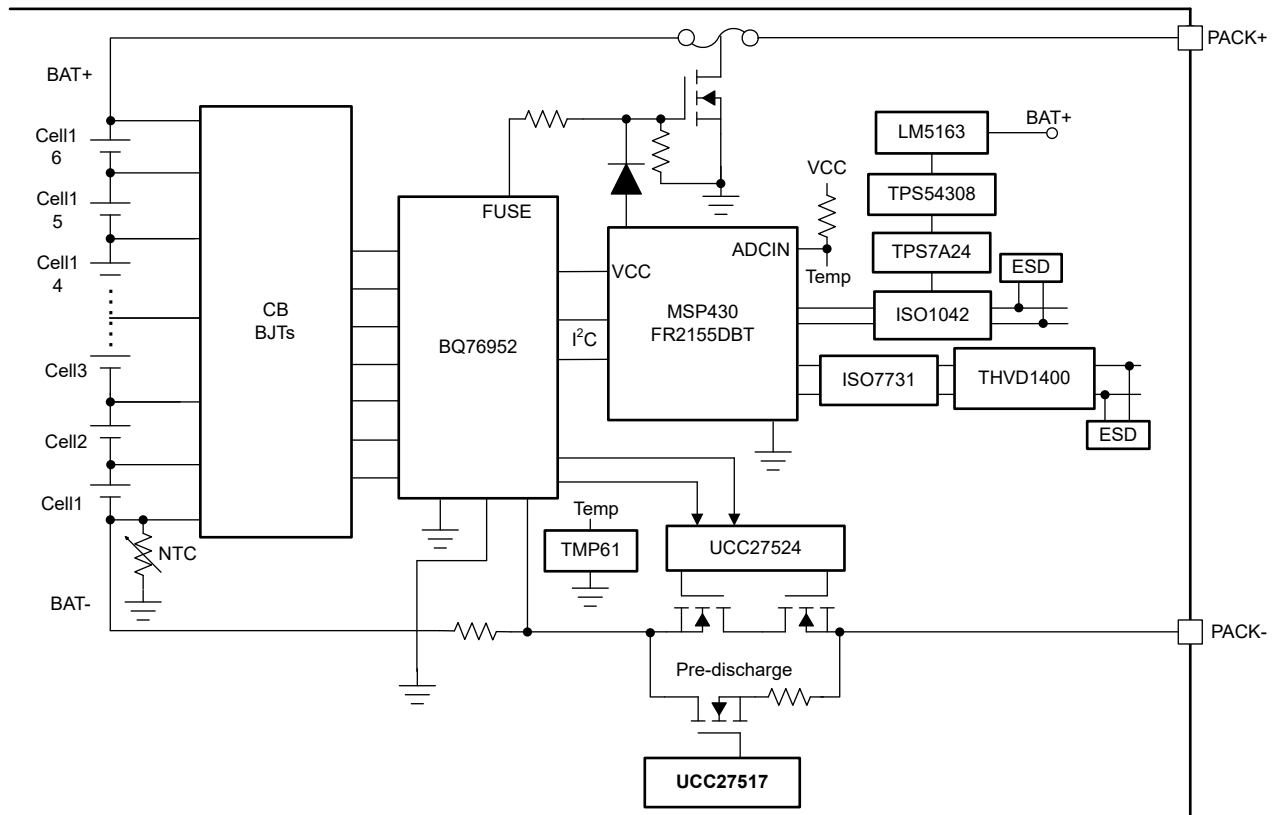
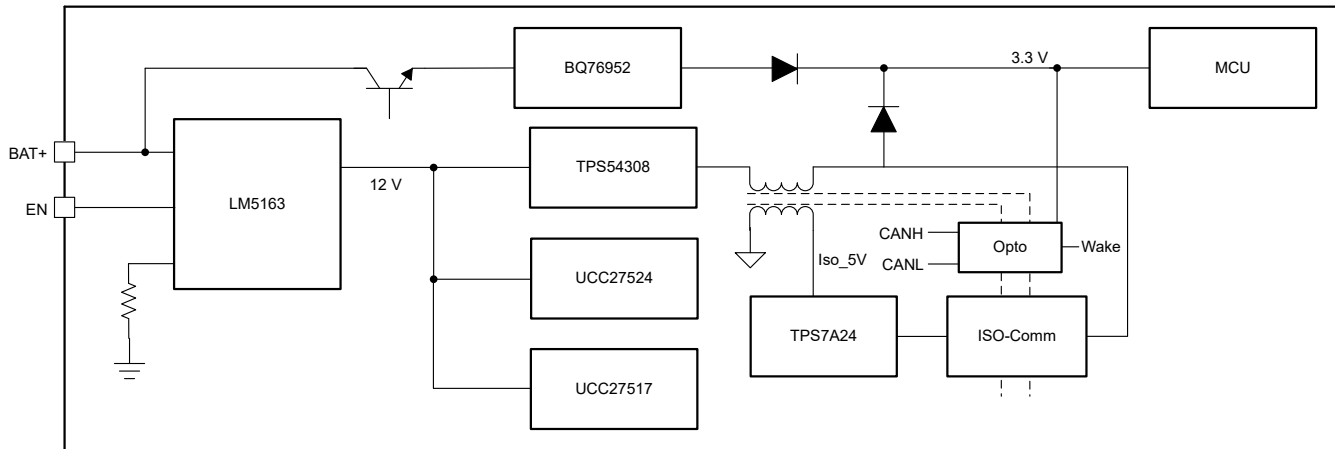

Figure 2-1. TIDA-010216 Block Diagram

The design uses the high-accuracy battery monitor and protector bq76952 from TI to monitor each cell voltage, pack current and temperature data, and protect the battery pack from all unusual situations, including: COV, CUV, OT, overcurrent in charge and discharge and short-circuit discharge. There is a lower-power MSP430™ MCU MSP430FR2155 which communicates with the monitor, deal with all system control strategy, and upload all the requested information to the system side. This design supports isolated RS-485 communication with a three-channel digital isolator ISO7731 and a RS-485 transceiver THVD1400 for better flexibility. An isolated CAN transceiver is also present to test auxiliary power circuit performance. Five pairs of N-Channel MOSFETs are driven by a dual-channel 5-A sink and source current low-side driver (UCC27524) for fast MOSFET turn on and off. Another low side driver, the UCC27517, is used to drive pre-discharge MOSFET on and off. This design uses a 100-V input, 0.5-A, ultra-low IQ synchronous Buck DC/DC converter LM5163 to step down battery voltage to power MOSFET drivers. A fly-buck converter TPS54308 is used to generate a non-isolated 3.3 V to power MSU and an isolated 5 V to power isolated communication transceivers. A low I<sub>Q</sub> LDO TPS7A24 makes the isolated output voltage stable. A ±1%, 10-kΩ linear thermistor with positive temperature coefficient and 0603 package TMP61 is utilized to monitor the MOSFET temperature and measured by the MCU ADC.

## 2.2 Design Considerations

An important design consideration is the use of auxiliary power. With the need for low current consumption in standby mode and ship mode, and good thermal performance in normal mode, this design uses the auxiliary power strategy shown in [Figure 2-2](#).



**Figure 2-2. Auxiliary Power Architecture**

When the system is working in normal mode, the LM5163 buck DC/DC converter steps down the total battery voltage to 12 V to power the low-side MOSFET drivers – UCC27524 and UCC27517. A fly-back converter generates a non-isolated 3.3 V to power the MCU and an isolated 5 V is available for isolated communications with the TPS54308 from 12 V. The TPS7A24, a low  $I_Q$  LDO, regulates isolated rail output of the fly-back to a stable 5 V to power isolated transceivers. In standby mode, the MOSFETs are in off state, isolated communications are not available.

The LM5163 is disabled through the EN pin and the TPS54308, UCC27524, UCC27517 devices are powered off to save energy. The bq76952 device outputs 3.3 V through one regulator to power the MCU which is in lower power mode. If MOSFETs are required to be on in standby mode to enable a fast discharge response, the LM5163 device is still enabled to power 12 V for the driver IC. At this time the TPS54308 is disabled through the EN pin to power off isolated communications to save power. If further lower standby current is needed, a lower current consumption driving circuit can be used. For more information, see the [Using Low-Side FETs with the BQ769x2 Battery Monitor Family](#) application note.

The series diode on the BQ76952 regulator output makes sure that all power is from the DC/DC converter in normal mode preventing the BQ76952 regulator circuits from overheating. Therefore, design the DC/DC output a little higher than the 3.3 V BQ76952 regulator output. Detailed component design guidance is available from the [LM5163 and LM5164 converter quickstart design tool](#). When the system experiences a serious cell undervoltage and must enter ship mode, the MCU configures the BQ76952 device to enter shutdown mode through an I2C command or RST\_SHUT pin and disables LM5163 output through the EN pin. This configures the system to very low current consumption mode. This design supports the charger attach wake up function. When charger is attached, the BQ76952 wakes up and enables normal 5-V regulator output. The MCU is then powered on and enables the LM5163 through the EN pin. The whole system then returns to normal mode.

## 2.3 Highlighted Products

### 2.3.1 BQ76952

The BQ76952 device is a highly-integrated, high-accuracy battery monitor and protector for 3-series to 16-series Li-Ion, Li-Polymer, and LiFePO<sub>4</sub> battery packs. The device includes a high-accuracy monitoring system, a highly-configurable protection subsystem, and support for autonomous or host controlled cell balancing. Integration includes high-side charge-pump NFET drivers, dual programmable LDOs for external system use, and a host communication peripheral supporting 400-kHz I<sup>2</sup>C, SPI, and HDQ one-wire standards. The BQ76952 device is available in a 48-pin TQFP package.

### 2.3.2 LM5163

The LM5163 synchronous buck converter is designed to regulate over a wide input voltage range, minimizing the need for external surge suppression components. A minimum controllable on-time of 50 ns facilitates large step-down conversion ratios, enabling the direct step-down from a 48-V nominal input to low-voltage rails for reduced system complexity and cost. The LM5163 operates during input voltage dips as low as 6 V, at nearly 100% duty cycle if needed, making the device an excellent choice for wide input supply range industrial and high cell count battery pack applications. With integrated high-side and low-side power MOSFETs, the LM5163 delivers up to 0.5-A of output current. A constant on-time (COT) control architecture provides nearly constant switching frequency with excellent load and line transient response. Additional features of the LM5163 include ultra-low IQ and diode emulation mode operation for high light-load efficiency, remarkable peak and valley overcurrent protection, integrated VCC bias supply and bootstrap diode, precision enable and input UVLO, and thermal shutdown protection with automatic recovery. The LM5163 is available in a thermally-enhanced, 8-pin SO PowerPAD™ integrated circuit package.

### 2.3.3 MSP430FR2155

The MSP430FR215x micro-controller (MCUs) is part of the MSP430™ MCU value line portfolio of ultra-low power low-cost devices for sensing and measurement applications. The device includes a 12-channel, 12-bit ADC and two comparators. The MSP430FR215x supports an extended temperature range from -40° up to 105°C, so higher temperature industrial applications can benefit from the FRAM data-logging capabilities of the device. The extended temperature range allows developers to meet requirements of applications such as smoke detectors, sensor transmitters, and circuit breakers. The MSP430FR215x features a powerful 16-bit RISC CPU, 16-bit registers, and a constant generator that contribute to maximum code efficiency. The digitally-controlled oscillator (DCO) allows the device to wake up from low-power modes to active mode typically in less than 10 μs. The MSP430 ultra-low-power (ULP) FRAM microcontroller platform combines uniquely embedded FRAM and a holistic ultra-low-power system architecture, allowing system designers to increase performance while lowering energy consumption. FRAM technology combines the low-energy fast writes, flexibility, and endurance of RAM with the nonvolatile behavior of flash. MSP430FR215x is supported by an extensive hardware and software ecosystem with reference designs and code examples to get your design started quickly.

### 2.3.4 ISO1042

The ISO1042 device is a galvanically-isolated controller area network (CAN) transceiver that meets the specifications of the ISO11898-2 (2016) standard. The ISO1042 device offers ±70-V DC bus fault protection and ±30-V common-mode voltage range. The device supports up to 5-Mbps data rate in CAN FD mode allowing much faster transfer of payload compared to classic CAN. This device uses a silicon dioxide (SiO<sub>2</sub>) insulation barrier with a withstand voltage of 5000 V<sub>RMS</sub> and a working voltage of 1060 V<sub>RMS</sub>. Electromagnetic compatibility has been significantly enhanced to enable system-level ESD, EFT, surge, and emissions compliance. Used in conjunction with isolated power supplies, the device protects against high voltage, and prevents noise currents from the bus from entering the local ground. The ISO1042 device is available for both basic and reinforced isolation (see Reinforced and Basic Isolation Options). The ISO1042 device supports a wide ambient temperature range of -40°C to +125°C. The device is available in the SOIC-16 (DW) package and a smaller SOIC-8 (DWV) package.

### 2.3.5 TPS54308

The TPS54308 is a 4.5-V to 28-V input voltage range, 3-A synchronous buck converter. The device includes two integrated switching FETs, internal loop compensation and 5-ms internal soft start to reduce component count. By integrating the MOSFETs and employing the SOT-23 package, the TPS54308 achieves the high power density and offers a small footprint on the PCB. The TPS54308 operates in force continuous conduction mode (FCCM) during light load conditions, the switching frequency is maintained at an almost constant level over entire load range. Cycle-by-cycle current limit in both high-side MOSFET protects the converter in an overload condition and is enhanced by a low-side MOSFET freewheeling current limit which prevents current runaway. Hiccup mode protection is triggered if the overcurrent condition has persisted for longer than the present time.

### 2.3.6 ISO7731

The ISO773x devices are high-performance, triple-channel digital isolators with 5000 VRMS (DW package) and 3000-VRMS (DBQ package) isolation ratings per UL 1577. This family includes devices with reinforced insulation ratings according to VDE, CSA, TUV and CQC. The ISO7731B device is designed for applications that require basic insulation ratings only. The ISO773x family of devices provides high electromagnetic immunity and low emissions at low power consumption, while isolating CMOS or LVCMOS digital I/Os. Each isolation channel has a logic input and output buffer separated by a double capacitive silicon dioxide (SiO<sub>2</sub>) insulation barrier. This device comes with enable pins which can be used to put the respective outputs in high impedance for multi-controller driving applications and to reduce power consumption.

### 2.3.7 THVD1400

The THVD1400 and THVD1420 devices are robust half-duplex RS-485 transceivers for industrial applications. The bus pins are immune to high levels of IEC Contact Discharge ESD events, eliminating the need for additional system level protection components. The devices operate from a single 3-V to 5.5-V supply. The wide common-mode voltage range and low input leakage on bus pins make the devices an excellent choice for multi-point applications over long cable runs. The THVD1400 and THVD1420 are available in industry standard, 8-pin SOIC package for drop-in compatibility as well as in the industry-leading, small SOT package. The devices are characterized for ambient temperatures from -40°C to 125°C.

### 2.3.8 UCC27524

The UCC2752x family of devices are dual-channel, high-speed, low-side gate-driver devices capable of effectively driving MOSFET and IGBT power switches. Using a design that inherently minimizes shoot-through current, the UCC2752x can deliver high-peak current pulses of up to 5-A source and 5-A sink into capacitive loads along with rail-to-rail drive capability and extremely small propagation delay (typically 13 ns). In addition, the drivers feature matched internal propagation delays between the two channels. These delays are designed for applications requiring dual-gate drives with critical timing, such as synchronous rectifiers. This also enables connecting two channels in parallel to effectively increase current-drive capability or driving two switches in parallel with one input signal. The input pin thresholds are based on TTL and CMOS compatible low-voltage logic, which is fixed and independent of the VDD supply voltage. Wide hysteresis between the high and low thresholds offers excellent noise immunity.

### 2.3.9 TMP61

The TMP61 linear thermistor offers linearity and consistent sensitivity across temperature to enable simple and accurate methods for temperature conversion. The low power consumption and a small thermal mass of the device minimize the impact of self-heating. With built-in fail-safe behaviors at high temperatures and powerful immunity to environmental variation, these devices are designed for a long lifetime of high performance. The small size of the TMP6 series also allows for close placement to heat sources and quick response times. Take advantage of benefits over NTC thermistors such as no extra linearization circuitry, minimized calibration, less resistance tolerance variation, larger sensitivity at high temperatures, and simplified conversion methods to save time and memory in the processor. The TMP61 is currently available in a 0402 footprint, a 0603 footprint and a 2-pin through-hole TO-92S package.



### 3 Hardware, Software, Testing Requirements, and Test Results

The key performances of the TIDA-010216 were tested in a TI lab, the end equipment used and test processes and results are described in this section.

表 3-1 describes the connections for TIDA-010216 board.

**表 3-1. Board Connections**

CONNECTOR AND PIN ASSIGNMENTS	FUNCTION OR SCHEMATIC NET	NOTES
BAT-	BAT-	Cell stack negative; this provides a reference for the electronics and the high current path from the cells
PACK+	PACK+	Charger positive or load positive
PACK-	PACK-	Charger negative or load negative
P1	Cn	(n = 0 to 16) Cell monitor, balance, and electronics power connections.
P2-1	RS485-A	RS485 Bus I/O port, A
P2-2	RS485-B	RS485 Bus I/O port, B
P3-1	CAN-L	Low-level CAN BUS
P3-2	CAN-H	High-level CAN BUS
P4-1	3V3	SBW program connector 3.3 V
P4-2	SBIO	SBW program connector SBIO
P4-3	SBCLK	SBW program connector SBCLK
P4-4	GND	SBW program connector ground
P5-1	SDA	I2C communication SDA from bq76952, bq76942, and bq769142, connect SDA_MCU or EV2400 SDA
P5-2	SDA_MCU	I2C communication SDA from MCU
P5-3	SCL	I2C communication SCL from bq76952, bq76942, and bq769142, connect SCL_MCU or EV2400 SCL
P5-4	SCL_MCU	I2C communication SCL from MCU

#### 3.1 Hardware Requirements

表 3-2 summarizes the equipment used for testing.

**表 3-2. Test Equipment Summary**

EQUIPMENT	MODEL OR DESCRIPTION
Oscilloscope	Tektronix DPO 2024B
DC Power supply	Chroma 62050P-100-100
Electronic load	Chroma 63106
Multimeter	Agilent 34401A
DC Power supply	DAHUA DH1718G-4
Communication adapter	Texas Instruments EV2300 or EV2400
MSP430 programmer	MSP430 LaunchPad™ Development Kit
ESD Simulator	NoiseKen ESS-S3011

The *Battery Management Studio (bqStudio) Software* is recommended when debugging the board for the first time.

### 3.2 Test Setup

Use the following procedures before running this design board. The design was constructed with 16s pack configurations. The board was tested using DC source and 4900- $\mu$ F electrolytic capacitor in parallel to simulate the total pack. Sixteen 1-k $\Omega$  resistors in series are used to divide the pack voltage and simulate 16s battery cells.

☒ 3-1 shows the charge process setup example.

- DC source 1 configurations: 58 V – 3 A
- DC source 2 configurations: 48 V – 0.5 A
- Electronic load configurations: 48-V CV mode

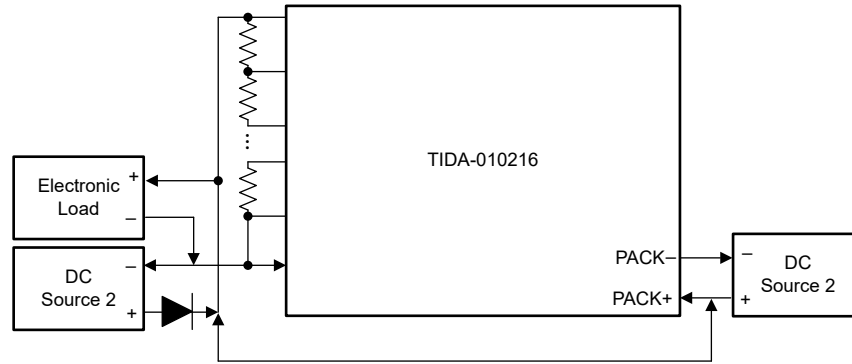

☒ 3-1. Charge Setup

☒ 3-2 shows the discharge process setup example.

- DC source 1 configurations: 48 V, 20 A
- Electronic load configurations: CC mode

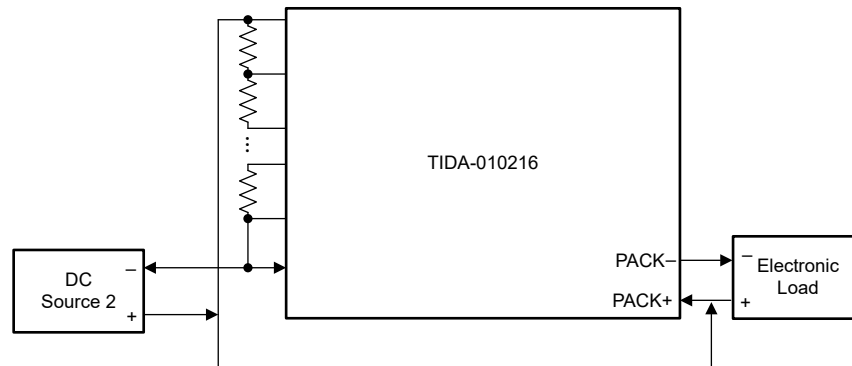

☒ 3-2. Discharge Setup



### 3.3 Test Results

#### 3.3.1 Cell Voltage Accuracy

This design does not perform any calibrations to further improve the cell voltage accuracy since the BQ76952 already achieves  $\pm 5$ -mV accuracy at 25°C and  $\pm 10$ -mV accuracy from 0°C to 60°C. So, the cell voltage accuracy is exactly the same with the BQ76952. More data is found in the [BQ76952 3-Series to 16-Series High Accuracy Battery Monitor and Protector for Li-Ion, Li-Polymer, and LiFePO4 Battery Packs](#) data sheet.

#### 3.3.2 Pack Current Accuracy

This design uses four 2-m $\Omega$ , 2-W, 50-PPM shunt resistors in parallel to measure pack current. Board offset was calibrated using the guidance of the *Calibration* section of the [BQ76952 Evaluation Module](#) user's guide. Then current gain was calibrated with 5-A discharging current and also followed the guidance of the *Calibration* section of the [BQ76952 Evaluation Module](#). Write the *board offset and current gain* values with OTP to the BQ76952, otherwise the MCU has to store such data and write to the BQ76952 every time the MCU wakes up from shutdown mode.  3-3 shows the pack current accuracy data under room temperature. The maximum current error is below  $\pm 30$  mA when discharging current is below 5 A and  $\pm 0.5\%$  when discharging current is above 5 A.

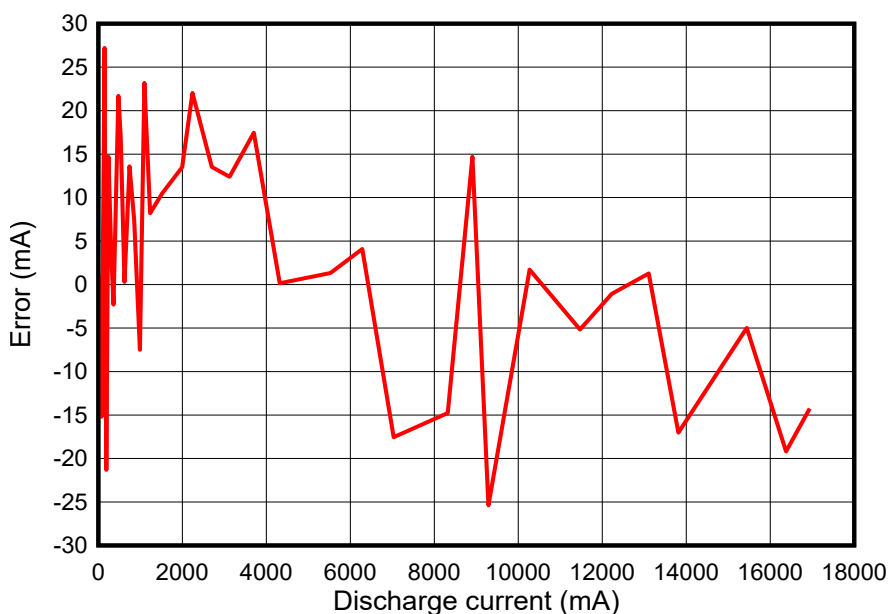

 3-3. Pack Current Accuracy

### 3.3.3 Auxiliary Power and System Current Consumption

Due to the auxiliary power strategy, this design has very low current consumption, especially when in standby mode and ship mode. System-level current consumption contains three parts: (1) DC/DC current, (2) BQ76952 current (current into BQ76952 BAT pin), and (3) LDO current (current into BQ76952 REGIN pin). This current can be measured from the voltage across (1) R78, (2) R54, and (3) R78. 表 3-3 shows the test results of current consumption.

表 3-3. Current Consumption

MODE	DESCRIPTION	R79 (100 Ω)	R54 (100 Ω)	R78 (309 Ω)	TOTAL CURRENT (μA)
Standby (MOSFET off)	Voltage (mV)	0.64	32	9.9	70.6
	Current (μA)	6.6	32	32	
Standby (MOSFET on)	Voltage (mV)	31	32	9.9	374
	Current (μA)	310	32	32	
Ship	Voltage (mV)	0.66	0	0	6.6
	Current (μA)	6.6	0	0	

Total current consumption is less than 100-μA in standby mode with both charge and discharge MOSFETs off. If both charge and discharge MOSFETs are required on in standby mode to secure zero discharge delay, the total current consumption is larger since driver circuit require several mA current. This design has about 400-μA total input current with both MOSFETs on. One way to decrease DC/DC input current is to decrease DC/DC switching frequency, circuits are reserved in this design. More drive circuit information is available in the [Using Low-Side FETs with the BQ769x2 Battery Monitor Family](#) application note.

図 3-4, 図 3-5, and 図 3-6 show the auxiliary circuit start-up and output ripple for both 12 V and 3.3 V.



図 3-4. Auxiliary Start-Up



図 3-5. 12-V Ripple

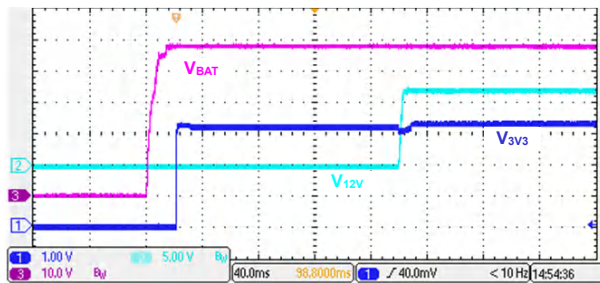

図 3-6. 3.3-V Ripple

### 3.3.4 Cell Balancing

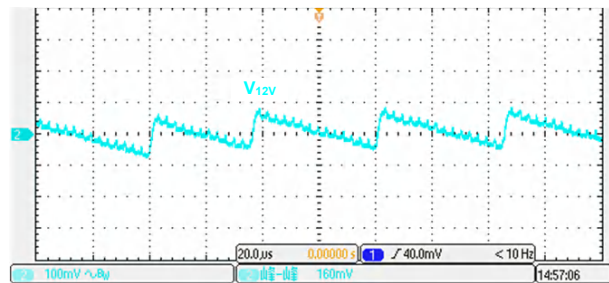
The design board supports external cell balancing with 16 NPN transistors. The peak balancing current is about 100 mA with 3.5-V cell voltage. This design only balances non-adjacent cells in use. The conditions that trigger cell balancing include: minimum cell voltage is larger than 3300 mV, maximum cell voltage gap is larger than 40 mV, and cell temperature is between  $-20^{\circ}\text{C}$  to  $60^{\circ}\text{C}$ .  3-7 shows cell balancing in normal mode. This design also supports cell balancing when no charging or discharging is occurring.  3-8 shows the cell balancing in standby mode.

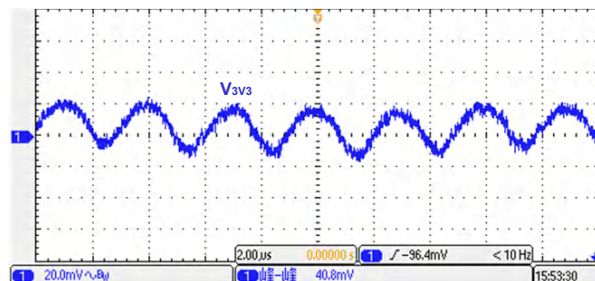
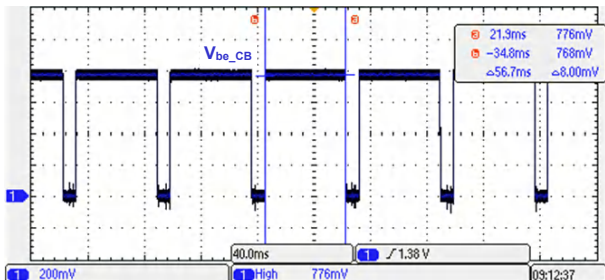
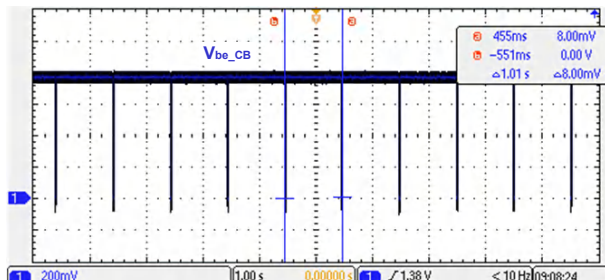
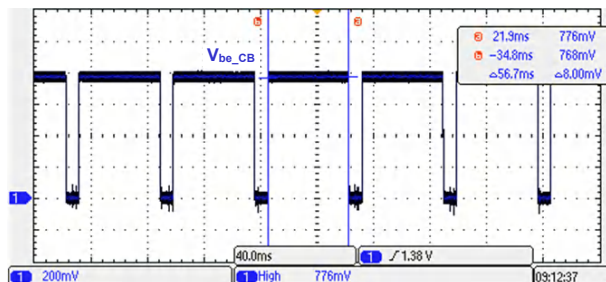

 3-7. Cell Balancing in Normal Mode

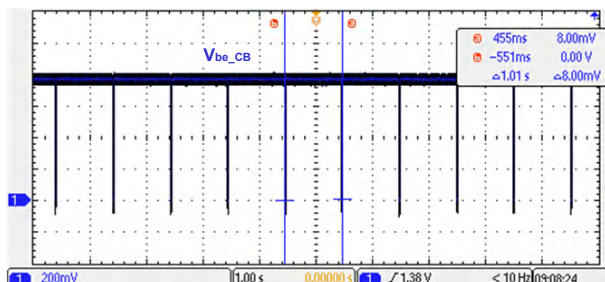

 3-8. Cell Balancing in Standby Mode

More cell balancing analysis is found in the [Cell Balancing With BQ769x2 Battery Monitors](#) application note.

### 3.3.5 Protection

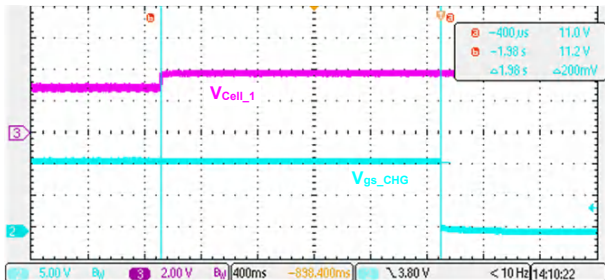
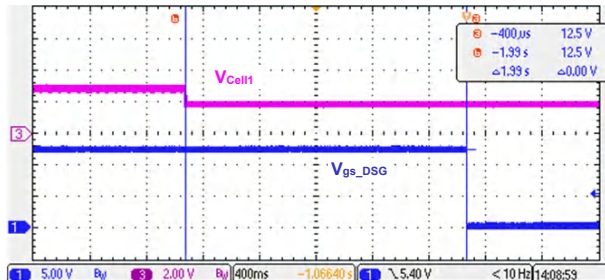
The design integrates a full set of battery cell protections, including: cell overvoltage, cell undervoltage, two levels of overcurrent discharge, overcurrent charge, discharge short circuit, overtemperature and undertemperature protections. Furthermore, this design also monitors lots of system-level faults, including: cell open wire, host watchdog, charge and discharge MOSFETs faults, MOSFETs overtemperature, and so on.  3-9 through  3-14 list some of the protections.

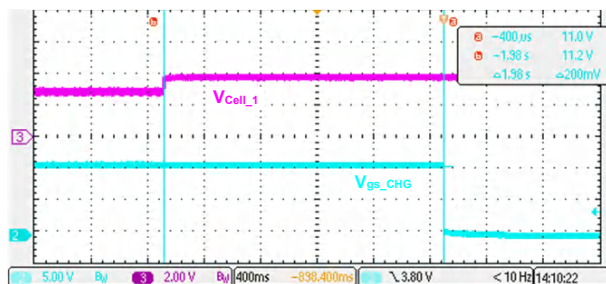

 3-9. Cell Overvoltage Protection

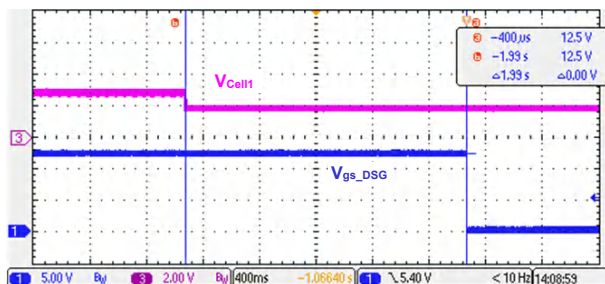

 3-10. Cell Undervoltage Protection

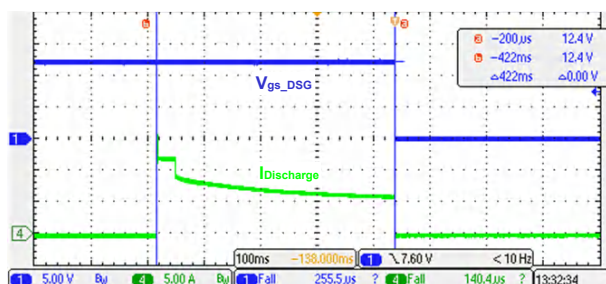

 3-11. Overcurrent Discharge Protection

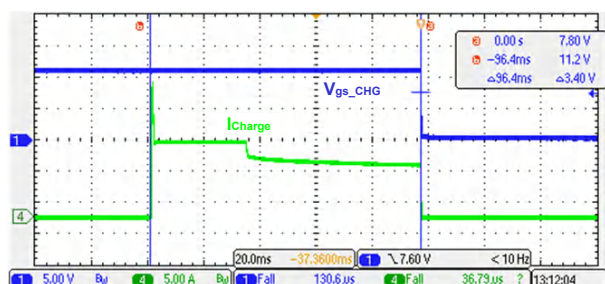

 3-12. Overcurrent Charger Protection



図 3-13. Short-Circuit Discharge Protection



図 3-14. Hardware Watchdog Protection

### 3.3.6 Working Modes Transition

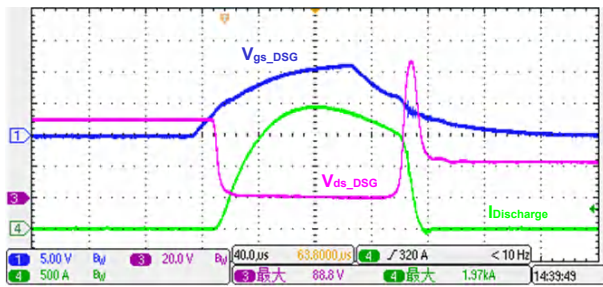
This design has three working modes: normal mode, standby mode, and ship mode. The pack is in normal mode when charging or discharging. The pack is in sleep mode is when not charging nor discharging, the pack is waiting for system attachment. Shutdown mode is a very low current consumption mode which saves energy and helps to avoid battery over discharge when the pack or cell voltage is low. 図 3-15 and 図 3-16 show different working mode transitions.

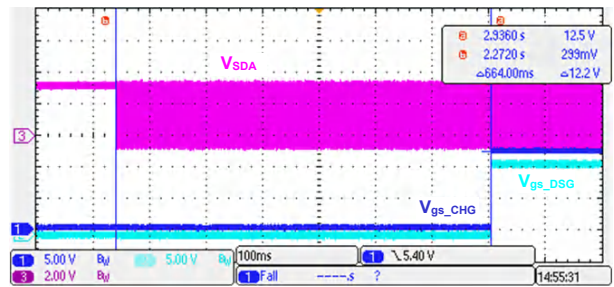

図 3-15. Ship Mode to Normal Mode



図 3-16. Capacitive Load Attach Detect

## 4 Design and Documentation Support

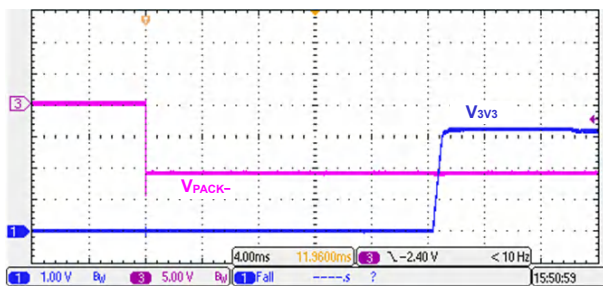
### 4.1 Design Files

#### 4.1.1 Schematics

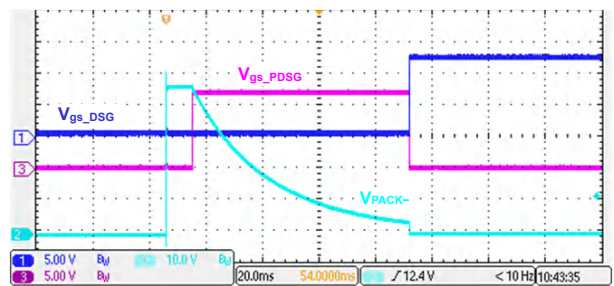
To download the schematics, see the design files at [TIDA-010216](#).

#### 4.1.2 BOM

To download the bill of materials (BOM), see the design files at [TIDA-010216](#).

### 4.2 Tools and Software

#### Tools

<a href="#">EV2400</a>	USB-based PC Interface Board for Battery Fuel (Gas) Gauge Evaluation Module
<a href="#">LM5163-LM5164DESIGN-CALC</a>	LM5163 and LM5164 converter quickstart design tool
<a href="#">BQ769X2-THERMISTOR-COEFF-CALCULATOR</a>	BQ76952, BQ76942 thermistor temperature optimizer - calculate the thermistors coefficients for T range

#### Software

<a href="#">BQSTUDIO</a>	Battery Management Studio (bqStudio) Software
<a href="#">CCSTUDIO</a>	Code Composer Studio™ integrated development environment (IDE)

### 4.3 Documentation Support

1. Texas Instruments, [BQ76952 3-Series to 16-Series High Accuracy Battery Monitor and Protector for Li-Ion, Li-Polymer, and LiFePO4 Battery Packs](#) data sheet
2. Texas Instruments, [Using Low-Side FETs with the BQ769x2 Battery Monitor Family](#) application note
3. Texas Instruments, [Cell Balancing With BQ769x2 Battery Monitors](#) application note
4. Texas Instruments, [Using DC/DC Buck Converters With Ultra-Low Quiescent Current for Industrial Battery-Pack Applications](#) application note

### 4.4 サポート・リソース

TI E2E™ サポート・フォーラムは、エンジニアが検証済みの回答と設計に関するヒントをエキスパートから迅速かつ直接得ることができる場所です。既存の回答を検索したり、独自の質問をしたりすることで、設計に必要な支援を迅速に得ることができます。

リンクされているコンテンツは、該当する貢献者により、現状のまま提供されるものです。これらは TI の仕様を構成するものではなく、必ずしも TI の見解を反映したものではありません。TI の [使用条件](#) を参照してください。

### 4.5 Trademarks

TI E2E™, MSP430™, PowerPAD™, LaunchPad™, Code Composer Studio™, and are trademarks of Texas Instruments.

すべての商標は、それぞれの所有者に帰属します。

## 5 About the Author

Ryan Tan is system manager covering the *Power Delivery* sector, Industrial SEM team. Ryan has over five years battery pack system design experience and has published several battery pack reference designs for e-bikes and e-scooters, garden tools, and server and telecom BBU applications.



## 重要なお知らせと免責事項

TI は、技術データと信頼性データ(データシートを含みます)、設計リソース(リファレンス・デザインを含みます)、アプリケーションや設計に関する各種アドバイス、Web ツール、安全性情報、その他のリソースを、欠陥が存在する可能性のある「現状のまま」提供しており、商品性および特定目的に対する適合性の黙示保証、第三者の知的財産権の非侵害保証を含むいかなる保証も、明示的または黙示的にかかわらず拒否します。

これらのリソースは、TI 製品を使用する設計の経験を積んだ開発者への提供を意図したものです。(1) お客様のアプリケーションに適した TI 製品の選定、(2) お客様のアプリケーションの設計、検証、試験、(3) お客様のアプリケーションに該当する各種規格や、その他のあらゆる安全性、セキュリティ、規制、または他の要件への確実な適合に関する責任を、お客様のみが単独で負うものとし、

上記の各種リソースは、予告なく変更される可能性があります。これらのリソースは、リソースで説明されている TI 製品を使用するアプリケーションの開発の目的でのみ、TI はその使用をお客様に許諾します。これらのリソースに関して、他の目的で複製することや掲載することは禁止されています。TI や第三者の知的財産権のライセンスが付与されている訳ではありません。お客様は、これらのリソースを自身で使用した結果発生するあらゆる申し立て、損害、費用、損失、責任について、TI およびその代理人を完全に補償するものとし、TI は一切の責任を拒否します。

TI の製品は、[TI の販売条件](#)、または [ti.com](https://www.ti.com) やかかる TI 製品の関連資料などのいずれかを通じて提供する適用可能な条項の下で提供されています。TI がこれらのリソースを提供することは、適用される TI の保証または他の保証の放棄の拡大や変更を意味するものではありません。

お客様がいかなる追加条項または代替条項を提案した場合でも、TI はそれらに異議を唱え、拒否します。

郵送先住所 : Texas Instruments, Post Office Box 655303, Dallas, Texas 75265

Copyright © 2022, Texas Instruments Incorporated