



Octal, 16-Bit, Low-Power, High-Voltage Output, Serial Input DIGITAL-TO-ANALOG CONVERTER

 Check for Samples: [DAC8718](#)

FEATURES

- **Bipolar Output: $\pm 2V$ to $\pm 16.5V$**
- **Unipolar Output: $0V$ to $+33V$**
- **16-Bit Resolution**
- **Low Power: 14.4mW/Ch (Bipolar Supply)**
- **Relative Accuracy: 4 LSB Max**
- **Low Zero/Full-Scale Error**
 - Before User Calibration: ± 10 LSB Max
 - After User Calibration: ± 1 LSB
- **Flexible System Calibration**
- **Low Glitch: 4nV-s**
- **Settling Time: 15 μ s**
- **Channel Monitor Output**
- **Programmable Gain: x4/x6**
- **Programmable Offset**
- **SPI™: Up to 50MHz, 1.8V/3V/5V Logic**
- **Schmitt Trigger Inputs**
- **Daisy-Chain with Sleep Mode Enhancement**
- **Packages: QFN-48 (7x7mm), TQFP-64 (10x10mm)**

APPLICATIONS

- **Automatic Test Equipment**
- **PLC and Industrial Process Control**
- **Communications**

DESCRIPTION

The DAC8718 is a low-power, octal, 16-bit digital-to-analog converter (DAC). With a 5V reference, the output can either be a bipolar $\pm 15V$ voltage when operating from dual $\pm 15.5V$ (or higher) power supplies, or a unipolar $0V$ to $+30V$ voltage when operating from a $+30.5V$ (or higher) power supply. With a 5.5V reference, the output can either be a bipolar $\pm 16.5V$ voltage when operating from dual $\pm 17V$ (or higher) power supplies, or a unipolar $0V$ to $+33V$ voltage when operating from a $+33.5V$ (or higher) power supply. This DAC provides low-power operation, good linearity, and low glitch over the specified temperature range of $-40^{\circ}C$ to $+105^{\circ}C$. This device is trimmed in manufacturing and has very low zero-code and gain error. In addition, system level calibration can be performed to achieve ± 1 LSB bipolar zero/full-scale error with bipolar supplies, or ± 1 LSB zero code/full-scale error with a unipolar supply, over the entire signal chain. The output range can be offset by using the DAC offset register.

The DAC8718 features a standard, high-speed serial peripheral interface (SPI) that operates at up to 50MHz and is 1.8V, 3V, and 5V logic compatible, to communicate with a DSP or microprocessor. The input data of the device are double-buffered. An asynchronous load input (\overline{LDAC}) transfers data from the DAC data register to the DAC latch. The asynchronous \overline{CLR} input sets the output of all eight DACs to AGND. The V_{MON} pin is a monitor output that connects to the individual analog outputs, the offset DAC, the reference buffer outputs, and two external inputs through a multiplexer (mux).

The DAC8718 is pin-to-pin and function-compatible with the [DAC8218](#) (14-bit) and the [DAC7718](#) (12-bit).

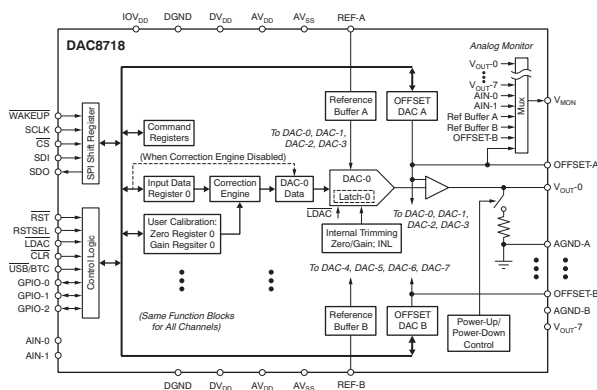

Please be aware that an important notice concerning availability, standard warranty, and use in critical applications of Texas Instruments semiconductor products and disclaimers thereto appears at the end of this data sheet.

DSP is a trademark of Texas Instruments.
 SPI, QSPI are trademarks of Motorola Inc.
 Microwire is a trademark of National Semiconductor.
 All other trademarks are the property of their respective owners.



This integrated circuit can be damaged by ESD. Texas Instruments recommends that all integrated circuits be handled with appropriate precautions. Failure to observe proper handling and installation procedures can cause damage.

ESD damage can range from subtle performance degradation to complete device failure. Precision integrated circuits may be more susceptible to damage because very small parametric changes could cause the device not to meet its published specifications.

ORDERING INFORMATION⁽¹⁾

PRODUCT	RELATIVE ACCURACY (LSB)	DIFFERENTIAL LINEARITY (LSB)	PACKAGE-LEAD	PACKAGE DESIGNATOR	SPECIFIED TEMPERATURE RANGE	PACKAGE MARKING
DAC8718	±4	±1	QFN-48	RGZ	-40°C to +105°C	DAC8718
	±4	±1	TQFP-64	PAG	-40°C to +105°C	DAC8718

(1) For the most current package and ordering information, see the Package Option Addendum at the end of this data sheet, or see the TI web site at www.ti.com.

ABSOLUTE MAXIMUM RATINGS⁽¹⁾

Over operating free-air temperature range (unless otherwise noted).

	DAC8718	UNIT		
AV _{DD} to AV _{SS}	-0.3 to 38	V		
AV _{DD} to AGND	-0.3 to 38	V		
AV _{SS} to AGND, DGND	-19 to 0.3	V		
DV _{DD} to DGND	-0.3 to 6	V		
IOV _{DD} to DGND	-0.3 to min of (6 or DV _{DD} + 0.3)	V		
AGND-x to DGND	-0.3 to 0.3	V		
Digital input voltage to DGND	-0.3 to IOV _{DD} + 0.3	V		
SDO to DGND	-0.3 to IOV _{DD} + 0.3	V		
V _{OUT-x} , V _{MON} , AIN-x to AV _{SS}	-0.3 to AV _{DD} + 0.3	V		
REF-A, REF-B to AGND	-0.3 to DV _{DD}	V		
GPIO-n to DGND	-0.3 to IOV _{DD} + 0.3	V		
GPIO-n input current	5	mA		
Maximum current from V _{MON}	3	mA		
Operating temperature range	-40 to +105	°C		
Storage temperature range	-65 to +150	°C		
Maximum junction temperature (T _J max)	+150	°C		
ESD ratings	Human body model (HBM)	2.5		
	Charged device model (CDM)	1000		
	Machine model (MM)	200		
Thermal impedance	Junction-to-ambient, θ _{JA}	TQFP	55	°C/W
		QFN	27.5	°C/W
	Junction-to-case, θ _{JC}	TQFP	21	°C/W
		QFN	10.8	°C/W
Power dissipation	(T _J max - T _A) / θ _{JA}	W		

(1) Stresses above those listed under *Absolute Maximum Ratings* may cause permanent damage to the device. Exposure to absolute maximum conditions for extended periods may affect device reliability.

ELECTRICAL CHARACTERISTICS: Dual-Supply

All specifications at $T_A = T_{MIN}$ to T_{MAX} , $AV_{DD} = +16.5V$, $AV_{SS} = -16.5V$, $IOV_{DD} = DV_{DD} = +5V$, REF-A and REF-B = +5V, gain = 6, AGND-x = DGND = 0V, data format = straight binary, and Offset DAC A and Offset DAC B are at default values⁽¹⁾, unless otherwise noted.

PARAMETER	CONDITIONS	DAC8718			UNIT
		MIN	TYP	MAX	
STATIC PERFORMANCE⁽²⁾					
Resolution		16			Bits
Linearity error	Measured by line passing through codes 0000h and FFFFh				±4 LSB
Differential linearity error	Measured by line passing through codes 0000h and FFFFh				±1 LSB
Bipolar zero error	$T_A = +25^\circ\text{C}$, before user calibration, gain = 6, code = 8000h				±10 LSB
	$T_A = +25^\circ\text{C}$, before user calibration, gain = 4, code = 8000h				±15 LSB
	$T_A = +25^\circ\text{C}$, after user calib., gain = 4 or 6, code = 8000h	±1			LSB
Bipolar zero error TC	Gain = 4 or 6, code = 8000h	±0.5			±2 ppm FSR/°C
Zero-code error	$T_A = +25^\circ\text{C}$, gain = 6, code = 0000h				±10 LSB
	$T_A = +25^\circ\text{C}$, gain = 4, code = 0000h				±15 LSB
Zero-code error TC	Gain = 4 or 6, code = 0000h	±0.5			±3 ppm FSR/°C
Gain error	$T_A = +25^\circ\text{C}$, gain = 6				±10 LSB
	$T_A = +25^\circ\text{C}$, gain = 4				±15 LSB
Gain error TC	Gain = 4 or 6	±1			±3 ppm FSR/°C
Full-scale error	$T_A = +25^\circ\text{C}$, before user calibration, gain = 6, code = FFFFh				±10 LSB
	$T_A = +25^\circ\text{C}$, before user calibration, gain = 4, code = FFFFh				±15 LSB
	$T_A = +25^\circ\text{C}$, after user calib., gain = 4 or 6, code = FFFFh	±1			LSB
Full-scale error TC	Gain = 4 or 6, code = FFFFh	±0.5			±3 ppm FSR/°C
DC crosstalk ⁽³⁾	Measured channel at code = 8000h, full-scale change on any other channel	0.2			LSB

- (1) Offset DAC A and Offset DAC B are trimmed in manufacturing to minimize the error for symmetrical output. The default value may vary no more than ±10 LSB from the nominal number listed in [Table 7](#). The Offset DAC pins are not intended to drive an external load, and must not be connected during dual-supply operation.
- (2) Gain = 4 and TC specified by design and characterization.
- (3) The DAC outputs are buffered by op amps that share common AV_{DD} and AV_{SS} power supplies. DC crosstalk indicates how much dc change in one or more channel outputs may occur when the dc load current changes in one channel (because of an update). With high-impedance loads, the effect is virtually immeasurable. Multiple AV_{DD} and AV_{SS} terminals are provided to minimize dc crosstalk.

ELECTRICAL CHARACTERISTICS: Dual-Supply (continued)

All specifications at $T_A = T_{MIN}$ to T_{MAX} , $AV_{DD} = +16.5V$, $AV_{SS} = -16.5V$, $IOV_{DD} = DV_{DD} = +5V$, REF-A and REF-B = +5V, gain = 6, AGND-x = DGND = 0V, data format = straight binary, and Offset DAC A and Offset DAC B are at default values ⁽¹⁾, unless otherwise noted.

PARAMETER	CONDITIONS	DAC8718			UNIT
		MIN	TYP	MAX	
ANALOG OUTPUT (V_{OUT-0} to V_{OUT-7})⁽⁴⁾					
Voltage output ⁽⁵⁾	$V_{REF} = +5V$	-15		+15	V
	$V_{REF} = +1.5V$	-4.5		+4.5	V
Output impedance	Code = 8000h			0.5	Ω
Short-circuit current ⁽⁶⁾			± 8		mA
Load current	See Figure 37		± 3		mA
Output drift vs time	$T_A = +25^\circ C$, device operating for 500 hours, full-scale output		3.4		ppm of FSR
	$T_A = +25^\circ C$, device operating for 1000 hours, full-scale output		4.3		ppm of FSR
Capacitive load stability				500	pF
Settling time	To 0.03% of FSR, $C_L = 200pF$, $R_L = 10k\Omega$, code from 0000h to FFFFh and FFFFh to 0000h		10		μs
	To 1 LSB, $C_L = 200pF$, $R_L = 10k\Omega$, code from 0000h to FFFFh and FFFFh to 0000h		15		μs
	To 1 LSB, $C_L = 200pF$, $R_L = 10k\Omega$, code from 7F00h to 8100h and 8100h to 7F00h		6		μs
Slew rate ⁽⁷⁾			6		V/ μs
Power-on delay ⁽⁸⁾	From $IOV_{DD} \geq +1.8V$ and $DV_{DD} \geq +2.7V$ to \overline{CS} low		200		μs
Power-down recovery time			60		μs
Digital-to-analog glitch ⁽⁹⁾	Code from 7FFFh to 8000h and 8000h to 7FFFh		4		nV-s
Glitch impulse peak amplitude	Code from 7FFFh to 8000h and 8000h to 7FFFh		5		mV
Channel-to-channel isolation ⁽¹⁰⁾	$V_{REF} = 4V_{PP}$, $f = 1kHz$		88		dB
DAC-to-DAC crosstalk ⁽¹¹⁾	DACs in the same group		7.5		nV-s
	DACs among different groups		1		nV-s
Digital crosstalk ⁽¹²⁾			1		nV-s
Digital feedthrough ⁽¹³⁾			1		nV-s
Output noise	$T_A = +25^\circ C$ at 10kHz, gain = 6		200		nV/ \sqrt{Hz}
	$T_A = +25^\circ C$ at 10kHz, gain = 4		130		nV/ \sqrt{Hz}
	0.1Hz to 10Hz, gain = 6		20		μV_{PP}
Power-supply rejection ⁽¹⁴⁾	$AV_{DD} = \pm 15.5V$ to $\pm 16.5V$		0.05		LSB

(4) Specified by design.

(5) The analog output range of V_{OUT-0} to V_{OUT-7} is equal to $(6 \times V_{REF} - 5 \times OUTPUT_OFFSET_DAC)$ for gain = 6. The maximum value of the analog output must not be greater than $(AV_{DD} - 0.5V)$, and the minimum value must not be less than $(AV_{SS} + 0.5V)$. All specifications are for a $\pm 16.5V$ power supply and a $\pm 15V$ output, unless otherwise noted.

(6) When the output current is greater than the specification, the current is clamped at the specified maximum value.

(7) Slew rate is measured from 10% to 90% of the transition when the output changes from 0 to full-scale.

(8) *Power-on delay* is defined as the time from when the supply voltages reach the specified conditions to when \overline{CS} goes low, for valid digital communication.

(9) *Digital-to-analog glitch* is defined as the amount of energy injected into the analog output at the major code transition. It is specified as the area of the glitch in nV-s. It is measured by toggling the DAC register data between 7FFFh and 8000h in straight binary format.

(10) *Channel-to-channel isolation* refers to the ratio of the signal amplitude at the output of one DAC channel to the amplitude of the sinusoidal signal on the reference input of another DAC channel. It is expressed in dB and measured at midscale.

(11) *DAC-to-DAC crosstalk* is the glitch impulse that appears at the output of one DAC as a result of both the full-scale digital code and subsequent analog output change at another DAC. It is measured with LDAC tied low and expressed in nV-s.

(12) *Digital crosstalk* is the glitch impulse transferred to the output of one converter as a result of a full-scale code change in the DAC input register of another converter. It is measured when the DAC output is not updated, and is expressed in nV-s.

(13) *Digital feedthrough* is the glitch impulse injected to the output of a DAC as a result of a digital code change in the DAC input register of the same DAC. It is measured with the full-scale digital code change without updating the DAC output, and is expressed in nV-s.

(14) The output must not be greater than $(AV_{DD} - 0.5V)$ and not less than $(AV_{SS} + 0.5V)$.

ELECTRICAL CHARACTERISTICS: Dual-Supply (continued)

All specifications at $T_A = T_{MIN}$ to T_{MAX} , $AV_{DD} = +16.5V$, $AV_{SS} = -16.5V$, $IOV_{DD} = DV_{DD} = +5V$, REF-A and REF-B = +5V, gain = 6, AGND-x = DGND = 0V, data format = straight binary, and Offset DAC A and Offset DAC B are at default values ⁽¹⁾, unless otherwise noted.

PARAMETER	CONDITIONS	DAC8718			UNIT
		MIN	TYP	MAX	
OFFSET DAC OUTPUT⁽¹⁵⁾ ⁽¹⁶⁾					
Voltage output	$V_{REF} = +5V$	0		5	V
Full-scale error	$T_A = +25^\circ C$		± 4		LSB
Zero-code error	$T_A = +25^\circ C$		± 2		LSB
Linearity error			± 6		LSB
Differential linearity error				± 1	LSB
ANALOG MONITOR PIN (V_{MON})					
Output impedance ⁽¹⁷⁾	$T_A = +25^\circ C$		2		k Ω
Three-state leakage current			100		nA
AUXILIARY ANALOG INPUT					
Input range		AV_{SS}		AV_{DD}	V
Input impedance (AIN-x to V_{MON})	$T_A = +25^\circ C$		2		k Ω
Input capacitance ⁽¹⁵⁾			4		pF
Input leakage current			30		nA
REFERENCE INPUT					
Reference input voltage range ⁽¹⁸⁾		1.0		5.5	V
Reference input dc impedance			10		M Ω
Reference input capacitance ⁽¹⁵⁾			10		pF
DIGITAL INPUT⁽¹⁵⁾					
High-level input voltage, V_{IH}	$IOV_{DD} = +4.5V$ to $+5.5V$	3.8	$0.3 + IOV_{DD}$		V
	$IOV_{DD} = +2.7V$ to $+3.3V$	2.3	$0.3 + IOV_{DD}$		V
	$IOV_{DD} = +1.7V$ to $2.0V$	1.5	$0.3 + IOV_{DD}$		V
Low-level input voltage, V_{IL}	$IOV_{DD} = +4.5V$ to $+5.5V$	-0.3	0.8		V
	$IOV_{DD} = +2.7V$ to $+3.3V$	-0.3	0.6		V
	$IOV_{DD} = +1.7V$ to $2.0V$	-0.3	0.3		V
Input current	\overline{CLR} , LDAC, \overline{RST} , \overline{CS} , and SDI			± 1	μA
	$\overline{USB/BTC}$, RSTSEL, and GPIO-n			± 5	μA
Input capacitance	\overline{CLR} , LDAC, \overline{RST} , \overline{CS} , and SDI		5		pF
	$\overline{USB/BTC}$ and RSTSEL		12		pF
	GPIO-n		14		pF
DIGITAL OUTPUT⁽¹⁵⁾					
High-level output voltage, V_{OH} (SDO)	$IOV_{DD} = +2.7V$ to $+5.5V$, sourcing 1mA	$IOV_{DD} - 0.4$		IOV_{DD}	V
	$IOV_{DD} = +1.8V$, sourcing 200 μA	1.6		IOV_{DD}	V
Low-level output voltage, V_{OL} (SDO)	$IOV_{DD} = +2.7V$ to $+5.5V$, sinking 1mA	0		0.4	V
	$IOV_{DD} = +1.8V$, sinking 200 μA	0		0.2	V
GPIO-n output voltage low, V_{OL}	1mA sink from IOV_{DD}		0.15		V
GPIO-n output voltage high, V_{OH}	10k Ω pull-up resistor to IOV_{DD}	$0.99 \times IOV_{DD}$			V
High-impedance leakage current	SDO and GPIO-n		± 5		μA
High-impedance output capacitance	SDO		5		pF
	GPIO-n		14		pF

(15) Specified by design.

(16) Offset DAC A and Offset DAC B are trimmed in manufacturing to minimize the error for symmetrical output. The default value may vary no more than ± 10 LSB from the nominal number listed in Table 7. The Offset DAC pins are not intended to drive an external load, and must not be connected during dual-supply operation.

(17) 8k Ω when V_{MON} is connected to Reference Buffer A or B, and 4k Ω when V_{MON} is connected to Offset DAC-A or -B.

(18) Reference input voltage $\leq DV_{DD}$.

ELECTRICAL CHARACTERISTICS: Dual-Supply (continued)

All specifications at $T_A = T_{MIN}$ to T_{MAX} , $AV_{DD} = +16.5V$, $AV_{SS} = -16.5V$, $IOV_{DD} = DV_{DD} = +5V$, REF-A and REF-B = +5V, gain = 6, AGND-x = DGND = 0V, data format = straight binary, and Offset DAC A and Offset DAC B are at default values ⁽¹⁾, unless otherwise noted.

PARAMETER	CONDITIONS	DAC8718			UNIT
		MIN	TYP	MAX	
POWER SUPPLY					
AV_{DD}		+4.5		+18	V
AV_{SS}		-18		-4.5	V
DV_{DD}		+2.7		+5.5	V
IOV_{DD} ⁽¹⁹⁾		+1.8		+5.5	V
AI_{DD}	Normal operation, midscale code, output unloaded		4.3	6	mA
	Power down, output unloaded		35		μ A
AI_{SS}	Normal operation, midscale code, output unloaded	-4	-2.7		mA
	Power down, output unloaded		35		μ A
DI_{DD}	Normal operation		78		μ A
	Power down		36		μ A
IOI_{DD}	Normal operation, $V_{IH} = IOV_{DD}$, $V_{IL} = DGND$		5		μ A
	Power down, $V_{IH} = IOV_{DD}$, $V_{IL} = DGND$		5		μ A
Power dissipation	Normal operation, $\pm 16.5V$ supplies, midscale code		115	165	mW
TEMPERATURE RANGE					
Specified performance		-40		+105	$^{\circ}$ C

(19) $IOV_{DD} \leq DV_{DD}$.

ELECTRICAL CHARACTERISTICS: Single-Supply

All specifications at $T_A = T_{MIN}$ to T_{MAX} , $AV_{DD} = +32V$, $AV_{SS} = 0V$, $IOV_{DD} = DV_{DD} = +5V$, REF-A and REF-B = +5V, gain = 6, AGND-x = DGND = 0V, data format = straight binary, and OFFSET-A = OFFSET-B = AGND, unless otherwise noted.

PARAMETER	CONDITIONS	DAC8718			UNIT
		MIN	TYP	MAX	
STATIC PERFORMANCE⁽¹⁾					
Resolution		16			Bits
Linearity error	Measured by line passing through codes 0100h and FFFFh			±4	LSB
Differential linearity error	Measured by line passing through codes 0100h and FFFFh			±1	LSB
Unipolar zero error	$T_A = +25^\circ C$, before user calibration, gain = 6, code = 0100h			±10	LSB
	$T_A = +25^\circ C$, before user calibration, gain = 4, code = 0100h			±15	LSB
	$T_A = +25^\circ C$, after user calib., gain = 4 or 6, code = 0100h		±1		LSB
Unipolar zero error TC	Gain = 4 or 6, code = 0100h		±0.5	±3	ppm FSR/°C
Gain error	$T_A = +25^\circ C$, gain = 6			±10	LSB
	$T_A = +25^\circ C$, gain = 4			±15	LSB
Gain error TC	Gain = 4 or 6		±1	±3	ppm FSR/°C
Full-scale error	$T_A = +25^\circ C$, before user calibration, gain = 6, code = FFFFh			±10	LSB
	$T_A = +25^\circ C$, before user calibration, gain = 4, code = FFFFh			±15	LSB
	$T_A = +25^\circ C$, after user calib., gain = 4 or 6, code = FFFFh		±1		LSB
Full-scale error TC	Gain = 4 or 6, code = FFFFh		±0.5	±3	ppm FSR/°C
DC crosstalk ⁽²⁾	Measured channel at code = 8000h, full-scale change on any other channel		0.2		LSB
ANALOG OUTPUT (V_{OUT-0} to V_{OUT-7})⁽³⁾					
Voltage output ⁽⁴⁾	$V_{REF} = +5V$	0		+30	V
	$V_{REF} = +1.5V$	0		+9	V
Output impedance	Code = 8000h			0.5	Ω
Short-circuit current ⁽⁵⁾			±8		mA
Load current	See Figure 84 and Figure 85		±3		mA
Output drift vs time	$T_A = +25^\circ C$, device operating for 500 hours, full-scale output		3.4		ppm of FSR
	$T_A = +25^\circ C$, device operating for 1000 hours, full-scale output		4.3		ppm of FSR
Capacitive load stability				500	pF
Settling time	To 0.03% of FSR, $C_L = 200pF$, $R_L = 10k\Omega$, code from 0100h to FFFFh and FFFFh to 0100h		10		μs
	To 1 LSB, $C_L = 200pF$, $R_L = 10k\Omega$, code from 0100h to FFFFh and FFFFh to 0100h		15		μs
	To 1 LSB, $C_L = 200pF$, $R_L = 10k\Omega$, code from 7F00h to 8100h and 8100h to 7F00h		6		μs
Slew rate ⁽⁶⁾			6		V/μs
Power-on delay ⁽⁷⁾	From $IOV_{DD} \geq +1.8V$ and $DV_{DD} \geq +2.7V$ to \overline{CS} low		200		μs
Power-down recovery time			90		μs
Digital-to-analog glitch ⁽⁸⁾	Code from 7FFFh to 8000h and 8000h to 7FFFh		4		nV-s
Glitch impulse peak amplitude	Code from 7FFFh to 8000h and 8000h to 7FFFh		5		mV
Channel-to-channel isolation ⁽⁹⁾	$V_{REF} = 4V_{PP}$, $f = 1kHz$		88		dB

- (1) Gain = 4 and TC specified by design and characterization.
- (2) The DAC outputs are buffered by op amps that share common AV_{DD} and AV_{SS} power supplies. DC crosstalk indicates how much dc change in one or more channel outputs may occur when the dc load current changes in one channel (because of an update). With high-impedance loads, the effect is virtually immeasurable. Multiple AV_{DD} and AV_{SS} terminals are provided to minimize dc crosstalk.
- (3) Specified by design.
- (4) The analog output range of V_{OUT-0} to V_{OUT-7} is equal to $(6 \times V_{REF})$ for gain = 6. The maximum value of the analog output must not be greater than $(AV_{DD} - 0.5V)$. All specifications are for a +32V power supply and a 0V to +30V output, unless otherwise noted.
- (5) When the output current is greater than the specification, the current is clamped at the specified maximum value.
- (6) Slew rate is measured from 10% to 90% of the transition when the output changes from 0 to full-scale.
- (7) *Power-on delay* is defined as the time from when the supply voltages reach the specified conditions to when \overline{CS} goes low, for valid digital communication.
- (8) *Digital-to-analog glitch* is defined as the amount of energy injected into the analog output at the major code transition. It is specified as the area of the glitch in nV-s. It is measured by toggling the DAC register data between 7FFFh and 8000h in straight binary format.
- (9) *Channel-to-channel isolation* refers to the ratio of the signal amplitude at the output of one DAC channel to the amplitude of the sinusoidal signal on the reference input of another DAC channel. It is expressed in dB and measured at midscale.

ELECTRICAL CHARACTERISTICS: Single-Supply (continued)

All specifications at $T_A = T_{MIN}$ to T_{MAX} , $AV_{DD} = +32V$, $AV_{SS} = 0V$, $IOV_{DD} = DV_{DD} = +5V$, REF-A and REF-B = +5V, gain = 6, AGND-x = DGND = 0V, data format = straight binary, and OFFSET-A = OFFSET-B = AGND, unless otherwise noted.

PARAMETER	CONDITIONS	DAC8718			UNIT
		MIN	TYP	MAX	
DAC-to-DAC crosstalk ⁽¹⁰⁾	DACs in the same group		10		nV-s
	DACs among different groups		1		nV-s
Digital crosstalk ⁽¹¹⁾			1		nV-s
Digital feedthrough ⁽¹²⁾			1		nV-s
Output noise	$T_A = +25^\circ\text{C}$ at 10kHz, gain = 6		200		nV/ $\sqrt{\text{Hz}}$
	$T_A = +25^\circ\text{C}$ at 10kHz, gain = 4		130		nV/ $\sqrt{\text{Hz}}$
	0.1Hz to 10Hz, gain = 6		20		μV_{PP}
Power-supply rejection ⁽¹³⁾	$AV_{DD} = +33V$ to +36V		0.05		LSB
ANALOG MONITOR PIN (V_{MON})					
Output impedance ⁽¹⁴⁾	$T_A = +25^\circ\text{C}$		2		k Ω
Three-state leakage current			100		nA
AUXILIARY ANALOG INPUT					
Input range		AV_{SS}		AV_{DD}	V
Input impedance (AIN-x to V_{MON})	$T_A = +25^\circ\text{C}$		2		k Ω
Input capacitance ⁽¹⁵⁾			4		pF
Input leakage current			30		nA
REFERENCE INPUT					
Reference input voltage range ⁽¹⁶⁾		1.0		5.5	V
Reference input dc impedance			10		M Ω
Reference input capacitance ⁽¹⁵⁾			10		pF
DIGITAL INPUT⁽¹⁵⁾					
High-level input voltage, V_{IH}	$IOV_{DD} = +4.5V$ to +5.5V	3.8		$0.3 + IOV_{DD}$	V
	$IOV_{DD} = +2.7V$ to +3.3V	2.3		$0.3 + IOV_{DD}$	V
	$IOV_{DD} = +1.7V$ to 2.0V	1.5		$0.3 + IOV_{DD}$	V
Low-level input voltage, V_{IL}	$IOV_{DD} = +4.5V$ to +5.5V	-0.3		0.8	V
	$IOV_{DD} = +2.7V$ to +3.3V	-0.3		0.6	V
	$IOV_{DD} = +1.7V$ to 2.0V	-0.3		0.3	V
Input current	$\overline{\text{CLR}}$, $\overline{\text{LDAC}}$, $\overline{\text{RST}}$, $\overline{\text{CS}}$, and SDI			± 1	μA
	$\overline{\text{USB/BTC}}$, RSTSEL, and GPIO-n			± 5	μA
Input capacitance	$\overline{\text{CLR}}$, $\overline{\text{LDAC}}$, $\overline{\text{RST}}$, $\overline{\text{CS}}$, and SDI		5		pF
	$\overline{\text{USB/BTC}}$ and RSTSEL		12		pF
	GPIO-n		14		pF

(10) DAC-to-DAC crosstalk is the glitch impulse that appears at the output of one DAC as a result of both the full-scale digital code and subsequent analog output change at another DAC. It is measured with LDAC tied low and expressed in nV-s.

(11) Digital crosstalk is the glitch impulse transferred to the output of one converter as a result of a full-scale code change in the DAC input register of another converter. It is measured when the DAC output is not updated, and is expressed in nV-s.

(12) Digital feedthrough is the glitch impulse injected to the output of a DAC as a result of a digital code change in the DAC input register of the same DAC. It is measured with the full-scale digital code change without updating the DAC output, and is expressed in nV-s.

(13) The analog output must not be greater than $(AV_{DD} - 0.5V)$.

(14) 8k Ω when V_{MON} is connected to Reference Buffer A or B, and 4k Ω when V_{MON} is connected to Offset DAC-A or -B.

(15) Specified by design.

(16) Reference input voltage $\leq DV_{DD}$.

ELECTRICAL CHARACTERISTICS: Single-Supply (continued)

All specifications at $T_A = T_{MIN}$ to T_{MAX} , $AV_{DD} = +32V$, $AV_{SS} = 0V$, $IOV_{DD} = DV_{DD} = +5V$, REF-A and REF-B = +5V, gain = 6, AGND-x = DGND = 0V, data format = straight binary, and OFFSET-A = OFFSET-B = AGND, unless otherwise noted.

PARAMETER	CONDITIONS	DAC8718			UNIT
		MIN	TYP	MAX	
DIGITAL OUTPUT⁽¹⁷⁾					
High-level output voltage, V_{OH} (SDO)	$IOV_{DD} = +2.7V$ to $+5.5V$, sourcing 1mA	$IOV_{DD} - 0.4$		IOV_{DD}	V
	$IOV_{DD} = +1.8V$, sourcing 200 μ A	1.6		IOV_{DD}	V
Low-level output voltage, V_{OL} (SDO)	$IOV_{DD} = +2.7V$ to $+5.5V$, sinking 1mA	0		0.4	V
	$IOV_{DD} = +1.8V$, sinking 200 μ A	0		0.2	V
GPIO-n output voltage low, V_{OL}	1mA sink from IOV_{DD}		0.15		V
GPIO-n output voltage high, V_{OH}	10k Ω pull-up resistor to IOV_{DD}	$0.99 \times IOV_{DD}$			V
High-impedance leakage current	SDO and GPIO-n		± 5		μ A
High-impedance output capacitance	SDO		5		pF
	GPIO-n		14		pF
POWER SUPPLY					
AV_{DD}		+9		+36	V
DV_{DD}		+2.7		+5.5	V
IOV_{DD} ⁽¹⁸⁾		+1.8		+5.5	V
AI_{DD}	Normal operation, midscale code, output unloaded		4.5	7	mA
	Power down, output unloaded		35		μ A
DI_{DD}	Normal operation		70		μ A
	Power down		36		μ A
IOI_{DD}	Normal operation, $V_{IH} = IOV_{DD}$, $V_{IL} = DGND$		5		μ A
	Power down, $V_{IH} = IOV_{DD}$, $V_{IL} = DGND$		5		μ A
Power dissipation	Normal operation		140	225	mW
TEMPERATURE RANGE					
Specified performance		-40		+105	$^{\circ}$ C

(17) Specified by design.

(18) $IOV_{DD} \leq DV_{DD}$.

FUNCTIONAL BLOCK DIAGRAM

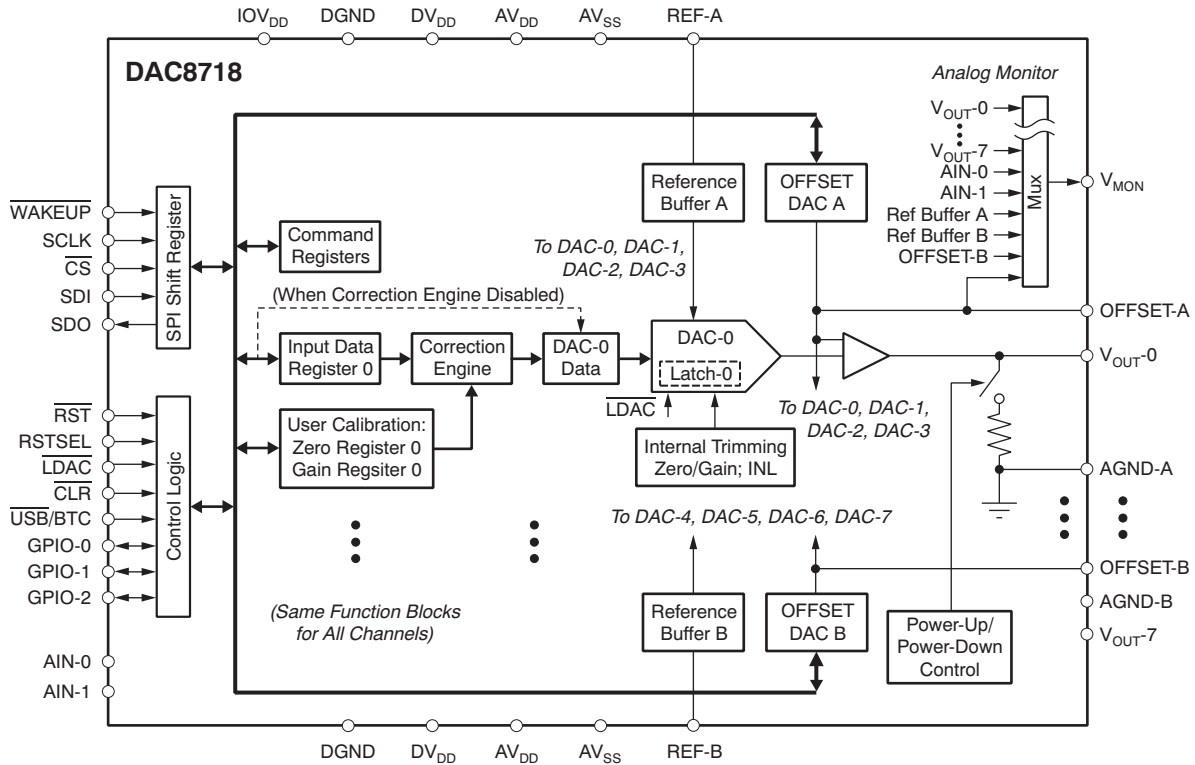
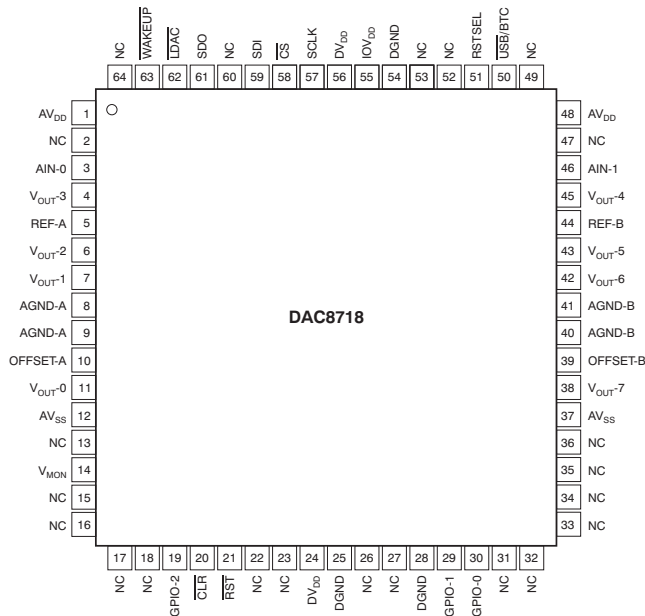
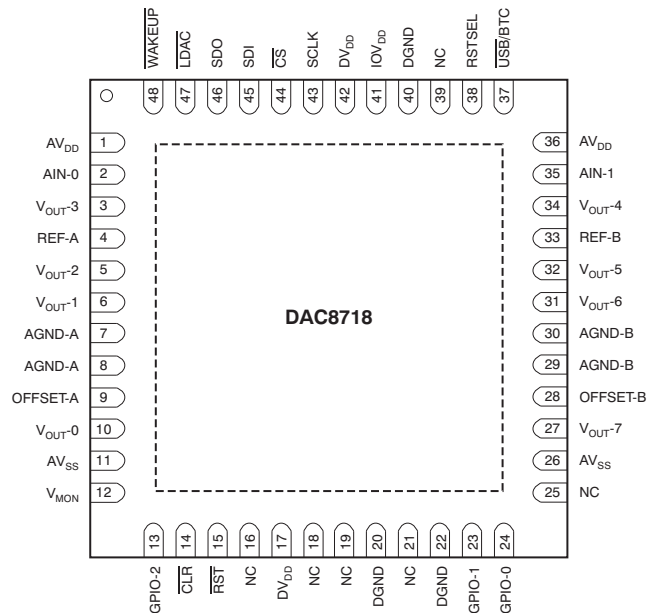

Figure 1. Functional Block Diagram

PIN CONFIGURATIONS

**PAG PACKAGE
TQFP-64
(TOP VIEW)**

**RGZ PACKAGE
QFN-48
(TOP VIEW)**

- (1) The thermal pad is internally connected to the substrate. This pad can be connected to AV_{SS} or left floating. Keep the thermal pad separate from the digital ground, if possible.

PIN DESCRIPTIONS

PIN NAME	PIN NO.		I/O	DESCRIPTION
	QFN-48	TQFP-64		
AV _{DD}	1	1	I	Positive analog power supply
AIN-0	2	3	I	Auxiliary analog input 0, directly routed to the analog mux
V _{OUT-3}	3	4	O	DAC-3 output
REF-A	4	5	I	Group A ⁽¹⁾ reference input
V _{OUT-2}	5	6	O	DAC-2 output
V _{OUT-1}	6	7	O	DAC-1 output
AGND-A	7	8	I	Group A analog ground and the ground of REF-A. This pin must be tied to AGND-B and DGND.
AGND-A	8	9	I	Group A analog ground and the ground of REF-A. This pin must be tied to AGND-B and DGND.
OFFSET-A	9	10	O	OFFSET DAC-A analog output. Must be connected to AGND-A during single power-supply operation (AV _{SS} = 0V). This pin is not intended to drive an external load.
V _{OUT-0}	10	11	O	DAC-0 output
AV _{SS}	11	12	I	Negative analog power supply
V _{MON}	12	14	O	Analog monitor output. This pin is either in Hi-Z status, connected to one of the eight DAC outputs, reference buffer outputs, offset DAC outputs, or one of the auxiliary analog inputs, depending on the content of the Monitor Register. See the Monitor Register, Table 12 , for details.
GPIO-2	13	19	I/O	General-purpose digital input/output 2. This pin is a bidirectional digital input/output, open-drain and requires an external pull-up resistor. See the GPIO Pins section for details.
CLR	14	20	I	Clear input, level triggered. When the CLR pin is logic '0', all V _{OUT-X} pins connect to AGND-x through switches and internal low-impedance. When the CLR pin is logic '1', all V _{OUT-X} pins connect to the amplifier outputs.
RST	15	21	I	Reset input (active low). Logic low on this pin resets the DAC registers and DACs to the values defined by the RSTSEL pin. CS must be logic high when RST is active.

(1) Group A consists of DAC-0, DAC-1, DAC-2, and DAC-3. Group B consists of DAC-4, DAC-5, DAC-6, and DAC-7.

PIN DESCRIPTIONS (continued)

PIN NAME	PIN NO.		I/O	DESCRIPTION
	QFN-48	TQFP-64		
DV _{DD}	17	24	I	Digital power supply
DGND	20	25	I	Digital ground
DGND	22	28	I	Digital ground
GPIO-1	23	29	I/O	General-purpose digital input/output 1. This pin is a bidirectional digital input/output, open-drain and requires an external resistor. See the GPIO Pins section for details.
GPIO-0	24	30	I/O	General-purpose digital input/output 0. This pin is a bidirectional digital input/output, open-drain and requires an external resistor. See the GPIO Pins section for details.
AV _{SS}	26	37	I	Negative analog power supply
V _{OUT-7}	27	38	O	DAC-7 output
OFFSET-B	28	39	O	OFFSET DAC-B analog output. Must be connected to AGND-B during single-supply operation (AV _{SS} = 0V).
AGND-B	29	40	I	Group B ⁽¹⁾ analog ground and the ground of REF-B. This pin must be tied to AGND-A and DGND.
AGND-B	30	41	I	Group B analog ground and the ground of REF-B. This pin must be tied to AGND-A and DGND.
V _{OUT-6}	31	42	O	DAC-6 output
V _{OUT-5}	32	43	O	DAC-5 output
REF-B	33	44	I	Group B reference input
V _{OUT-4}	34	45	O	DAC-4 output
AIN-1	35	46	I	Auxiliary analog input 1, directly routed to the analog mux
AV _{DD}	36	48	I	Positive analog power supply
$\overline{\text{USB/BTC}}$	37	50	I	Data format selection of Input DAC data and Offset DAC data. Data are in straight binary format when connected to DGND or in twos complement format when connected to IOV _{DD} . The command data are always in straight binary format. Refer to Input Data Format section for details.
RSTSEL	38	51	I	Output reset selection. Selects the output voltage on the V _{OUT} pin after power-on or hardware reset. Refer to the Power-On Reset section for details.
DGND	40	54	I	Digital ground
IOV _{DD}	41	55	I	Interface power
DV _{DD}	42	56	I	Digital power supply
SCLK	43	57	I	SPI bus serial clock input
$\overline{\text{CS}}$	44	58	I	SPI bus chip select input (active low). Data are not clocked into SDI unless $\overline{\text{CS}}$ is low. When $\overline{\text{CS}}$ is high, SDO is in a high-impedance state and the SCLK and SDI signals are blocked from the device.
SDI	45	59	I	SPI bus serial data input
SDO	46	61	O	SPI bus serial data output. When the DSDO bit = '0', the SDO pin works as an output in normal operation. When the DSDO bit = '1', SDO is always in a Hi-Z state, regardless of the $\overline{\text{CS}}$ pin status. Refer to the Timing Diagrams section for details.
$\overline{\text{LDAC}}$	47	62	I	Load DAC latch control input (active low). When $\overline{\text{LDAC}}$ is low, the DAC latch is transparent and the contents of the DAC Data Register are transferred to it. The DAC output changes to the corresponding level simultaneously when the DAC latch is updated. See the Updating the DAC Outputs section for details. If asynchronous mode is desired, $\overline{\text{LDAC}}$ must be permanently tied low before power is applied to the device. If synchronous mode is desired, $\overline{\text{LDAC}}$ must be logic high during power-on.
$\overline{\text{WAKEUP}}$	48	63	I	Wake-up input (active low). Restores the SPI from sleep to normal operation. See the Daisy-Chain Operation section for details.
NC	16, 18, 19, 21, 25, 39	2, 13, 15-18, 22, 23, 26, 27, 31-36, 47, 49, 52, 53, 60, 64	—	Not connected

TIMING DIAGRAMS

Case 1: Standalone mode: Update without $\overline{\text{LDAC}}$ pin; $\overline{\text{LDAC}}$ pin tied to logic low.

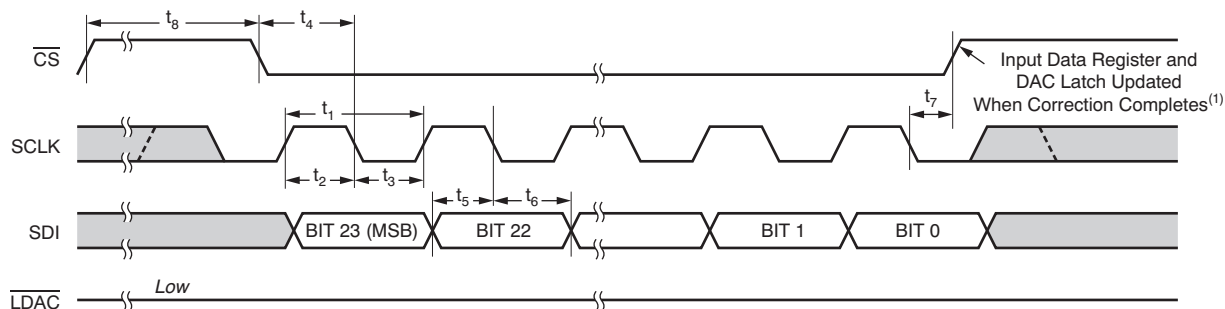

NOTE: (1) If the correction engine is off, the DAC latch is reloaded immediately after the DAC Data Register is updated.

Case 2: Standalone mode: Update with $\overline{\text{LDAC}}$ pin.

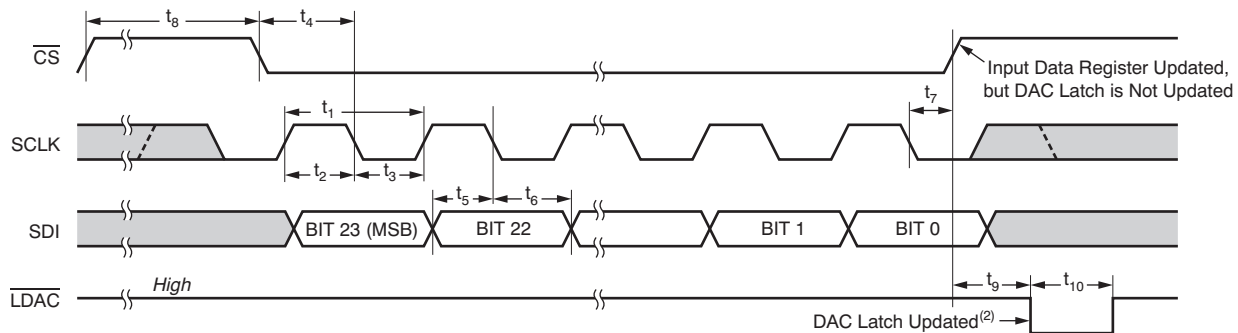

NOTE: (2) The DAC latch is updated when $\overline{\text{LDAC}}$ goes low, as long as the timing requirement of t_9 is satisfied.



Figure 2. SPI Timing for Standalone Mode

TIMING DIAGRAMS (continued)

Case 3: Daisy-Chain Mode: Update without $\overline{\text{LDAC}}$ pin; $\overline{\text{LDAC}}$ pin tied to logic low.

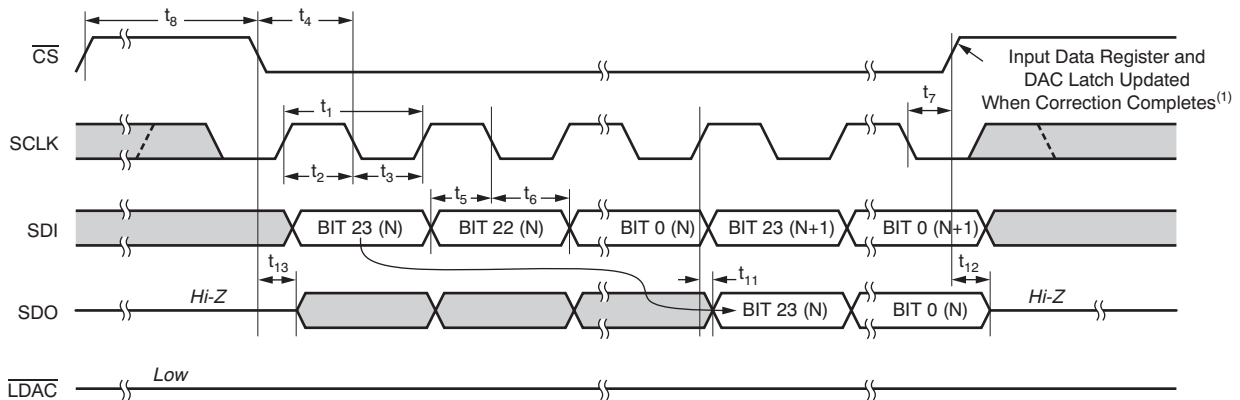

NOTE: (1) If the correction engine is off, the DAC latch is reloaded immediately after the DAC Data Register is updated.

Case 4: Daisy-Chain Mode: Update with $\overline{\text{LDAC}}$ pin.

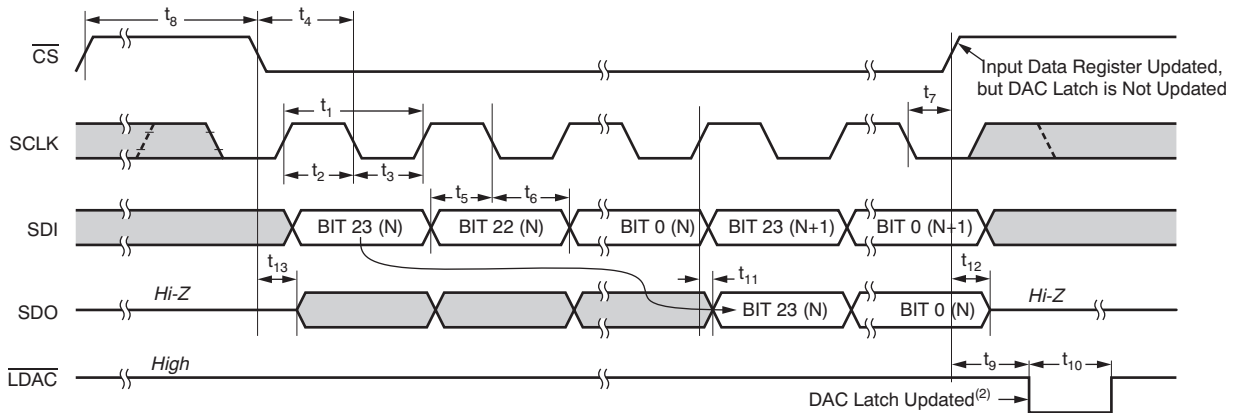

NOTE: (2) The DAC latch is updated when $\overline{\text{LDAC}}$ goes low. The proper data are loaded if the t_9 timing requirement is satisfied. Otherwise, invalid data are loaded.

Case 5: Daisy-Chain Mode: Sleeping.

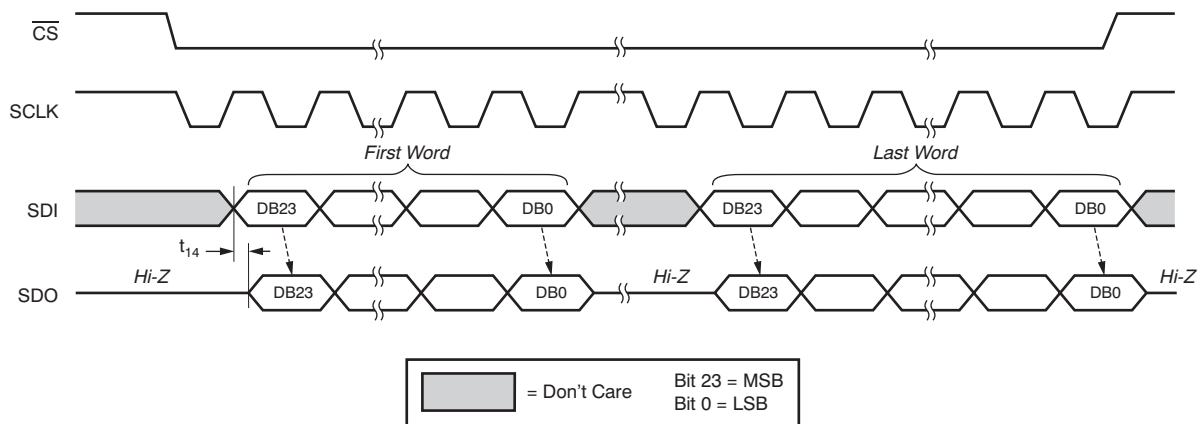

Figure 3. SPI Timing for Daisy-Chain Mode

TIMING DIAGRAMS (continued)

Case 6: Readback for Standalone mode.

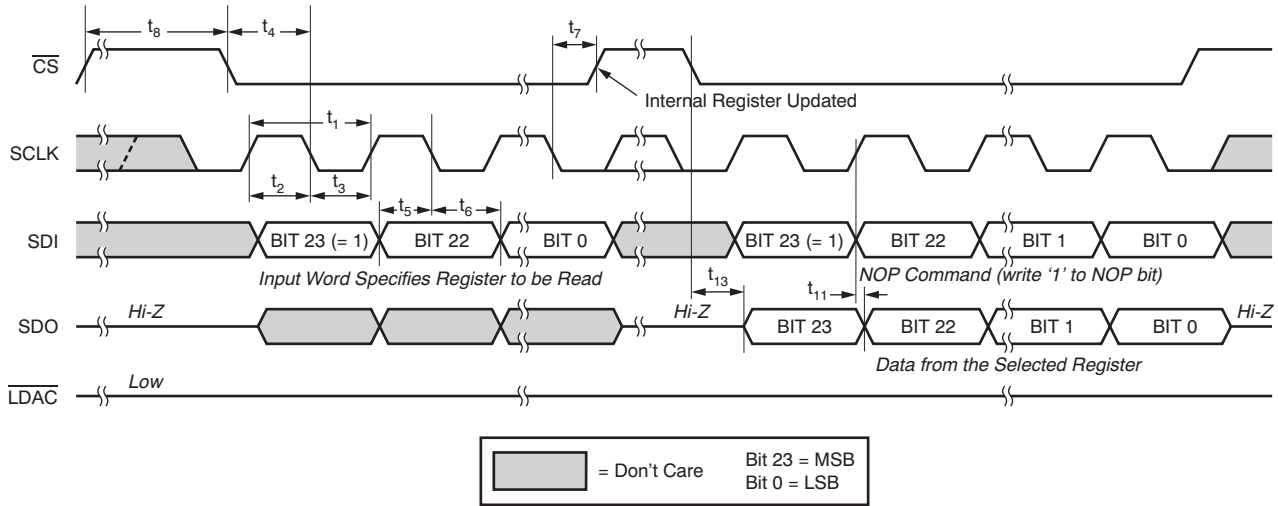

Figure 4. SPI Timing for Readback Operation in Standalone Mode

TIMING CHARACTERISTICS: IOV_{DD} = +5V⁽¹⁾⁽²⁾⁽³⁾⁽⁴⁾

At –40°C to +105°C, DV_{DD} = +5V, and IOV_{DD} = +5V, unless otherwise noted.

PARAMETER		MIN	MAX	UNIT
f _{SCLK}	Clock frequency		50	MHz
t ₁	SCLK cycle time	20		ns
t ₂	SCLK high time	10		ns
t ₃	SCLK low time	7		ns
t ₄	\overline{CS} falling edge to SCLK falling edge setup time	8		ns
t ₅	SDI setup time before falling edge of SCLK	5		ns
t ₆	SDI hold time after falling edge of SCLK	5		ns
t ₇	SCLK falling edge to \overline{CS} rising edge	5		ns
t ₈	\overline{CS} high time	10		ns
t ₉	\overline{CS} rising edge to \overline{LDAC} falling edge	5		ns
t ₁₀	\overline{LDAC} pulse duration	10		ns
t ₁₁	Delay from SCLK rising edge to SDO valid	3	8	ns
t ₁₂	Delay from \overline{CS} rising edge to SDO Hi-Z		5	ns
t ₁₃	Delay from \overline{CS} falling edge to SDO valid		6	ns
t ₁₄	SDI to SDO delay during sleep mode	2	5	ns

- (1) Specified by design. Not production tested.
- (2) Sample tested during the initial release and after any redesign or process changes that may affect these parameters.
- (3) All input signals are specified with t_R = t_F = 2ns (10% to 90% of IOV_{DD}) and timed from a voltage level of IOV_{DD}/2.
- (4) SDO loaded with 10Ω series resistance and 10pF load capacitance for SDO timing specifications, with t_R = t_F ≤ 5ns.

TIMING CHARACTERISTICS: IOV_{DD} = +3V⁽¹⁾⁽²⁾⁽³⁾⁽⁴⁾

At –40°C to +105°C, DV_{DD} = +3V/+5V, and IOV_{DD} = +3V, unless otherwise noted.

PARAMETER		MIN	MAX	UNIT
f _{SCLK}	Clock frequency		25	MHz
t ₁	SCLK cycle time	40		ns
t ₂	SCLK high time	19		ns
t ₃	SCLK low time	7		ns
t ₄	\overline{CS} falling edge to SCLK falling edge setup time	15		ns
t ₅	SDI setup time before falling edge of SCLK	5		ns
t ₆	SDI hold time after falling edge of SCLK	5		ns
t ₇	SCLK falling edge to \overline{CS} rising edge	10		ns
t ₈	\overline{CS} high time	19		ns
t ₉	\overline{CS} rising edge to \overline{LDAC} falling edge	5		ns
t ₁₀	\overline{LDAC} pulse duration	10		ns
t ₁₁	Delay from SCLK rising edge to SDO valid	3	15	ns
t ₁₂	Delay from \overline{CS} rising edge to SDO Hi-Z		7	ns
t ₁₃	Delay from \overline{CS} falling edge to SDO valid		10	ns
t ₁₄	SDI to SDO delay during sleep mode	2	10	ns

- (1) Specified by design. Not production tested.
- (2) Sample tested during the initial release and after any redesign or process changes that may affect these parameters.
- (3) All input signals are specified with t_R = t_F = 3ns (10% to 90% of IOV_{DD}) and timed from a voltage level of IOV_{DD}/2.
- (4) SDO loaded with 10Ω series resistance and 10pF load capacitance for SDO timing specifications, with t_R = t_F ≤ 5ns.

TIMING CHARACTERISTICS: IOV_{DD} = +1.8V⁽¹⁾⁽²⁾⁽³⁾⁽⁴⁾

 At –40°C to +105°C, DV_{DD} = +3V/+5V, and IOV_{DD} = +1.8V, unless otherwise noted.

PARAMETER		MIN	MAX	UNIT
f _{SCLK}	Clock frequency		16.6	MHz
t ₁	SCLK cycle time	60		ns
t ₂	SCLK high time	28		ns
t ₃	SCLK low time	7		ns
t ₄	\overline{CS} falling edge to SCLK falling edge setup time	28		ns
t ₅	SDI setup time before falling edge of SCLK	10		ns
t ₆	SDI hold time after falling edge of SCLK	5		ns
t ₇	SCLK falling edge to \overline{CS} rising edge	10		ns
t ₈	\overline{CS} high time	28		ns
t ₉	\overline{CS} rising edge to \overline{LDAC} falling edge	5		ns
t ₁₀	\overline{LDAC} pulse duration	10		ns
t ₁₁	Delay from SCLK rising edge to SDO valid	3	25	ns
t ₁₂	Delay from \overline{CS} rising edge to SDO Hi-Z		15	ns
t ₁₃	Delay from \overline{CS} falling edge to SDO valid		23	ns
t ₁₄	SDI to SDO delay during sleep mode	2	25	ns

- (1) Specified by design. Not production tested.
- (2) Sample tested during the initial release and after any redesign or process changes that may affect these parameters.
- (3) All input signals are specified with t_R = t_F = 6ns (10% to 90% of IOV_{DD}) and timed from a voltage level of IOV_{DD}/2.
- (4) SDO loaded with 10Ω series resistance and 10pF load capacitance for SDO timing specifications, with t_R = t_F ≤ 15ns.

TYPICAL CHARACTERISTICS: Bipolar

At $T_A = 25^\circ\text{C}$, $AV_{DD} = 16.5\text{V}$, $AV_{SS} = -16.5\text{V}$, $V_{REF} = IOV_{DD} = DV_{DD} = 5\text{V}$, gain = 6, data format=USB, unless otherwise noted.

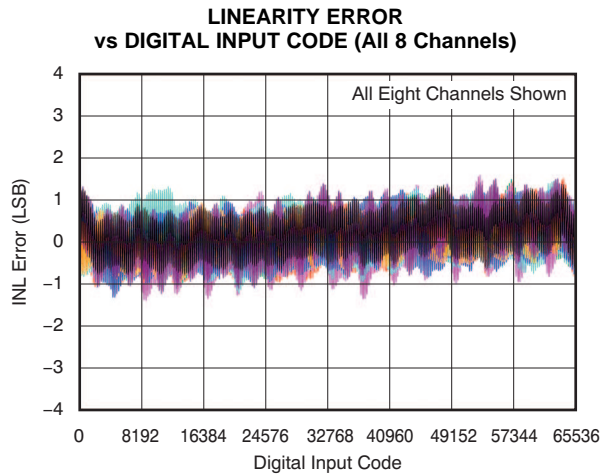

Figure 5.

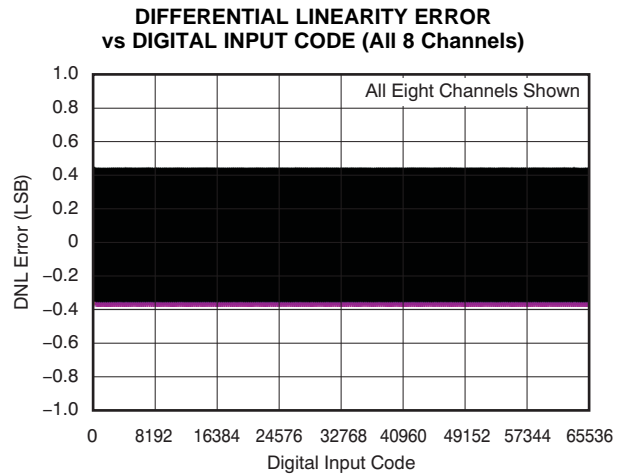

Figure 6.

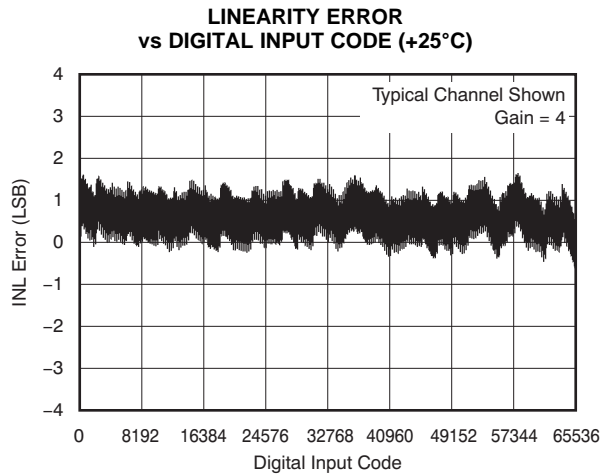

Figure 7.

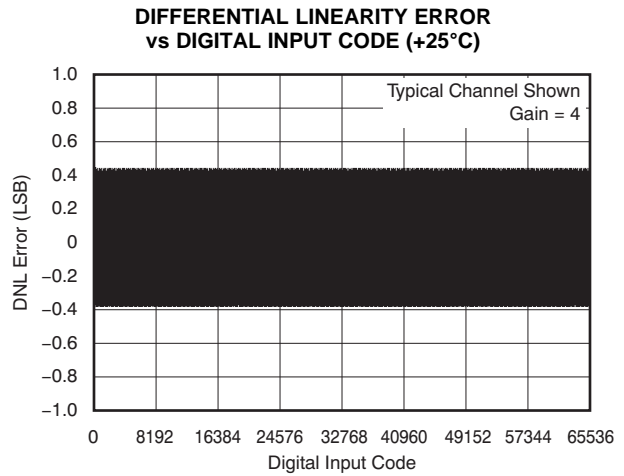

Figure 8.

TYPICAL CHARACTERISTICS: Bipolar (continued)

At $T_A = 25^\circ\text{C}$, $AV_{DD} = 16.5\text{V}$, $AV_{SS} = -16.5\text{V}$, $V_{REF} = IOV_{DD} = DV_{DD} = 5\text{V}$, gain = 6, data format=USB, unless otherwise noted.

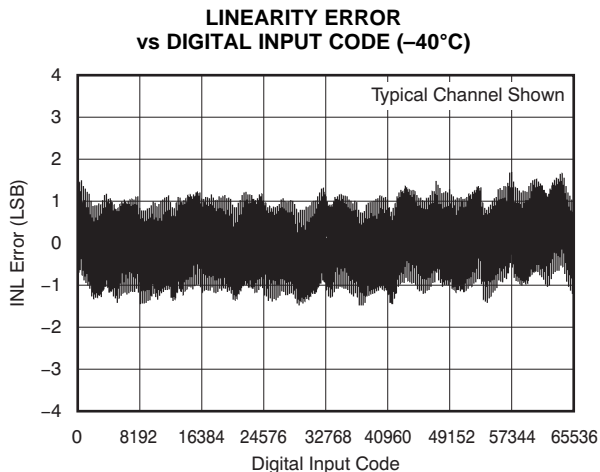

Figure 9.

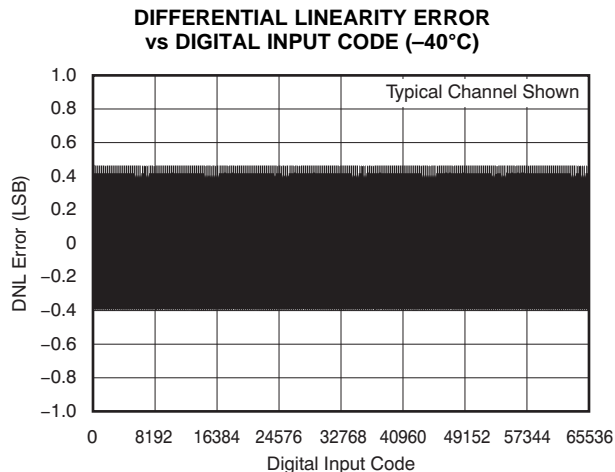

Figure 10.

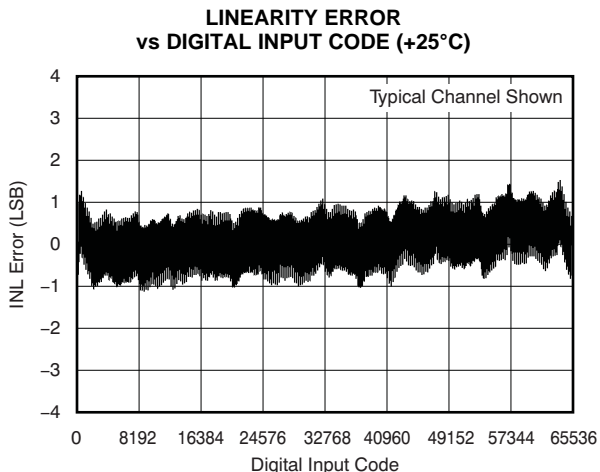

Figure 11.

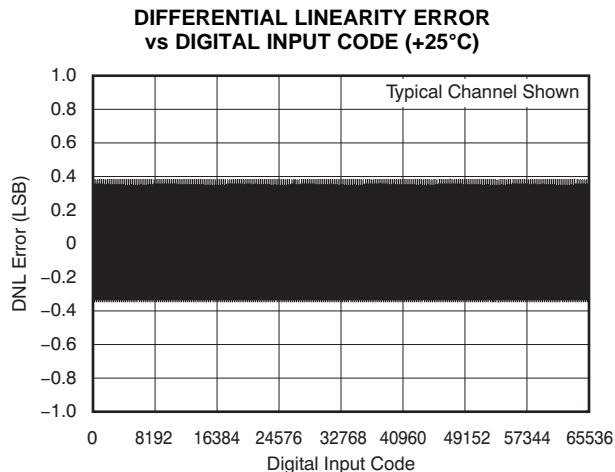

Figure 12.

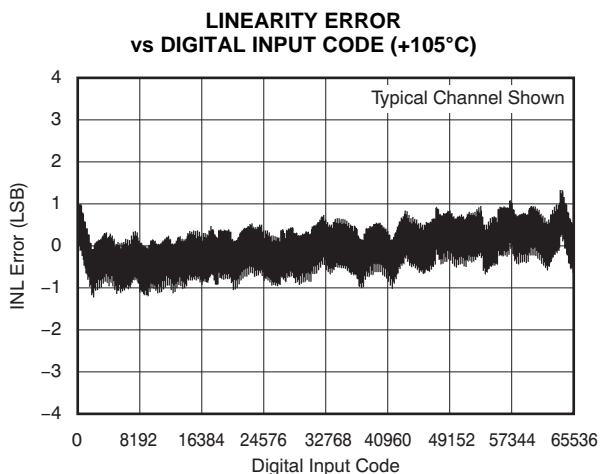

Figure 13.

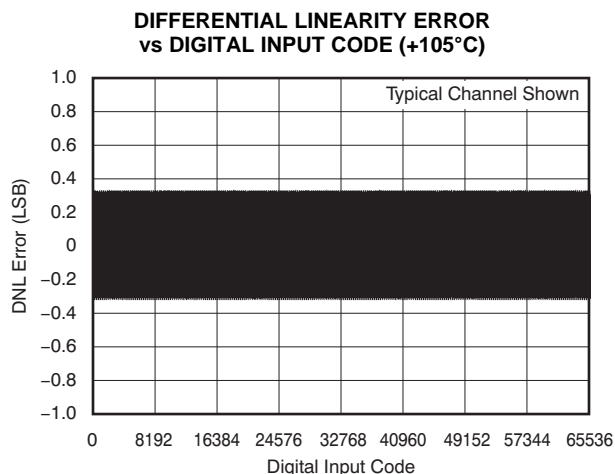

Figure 14.

TYPICAL CHARACTERISTICS: Bipolar (continued)

At $T_A = 25^\circ\text{C}$, $AV_{DD} = 16.5\text{V}$, $AV_{SS} = -16.5\text{V}$, $V_{REF} = IOV_{DD} = DV_{DD} = 5\text{V}$, gain = 6, data format=USB, unless otherwise noted.

LINEARITY ERROR vs TEMPERATURE

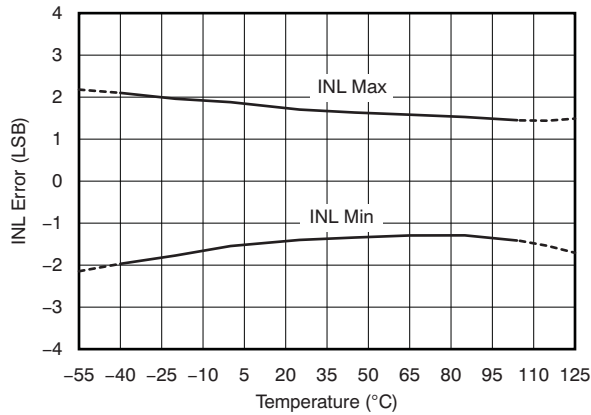

Figure 15.

DIFFERENTIAL LINEARITY ERROR vs TEMPERATURE

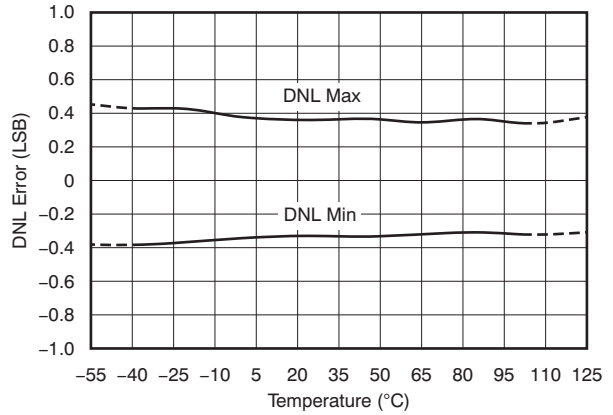

Figure 16.

LINEARITY ERROR vs TEMPERATURE

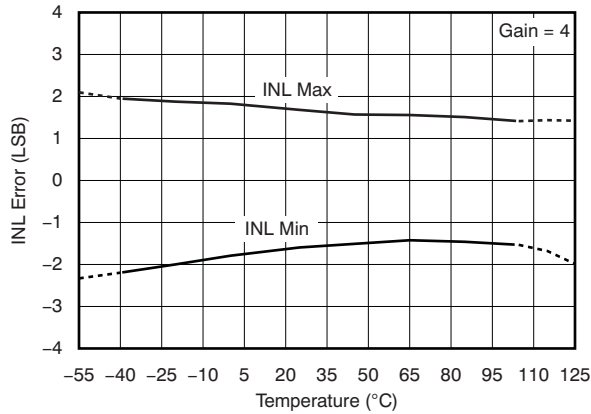

Figure 17.

DIFFERENTIAL LINEARITY ERROR vs TEMPERATURE

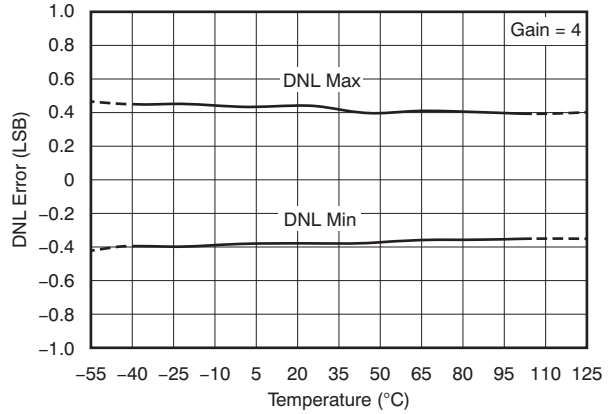

Figure 18.

LINEARITY ERROR vs REFERENCE VOLTAGE

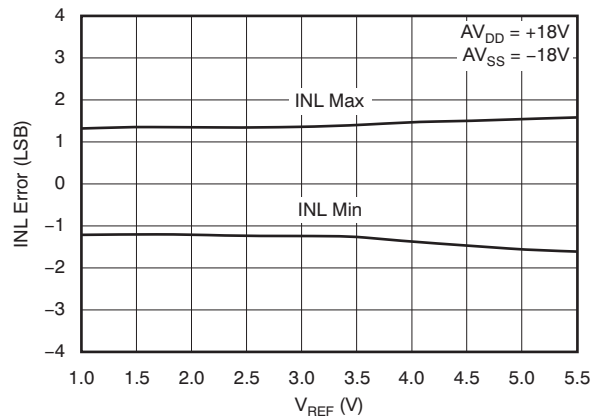

Figure 19.

DIFFERENTIAL LINEARITY ERROR vs REFERENCE VOLTAGE

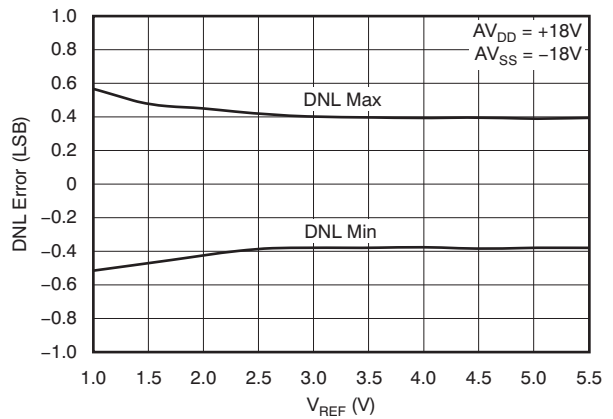

Figure 20.

TYPICAL CHARACTERISTICS: Bipolar (continued)

At $T_A = 25^\circ\text{C}$, $AV_{DD} = 16.5\text{V}$, $AV_{SS} = -16.5\text{V}$, $V_{REF} = IOV_{DD} = DV_{DD} = 5\text{V}$, gain = 6, data format=USB, unless otherwise noted.

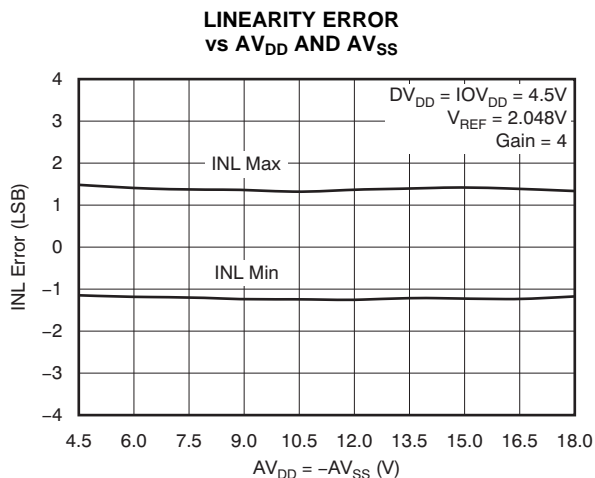

Figure 21.

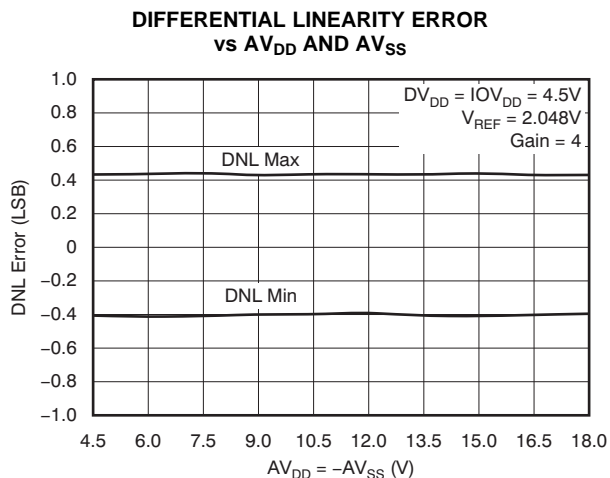

Figure 22.

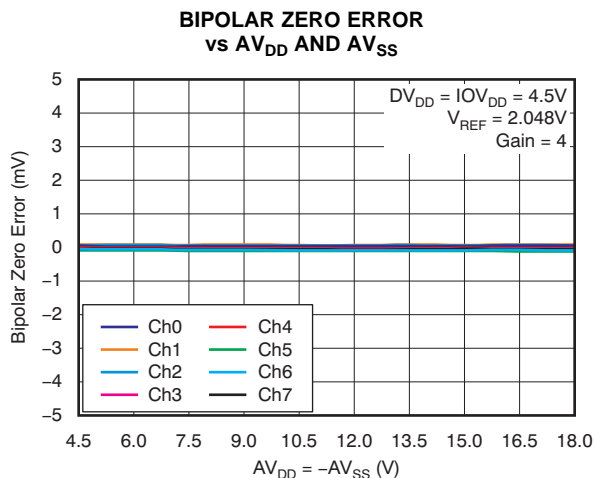

Figure 23.

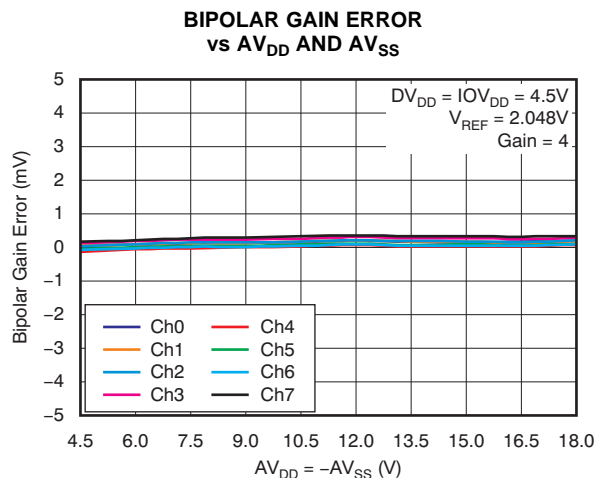

Figure 24.

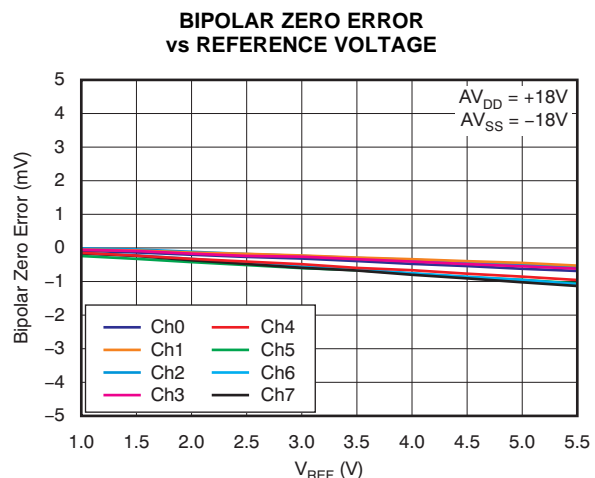

Figure 25.

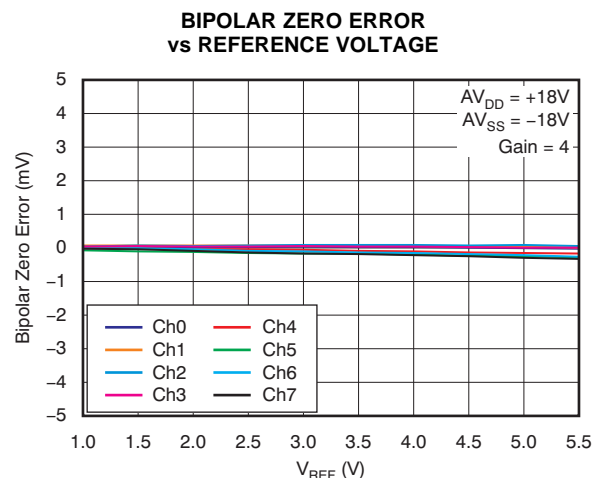

Figure 26.

TYPICAL CHARACTERISTICS: Bipolar (continued)

At $T_A = 25^\circ\text{C}$, $AV_{DD} = 16.5\text{V}$, $AV_{SS} = -16.5\text{V}$, $V_{REF} = IOV_{DD} = DV_{DD} = 5\text{V}$, gain = 6, data format=USB, unless otherwise noted.

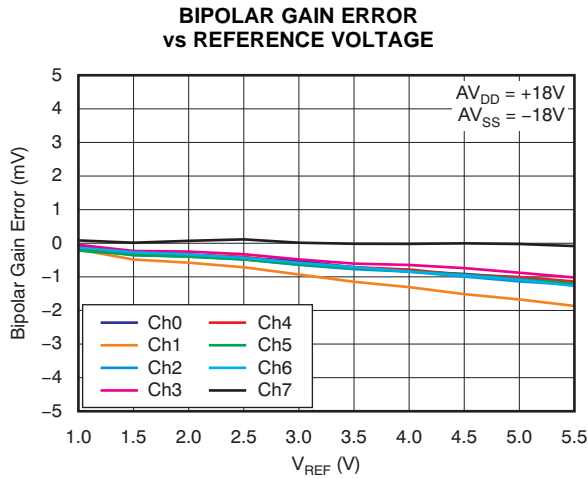

Figure 27.

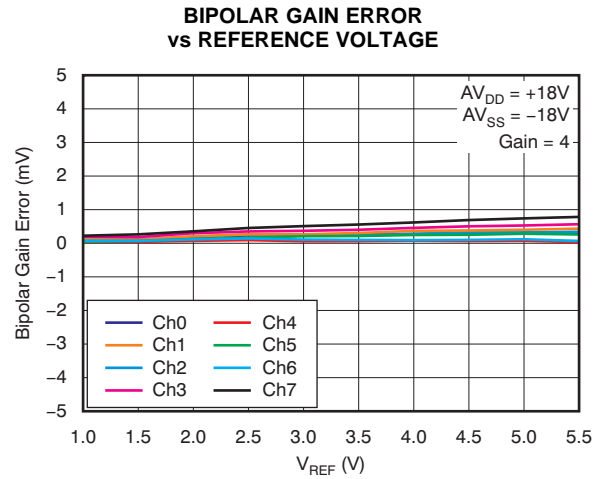

Figure 28.

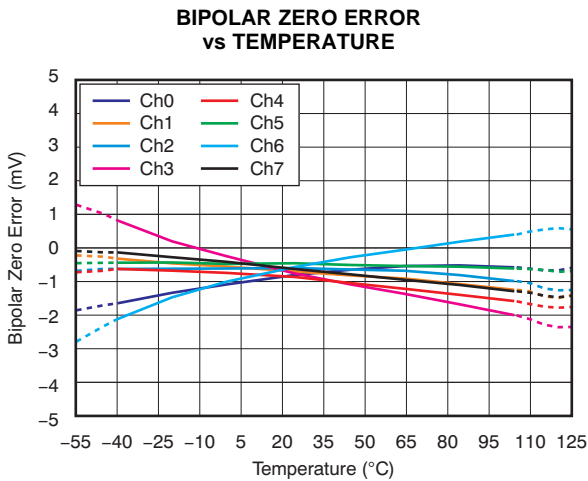

Figure 29.

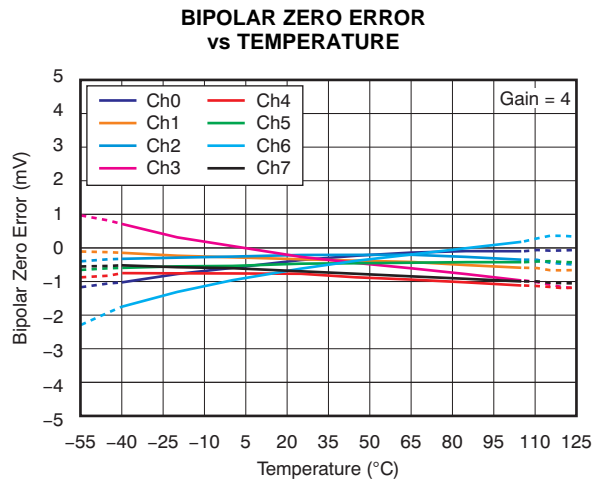

Figure 30.

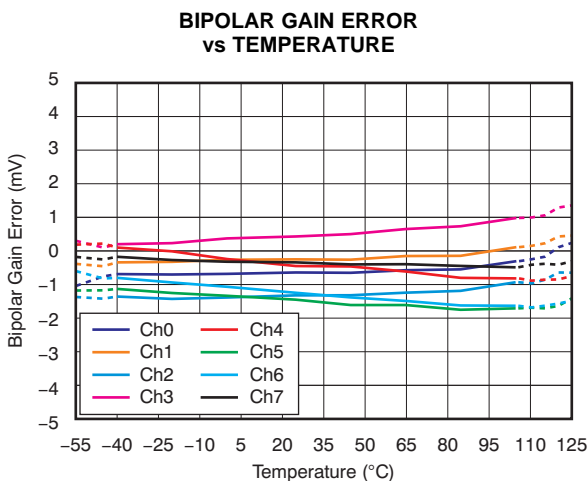

Figure 31.

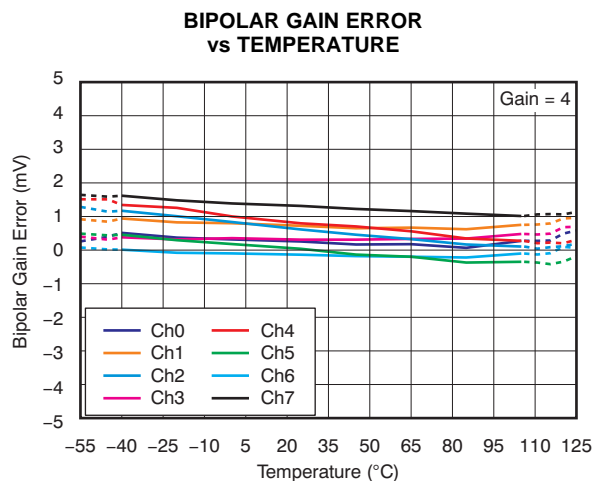

Figure 32.

TYPICAL CHARACTERISTICS: Bipolar (continued)

At $T_A = 25^\circ\text{C}$, $AV_{DD} = 16.5\text{V}$, $AV_{SS} = -16.5\text{V}$, $V_{REF} = IOV_{DD} = DV_{DD} = 5\text{V}$, gain = 6, data format=USB, unless otherwise noted.

ANALOG POWER-SUPPLY CURRENT vs TEMPERATURE

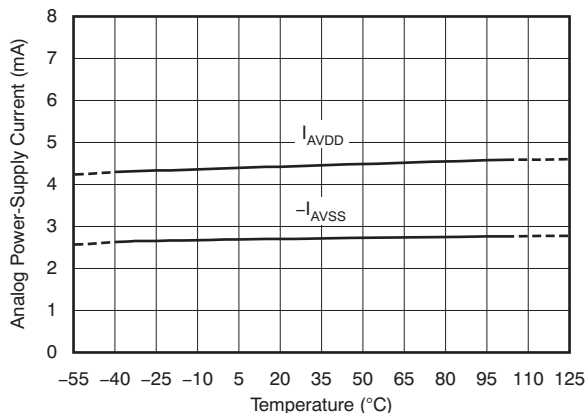

Figure 33.

ANALOG POWER-SUPPLY CURRENT vs REFERENCE VOLTAGE

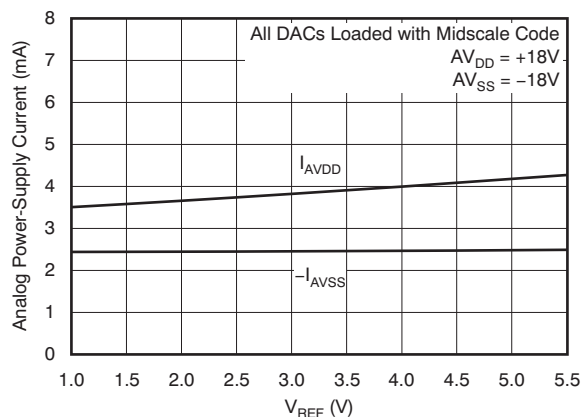

Figure 34.

ANALOG POWER-SUPPLY CURRENT vs DIGITAL INPUT CODE

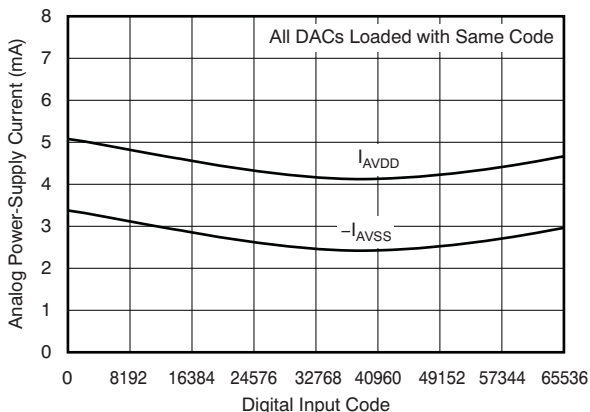

Figure 35.

DIGITAL POWER-SUPPLY CURRENT vs LOGIC INPUT VOLTAGE

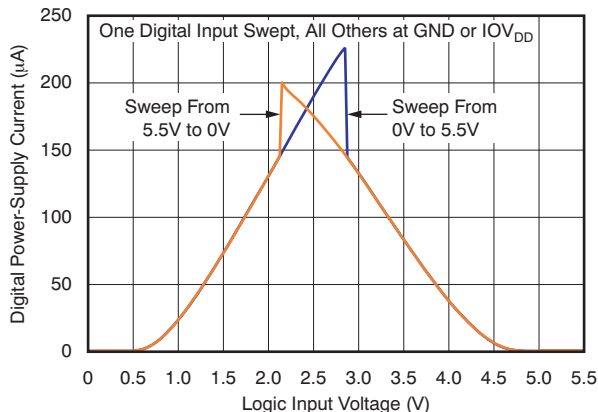

Figure 36.

DELTA OUTPUT VOLTAGE vs SOURCE AND SINK CURRENTS

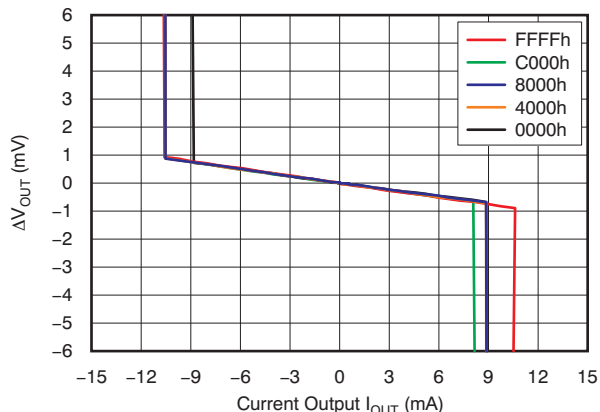

Figure 37.

DAC OUTPUT NOISE DENSITY vs FREQUENCY

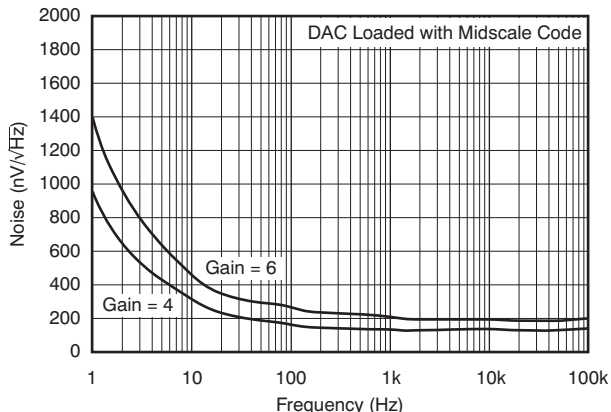

Figure 38.

TYPICAL CHARACTERISTICS: Bipolar (continued)

At $T_A = 25^\circ\text{C}$, $AV_{DD} = 16.5\text{V}$, $AV_{SS} = -16.5\text{V}$, $V_{REF} = IOV_{DD} = DV_{DD} = 5\text{V}$, gain = 6, data format=USB, unless otherwise noted.

**SETTLING TIME
-15V TO +15V TRANSITION**

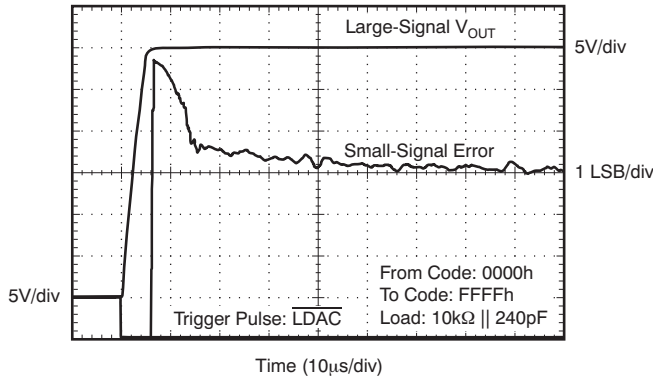

Figure 39.

**SETTLING TIME
+15V TO -15V TRANSITION**

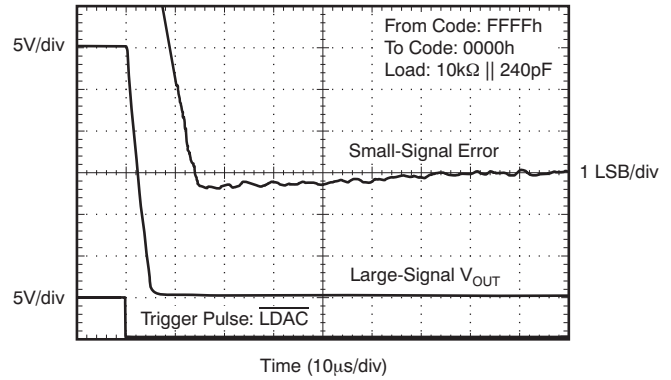

Figure 40.

**SETTLING TIME
1/4 TO 3/4 FULL-SCALE TRANSITION**

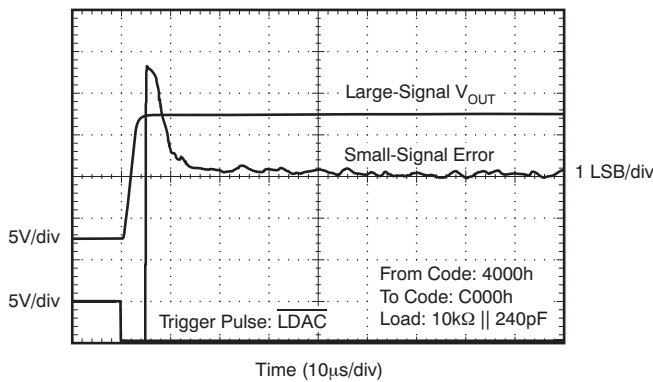

Figure 41.

**SETTLING TIME
3/4 TO 1/4 FULL-SCALE TRANSITION**

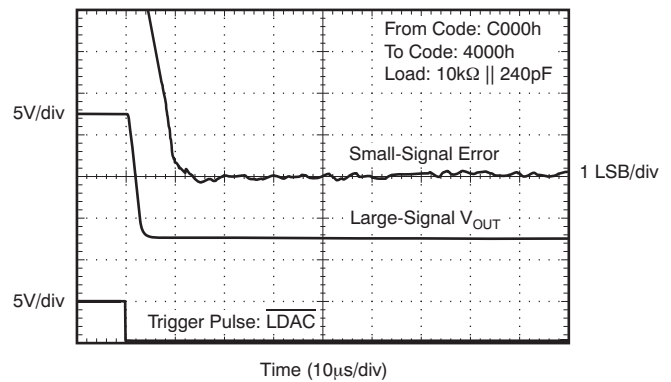

Figure 42.

**GLITCH ENERGY
1 LSB STEP, RISING EDGE**

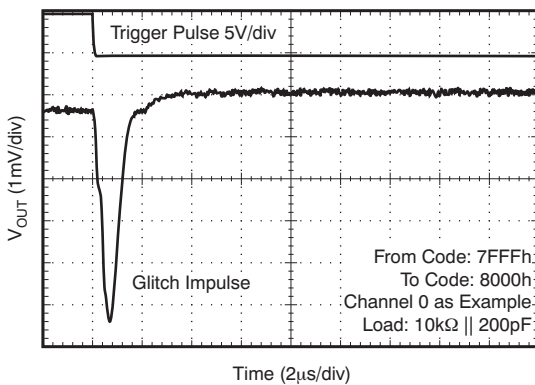

Figure 43.

**GLITCH ENERGY
1 LSB STEP, FALLING EDGE**

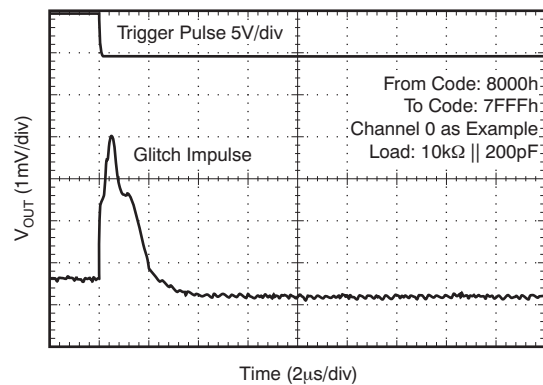

Figure 44.

TYPICAL CHARACTERISTICS: Bipolar (continued)

At $T_A = 25^\circ\text{C}$, $AV_{DD} = 16.5\text{V}$, $AV_{SS} = -16.5\text{V}$, $V_{REF} = IOV_{DD} = DV_{DD} = 5\text{V}$, gain = 6, data format=USB, unless otherwise noted.

BIPOLAR ZERO ERROR HISTOGRAM

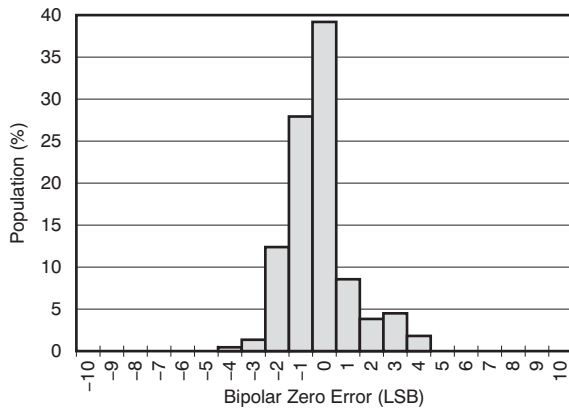

Figure 45.

BIPOLAR ZERO ERROR HISTOGRAM

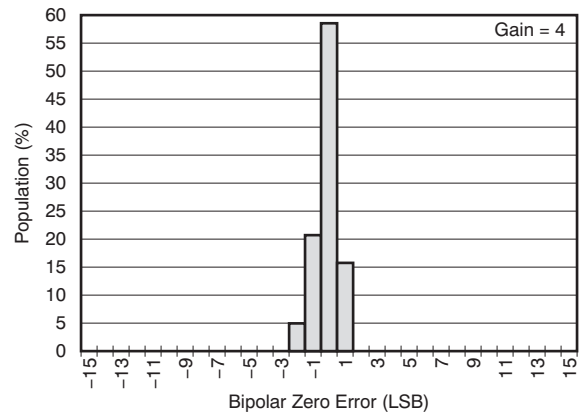

Figure 46.

BIPOLAR GAIN ERROR HISTOGRAM

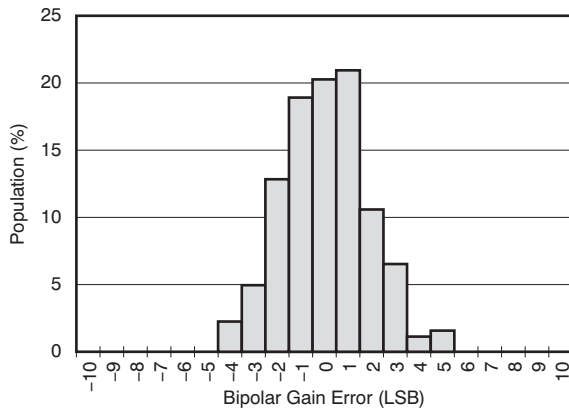

Figure 47.

BIPOLAR GAIN ERROR HISTOGRAM

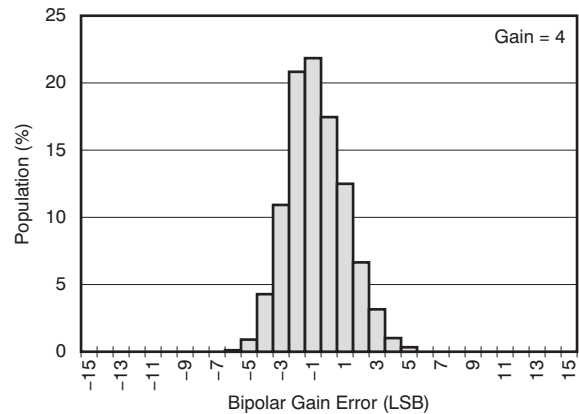

Figure 48.

NEGATIVE ANALOG POWER SUPPLY HISTOGRAM

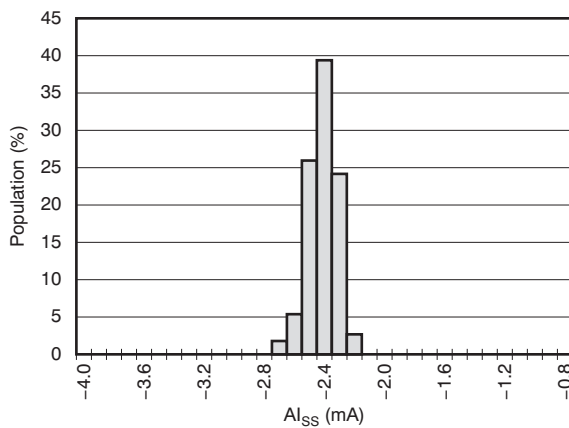

Figure 49.

POSITIVE ANALOG POWER SUPPLY HISTOGRAM

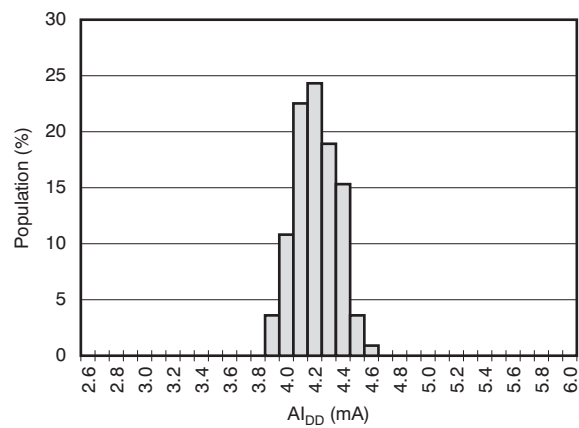

Figure 50.

TYPICAL CHARACTERISTICS: Bipolar (continued)

At $T_A = 25^\circ\text{C}$, $AV_{DD} = 16.5\text{V}$, $AV_{SS} = -16.5\text{V}$, $V_{REF} = IOV_{DD} = DV_{DD} = 5\text{V}$, gain = 6, data format=USB, unless otherwise noted.

**DAC OUTPUT NOISE
0.1Hz TO 10Hz**

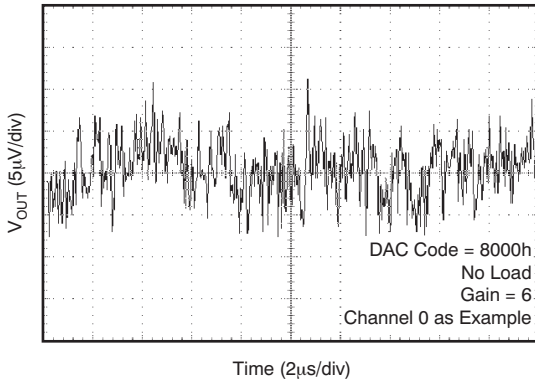

Figure 51.

**DAC OUTPUT NOISE
0.1Hz TO 10Hz**

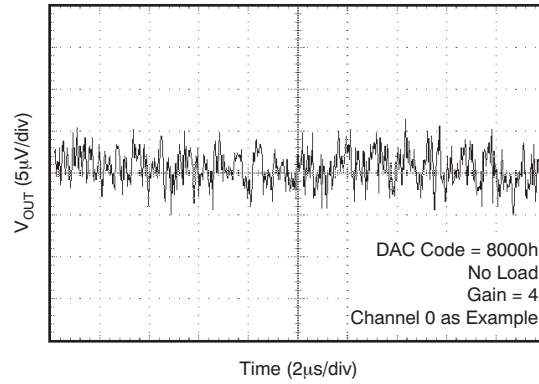

Figure 52.

TYPICAL CHARACTERISTICS: Unipolar

At $T_A = 25^\circ\text{C}$, $AV_{DD} = 32\text{V}$, $AV_{SS} = 0\text{V}$, $V_{REF} = 5\text{V}$, $IOV_{DD} = DV_{DD} = 5\text{V}$, gain=6, and data format=USB, unless otherwise noted.

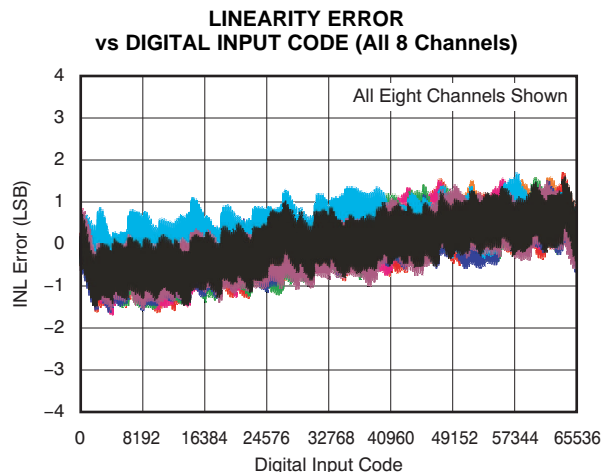

Figure 53.

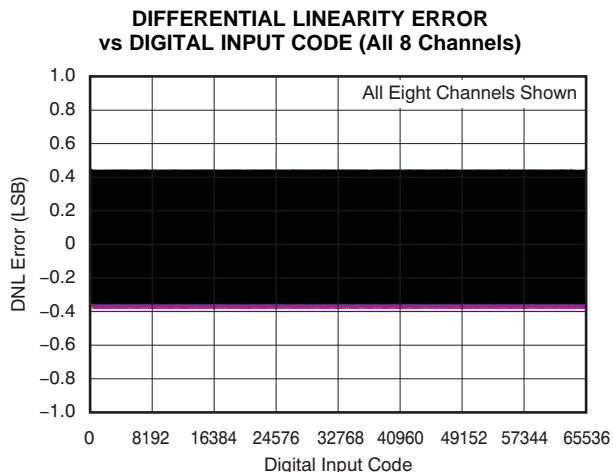

Figure 54.

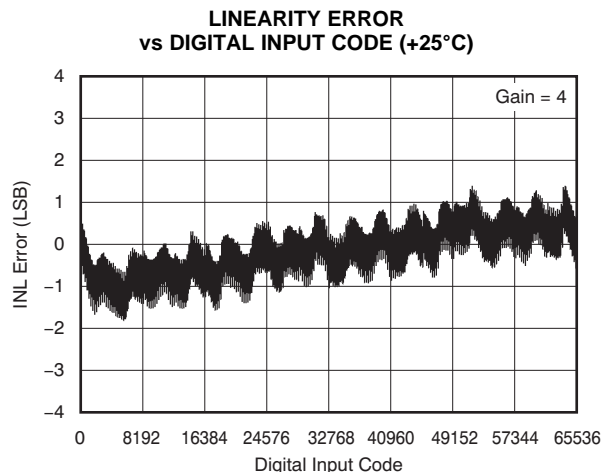

Figure 55.

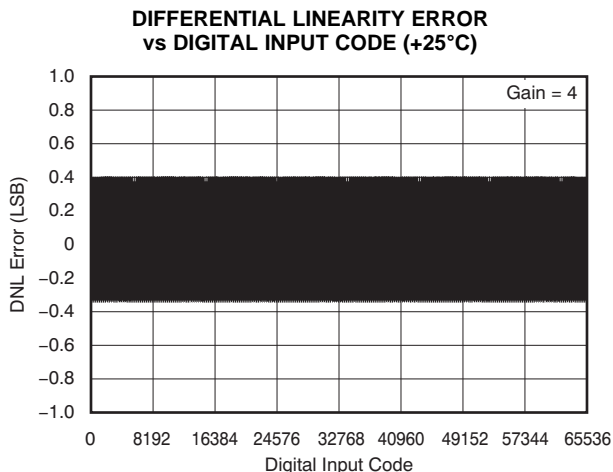

Figure 56.

TYPICAL CHARACTERISTICS: Unipolar (continued)

At $T_A = 25^\circ\text{C}$, $AV_{DD} = 32\text{V}$, $AV_{SS} = 0\text{V}$, $V_{REF} = 5\text{V}$, $IOV_{DD} = DV_{DD} = 5\text{V}$, gain=6, and data format=USB, unless otherwise noted.

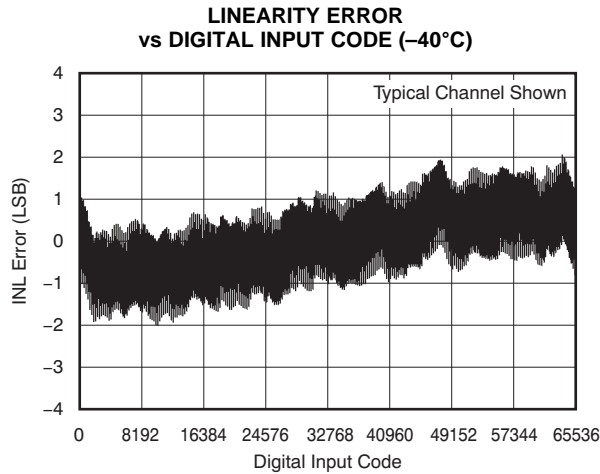

Figure 57.

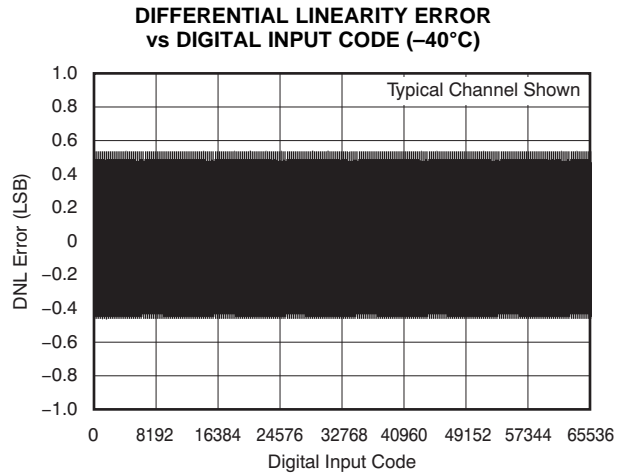

Figure 58.

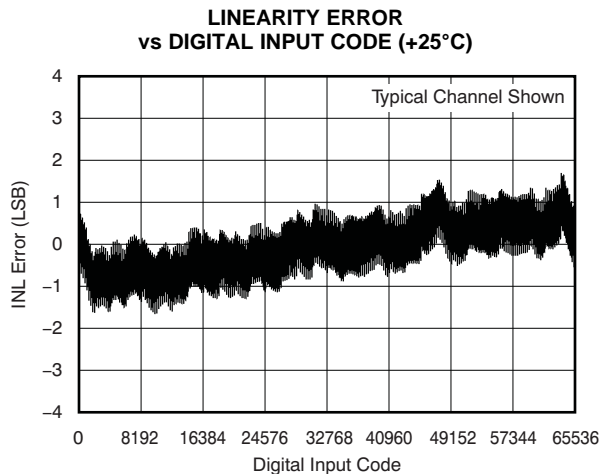

Figure 59.

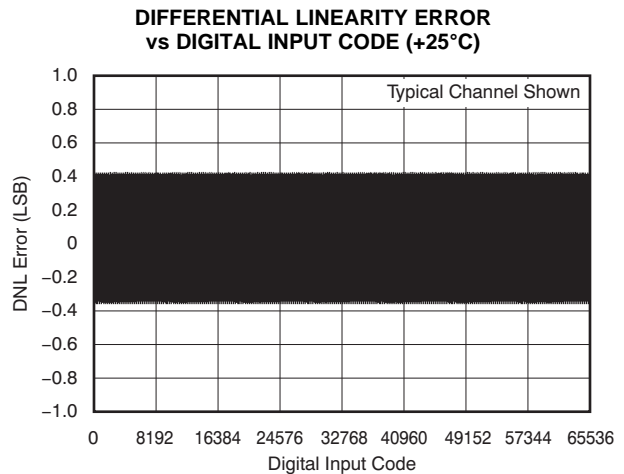

Figure 60.

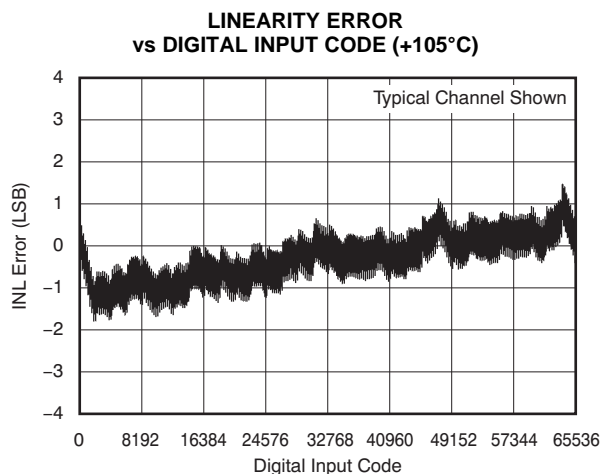

Figure 61.

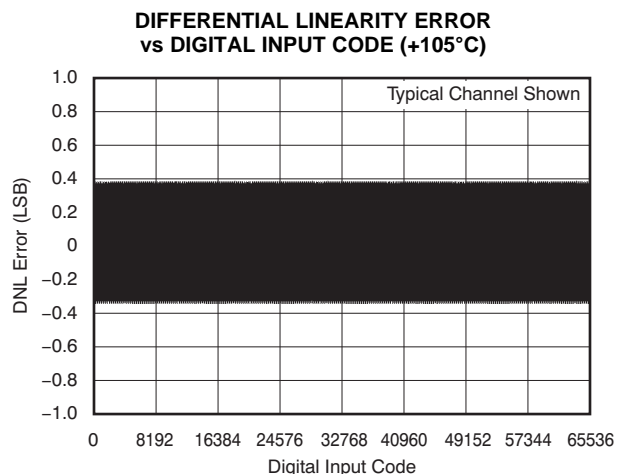

Figure 62.

TYPICAL CHARACTERISTICS: Unipolar (continued)

At $T_A = 25^\circ\text{C}$, $AV_{DD} = 32\text{V}$, $AV_{SS} = 0\text{V}$, $V_{REF} = 5\text{V}$, $IOV_{DD} = DV_{DD} = 5\text{V}$, gain=6, and data format=USB, unless otherwise noted.

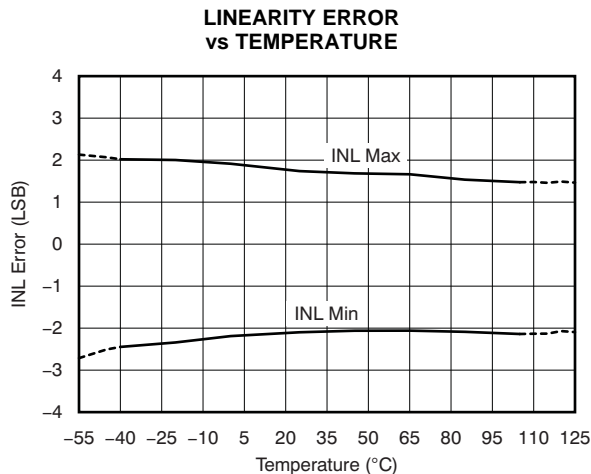

Figure 63.

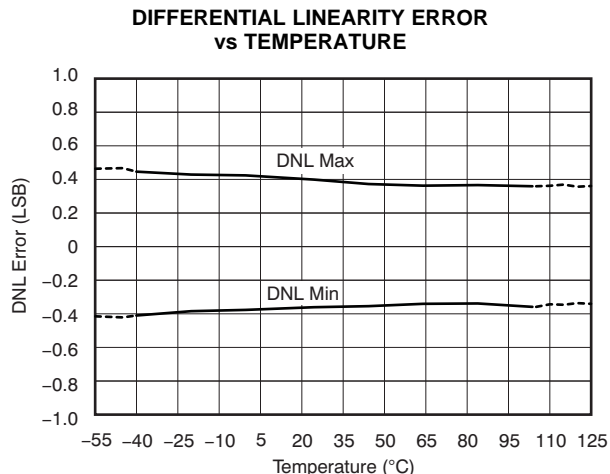

Figure 64.

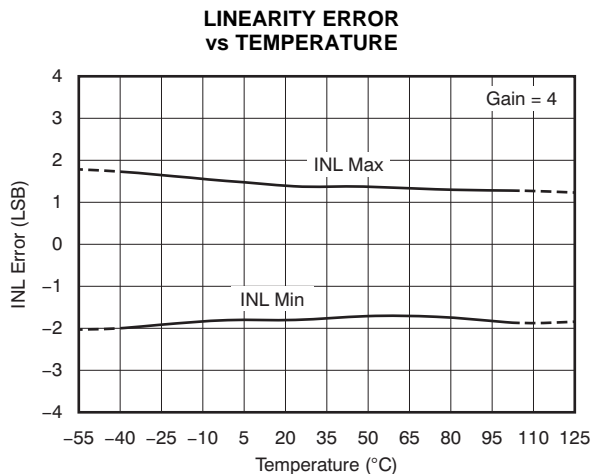

Figure 65.

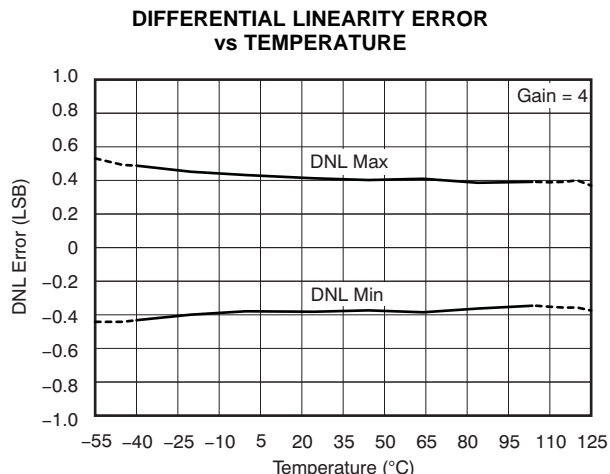

Figure 66.

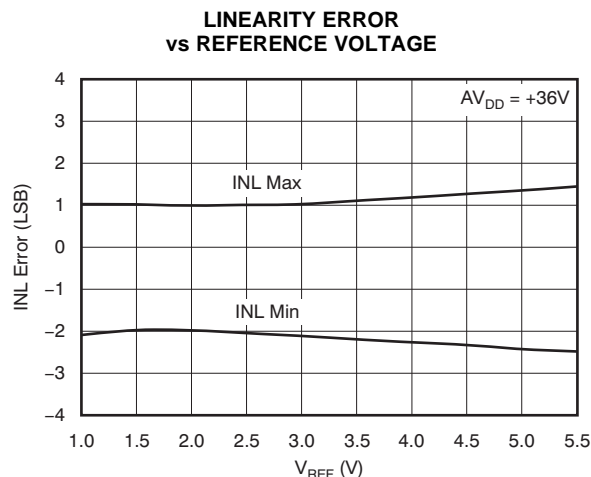

Figure 67.

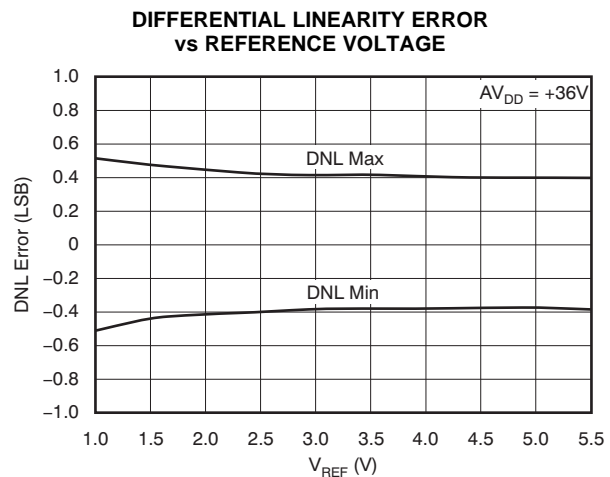

Figure 68.

TYPICAL CHARACTERISTICS: Unipolar (continued)

At $T_A = 25^\circ\text{C}$, $AV_{DD} = 32\text{V}$, $AV_{SS} = 0\text{V}$, $V_{REF} = 5\text{V}$, $IOV_{DD} = DV_{DD} = 5\text{V}$, gain=6, and data format=USB, unless otherwise noted.

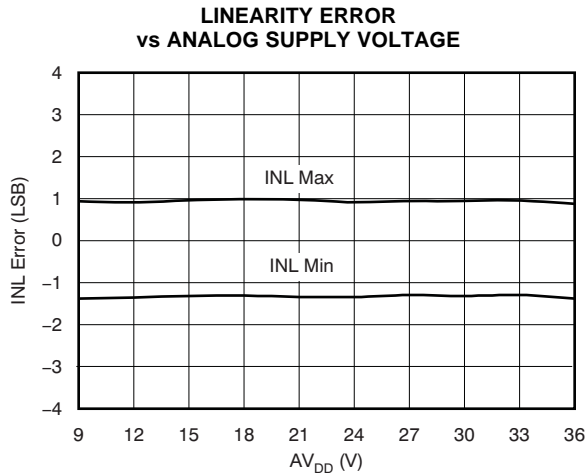

Figure 69.

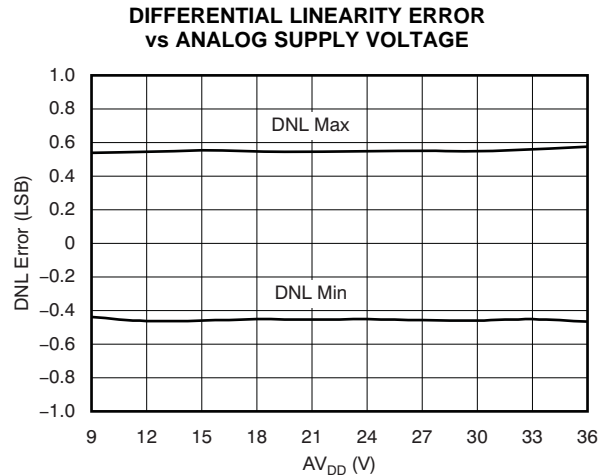

Figure 70.

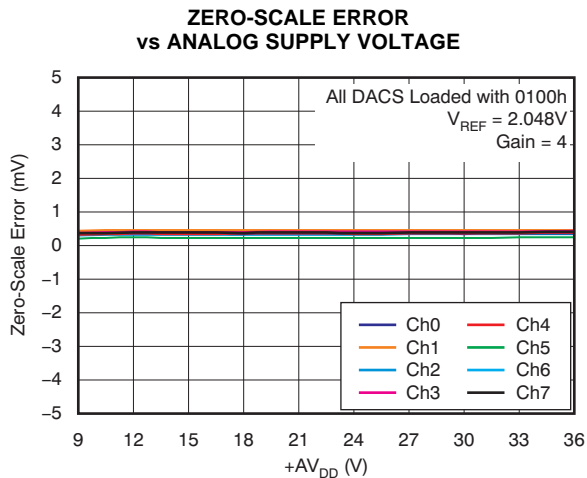

Figure 71.

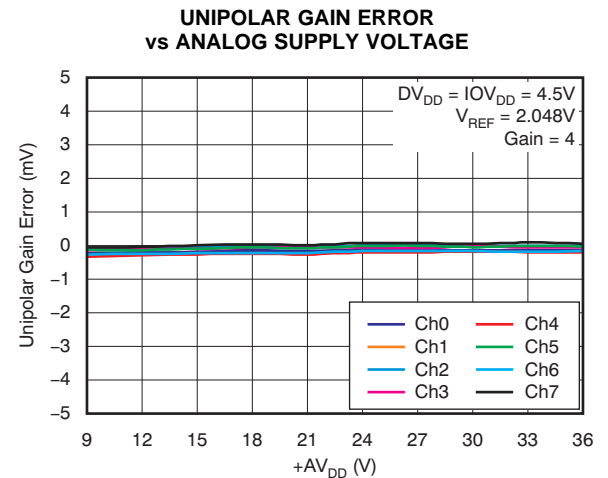

Figure 72.

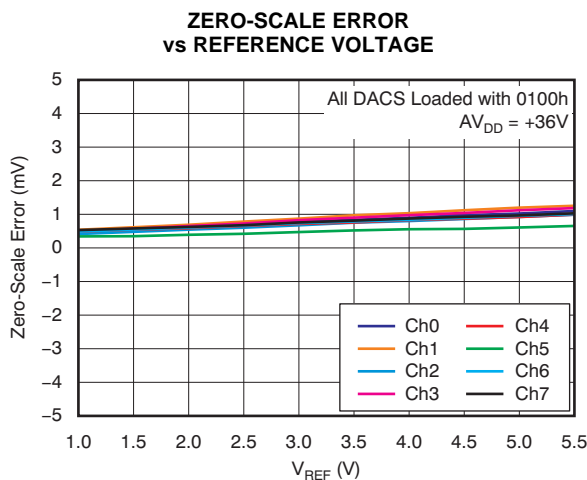

Figure 73.

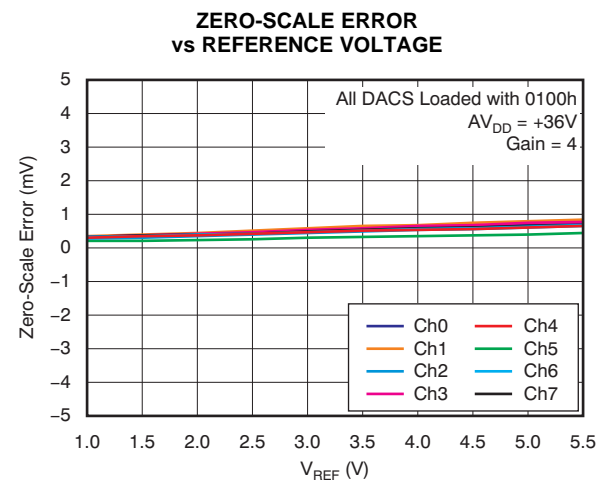

Figure 74.

TYPICAL CHARACTERISTICS: Unipolar (continued)

At $T_A = 25^\circ\text{C}$, $AV_{DD} = 32\text{V}$, $AV_{SS} = 0\text{V}$, $V_{REF} = 5\text{V}$, $IOV_{DD} = DV_{DD} = 5\text{V}$, gain=6, and data format=USB, unless otherwise noted.

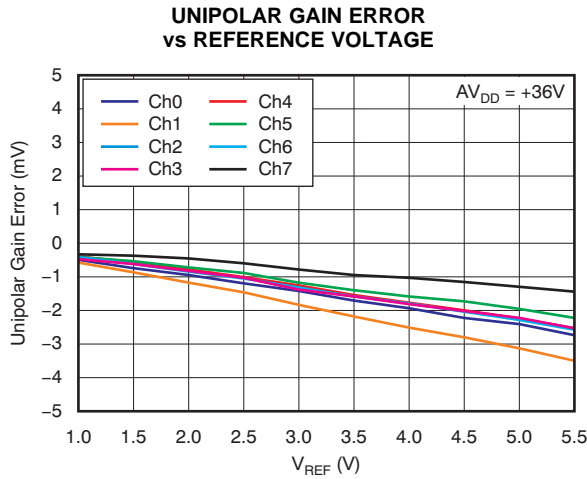

Figure 75.

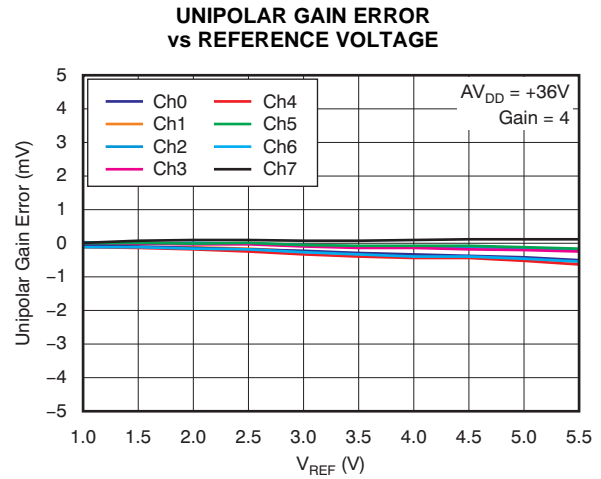

Figure 76.

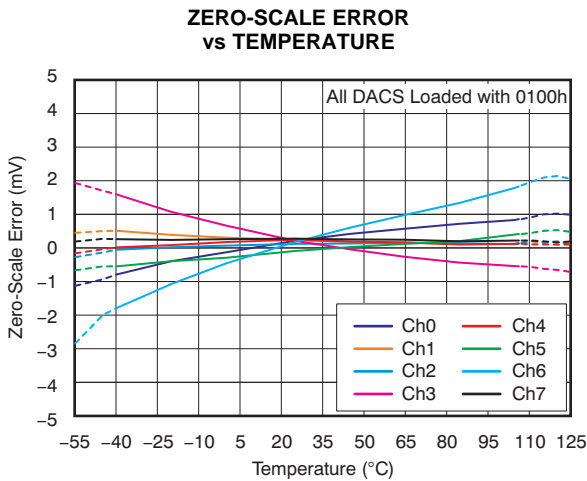

Figure 77.

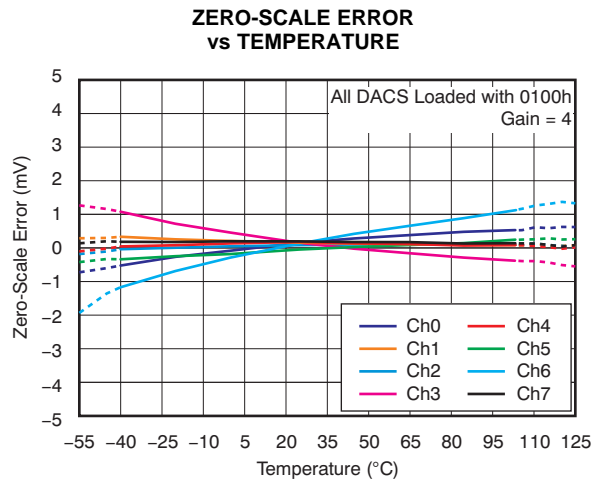

Figure 78.

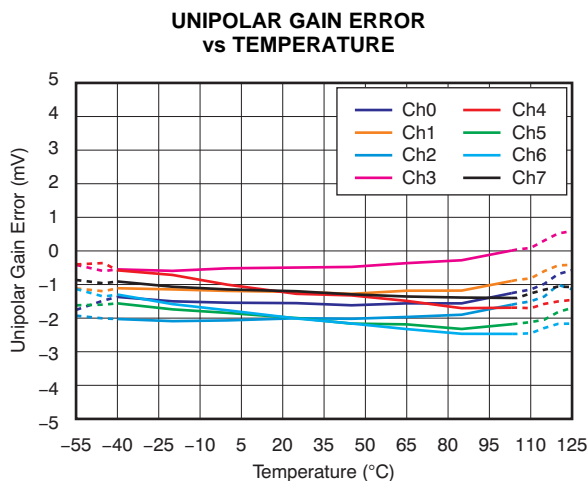

Figure 79.

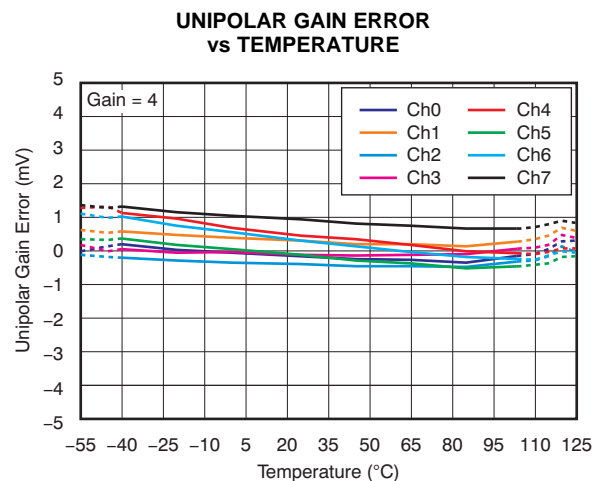

Figure 80.

TYPICAL CHARACTERISTICS: Unipolar (continued)

At $T_A = 25^\circ\text{C}$, $AV_{DD} = 32\text{V}$, $AV_{SS} = 0\text{V}$, $V_{REF} = 5\text{V}$, $IOV_{DD} = DV_{DD} = 5\text{V}$, gain=6, and data format=USB, unless otherwise noted.

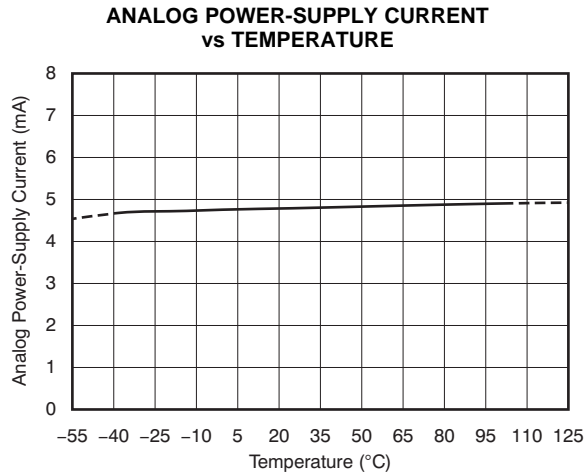

Figure 81.

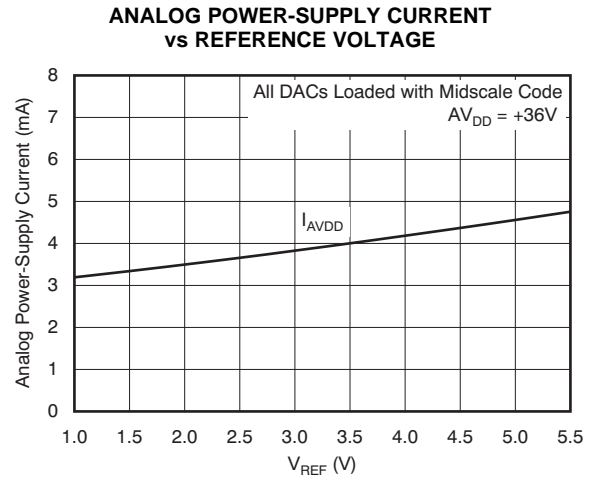

Figure 82.

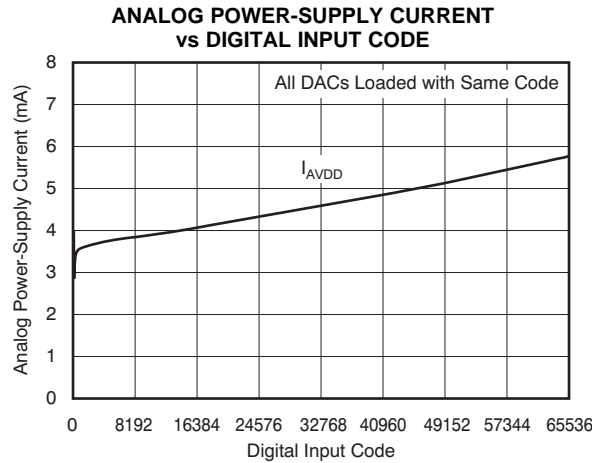

Figure 83.

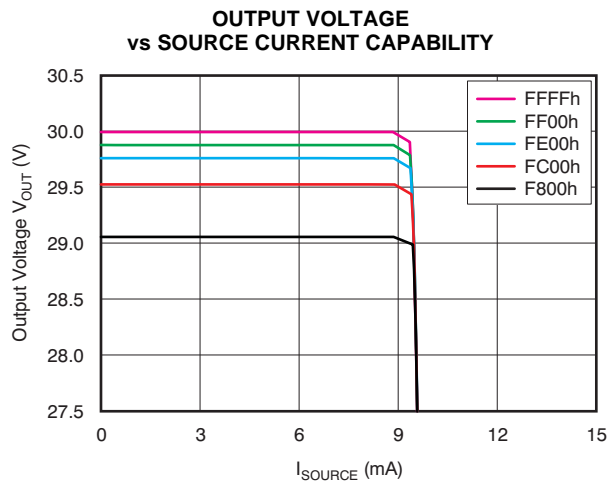

Figure 84.

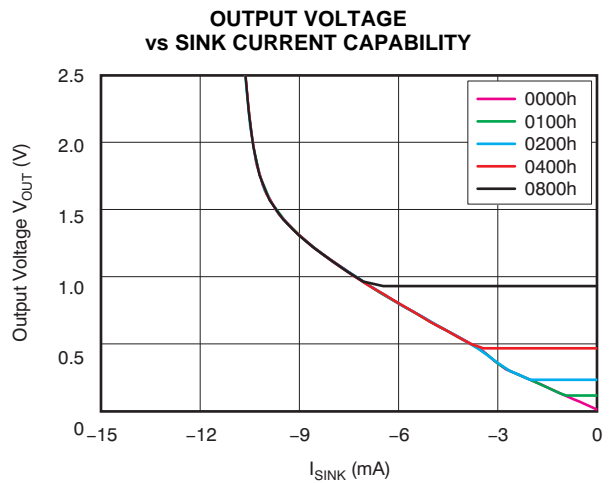

Figure 85.

TYPICAL CHARACTERISTICS: Unipolar (continued)

At $T_A = 25^\circ\text{C}$, $AV_{DD} = 32\text{V}$, $AV_{SS} = 0\text{V}$, $V_{REF} = 5\text{V}$, $IOV_{DD} = DV_{DD} = 5\text{V}$, gain=6, and data format=USB, unless otherwise noted.

**SETTLING TIME
0V TO 30V TRANSITION**

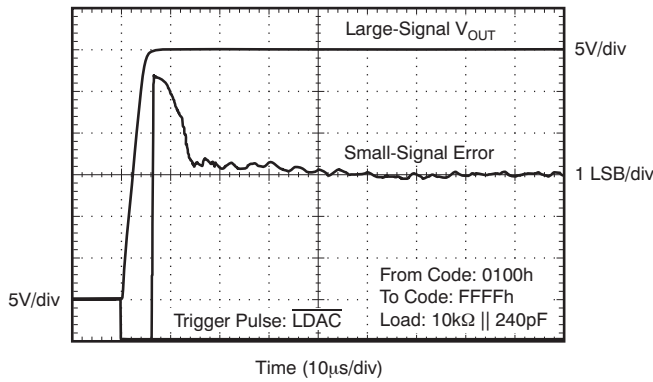

Figure 86.

**SETTLING TIME
30V TO 0V TRANSITION**

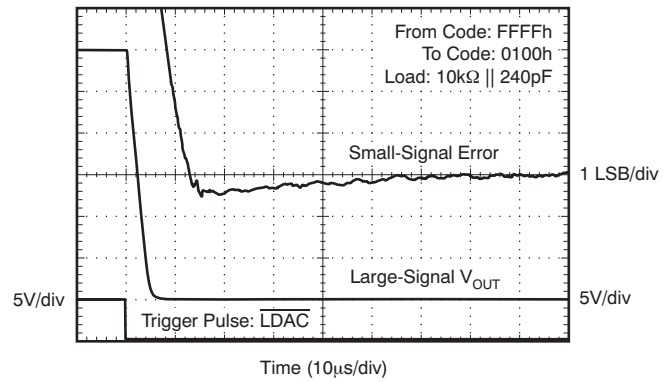

Figure 87.

**SETTLING TIME
1/4 TO 3/4 TRANSITION**

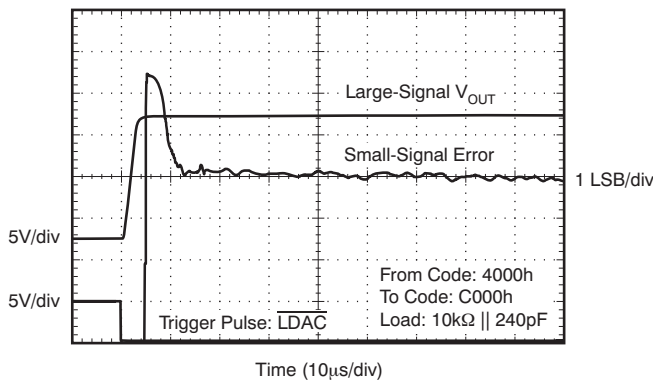

Figure 88.

**SETTLING TIME
3/4 TO 1/4 TRANSITION**

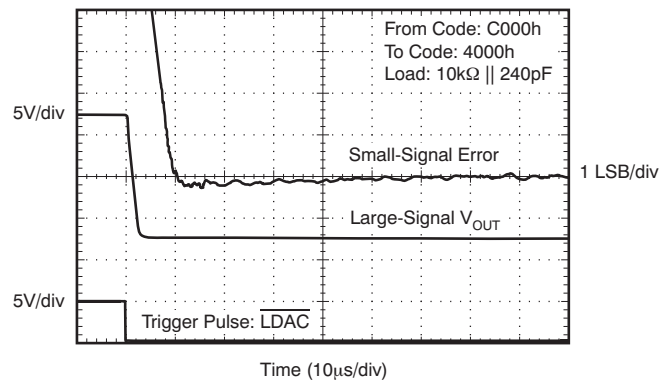

Figure 89.

**GLITCH ENERGY
1 LSB STEP, RISING EDGE**

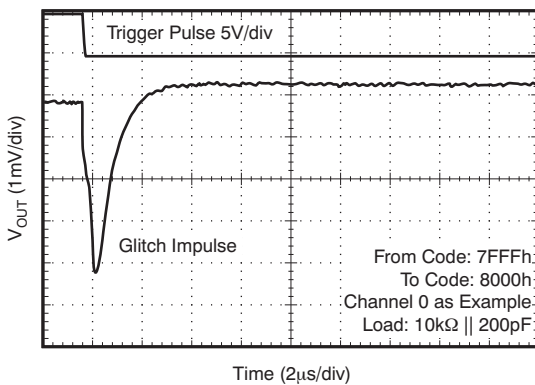

Figure 90.

**GLITCH ENERGY
1 LSB STEP, FALLING EDGE**

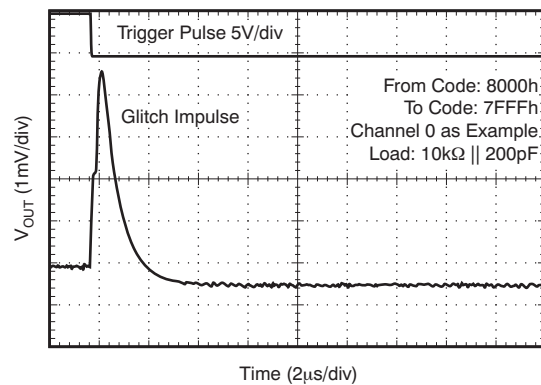

Figure 91.

TYPICAL CHARACTERISTICS: Unipolar (continued)

At $T_A = 25^\circ\text{C}$, $AV_{DD} = 32\text{V}$, $AV_{SS} = 0\text{V}$, $V_{REF} = 5\text{V}$, $IOV_{DD} = DV_{DD} = 5\text{V}$, gain=6, and data format=USB, unless otherwise noted.

ZERO-SCALE ERROR HISTOGRAM

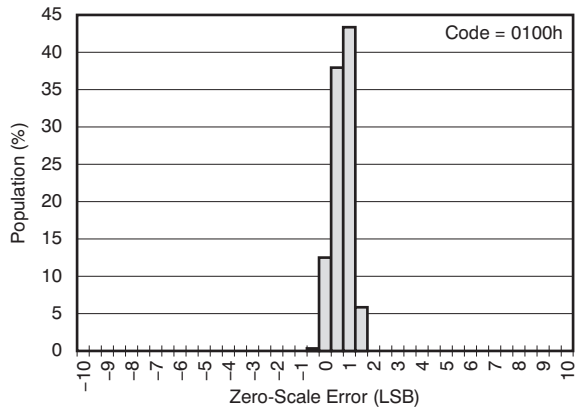

Figure 92.

ZERO-SCALE ERROR HISTOGRAM

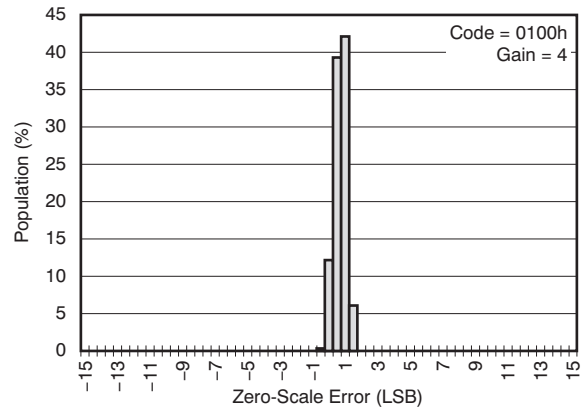

Figure 93.

UNIPOLAR GAIN ERROR HISTOGRAM

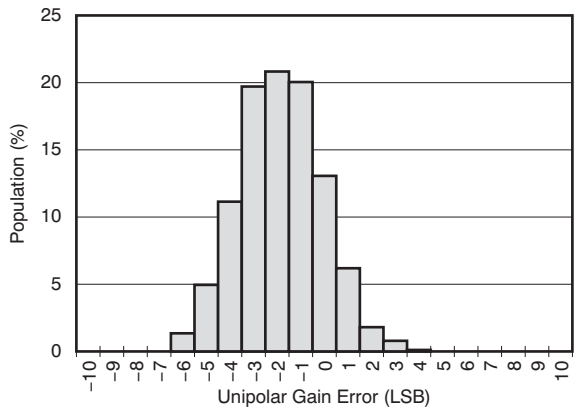

Figure 94.

UNIPOLAR GAIN ERROR HISTOGRAM

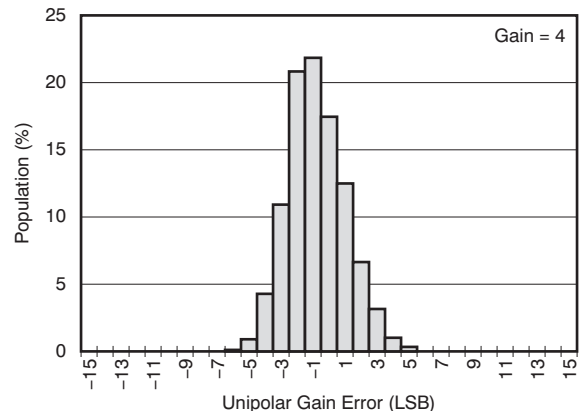

Figure 95.

ANALOG POWER-SUPPLY CURRENT HISTOGRAM

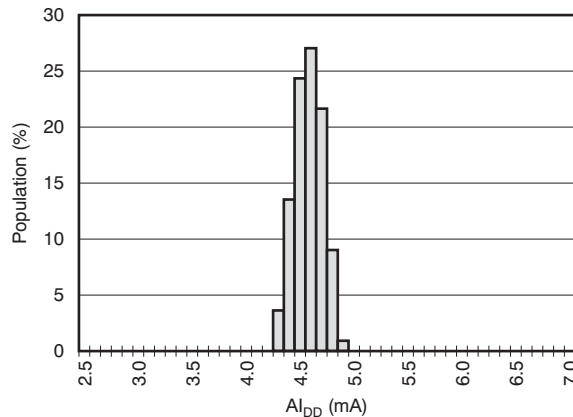

Figure 96.

THEORY OF OPERATION

GENERAL DESCRIPTION

The DAC8718 contains eight DAC channels and eight output amplifiers in a single package. Each channel consists of a resistor-string DAC followed by an output buffer amplifier. The resistor-string section is simply a string of resistors, each with a value of R , from REF-x to AGND, as shown in Figure 97. This type of architecture provides DAC monotonicity. The 16-bit binary digital code loaded to the DAC latch determines at which node on the string the voltage is tapped off before being fed into the output amplifier. The output amplifier multiplies the DAC output voltage by a gain of six or four. Using a gain of 6 and power supplies allowing for at least 0.5V headroom, the output span is 9V with a 1.5V reference, 18V with a 3V reference, and 30V with a 5V reference.

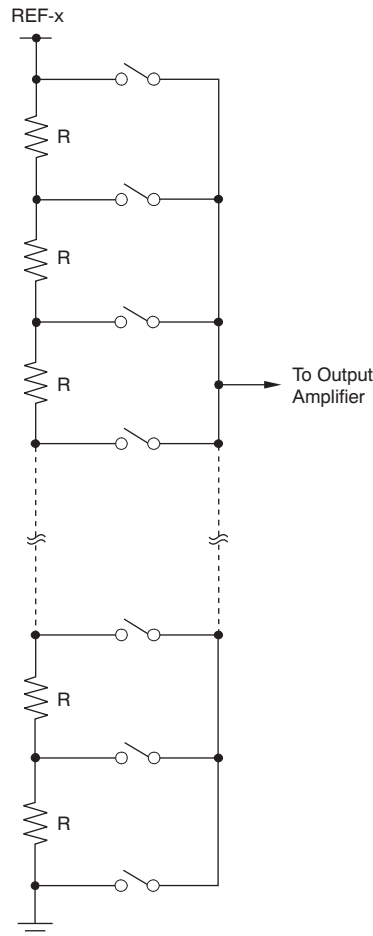

Figure 97. Resistor String

CHANNEL GROUPS

The eight DAC channels and two Offset DACs are arranged into two groups (A and B) with four channels and one Offset DAC per group. Group A consists of DAC-0, DAC-1, DAC-2, DAC-3, and Offset DAC-A. Group B consists of DAC-4, DAC-5, DAC-6, DAC-7, and Offset DAC-B. Group A derives its reference voltage from REF-A, and Group B derives its reference voltage from REF-B.

USER-CALIBRATION FOR ZERO-CODE ERROR AND GAIN ERROR

The DAC8718 implements a digital user-calibration function that allows for trimming gain and zero errors on the entire signal chain. This function can eliminate the need for external adjustment circuits. Each DAC channel has a Zero Register and Gain Register. Using the correction engine, the data from the Input Data Register are operated on by a digital adder and multiplier controlled by the contents of the Zero and Gain registers, respectively. The calibrated DAC data are then stored in the DAC Data Register where they are finally transferred into the DAC latch and set the DAC output. Each time the data are written to the Input Data Register (or to the Gain or Zero registers), the data in the Input Data Register are corrected, and the results automatically transferred to the DAC Data Register.

The range of the gain adjustment coefficient is 0.5 to 1.5. The range of the zero adjustment is -32768 LSB to $+32767$ LSB, or $\pm 50\%$ of full scale.

There is only one correction engine in the DAC8718, which is shared among all channels.

If the user-calibration function is not needed, the correction engine can be turned off. Setting the SCE bit in the Configuration Register to '0' turns off the correction engine. Setting SCE to '1' enables the correction engine. When SCE = '0', the data are directly transferred to the DAC Data Register. In this case, writing to the Gain Register or Zero Register updates the Gain and Zero registers but does not start a math engine calculation. Reading these registers returns the written values.

ANALOG OUTPUTS (V_{OUT-0} to V_{OUT-7} , with reference to the ground of REF-x)

When the correction engine is off (SCE = '0'):

$$V_{OUT} = V_{REF} \times \text{Gain} \times \left(\frac{\text{INPUT_CODE}}{65536} \right) - V_{REF} \times (\text{Gain} - 1) \times \left(\frac{\text{OFFSETDAC_CODE}}{65536} \right) \quad (1)$$

When the correction engine is on (SCE = '1'):

$$V_{OUT} = V_{REF} \times \text{Gain} \times \left(\frac{\text{DAC_DATA_CODE}}{65536} \right) - V_{REF} \times (\text{Gain} - 1) \times \left(\frac{\text{OFFSETDAC_CODE}}{65536} \right) \quad (2)$$

Where:

$$\text{DAC_DATA_CODE} = \left(\frac{\text{INPUT_CODE} \times (\text{USER_GAIN} + 2^{15})}{2^{16}} \right) + \text{USER_ZERO}$$

Gain = the DAC gain defined by the GAIN bit in the Configuration Register.

INPUT_CODE = data written into the Input Data Register (SCE = '1') or the DAC Data Register (SCE = '0').

OFFSETDAC_CODE = the data written into the Offset DAC Register.

USER_GAIN = the code of the Gain Register.

USER_ZERO = the code of the Zero Register.

For single-supply operation, the OFFSET-A pin must be connected to the AGND-A pin and the OFFSET-B pin must be connected to the AGND-B pin through low-impedance connections (see the [Layout](#) section for details). Offset DAC-A and Offset DAC-B are in a power-down state.

For dual-supply operation, the OFFSET-A and OFFSET-B default codes for a gain of 6 are 39322 with a ± 10 LSB variation, depending on the linearity of the Offset DACs. The default code for a gain of 4 is 43691 with a ± 10 LSB variation. The default codes of OFFSET-A and OFFSET-B are independently factory trimmed for both gains of 6 and 4.

The power-on default value of the Gain Register is 32768, and the default value of the Zero Register is '0'. The DAC input registers are set to a default value of 0000h.

Note that the maximum output voltage must not be greater than $(AV_{DD} - 0.5V)$ and the minimum output voltage must not be less than $(AV_{SS} + 0.5V)$; otherwise, the output may be saturated.

INPUT DATA FORMAT

The $\overline{\text{USB/BTC}}$ pin defines the input data format and the Offset DAC format. When this pin is connected to DGND, the Input DAC data and Offset DAC data are straight binary, as shown in Table 1 and Table 3. When this pin is connected to IOV_{DD}, the Input DAC data and Offset DAC data are in twos complement format, as shown in Table 2 and Table 4.

Table 1. Bipolar Output vs Straight Binary Code Using Dual Power Supplies with Gain = 6

USB CODE	NOMINAL OUTPUT	DESCRIPTION
FFFFh	$+3 \times V_{\text{REF}} \times (32767/32768)$	+Full-Scale – 1 LSB
...
8001h	$+3 \times V_{\text{REF}} \times (1/32768)$	+1 LSB
8000h	0	Zero
7FFFh	$-3 \times V_{\text{REF}} \times (1/32768)$	-1 LSB
...
0000h	$-3 \times V_{\text{REF}} \times (32768/32768)$	-Full-Scale

Table 2. Bipolar Output vs Twos Complement Code Using Dual Power Supplies with Gain = 6

BTC CODE	NOMINAL OUTPUT	DESCRIPTION
7FFFh	$+3 \times V_{\text{REF}} \times (32767/32768)$	+Full-Scale – 1 LSB
...
0001h	$+3 \times V_{\text{REF}} \times (1/32768)$	+1 LSB
0000h	0	Zero
FFFFh	$-3 \times V_{\text{REF}} \times (1/32768)$	-1 LSB
...
8000h	$-3 \times V_{\text{REF}} \times (32768/32768)$	-Full-Scale

Table 3. Unipolar Output vs Straight Binary Code Using Single Power Supply with Gain = 6

USB CODE	NOMINAL OUTPUT	DESCRIPTION
FFFFh	$+6 \times V_{\text{REF}} \times (65535/65536)$	+Full-Scale – 1 LSB
...
8001h	$+6 \times V_{\text{REF}} \times (32769/65536)$	Midscale + 1 LSB
8000h	$+6 \times V_{\text{REF}} \times (32768/65536)$	Midscale
7FFFh	$+6 \times V_{\text{REF}} \times (32767/65536)$	Midscale – 1 LSB
...
0000h	0	0

Table 4. Unipolar Output vs Twos Complement Code Using Single Power Supply with Gain = 6

BTC CODE	NOMINAL OUTPUT	DESCRIPTION
7FFFh	$+6 \times V_{\text{REF}} \times (65535/65536)$	+Full-Scale – 1 LSB
...
0001h	$+6 \times V_{\text{REF}} \times (32769/65536)$	Midscale + 1 LSB
0000h	$+6 \times V_{\text{REF}} \times (32768/65536)$	Midscale
FFFFh	$+6 \times V_{\text{REF}} \times (32767/65536)$	Midscale – 1 LSB
...
8000h	0	0

The data written to the Gain Register are always in straight binary, data to the Zero Register are in twos complement, and data to all other control registers are as specified in the definitions, regardless of the USB/BTC pin status.

In reading operation, the read-back data are in the same format as written.

OFFSET DACS

There are two 16-bit Offset DACs: one for Group A, and one for Group B. The Offset DACs allow the entire output curve of the associated DAC groups to be shifted by introducing a programmable offset. This offset allows for asymmetric bipolar operation of the DACs or unipolar operation with bipolar supplies. Thus, subject to the limitations of headroom, it is possible to set the output range of Group A and/or Group B to be unipolar positive, unipolar negative, symmetrical bipolar, or asymmetrical bipolar, as shown in [Table 5](#) and [Table 6](#). Increasing the digital input codes for the offset DAC shifts the outputs of the associated channels in the negative direction. The default codes for the Offset DACs in the DAC8718 are factory trimmed to provide optimal offset and gain performance for the default output range and span of symmetric bipolar operation. When the output range is adjusted by changing the value of the Offset DAC, an extra offset is introduced as a result of the linearity and offset errors of the Offset DAC. Therefore, the actual shift in the output span may vary slightly from the ideal calculations. For optimal offset and gain performance in the default symmetric bipolar operation, the Offset DAC input codes should not be changed from the default power-on values. The maximum allowable offset depends on the reference and the power supply. If INPUT_CODE from [Equation 1](#) or DAC_DATA_CODE from [Equation 2](#) is set to 0, then these equations simplify to [Equation 3](#):

$$V_{OUT} = -V_{REF} \times (\text{Gain} - 1) \times \left(\frac{\text{OFFSETDAC_CODE}}{65536} \right) \quad (3)$$

This equation shows the transfer function of the Offset DAC to the output of the DAC channels. In any case, the analog output must not go beyond the specified range shown in the [Analog Outputs](#) section. After power-on or reset, the Offset DAC is set to the value defined by the selected data format and the selected analog output voltage. If the DAC gain setting is changed, the offset DAC code is reset to the default value corresponding to the new DAC gain setting. Refer to the [Power-On Reset](#) and [Hardware Reset](#) sections for details.

For single-supply operation ($AV_{SS} = 0V$), the Offset DAC is turned off, and the output amplifier is in a Hi-Z state. The OFFSET-x pin must be connected to the AGND-x pin through a low-impedance connection (see the [Layout](#) section for details). For dual-supply operation, this pin provides the output of the Offset DAC. The OFFSET-x pin is not intended to drive an external load. See [Figure 98](#) for the internal Offset DAC and output amplifier configuration.

Table 5. Example of Offset DAC Codes and Output Ranges with Gain = 6 and $V_{REF} = 5V$

OFFSET DAC CODE	OFFSET DAC VOLTAGE	DAC CHANNELS MFS ⁽¹⁾ VOLTAGE	DAC CHANNELS PFS ⁽¹⁾ VOLTAGE
999Ah ⁽²⁾	3.0V	-15V	+15V – 1 LSB
0000h	0V	0V	+30V – 1 LSB
FFFFh	-5.0V	-25V	+5V – 1 LSB
6666h	-2.0V	-10V	+20V – 1 LSB
CCCDh	-4.0V	-20V	+10V – 1 LSB

(1) MFS = minus full-scale; PFS = plus full-scale.

(2) This is the default code for symmetric bipolar operation; actual codes may vary ± 10 LSB. Codes are in straight binary format.

Table 6. Example of Offset DAC Codes and Output Ranges with Gain = 4 and $V_{REF} = 5V$

OFFSET DAC CODE	OFFSET DAC VOLTAGE	DAC CHANNELS MFS ⁽¹⁾ VOLTAGE	DAC CHANNELS PFS ⁽¹⁾ VOLTAGE
AAABh ⁽²⁾	~3.33333V	-10V	+10V – 1 LSB
0000h	0V	0V	+20V – 1 LSB
FFFFh	-5.0V	-15V	+5V – 1 LSB
5555h	~1.666V	-5V	+15V – 1 LSB
8000h	2.5V	-7.5V	+12.5V – 1 LSB
D555h	~4.1666V	-12.5V	+7.5V – 1 LSB

(1) MFS = minus full-scale; PFS = plus full-scale.

(2) This is the default code for symmetric bipolar operation; actual codes may vary ± 10 LSB. Codes are in straight binary format.

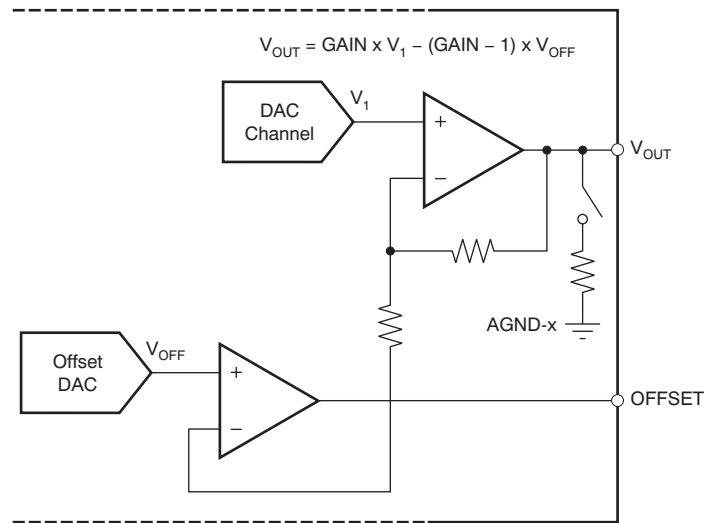

Figure 98. Output Amplifier and Offset DAC

OUTPUT AMPLIFIERS

The output amplifiers can swing to 0.5V below the positive supply and 0.5V above the negative supply. This condition limits how much the output can be offset for a given reference voltage. The maximum range of the output for $\pm 17V$ power and a +5.5V reference is $-16.5V$ to $+16.5V$ for gain = 6.

Each output amplifier is implemented with individual over-current protection. The amplifier is clamped at 8mA, even if the output current goes over 8mA.

GENERAL-PURPOSE INPUT/OUTPUT PINS (GPIO-0 to GPIO-2)

The GPIO pins are general-purpose, bidirectional, digital input/outputs, as shown in Figure 99. When a GPIO pin acts as an output, the pin status is determined by the corresponding GPIO bit in the GPIO Register. The pin output is high-impedance when the GPIO bit is set to '1', and is logic low when the GPIO bit is cleared to '0'. Note that a pull-up resistor to IOV_{DD} is required when using a GPIO pin as an output. When a GPIO pin acts as an input, the digital value on the pin is acquired by reading the corresponding GPIO bit. After power-on reset, or any forced hardware or software reset, the GPIO bits are set to '1', and the GPIO pins are in a high-impedance state. If not used, the GPIO pins must be tied to either DGND or to IOV_{DD} through a pull-up resistor. Leaving the GPIO pins floating can cause high IOV_{DD} supply currents.

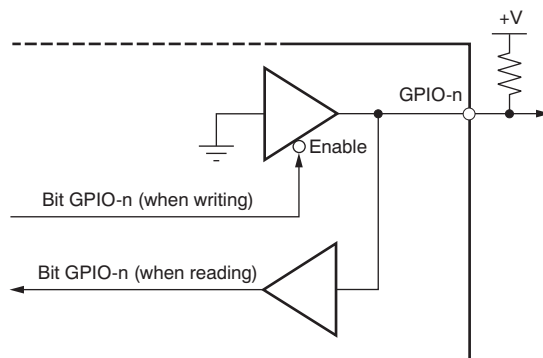

Figure 99. GPIO-n Pin

ANALOG OUTPUT PIN ($\overline{\text{CLR}}$)

The $\overline{\text{CLR}}$ pin is an active low input that should be high for normal operation. When this pin is in logic '0', all V_{OUT} outputs connect to AGND-x through internal 15k Ω resistors and are cleared to 0V, and the output buffer is in a Hi-Z state. While $\overline{\text{CLR}}$ is low, all LDAC pulses are ignored. When $\overline{\text{CLR}}$ is taken high again while the LDAC is high, the DAC outputs remain cleared until LDAC is taken low. However, if LDAC is tied low, taking $\overline{\text{CLR}}$ back to high sets the DAC output to the level defined by the value of the DAC latch. The contents of the Zero Registers, Gain Registers, Input Data Registers, DAC Data Registers, and DAC latches are not affected by taking $\overline{\text{CLR}}$ low.

POWER-ON RESET

The DAC8718 contains a power-on reset circuit that controls the output during power-on and power down. This feature is useful in applications where the known state of the DAC output during power-on is important. The Offset DAC Registers, DAC Data Registers, and DAC latches are loaded with the value defined by the RSTSEL pin, as shown in [Table 7](#). The Gain Registers and Zero Registers are loaded with default values. The Input Data Register is reset to 0000h, independent of the RSTSEL state.

Table 7. Bipolar Output Reset Values for Dual Power-Supply Operation

RSTSEL PIN	$\overline{\text{USB}}/\text{BTC}$ PIN	INPUT FORMAT	VALUE OF DAC DATA REGISTER AND DAC LATCH	VALUE OF OFFSET DAC REGISTER FOR GAIN = 6 ⁽¹⁾	V _{OUT}
DGND	DGND	Straight Binary	0000h	999Ah	–Full-Scale
IOV _{DD}	DGND	Straight Binary	8000h	999Ah	0 V
DGND	IOV _{DD}	Twos Complement	8000h	199Ah	–Full-Scale
IOV _{DD}	IOV _{DD}	Twos Complement	0000h	199Ah	0 V

(1) Offset DAC A and Offset DAC B are trimmed in manufacturing to minimize the error for symmetrical output. The default value may vary no more than ± 10 LSB from the nominal number listed in this table.

In single-supply operation, the Offset DAC is turned off and the output is unipolar. The power-on reset is defined as shown in [Table 8](#).

Table 8. Unipolar Output Reset Values for Single Power-Supply Operation

RSTSEL PIN	$\overline{\text{USB}}/\text{BTC}$ PIN	INPUT FORMAT	VALUE OF DAC DATA REGISTER AND DAC LATCH	V _{OUT}
DGND	DGND	Straight Binary	0000h	0 V
IOV _{DD}	DGND	Straight Binary	8000h	Midscale
DGND	IOV _{DD}	Twos Complement	8000h	0 V
IOV _{DD}	IOV _{DD}	Twos Complement	0000h	Midscale

HARDWARE RESET

When the $\overline{\text{RST}}$ pin is low, the device is in hardware reset. All the analog outputs (V_{OUT-0} to V_{OUT-7}), the DAC registers, and the DAC latches are set to the reset values defined by the RSTSEL pin as shown in [Table 7](#) and [Table 8](#). In addition, the Gain and Zero Registers are loaded with default values, communication is disabled, and the signals on $\overline{\text{CS}}$ and SDI are ignored (note that SDO is in a high-impedance state). The Input Data Register is reset to 0000h, independent of the RSTSEL state. On the rising edge of $\overline{\text{RST}}$, the analog outputs (V_{OUT-0} to V_{OUT-7}) maintain the reset value as defined by the RSTSEL pin until a new value is programmed. After $\overline{\text{RST}}$ goes high, the serial interface returns to normal operation. $\overline{\text{CS}}$ must be set to a logic high whenever $\overline{\text{RST}}$ is used.

UPDATING THE DAC OUTPUTS

Depending on the status of both \overline{CS} and \overline{LDAC} , and after data have been transferred into the DAC Data registers, the DAC outputs can be updated either in asynchronous mode or synchronous mode. This update mode is established at power-on. If asynchronous mode is desired, the \overline{LDAC} pin must be permanently tied low before power is applied to the device. If synchronous mode is desired, \overline{LDAC} must be logic high before and during power-on.

The DAC8718 updates a DAC latch only if it has been accessed since the last time \overline{LDAC} was brought low or if the LD bit is set to '1', thereby eliminating any unnecessary glitch. Any DAC channels that were not accessed are not loaded again. When the DAC latch is updated, the corresponding output changes to the new level immediately.

Asynchronous Mode

In this mode, the \overline{LDAC} pin is set low at power-up. This action places the DAC8718 into Asynchronous mode, and the LD bit and \overline{LDAC} signal are ignored. When the correction engine is off (SCE bit = '0'), the DAC Data Registers and DAC latches are updated immediately when \overline{CS} goes high. When the correction engine is on (SCE bit = '1'), each DAC latch is updated individually when the correction engine updates the corresponding DAC Data Register.

Synchronous Mode

To use this mode, set \overline{LDAC} high before \overline{CS} goes low, and then take \overline{LDAC} low or set the LD bit to '1' after \overline{CS} goes high. If \overline{LDAC} goes low or if the LD bit is set to '1' when SCE = '0', all DAC latches are updated simultaneously. If \overline{LDAC} goes low or if the LD bit is set to '1' when SCE = '1', all DAC latches are updated simultaneously after the correction engine has updated the corresponding DAC register.

In this mode, when \overline{LDAC} stays high, the DAC latch is not updated; therefore, the DAC output does not change. The DAC latch is updated by taking \overline{LDAC} low (or by setting the LD bit in the Configuration Register to '1') any time after the delay of t_9 from the rising edge of \overline{CS} . If the timing requirement of t_9 is not satisfied, invalid data are loaded. Refer to the [Timing Diagrams](#) and the Configuration Register ([Table 11](#)) for details.

MONITOR OUTPUT PIN (V_{MON})

The V_{MON} pin is the channel monitor output. It can be either high-impedance or monitor any one of the DAC outputs, auxiliary analog inputs, offset DAC outputs, or reference buffer outputs. The channel monitor function consists of an analog multiplexer addressed via the serial interface, allowing any channel output, reference buffer output, auxiliary analog inputs, or offset DAC output to be routed to the V_{MON} pin for monitoring using an external ADC. The monitor function is controlled by the Monitor Register, which allows the monitor output to be enabled or disabled. When disabled, the monitor output is high-impedance; therefore, several monitor outputs may be connected in parallel with only one enabled at a time.

Note that the multiplexer is implemented as a series of analog switches. Care should be taken to ensure the maximum current from the V_{MON} pin must not be greater than the given specification because this could conceivably cause a large amount of current to flow from the input of the multiplexer (that is, from V_{OUT-X}) to the output of the multiplexer (V_{MON}). Refer to the *Monitor Register* section and [Table 12](#) for more details.

ANALOG INPUT PINS (AIN-0 and AIN-1)

Pins AIN-0 and AIN-1 are two analog inputs that directly connect to the analog mux of the analog monitor output. When AIN-0 or AIN-1 is accessed, it is routed via the mux to the V_{MON} pin. Thus, one external ADC channel can monitor eight DACs plus two extra external analog signals, AIN-0 and AIN-1.

POWER-DOWN MODE

The DAC8718 is implemented with a power-down function to reduce power consumption. Either the entire device or each individual group can be put into power-down mode. If the proper power-down bit (PD-x) in the Configuration Register is set to '1', the individual group is put into power down mode. During power-down mode, the analog outputs (V_{OUT-0} to V_{OUT-7}) connect to AGND-X through an internal 15k Ω resistor, and the output buffer is in Hi-Z status. When the entire device is in power-down, the bus interface remains active in order to continue communication and receive commands from the host controller, but all other circuits are powered down. The host controller can wake the device from power-down mode and return to normal operation by clearing the PD-x bit; it takes 200 μ s or less for recovery to complete.

POWER-ON RESET SEQUENCING

The DAC8718 permanently latches the status of some of the digital pins at power-on. These digital levels should be well-defined before or while the digital supply voltages are applied. Therefore, it is advised to have a pull up resistor to IOV_{DD} for the digital initialization pins (LDAC, CLR, RST, CS, and RSTSEL) to ensure that these levels are set correctly while the digital supplies are raised.

For proper power-on initialization of the device, IOV_{DD} and the digital pins must be applied before or at the same time as DV_{DD}. If possible, it is preferred that IOV_{DD} and DV_{DD} can be connected together in order to simplify the supply sequencing requirements. Pull-up resistors should go to either supply. AV_{DD} should be applied after the digital supplies (IOV_{DD} and DV_{DD}) and digital initialization pins (LDAC, CLR, RST, CS, and RSTSEL). AV_{SS} can be applied at the same time as or after AV_{DD}. The REF-x pins must be applied last.

SERIAL INTERFACE

The DAC8718 is controlled over a versatile, three-wire serial interface that operates at clock rates of up to 50MHz and is compatible with SPI, QSPI™, Microwire™, and DSP™ standards.

SPI Shift Register

The SPI Shift Register is 24 bits wide. Data are loaded into the device MSB first as a 24-bit word under the control of the serial clock input, SCLK. The SPI Shift Register consists of a read/write bit, five register address bits, 16 data bits, and two reserve bits for future devices, as shown in [Table 9](#). The falling edge of \overline{CS} starts the communication cycle. The data are latched into the SPI Shift Register on the falling edge of SCLK while \overline{CS} is low. When \overline{CS} is high, the SCLK and SDI signals are blocked and the SDO pin is in a high-impedance state. The contents of the SPI shifter register are decoded and transferred to the proper internal registers on the rising edge of \overline{CS} . The timing for this operation is shown in the [Timing Diagrams](#) section.

The serial interface works with both a continuous and non-continuous serial clock. A continuous SCLK source can only be used if \overline{CS} is held low for the correct number of clock cycles. In gated clock mode, a burst clock containing the exact number of clock cycles must be used and \overline{CS} must be taken high after the final clock in order to latch the data.

The serial interface requires \overline{CS} to be logic high during the power-on sequencing; therefore, it is advised to have a pullup resistor to IOV_{DD} on the \overline{CS} pin. Refer to the [Power-On Reset Sequencing](#) section for further details.

Stand-Alone Operation

The serial clock can be a continuous or a gated clock. The first falling edge of \overline{CS} starts the operation cycle. Exactly 24 falling clock edges must be applied before \overline{CS} is brought back high again. If \overline{CS} is brought high before the 24th falling SCLK edge, then the data written are not transferred into the internal registers. If more than 24 falling SCLK edges are applied before \overline{CS} is brought high, then the last 24 bits are used. The device internal registers are updated from the Shift Register on the rising edge of \overline{CS} . In order for another serial transfer to take place, \overline{CS} must be brought low again.

When the data have been transferred into the chosen register of the addressed DAC, all DAC latches and analog outputs can be updated by taking \overline{LDAC} low.

Daisy-Chain Operation

For systems that contain more than one device, the SDO pin can be used to daisy-chain multiple devices together. Daisy-chain operation can be useful in system diagnostics and in reducing the number of serial interface lines. Note that before daisy-chain operation can begin, the SDO pin must be enabled by setting the SDO disable bit (DSDO) in the Configuration Register to '0'; this bit is cleared by default.

The DAC8718 provides two modes for daisy-chain operation: normal and sleep. The SLEEP bit in the SPI Mode register determines which mode is used.

In Normal mode (SLEEP bit = '0'), the data clocked into the SDI pin are transferred into the Shift Register. The first falling edge of \overline{CS} starts the operating cycle. SCLK is continuously applied to the SPI Shift Register when \overline{CS} is low. If more than 24 clock pulses are applied, the data ripple out of the Shift Register and appear on the SDO line. These data are clocked out on the rising edge of SCLK and are valid on the falling edge. By connecting the SDO pin of the first device to the SDI input of the next device in the chain, a multiple-device interface is constructed. Each device in the system requires 24 clock pulses. Therefore, the total number of clock cycles must equal $24 \times N$, where N is the total number of DAC8718s in the chain. When the serial transfer to all devices is complete, \overline{CS} is taken high. This action latches the data from the SPI Shift Registers to the device internal registers for each device in the daisy-chain, and prevents any further data from being clocked in. The serial clock can be a continuous or a gated clock. Note that a continuous SCLK source can only be used if \overline{CS} is held low for the correct number of clock cycles. For gated clock mode, a burst clock containing the exact number of clock cycles must be used and \overline{CS} must be taken high after the final clock in order to latch the data.

In Sleep mode (SLEEP bit = '1'), the data clocked into SDI are routed to the SDO pin directly; the Shift Register is bypassed. The first falling edge of \overline{CS} starts the operating cycle. When SCLK is continuously applied with \overline{CS} low, the data clocked into the SDI pin appear on the SDO pin almost immediately (with approximately a 5 ns delay; see the [Timing Diagrams](#) section); there is no 24 clock delay, as there is in normal operating mode. While in Sleep mode, no data bits are clocked into the Shift Register, and the device does not receive any new data or commands. Putting the device into Sleep mode eliminates the 24 clock delay from SDI to SDO caused by the

Shift Register, thus greatly speeding up the data transfer. For example, consider three DAC8718s (A, B, and C) in a daisy-chain configuration. The data from the SPI controller are transferred first to A, then to B, and finally to C. In normal daisy-chain operation, a total of 72 clocks are needed to transfer one word to C. However, if A and B are placed into Sleep mode, the first 24 data bits are directly transferred to C (through A and B); therefore, only 24 clocks are needed.

To wake the device up from sleep mode and return to normal operation, either one of following methods can be used:

1. Pull the $\overline{\text{WAKEUP}}$ pin low, which forces the SLEEP bit to '0' and returns the device to normal operating mode.
2. Use the W2 bit and the $\overline{\text{CS}}$ pin.

When the W2 bit = '1', if $\overline{\text{CS}}$ is applied with no more than one falling edge of SCLK, then the rising edge of $\overline{\text{CS}}$ wakes the device from sleep mode back to normal operation. However, the device will not wake-up if more than one falling edge of SCLK exists while $\overline{\text{CS}}$ is low.

Read-Back Operation

The READ command is used to start read-back operation. However, before read-back operation can be initiated, the SDO pin must be enabled by setting the DSDO bit in the Configuration Register to '0'; this bit is cleared by default. Read-back operation is then started by executing a READ command (R/W bit = '1', see Table 9). Bits A4 to A0 in the READ command select the register to be read. The remaining data in the command are *don't care* bits. During the next SPI operation, the data appearing on the SDO output are from the previously addressed register. For a read of a single register, a NOP command can be used to clock out the data from the selected register on SDO. Multiple registers can be read if multiple READ commands are issued. The readback diagram in Figure 100 shows the read-back sequence.

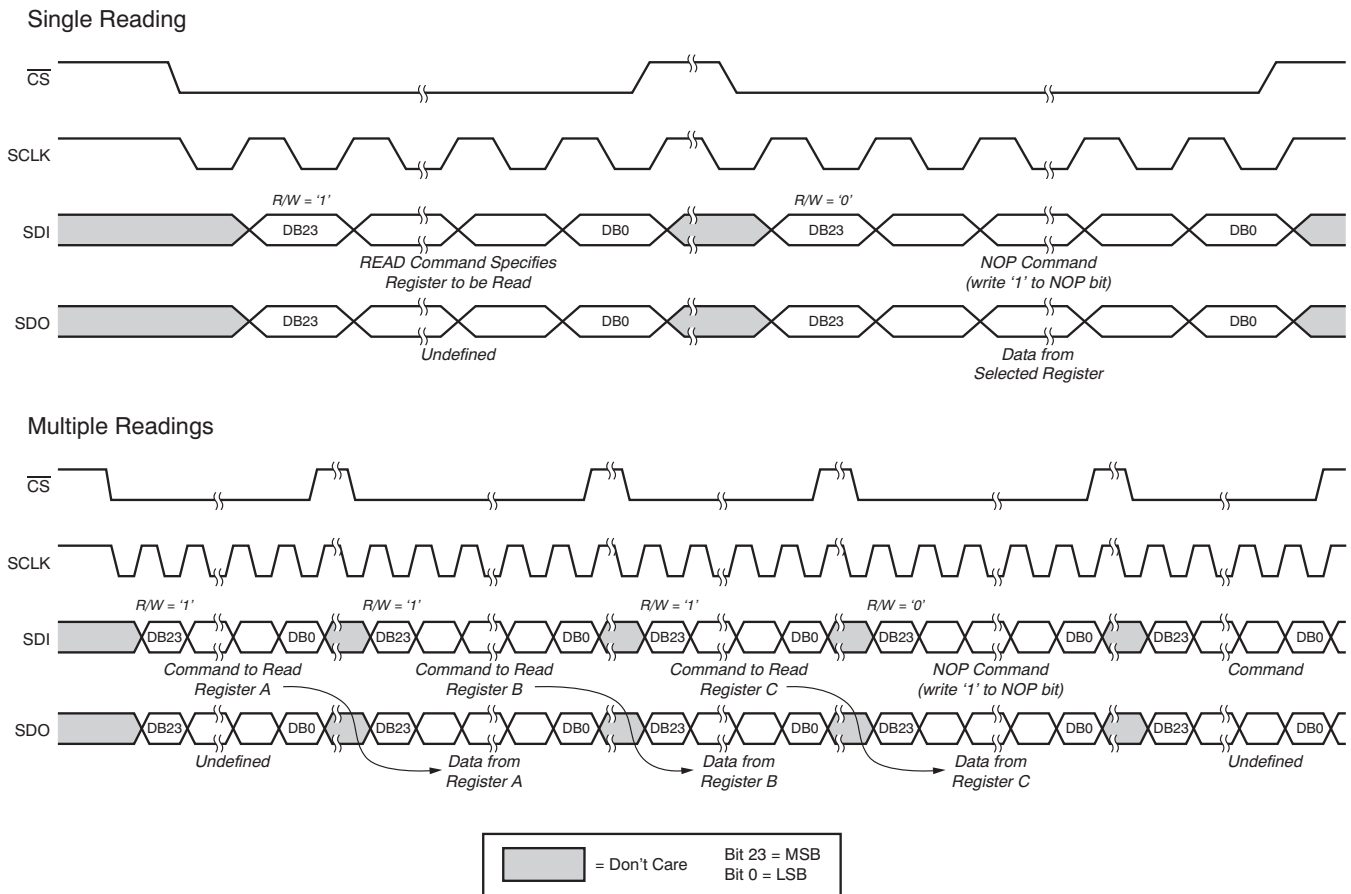

Figure 100. Read-Back Operation

SPI SHIFT REGISTER

The SPI Shift Register is 24 bits wide, as shown in [Table 9](#). The register mapping is shown in [Table 10](#); X = don't care—writing to it has no effect, reading it returns '0'.

Table 9. Shift Register Format

MSB								
DB23	DB22	DB21	DB20	DB19	DB18	DB17	DB16	DB15:DB0
R/W	X	X	A4	A3	A2	A1	A0	DATA

R/W Indicates a read from or a write to the addressed register.

R/W = '0' sets a write operation and the data are written to the specified register.

R/W = '1' sets a read-back operation. Bits A4 to A0 select the register to be read. The remaining bits are *don't care* bits. During the next SPI operation, the data appearing on SDO pin are from the previously addressed register.

A4:A0 Address bits that specify which register is accessed.

DATA 16 data bits

Table 10. Register Map

ADDRESS BITS					DATA BITS														REGISTER
A4	A3	A2	A1	A0	D15	D14	D13	D12	D11	D10	D9	D8	D7	D6	D5	D4	D3:D0		
0	0	0	0	0	A/B	LD	RST	PD-A	PD-B	SCE	X	GAIN-A	GAIN-B	DSDO	NOP	W2	X ⁽¹⁾	Configuration Register	
0	0	0	0	1	Analog Monitor Select													X ⁽¹⁾	Monitor Register
0	0	0	1	0	GPIO-2	GPIO-1	GPIO-0	X ⁽¹⁾										GPIO Register	
0	0	0	1	1	OS15:OS0 ⁽²⁾													Offset DAC-A Data	
0	0	1	0	0	OS15:OS0 ⁽²⁾													Offset DAC-B Data	
0	0	1	0	1	Reserved ⁽³⁾													Reserved	
0	0	1	1	0	SLEEP	Reserved ⁽³⁾												SPI MODE	
0	0	1	1	1	DB15:DB0													Broadcast	
0	1	0	0	0	DB15:DB0													DAC-0	
0	1	0	0	1	DB15:DB0													DAC-1	
0	1	0	1	0	DB15:DB0													DAC-2	
0	1	0	1	1	DB15:DB0													DAC-3	
0	1	1	0	0	DB15:DB0													DAC-4	
0	1	1	0	1	DB15:DB0													DAC-5	
0	1	1	1	0	DB15:DB0													DAC-6	
0	1	1	1	1	DB15:DB0													DAC-7	
1	0	0	0	0	Z15:Z0, default = 0 (0000h), twos complement													Zero Register-0	
1	1	0	0	0	G15:G0, default = 32768 (8000h), straight binary													Gain Register-0	
1	0	0	0	1	Z15:Z0, default = 0 (0000h), twos complement													Zero Register-1	
1	1	0	0	1	G15:G0, default = 32768 (8000h), straight binary													Gain Register-1	
1	0	0	1	0	Z15:Z0, default = 0 (0000h), twos complement													Zero Register-2	
1	1	0	1	0	G15:G0, default = 32768 (8000h), straight binary													Gain Register-2	
1	0	0	1	1	Z15:Z0, default = 0 (0000h), twos complement													Zero Register-3	
1	1	0	1	1	G15:G0, default = 32768 (8000h), straight binary													Gain Register-3	
1	0	1	0	0	Z15:Z0, default = 0 (0000h), twos complement													Zero Register-4	
1	1	1	0	0	G15:G0, default = 32768 (8000h), straight binary													Gain Register-4	
1	0	1	0	1	Z15:Z0, default = 0 (0000h), twos complement													Zero Register-5	
1	1	1	0	1	G15:G0, default = 32768 (8000h), straight binary													Gain Register-5	
1	0	1	1	0	Z15:Z0, default = 0 (0000h), twos complement													Zero Register-6	
1	1	1	1	0	G15:G0, default = 32768 (8000h), straight binary													Gain Register-6	
1	0	1	1	1	Z15:Z0, default = 0 (0000h), twos complement													Zero Register-7	
1	1	1	1	1	G15:G0, default = 32768 (8000h), straight binary													Gain Register-7	

- (1) X = don't care—writing to this bit has no effect; reading the bit returns '0'.
- (2) Table 7 lists the default values for a dual power supply. Offset DAC A and Offset DAC B are trimmed in manufacturing to minimize the error for symmetrical output. The default value may vary no more than ±10 LSB from the nominal number listed in Table 7. For a single power supply, the Offset DACs are turned off.
- (3) Writing to a reserved bit has no effect; reading the bit returns '0'.

INTERNAL REGISTERS

The DAC8718 internal registers consist of the Configuration Register, the Monitor Register, the DAC Input Data Registers, the Zero Registers, the DAC Data Registers, and the Gain Registers, and are described in the following section.

The Configuration Register specifies which actions are performed by the device. [Table 11](#) shows the details.

Table 11. Configuration Register (Default = 8000h)

BIT	NAME	DEFAULT VALUE	DESCRIPTION
D15	A/B	1	A/B bit. When A/B = '0', reading DAC-x returns the value in the Input Data Register. When A/B = '1', reading DAC-x returns the value in the DAC Data Register. When the correction engine is enabled, the data returned from the Input Data Register is the original data written to the bus, and the value in the DAC Data Register is the corrected data.
D14	LD	0	Synchronously update DACs bit. When LDAC is tied high, setting LD = '1' at any time after the write operation and the correction process complete synchronously updates all DAC latches with the content of the corresponding DAC Data Register, and sets V_{OUT} to a new level. The DAC8718 updates the DAC latch only if it has been accessed since the last time LDAC was brought low or the LD bit was set to '1', thereby eliminating unnecessary glitch. Any DACs that were not accessed are not reloaded. After updating, the bit returns to '0'. When the correction engine is turned off, bit LD can be set to '1' any time after the writing operation is complete; the DAC latch is immediately updated when bit LD is set. When the LDAC pin is tied low, this bit is ignored.
D13	RST	0	Software reset bit. Set the RST bit to '1' to reset the device; functions the same as a hardware reset. After reset completes, the RST bit returns to '0'.
D12	PD-A	0	Power-down bit for Group A (DAC-0, DAC-1, DAC-2, and DAC-3). Setting the PD-A bit to '1' places Group A (DAC-0, DAC-1, DAC-2, and DAC-3) into power-down operation. All output buffers are in Hi-Z and all analog outputs (V_{OUT-X}) connect to AGND-A through an internal 15-k Ω resistor. The interface is still active. Setting the PD-A bit to '0' returns group A to normal operation.
D11	PD-B	0	Power-down bit for Group B (DAC-4, DAC-5, DAC-6, and DAC-7). Setting the PD-B bit to '1' places Group B (DAC-4, DAC-5, DAC-6, and DAC-7) into power-down operation. All output buffers are in Hi-Z and all analog outputs (V_{OUT-X}) connect to AGND-B through an internal 15-k Ω resistor. The interface is still active. Setting the PD-B bit to '0' returns group B to normal operation.
D10	SCE	0	System-calibration enable bit. Set the SCE bit to '1' to enable the correction engine. When the engine is enabled, the input data are adjusted by the correction engine according to the contents of the corresponding Gain Register and Zero Register. The results are transferred to the corresponding DAC Data Register, and finally loaded into the DAC latch, which sets the V_{OUT-X} pin output level. Set the SCE bit to '0' to turn off the correction engine. When the engine is turned off, the input data are transferred to the corresponding DAC Data Register immediately, and then loaded into the DAC latch, which sets the output voltage. Refer to the User Calibration for Zero-Code Error and Gain Error section for details.
D9	—	0	Reserved. Writing to this bit has no effect; reading this bit returns '0'.
D8	GAIN-A	0	Gain bit for Group A (DAC-0, DAC-1, DAC-2, and DAC-3). Updating this bit to a new value automatically resets the Offset DAC-A Register to the factory-trimmed value for the new gain setting. Set the GAIN-A bit to '0' for an output span = 6 \times REF-A. Set the GAIN-A bit to '1' for an output span = 4 \times REF-A.
D7	GAIN-B	0	Gain bit for Group B (DAC-4, DAC-5, DAC-6, and DAC-7). Updating this bit to a new value automatically resets the Offset DAC-B Register to the factory-trimmed value for the new gain setting. Set the GAIN-B bit to '0' for an output span = 6 \times REF-B. Set the GAIN-B bit to '1' for an output span = 4 \times REF-B.
D6	DSDO	0	Disable SDO bit. Set the DSDO bit to '0' to enable the SDO pin (default). The SDO pin works as a normal SPI output. Set the DSDO bit to '1' to disable the SDO pin. The SDO pin is always in a Hi-Z state no matter what the status of the \overline{CS} pin is.
D5	NOP	0	No operation bit. During a write operation, setting the NOP bit to '1' has no effect (the bit returns to '0' when the write operation completes). Setting the NOP bit to '0', returns the device to normal operation. During a read operation, the bit always returns "0"
D4	W2	0	Second wake-up operation bit. If the WAKEUP pin is high, an alternative method to wake-up the device from sleep in SPI is by using the \overline{CS} pin. When W2 = '1', the rising edge of \overline{CS} restores the device from sleep mode to normal operation, if no more than one falling edge of SCLK exists while \overline{CS} is low. However, the device will not wake up if more than one falling edge of SCLK exists. Setting the W2 bit to '0' disables this function, and the rising edge of \overline{CS} does not wake up the device. If the WAKEUP is low, this bit is ignored and the device is always in normal mode.
D3:D0	—	0	Reserved. Writing to these bits has no effect; reading these bits returns '0'.

Monitor Register (default = 0000h).

The Monitor Register selects one of the DAC outputs, auxiliary analog inputs, reference buffer outputs, or offset DAC outputs to be monitored through the V_{MON} pin. When bits [D15:D4] = '0', the monitor is disabled and V_{MON} is in a Hi-Z state.

Note that if any value is written other than those specified in Table 12, the Monitor Register stores the invalid value; however, the V_{MON} pin is forced into a Hi-Z state.

Table 12. Monitor Register (Default = 0000h)

D15	D14	D13	D12	D11	D10	D9	D8	D7	D6	D5	D4	D3:D0	V_{MON} CONNECTS TO
0	0	0	0	0	0	0	0	0	0	0	1	X ⁽¹⁾	Reference buffer B output
0	0	0	0	0	0	0	0	0	0	1	0	X	Reference buffer A output
0	0	0	0	0	0	0	0	0	1	0	1	X	Offset DAC B output
0	0	0	0	0	0	0	0	0	1	1	0	X	Offset DAC A output
0	0	0	0	0	0	0	0	0	1	0	0	X	AIN-0
0	0	0	0	0	0	0	0	1	0	0	0	X	AIN-1
0	0	0	0	0	0	0	1	0	0	0	0	X	DAC-0
0	0	0	0	0	0	1	0	0	0	0	0	X	DAC-1
0	0	0	0	0	1	0	0	0	0	0	0	X	DAC-2
0	0	0	0	1	0	0	0	0	0	0	0	X	DAC-4
0	0	0	1	0	0	0	0	0	0	0	0	X	DAC-4
0	0	1	0	0	0	0	0	0	0	0	0	X	DAC-5
0	1	0	0	0	0	0	0	0	0	0	0	X	DAC-6
1	0	0	0	0	0	0	0	0	0	0	0	X	DAC-7
0	0	0	0	0	0	0	0	0	0	0	0	X	Monitor function disabled, Hi-Z (default)

(1) X = don't care.

GPIO Register (default = E000h).

The GPIO Register determines the status of each GPIO pin.

D15	D14	D13	D12	D11	D10	D9	D8	D7	D6	D5	D4	D3	D2	D1	D0
GPIO-2	GPIO-1	GPIO-0	X	X	X	X	X	X	X	X	X	X	X	X	X

GPIO-2:0 For write operations, the GPIO-n pin operates as an output. Writing a '1' to the GPIO-n bit sets the GPIO-n pin to high impedance, and writing a '0' sets the GPIO-n pin to logic low. An external pull-up resistor is required when using the GPIO-n pin as an output.

For read operations, the GPIO-n pin operates as an input. Read the GPIO-n bit to receive the status of the corresponding GPIO-n pin. Reading a '0' indicates that the GPIO-n pin is low, and reading a '1' indicates that the GPIO-n pin is high.

After power-on reset, or any forced hardware or software reset, all GPIO-n bits are set to '1', and the GPIO pins are in a high impedance state.

Offset DAC-A/B Registers (default = 999Ah for dual supplies or 0000h for single supplies).

The Offset DAC-A and Offset DAC-B registers contain, by default, the factory-trimmed Offset DAC code providing optimal offset and span for symmetric bipolar operation when dual supplies are detected, and contain code 0000h when a single supply is detected.

D15	D14	D13	D12	D11	D10	D9	D8	D7	D6	D5	D4	D3	D2	D1	D0
OS15	OS14	OS13	OS12	OS11	OS10	OS9	OS8	OS7	OS6	OS5	OS4	OS3	OS2	OS1	OS0

OS15:0 For dual-supply operation, the default code for a gain of 6 is 999Ah with a ± 10 LSB variation, depending on the linearity of each Offset DAC. The default code for a gain of 4 is AAABh with a ± 10 LSB variation. The default codes of Offset DAC-A and Offset DAC-B registers are independently factory trimmed for both gains of 6 and 4.

When single-supply operation is present, writing to these registers is ignored and reading returns 0000h. When dual-supply operation is present, updating the GAIN-A (GAIN-B) bit on the configuration register automatically reloads the factory-trimmed code into the Offset DAC-A (Offset DAC-B) register for the new GAIN-A (GAIN-B) setting. See the [Offset DACs](#) for further details.

SPI MODE Register (default = 0000h).

The SPI Mode Register is used to put the device into SPI sleep mode.

D15	D14	D13	D12	D11	D10	D9	D8	D7	D6	D5	D4	D3	D2	D1	D0
SLEEP	X	X	X	X	X	X	X	X	X	X	X	X	X	X	X

SLEEP Set the SLEEP bit to '1' to put the device into SPI sleep mode.

When the SLEEP bit = '0', the SPI is in normal mode. The bit is cleared ('0') after a hardware reset (through the $\overline{\text{RST}}$ pin) or if the $\overline{\text{WAKEUP}}$ pin is low.

For normal SPI operation, the data entering the SDI pin is transferred into the Shift Register. However, for SPI sleep mode, the Shift Register is bypassed. The data entering into the SDI pin are directly transferred to the SDO pin instead of the Shift Register.

Broadcast Register.

The DAC8718 broadcast register can be used to update all eight DAC register channels simultaneously using data bits D15:D0. This write-only register uses address A4:A0 = 07h, and is only available when the SCE bit = '0' (default). If the SCE bit = '1', this register is ignored. Reading this register always returns 0000h.

Input Data Register for DAC-n, where n = 0 to 7 (default = 0000h).

This register stores the DAC data written to the device when the SCE bit = '1' and is controlled by the correction engine. When the SCE bit = '0' (default), the DAC Data Register stores the DAC data written to the device. When the data are loaded into the corresponding DAC latch, the DAC output changes to the new level defined by the DAC latch. The default value after power-on or reset is 0000h.

Table 13. DAC-n⁽¹⁾ Input Data Register

MSB															LSB
D15	D14	D13	D12	D11	D10	D9	D8	D7	D6	D5	D4	D3	D2	D1	D0
DB15 ⁽²⁾	DB14	DB13	DB12	DB11	DB10	DB9	DB8	DB7	DB6	DB5	DB4	DB3	DB2	DB1	DB0

(1) n = 0, 1, 2, 3, 4, 5, 6, or 7.

(2) DB15:DB0 are the DAC data bits.

Zero Register n, where n = 0 to 7 (default = 0000h).

The Zero Register stores the user-calibration data that are used to eliminate the offset error. The data are 16 bits wide, 1 LSB/step, and the total adjustment is –32768 LSB to +32767 LSB, or $\pm 50\%$ of full-scale range. The Zero Register uses a twos complement data format.

Table 14. Zero Register

D15	D14	D13	D12	D11	D10	D9	D8	D7	D6	D5	D4	D3	D2	D1	D0
Z15	Z14	Z13	Z12	Z11	Z10	Z9	Z8	Z7	Z6	Z5	Z4	Z3	Z2	Z1	Z0
Z15:Z0—OFFSET BITS								ZERO ADJUSTMENT							
7FFFh								+32767 LSB							
7FFEh								+32766 LSB							
...							
0001h								+1 LSB							
0000h								0 LSB (default)							
FFFFh								–1 LSB							
...							
8001h								–32767 LSB							
8000h								–32768 LSB							

Gain Register n, where n = 0 to 7 (default = 8000h).

The Gain Register stores the user-calibration data that are used to eliminate the gain error. The data are 16 bits wide, 0.0015% FSR/step, and the total adjustment range 0.5 to 1.5. The Gain Register uses a straight binary data format.

Table 15. Gain Register

D15	D14	D13	D12	D11	D10	D9	D8	D7	D6	D5	D4	D3	D2	D1	D0
G15	G14	G13	G12	G11	G10	G9	G8	G7	G6	G5	G4	G3	G2	G1	G0
G15:G0—GAIN-CODE BITS								GAIN ADJUSTMENT COEFFICIENT							
FFFFh								1.499985							
FFFEh								1.499969							
...							
8001h								1.000015							
8000h								1 (default)							
7FFFh								0.999985							
...							
0001h								0.500015							
0000h								0.5							

APPLICATION INFORMATION

BASIC OPERATION

The DAC8718 is a highly-integrated device with high-performance reference buffers and output buffers, greatly reducing the printed circuit board (PCB) area and production cost. On-chip reference buffers eliminate the need for a negative external reference. [Figure 101](#) shows a basic application for the DAC8718.

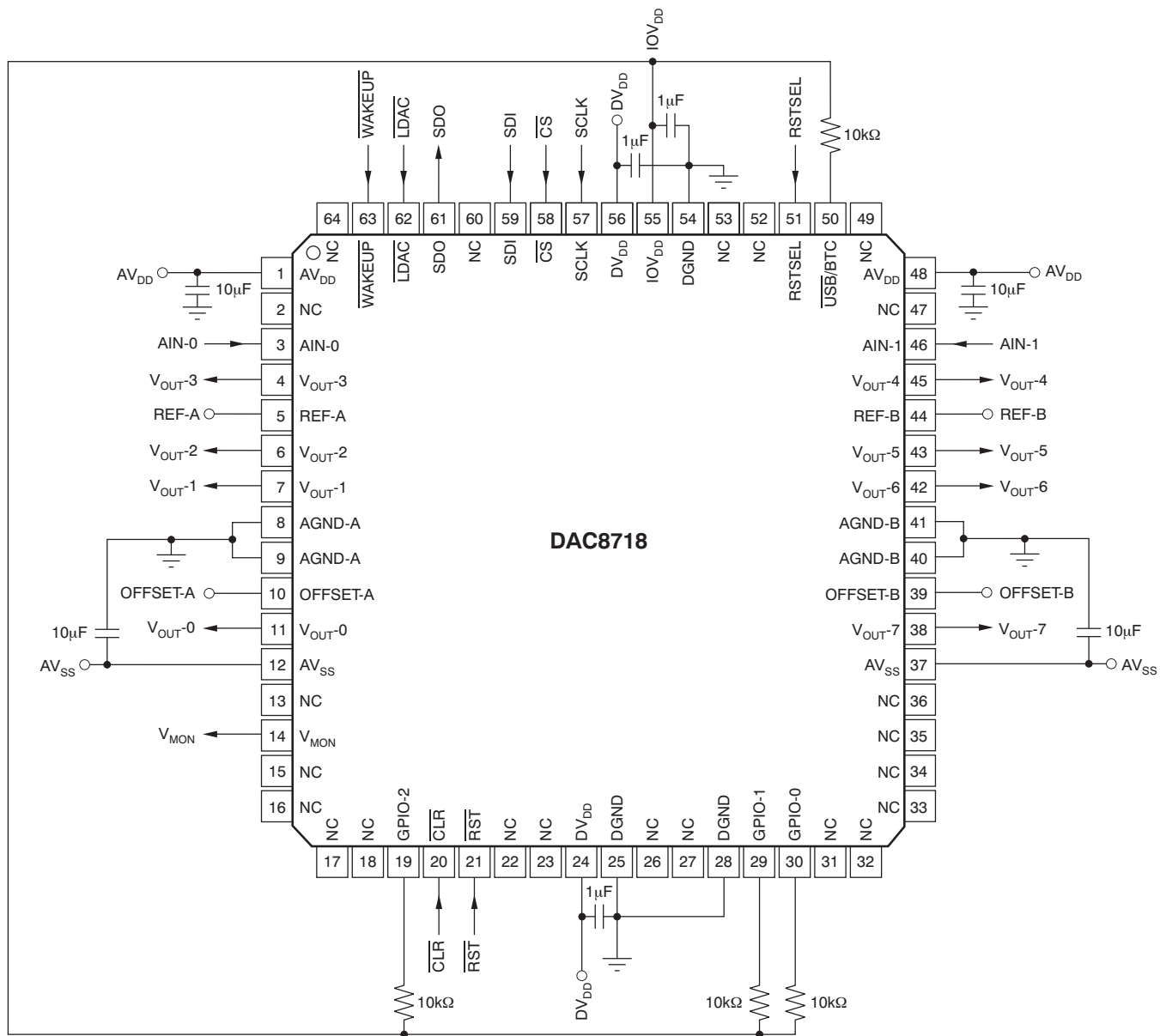

NOTES: AVDD = +15V, AVSS = -15V, DVDD = +5V, IOVDD = +1.8V to +5V, REF-A = +5V, and REF-B = +2.5V.
The OFFSET-A and OFFSET-B pins must be connected to the AGND pin when used in unipolar operation.

Figure 101. Basic Application Example

PRECISION VOLTAGE REFERENCE SELECTION

To achieve the optimum performance from the DAC8718 over the full operating temperature range, a precision voltage reference must be used. Careful consideration should be given to the selection of a precision voltage reference. The DAC8718 has two reference inputs, REF-A and REF-B. The voltages applied to the reference inputs are used to provide a buffered positive reference for the DAC cores. Therefore, any error in the voltage reference is reflected in the outputs of the device. There are four possible sources of error to consider when choosing a voltage reference for high-accuracy applications: initial accuracy, temperature coefficient of the output voltage, long-term drift, and output voltage noise. Initial accuracy error on the output voltage of an external reference can lead to a full-scale error in the DAC. Therefore, to minimize these errors, a reference with low initial accuracy error specification is preferred. Long-term drift is a measure of how much the reference output voltage drifts over time. A reference with a tight, long-term drift specification ensures that the overall solution remains relatively stable over its entire lifetime. The temperature coefficient of a reference output voltage affects the output drift when the temperature changes. Choose a reference with a tight temperature coefficient specification to reduce the dependence of the DAC output voltage on ambient conditions. In high-accuracy applications, which have a relatively low noise budget, the reference output voltage noise also must be considered. Choosing a reference with as low an output noise voltage as practical for the required system resolution is important. Precision voltage references such as TI's [REF50xx](#) (2V to 5V) and [REF32xx](#) (1.25V to 4V) provide a low-drift, high-accuracy reference voltage.

POWER-SUPPLY NOISE

The DAC8718 must have ample supply bypassing of 1 μ F to 10 μ F in parallel with 0.1 μ F on each supply, located as close to the package as possible; ideally, immediately next to the device. The 1 μ F to 10 μ F capacitors must be the tantalum-bead type. The 0.1 μ F capacitor must have low effective series resistance (ESR) and low effective series inductance (ESI), such as common ceramic types, which provide a low-impedance path to ground at high frequencies to handle transient currents because of internal logic switching. The power-supply lines must be as large a trace as possible to provide low-impedance paths and reduce the effects of glitches on the power-supply line. Apart from these considerations, the wideband noise on the AV_{DD}, AV_{SS}, DV_{DD} and IOV_{DD} supplies should be filtered before feeding to the DAC to obtain the best possible noise performance.

LAYOUT

Precision analog circuits require careful layout, adequate bypassing, and a clean, well-regulated power supply to obtain the best possible dc and ac performance. Careful consideration of the power-supply and ground-return layout helps to meet the rated performance. DGND is the return path for digital currents and AGND is the power ground for the DAC. For the best ac performance, care should be taken to connect DGND and AGND with very low resistance back to the supply ground. The PCB must be designed so that the analog and digital sections are separated and confined to certain areas of the board. If multiple devices require an AGND-to-DGND connection, the connection is to be made at one point only. The star ground point is established as close as possible to the device.

The power-supply traces must be as large as possible to provide low impedance paths and reduce the effects of glitches on the power-supply line. Fast switching signals must never be run near the reference inputs. It is essential to minimize noise on the reference inputs because it couples through to the DAC output. Avoid crossover of digital and analog signals. Traces on opposite sides of the board must run at right angles to each other. This configuration reduces the effects of feedthrough on the board. A microstrip technique may be considered, but is not always possible with a double-sided board. In this technique, the component side of the board is dedicated to the ground plane, and signal traces are placed on the solder-side.

Each DAC group has a ground pin, AGND-x, which is the ground of the output from the DACs in the group. It must be connected directly to the corresponding reference ground in low-impedance paths to get the best performance. AGND-A must be connected with REFGND-A and AGND-B must be connected with REFGND-B. AGND-A and AGND-B must be tied together and connected to the analog power ground and DGND.

During single-supply operation, the OFFSET-x pins must be connected to AGND-x with a low-impedance path because these pins carry DAC-code-dependent current. Any resistance from OFFSET-x to AGND-x causes a voltage drop by this code-dependent current. Therefore, it is very important to minimize routing resistance to AGND-x or to any ground plane that AGND-x is connected to.

PACKAGING INFORMATION

Orderable Device	Status (1)	Package Type	Package Drawing	Pins	Package Qty	Eco Plan (2)	Lead finish/ Ball material (6)	MSL Peak Temp (3)	Op Temp (°C)	Device Marking (4/5)	Samples
DAC8718SPAG	ACTIVE	TQFP	PAG	64	160	RoHS & Green	NIPDAU	Level-4-260C-72 HR	-40 to 105	DAC8718S	Samples
DAC8718SPAGR	ACTIVE	TQFP	PAG	64	1500	RoHS & Green	NIPDAU	Level-4-260C-72 HR	-40 to 105	DAC8718S	Samples
DAC8718SRGZR	ACTIVE	VQFN	RGZ	48	2500	RoHS & Green	NIPDAU	Level-3-260C-168 HR	-40 to 105	DAC8718S	Samples
DAC8718SRGZT	ACTIVE	VQFN	RGZ	48	250	RoHS & Green	NIPDAU	Level-3-260C-168 HR	-40 to 105	DAC8718S	Samples

(1) The marketing status values are defined as follows:

ACTIVE: Product device recommended for new designs.

LIFEBUY: TI has announced that the device will be discontinued, and a lifetime-buy period is in effect.

NRND: Not recommended for new designs. Device is in production to support existing customers, but TI does not recommend using this part in a new design.

PREVIEW: Device has been announced but is not in production. Samples may or may not be available.

OBSELETE: TI has discontinued the production of the device.

(2) **RoHS:** TI defines "RoHS" to mean semiconductor products that are compliant with the current EU RoHS requirements for all 10 RoHS substances, including the requirement that RoHS substance do not exceed 0.1% by weight in homogeneous materials. Where designed to be soldered at high temperatures, "RoHS" products are suitable for use in specified lead-free processes. TI may reference these types of products as "Pb-Free".

RoHS Exempt: TI defines "RoHS Exempt" to mean products that contain lead but are compliant with EU RoHS pursuant to a specific EU RoHS exemption.

Green: TI defines "Green" to mean the content of Chlorine (Cl) and Bromine (Br) based flame retardants meet JS709B low halogen requirements of <=1000ppm threshold. Antimony trioxide based flame retardants must also meet the <=1000ppm threshold requirement.

(3) MSL, Peak Temp. - The Moisture Sensitivity Level rating according to the JEDEC industry standard classifications, and peak solder temperature.

(4) There may be additional marking, which relates to the logo, the lot trace code information, or the environmental category on the device.

(5) Multiple Device Markings will be inside parentheses. Only one Device Marking contained in parentheses and separated by a "-" will appear on a device. If a line is indented then it is a continuation of the previous line and the two combined represent the entire Device Marking for that device.

(6) Lead finish/Ball material - Orderable Devices may have multiple material finish options. Finish options are separated by a vertical ruled line. Lead finish/Ball material values may wrap to two lines if the finish value exceeds the maximum column width.

Important Information and Disclaimer:The information provided on this page represents TI's knowledge and belief as of the date that it is provided. TI bases its knowledge and belief on information provided by third parties, and makes no representation or warranty as to the accuracy of such information. Efforts are underway to better integrate information from third parties. TI has taken and

continues to take reasonable steps to provide representative and accurate information but may not have conducted destructive testing or chemical analysis on incoming materials and chemicals. TI and TI suppliers consider certain information to be proprietary, and thus CAS numbers and other limited information may not be available for release.

In no event shall TI's liability arising out of such information exceed the total purchase price of the TI part(s) at issue in this document sold by TI to Customer on an annual basis.

TAPE AND REEL INFORMATION

QUADRANT ASSIGNMENTS FOR PIN 1 ORIENTATION IN TAPE

*All dimensions are nominal

Device	Package Type	Package Drawing	Pins	SPQ	Reel Diameter (mm)	Reel Width W1 (mm)	A0 (mm)	B0 (mm)	K0 (mm)	P1 (mm)	W (mm)	Pin1 Quadrant
DAC8718SPAGR	TQFP	PAG	64	1500	330.0	24.4	13.0	13.0	1.5	16.0	24.0	Q2
DAC8718SRGZR	VQFN	RGZ	48	2500	330.0	16.4	7.3	7.3	1.5	12.0	16.0	Q2

TAPE AND REEL BOX DIMENSIONS

*All dimensions are nominal

Device	Package Type	Package Drawing	Pins	SPQ	Length (mm)	Width (mm)	Height (mm)
DAC8718SPAGR	TQFP	PAG	64	1500	350.0	350.0	43.0
DAC8718SRGZR	VQFN	RGZ	48	2500	350.0	350.0	43.0

TRAY

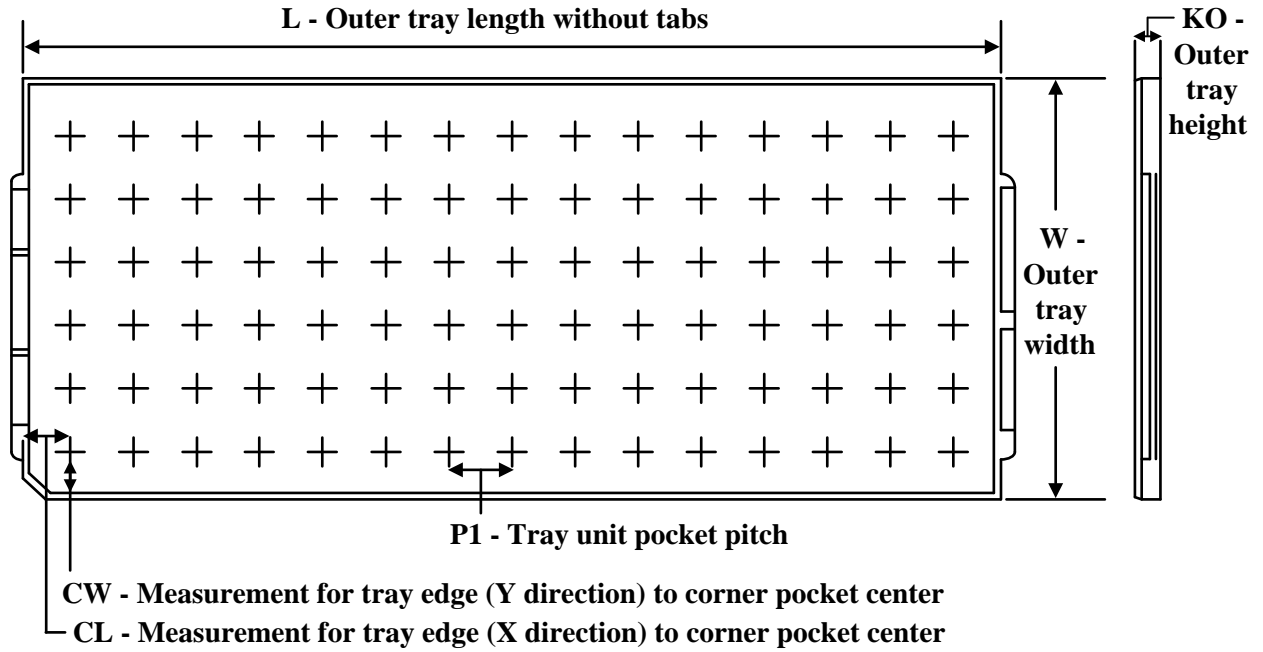

Chamfer on Tray corner indicates Pin 1 orientation of packed units.

*All dimensions are nominal

Device	Package Name	Package Type	Pins	SPQ	Unit array matrix	Max temperature (°C)	L (mm)	W (mm)	K0 (µm)	P1 (mm)	CL (mm)	CW (mm)
DAC8718SPAG	PAG	TQFP	64	160	8 x 20	150	315	135.9	7620	15.2	13.1	13

PAG (S-PQFP-G64)

PLASTIC QUAD FLATPACK



- NOTES: A. All linear dimensions are in millimeters.
 B. This drawing is subject to change without notice.
 C. Falls within JEDEC MS-026

PAG (S-PQFP-G64)

PLASTIC QUAD FLATPACK



- NOTES:
- A. All linear dimensions are in millimeters.
 - B. This drawing is subject to change without notice.
 - C. Laser cutting apertures with trapezoidal walls and also rounding corners will offer better paste release. Customers should contact their board assembly site for stencil design recommendations. Example stencil design based on a 50% volumetric metal load solder paste. Refer to IPC-7525 for other stencil recommendations.
 - D. Customers should contact their board fabrication site for solder mask tolerances between and around signal pads.

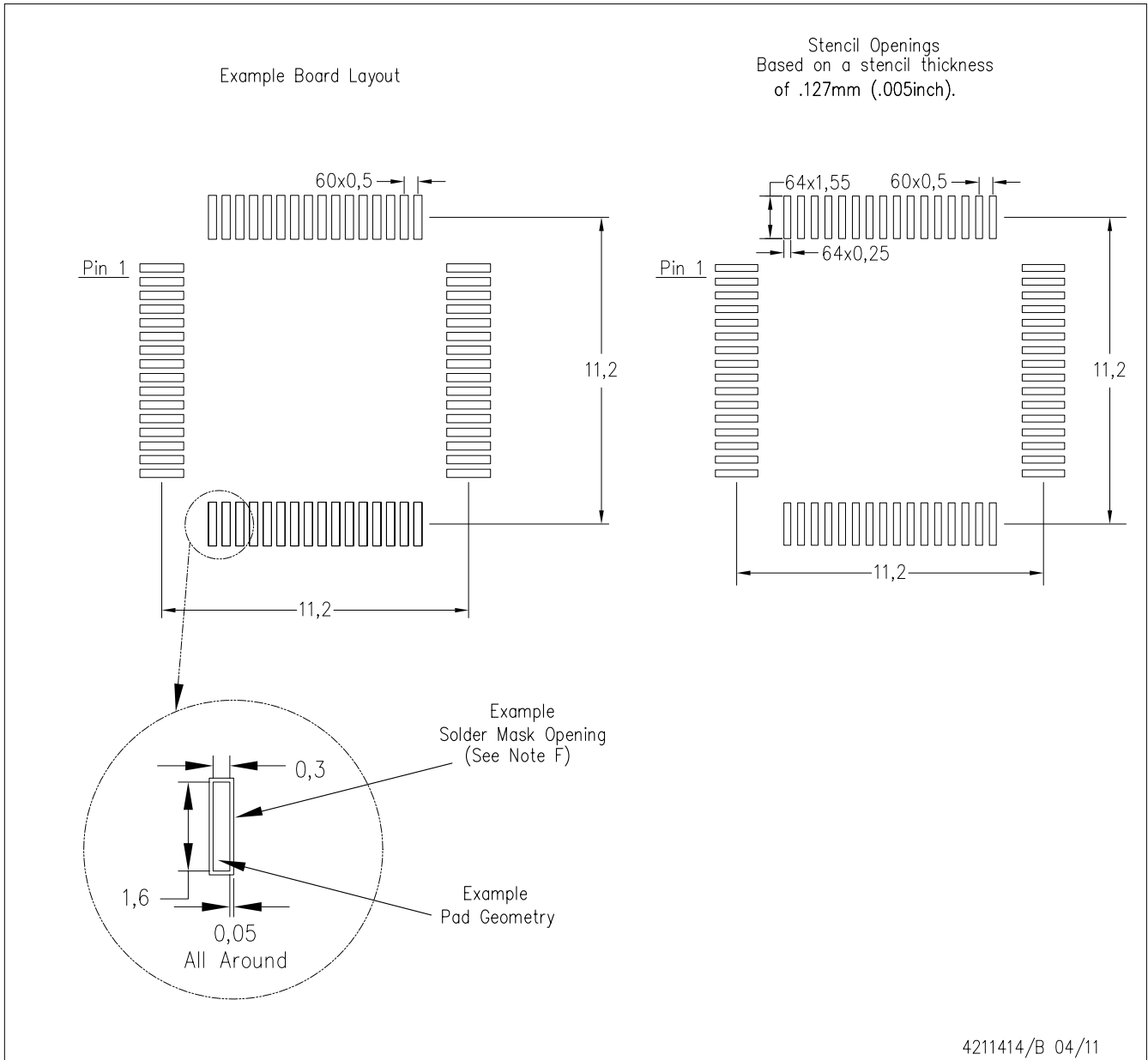

- NOTES:
- A. All linear dimensions are in millimeters.
 - B. This drawing is subject to change without notice.
 - C. Laser cutting apertures with trapezoidal walls and also rounding corners will offer better paste release. Customers should contact their board assembly site for stencil design recommendations. Example stencil design based on a 50% volumetric metal load solder paste. Refer to IPC-7525 for other stencil recommendations.
 - D. Customers should contact their board fabrication site for solder mask tolerances between and around signal pads.

GENERIC PACKAGE VIEW

RGZ 48

VQFN - 1 mm max height

7 x 7, 0.5 mm pitch

PLASTIC QUADFLAT PACK- NO LEAD

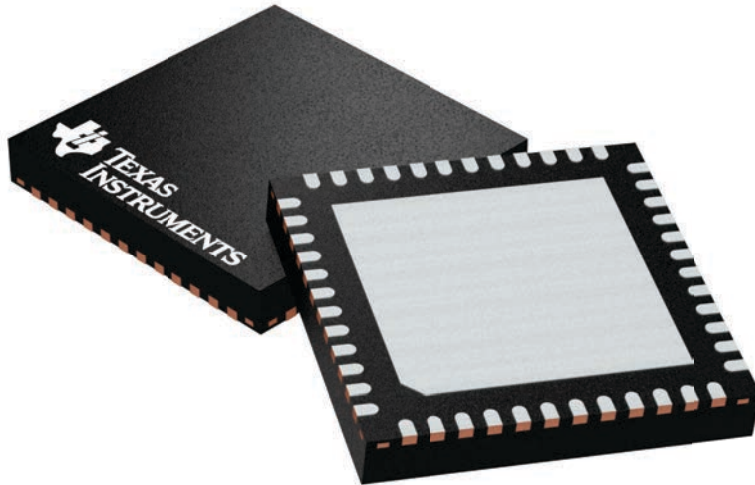

Images above are just a representation of the package family, actual package may vary.
Refer to the product data sheet for package details.

4224671/A

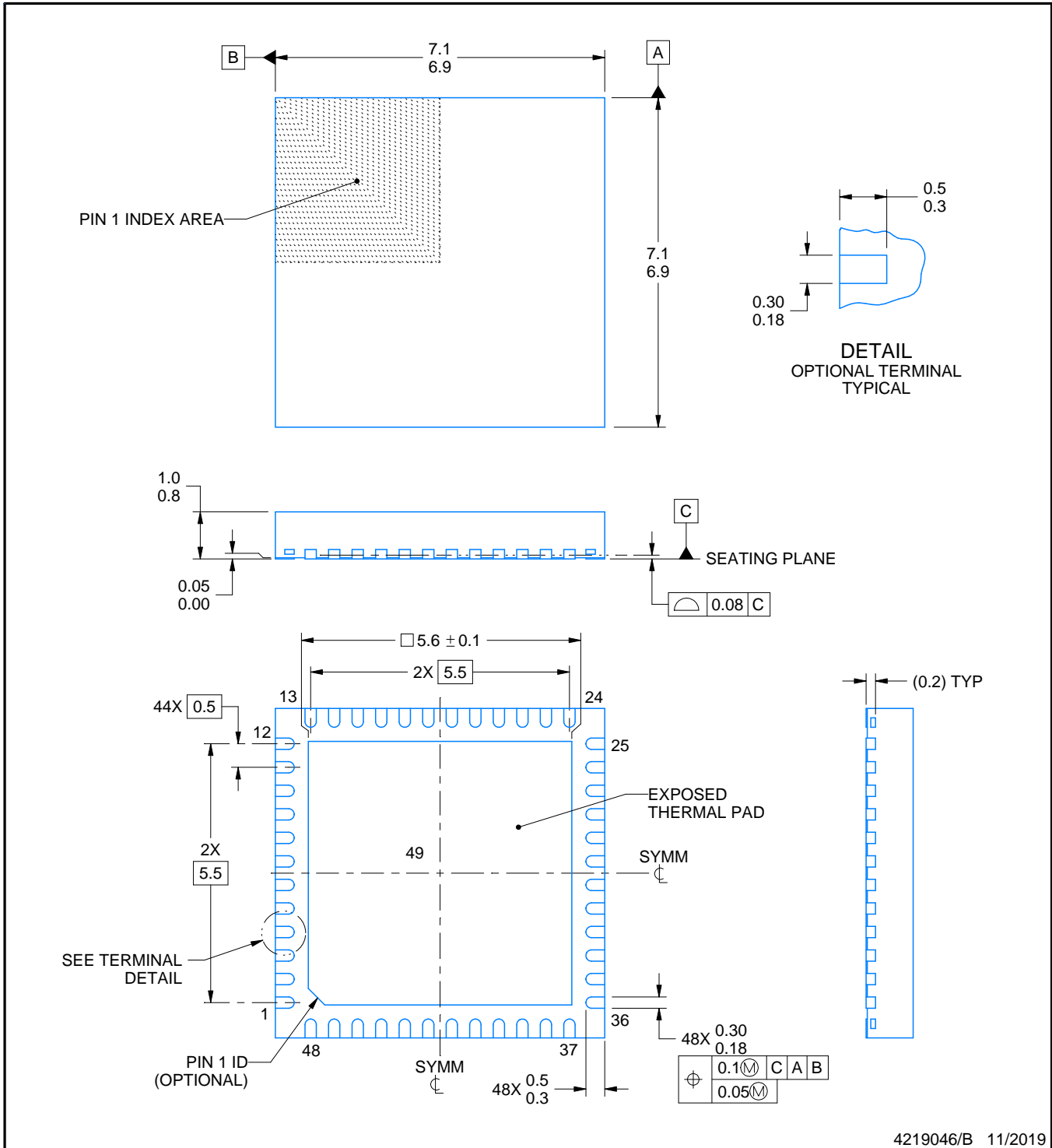
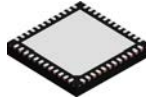

4219046/B 11/2019

NOTES:

1. All linear dimensions are in millimeters. Any dimensions in parenthesis are for reference only. Dimensioning and tolerancing per ASME Y14.5M.
2. This drawing is subject to change without notice.
3. The package thermal pad must be soldered to the printed circuit board for thermal and mechanical performance.

EXAMPLE BOARD LAYOUT

RGZ0048D

VQFN - 1 mm max height

PLASTIC QUAD FLATPACK - NO LEAD

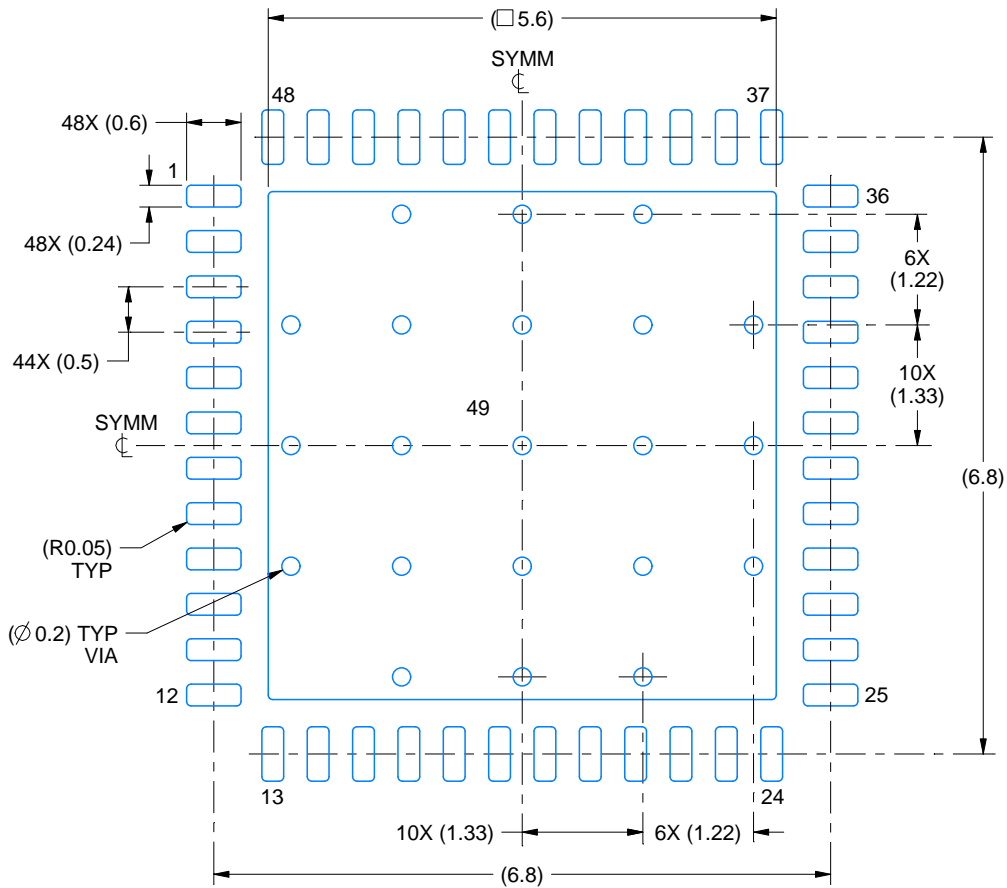

LAND PATTERN EXAMPLE
EXPOSED METAL SHOWN
SCALE:12X

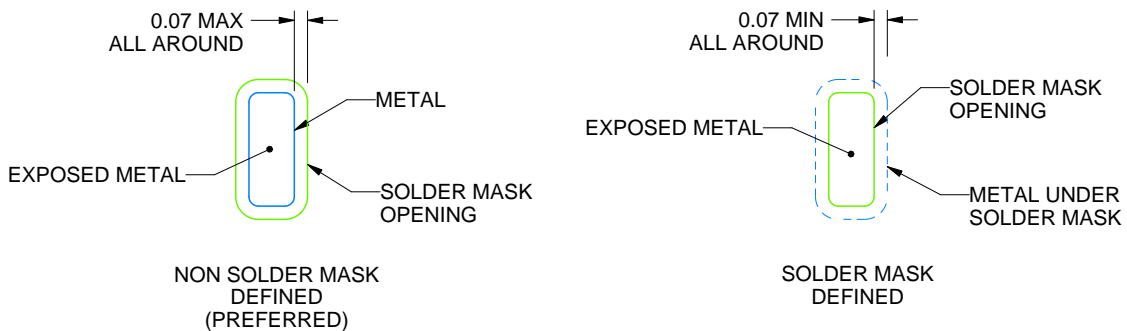

SOLDER MASK DETAILS

4219046/B 11/2019

NOTES: (continued)

4. This package is designed to be soldered to a thermal pad on the board. For more information, see Texas Instruments literature number SLUA271 (www.ti.com/lit/sluea271).
5. Vias are optional depending on application, refer to device data sheet. If any vias are implemented, refer to their locations shown on this view. It is recommended that vias under paste be filled, plugged or tented.

EXAMPLE STENCIL DESIGN

RGZ0048D

VQFN - 1 mm max height

PLASTIC QUAD FLATPACK - NO LEAD

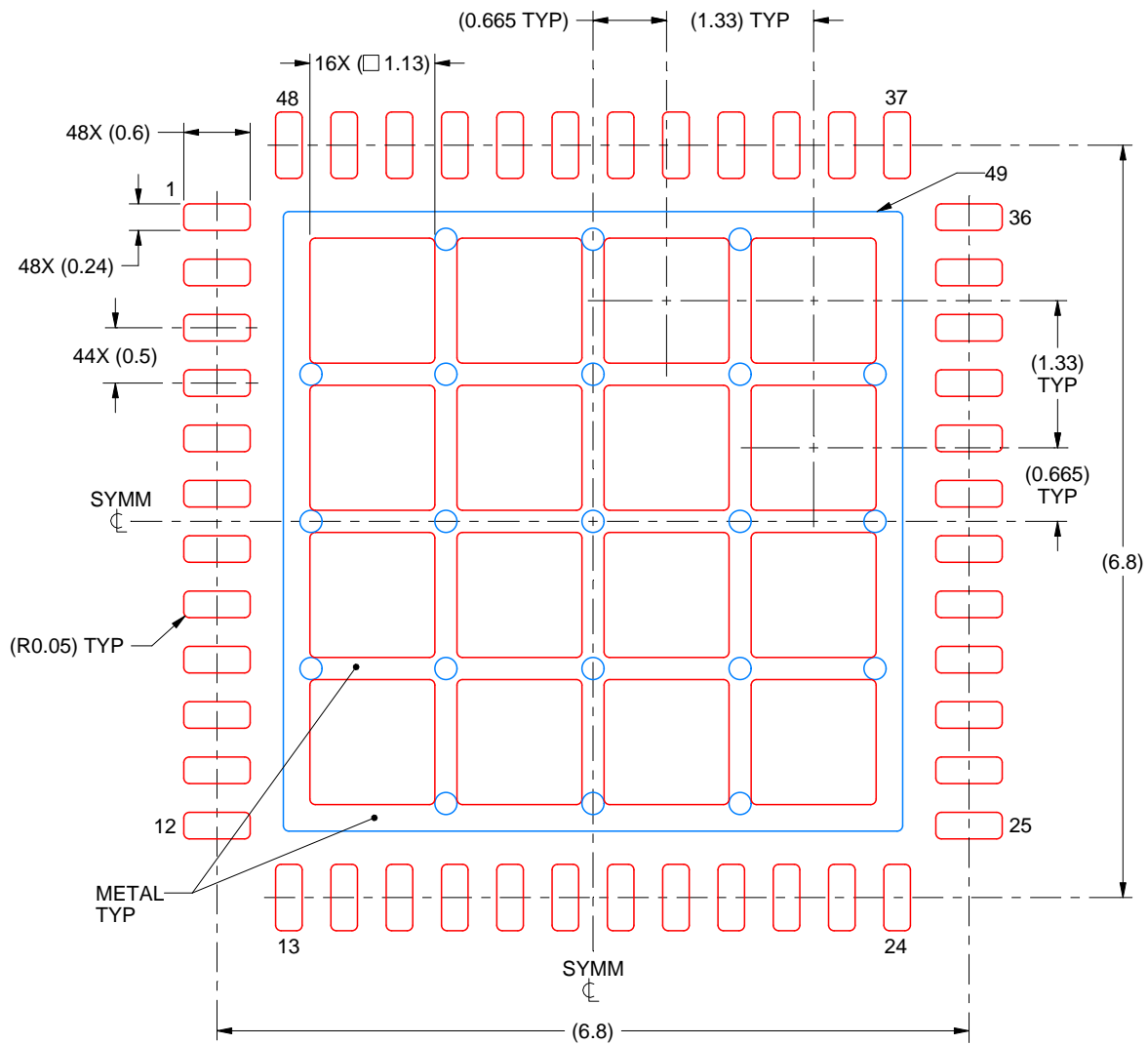

SOLDER PASTE EXAMPLE
BASED ON 0.125 mm THICK STENCIL

EXPOSED PAD 49
66% PRINTED SOLDER COVERAGE BY AREA UNDER PACKAGE
SCALE:15X

4219046/B 11/2019

NOTES: (continued)

6. Laser cutting apertures with trapezoidal walls and rounded corners may offer better paste release. IPC-7525 may have alternate design recommendations.

IMPORTANT NOTICE AND DISCLAIMER

TI PROVIDES TECHNICAL AND RELIABILITY DATA (INCLUDING DATA SHEETS), DESIGN RESOURCES (INCLUDING REFERENCE DESIGNS), APPLICATION OR OTHER DESIGN ADVICE, WEB TOOLS, SAFETY INFORMATION, AND OTHER RESOURCES "AS IS" AND WITH ALL FAULTS, AND DISCLAIMS ALL WARRANTIES, EXPRESS AND IMPLIED, INCLUDING WITHOUT LIMITATION ANY IMPLIED WARRANTIES OF MERCHANTABILITY, FITNESS FOR A PARTICULAR PURPOSE OR NON-INFRINGEMENT OF THIRD PARTY INTELLECTUAL PROPERTY RIGHTS.

These resources are intended for skilled developers designing with TI products. You are solely responsible for (1) selecting the appropriate TI products for your application, (2) designing, validating and testing your application, and (3) ensuring your application meets applicable standards, and any other safety, security, regulatory or other requirements.

These resources are subject to change without notice. TI grants you permission to use these resources only for development of an application that uses the TI products described in the resource. Other reproduction and display of these resources is prohibited. No license is granted to any other TI intellectual property right or to any third party intellectual property right. TI disclaims responsibility for, and you will fully indemnify TI and its representatives against, any claims, damages, costs, losses, and liabilities arising out of your use of these resources.

TI's products are provided subject to [TI's Terms of Sale](#) or other applicable terms available either on [ti.com](https://www.ti.com) or provided in conjunction with such TI products. TI's provision of these resources does not expand or otherwise alter TI's applicable warranties or warranty disclaimers for TI products.

TI objects to and rejects any additional or different terms you may have proposed.

Mailing Address: Texas Instruments, Post Office Box 655303, Dallas, Texas 75265
Copyright © 2023, Texas Instruments Incorporated