



## ABSTRACT

This report covers the radiation characterization results of the SN54SC8T595-SEP, radiation tolerant 8-bit shift registers with 3-state output and logic level shifter. The study was done to determine Total Ionizing Dose (TID) effects under high dose rate (HDR) up to 50krad(Si) as a one time characterization. The results show that all samples passed within the specified limits up to 30krad(Si) (with 72 hour room temperature anneal). Radiation Lot Acceptance Testing (RLAT) is performed using 5 units at a dose level of 30krad(Si) for future wafer lots per MIL-STD-883 TM 1019. All future wafer lots are tested under the same conditions.

The SN54SC8T595-SEP is packaged in a space enhanced plastic package for low outgassing characteristics and is Single Event Latch-Up (SEL) immune up to 50MeV-cm<sup>2</sup>/mg, which makes the device an option for low Earth orbit space applications. Single Event Transient (SET) data is also provided in the Single Event Effects Radiation Report.

The SN54SC8T595-SEP Total Ionizing Dose (TID) Report covers the TID performance of all devices listed below. The SN54SC8T595-SEP device covers all functional blocks and active die area of the other devices, which is why the device was selected for single-event effect testing for this group of devices.

- **SN54SC8T595-SEP**
- SN54SC8T164-SEP
- SN54SC8T374-SEP
- SN54SC8T574-SEP

## Table of Contents

<b>1 Device Information</b> .....	2
1.1 Device Details.....	2
<b>2 Total Dose Test Setup</b> .....	3
2.1 Test Overview.....	3
2.2 Test Description and Facilities.....	3
2.3 Test Setup Details.....	3
2.4 Test Configuration and Condition.....	4
<b>3 TID Characterization Test Results</b> .....	5
3.1 TID Characterization Summary Results.....	5
3.2 Specification Compliance Matrix.....	6
<b>4 Reference Documents</b> .....	7
<b>5 Appendix: HDR TID Report Data</b> .....	7

## List of Figures

Figure 2-1. SN54SC8T595-SEP Bias Diagram.....	3
---	---

## List of Tables

Table 1-1. Device and Exposure Details.....	2
Table 2-1. HDR Device Information.....	4
Table 3-1. Electrical Parameters Table.....	6

## Trademarks

All trademarks are the property of their respective owners.

## 1 Device Information

The SN54SC8T595-SEP contains an 8-bit, serial-in, parallel-out shift register that feeds an 8-bit D-type storage register. The storage register has parallel 3-state outputs. Separate clocks are provided for both the shift and storage register. The shift register has a direct overriding clear (SRCLR) input, serial (SER) input, and a serial output (QH') for cascading. When the output-enable (OE) input is high, the outputs are in a high-impedance state. Internal register data is not impacted by the operation of the OE input. The output level is referenced to the supply voltage (VCC) and supports 1.8V, 2.5V, 3.3V, and 5V CMOS levels.

The input is designed with a lower threshold circuit to support up translation for lower voltage CMOS inputs (for example, 1.2V input to 1.8V output or 1.8V input to 3.3V output). In addition, the 5V tolerant input pins enable down translation (for example, 3.3V to 2.5V output). The SN54SC8T595-SEP is a pure CMOS device and therefore was tested at a High Dose Rate (HDR) for TID testing.

### 1.1 Device Details

[Table 1-1](#) lists the device information used for TID HDR characterization and qualification.

**Table 1-1. Device and Exposure Details**

TID HDR Details: Up To 50krad(Si)	
TI Device Number	SN54SC8T595-SEP
Package	16-pin PW (TSSOP)
Technology	LBC9
Die Lot Number	3272257RFB
A/T Lot Number and Date Code	4085562ML4 / 41C5Q8K
Quantity Tested	21 irradiated devices + 4 control
Lot Accept or Reject	Devices passed 30krad(Si)
HDR Radiation Facility	Texas Instruments CLAB in Dallas, Texas
HDR Dose Level	10krad(Si), 20krad(Si), 30krad(Si), 50krad(Si)
HDR Dose Rate	184.95rad(Si)/s ionizing radiation
Effective Dose Rate 30krad(Si) with 72 hour Anneal	115.74mrad(Si)/s ionizing radiation
HDR Radiation Source	Gammacell 220 Excel (GC-220E) Co-60
Irradiation Temperature	Ambient, room temperature

## 2 Total Dose Test Setup

### 2.1 Test Overview

The SN54SC8T595-SEP samples were irradiated at a high dose rate of 184.95rad(Si)/s up to 50krad(Si) (115.74mrad(Si)/s effective does rate for 30krad(Si) with 72 hour anneal) and then put through full electrical parametric testing on the production Automated Test Equipment (ATE). The samples were functional and passed all electrical parametric tests with readings within data sheet electrical specification limits.

### 2.2 Test Description and Facilities

The SN54SC8T595-SEP HDR exposure was performed on biased devices in a Co-60 gamma cell at TI facility in Dallas, Texas. The un-attenuated dose rate of this cell is 184.95rads(Si)/s (115.74mrad(Si)/s effective does rate of 30krad(Si) with 72 hour anneal). After exposure, the devices were packed in dry ice (per MIL-STD-883 Method 1019.9 section 3.10) and full post radiation electrical evaluation using Texas Instruments ATE was conducted. ATE test limits are set per data sheet electrical limits based on qualification and characterization data. Post radiation measurements were taken within 30 minutes of removing the devices from the dry ice container. The devices were allowed to reach room temperature prior to electrical post radiation measurements.

### 2.3 Test Setup Details

The devices were tested in biased conditions as described in the following sections.

#### 2.3.1 Bias Diagram

Figure 2-1 shows the bias conditions for each pin during irradiation.

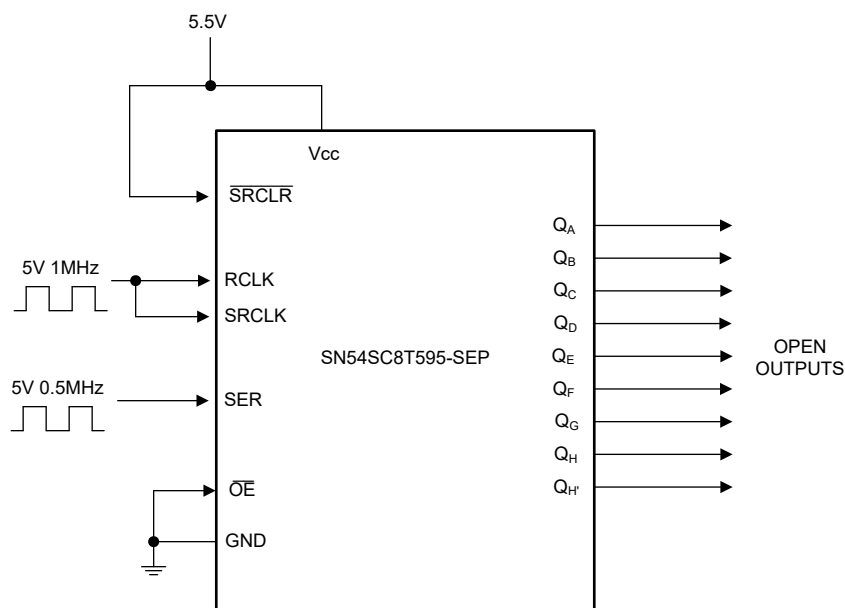

Figure 2-1. SN54SC8T595-SEP Bias Diagram

## 2.4 Test Configuration and Condition

A step stress (10k, 20k, 30k and 50k) test method was used to determine the TID hardness level. That is, after a predetermined TID level was reached, an electrical test was performed on a given sample of parts to verify that the units are within specified data sheet electrical test limits. The HDR RLAT units were irradiated to 30krad(Si), parametrically tested on ATE, and then were annealed at 25°C for 72 hours. The units that were irradiated to 30krad(Si) and were annealed for 72 hours are denoted as 31krad(Si) in [Section 5](#). ATE parametric testing was completed before and after the anneal.

[Table 2-1](#) lists the serialized samples used for TID characterization.

**Table 2-1. HDR Device Information**

Control Group	HDR Dose Rate = 184.95rad(Si)/s Effective Dose Rate (30krad + Anneal 72 hours) = 115.74mrad(Si)/s				
	Total Samples: 21 Biased				
Total Samples: 4	Exposure Levels				
0krad (Si)	10krad (Si)	20krad(Si)	30krad(Si)		50krad (Si)
Biased	Biased	Biased	Biased	Biased + 72 hour anneal	Biased
1 - 4	5 - 9	10 - 14	15 - 20	15a - 20a	21 - 25

## 3 TID Characterization Test Results

### 3.1 TID Characterization Summary Results

The parametric data for the SN54SC8T595-SEP passes up to 30krad(Si) (with 72 hour room temperature anneal) HDR TID irradiation. The drifts of the electrical parameters through HDR were within the data sheet limits.

Overall, the SN54SC8T595-SEP showed a strong degree of hardness to HDR TID irradiation up to 30krad(Si). The measurements taken post-irradiation for each sample set showed a marginal shift for most parameters at each dose level. The parameters that did show a greater degree of change between pre- and post-irradiation were still within the electrical performance characteristics specified in the data sheet electrical parameters. For the data sheet electrical parameters and associated tests, see [SN54SC8T595-SEP Radiation-Tolerant, 8-Bit Shift Registers With 3-State Output And Logic Level Shifter](#).

See [Section 5](#) for HDR report up to 50 krad(Si).

### 3.2 Specification Compliance Matrix

**Table 3-1. Electrical Parameters Table**

Parameter	Test Conditions	V <sub>CC</sub>	T <sub>A</sub> = -55°C to +125°C			Unit	Test Name
			MIN	TYP	MAX		
V <sub>T+</sub> 1	Positive-going input threshold voltage	1.2V to 1.3V	0.31	0.655	1.1	V	VTP_1P2V
		1.65V to 2V	0.39	0.915	1.32		VTP_1P65V
		2.25V to 2.75V	0.51	1.09	1.51		VTP_2P25V
		3V to 3.6V	0.65	1.2	1.7		VTP_3V
		4.5V to 5.5V	0.87	1.51	2.16		VTP_4P5V, VTP_5P5V
V <sub>T-</sub> 1	Negative-going input threshold voltage	1.2V to 1.3V	0.11	0.349	0.60	V	VTN_1P2V
		1.65V to 2V	0.18	0.455	0.63		VTN_1P65V
		2.25V to 2.75V	0.25	0.545	0.74		VTN_2P25V
		3V to 3.6V	0.33	0.635	0.85		VTN_3V
		4.5V to 5.5V	0.45	0.755	1.14		VTN_4P5V, VTN_5P5V
ΔV <sub>T</sub> 1	Hysteresis (V <sub>T+</sub> - V <sub>T-</sub> )	1.2V to 1.3V	0.2	0.29	0.77	V	DELTAVT_1P2V
		1.65V to 2V	0.21	0.43	0.88		DELTAVT_1P65V
		2.25V to 2.75V	0.25	0.54	0.91		DELTAVT_2P25V
		3V to 3.6V	0.31	0.63	0.91		DELTAVT_3V
		4.5V to 5.5V	0.43	0.75	1.05		DELTAVT_4P5V, DELTAVT_5P5V
V <sub>IH</sub>	High-level input voltage	1.2V to 1.3V	0.78			V	VIH_1P2V
		1.65V to 2V	1.1				VIH_1P65V
		2.25V to 2.75V	1.28				VIH_2P25V
		3V to 3.6V	1.45				VIH_3V
		4.5V to 5.5V	2				VIH_4P5V, VIH_5P5V
V <sub>IL</sub>	Low-Level input voltage	1.2V to 1.3V			0.18	V	VIL_1P2V
		1.65V to 2V			0.5		VIL_1P65V
		2.25V to 2.75V			0.65		VIL_2P25V
		3V to 3.6V			0.75		VIL_3V
		4.5V to 5.5V			0.85		VIL_4P5V, VIL_5P5V
V <sub>OH</sub> 2	I <sub>OH</sub> = -50μA	1.2V to 5.5V	V <sub>CC</sub> -0.2			V	VOH_N50UA_1P2V, VOH_N50UA_5P5V
	I <sub>OH</sub> = -1mA	1.2V	0.8				VOH_N1MA_1P2V
	I <sub>OH</sub> = -2mA	1.65V to 2V	1.21				VOH_N2MA_1P65V
	I <sub>OH</sub> = -3mA	2.25V to 2.75V	1.93				VOH_N3MA_2P25V
	I <sub>OH</sub> = -5.5mA	3V to 3.6V	2.49				VOH_N5P5MA_3V
	I <sub>OH</sub> = -8mA	4.5V to 5.5V	3.95				VOH_N8MA_4P5V
	I <sub>OH</sub> = -24mA	4.5V to 5.5V	3.15				VOH_N24MA_5P5V
V <sub>OL</sub>	I <sub>OL</sub> = 50μA	1.2V to 5.5V			0.1	V	VOL_50UA_1P2V, VOL_50UA_5P5V
	I <sub>OL</sub> = 1mA	1.2V			0.2		VOL_1MA_1P2V
	I <sub>OL</sub> = 2mA	1.65V to 2V			0.25		VOL_2MA_1P65V
	I <sub>OL</sub> = 3mA	2.25V to 2.75V			0.2		VOL_3MA_2P25V
	I <sub>OL</sub> = 5.5mA	3V to 3.6V			0.25		VOL_5P5MA_3V
	I <sub>OL</sub> = 8mA	4.5V to 5.5V			0.35		VOL_8MA_4P5V
	I <sub>OL</sub> = 24mA	4.5V to 5.5V			0.75		VOL_24MA_5P5V
I <sub>CC</sub>	V <sub>I</sub> = V <sub>CC</sub> or GND, I <sub>O</sub> = 0	1.2V to 5.5V		2	220	μA	ICC_5P5V
ΔI <sub>CC</sub>	One input at 0.3V or 3.4V, other inputs at V <sub>CC</sub> or GND	5.5V			1.5	mA	DELTAICC_5P5V
	One input at 0.3V or 1.1V, other inputs at V <sub>CC</sub> or GND	1.8V			68	μA	DELTAICC_1P8V
I <sub>OZ</sub> 3	V <sub>O</sub> = V <sub>CC</sub> or GND	5.5V			±26	μA	IOZ_5P5V
I <sub>I</sub>	V <sub>I</sub> = 0V to V <sub>CC</sub>	V <sub>I</sub> = 0V to V <sub>CC</sub>			±1	μA	II_5P5V

- Schmitt-trigger input devices only.
- Push-pull output devices only.
- 3-State output devices only.

## 4 Reference Documents

Texas Instruments total ionizing dose radiation (total dose) test procedure follows the standards put forth in MIL-STD-883 TM 1019. The document can be found at the DLA website.

## 5 Appendix: HDR TID Report Data

This appendix provides the SN54SC8T595-SEP TID HDR report. The report shows the variation for each parameter up to 50krad(Si).

# TID Report SN54SC8T595-SEP

		DELTAICC_1P8V					
		Units		μA			
		Max Limit		68			
		Min Limit		-1			
krad	Serial #	PreTestHDR	PostTestHDR	Delta	Delta %	% of Limit Range	
0	1	3.412	3.349	-0.06	-1.85%	0.09%	
0	2	3.098	3.036	-0.06	-2.00%	0.09%	
0	3	3.286	2.973	-0.31	-9.53%	0.45%	
0	4	3.099	3.161	0.06	2.00%	0.09%	
10	5	3.036	2.848	-0.19	-6.19%	0.27%	
10	6	3.380	3.130	-0.25	-7.40%	0.36%	
10	7	3.130	2.973	-0.16	-5.02%	0.23%	
10	8	3.192	3.224	0.03	1.00%	0.05%	
10	9	3.005	2.848	-0.16	-5.22%	0.23%	
20	10	3.036	3.099	0.06	2.08%	0.09%	
20	11	3.192	2.817	-0.38	-11.75%	0.54%	
20	12	3.161	2.942	-0.22	-6.93%	0.32%	
20	13	2.879	3.286	0.41	14.14%	0.59%	
20	14	3.224	3.067	-0.16	-4.87%	0.23%	
30	15	3.036	3.192	0.16	5.14%	0.23%	
30	16	3.286	3.161	-0.13	-3.80%	0.18%	
30	17	3.192	3.192	0.00	0.00%	0.00%	
30	18	3.443	3.161	-0.28	-8.19%	0.41%	
30	19	3.161	3.004	-0.16	-4.97%	0.23%	
30	20	2.942	2.848	-0.09	-3.20%	0.14%	
31	15a	3.036	2.973	-0.06	-2.08%	0.09%	
31	16a	3.286	3.005	-0.28	-8.55%	0.41%	
31	17a	3.192	3.099	-0.09	-2.91%	0.13%	
31	18a	3.443	2.879	-0.56	-16.38%	0.82%	
31	19a	3.161	3.098	-0.06	-1.99%	0.09%	
31	20a	2.942	3.067	0.13	4.25%	0.18%	
50	21	3.098	3.725	0.63	20.24%	0.91%	
50	22	3.161	3.255	0.09	2.97%	0.14%	
50	23	3.036	3.631	0.60	19.60%	0.86%	
50	24	3.412	3.599	0.19	5.48%	0.27%	
50	25	3.036	3.943	0.91	29.87%	1.31%	
Max		3.443	3.725	0.28	20.24%	0.91%	
Average		3.165	3.121	-0.04	-1.20%	0.29%	
Min		2.879	2.817	-0.06	-16.38%	0.00%	
Std Dev		0.153	0.227	0.07	8.24%	0.24%	

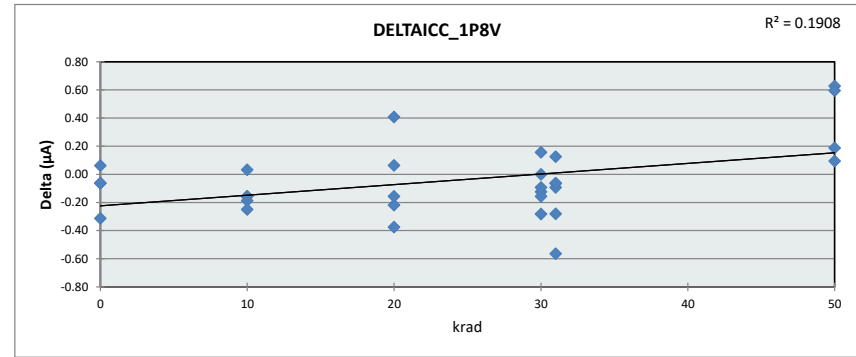

		DELTAICC_1P8V					
		Units		μA			
		Max Limit		68			
		Min Limit		-1			
krad		0	10	20	30	31	50
LL		-1.000	-1.000	-1.000	-1.000	-1.000	-1.000
Min		2.973	2.848	2.817	2.848	2.879	3.255
Average		3.130	3.005	3.042	3.093	3.020	3.631
Max		3.349	3.224	3.286	3.192	3.099	3.943
UL		68.000	68.000	68.000	68.000	68.000	68.000

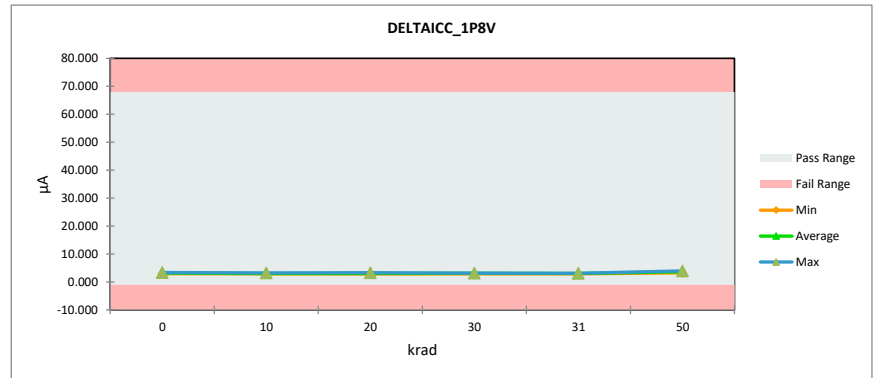



# TID Report SN54SC8T595-SEP

		DELTAICC_5P5V				
		μA				
		1500				
		-1				
krad	Serial #	PreTestHDR	PostTestHDR	Delta	Delta %	% of Limit Range
0	1	92.770	92.770	0.00	0.00%	0.00%
0	2	92.420	92.670	0.25	0.27%	0.02%
0	3	92.860	92.960	0.10	0.11%	0.01%
0	4	92.430	93.240	0.81	0.88%	0.05%
10	5	92.330	91.860	-0.47	-0.51%	0.03%
10	6	91.890	92.050	0.16	0.17%	0.01%
10	7	91.960	92.050	0.09	0.10%	0.01%
10	8	92.260	92.460	0.20	0.22%	0.01%
10	9	92.300	91.990	-0.31	-0.34%	0.02%
20	10	92.580	91.960	-0.62	-0.67%	0.04%
20	11	92.110	91.200	-0.91	-0.99%	0.06%
20	12	91.610	91.110	-0.50	-0.55%	0.03%
20	13	91.890	91.450	-0.44	-0.48%	0.03%
20	14	92.240	91.710	-0.53	-0.57%	0.04%
30	15	92.270	92.800	0.53	0.57%	0.04%
30	16	92.140	93.110	0.97	1.05%	0.06%
30	17	92.430	93.680	1.25	1.35%	0.08%
30	18	92.070	92.920	0.85	0.92%	0.06%
30	19	92.040	92.540	0.50	0.54%	0.03%
30	20	91.510	92.950	1.44	1.57%	0.10%
31	15a	92.270	92.330	0.06	0.07%	0.00%
31	16a	92.140	92.020	-0.12	-0.13%	0.01%
31	17a	92.430	92.550	0.12	0.13%	0.01%
31	18a	92.070	92.570	0.50	0.54%	0.03%
31	19a	92.040	92.860	0.82	0.89%	0.05%
31	20a	91.510	92.040	0.53	0.58%	0.04%
50	21	91.730	94.800	3.07	3.35%	0.20%
50	22	91.320	94.510	3.19	3.49%	0.21%
50	23	91.820	94.330	2.51	2.73%	0.17%
50	24	92.520	96.020	3.50	3.78%	0.23%
50	25	92.360	94.670	2.31	2.50%	0.15%
	Max	92.860	96.020	3.16	3.78%	0.23%
	Average	92.132	92.717	0.58	0.64%	0.06%
	Min	91.320	91.110	-0.21	-0.99%	0.00%
	Std Dev	0.367	1.084	0.72	1.25%	0.06%

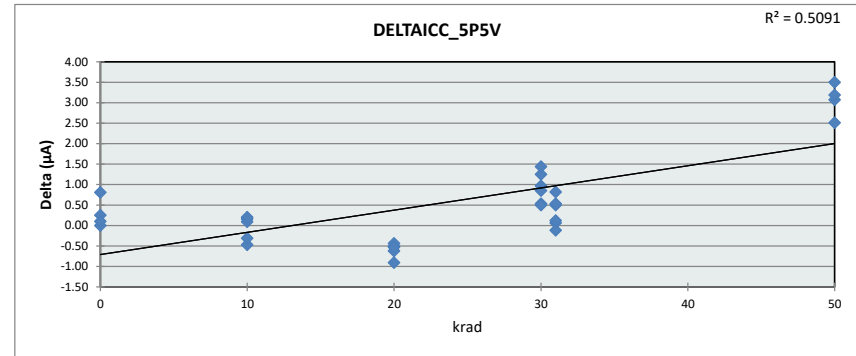

		DELTAICC_5P5V					
		μA					
		1500					
		-1					
krad		0	10	20	30	31	50
LL		-1.000	-1.000	-1.000	-1.000	-1.000	-1.000
Min		92.670	91.860	91.110	92.540	92.020	94.330
Average		92.910	92.082	91.486	93.000	92.395	94.866
Max		93.240	92.460	91.960	93.680	92.860	96.020
UL		1500.000	1500.000	1500.000	1500.000	1500.000	1500.000

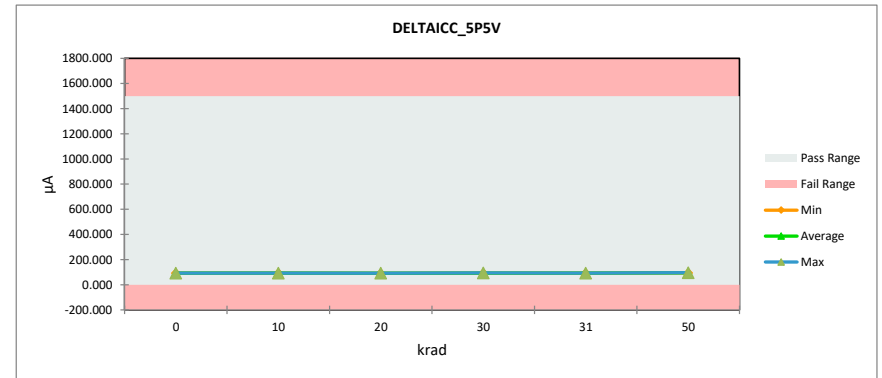

# TID Report SN54SC8T595-SEP

		ICC					
		μA					
		220					
		-0.1					
krad	Serial #	PreTestHDR	PostTestHDR	Delta	Delta %	% of Limit Range	
0	1	0.043	0.040	0.00	-7.30%	0.00%	
0	2	0.700	0.038	-0.66	-94.63%	0.30%	
0	3	0.044	0.057	0.01	29.66%	0.01%	
0	4	0.123	0.045	-0.08	-63.62%	0.04%	
10	5	0.060	0.049	-0.01	-17.34%	0.00%	
10	6	0.092	0.077	-0.02	-16.34%	0.01%	
10	7	1.225	0.055	-1.17	-95.50%	0.53%	
10	8	0.188	0.022	-0.17	-88.40%	0.08%	
10	9	0.040	0.047	0.01	19.09%	0.00%	
20	10	0.075	0.196	0.12	162.21%	0.06%	
20	11	0.051	0.192	0.14	277.31%	0.06%	
20	12	0.025	0.120	0.09	372.44%	0.04%	
20	13	0.045	0.163	0.12	263.19%	0.05%	
20	14	0.094	0.096	0.00	1.46%	0.00%	
30	15	0.029	5.943	5.91	20134.93%	2.69%	
30	16	0.035	7.157	7.12	20151.84%	3.24%	
30	17	0.053	7.116	7.06	13341.63%	3.21%	
30	18	0.095	7.337	7.24	7659.92%	3.29%	
30	19	0.036	6.606	6.57	18430.15%	2.99%	
30	20	0.039	4.720	4.68	12127.98%	2.13%	
31	15a	0.029	0.868	0.84	2855.40%	0.38%	
31	16a	0.035	0.544	0.51	1440.46%	0.23%	
31	17a	0.053	0.424	0.37	700.34%	0.17%	
31	18a	0.095	0.894	0.80	845.85%	0.36%	
31	19a	0.036	0.814	0.78	2183.59%	0.35%	
31	20a	0.039	0.804	0.77	1983.94%	0.35%	
50	21	0.027	1088.000	1087.97	3988169.79%	494.31%	
50	22	0.063	1177.000	1176.94	1877392.42%	534.73%	
50	23	0.089	1309.000	1308.91	1467224.29%	594.69%	
50	24	0.045	882.000	881.96	1978809.58%	400.71%	
50	25	0.035	1104.000	1103.96	3152384.29%	501.57%	
	Max	1.225	1309.000	1307.78	3988169.79%	594.69%	
	Average	0.120	150.014	149.89	313806.48%	68.17%	
	Min	0.025	0.022	0.00	-95.50%	0.00%	
	Std Dev	0.242	388.880	388.64	881727.45%	176.67%	

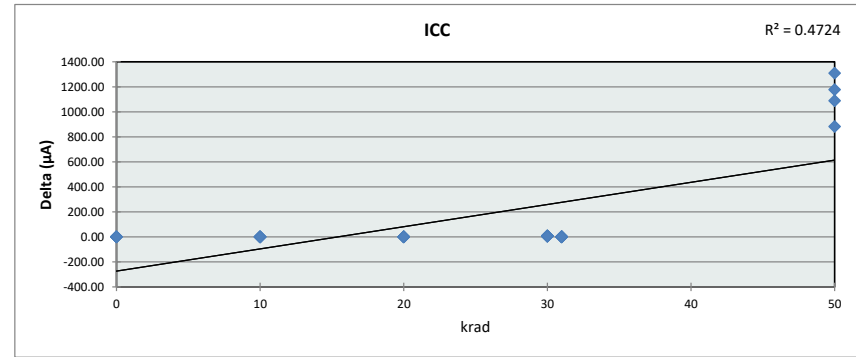

		ICC					
		μA					
		220					
		-0.1					
krad	0	10	20	30	31	50	
LL	-0.100	-0.100	-0.100	-0.100	-0.100	-0.100	
Min	0.038	0.022	0.096	4.720	0.424	882.000	
Average	0.045	0.050	0.153	6.480	0.725	1112.000	
Max	0.057	0.077	0.196	7.337	0.894	1309.000	
UL	220.000	220.000	220.000	220.000	220.000	220.000	

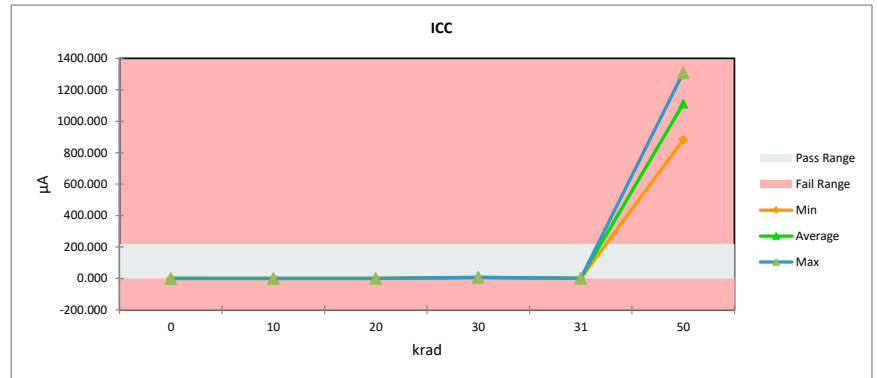

# TID Report SN54SC8T595-SEP

II_5P5V						
Units		μA				
Max Limit		1				
Min Limit		-1				
krad	Serial #	PreTestHDR	PostTestHDR	Delta	Delta %	% of Limit Range
0	1	0.004	0.005	0.00	10.63%	0.02%
0	2	0.006	0.002	0.00	-61.39%	0.19%
0	3	0.003	0.003	0.00	-0.07%	0.00%
0	4	0.005	0.004	0.00	-24.61%	0.06%
10	5	0.004	0.012	0.01	233.15%	0.43%
10	6	0.006	0.008	0.00	45.31%	0.13%
10	7	0.010	0.001	-0.01	-85.75%	0.44%
10	8	0.006	0.003	0.00	-50.45%	0.16%
10	9	0.003	0.016	0.01	415.81%	0.63%
20	10	0.012	0.004	-0.01	-70.46%	0.43%
20	11	0.005	0.002	0.00	-54.08%	0.14%
20	12	0.002	0.002	0.00	-13.08%	0.02%
20	13	0.003	0.012	0.01	244.18%	0.41%
20	14	0.003	0.004	0.00	18.74%	0.03%
30	15	0.002	-0.017	-0.02	-823.62%	0.99%
30	16	0.003	-0.005	-0.01	-249.14%	0.38%
30	17	0.013	-0.016	-0.03	-222.50%	1.50%
30	18	0.007	-0.014	-0.02	-290.90%	1.08%
30	19	0.010	-0.006	-0.02	-162.20%	0.84%
30	20	0.003	-0.010	-0.01	-419.95%	0.65%
31	15a	0.002	-0.004	-0.01	-276.21%	0.33%
31	16a	0.003	-0.007	-0.01	-322.43%	0.49%
31	17a	0.013	-0.004	-0.02	-132.28%	0.89%
31	18a	0.007	-0.007	-0.01	-190.82%	0.71%
31	19a	0.010	-0.006	-0.02	-156.35%	0.81%
31	20a	0.003	-0.010	-0.01	-410.36%	0.63%
50	21	0.013	-1.036	-1.05	-7980.64%	52.47%
50	22	0.011	-1.909	-1.92	-17051.71%	96.00%
50	23	0.005	-1.234	-1.24	-23658.43%	61.97%
50	24	0.008	-1.407	-1.42	-17539.74%	70.76%
50	25	0.004	-1.054	-1.06	-28849.39%	52.90%
	Max	0.013	0.016	0.00	415.81%	96.00%
	Average	0.006	-0.187	-0.19	-2309.31%	9.79%
	Min	0.002	-1.909	-1.91	-23658.43%	0.00%
	Std Dev	0.004	0.497	0.49	6056.18%	24.88%

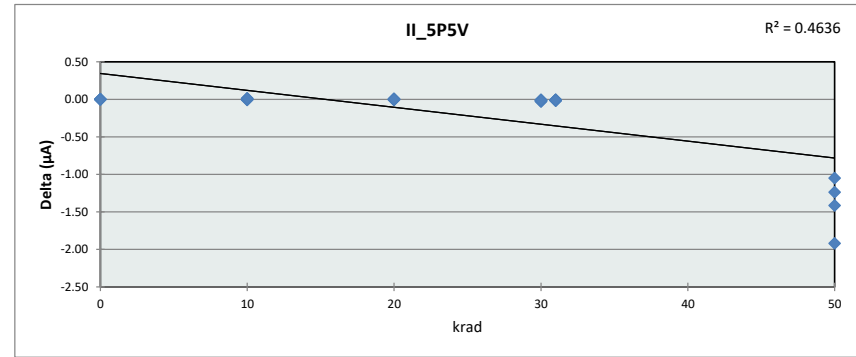

II_5P5V						
Units		μA				
Max Limit		1				
Min Limit		-1				
krad	0	10	20	30	31	50
LL	-1.000	-1.000	-1.000	-1.000	-1.000	-1.000
Min	0.002	0.001	0.002	-0.017	-0.010	-1.909
Average	0.004	0.008	0.005	-0.011	-0.006	-1.328
Max	0.005	0.016	0.012	-0.005	-0.004	-1.036
UL	1.000	1.000	1.000	1.000	1.000	1.000

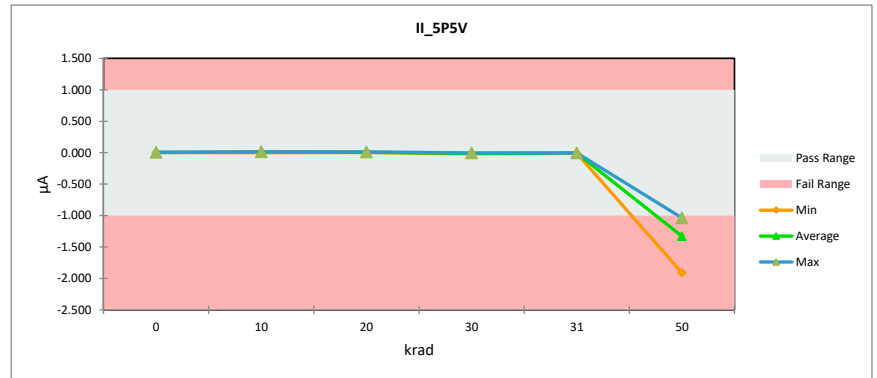

# TID Report SN54SC8T595-SEP

		IOZ_5P5V				
		Units		μA		
		Max Limit		26		
		Min Limit		-26		
krad	Serial #	PreTestHDR	PostTestHDR	Delta	Delta %	% of Limit Range
0	1	0.013	0.009	0.00	-29.41%	0.01%
0	2	0.318	0.007	-0.31	-97.77%	0.60%
0	3	0.009	0.009	0.00	-4.87%	0.00%
0	4	0.030	0.008	-0.02	-74.28%	0.04%
10	5	0.013	0.011	0.00	-17.72%	0.00%
10	6	0.024	0.006	-0.02	-74.22%	0.03%
10	7	0.731	0.006	-0.72	-99.22%	1.39%
10	8	0.053	0.010	-0.04	-81.65%	0.08%
10	9	0.006	0.006	0.00	-6.77%	0.00%
20	10	0.011	0.013	0.00	18.83%	0.00%
20	11	0.005	0.009	0.00	92.99%	0.01%
20	12	0.005	0.010	0.00	96.07%	0.01%
20	13	0.006	0.013	0.01	105.41%	0.01%
20	14	0.020	0.012	-0.01	-38.08%	0.01%
30	15	0.006	0.685	0.68	10694.33%	1.30%
30	16	0.008	0.701	0.69	8328.14%	1.33%
30	17	0.010	0.544	0.53	5122.86%	1.03%
30	18	0.012	0.508	0.50	4271.45%	0.96%
30	19	0.006	0.523	0.52	8854.48%	1.00%
30	20	0.007	0.332	0.33	4908.30%	0.63%
31	15a	0.006	0.030	0.02	378.96%	0.05%
31	16a	0.008	0.024	0.02	191.76%	0.03%
31	17a	0.010	0.014	0.00	37.56%	0.01%
31	18a	0.012	0.024	0.01	103.44%	0.02%
31	19a	0.006	0.020	0.01	250.10%	0.03%
31	20a	0.007	0.018	0.01	173.51%	0.02%
50	21	0.007	62.070	62.06	902605.06%	119.35%
50	22	0.014	75.630	75.62	551139.07%	145.42%
50	23	0.015	94.100	94.09	630597.05%	180.93%
50	24	0.008	54.740	54.73	708875.52%	105.25%
50	25	0.009	72.940	72.93	809444.95%	140.25%
	Max	0.731	94.100	93.37	902605.06%	180.93%
	Average	0.046	9.670	9.62	94544.03%	18.65%
	Min	0.005	0.006	0.00	-99.22%	0.00%
	Std Dev	0.141	25.340	25.20	245706.66%	48.70%

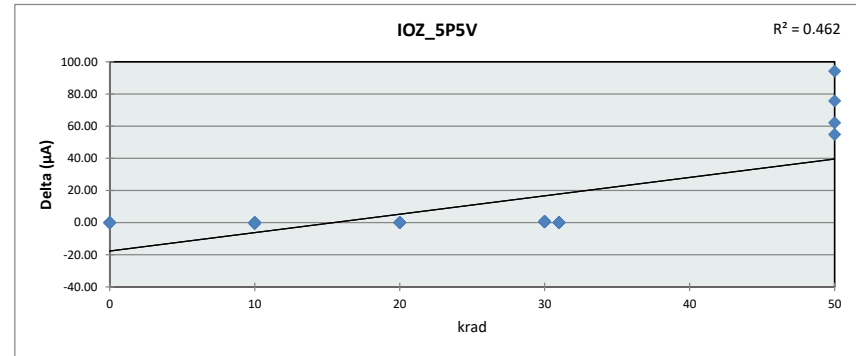

		IOZ_5P5V					
		Units					
		μA					
		Max Limit					
		26					
		Min Limit					
		-26					
krad		0	10	20	30	31	50
LL		-26.000	-26.000	-26.000	-26.000	-26.000	-26.000
Min		0.007	0.006	0.009	0.332	0.014	54.740
Average		0.008	0.008	0.012	0.549	0.022	71.896
Max		0.009	0.011	0.013	0.701	0.030	94.100
UL		26.000	26.000	26.000	26.000	26.000	26.000

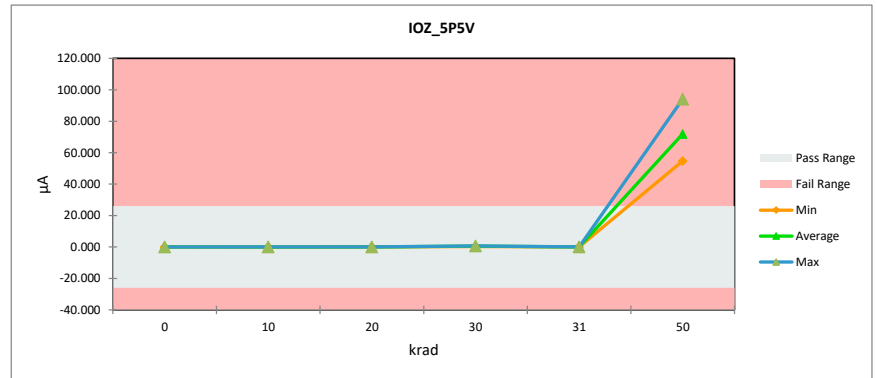

# TID Report

## SN54SC8T595-SEP

		VIH_1P2V				
Units		V				
Max Limit		0.78				
Min Limit		0.18				
krad	Serial #	PreTestHDR	PostTestHDR	Delta	Delta %	% of Limit Range
0	1	0.542	0.542	0.00	0.00%	0.00%
0	2	0.543	0.543	0.00	0.00%	0.00%
0	3	0.541	0.543	0.00	0.22%	0.20%
0	4	0.541	0.541	0.00	0.00%	0.00%
10	5	0.535	0.512	-0.02	-4.42%	3.94%
10	6	0.541	0.524	-0.02	-3.25%	2.93%
10	7	0.541	0.521	-0.02	-3.81%	3.44%
10	8	0.542	0.523	-0.02	-3.58%	3.23%
10	9	0.534	0.523	-0.01	-2.04%	1.82%
20	10	0.534	0.356	-0.18	-33.37%	29.71%
20	11	0.534	0.369	-0.16	-30.88%	27.49%
20	12	0.542	0.376	-0.17	-30.65%	27.69%
20	13	0.534	0.368	-0.17	-31.10%	27.69%
20	14	0.541	0.384	-0.16	-28.93%	26.08%
30	15	0.535	0.116	-0.42	-78.35%	69.84%
30	16	0.542	0.129	-0.41	-76.29%	68.93%
30	17	0.541	0.131	-0.41	-75.79%	68.32%
30	18	0.530	0.115	-0.42	-78.38%	69.23%
30	19	0.531	0.154	-0.38	-71.01%	62.87%
30	20	0.531	0.129	-0.40	-75.78%	67.01%
31	15a	0.535	0.384	-0.15	-28.12%	25.07%
31	16a	0.542	0.432	-0.11	-20.36%	18.39%
31	17a	0.541	0.434	-0.11	-19.73%	17.79%
31	18a	0.530	0.344	-0.19	-35.13%	31.03%
31	19a	0.531	0.376	-0.16	-29.23%	25.87%
31	20a	0.531	0.367	-0.16	-30.75%	27.19%
50	21	0.529	0.101	-0.43	-80.97%	71.36%
50	22	0.532	0.101	-0.43	-81.08%	71.86%
50	23	0.531	0.101	-0.43	-81.06%	71.76%
50	24	0.535	0.101	-0.43	-81.19%	72.37%
50	25	0.528	0.101	-0.43	-80.95%	71.26%
	Max	0.543	0.543	0.00	0.22%	72.37%
	Average	0.536	0.338	-0.20	-37.17%	33.10%
	Min	0.529	0.101	-0.43	-81.19%	0.00%
	Std Dev	0.005	0.171	0.17	31.61%	28.07%

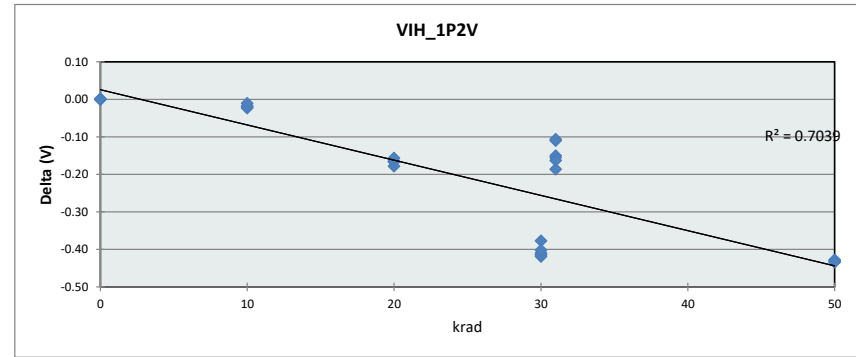

		VIH_1P2V					
Units		V					
Max Limit		0.78					
Min Limit		0.18					
krad		0	10	20	30	31	50
LL		0.180	0.180	0.180	0.180	0.180	0.180
Min		0.541	0.512	0.356	0.115	0.344	0.101
Average		0.542	0.520	0.371	0.129	0.390	0.101
Max		0.543	0.524	0.384	0.154	0.434	0.101
UL		0.780	0.780	0.780	0.780	0.780	0.780

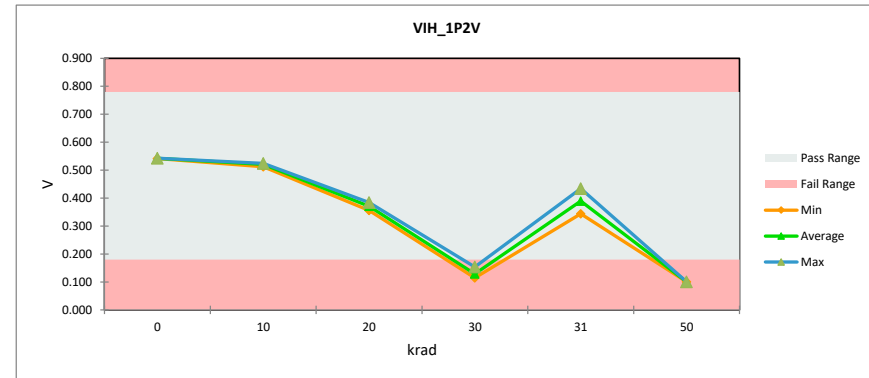

# TID Report SN54SC8T595-SEP

		VIH_1P65V				
Units		V				
Max Limit		1.1				
Min Limit		0.5				
krad	Serial #	PreTestHDR	PostTestHDR	Delta	Delta %	% of Limit Range
0	1	0.703	0.703	0.00	0.00%	0.00%
0	2	0.705	0.705	0.00	0.00%	0.00%
0	3	0.703	0.703	0.00	0.00%	0.00%
0	4	0.704	0.704	0.00	0.00%	0.00%
10	5	0.698	0.681	-0.02	-2.39%	2.78%
10	6	0.704	0.691	-0.01	-1.87%	2.20%
10	7	0.704	0.691	-0.01	-1.87%	2.20%
10	8	0.704	0.692	-0.01	-1.75%	2.05%
10	9	0.696	0.688	-0.01	-1.14%	1.32%
20	10	0.697	0.630	-0.07	-9.59%	11.14%
20	11	0.697	0.632	-0.07	-9.33%	10.84%
20	12	0.702	0.636	-0.07	-9.39%	10.99%
20	13	0.696	0.631	-0.07	-9.35%	10.84%
20	14	0.702	0.635	-0.07	-9.64%	11.28%
30	15	0.696	0.534	-0.16	-23.37%	27.11%
30	16	0.702	0.541	-0.16	-23.04%	26.97%
30	17	0.702	0.533	-0.17	-24.16%	28.28%
30	18	0.692	0.546	-0.15	-21.10%	24.33%
30	19	0.694	0.530	-0.16	-23.58%	27.26%
30	20	0.693	0.537	-0.16	-22.47%	25.94%
31	15a	0.696	0.641	-0.06	-7.96%	9.23%
31	16a	0.702	0.648	-0.05	-7.76%	9.09%
31	17a	0.702	0.649	-0.05	-7.64%	8.94%
31	18a	0.692	0.626	-0.07	-9.53%	10.99%
31	19a	0.694	0.634	-0.06	-8.62%	9.97%
31	20a	0.693	0.629	-0.06	-9.14%	10.55%
50	21	0.691	0.274	-0.42	-60.33%	69.47%
50	22	0.694	0.259	-0.43	-62.63%	72.40%
50	23	0.694	0.271	-0.42	-60.98%	70.49%
50	24	0.697	0.249	-0.45	-64.21%	74.60%
50	25	0.690	0.279	-0.41	-59.51%	68.44%
Max		0.705	0.705	0.00	0.00%	74.60%
Average		0.698	0.584	-0.11	-16.43%	19.04%
Min		0.691	0.249	-0.44	-64.21%	0.00%
Std Dev		0.005	0.140	0.14	19.80%	22.90%

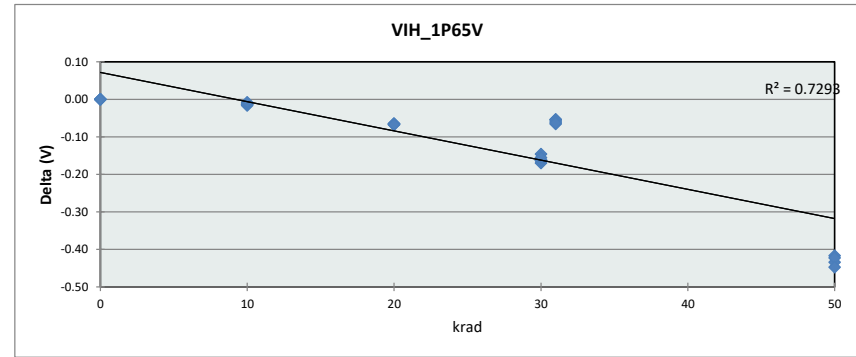

		VIH_1P65V					
Units		V					
Max Limit		1.1					
Min Limit		0.5					
krad		0	10	20	30	31	50
LL		0.500	0.500	0.500	0.500	0.500	0.500
Min		0.703	0.681	0.630	0.530	0.626	0.249
Average		0.704	0.689	0.633	0.537	0.638	0.267
Max		0.705	0.692	0.636	0.546	0.649	0.279
UL		1.100	1.100	1.100	1.100	1.100	1.100

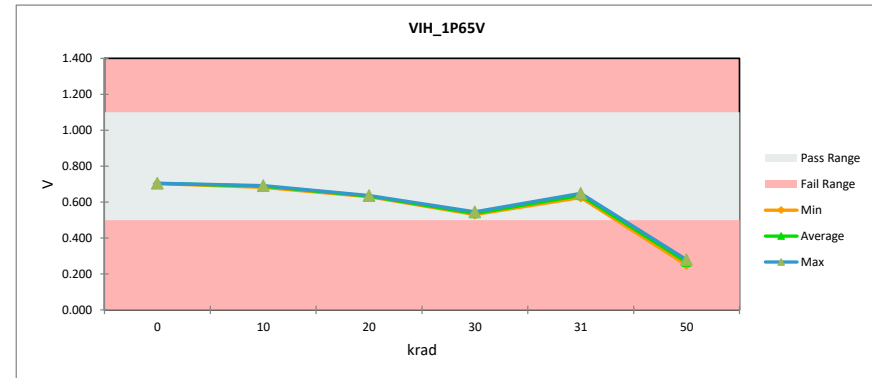

# TID Report SN54SC8T595-SEP

		VIH_2P25V				
		Units		V		
		Max Limit		1.28		
		Min Limit		0.65		
krad	Serial #	PreTestHDR	PostTestHDR	Delta	Delta %	% of Limit Range
0	1	0.878	0.877	0.00	-0.14%	0.20%
0	2	0.881	0.881	0.00	0.00%	0.00%
0	3	0.879	0.879	0.00	0.00%	0.00%
0	4	0.881	0.881	0.00	0.00%	0.00%
10	5	0.873	0.860	-0.01	-1.57%	2.17%
10	6	0.879	0.870	-0.01	-1.13%	1.58%
10	7	0.877	0.868	-0.01	-0.99%	1.38%
10	8	0.879	0.868	-0.01	-1.27%	1.78%
10	9	0.872	0.866	-0.01	-0.71%	0.99%
20	10	0.873	0.830	-0.04	-4.98%	6.91%
20	11	0.873	0.835	-0.04	-4.41%	6.12%
20	12	0.877	0.837	-0.04	-4.54%	6.31%
20	13	0.873	0.835	-0.04	-4.41%	6.12%
20	14	0.877	0.835	-0.04	-4.82%	6.71%
30	15	0.873	0.766	-0.11	-12.24%	16.97%
30	16	0.876	0.773	-0.10	-11.78%	16.38%
30	17	0.878	0.780	-0.10	-11.18%	15.59%
30	18	0.866	0.776	-0.09	-10.34%	14.21%
30	19	0.868	0.775	-0.09	-10.74%	14.80%
30	20	0.868	0.784	-0.08	-9.74%	13.42%
31	15a	0.873	0.840	-0.03	-3.84%	5.33%
31	16a	0.876	0.845	-0.03	-3.55%	4.93%
31	17a	0.878	0.846	-0.03	-3.68%	5.13%
31	18a	0.866	0.829	-0.04	-4.31%	5.92%
31	19a	0.868	0.831	-0.04	-4.30%	5.92%
31	20a	0.868	0.830	-0.04	-4.44%	6.12%
50	21	0.866	0.630	-0.24	-27.28%	37.49%
50	22	0.868	0.623	-0.24	-28.21%	38.87%
50	23	0.870	0.632	-0.24	-27.31%	37.69%
50	24	0.873	0.615	-0.26	-29.61%	41.04%
50	25	0.866	0.637	-0.23	-26.42%	36.31%
	Max	0.881	0.881	0.00	0.00%	41.04%
	Average	0.874	0.806	-0.07	-7.72%	10.67%
	Min	0.866	0.615	-0.25	-29.61%	0.00%
	Std Dev	0.005	0.080	0.08	8.94%	12.34%

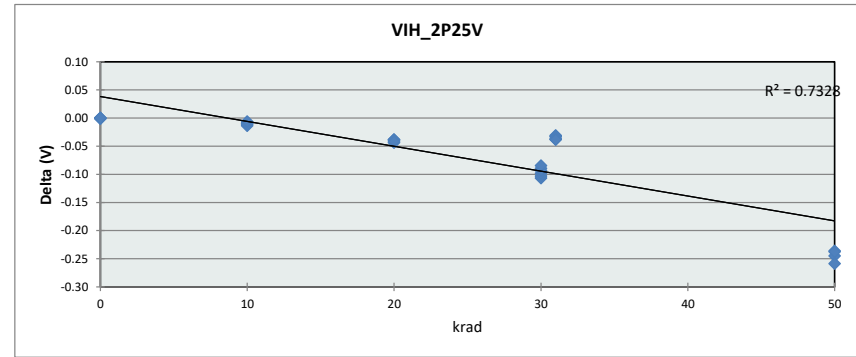

		VIH_2P25V					
		Units		V			
		Max Limit		1.28			
		Min Limit		0.65			
krad		0	10	20	30	31	50
LL		0.650	0.650	0.650	0.650	0.650	0.650
Min		0.877	0.860	0.830	0.766	0.829	0.615
Average		0.879	0.866	0.834	0.776	0.837	0.627
Max		0.881	0.870	0.837	0.784	0.846	0.637
UL		1.280	1.280	1.280	1.280	1.280	1.280

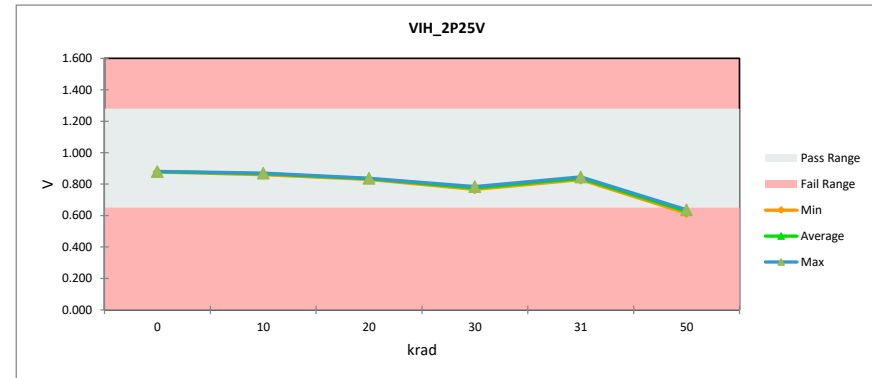

# TID Report

## SN54SC8T595-SEP

		VIH_3V					
		Units		V			
		Max Limit		1.45			
		Min Limit		0.75			
krad	Serial #	PreTestHDR	PostTestHDR	Delta	Delta %	% of Limit Range	
0	1	1.051	1.053	0.00	0.16%	0.24%	
0	2	1.054	1.054	0.00	0.00%	0.00%	
0	3	1.053	1.053	0.00	0.00%	0.00%	
0	4	1.054	1.054	0.00	0.00%	0.00%	
10	5	1.046	1.034	-0.01	-1.14%	1.70%	
10	6	1.053	1.044	-0.01	-0.81%	1.21%	
10	7	1.053	1.041	-0.01	-1.13%	1.70%	
10	8	1.053	1.041	-0.01	-1.13%	1.70%	
10	9	1.046	1.039	-0.01	-0.65%	0.97%	
20	10	1.046	1.012	-0.03	-3.25%	4.85%	
20	11	1.046	1.020	-0.03	-2.44%	3.64%	
20	12	1.049	1.017	-0.03	-3.07%	4.61%	
20	13	1.047	1.020	-0.03	-2.59%	3.88%	
20	14	1.054	1.015	-0.04	-3.70%	5.58%	
30	15	1.047	0.981	-0.07	-6.32%	9.46%	
30	16	1.047	0.985	-0.06	-6.00%	8.98%	
30	17	1.056	0.990	-0.07	-6.27%	9.46%	
30	18	1.042	0.983	-0.06	-5.70%	8.49%	
30	19	1.042	0.986	-0.06	-5.38%	8.00%	
30	20	1.041	0.988	-0.05	-5.06%	7.52%	
31	15a	1.047	1.020	-0.03	-2.59%	3.88%	
31	16a	1.047	1.027	-0.02	-1.95%	2.91%	
31	17a	1.056	1.025	-0.03	-2.89%	4.37%	
31	18a	1.042	1.008	-0.03	-3.26%	4.85%	
31	19a	1.042	1.012	-0.03	-2.93%	4.37%	
31	20a	1.041	1.010	-0.03	-2.94%	4.37%	
50	21	1.039	0.900	-0.14	-13.40%	19.89%	
50	22	1.041	0.903	-0.14	-13.22%	19.65%	
50	23	1.044	0.905	-0.14	-13.34%	19.89%	
50	24	1.049	0.900	-0.15	-14.24%	21.35%	
50	25	1.039	0.903	-0.14	-13.07%	19.41%	
Max		1.056	1.054	0.00	0.16%	21.35%	
Average		1.048	1.004	-0.04	-4.17%	6.25%	
Min		1.039	0.900	-0.14	-14.24%	0.00%	
Std Dev		0.005	0.046	0.04	4.20%	6.25%	

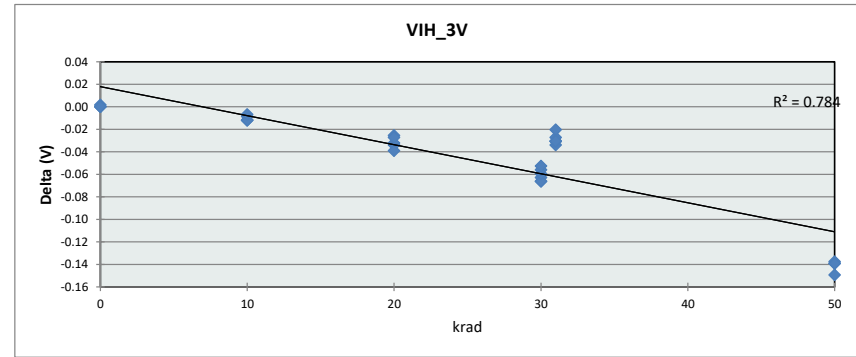

		VIH_3V					
		Units		V			
		Max Limit		1.45			
		Min Limit		0.75			
krad		0	10	20	30	31	50
LL		0.750	0.750	0.750	0.750	0.750	0.750
Min		1.053	1.034	1.012	0.981	1.008	0.900
Average		1.053	1.040	1.017	0.986	1.017	0.902
Max		1.054	1.044	1.020	0.990	1.027	0.905
UL		1.450	1.450	1.450	1.450	1.450	1.450

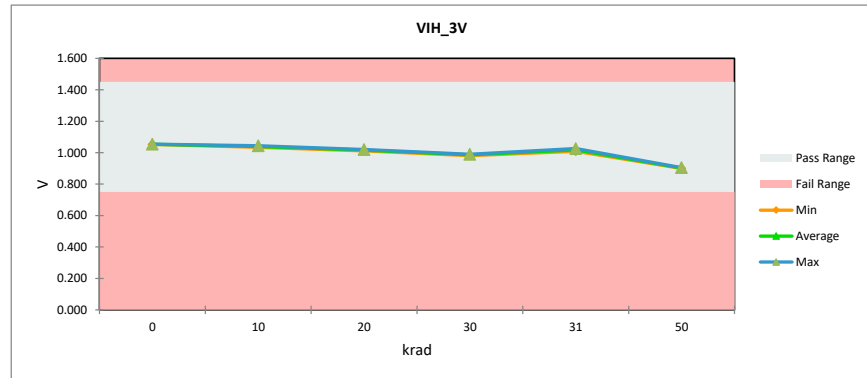



# TID Report

## SN54SC8T595-SEP

		VIH_4P5V				
Units		V				
Max Limit		2				
Min Limit		0.85				
krad	Serial #	PreTestHDR	PostTestHDR	Delta	Delta %	% of Limit Range
0	1	1.352	1.354	0.00	0.19%	0.23%
0	2	1.362	1.362	0.00	0.00%	0.00%
0	3	1.362	1.359	0.00	-0.19%	0.23%
0	4	1.359	1.362	0.00	0.19%	0.23%
10	5	1.354	1.344	-0.01	-0.77%	0.91%
10	6	1.362	1.352	-0.01	-0.77%	0.91%
10	7	1.357	1.349	-0.01	-0.58%	0.68%
10	8	1.359	1.349	-0.01	-0.77%	0.91%
10	9	1.354	1.349	-0.01	-0.39%	0.45%
20	10	1.357	1.328	-0.03	-2.11%	2.49%
20	11	1.352	1.331	-0.02	-1.54%	1.81%
20	12	1.359	1.331	-0.03	-2.11%	2.49%
20	13	1.357	1.331	-0.03	-1.92%	2.27%
20	14	1.354	1.328	-0.03	-1.93%	2.27%
30	15	1.354	1.305	-0.05	-3.66%	4.31%
30	16	1.352	1.305	-0.05	-3.47%	4.08%
30	17	1.357	1.307	-0.05	-3.65%	4.31%
30	18	1.344	1.300	-0.04	-3.30%	3.85%
30	19	1.346	1.305	-0.04	-3.10%	3.63%
30	20	1.349	1.302	-0.05	-3.48%	4.08%
31	15a	1.354	1.336	-0.02	-1.35%	1.59%
31	16a	1.352	1.336	-0.02	-1.16%	1.36%
31	17a	1.357	1.336	-0.02	-1.54%	1.81%
31	18a	1.344	1.323	-0.02	-1.55%	1.81%
31	19a	1.346	1.328	-0.02	-1.36%	1.59%
31	20a	1.349	1.323	-0.03	-1.93%	2.27%
50	21	1.346	1.247	-0.10	-7.36%	8.62%
50	22	1.352	1.250	-0.10	-7.52%	8.84%
50	23	1.352	1.250	-0.10	-7.52%	8.84%
50	24	1.357	1.250	-0.11	-7.88%	9.30%
50	25	1.344	1.247	-0.10	-7.18%	8.39%
Max		1.362	1.362	0.00	0.19%	9.30%
Average		1.354	1.321	-0.03	-2.42%	2.87%
Min		1.344	1.247	-0.10	-7.88%	0.00%
Std Dev		0.005	0.034	0.03	2.35%	2.73%

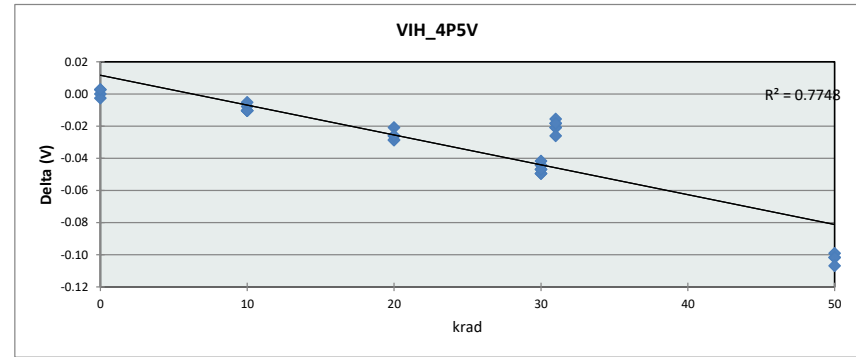

		VIH_4P5V					
Units		V					
Max Limit		2					
Min Limit		0.85					
krad		0	10	20	30	31	50
LL		0.850	0.850	0.850	0.850	0.850	0.850
Min		1.354	1.344	1.328	1.300	1.323	1.247
Average		1.359	1.349	1.330	1.304	1.330	1.249
Max		1.362	1.352	1.331	1.307	1.336	1.250
UL		2.000	2.000	2.000	2.000	2.000	2.000

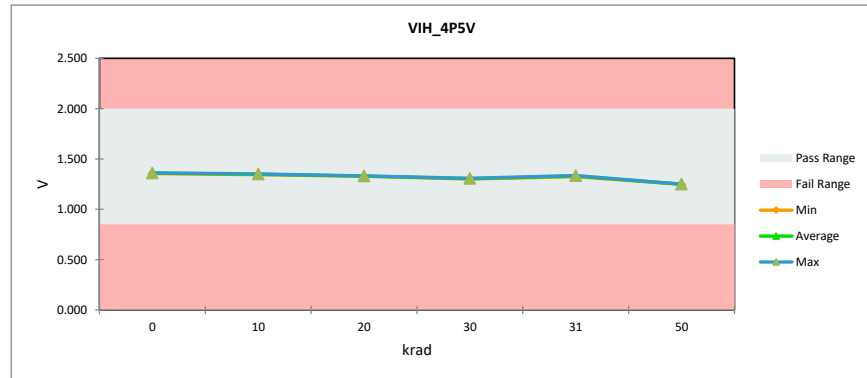

# TID Report SN54SC8T595-SEP

		VIH_5P5V				
Units		V				
Max Limit		2				
Min Limit		0.85				
krad	Serial #	PreTestHDR	PostTestHDR	Delta	Delta %	% of Limit Range
0	1	1.537	1.537	0.00	0.00%	0.00%
0	2	1.546	1.546	0.00	0.00%	0.00%
0	3	1.543	1.546	0.00	0.21%	0.28%
0	4	1.546	1.546	0.00	0.00%	0.00%
10	5	1.540	1.530	-0.01	-0.63%	0.84%
10	6	1.550	1.537	-0.01	-0.83%	1.12%
10	7	1.543	1.533	-0.01	-0.62%	0.84%
10	8	1.543	1.533	-0.01	-0.62%	0.84%
10	9	1.540	1.533	-0.01	-0.42%	0.56%
20	10	1.540	1.514	-0.03	-1.67%	2.24%
20	11	1.543	1.517	-0.03	-1.67%	2.24%
20	12	1.540	1.514	-0.03	-1.67%	2.24%
20	13	1.543	1.517	-0.03	-1.67%	2.24%
20	14	1.543	1.511	-0.03	-2.08%	2.79%
30	15	1.540	1.495	-0.04	-2.92%	3.91%
30	16	1.533	1.492	-0.04	-2.72%	3.63%
30	17	1.540	1.495	-0.04	-2.92%	3.91%
30	18	1.533	1.488	-0.04	-2.93%	3.91%
30	19	1.533	1.492	-0.04	-2.72%	3.63%
30	20	1.533	1.488	-0.04	-2.93%	3.91%
31	15a	1.540	1.521	-0.02	-1.25%	1.68%
31	16a	1.533	1.521	-0.01	-0.84%	1.12%
31	17a	1.540	1.524	-0.02	-1.04%	1.40%
31	18a	1.533	1.508	-0.03	-1.68%	2.24%
31	19a	1.533	1.514	-0.02	-1.26%	1.68%
31	20a	1.533	1.508	-0.03	-1.68%	2.24%
50	21	1.537	1.440	-0.10	-6.27%	8.38%
50	22	1.537	1.443	-0.09	-6.07%	8.11%
50	23	1.537	1.443	-0.09	-6.07%	8.11%
50	24	1.543	1.447	-0.10	-6.25%	8.38%
50	25	1.533	1.440	-0.09	-6.08%	8.11%
Max		1.550	1.546	0.00	0.21%	8.38%
Average		1.539	1.508	-0.03	-2.04%	2.75%
Min		1.533	1.440	-0.09	-6.27%	0.00%
Std Dev		0.005	0.031	0.03	1.90%	2.51%

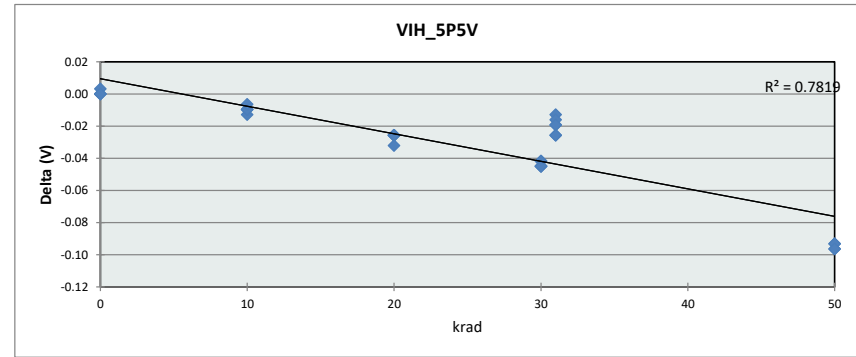

		VIH_5P5V					
Units		V					
Max Limit		2					
Min Limit		0.85					
krad		0	10	20	30	31	50
LL		0.850	0.850	0.850	0.850	0.850	0.850
Min		1.537	1.530	1.511	1.488	1.508	1.440
Average		1.544	1.533	1.515	1.492	1.516	1.443
Max		1.546	1.537	1.517	1.495	1.524	1.447
UL		2.000	2.000	2.000	2.000	2.000	2.000

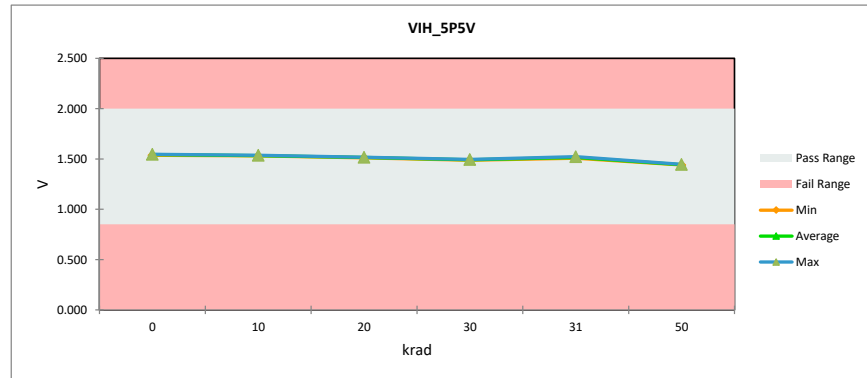

# TID Report

## SN54SC8T595-SEP

		VIL_1P2V				
		Units		V		
		Max Limit		0.78		
		Min Limit		0.18		
krad	Serial #	PreTestHDR	PostTestHDR	Delta	Delta %	% of Limit Range
0	1	0.534	0.534	0.00	0.13%	0.11%
0	2	0.534	0.532	0.00	-0.25%	0.22%
0	3	0.535	0.535	0.00	0.00%	0.00%
0	4	0.532	0.532	0.00	0.00%	0.00%
10	5	0.526	0.506	-0.02	-3.68%	3.22%
10	6	0.533	0.518	-0.01	-2.75%	2.45%
10	7	0.533	0.516	-0.02	-3.25%	2.89%
10	8	0.533	0.517	-0.02	-3.00%	2.67%
10	9	0.528	0.518	-0.01	-1.90%	1.67%
20	10	0.529	0.358	-0.17	-32.29%	28.46%
20	11	0.526	0.368	-0.16	-30.08%	26.35%
20	12	0.534	0.372	-0.16	-30.25%	26.91%
20	13	0.526	0.386	-0.14	-26.62%	23.35%
20	14	0.534	0.382	-0.15	-28.47%	25.35%
30	15	0.526	0.132	-0.39	-74.88%	65.60%
30	16	0.534	0.118	-0.42	-77.88%	69.27%
30	17	0.536	0.122	-0.41	-77.22%	68.93%
30	18	0.524	0.149	-0.37	-71.60%	62.49%
30	19	0.523	0.119	-0.40	-77.18%	67.27%
30	20	0.522	0.201	-0.32	-61.44%	53.48%
31	15a	0.526	0.414	-0.11	-21.32%	18.68%
31	16a	0.534	0.426	-0.11	-20.13%	17.90%
31	17a	0.536	0.428	-0.11	-20.05%	17.90%
31	18a	0.524	0.345	-0.18	-34.14%	29.80%
31	19a	0.523	0.408	-0.12	-22.07%	19.24%
31	20a	0.522	0.404	-0.12	-22.74%	19.79%
50	21	0.524	0.106	-0.42	-79.78%	69.71%
50	22	0.524	0.105	-0.42	-80.04%	69.94%
50	23	0.522	0.099	-0.42	-80.98%	70.49%
50	24	0.528	0.100	-0.43	-81.05%	71.27%
50	25	0.521	0.100	-0.42	-80.80%	70.16%
	Max	0.536	0.535	0.00	0.13%	71.27%
	Average	0.529	0.342	-0.19	-35.50%	31.18%
	Min	0.522	0.099	-0.42	-81.05%	0.00%
	Std Dev	0.005	0.167	0.16	31.32%	27.46%

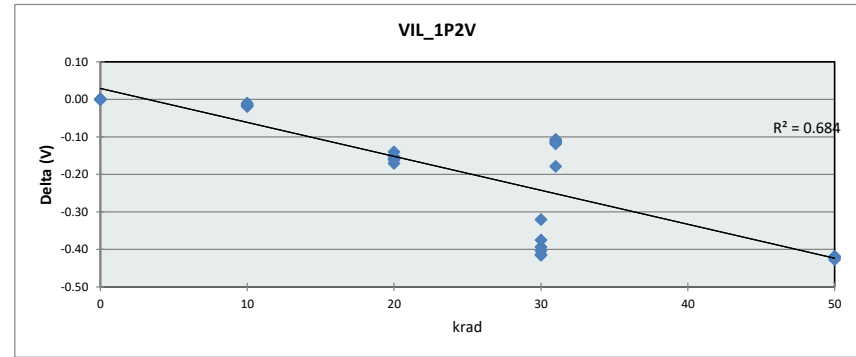

		VIL_1P2V					
		Units		V			
		Max Limit		0.78			
		Min Limit		0.18			
krad		0	10	20	30	31	50
LL		0.180	0.180	0.180	0.180	0.180	0.180
Min		0.532	0.506	0.358	0.118	0.345	0.099
Average		0.533	0.515	0.373	0.140	0.404	0.102
Max		0.535	0.518	0.386	0.201	0.428	0.106
UL		0.780	0.780	0.780	0.780	0.780	0.780

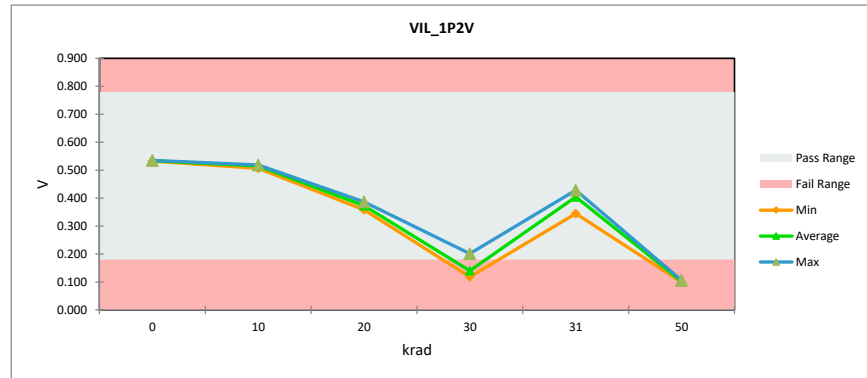

# TID Report

## SN54SC8T595-SEP

		VIL_1P65V				
Units		V				
Max Limit		1.1				
Min Limit		0.5				
krad	Serial #	PreTestHDR	PostTestHDR	Delta	Delta %	% of Limit Range
0	1	0.688	0.688	0.00	0.00%	0.00%
0	2	0.687	0.688	0.00	0.14%	0.16%
0	3	0.689	0.688	0.00	-0.14%	0.16%
0	4	0.686	0.686	0.00	0.00%	0.00%
10	5	0.681	0.667	-0.01	-2.13%	2.42%
10	6	0.688	0.677	-0.01	-1.69%	1.93%
10	7	0.686	0.676	-0.01	-1.55%	1.77%
10	8	0.687	0.677	-0.01	-1.41%	1.61%
10	9	0.681	0.673	-0.01	-1.28%	1.45%
20	10	0.681	0.615	-0.07	-9.80%	11.12%
20	11	0.678	0.617	-0.06	-9.12%	10.32%
20	12	0.686	0.620	-0.07	-9.59%	10.96%
20	13	0.679	0.615	-0.06	-9.54%	10.80%
20	14	0.687	0.619	-0.07	-9.85%	11.29%
30	15	0.678	0.529	-0.15	-21.96%	24.83%
30	16	0.687	0.536	-0.15	-21.96%	25.15%
30	17	0.688	0.530	-0.16	-22.91%	26.28%
30	18	0.676	0.542	-0.13	-19.76%	22.25%
30	19	0.677	0.526	-0.15	-22.31%	25.15%
30	20	0.677	0.532	-0.14	-21.30%	24.02%
31	15a	0.678	0.624	-0.05	-7.98%	9.03%
31	16a	0.687	0.631	-0.06	-8.16%	9.35%
31	17a	0.688	0.632	-0.06	-8.15%	9.35%
31	18a	0.676	0.610	-0.07	-9.74%	10.96%
31	19a	0.677	0.618	-0.06	-8.58%	9.67%
31	20a	0.677	0.613	-0.06	-9.44%	10.64%
50	21	0.676	0.269	-0.41	-60.14%	67.71%
50	22	0.677	0.255	-0.42	-62.39%	70.45%
50	23	0.677	0.264	-0.41	-60.91%	68.68%
50	24	0.682	0.244	-0.44	-64.22%	73.03%
50	25	0.675	0.274	-0.40	-59.37%	66.74%
Max		0.689	0.688	0.00	0.14%	73.03%
Average		0.682	0.572	-0.11	-16.20%	18.35%
Min		0.676	0.244	-0.43	-64.22%	0.00%
Std Dev		0.005	0.136	0.13	19.68%	22.23%

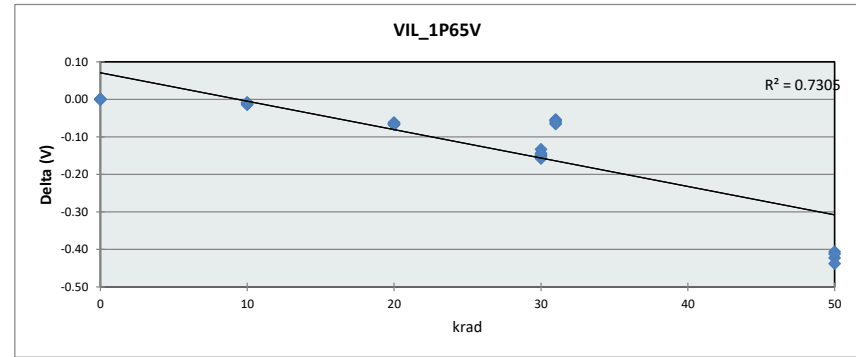

		VIL_1P65V					
Units		V					
Max Limit		1.1					
Min Limit		0.5					
krad		0	10	20	30	31	50
LL		0.500	0.500	0.500	0.500	0.500	0.500
Min		0.686	0.667	0.615	0.526	0.610	0.244
Average		0.688	0.674	0.617	0.533	0.621	0.261
Max		0.688	0.677	0.620	0.542	0.632	0.274
UL		1.100	1.100	1.100	1.100	1.100	1.100

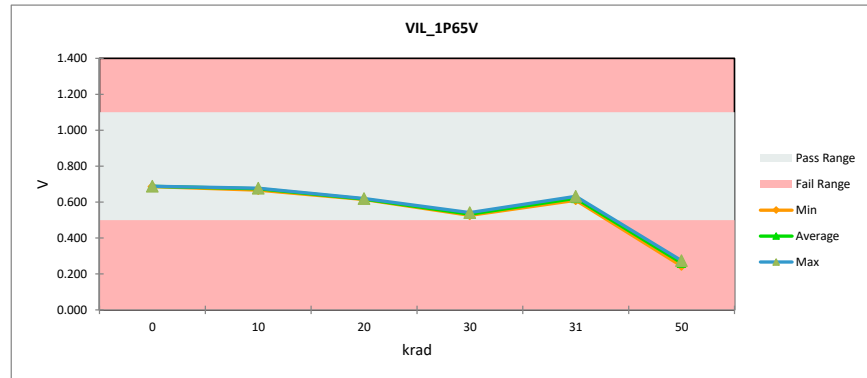

# TID Report

## SN54SC8T595-SEP

		VIL_2P25V				
Units		V				
Max Limit		1.28				
Min Limit		0.65				
krad	Serial #	PreTestHDR	PostTestHDR	Delta	Delta %	% of Limit Range
0	1	0.838	0.838	0.00	0.00%	0.00%
0	2	0.843	0.843	0.00	0.00%	0.00%
0	3	0.840	0.840	0.00	0.00%	0.00%
0	4	0.841	0.841	0.00	0.00%	0.00%
10	5	0.834	0.822	-0.01	-1.48%	1.95%
10	6	0.840	0.832	-0.01	-0.98%	1.30%
10	7	0.837	0.830	-0.01	-0.82%	1.09%
10	8	0.840	0.829	-0.01	-1.30%	1.74%
10	9	0.833	0.826	-0.01	-0.82%	1.09%
20	10	0.833	0.789	-0.04	-5.25%	6.95%
20	11	0.834	0.795	-0.04	-4.75%	6.30%
20	12	0.837	0.797	-0.04	-4.74%	6.30%
20	13	0.833	0.796	-0.04	-4.43%	5.86%
20	14	0.838	0.795	-0.04	-5.22%	6.95%
30	15	0.833	0.767	-0.07	-7.88%	10.42%
30	16	0.836	0.773	-0.06	-7.53%	9.99%
30	17	0.840	0.773	-0.07	-7.98%	10.64%
30	18	0.828	0.776	-0.05	-6.28%	8.25%
30	19	0.829	0.761	-0.07	-8.25%	10.85%
30	20	0.829	0.763	-0.07	-7.92%	10.42%
31	15a	0.833	0.800	-0.03	-3.94%	5.21%
31	16a	0.836	0.804	-0.03	-3.76%	4.99%
31	17a	0.840	0.806	-0.03	-4.07%	5.43%
31	18a	0.828	0.789	-0.04	-4.63%	6.08%
31	19a	0.829	0.792	-0.04	-4.45%	5.86%
31	20a	0.829	0.789	-0.04	-4.78%	6.30%
50	21	0.828	0.622	-0.21	-24.79%	32.56%
50	22	0.829	0.616	-0.21	-25.74%	33.86%
50	23	0.830	0.625	-0.21	-24.71%	32.56%
50	24	0.834	0.607	-0.23	-27.21%	36.03%
50	25	0.826	0.629	-0.20	-23.84%	31.26%
Max		0.843	0.843	0.00	0.00%	36.03%
Average		0.834	0.778	-0.06	-6.79%	8.97%
Min		0.828	0.607	-0.22	-27.21%	0.00%
Std Dev		0.005	0.068	0.06	7.95%	10.48%

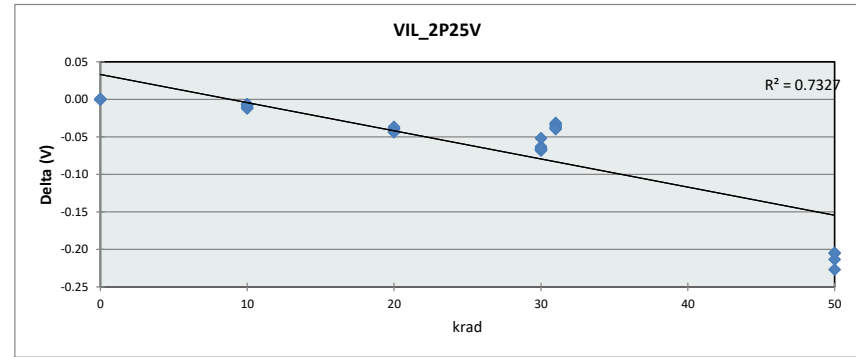

		VIL_2P25V					
Units		V					
Max Limit		1.28					
Min Limit		0.65					
krad		0	10	20	30	31	50
LL		0.650	0.650	0.650	0.650	0.650	0.650
Min		0.838	0.822	0.789	0.761	0.789	0.607
Average		0.841	0.828	0.794	0.769	0.797	0.620
Max		0.843	0.832	0.797	0.776	0.806	0.629
UL		1.280	1.280	1.280	1.280	1.280	1.280

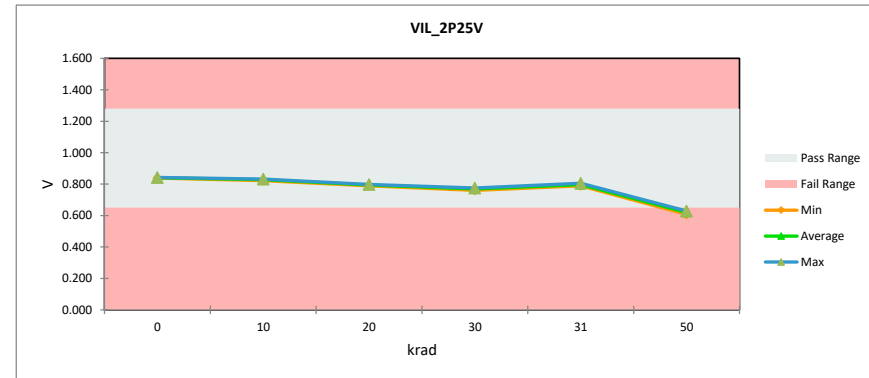

# TID Report

## SN54SC8T595-SEP

		VIL_3V				
		Units		V		
		Max Limit		1.45		
		Min Limit		0.75		
krad	Serial #	PreTestHDR	PostTestHDR	Delta	Delta %	% of Limit Range
0	1	1.041	1.043	0.00	0.18%	0.27%
0	2	1.047	1.047	0.00	0.00%	0.00%
0	3	1.045	1.047	0.00	0.18%	0.27%
0	4	1.047	1.047	0.00	0.00%	0.00%
10	5	1.040	1.028	-0.01	-1.08%	1.60%
10	6	1.045	1.038	-0.01	-0.71%	1.07%
10	7	1.043	1.034	-0.01	-0.90%	1.33%
10	8	1.047	1.034	-0.01	-1.25%	1.87%
10	9	1.040	1.034	-0.01	-0.54%	0.80%
20	10	1.040	1.006	-0.03	-3.23%	4.80%
20	11	1.041	1.010	-0.03	-3.05%	4.54%
20	12	1.043	1.012	-0.03	-3.04%	4.54%
20	13	1.040	1.010	-0.03	-2.87%	4.27%
20	14	1.041	1.008	-0.03	-3.23%	4.80%
30	15	1.040	0.976	-0.06	-6.11%	9.07%
30	16	1.041	0.980	-0.06	-5.92%	8.81%
30	17	1.047	0.982	-0.07	-6.24%	9.34%
30	18	1.034	0.974	-0.06	-5.78%	8.54%
30	19	1.036	0.976	-0.06	-5.77%	8.54%
30	20	1.034	0.976	-0.06	-5.60%	8.27%
31	15a	1.040	1.013	-0.03	-2.52%	3.74%
31	16a	1.041	1.017	-0.02	-2.33%	3.47%
31	17a	1.047	1.015	-0.03	-3.03%	4.54%
31	18a	1.034	1.002	-0.03	-3.07%	4.54%
31	19a	1.036	1.006	-0.03	-2.89%	4.27%
31	20a	1.034	1.002	-0.03	-3.07%	4.54%
50	21	1.032	0.892	-0.14	-13.57%	20.01%
50	22	1.032	0.894	-0.14	-13.39%	19.75%
50	23	1.034	0.896	-0.14	-13.37%	19.75%
50	24	1.041	0.888	-0.15	-14.71%	21.88%
50	25	1.034	0.896	-0.14	-13.37%	19.75%
	Max	1.047	1.047	0.00	0.18%	21.88%
	Average	1.040	0.996	-0.04	-4.23%	6.31%
	Min	1.032	0.888	-0.14	-14.71%	0.00%
	Std Dev	0.005	0.047	0.04	4.28%	6.29%

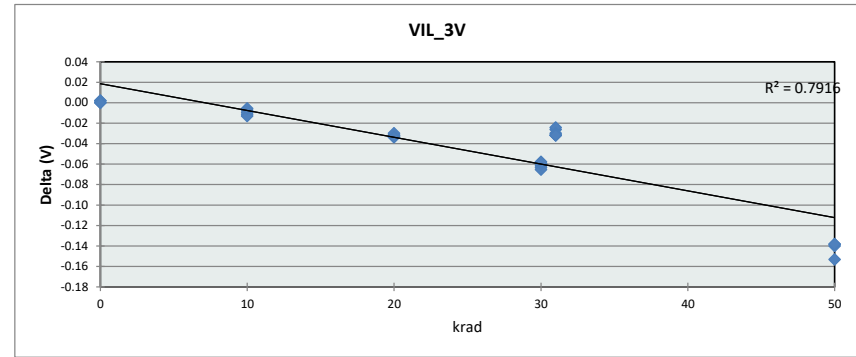

		VIL_3V					
		Units		V			
		Max Limit		1.45			
		Min Limit		0.75			
krad		0	10	20	30	31	50
LL		0.750	0.750	0.750	0.750	0.750	0.750
Min		1.043	1.028	1.006	0.974	1.002	0.888
Average		1.046	1.034	1.009	0.977	1.009	0.893
Max		1.047	1.038	1.012	0.982	1.017	0.896
UL		1.450	1.450	1.450	1.450	1.450	1.450

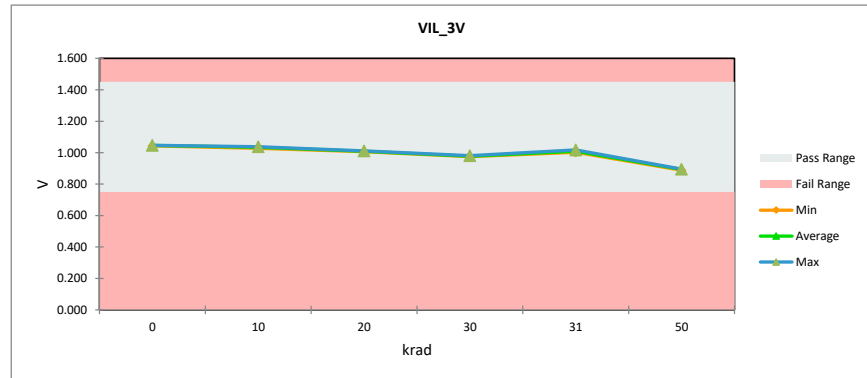

# TID Report SN54SC8T595-SEP

		VIL_4P5V				
		Units		V		
		Max Limit		2		
		Min Limit		0.85		
krad	Serial #	PreTestHDR	PostTestHDR	Delta	Delta %	% of Limit Range
0	1	1.342	1.342	0.00	0.00%	0.00%
0	2	1.351	1.351	0.00	0.00%	0.00%
0	3	1.345	1.336	-0.01	-0.64%	0.75%
0	4	1.345	1.336	-0.01	-0.64%	0.75%
10	5	1.342	1.331	-0.01	-0.86%	1.00%
10	6	1.345	1.339	-0.01	-0.43%	0.50%
10	7	1.342	1.336	-0.01	-0.43%	0.50%
10	8	1.342	1.336	-0.01	-0.43%	0.50%
10	9	1.342	1.333	-0.01	-0.64%	0.75%
20	10	1.345	1.316	-0.03	-2.13%	2.49%
20	11	1.339	1.319	-0.02	-1.50%	1.75%
20	12	1.342	1.316	-0.03	-1.92%	2.24%
20	13	1.342	1.319	-0.02	-1.71%	2.00%
20	14	1.342	1.313	-0.03	-2.14%	2.49%
30	15	1.339	1.293	-0.05	-3.43%	3.99%
30	16	1.339	1.293	-0.05	-3.43%	3.99%
30	17	1.345	1.296	-0.05	-3.63%	4.24%
30	18	1.331	1.288	-0.04	-3.23%	3.74%
30	19	1.333	1.290	-0.04	-3.23%	3.74%
30	20	1.333	1.288	-0.05	-3.44%	3.99%
31	15a	1.339	1.322	-0.02	-1.29%	1.50%
31	16a	1.339	1.322	-0.02	-1.29%	1.50%
31	17a	1.345	1.325	-0.02	-1.49%	1.75%
31	18a	1.331	1.311	-0.02	-1.51%	1.75%
31	19a	1.333	1.316	-0.02	-1.29%	1.50%
31	20a	1.333	1.311	-0.02	-1.72%	2.00%
50	21	1.333	1.236	-0.10	-7.31%	8.48%
50	22	1.336	1.239	-0.10	-7.30%	8.48%
50	23	1.333	1.239	-0.09	-7.10%	8.23%
50	24	1.342	1.239	-0.10	-7.69%	8.98%
50	25	1.333	1.236	-0.10	-7.31%	8.48%
	Max	1.351	1.351	0.00	0.00%	8.98%
	Average	1.340	1.308	-0.03	-2.39%	2.79%
	Min	1.331	1.236	-0.09	-7.69%	0.00%
	Std Dev	0.005	0.033	0.03	2.25%	2.61%

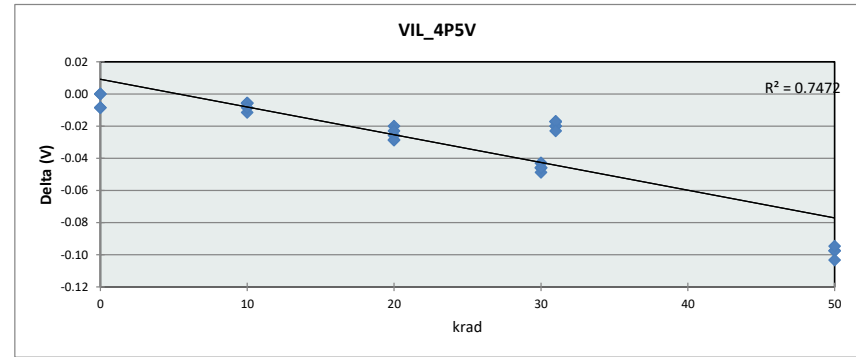

		VIL_4P5V				
		Units		V		
		Max Limit		2		
		Min Limit		0.85		
krad	LL	Min	Average	Max	UL	
0	0.850	1.336	1.341	1.351	2.000	
10	0.850	1.331	1.335	1.339	2.000	
20	0.850	1.313	1.317	1.319	2.000	
30	0.850	1.288	1.291	1.296	2.000	
31	0.850	1.311	1.318	1.325	2.000	
50	0.850	1.236	1.238	1.239	2.000	

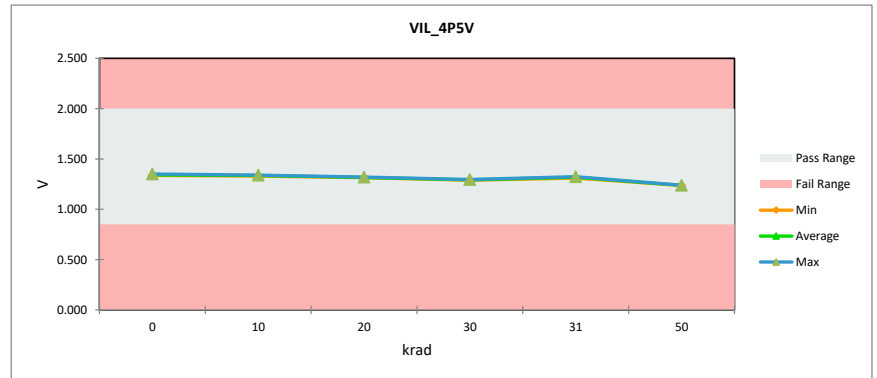

# TID Report

## SN54SC8T595-SEP

		VIL_5P5V				
		Units		V		
		Max Limit		2		
		Min Limit		0.85		
krad	Serial #	PreTestHDR	PostTestHDR	Delta	Delta %	% of Limit Range
0	1	1.521	1.521	0.00	0.00%	0.00%
0	2	1.532	1.532	0.00	0.00%	0.00%
0	3	1.521	1.525	0.00	0.23%	0.31%
0	4	1.528	1.521	-0.01	-0.46%	0.61%
10	5	1.528	1.514	-0.01	-0.93%	1.23%
10	6	1.525	1.521	0.00	-0.23%	0.31%
10	7	1.528	1.518	-0.01	-0.69%	0.92%
10	8	1.525	1.518	-0.01	-0.46%	0.61%
10	9	1.521	1.518	0.00	-0.23%	0.31%
20	10	1.525	1.500	-0.02	-1.62%	2.15%
20	11	1.525	1.504	-0.02	-1.39%	1.84%
20	12	1.525	1.500	-0.02	-1.62%	2.15%
20	13	1.514	1.504	-0.01	-0.70%	0.92%
20	14	1.525	1.497	-0.03	-1.85%	2.46%
30	15	1.521	1.479	-0.04	-2.79%	3.69%
30	16	1.518	1.479	-0.04	-2.56%	3.38%
30	17	1.528	1.479	-0.05	-3.24%	4.30%
30	18	1.514	1.472	-0.04	-2.80%	3.69%
30	19	1.518	1.475	-0.04	-2.80%	3.69%
30	20	1.514	1.472	-0.04	-2.80%	3.69%
31	15a	1.521	1.507	-0.01	-0.93%	1.23%
31	16a	1.518	1.504	-0.01	-0.93%	1.23%
31	17a	1.528	1.507	-0.02	-1.39%	1.84%
31	18a	1.514	1.493	-0.02	-1.40%	1.84%
31	19a	1.518	1.500	-0.02	-1.16%	1.54%
31	20a	1.514	1.493	-0.02	-1.40%	1.84%
50	21	1.514	1.426	-0.09	-5.84%	7.69%
50	22	1.518	1.429	-0.09	-5.82%	7.69%
50	23	1.518	1.426	-0.09	-6.06%	7.99%
50	24	1.528	1.429	-0.10	-6.48%	8.61%
50	25	1.514	1.426	-0.09	-5.84%	7.69%
	Max	1.532	1.532	0.00	0.23%	8.61%
	Average	1.522	1.492	-0.03	-1.95%	2.59%
	Min	1.514	1.426	-0.09	-6.48%	0.00%
	Std Dev	0.005	0.031	0.03	1.89%	2.47%

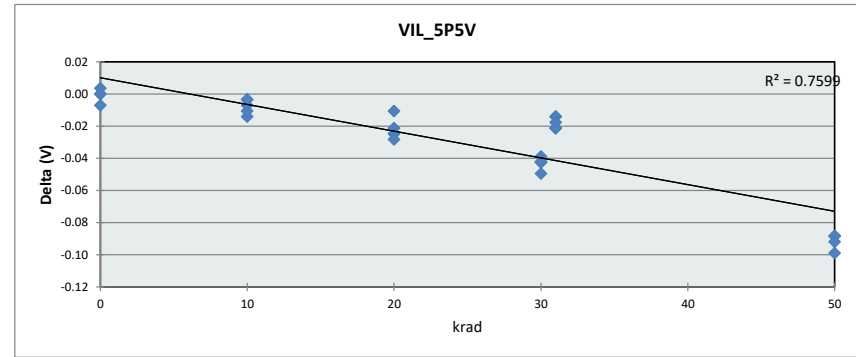

		VIL_5P5V					
		Units					
		Max Limit					
		Min Limit					
		0.85					
krad		0	10	20	30	31	50
LL		0.850	0.850	0.850	0.850	0.850	0.850
Min		1.521	1.514	1.497	1.472	1.493	1.426
Average		1.525	1.518	1.501	1.476	1.501	1.427
Max		1.532	1.521	1.504	1.479	1.507	1.429
UL		2.000	2.000	2.000	2.000	2.000	2.000

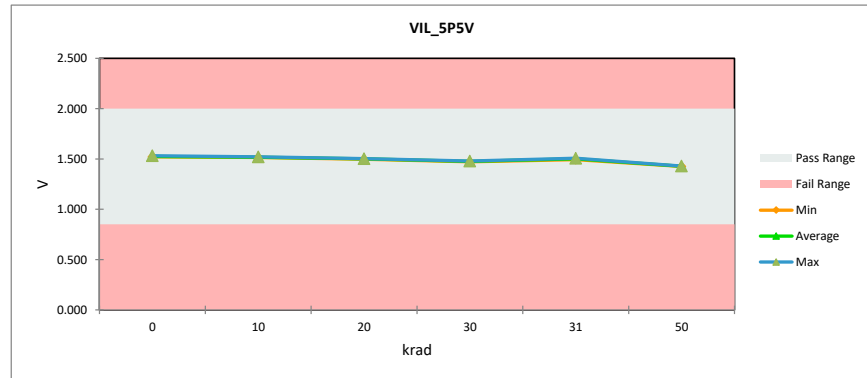



# TID Report

## SN54SC8T595-SEP

		VOH_N1MA_1P2V				
		Units		V		
		Max Limit		1.3		
		Min Limit		0.8		
krad	Serial #	PreTestHDR	PostTestHDR	Delta	Delta %	% of Limit Range
0	1	1.139	1.139	0.00	-0.01%	0.02%
0	2	1.139	1.139	0.00	-0.01%	0.01%
0	3	1.137	1.139	0.00	0.15%	0.33%
0	4	1.139	1.138	0.00	-0.03%	0.06%
10	5	1.136	1.136	0.00	-0.01%	0.01%
10	6	1.139	1.137	0.00	-0.20%	0.46%
10	7	1.139	1.138	0.00	-0.02%	0.04%
10	8	1.139	1.138	0.00	-0.01%	0.03%
10	9	1.136	1.136	0.00	-0.01%	0.02%
20	10	1.137	1.136	0.00	-0.03%	0.07%
20	11	1.137	1.137	0.00	-0.03%	0.07%
20	12	1.139	1.138	0.00	-0.03%	0.07%
20	13	1.137	1.136	0.00	-0.02%	0.04%
20	14	1.137	1.138	0.00	0.15%	0.34%
30	15	1.137	1.136	0.00	-0.03%	0.06%
30	16	1.139	1.138	0.00	-0.04%	0.10%
30	17	1.138	1.138	0.00	-0.04%	0.09%
30	18	1.137	1.137	0.00	-0.01%	0.02%
30	19	1.137	1.137	0.00	-0.03%	0.07%
30	20	1.137	1.136	0.00	-0.03%	0.08%
31	15a	1.137	1.137	0.00	-0.02%	0.04%
31	16a	1.139	1.138	0.00	-0.04%	0.10%
31	17a	1.138	1.138	0.00	-0.02%	0.04%
31	18a	1.137	1.137	0.00	-0.02%	0.05%
31	19a	1.137	1.137	0.00	-0.03%	0.08%
31	20a	1.137	1.137	0.00	-0.02%	0.05%
50	21	1.137	1.134	0.00	-0.24%	0.54%
50	22	1.137	1.134	0.00	-0.23%	0.53%
50	23	1.137	1.134	0.00	-0.24%	0.56%
50	24	1.137	1.134	0.00	-0.25%	0.57%
50	25	1.137	1.134	0.00	-0.20%	0.45%
	Max	1.139	1.139	0.00	0.15%	0.57%
	Average	1.137	1.137	0.00	-0.05%	0.15%
	Min	1.136	1.134	0.00	-0.25%	0.01%
	Std Dev	0.001	0.001	0.00	0.10%	0.19%

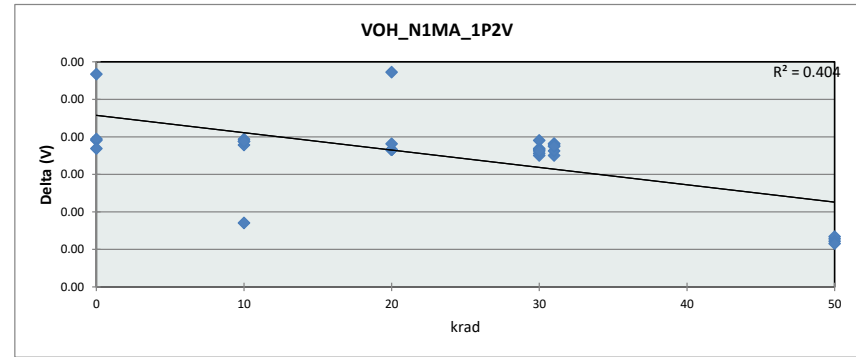

		VOH_N1MA_1P2V					
		Units		V			
		Max Limit		1.3			
		Min Limit		0.8			
krad		0	10	20	30	31	50
LL		0.800	0.800	0.800	0.800	0.800	0.800
Min		1.138	1.136	1.136	1.136	1.137	1.134
Average		1.139	1.137	1.137	1.137	1.137	1.134
Max		1.139	1.138	1.138	1.138	1.138	1.134
UL		1.300	1.300	1.300	1.300	1.300	1.300

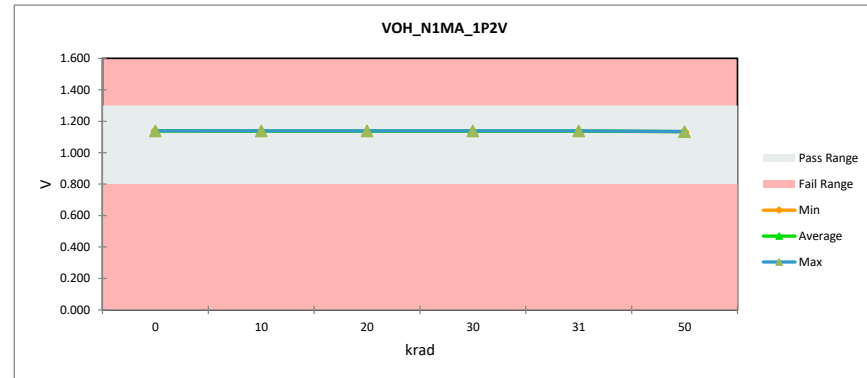

# TID Report SN54SC8T595-SEP

		VOH_N2MA_1P65V					
		Units		V			
		Max Limit		1.75			
		Min Limit		1.21			
krad	Serial #	PreTestHDR	PostTestHDR	Delta	Delta %	% of Limit Range	
0	1	1.570	1.570	0.00	0.01%	0.02%	
0	2	1.570	1.570	0.00	0.00%	0.01%	
0	3	1.566	1.570	0.00	0.20%	0.57%	
0	4	1.570	1.569	0.00	-0.01%	0.03%	
10	5	1.568	1.568	0.00	0.01%	0.02%	
10	6	1.570	1.566	0.00	-0.26%	0.76%	
10	7	1.570	1.570	0.00	-0.01%	0.02%	
10	8	1.570	1.570	0.00	0.01%	0.03%	
10	9	1.568	1.568	0.00	0.00%	0.01%	
20	10	1.568	1.568	0.00	0.01%	0.02%	
20	11	1.568	1.568	0.00	0.00%	0.01%	
20	12	1.570	1.570	0.00	0.00%	0.01%	
20	13	1.568	1.566	0.00	-0.12%	0.36%	
20	14	1.565	1.569	0.00	0.26%	0.74%	
30	15	1.568	1.568	0.00	0.01%	0.02%	
30	16	1.569	1.569	0.00	0.00%	0.00%	
30	17	1.569	1.569	0.00	-0.01%	0.04%	
30	18	1.568	1.568	0.00	0.02%	0.05%	
30	19	1.568	1.568	0.00	0.00%	0.01%	
30	20	1.568	1.568	0.00	0.01%	0.02%	
31	15a	1.568	1.568	0.00	0.01%	0.04%	
31	16a	1.569	1.569	0.00	0.00%	0.01%	
31	17a	1.569	1.569	0.00	0.01%	0.03%	
31	18a	1.568	1.568	0.00	-0.01%	0.02%	
31	19a	1.568	1.568	0.00	-0.01%	0.03%	
31	20a	1.568	1.568	0.00	-0.01%	0.04%	
50	21	1.568	1.566	0.00	-0.11%	0.32%	
50	22	1.568	1.567	0.00	-0.08%	0.24%	
50	23	1.568	1.566	0.00	-0.13%	0.37%	
50	24	1.568	1.566	0.00	-0.10%	0.29%	
50	25	1.568	1.567	0.00	-0.07%	0.20%	
	Max	1.570	1.570	0.00	0.26%	0.76%	
	Average	1.568	1.568	0.00	-0.01%	0.14%	
	Min	1.565	1.566	0.00	-0.26%	0.00%	
	Std Dev	0.001	0.001	0.00	0.09%	0.22%	

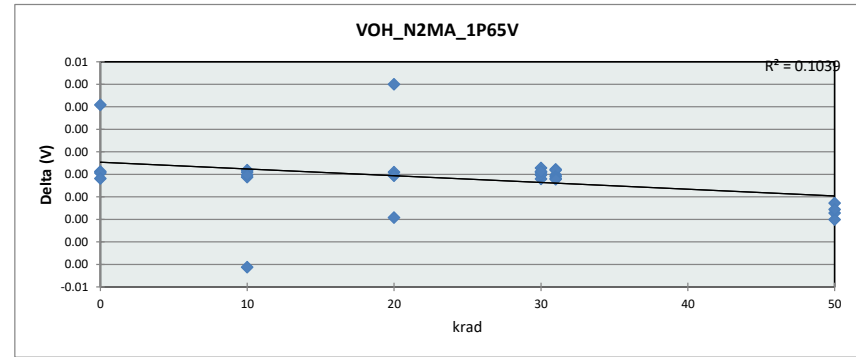

		VOH_N2MA_1P65V					
		Units		V			
		Max Limit		1.75			
		Min Limit		1.21			
krad		0	10	20	30	31	50
LL		1.210	1.210	1.210	1.210	1.210	1.210
Min		1.569	1.566	1.566	1.568	1.568	1.566
Average		1.570	1.568	1.568	1.569	1.568	1.566
Max		1.570	1.570	1.570	1.569	1.569	1.567
UL		1.750	1.750	1.750	1.750	1.750	1.750

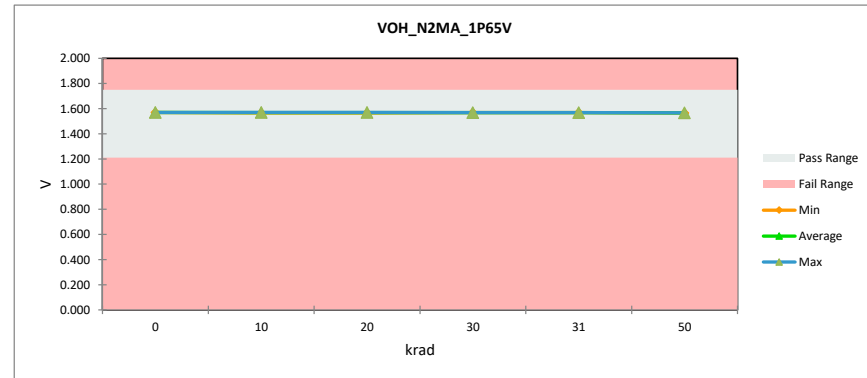

# TID Report SN54SC8T595-SEP

		VOH_N3MA_2P25V					
		Units		V			
		Max Limit		2.35			
		Min Limit		1.93			
krad	Serial #	PreTestHDR	PostTestHDR	Delta	Delta %	% of Limit Range	
0	1	2.158	2.158	0.00	0.00%	0.01%	
0	2	2.157	2.157	0.00	0.00%	0.02%	
0	3	2.152	2.157	0.01	0.24%	1.24%	
0	4	2.157	2.157	0.00	-0.01%	0.05%	
10	5	2.155	2.156	0.00	0.01%	0.04%	
10	6	2.157	2.151	-0.01	-0.28%	1.46%	
10	7	2.157	2.157	0.00	0.00%	0.00%	
10	8	2.157	2.157	0.00	0.01%	0.04%	
10	9	2.155	2.155	0.00	0.00%	0.00%	
20	10	2.155	2.155	0.00	0.02%	0.08%	
20	11	2.155	2.155	0.00	0.01%	0.04%	
20	12	2.157	2.157	0.00	0.00%	0.03%	
20	13	2.155	2.151	0.00	-0.18%	0.93%	
20	14	2.151	2.157	0.01	0.29%	1.46%	
30	15	2.155	2.155	0.00	0.01%	0.06%	
30	16	2.157	2.157	0.00	-0.01%	0.03%	
30	17	2.157	2.156	0.00	-0.04%	0.22%	
30	18	2.156	2.156	0.00	0.01%	0.07%	
30	19	2.156	2.156	0.00	0.01%	0.07%	
30	20	2.156	2.156	0.00	0.00%	0.00%	
31	15a	2.155	2.156	0.00	0.02%	0.11%	
31	16a	2.157	2.157	0.00	-0.01%	0.04%	
31	17a	2.157	2.157	0.00	0.01%	0.06%	
31	18a	2.156	2.156	0.00	0.00%	0.02%	
31	19a	2.156	2.156	0.00	0.00%	0.01%	
31	20a	2.156	2.156	0.00	0.00%	0.01%	
50	21	2.156	2.155	0.00	-0.05%	0.26%	
50	22	2.155	2.155	0.00	-0.04%	0.21%	
50	23	2.156	2.154	0.00	-0.07%	0.38%	
50	24	2.155	2.154	0.00	-0.06%	0.33%	
50	25	2.156	2.155	0.00	-0.04%	0.19%	
Max		2.158	2.158	0.00	0.29%	1.46%	
Average		2.156	2.156	0.00	0.00%	0.24%	
Min		2.151	2.151	0.00	-0.28%	0.00%	
Std Dev		0.001	0.002	0.00	0.10%	0.43%	

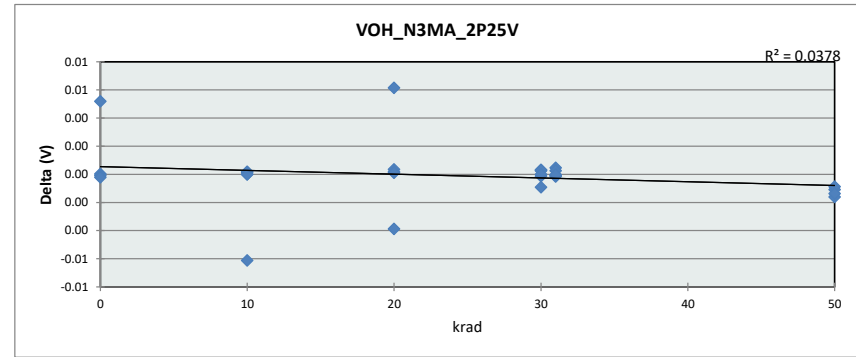

		VOH_N3MA_2P25V					
		Units		V			
		Max Limit		2.35			
		Min Limit		1.93			
krad		0	10	20	30	31	50
LL		1.930	1.930	1.930	1.930	1.930	1.930
Min		2.157	2.151	2.151	2.155	2.156	2.154
Average		2.157	2.155	2.155	2.156	2.156	2.154
Max		2.158	2.157	2.157	2.157	2.157	2.155
UL		2.350	2.350	2.350	2.350	2.350	2.350

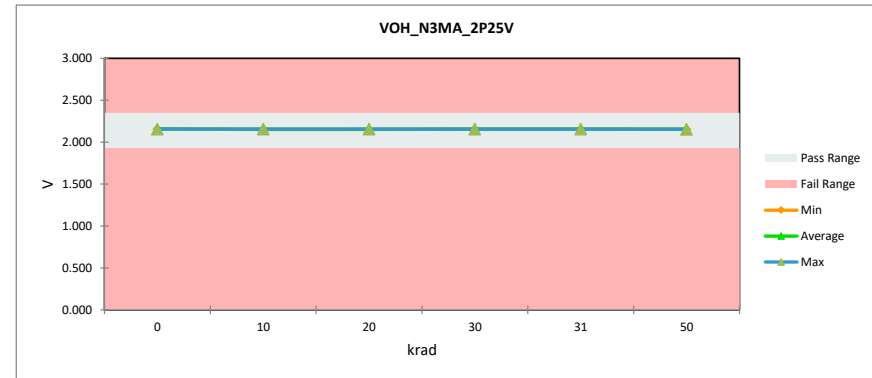

# TID Report SN54SC8T595-SEP

		VOH_N5P5MA_3V				
Units		V				
Max Limit		3.1				
Min Limit		2.49				
krad	Serial #	PreTestHDR	PostTestHDR	Delta	Delta %	% of Limit Range
0	1	2.856	2.856	0.00	0.00%	0.01%
0	2	2.856	2.856	0.00	0.00%	0.01%
0	3	2.846	2.856	0.01	0.33%	1.53%
0	4	2.855	2.855	0.00	-0.01%	0.04%
10	5	2.852	2.853	0.00	0.01%	0.07%
10	6	2.855	2.845	-0.01	-0.37%	1.72%
10	7	2.855	2.855	0.00	0.00%	0.01%
10	8	2.855	2.855	0.00	0.00%	0.01%
10	9	2.852	2.853	0.00	0.00%	0.01%
20	10	2.852	2.853	0.00	0.01%	0.04%
20	11	2.852	2.853	0.00	0.01%	0.03%
20	12	2.855	2.855	0.00	0.01%	0.03%
20	13	2.852	2.845	-0.01	-0.26%	1.22%
20	14	2.844	2.855	0.01	0.41%	1.93%
30	15	2.852	2.853	0.00	0.02%	0.09%
30	16	2.855	2.855	0.00	0.01%	0.05%
30	17	2.855	2.853	0.00	-0.07%	0.33%
30	18	2.854	2.854	0.00	0.02%	0.09%
30	19	2.854	2.854	0.00	0.02%	0.11%
30	20	2.854	2.854	0.00	0.00%	0.01%
31	15a	2.852	2.853	0.00	0.02%	0.09%
31	16a	2.855	2.855	0.00	0.00%	0.01%
31	17a	2.855	2.855	0.00	0.01%	0.04%
31	18a	2.854	2.854	0.00	0.00%	0.02%
31	19a	2.854	2.854	0.00	0.01%	0.03%
31	20a	2.854	2.853	0.00	-0.01%	0.04%
50	21	2.853	2.852	0.00	-0.03%	0.15%
50	22	2.853	2.852	0.00	-0.03%	0.12%
50	23	2.854	2.852	0.00	-0.05%	0.22%
50	24	2.852	2.851	0.00	-0.03%	0.15%
50	25	2.853	2.853	0.00	-0.02%	0.10%
Max		2.856	2.856	0.00	0.41%	1.93%
Average		2.853	2.853	0.00	0.00%	0.27%
Min		2.844	2.845	0.00	-0.37%	0.01%
Std Dev		0.003	0.003	0.00	0.13%	0.54%

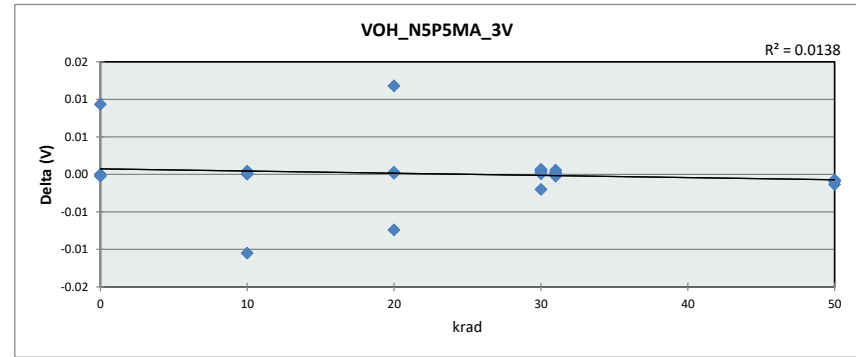

		VOH_N5P5MA_3V					
Units		V					
Max Limit		3.1					
Min Limit		2.49					
krad		0	10	20	30	31	50
LL		2.490	2.490	2.490	2.490	2.490	2.490
Min		2.855	2.845	2.845	2.853	2.853	2.851
Average		2.856	2.852	2.852	2.854	2.854	2.852
Max		2.856	2.855	2.855	2.855	2.855	2.853
UL		3.100	3.100	3.100	3.100	3.100	3.100

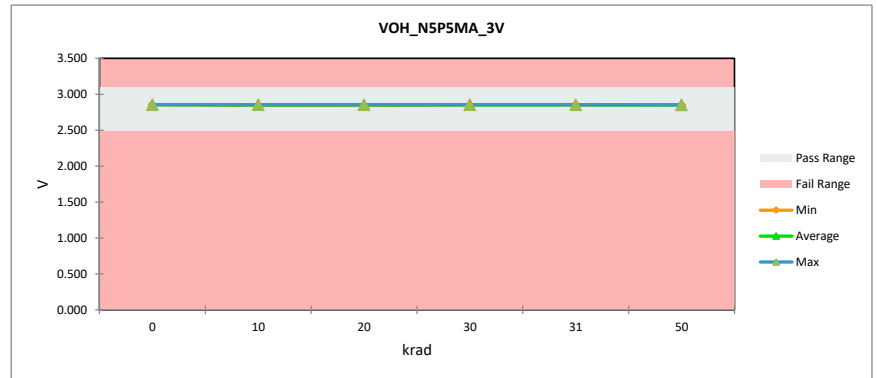

# TID Report

## SN54SC8T595-SEP

		VOH_N8MA_4P5V				
		Units		V		
		Max Limit		4.6		
		Min Limit		3.95		
krad	Serial #	PreTestHDR	PostTestHDR	Delta	Delta %	% of Limit Range
0	1	4.323	4.323	0.00	-0.01%	0.03%
0	2	4.323	4.323	0.00	0.00%	0.01%
0	3	4.309	4.322	0.01	0.32%	2.11%
0	4	4.322	4.322	0.00	-0.01%	0.08%
10	5	4.318	4.319	0.00	0.01%	0.05%
10	6	4.322	4.306	-0.02	-0.36%	2.41%
10	7	4.321	4.321	0.00	0.01%	0.07%
10	8	4.322	4.322	0.00	0.00%	0.03%
10	9	4.318	4.319	0.00	0.01%	0.03%
20	10	4.318	4.319	0.00	0.01%	0.09%
20	11	4.318	4.319	0.00	0.01%	0.07%
20	12	4.321	4.321	0.00	0.00%	0.03%
20	13	4.318	4.307	-0.01	-0.26%	1.74%
20	14	4.305	4.322	0.02	0.40%	2.65%
30	15	4.318	4.319	0.00	0.01%	0.08%
30	16	4.321	4.321	0.00	0.01%	0.07%
30	17	4.321	4.318	0.00	-0.08%	0.51%
30	18	4.320	4.321	0.00	0.01%	0.07%
30	19	4.320	4.321	0.00	0.01%	0.09%
30	20	4.320	4.320	0.00	0.00%	0.02%
31	15a	4.318	4.319	0.00	0.01%	0.09%
31	16a	4.321	4.321	0.00	0.00%	0.02%
31	17a	4.321	4.322	0.00	0.01%	0.07%
31	18a	4.320	4.320	0.00	0.00%	0.02%
31	19a	4.320	4.321	0.00	0.01%	0.03%
31	20a	4.320	4.320	0.00	0.00%	0.01%
50	21	4.320	4.319	0.00	-0.01%	0.09%
50	22	4.319	4.319	0.00	-0.01%	0.09%
50	23	4.320	4.319	0.00	-0.03%	0.21%
50	24	4.318	4.317	0.00	-0.02%	0.12%
50	25	4.320	4.319	0.00	-0.01%	0.06%
Max		4.323	4.323	0.00	0.40%	2.65%
Average		4.319	4.319	0.00	0.00%	0.37%
Min		4.305	4.306	0.00	-0.36%	0.01%
Std Dev		0.004	0.004	0.00	0.13%	0.76%

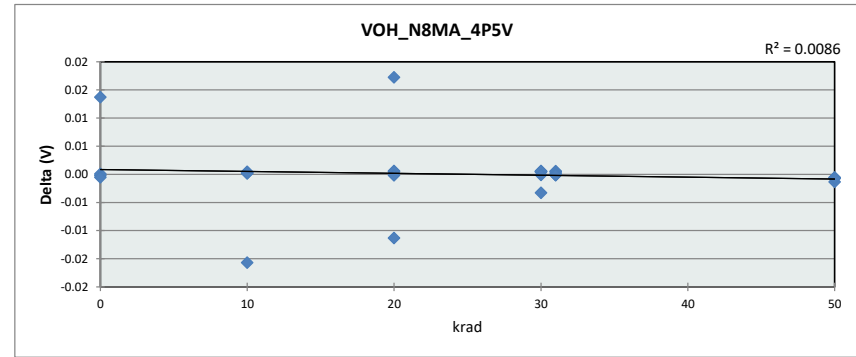

		VOH_N8MA_4P5V					
		Units					
		V					
		Max Limit					
		4.6					
		Min Limit					
		3.95					
krad		0	10	20	30	31	50
LL		3.950	3.950	3.950	3.950	3.950	3.950
Min		4.322	4.306	4.307	4.318	4.319	4.317
Average		4.322	4.317	4.317	4.320	4.320	4.319
Max		4.323	4.322	4.322	4.321	4.322	4.319
UL		4.600	4.600	4.600	4.600	4.600	4.600

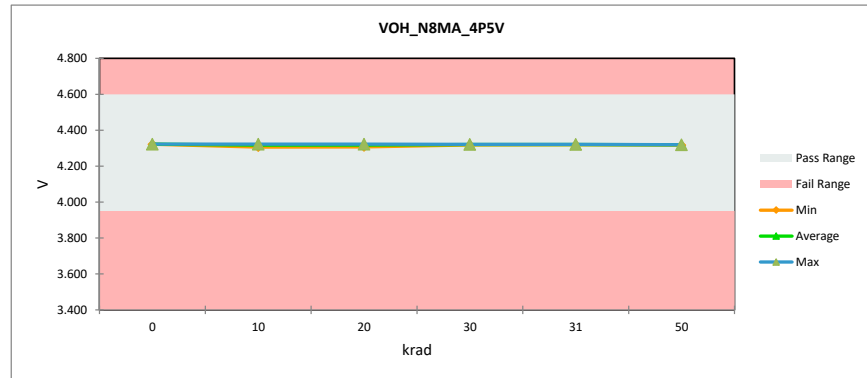

# TID Report SN54SC8T595-SEP

		VOH_N24MA_5P5V				
Units		V				
Max Limit		5.6				
Min Limit		3.15				
krad	Serial #	PreTestHDR	PostTestHDR	Delta	Delta %	% of Limit Range
0	1	4.991	4.991	0.00	0.00%	0.01%
0	2	4.990	4.990	0.00	0.00%	0.00%
0	3	4.948	4.990	0.04	0.85%	1.73%
0	4	4.990	4.988	0.00	-0.03%	0.06%
10	5	4.978	4.978	0.00	0.02%	0.04%
10	6	4.988	4.941	-0.05	-0.94%	1.90%
10	7	4.986	4.987	0.00	0.01%	0.03%
10	8	4.988	4.989	0.00	0.01%	0.03%
10	9	4.977	4.978	0.00	0.02%	0.03%
20	10	4.977	4.978	0.00	0.02%	0.05%
20	11	4.977	4.978	0.00	0.02%	0.04%
20	12	4.986	4.985	0.00	-0.01%	0.03%
20	13	4.977	4.941	-0.04	-0.71%	1.44%
20	14	4.937	4.988	0.05	1.04%	2.10%
30	15	4.977	4.978	0.00	0.03%	0.06%
30	16	4.985	4.986	0.00	0.02%	0.05%
30	17	4.986	4.977	-0.01	-0.19%	0.39%
30	18	4.984	4.985	0.00	0.02%	0.04%
30	19	4.984	4.985	0.00	0.03%	0.06%
30	20	4.983	4.982	0.00	-0.02%	0.04%
31	15a	4.977	4.978	0.00	0.02%	0.05%
31	16a	4.985	4.985	0.00	0.00%	0.01%
31	17a	4.986	4.987	0.00	0.02%	0.03%
31	18a	4.984	4.983	0.00	-0.01%	0.02%
31	19a	4.984	4.984	0.00	0.00%	0.00%
31	20a	4.983	4.983	0.00	-0.01%	0.03%
50	21	4.982	4.982	0.00	-0.01%	0.02%
50	22	4.980	4.980	0.00	0.00%	0.01%
50	23	4.984	4.983	0.00	-0.02%	0.04%
50	24	4.977	4.977	0.00	-0.01%	0.01%
50	25	4.982	4.981	0.00	-0.01%	0.01%
Max		4.991	4.991	0.00	1.04%	2.10%
Average		4.980	4.981	0.00	0.01%	0.28%
Min		4.937	4.941	0.00	-0.94%	0.00%
Std Dev		0.011	0.012	0.00	0.33%	0.61%

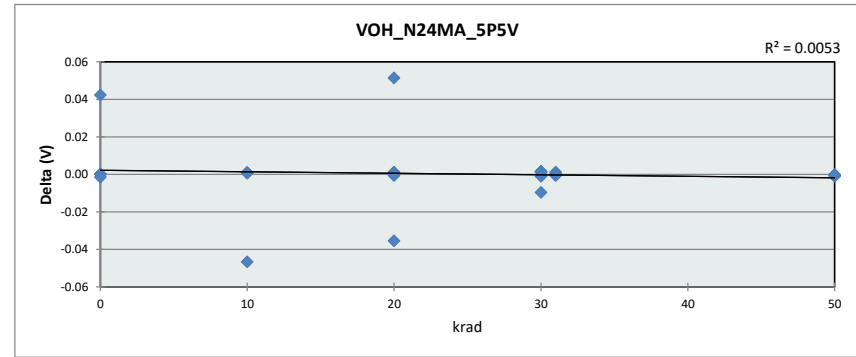

		VOH_N24MA_5P5V					
Units		V					
Max Limit		5.6					
Min Limit		3.15					
krad		0	10	20	30	31	50
LL		3.150	3.150	3.150	3.150	3.150	3.150
Min		4.988	4.941	4.941	4.977	4.978	4.977
Average		4.990	4.975	4.974	4.982	4.983	4.980
Max		4.991	4.989	4.988	4.986	4.987	4.983
UL		5.600	5.600	5.600	5.600	5.600	5.600

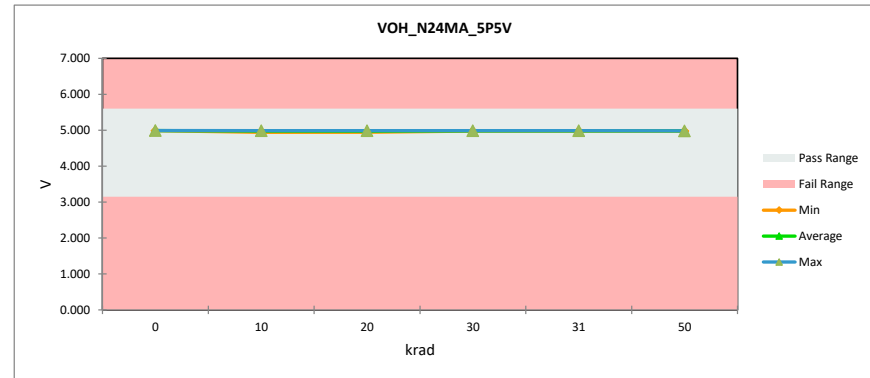

# TID Report

## SN54SC8T595-SEP

		VOH_N50UA_1P2V				
		Units		V		
		Max Limit		1.3		
		Min Limit		1		
krad	Serial #	PreTestHDR	PostTestHDR	Delta	Delta %	% of Limit Range
0	1	1.196	1.196	0.00	0.02%	0.06%
0	2	1.196	1.196	0.00	0.01%	0.03%
0	3	1.196	1.196	0.00	0.01%	0.02%
0	4	1.196	1.196	0.00	0.01%	0.04%
10	5	1.196	1.196	0.00	-0.01%	0.02%
10	6	1.196	1.196	0.00	0.00%	0.02%
10	7	1.196	1.196	0.00	0.01%	0.02%
10	8	1.196	1.196	0.00	0.00%	0.01%
10	9	1.196	1.196	0.00	-0.03%	0.10%
20	10	1.196	1.196	0.00	0.00%	0.01%
20	11	1.196	1.196	0.00	-0.01%	0.03%
20	12	1.196	1.196	0.00	0.00%	0.01%
20	13	1.196	1.196	0.00	-0.01%	0.06%
20	14	1.196	1.196	0.00	0.01%	0.03%
30	15	1.196	1.196	0.00	-0.02%	0.06%
30	16	1.196	1.196	0.00	0.00%	0.00%
30	17	1.196	1.196	0.00	0.01%	0.04%
30	18	1.196	1.196	0.00	0.02%	0.07%
30	19	1.196	1.196	0.00	0.01%	0.02%
30	20	1.196	1.196	0.00	-0.01%	0.05%
31	15a	1.196	1.196	0.00	0.00%	0.01%
31	16a	1.196	1.196	0.00	0.00%	0.01%
31	17a	1.196	1.196	0.00	0.02%	0.08%
31	18a	1.196	1.196	0.00	0.01%	0.05%
31	19a	1.196	1.196	0.00	0.00%	0.01%
31	20a	1.196	1.196	0.00	0.00%	0.01%
50	21	1.196	1.194	0.00	-0.19%	0.76%
50	22	1.196	1.193	0.00	-0.23%	0.90%
50	23	1.196	1.193	0.00	-0.29%	1.17%
50	24	1.196	1.194	0.00	-0.17%	0.69%
50	25	1.196	1.193	0.00	-0.23%	0.90%
Max		1.196	1.196	0.00	0.02%	1.17%
Average		1.196	1.196	0.00	-0.03%	0.15%
Min		1.196	1.193	0.00	-0.29%	0.00%
Std Dev		0.000	0.001	0.00	0.08%	0.30%

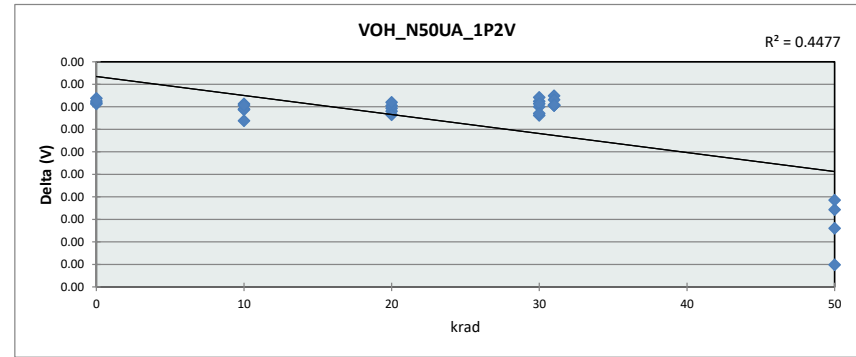

		VOH_N50UA_1P2V					
		Units					
		V					
		Max Limit					
		1.3					
		Min Limit					
		1					
krad		0	10	20	30	31	50
LL		1.000	1.000	1.000	1.000	1.000	1.000
Min		1.196	1.196	1.196	1.196	1.196	1.193
Average		1.196	1.196	1.196	1.196	1.196	1.194
Max		1.196	1.196	1.196	1.196	1.196	1.194
UL		1.300	1.300	1.300	1.300	1.300	1.300

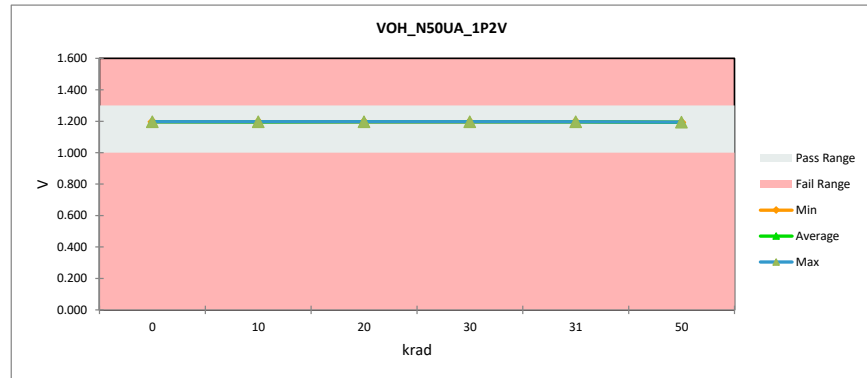

# TID Report SN54SC8T595-SEP

VOH_N50UA_5P5V						
Units	V					
Max Limit	5.6					
Min Limit	5.3					
krad	Serial #	PreTestHDR	PostTestHDR	Delta	Delta %	% of Limit Range
0	1	5.498	5.498	0.00	0.00%	0.08%
0	2	5.498	5.498	0.00	0.00%	0.01%
0	3	5.498	5.498	0.00	0.00%	0.00%
0	4	5.498	5.498	0.00	0.00%	0.01%
10	5	5.498	5.498	0.00	0.00%	0.02%
10	6	5.498	5.498	0.00	0.00%	0.00%
10	7	5.498	5.498	0.00	0.01%	0.09%
10	8	5.498	5.498	0.00	0.00%	0.05%
10	9	5.498	5.498	0.00	0.00%	0.04%
20	10	5.498	5.498	0.00	0.00%	0.02%
20	11	5.498	5.498	0.00	0.00%	0.04%
20	12	5.498	5.498	0.00	0.00%	0.03%
20	13	5.498	5.498	0.00	0.00%	0.01%
20	14	5.498	5.498	0.00	0.00%	0.05%
30	15	5.498	5.498	0.00	0.00%	0.03%
30	16	5.498	5.498	0.00	0.00%	0.03%
30	17	5.498	5.498	0.00	0.00%	0.01%
30	18	5.498	5.498	0.00	0.00%	0.05%
30	19	5.498	5.498	0.00	0.00%	0.03%
30	20	5.498	5.498	0.00	0.00%	0.01%
31	15a	5.498	5.498	0.00	0.00%	0.01%
31	16a	5.498	5.498	0.00	0.00%	0.03%
31	17a	5.498	5.498	0.00	0.00%	0.01%
31	18a	5.498	5.498	0.00	0.00%	0.03%
31	19a	5.498	5.498	0.00	0.00%	0.04%
31	20a	5.498	5.498	0.00	0.00%	0.00%
50	21	5.498	5.497	0.00	-0.02%	0.45%
50	22	5.498	5.497	0.00	-0.03%	0.55%
50	23	5.498	5.496	0.00	-0.03%	0.61%
50	24	5.498	5.497	0.00	-0.02%	0.40%
50	25	5.498	5.497	0.00	-0.02%	0.44%
Max		5.498	5.498	0.00	0.01%	0.61%
Average		5.498	5.498	0.00	0.00%	0.09%
Min		5.498	5.496	0.00	-0.03%	0.00%
Std Dev		0.000	0.001	0.00	0.01%	0.17%

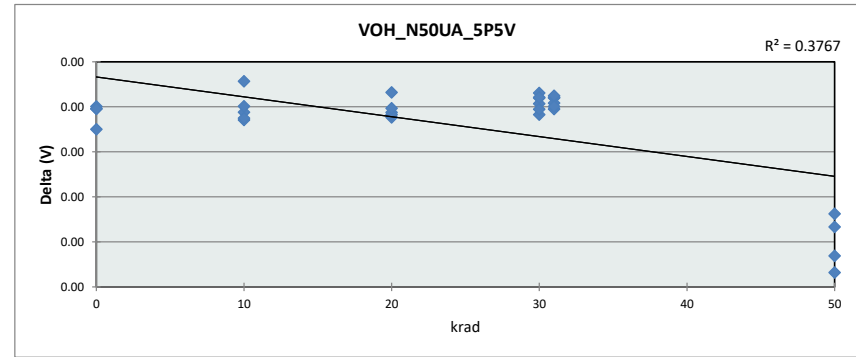

VOH_N50UA_5P5V						
Units	V					
Max Limit	5.6					
Min Limit	5.3					
krad	0	10	20	30	31	50
LL	5.300	5.300	5.300	5.300	5.300	5.300
Min	5.498	5.498	5.498	5.498	5.498	5.496
Average	5.498	5.498	5.498	5.498	5.498	5.497
Max	5.498	5.498	5.498	5.498	5.498	5.497
UL	5.600	5.600	5.600	5.600	5.600	5.600

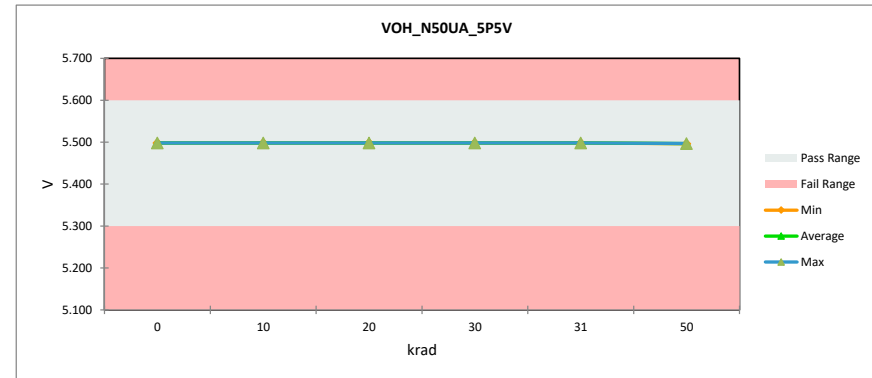



# TID Report SN54SC8T595-SEP

		VOL_1MA_1P2V				
		Units		V		
		Max Limit		0.2		
		Min Limit		-0.001		
krad	Serial #	PreTestHDR	PostTestHDR	Delta	Delta %	% of Limit Range
0	1	0.046	0.046	0.00	-0.39%	0.09%
0	2	0.046	0.046	0.00	-0.14%	0.03%
0	3	0.046	0.046	0.00	0.43%	0.10%
0	4	0.046	0.046	0.00	0.27%	0.06%
10	5	0.046	0.045	0.00	-0.82%	0.19%
10	6	0.045	0.045	0.00	-0.26%	0.06%
10	7	0.046	0.046	0.00	-0.68%	0.16%
10	8	0.046	0.046	0.00	-0.61%	0.14%
10	9	0.045	0.045	0.00	-0.05%	0.01%
20	10	0.045	0.045	0.00	-0.55%	0.12%
20	11	0.046	0.045	0.00	-0.75%	0.17%
20	12	0.046	0.045	0.00	-0.74%	0.17%
20	13	0.046	0.045	0.00	-0.82%	0.19%
20	14	0.045	0.045	0.00	-0.48%	0.11%
30	15	0.045	0.045	0.00	-1.24%	0.28%
30	16	0.046	0.045	0.00	-2.04%	0.46%
30	17	0.045	0.045	0.00	-1.03%	0.23%
30	18	0.045	0.045	0.00	-0.53%	0.12%
30	19	0.045	0.044	0.00	-1.11%	0.25%
30	20	0.045	0.045	0.00	-1.31%	0.30%
31	15a	0.045	0.045	0.00	-0.55%	0.12%
31	16a	0.046	0.045	0.00	-0.94%	0.21%
31	17a	0.045	0.045	0.00	-0.48%	0.11%
31	18a	0.045	0.045	0.00	-0.07%	0.02%
31	19a	0.045	0.045	0.00	-0.14%	0.03%
31	20a	0.045	0.045	0.00	-0.48%	0.11%
50	21	0.045	0.044	0.00	-1.45%	0.33%
50	22	0.045	0.045	0.00	-0.95%	0.21%
50	23	0.045	0.044	0.00	-0.91%	0.20%
50	24	0.046	0.045	0.00	-1.92%	0.44%
50	25	0.045	0.044	0.00	-1.45%	0.33%
	Max	0.046	0.046	0.00	0.43%	0.46%
	Average	0.045	0.045	0.00	-0.69%	0.17%
	Min	0.045	0.044	0.00	-2.04%	0.01%
	Std Dev	0.000	0.000	0.00	0.56%	0.11%

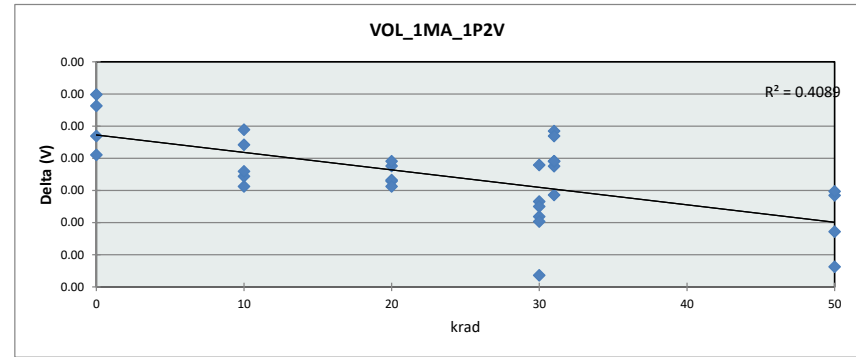

		VOL_1MA_1P2V					
		Units		V			
		Max Limit		0.2			
		Min Limit		-0.001			
krad		0	10	20	30	31	50
LL		-0.001	-0.001	-0.001	-0.001	-0.001	-0.001
Min		0.046	0.045	0.045	0.044	0.045	0.044
Average		0.046	0.045	0.045	0.045	0.045	0.045
Max		0.046	0.046	0.045	0.045	0.045	0.045
UL		0.200	0.200	0.200	0.200	0.200	0.200

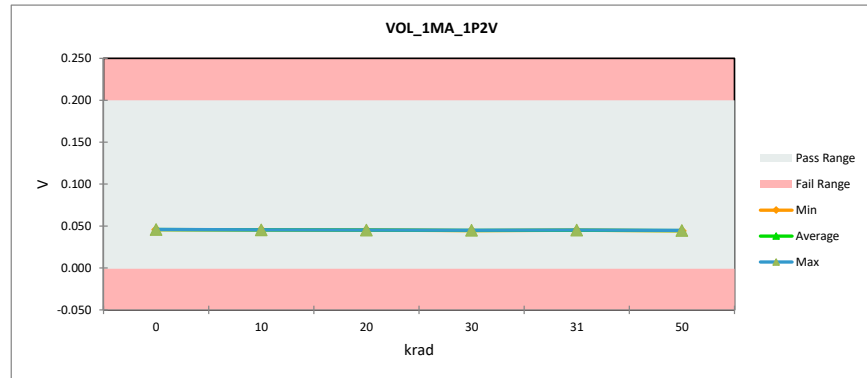

# TID Report SN54SC8T595-SEP

		VOL_2MA_1P65V				
		Units		V		
		Max Limit		0.25		
		Min Limit		-0.001		
krad	Serial #	PreTestHDR	PostTestHDR	Delta	Delta %	% of Limit Range
0	1	0.058	0.058	0.00	-0.16%	0.04%
0	2	0.058	0.058	0.00	0.05%	0.01%
0	3	0.058	0.058	0.00	0.33%	0.07%
0	4	0.058	0.058	0.00	0.38%	0.09%
10	5	0.058	0.058	0.00	-0.22%	0.05%
10	6	0.057	0.057	0.00	-0.20%	0.05%
10	7	0.057	0.058	0.00	0.23%	0.05%
10	8	0.058	0.058	0.00	-0.42%	0.10%
10	9	0.058	0.058	0.00	0.05%	0.01%
20	10	0.057	0.057	0.00	-0.05%	0.01%
20	11	0.058	0.058	0.00	-0.38%	0.09%
20	12	0.058	0.058	0.00	-0.42%	0.10%
20	13	0.058	0.058	0.00	0.00%	0.00%
20	14	0.058	0.058	0.00	-0.22%	0.05%
30	15	0.057	0.057	0.00	-0.71%	0.16%
30	16	0.058	0.057	0.00	-0.60%	0.14%
30	17	0.058	0.057	0.00	-0.71%	0.16%
30	18	0.058	0.057	0.00	-0.69%	0.16%
30	19	0.058	0.057	0.00	-0.98%	0.22%
30	20	0.058	0.058	0.00	-0.49%	0.11%
31	15a	0.057	0.057	0.00	-0.05%	0.01%
31	16a	0.058	0.057	0.00	-0.43%	0.10%
31	17a	0.058	0.058	0.00	0.05%	0.01%
31	18a	0.058	0.058	0.00	-0.15%	0.03%
31	19a	0.058	0.057	0.00	-0.27%	0.06%
31	20a	0.058	0.058	0.00	0.00%	0.00%
50	21	0.058	0.058	0.00	-0.59%	0.14%
50	22	0.058	0.057	0.00	-0.60%	0.14%
50	23	0.058	0.057	0.00	-0.37%	0.08%
50	24	0.057	0.057	0.00	-0.44%	0.10%
50	25	0.058	0.058	0.00	-0.56%	0.13%
	Max	0.058	0.058	0.00	0.38%	0.22%
	Average	0.058	0.057	0.00	-0.27%	0.08%
	Min	0.057	0.057	0.00	-0.98%	0.00%
	Std Dev	0.000	0.000	0.00	0.33%	0.06%

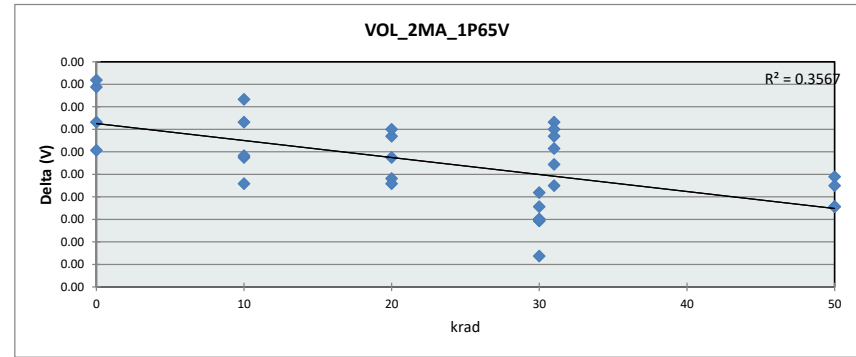

		VOL_2MA_1P65V					
		Units		V			
		Max Limit		0.25			
		Min Limit		-0.001			
krad		0	10	20	30	31	50
LL		-0.001	-0.001	-0.001	-0.001	-0.001	-0.001
Min		0.058	0.057	0.057	0.057	0.057	0.057
Average		0.058	0.058	0.058	0.057	0.058	0.057
Max		0.058	0.058	0.058	0.058	0.058	0.058
UL		0.250	0.250	0.250	0.250	0.250	0.250

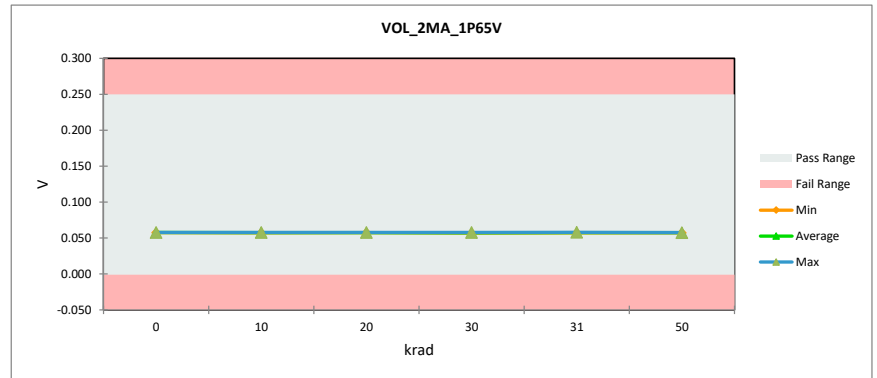

# TID Report SN54SC8T595-SEP

		VOL_3MA_2P25V				
		Units		V		
		Max Limit		0.2		
		Min Limit		-0.001		
krad	Serial #	PreTestHDR	PostTestHDR	Delta	Delta %	% of Limit Range
0	1	0.067	0.067	0.00	-0.14%	0.05%
0	2	0.067	0.067	0.00	0.00%	0.00%
0	3	0.067	0.067	0.00	0.34%	0.11%
0	4	0.067	0.067	0.00	0.09%	0.03%
10	5	0.067	0.067	0.00	-0.09%	0.03%
10	6	0.067	0.067	0.00	-0.28%	0.09%
10	7	0.067	0.067	0.00	0.19%	0.06%
10	8	0.067	0.067	0.00	-0.08%	0.03%
10	9	0.067	0.067	0.00	-0.23%	0.08%
20	10	0.067	0.067	0.00	0.28%	0.09%
20	11	0.067	0.067	0.00	-0.42%	0.14%
20	12	0.067	0.067	0.00	-0.55%	0.18%
20	13	0.067	0.067	0.00	-0.37%	0.12%
20	14	0.067	0.067	0.00	-0.09%	0.03%
30	15	0.066	0.066	0.00	-0.33%	0.11%
30	16	0.067	0.066	0.00	-0.47%	0.16%
30	17	0.067	0.067	0.00	-0.37%	0.12%
30	18	0.067	0.067	0.00	-0.47%	0.16%
30	19	0.067	0.067	0.00	-0.65%	0.22%
30	20	0.068	0.067	0.00	-0.88%	0.30%
31	15a	0.066	0.066	0.00	0.24%	0.08%
31	16a	0.067	0.067	0.00	0.24%	0.08%
31	17a	0.067	0.067	0.00	0.05%	0.02%
31	18a	0.067	0.067	0.00	-0.14%	0.05%
31	19a	0.067	0.067	0.00	-0.28%	0.09%
31	20a	0.068	0.067	0.00	-0.05%	0.02%
50	21	0.068	0.067	0.00	-0.51%	0.17%
50	22	0.067	0.067	0.00	-0.70%	0.23%
50	23	0.067	0.067	0.00	-0.65%	0.22%
50	24	0.067	0.066	0.00	-0.42%	0.14%
50	25	0.067	0.067	0.00	-0.47%	0.16%
	Max	0.068	0.067	0.00	0.34%	0.30%
	Average	0.067	0.067	0.00	-0.23%	0.11%
	Min	0.066	0.066	0.00	-0.88%	0.00%
	Std Dev	0.000	0.000	0.00	0.32%	0.07%

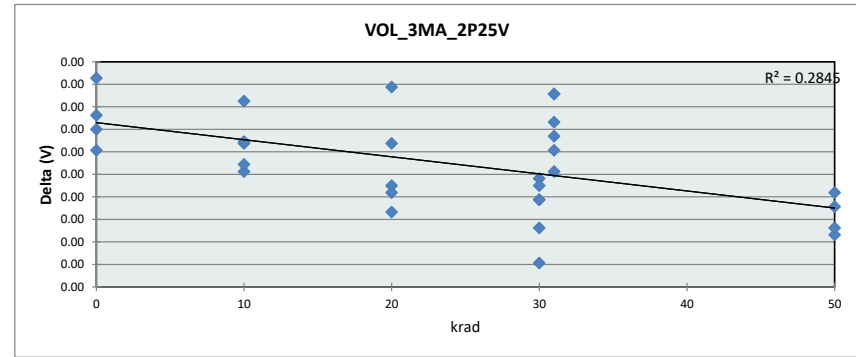

		VOL_3MA_2P25V					
		Units		V			
		Max Limit		0.2			
		Min Limit		-0.001			
krad		0	10	20	30	31	50
LL		-0.001	-0.001	-0.001	-0.001	-0.001	-0.001
Min		0.067	0.067	0.067	0.066	0.066	0.066
Average		0.067	0.067	0.067	0.067	0.067	0.067
Max		0.067	0.067	0.067	0.067	0.067	0.067
UL		0.200	0.200	0.200	0.200	0.200	0.200

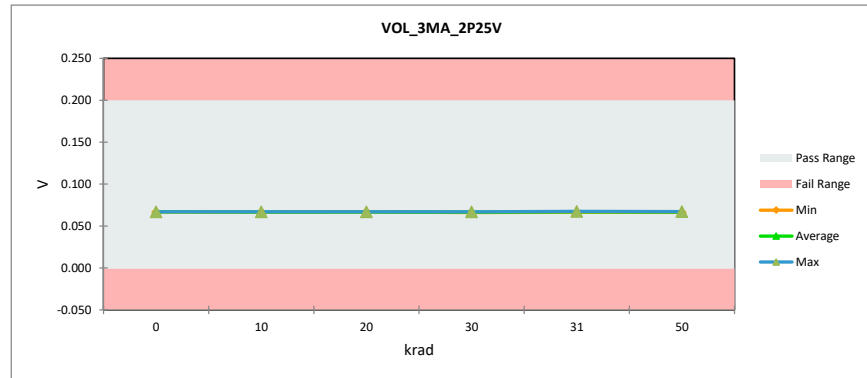

# TID Report SN54SC8T595-SEP

VOL_5P5MA_3V						
Units	V					
Max Limit	0.25					
Min Limit	-0.001					
krad	Serial #	PreTestHDR	PostTestHDR	Delta	Delta %	% of Limit Range
0	1	0.105	0.105	0.00	-0.06%	0.02%
0	2	0.105	0.105	0.00	0.09%	0.04%
0	3	0.105	0.105	0.00	-0.06%	0.02%
0	4	0.105	0.105	0.00	0.15%	0.06%
10	5	0.105	0.105	0.00	-0.18%	0.07%
10	6	0.105	0.105	0.00	0.06%	0.02%
10	7	0.105	0.105	0.00	-0.06%	0.02%
10	8	0.105	0.105	0.00	-0.24%	0.10%
10	9	0.105	0.105	0.00	-0.03%	0.01%
20	10	0.105	0.105	0.00	-0.24%	0.10%
20	11	0.105	0.105	0.00	-0.18%	0.07%
20	12	0.106	0.105	0.00	-0.27%	0.11%
20	13	0.105	0.105	0.00	-0.06%	0.02%
20	14	0.105	0.105	0.00	-0.38%	0.16%
30	15	0.104	0.104	0.00	-0.36%	0.15%
30	16	0.105	0.104	0.00	-0.39%	0.16%
30	17	0.105	0.105	0.00	-0.45%	0.19%
30	18	0.106	0.105	0.00	-0.47%	0.20%
30	19	0.105	0.105	0.00	-0.44%	0.19%
30	20	0.106	0.105	0.00	-0.59%	0.25%
31	15a	0.104	0.104	0.00	0.00%	0.00%
31	16a	0.105	0.104	0.00	-0.18%	0.07%
31	17a	0.105	0.105	0.00	-0.18%	0.07%
31	18a	0.106	0.106	0.00	-0.27%	0.11%
31	19a	0.105	0.105	0.00	-0.33%	0.14%
31	20a	0.106	0.106	0.00	-0.03%	0.01%
50	21	0.106	0.105	0.00	-0.44%	0.19%
50	22	0.106	0.105	0.00	-0.41%	0.17%
50	23	0.106	0.105	0.00	-0.44%	0.19%
50	24	0.105	0.104	0.00	-0.33%	0.14%
50	25	0.105	0.105	0.00	-0.36%	0.15%
	Max	0.106	0.106	0.00	0.15%	0.25%
	Average	0.105	0.105	0.00	-0.23%	0.10%
	Min	0.104	0.104	0.00	-0.59%	0.00%
	Std Dev	0.000	0.000	0.00	0.19%	0.07%

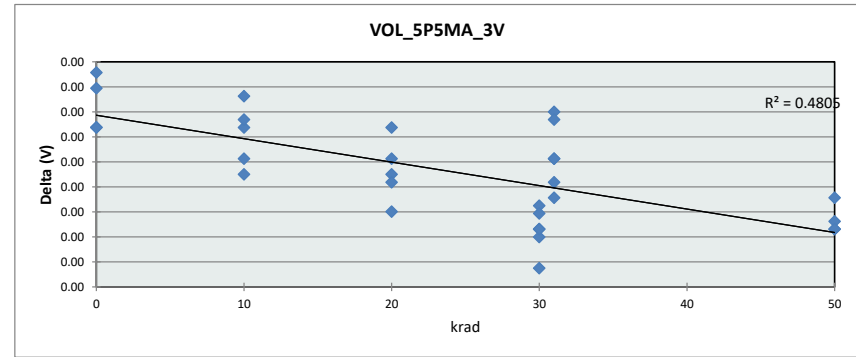

VOL_5P5MA_3V						
Units	V					
Max Limit	0.25					
Min Limit	-0.001					
krad	0	10	20	30	31	50
LL	-0.001	-0.001	-0.001	-0.001	-0.001	-0.001
Min	0.105	0.105	0.105	0.104	0.104	0.104
Average	0.105	0.105	0.105	0.105	0.105	0.105
Max	0.105	0.105	0.105	0.105	0.106	0.105
UL	0.250	0.250	0.250	0.250	0.250	0.250

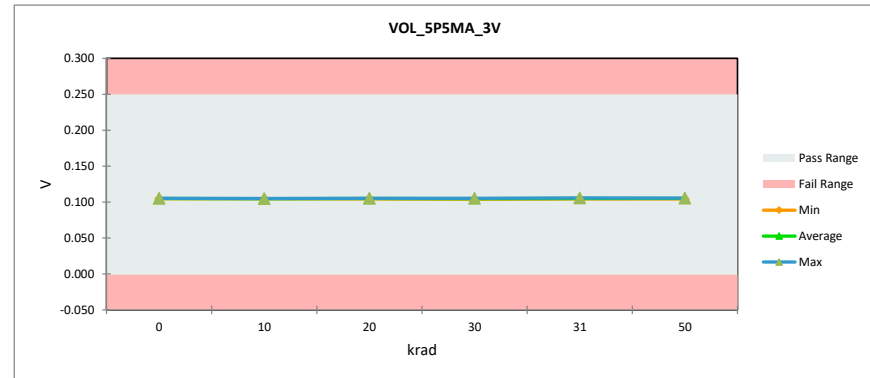

# TID Report SN54SC8T595-SEP

		VOL_8MA_4P5V					
		Units		V			
		Max Limit		0.35			
		Min Limit		-0.001			
krad	Serial #	PreTestHDR	PostTestHDR	Delta	Delta %	% of Limit Range	
0	1	0.132	0.132	0.00	0.00%	0.00%	
0	2	0.133	0.133	0.00	0.11%	0.04%	
0	3	0.133	0.133	0.00	0.02%	0.01%	
0	4	0.132	0.133	0.00	0.14%	0.05%	
10	5	0.133	0.132	0.00	-0.14%	0.05%	
10	6	0.132	0.132	0.00	-0.19%	0.07%	
10	7	0.133	0.133	0.00	-0.19%	0.07%	
10	8	0.133	0.133	0.00	-0.14%	0.05%	
10	9	0.133	0.133	0.00	-0.09%	0.04%	
20	10	0.132	0.132	0.00	-0.02%	0.01%	
20	11	0.133	0.133	0.00	0.05%	0.02%	
20	12	0.133	0.133	0.00	-0.12%	0.04%	
20	13	0.134	0.133	0.00	-0.09%	0.04%	
20	14	0.133	0.132	0.00	-0.38%	0.14%	
30	15	0.132	0.132	0.00	-0.40%	0.15%	
30	16	0.132	0.132	0.00	-0.33%	0.12%	
30	17	0.133	0.133	0.00	-0.33%	0.12%	
30	18	0.134	0.133	0.00	-0.30%	0.12%	
30	19	0.133	0.133	0.00	-0.35%	0.13%	
30	20	0.134	0.133	0.00	-0.37%	0.14%	
31	15a	0.132	0.132	0.00	-0.14%	0.05%	
31	16a	0.132	0.132	0.00	-0.05%	0.02%	
31	17a	0.133	0.133	0.00	0.02%	0.01%	
31	18a	0.134	0.134	0.00	-0.05%	0.02%	
31	19a	0.133	0.133	0.00	-0.30%	0.12%	
31	20a	0.134	0.134	0.00	-0.05%	0.02%	
50	21	0.134	0.133	0.00	-0.16%	0.06%	
50	22	0.134	0.133	0.00	-0.33%	0.12%	
50	23	0.134	0.133	0.00	-0.30%	0.12%	
50	24	0.133	0.132	0.00	-0.33%	0.12%	
50	25	0.133	0.133	0.00	-0.24%	0.09%	
Max		0.134	0.134	0.00	0.14%	0.15%	
Average		0.133	0.133	0.00	-0.16%	0.07%	
Min		0.132	0.132	0.00	-0.40%	0.00%	
Std Dev		0.001	0.001	0.00	0.16%	0.05%	

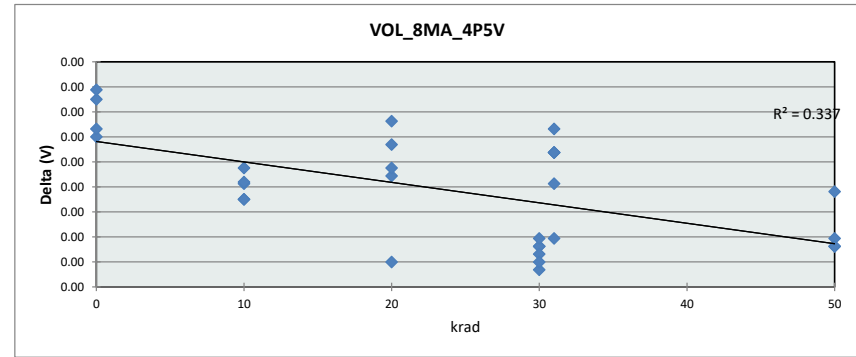

		VOL_8MA_4P5V					
		Units		V			
		Max Limit		0.35			
		Min Limit		-0.001			
krad		0	10	20	30	31	50
LL		-0.001	-0.001	-0.001	-0.001	-0.001	-0.001
Min		0.132	0.132	0.132	0.132	0.132	0.132
Average		0.133	0.133	0.133	0.133	0.133	0.133
Max		0.133	0.133	0.133	0.133	0.134	0.133
UL		0.350	0.350	0.350	0.350	0.350	0.350

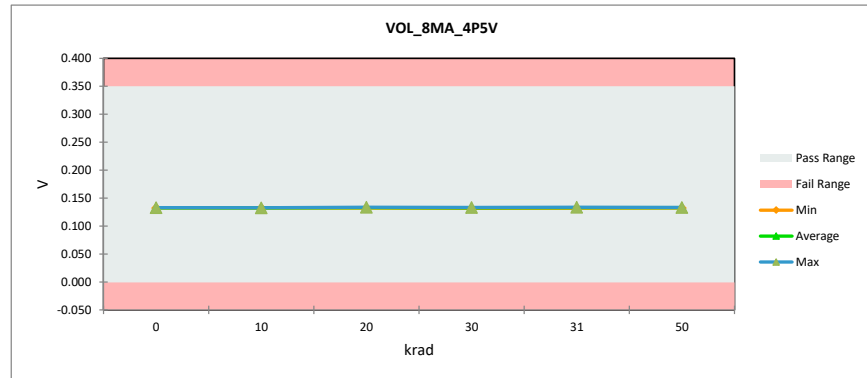

# TID Report SN54SC8T595-SEP

		VOL_24MA_5P5V				
		Units		V		
		Max Limit		0.75		
		Min Limit		-0.001		
krad	Serial #	PreTestHDR	PostTestHDR	Delta	Delta %	% of Limit Range
0	1	0.383	0.382	0.00	-0.11%	0.06%
0	2	0.384	0.384	0.00	0.06%	0.03%
0	3	0.383	0.383	0.00	0.05%	0.02%
0	4	0.383	0.383	0.00	0.05%	0.02%
10	5	0.384	0.383	0.00	-0.16%	0.08%
10	6	0.383	0.382	0.00	-0.19%	0.10%
10	7	0.385	0.384	0.00	-0.18%	0.09%
10	8	0.384	0.383	0.00	-0.29%	0.15%
10	9	0.384	0.383	0.00	-0.18%	0.09%
20	10	0.383	0.382	0.00	-0.08%	0.04%
20	11	0.386	0.385	0.00	-0.21%	0.11%
20	12	0.386	0.385	0.00	-0.20%	0.10%
20	13	0.386	0.386	0.00	-0.15%	0.07%
20	14	0.384	0.383	0.00	-0.32%	0.16%
30	15	0.382	0.381	0.00	-0.28%	0.14%
30	16	0.383	0.381	0.00	-0.31%	0.16%
30	17	0.384	0.383	0.00	-0.24%	0.12%
30	18	0.387	0.385	0.00	-0.38%	0.20%
30	19	0.386	0.384	0.00	-0.32%	0.17%
30	20	0.386	0.385	0.00	-0.39%	0.20%
31	15a	0.382	0.382	0.00	-0.01%	0.00%
31	16a	0.383	0.382	0.00	-0.08%	0.04%
31	17a	0.384	0.384	0.00	0.01%	0.00%
31	18a	0.387	0.386	0.00	-0.17%	0.09%
31	19a	0.386	0.385	0.00	-0.18%	0.09%
31	20a	0.386	0.386	0.00	-0.06%	0.03%
50	21	0.387	0.385	0.00	-0.37%	0.19%
50	22	0.387	0.385	0.00	-0.46%	0.24%
50	23	0.387	0.385	0.00	-0.29%	0.15%
50	24	0.383	0.382	0.00	-0.37%	0.19%
50	25	0.385	0.384	0.00	-0.37%	0.19%
	Max	0.387	0.386	0.00	0.06%	0.24%
	Average	0.385	0.384	0.00	-0.19%	0.11%
	Min	0.382	0.381	0.00	-0.46%	0.20%
	Std Dev	0.002	0.001	0.00	0.14%	0.06%

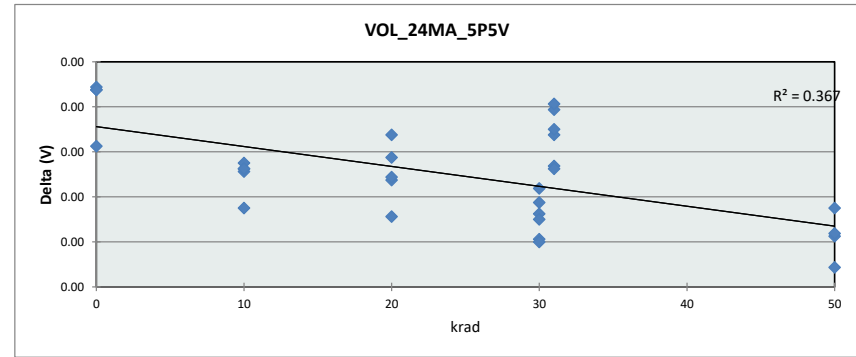

		VOL_24MA_5P5V					
		Units		V			
		Max Limit		0.75			
		Min Limit		-0.001			
krad		0	10	20	30	31	50
LL		-0.001	-0.001	-0.001	-0.001	-0.001	-0.001
Min		0.382	0.382	0.382	0.381	0.382	0.382
Average		0.383	0.383	0.384	0.383	0.384	0.384
Max		0.384	0.384	0.386	0.385	0.386	0.385
UL		0.750	0.750	0.750	0.750	0.750	0.750

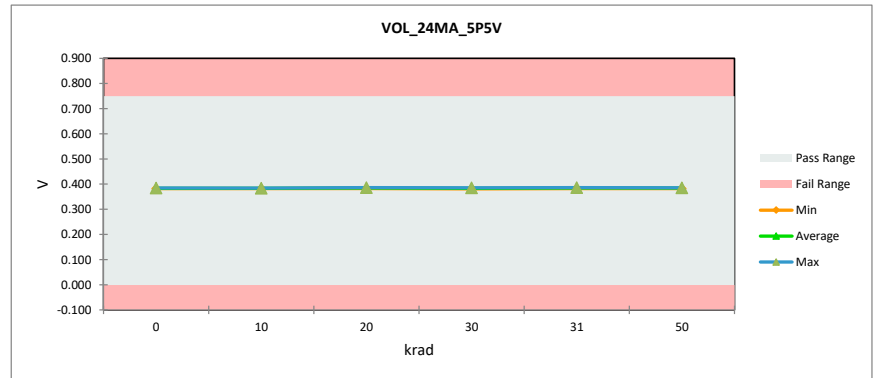

# TID Report

## SN54SC8T595-SEP

		VOL_50UA_1P2V				
		Units		V		
		Max Limit		0.1		
		Min Limit		-0.001		
krad	Serial #	PreTestHDR	PostTestHDR	Delta	Delta %	% of Limit Range
0	1	0.002	0.002	0.00	31.02%	0.50%
0	2	0.002	0.002	0.00	-4.64%	0.09%
0	3	0.002	0.002	0.00	-0.52%	0.01%
0	4	0.002	0.002	0.00	10.42%	0.20%
10	5	0.002	0.002	0.00	17.15%	0.30%
10	6	0.002	0.002	0.00	8.85%	0.16%
10	7	0.002	0.002	0.00	12.38%	0.22%
10	8	0.002	0.002	0.00	10.25%	0.19%
10	9	0.002	0.002	0.00	18.33%	0.31%
20	10	0.002	0.002	0.00	10.46%	0.20%
20	11	0.002	0.002	0.00	16.85%	0.30%
20	12	0.002	0.002	0.00	14.40%	0.25%
20	13	0.002	0.002	0.00	25.21%	0.40%
20	14	0.002	0.002	0.00	12.27%	0.23%
30	15	0.002	0.002	0.00	8.01%	0.15%
30	16	0.002	0.002	0.00	22.11%	0.37%
30	17	0.002	0.002	0.00	10.25%	0.19%
30	18	0.002	0.002	0.00	16.95%	0.29%
30	19	0.002	0.002	0.00	6.96%	0.12%
30	20	0.002	0.002	0.00	-4.31%	0.08%
31	15a	0.002	0.002	0.00	4.96%	0.09%
31	16a	0.002	0.002	0.00	24.27%	0.40%
31	17a	0.002	0.002	0.00	11.96%	0.22%
31	18a	0.002	0.002	0.00	18.00%	0.31%
31	19a	0.002	0.002	0.00	10.43%	0.19%
31	20a	0.002	0.002	0.00	4.39%	0.08%
50	21	0.002	0.002	0.00	4.95%	0.09%
50	22	0.002	0.002	0.00	10.43%	0.19%
50	23	0.002	0.002	0.00	24.43%	0.41%
50	24	0.002	0.002	0.00	19.80%	0.34%
50	25	0.002	0.002	0.00	10.25%	0.19%
	Max	0.002	0.002	0.00	31.02%	0.50%
	Average	0.002	0.002	0.00	12.53%	0.23%
	Min	0.002	0.002	0.00	-4.64%	0.01%
	Std Dev	0.000	0.000	0.00	8.46%	0.12%

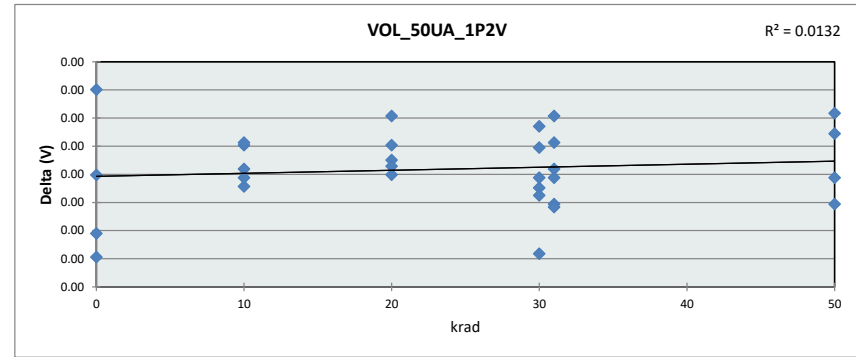

		VOL_50UA_1P2V					
		Units		V			
		Max Limit		0.1			
		Min Limit		-0.001			
krad		0	10	20	30	31	50
LL		-0.001	-0.001	-0.001	-0.001	-0.001	-0.001
Min		0.002	0.002	0.002	0.002	0.002	0.002
Average		0.002	0.002	0.002	0.002	0.002	0.002
Max		0.002	0.002	0.002	0.002	0.002	0.002
UL		0.100	0.100	0.100	0.100	0.100	0.100

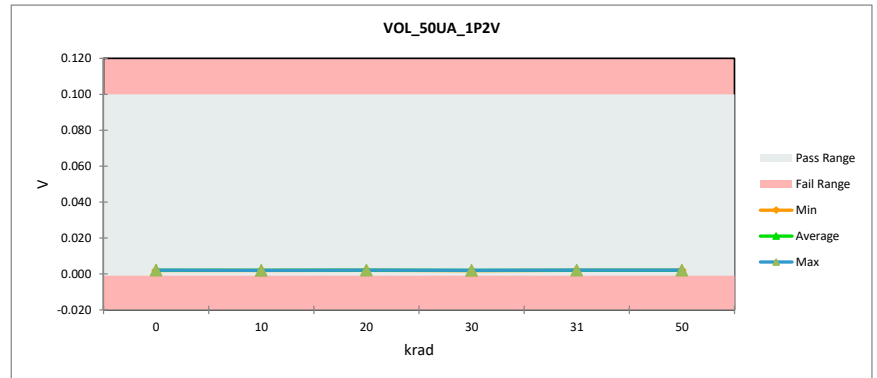

# TID Report SN54SC8T595-SEP

		VOL_50UA_5P5V				
		Units		V		
		Max Limit		0.1		
		Min Limit		-0.001		
krad	Serial #	PreTestHDR	PostTestHDR	Delta	Delta %	% of Limit Range
0	1	0.001	0.001	0.00	-0.07%	0.00%
0	2	0.001	0.001	0.00	26.12%	0.13%
0	3	0.000	0.001	0.00	175.02%	0.41%
0	4	0.001	0.001	0.00	32.15%	0.17%
10	5	0.000	0.001	0.00	41.20%	0.19%
10	6	0.001	0.001	0.00	28.60%	0.16%
10	7	0.000	0.001	0.00	75.94%	0.32%
10	8	0.001	0.001	0.00	14.54%	0.09%
10	9	0.000	0.001	0.00	43.41%	0.20%
20	10	0.001	0.001	0.00	16.96%	0.09%
20	11	0.001	0.001	0.00	29.53%	0.15%
20	12	0.000	0.001	0.00	57.05%	0.26%
20	13	0.000	0.001	0.00	38.47%	0.19%
20	14	0.000	0.001	0.00	73.37%	0.31%
30	15	0.000	0.001	0.00	12.72%	0.06%
30	16	0.000	0.001	0.00	41.20%	0.19%
30	17	0.000	0.001	0.00	47.91%	0.22%
30	18	0.000	0.001	0.00	60.37%	0.22%
30	19	0.000	0.001	0.00	103.95%	0.34%
30	20	0.000	0.001	0.00	36.73%	0.15%
31	15a	0.000	0.001	0.00	53.21%	0.26%
31	16a	0.000	0.001	0.00	57.21%	0.26%
31	17a	0.000	0.001	0.00	43.27%	0.20%
31	18a	0.000	0.001	0.00	71.76%	0.26%
31	19a	0.000	0.001	0.00	106.84%	0.35%
31	20a	0.000	0.001	0.00	43.98%	0.19%
50	21	0.001	0.001	0.00	39.75%	0.22%
50	22	0.001	0.001	0.00	22.73%	0.12%
50	23	0.000	0.001	0.00	48.05%	0.22%
50	24	0.001	0.001	0.00	26.80%	0.15%
50	25	0.000	0.001	0.00	80.91%	0.34%
	Max	0.001	0.001	0.00	175.02%	0.41%
	Average	0.000	0.001	0.00	48.96%	0.20%
	Min	0.000	0.001	0.00	-0.07%	0.00%
	Std Dev	0.000	0.000	0.00	34.06%	0.09%

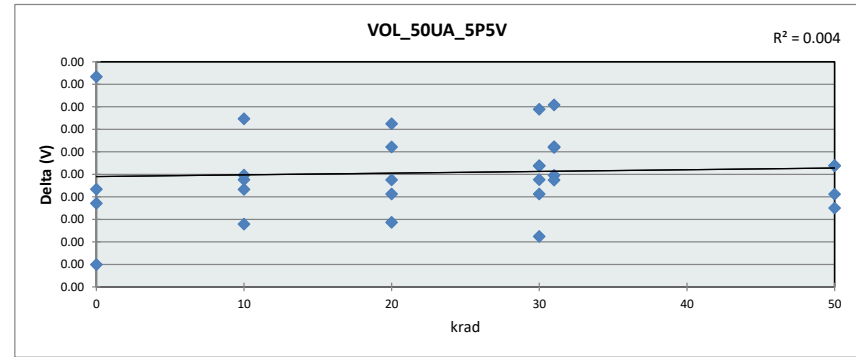

		VOL_50UA_5P5V					
		Units		V			
		Max Limit		0.1			
		Min Limit		-0.001			
krad		0	10	20	30	31	50
LL		-0.001	-0.001	-0.001	-0.001	-0.001	-0.001
Min		0.001	0.001	0.001	0.001	0.001	0.001
Average		0.001	0.001	0.001	0.001	0.001	0.001
Max		0.001	0.001	0.001	0.001	0.001	0.001
UL		0.100	0.100	0.100	0.100	0.100	0.100

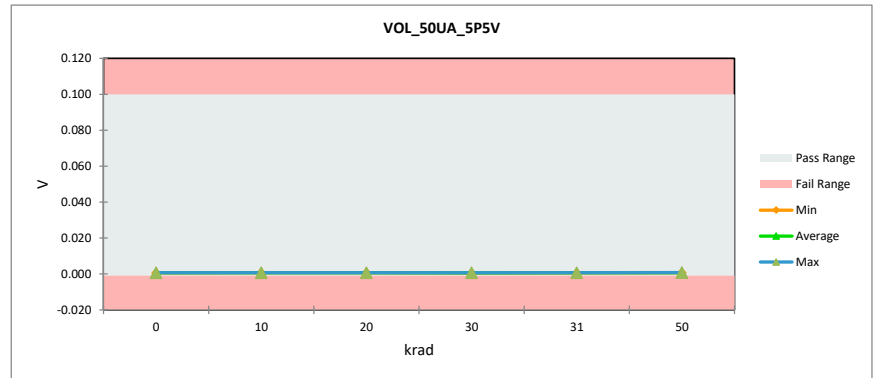



## IMPORTANT NOTICE AND DISCLAIMER

TI PROVIDES TECHNICAL AND RELIABILITY DATA (INCLUDING DATA SHEETS), DESIGN RESOURCES (INCLUDING REFERENCE DESIGNS), APPLICATION OR OTHER DESIGN ADVICE, WEB TOOLS, SAFETY INFORMATION, AND OTHER RESOURCES "AS IS" AND WITH ALL FAULTS, AND DISCLAIMS ALL WARRANTIES, EXPRESS AND IMPLIED, INCLUDING WITHOUT LIMITATION ANY IMPLIED WARRANTIES OF MERCHANTABILITY, FITNESS FOR A PARTICULAR PURPOSE OR NON-INFRINGEMENT OF THIRD PARTY INTELLECTUAL PROPERTY RIGHTS.

These resources are intended for skilled developers designing with TI products. You are solely responsible for (1) selecting the appropriate TI products for your application, (2) designing, validating and testing your application, and (3) ensuring your application meets applicable standards, and any other safety, security, regulatory or other requirements.

These resources are subject to change without notice. TI grants you permission to use these resources only for development of an application that uses the TI products described in the resource. Other reproduction and display of these resources is prohibited. No license is granted to any other TI intellectual property right or to any third party intellectual property right. TI disclaims responsibility for, and you will fully indemnify TI and its representatives against, any claims, damages, costs, losses, and liabilities arising out of your use of these resources.

TI's products are provided subject to [TI's Terms of Sale](#) or other applicable terms available either on [ti.com](https://www.ti.com) or provided in conjunction with such TI products. TI's provision of these resources does not expand or otherwise alter TI's applicable warranties or warranty disclaimers for TI products.

TI objects to and rejects any additional or different terms you may have proposed.

Mailing Address: Texas Instruments, Post Office Box 655303, Dallas, Texas 75265  
Copyright © 2025, Texas Instruments Incorporated