

TLK10002 Dual-Channel, 10-Gbps, Multi-Rate Transceiver Evaluation Module

This user's guide describes the usage and construction of the TLK10002 evaluation module (EVM). This document provides guidance on proper use by showing some device configurations and test modes. In addition, design, layout, and schematic information is provided to the customer. Information in this guide can assist the customer in choosing the optimal design methods and materials in designing a complete system.

Contents

1	Introduction	4
2	EVM PCB and High-Speed Design Considerations	5
3	TLK10002EVM Kit Contents	6
4	Power	6
5	Control and Output Status Signals	7
6	MDIO	7
7	JTAG	8
8	Reset	8
9	Test and Setup Configurations	9
10	TLK10002EVM Motherboard Schematics	17
11	TLK10002EVM Motherboard Bill of Materials	37
12	TLK10002EVM Motherboard Layout	42
13	TLK10002EVM FPGA Daughterboard Schematics	53
14	TLK10002EVM FPGA Daughterboard Bill of Materials	68
15	TLK10002EVM FPGA Daughterboard Layout	73
16	TLK10002EVM SMA Breakout Board Schematics	83
17	TLK10002EVM SMA Breakout Board Layout	88

List of Figures

1	TLK10002EVM Boards	4
2	TLK10002EVM Motherboard.....	10
3	TLK10002EVM FPGA Daughterboard.....	11
4	TLK10002EVM SMA Breakout Board	12
5	TLK10002EVM Motherboard and FPGA Daughterboard	13
6	CRPAT Test Setup With FPGA Generator and Verifier	14
7	Optimizing the High-Speed Link of a System Board Through the GUI.....	15
8	TLK10002EVM Motherboard and SMA Breakout Board	16
9	Cover Page and Index, Sheet 1 of 20	17
10	USB Interface, Sheet 2 of 20	18
11	1P0V, 1P5V, and 1P8V Regulators, Sheet 3 of 20	19
12	2P5V and 3P3V Regulators, Sheet 4 of 20	20
13	Power Distribution, Sheet 5 of 20	21
14	Device Power, Ground, and Local Decoupling, Sheet 6 of 20	22
15	Global Signals, Sheet 7 of 20.....	23
16	MDIO, JTAG, and I2C Interface, Sheet 8 of 20	24

17	Clocks, Sheet 9 of 20	25
18	Jitter Cleaner Control, Sheet 10 of 20	26
19	Low-Speed Data Signals, Sheet 11 of 20	27
20	High-Speed Data Signals, Sheet 12 of 20	28
21	1P0V, 2P5V, and 3P3V Regulator LEDs, Sheet 13 of 20	29
22	1P5/8V Regulator LEDs, Sheet 14 of 20	30
23	5-V, 3P3V_PLL, and VDDO LEDs, Sheet 15 of 20	31
24	VDDA, VDDT, VDDD, and DVDD LEDs, Sheet 16 of 20	32
25	VDDRA LEDs, Sheet 17 of 20.....	33
26	VDDRB LEDs, Sheet 18 of 20.....	34
27	Jitter Cleaner Power LEDs, Sheet 19 of 20.....	35
28	Board-To-Board Connector, Sheet 20 of 20	36
29	Top Signal, Layer 1	42
30	Internal Ground, Layer 2.....	43
31	Internal Signal, Layer 3	44
32	Internal Ground, Layers 4, 6, 7, 9, 11, and 13.....	45
33	Internal Power, Layer 5	46
34	Internal Power, Layer 8	47
35	Internal Power, Layer 10	48
36	Internal Signal, Layer 12.....	49
37	Bottom Signal, Layer 14, Top View	50
38	Bottom Signal, Layer 14, Flipped View	51
39	Cover Page and Index, Sheet 1 of 15	53
40	USB Interface, Sheet 2 of 15	54
41	Regulators, Sheet 3 of 15	55
42	FPGA Power and Ground, Sheet 4 of 15	56
43	FPGA Configuration, Sheet 5 of 15	57
44	FPGA Gigabit Transceivers, Sheet 6 of 15	58
45	TI-Programmed Resources 1, Sheet 7 of 15	59
46	TI-Programmed Resources 2, Sheet 8 of 15	60
47	User Programmable Resources 1, Sheet 9 of 15	61
48	User-Programmable Resources 2, Sheet 10 of 15	62
49	FPGA No Connects, Sheet 11 of 15.....	63
50	Board-to-Board Connector, Sheet 12 of 15	64
51	1P2V LEDs, Sheet 13 of 15.....	65
52	1P8V and 2P5V LEDs, Sheet 14 of 15	66
53	3P3V and 5-V LEDs, Sheet 15 of 15	67
54	Top Signal, Layer 1	73
55	Internal Ground, Layer 2.....	74
56	Internal Signal, Layer 3	75
57	Internal Ground, Layers 4, 6, 7, 9, 11, and 13.....	76
58	Internal Power, Layer 5	77
59	Internal Power, Layer 8	78
60	Internal Power, Layer 10	79
61	Internal Signal, Layer 12.....	80
62	Bottom Signal, Layer 14, Top View	81
63	Cover Page and Index, Sheet 1 of 4.....	83
64	Channel-A Signals, Sheet 2 of 4	84
65	Channel-B Signals, Sheet 3 of 4	85

66	Common Signals, Sheet 4 of 4	86
67	Top Signal, Layer 1	88
68	Internal Ground, Layer 2.....	89
69	Internal GND, Layers 3, 4, and 5.....	90
70	Bottom Signal, Layer 6	91

List of Tables

1	TLK10002EVM Motherboard Bill of Materials	37
2	TLK10002EVM Motherboard Layer Construction	52
3	TLK10002EVM FPGA Daughterboard Bill of Materials	68
4	TLK10002EVM FPGA Daughterboard Layer Construction	82
5	TLK10002EVM SMA Breakout Board Bill of Materials	87
6	TLK10002EVM SMA Breakout Board Layer Construction	92

1 Introduction

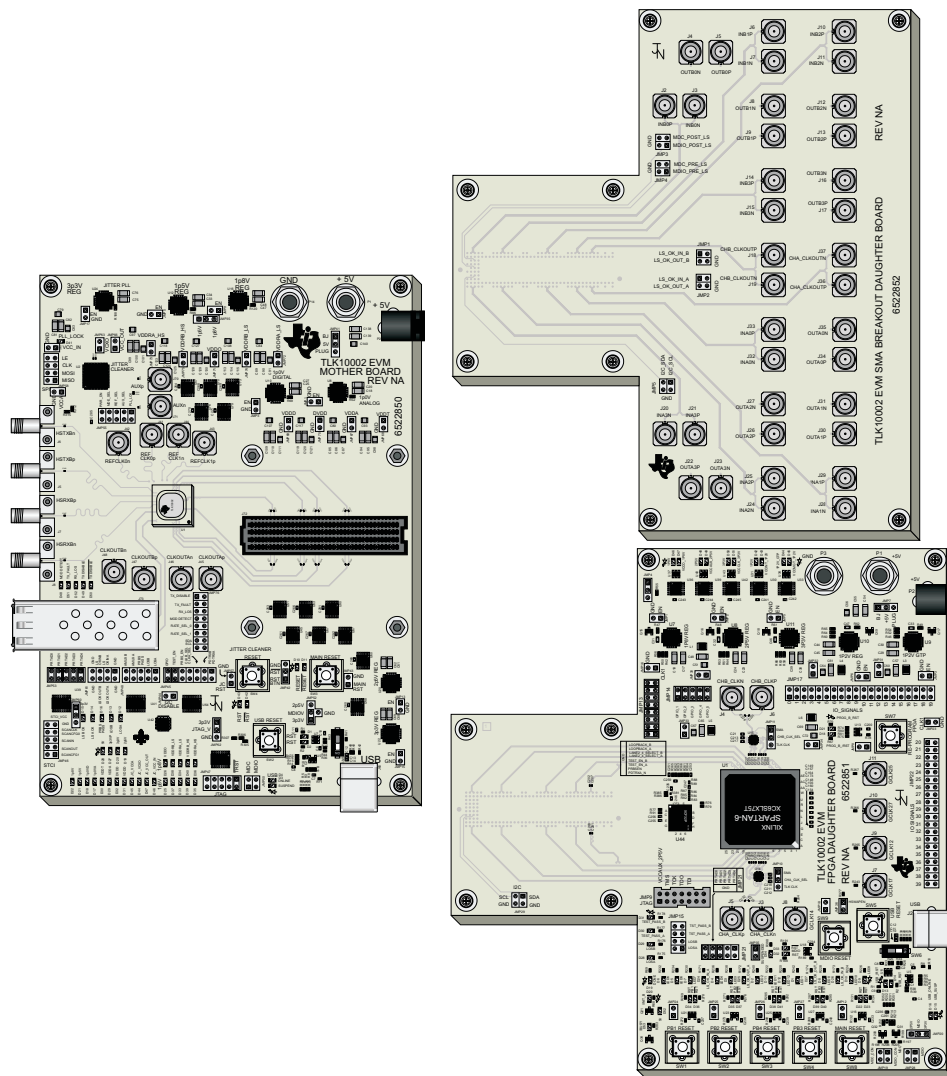

Figure 1. TLK1002EVM Boards

WARNING

This equipment is intended for use in a laboratory test environment only. It generates, uses, and can radiate radio frequency energy and has not been tested for compliance with the limits of computing devices pursuant to subpart J of part 15 of FCC rules, which are designed to provide reasonable protection against radio frequency interference. Operation of this equipment in other environments may cause interference with radio communications, in which case the user at own expense will be required to take whatever measures may be required to correct this interference.

The Texas Instruments (TI) TLK1002 SERDES evaluation module (EVM) boards are used to evaluate the functionality and the performance of the TLK1002 dual-channel, multi-rate transceiver device in a 144-ball PBGA package. The TLK1002 is a multigigabit transceiver intended for use in ultrahigh-speed,

bidirectional, point-to-point data transmission systems such as base station RRH (remote radio head) applications as well as any other high-speed application. All CPRI and OBSAI data rates from 1.2288 Gbps to 9.8304 Gbps and non-CPRI or OBSAI serial data rates between 1 Gbps and 10 Gbps are supported for the high-speed side. Each channel of the TLK10002 can be operated from a single, shared reference clock, or independently from separate reference clocks at different frequencies.

The TLK10002 performs data serialization/de-serialization and clock extraction as a physical layer interface device. Flexible clocking schemes are provided to support various operations and include the support for clocking with an externally jitter-cleaned clock recovered from the high-speed side.

Other features of the TLK10002 include an integrated latency measurement function, PRBS ($2^7 - 1$), ($2^{23} - 1$), ($2^{31} - 1$), and high, low, and mixed CRPAT long/short generation and verification for self-test, system-level support. Low-speed and high-speed side loopback modes are provided for self-test and system diagnostic purposes.

The TLK10002 has an integrated loss-of-signal (LOS) detection function on both high-speed and low-speed sides. LOS is asserted in conditions where the input differential voltage swing is less than the LOS assert threshold. The input differential voltage swing must exceed the de-assert threshold for the LOS condition to be cleared.

The low-speed side of the TLK10002 is ideal for interfacing with an FPGA or ASIC located on the same local physical system. The high-speed side is ideal for interfacing with remote systems through an optical fiber, an electrical cable, or a backplane interface. The TLK10002 supports operation with SFP and SFP+ optical modules. Both FPGA and optical interfaces are available in the evaluation kit for rapid prototyping and easy development.

Configuration of the TLK10002 on a per-channel basis is available by way of accessing a register space of control bits available through a two-wire access port called the Management Data Input/Output (MDIO) interface as defined in Clause 22 of the IEEE 802.3 Ethernet Specification.⁽¹⁾ The TLK10002EVM GUI provides access to all the registers of every device used on any of the TLK10002 boards through a standard USB 1.1 interface. The boards can be configured if necessary to accept or provide MDIO signals from or to an external source by installing and uninstalling certain resistors.

The TLK10002EVM board can be run from a single, 5-V power supply or 5-Vdc transformer. All voltages needed are regulated down through onboard LDO regulators which can be adjusted to the appropriate minimum, nominal, and maximum values through changing a single resistor value.

Voltage monitor circuits with LEDs are included on all voltage rails for easy debugging and identification of valid power rails.

All data I/O signals are broken out to connectors for easy and rapid prototyping; all control signals are easily controlled through the GUI or shunts on header blocks.

2 EVM PCB and High-Speed Design Considerations

The board can be used to evaluate device parameters in addition to acting as a guide for high-speed board layout. As the frequency of operation increases, the board designer must take special care to ensure that the highest signal integrity is maintained. To achieve this, the board's impedance is controlled to 50- Ω single-ended or 100- Ω differential impedance for both the low- and high-speed differential serial and clock connections. Vias are minimized and, when necessary, are designed to minimize impedance discontinuities along the transmission line. Care was taken to control trace length mismatch (board skew) to less than ± 0.5 mil.

Overall, the board layout must be designed and optimized to support high-speed operation. Thus, understanding impedance control and transmission line effects are crucial when designing high-speed boards. Some of the advanced features offered by this board include:

- The TLK10002 printed-circuit board (PCB) is designed for optimal high-speed signal integrity using Rogers Material for the outer signal layers and FR-4 for the inner layers. All gigabit and clock signals are routed over the Rogers Material for minimal signal loss. The optional FPGA and SMA Breakout Daughterboards use FR-4 for all layers.
- SMA and header fixtures are easily connected to test equipment.
- All input/output signals are accessible for rapid prototyping.

⁽¹⁾ The MDIO register map is located within the *TLK10002 Dual-Channel 10Gbps Multi-Rate Transceiver* datasheet.

- The entire board can be powered from a single, 5-V power supply where the power planes can be supplied through onboard regulators or through separate headers for isolation.
- Onboard capacitors provide ac coupling of high-speed transmit and receive signals.
- Voltage monitoring LED circuits provide quick indication that the voltage is within specification.
- Provisions are included for use of an onboard CDCE72010 jitter cleaner to supply a reference clock signal. Note that by default the hardware is configured for external reference clocks only.

3 TLK10002EVM Kit Contents

The TLK10002EVM kit contains the following:

- TLK10002EVM motherboard
- TLK10002EVM User's Guide (this document)
- TLK10002 data sheet
- CD-ROM containing user interface software and user guides

The following two daughterboards may be ordered separately for evaluation of the TLK10002 low-speed side:

- TLK10002EVM FPGA daughterboard
- TLK10002EVM SMA breakout daughterboard

4 Power

The TLK10002EVM can be operated off of a single, 5-V power supply with a 2.5-A or greater current rating, using the onboard, low-dropout (LDO) voltage regulators to generate the voltages required to correctly operate the TLK10002's 1-V and 1.5-V/1.8-V power rails. Additional 2.5-V and 3.3-V supplies have been added to support additional circuitry on the EVM board. Two-pin headers allow external laboratory power supplies to be used instead of the onboard LDO regulators if the ferrite beads at the source of the split planes are also removed. The LDO regulators used on the EVM are TI's TPS74401 and are adjustable using a resistor divider between the output and a feedback pin. Each regulator has been set to provide the appropriate voltage with a slightly higher margin at the source to account for IR drop across the board. If more information on the use of these regulators is desired, consult the regulator data sheets found at www.ti.com.

Several power supplies such as VDDRA_LS, VDDRB_LS, VDDRA_HS, VDDRB_HS, and VDDO can be operated off of either 1.5 V or 1.8 V depending on your specific setup. The EVM is designed to allow either of these voltages to be selected for use with the previously mentioned TLK10002 supply rails, but only allows either 1.5 V or 1.8 V to be selected at a time without some board modifications. Selection between 1.5 V and 1.8 V is performed by moving the jumper between the center pin and the respective 1p5V and 1p8V pins of JMP35.

The 0-Ω resistors are located at the entrance point of each power plane and can be replaced with a ferrite bead of an appropriate value depending on the desired data rate if desired. See [Figure 13](#) and [Figure 14](#) of the TLK10002EVM Schematics for more specific information on how all the power planes are connected and sourced from either the regulators or external headers.

4.1 Power Monitoring LEDs

Each plane of the TLK10002EVM has been equipped with a voltage monitoring circuit that monitors the voltage on the plane and lights the LEDs when the voltage is within the minimum/maximum data sheet limits for that power supply. A precision TI voltage reference chip is used along with 0.1% precision resistors to set minimum and maximum reference levels, providing a detection circuit that is accurate to approximately ±10 mV. The LEDs can be used as a basic indication of the status of power on the board being within the acceptable minimum/maximum limits given in the data sheet and not as a precise measurement tool, as some LED circuits may turn off at slightly different voltages when approaching the limits due to the manufacturing tolerances and available component values. If the LEDs fail to light, a problem exists with the voltage on the board that can result in damage to the board if the problem is not resolved.

5 Control and Output Status Signals

All of the external control and status pins on the TLK10002EVM have been consolidated to a single location on the board and broken out into several header blocks for easier reference. LEDs have been added to the LOSA, LOSB, PRBS_PASS, and PLL_LOCK of the CDCE72010 jitter cleaner lines in addition to the headers for scope probes to allow easy monitoring of the high/low value on the line. The LED is ON when the line is a logic high, and the LED is OFF when the line is a logic low. If the line is toggling, a dimming of the LED may be observed as the LED is pulsing on and off relative to the activity on the line.

All status pins and external control pins of the TLK10002 and the CDCE72010 can also be monitored or set high/low through the GUI. The preferred method of setting these control pins is through the GUI via the TCA6424 I2C-to-GPIO IC located on the board. If shunts are placed on the header for a particular control pin, the signal is physically tied low and software control is not possible. Mixed use of the hardware and software setting of various control pins is discouraged.

The I2C-based software control of the TLK10002 control pins can be disabled by placing a shunt on JMP44, which disables the level shifter attached to the signals by setting the enable pins low. This allows the onboard pullup resistors or shunts to ground on the header pins to set the high/low status of the control pins. If external control is desired, the Software Control radio button on the GUI front panel must be de-selected as well to disable the software portion of the interface.

See the TLK10002 data sheet for a detailed description of the control signals.

6 MDIO

The TLK10002 supports the Management Data Input/Output (MDIO) interface as defined in Clause 22 of the IEEE 802.3 Ethernet Specification. The MDIO allows register-based management and control of the serial links. Normal operation of the TLK10002 is possible without the use of this interface, although some additional features are accessible only through the MDIO interface.

The MDIO management interface consists of a bidirectional data path (MDIO) and a clock reference (MDC). The port address is determined by control pins PRTAD[4:0] as described in Table 1 of the TLK10002 data sheet.

In Clause 22, the top four control pins PRTAD[4:1] determine the device port address. In this mode, the two individual channels in TLK10002 are classified as two different ports. So, any PRTAD[4:1] value has two ports per TLK10002. The TLK10002 responds if the four MSBs of the PHY address field on MDIO protocol (PA[4:1]) matches PRTAD[4:1]. The LSB of PHY address field (PA[0]) will determine which channel/port within the TLK10002 to respond to.

If PA[0] = 1'b0, TLK10002's channel A responds.

If PA[0] = 1'b1, TLK10002's channel B responds.

Write transactions that address an invalid register or read only registers are ignored. Read transactions of invalid registers return a 0.

The TLK10002 requires either 1.5-V or 1.8-V I/O levels on the MDIO/MDC signals. Therefore, a bidirectional level shifter has been provided on board that level shift the 3.3-V MDIO and MDC signals to the appropriate 1.5-V/1.8-V levels. If a different MDIO controller is used that already has 1.5-V or 1.8-V signal levels, resistors R308, R309, R296, and R297 must be removed, thus disconnecting the level shifter. Resistors R293 and R295 can be installed which connect the TLK10002 MDIO and MDC signal pins directly to the pins of JMP50. A third option of using NFETs as level shifters has also been provided. Removing resistors R308, R309, R296, and R297, as well R293 and R295 if they were installed and installing an appropriate NFET such as Fairchild's FDV301N allows for this third option of level shifting to be evaluated.

The onboard TUSB3210 microcontroller is the preferred method of controlling the TLK10002 register stack and is the only way to interface the GUI with the board.

7 JTAG

The EVM also provides a separate connector to support the full five-pin JTAG interface of the TLK10002 with onboard level shifters to be compatible with most standard JTAG control interfaces to be used for manufacturing tests. The 3.3-V (header) side of the level shifter is connected to the header and the 1p5/8V side of the level shifter is connected to the TLK10002. If the level shifter is not needed, providing an external voltage of the appropriate signal level between pins 2 and 3 of JMP62 allows the signals to pass to the TLK10002 correctly.

8 Reset

The TLK10002EVM comes configured for manual reset operations involving the pushbutton reset switch (SW3). When switch SW3 is pressed, the TLK10002 device RESET pin (RST_N) goes LOW, and the entire TLK10002 device is reinitialized. A TI TPS3125J18 ultralow-voltage processor supervisory circuit is used to control the reset line. During power-on, $\overline{\text{RESET}}$ pin of U37 is asserted when the supply voltage becomes higher than 0.75 V. Thereafter, the supply voltage supervisor monitors the voltage and keeps $\overline{\text{RESET}}$ output active as long as the voltage remains below the threshold voltage (V_{IT}). An internal timer delays the return of the output to the inactive state (high) to ensure proper system reset. The delay time, $t_d = 180$ ms, starts after the voltage has risen above the threshold voltage (V_{IT}).

A manual reset input to the supervisory circuit, $\overline{\text{MR}}$, accepts the input from the pushbutton switch SW3. A low level at $\overline{\text{MR}}$ causes $\overline{\text{RESET}}$ to become active, thus resetting the TLK10002 device whenever the pushbutton RESET is pressed. By placing a jumper on JMP43, the manual reset (/MR) is tied hard to ground causing the TLK10002 to be held in a constant state of reset without the need to continually hold the Reset Pushbutton SW3. The supervisory circuit releases the reset line to a HIGH 180 ms (t_d) from the time the $\overline{\text{MR}}$ line becomes greater than the threshold voltage (V_{IT}).

By removing the jumper from JMP42, the supervised reset circuit is disconnected from the RST_N line. Reset control from an external controller or piece of equipment can be connected directly to pin 2 (RST_N) of JMP42 and a ground pin GND has been added to the JMP42 header next to the RST_N pin to allow easy access for the return current on that cable.

The CDCE72010 jitter cleaner $\overline{\text{RESET}}$ signal is also connected to the Main Reset pushbutton as well as individually controlled by pressing SW4. Note this $\overline{\text{RESET}}$ does not reset the CDCE72010 register stack settings and is only a PLL reset.

NOTE: In order to keep the GUI settings and the device settings synchronized during the evaluation of the TLK10002, all RESET commands must be issued through the GUI via the TCA6424 I2C-to-GPIO device connected to the signals. When the software RESET buttons are pressed, the GUI adjusts its memory settings of the various registers in order to match the new values the devices will reflect after the hardware RESET is performed. If the buttons are pressed on the board, the GUI does not reflect the devices' true status and may result in erroneous results during testing because the device is not configured according to the GUI's displayed results.

Depending on the power down and/or GUI termination sequence followed, the USB device may need to be RESET to allow re-enumeration to occur in future tests. When the board is powered on and the USB connection is enumerated, the USB online LED (D4) lights. If this LED fails to light, a PC-related issue may exist, and the PC must be restarted. The LED lights once the PC error is fixed. If the USB connection is improperly disconnected or terminated, the USB SUSPEND light D3 lights and is an indication that the USB connection is not properly established.

9 Test and Setup Configurations

The TLK10002EVM has an SFP+ Optical Module Cage attached directly to channel A's high-speed signals through approximately 2 inches of trace over Rogers Low-Dielectric material. Channel B's high-speed signals are attached to Edge Launch SMA connectors with 0.1- μ F ac coupling capacitors on the RX lines, and 0- Ω resistors on the TX lines to facilitate an external loopback configuration with only a single set of capacitors in line. The capacitors or resistors must be carefully reworked as necessary to facilitate the test needs during evaluation. Placing two 0.1- μ F ac coupling capacitors can result in lower performance and greater numbers of bit errors.

All low-speed signals on both the RX and TX signals have 0.1- μ F ac coupling capacitors and are routed to a Samtec SEAF board-to-board connector that mates with either the TLK10002EVM SMA breakout board for use in parametric and laboratory testing, or the TLK10002EVM FPGA breakout daughterboard for system-level evaluation.

The MDIO bus that is connected to the TLK10002 is also routed to the SEAF board-to-board connector and can be used to interface with either the FPGA or an external system board via the post level shifter MDIO signal header on the SMA breakout board.

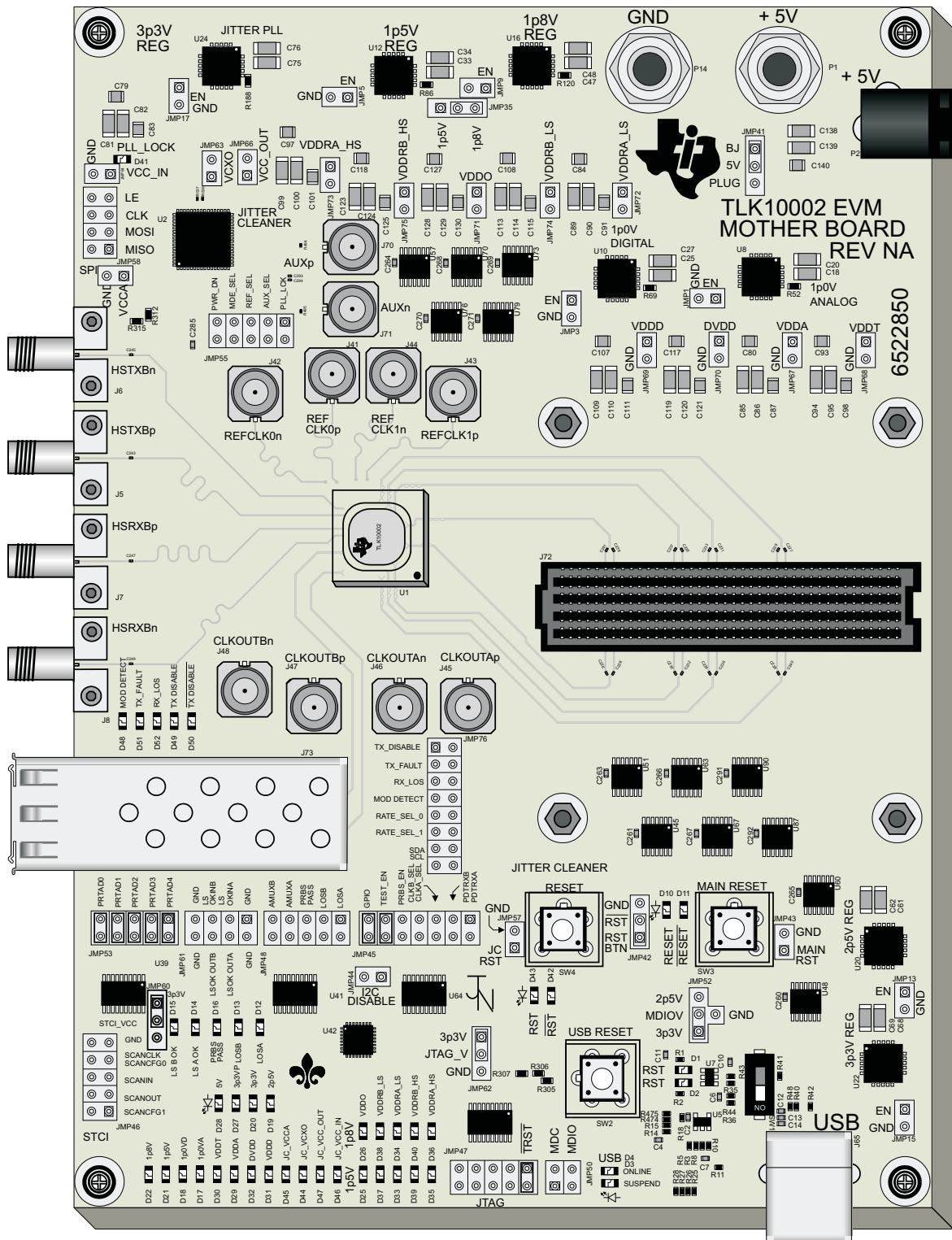

Figure 2. TLK1002EVM Motherboard

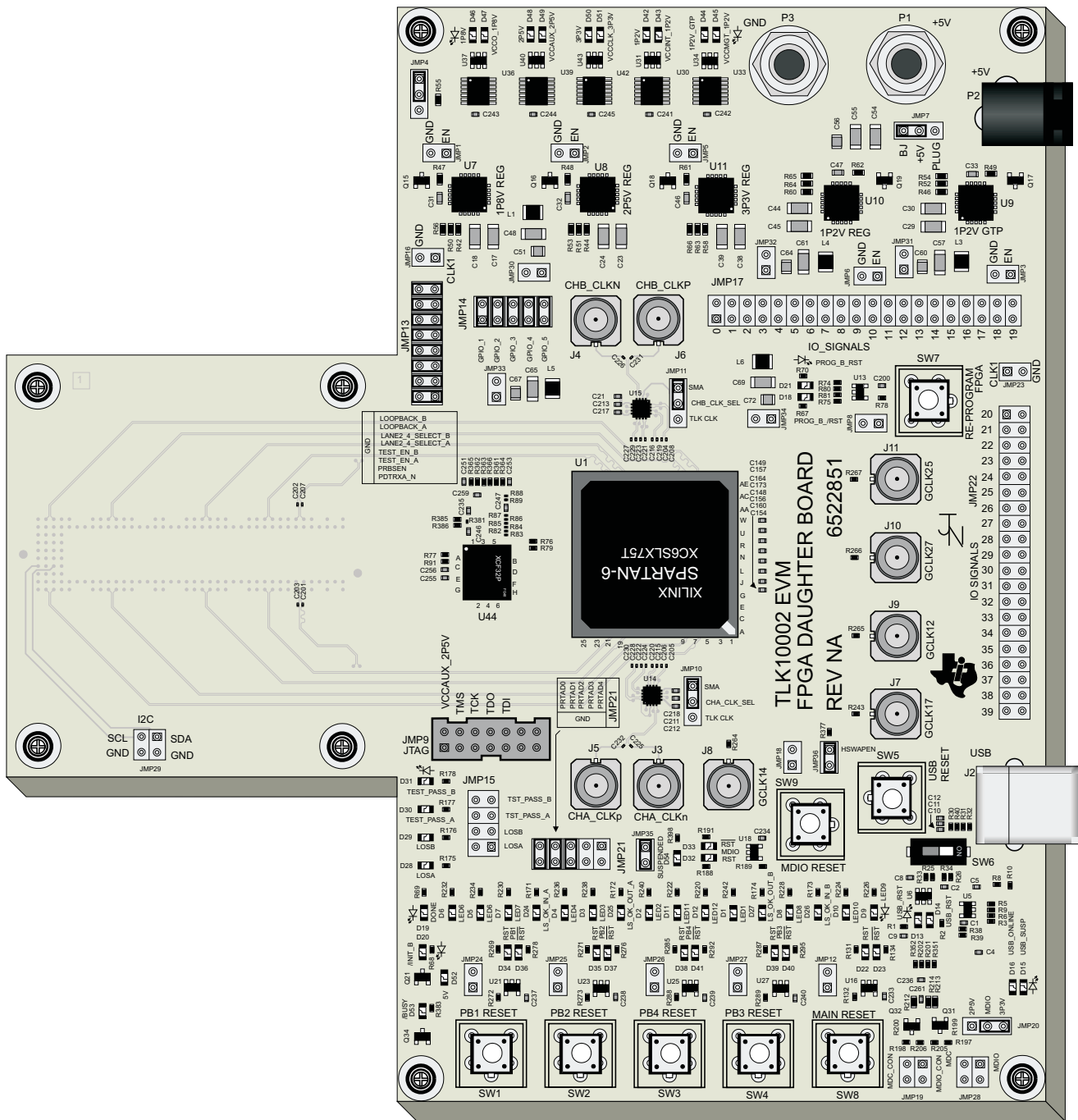

Figure 3. TLK1002EVM FPGA Daughterboard

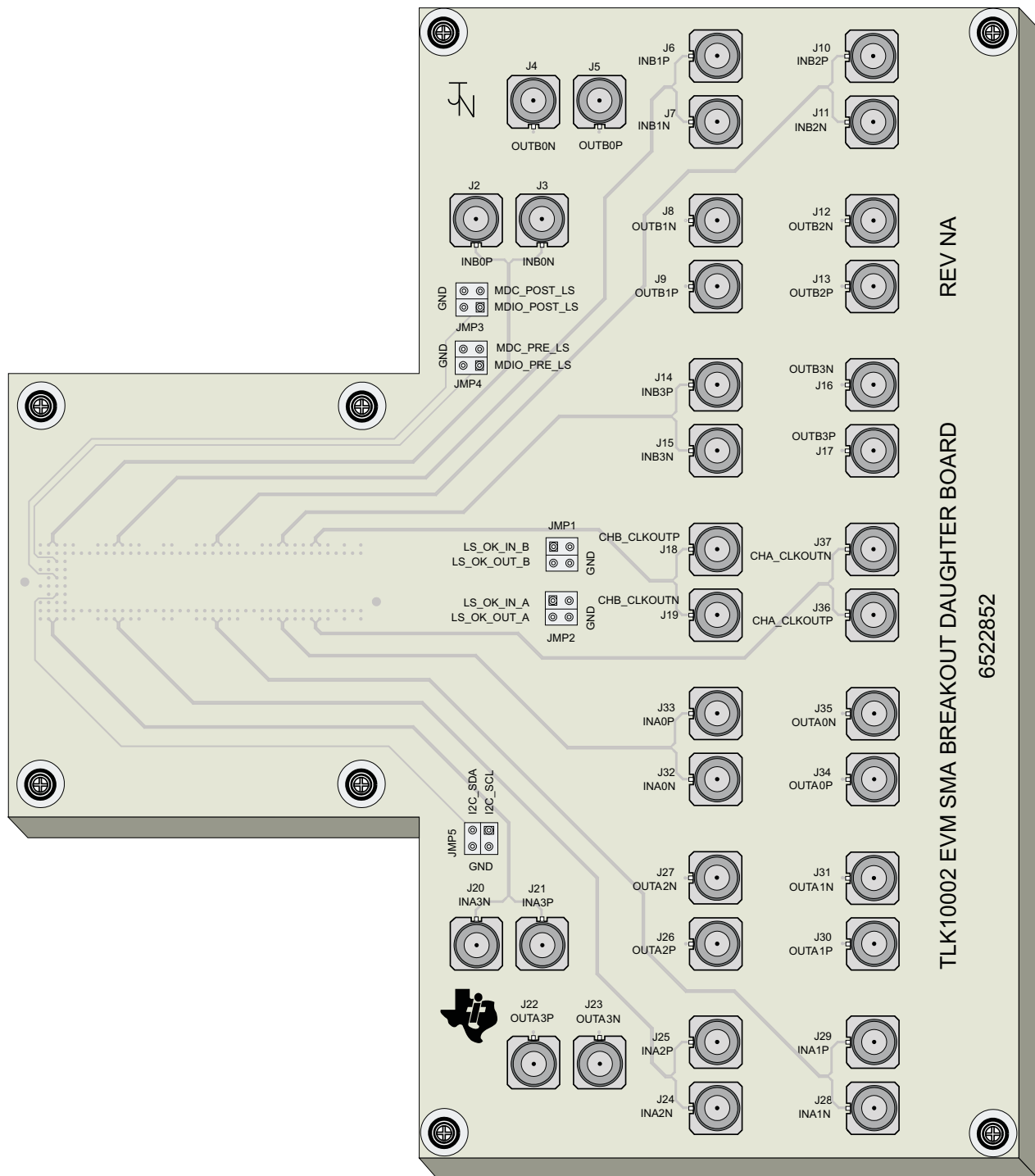

Figure 4. TLK10002EVM SMA Breakout Board

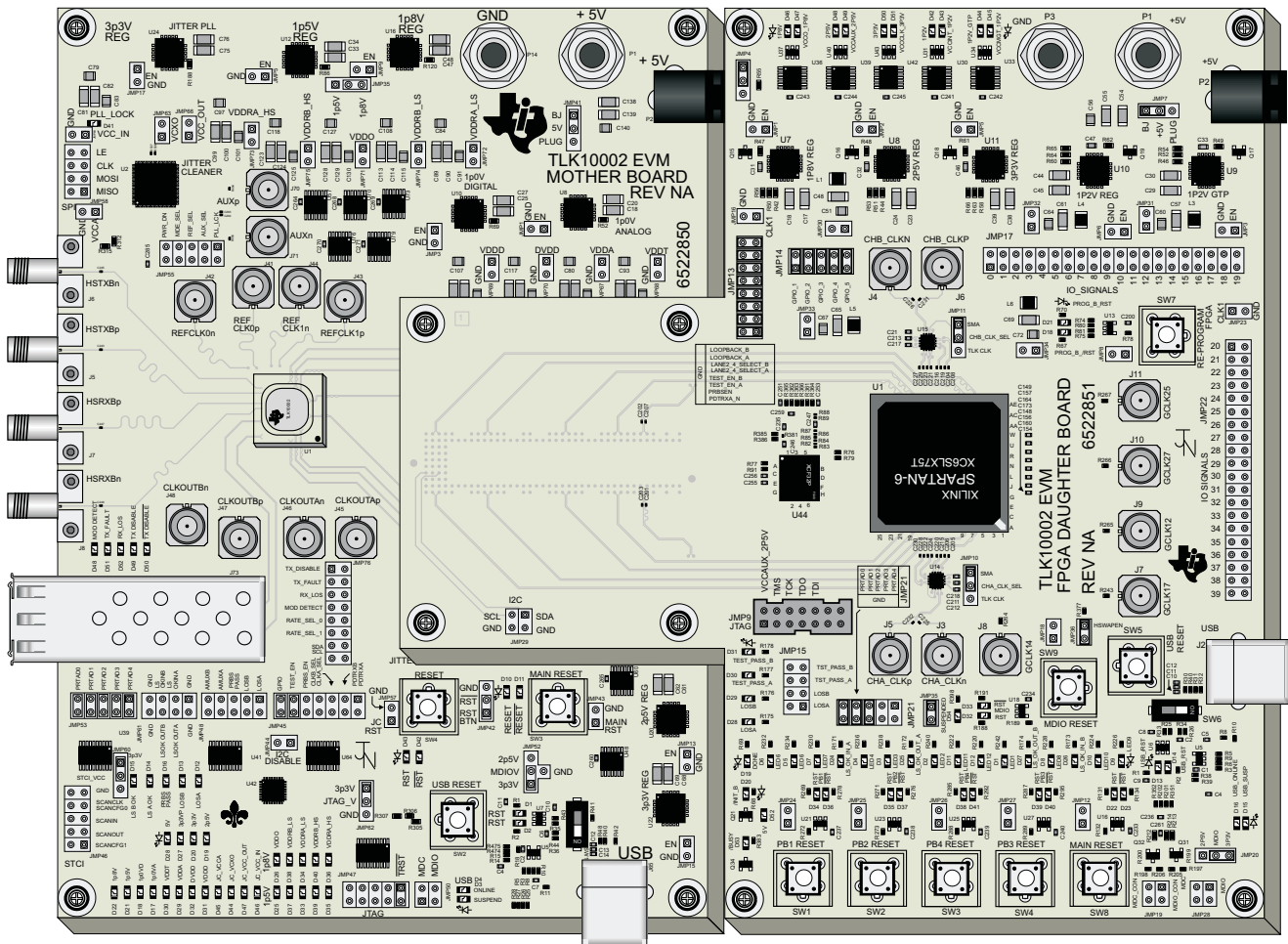

Figure 5. TLK10002EVM Motherboard and FPGA Daughterboard

A common method of evaluating the TLK10002 is to place the TLK10002 device in the transceiver mode with its high-speed signals externally looped back to itself. Using an external data source to generate and verify the data on the low-speed side of the device, data fully passes through the TLK10002 device exactly as it does in a system application.

Figure 6 is a diagram of how to set up the TLK10002 motherboard and the FPGA daughterboard that uses the FPGA CRPAT generators and verifiers to evaluate the TLK10002. The same 122.88-MHz clock must be applied to both FPGA clock inputs as well as one of the TLK10002 reference clock inputs. Two 5-V power supplies are needed, and 5 V must be applied to both boards individually because no power is shared through the board-to-board connector. Channel B of the TLK10002 must have SMA cables connected as shown with TXBP/RXBP and TXBN/RXBN connected together. In order to evaluate Channel A, an SFP+ Optical Module and optical fiber are required. A single USB cable connected to the TLK10002 motherboard allows access to the registers of both boards. Note that the PRTAD device address pins of the TLK10002 boards must be different in order to prevent writing to the wrong device's registers. The TLK10002 motherboard comes configured with PRTAD equal to address "0" and the FPGA daughterboard is configured with the address of "1." In order to communicate with the FPGA registers in the TLK10002EVM GUI, the PRTAD address of the FPGA daughterboard must first be entered into the Port Addr field on the Low Level Register Configuration tab and changed back to the TLK10002 address prior to re-accessing the TLK10002 registers.

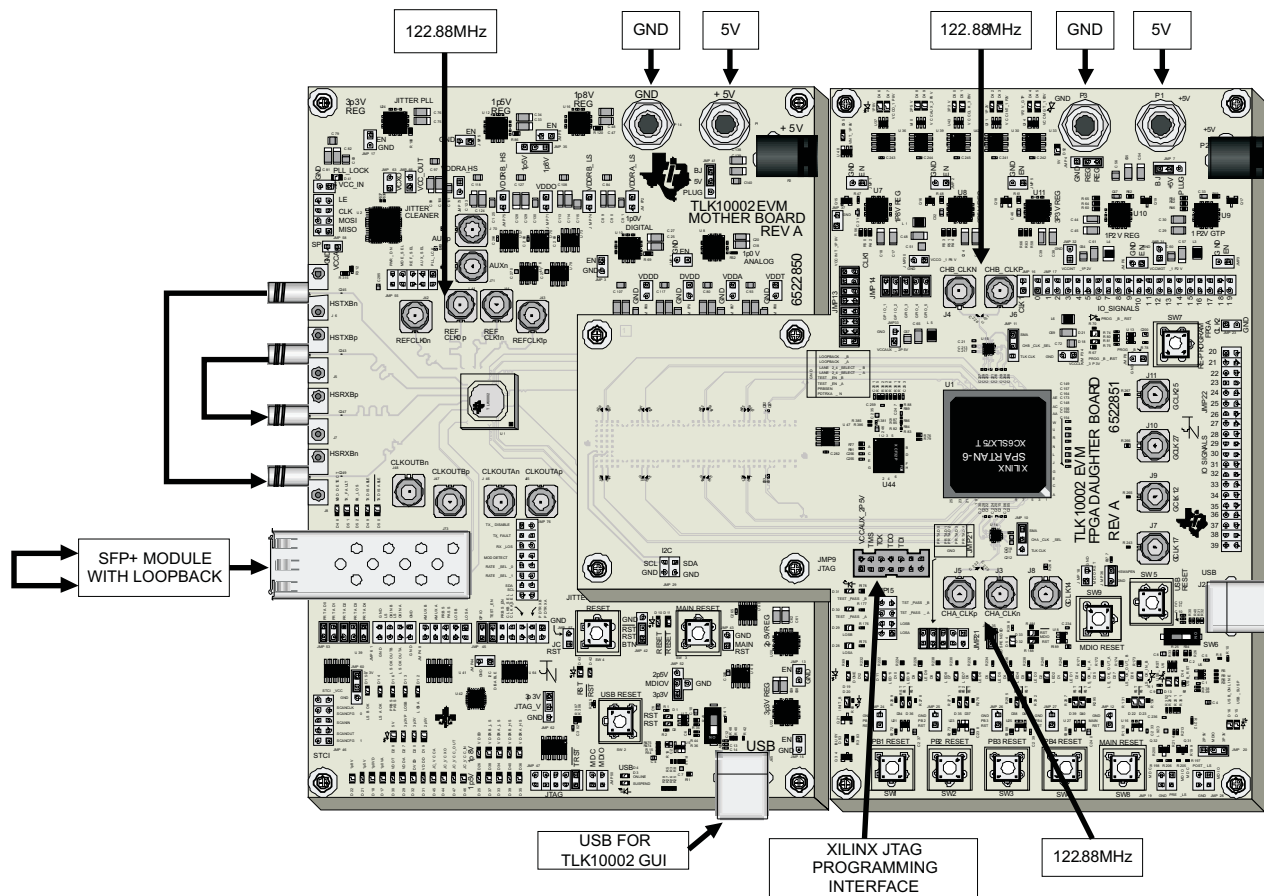

Figure 6. CRPAT Test Setup With FPGA Generator and Verifier

It is possible to use the Link Optimizer portion of the TLK10002 GUI to optimize the high-speed link on a third-party system board. Connect the TLK10002EVM SMA to the TLK10002EVM motherboard and connect the MDC_POST_LS and MDIO_POST_LS signals from the breakout board to the system board. Ensure that the system PRTAD[4:0] address is different than the motherboard's PRTAD[4:0], and enter the system address in the Port Addr field on the Low Level Register Configuration tab of the TLK10002EVM GUI.

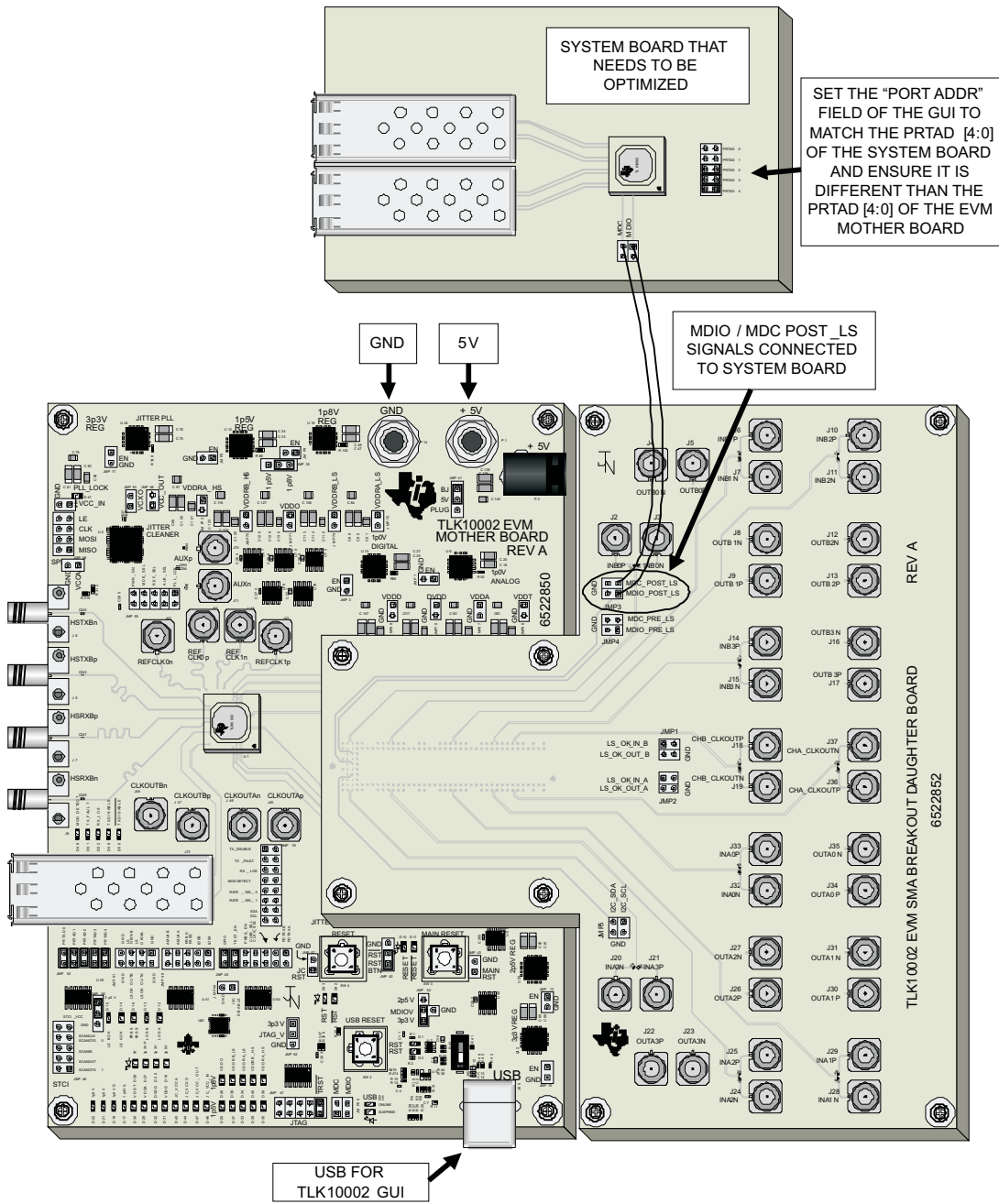

Figure 7. Optimizing the High-Speed Link of a System Board Through the GUI

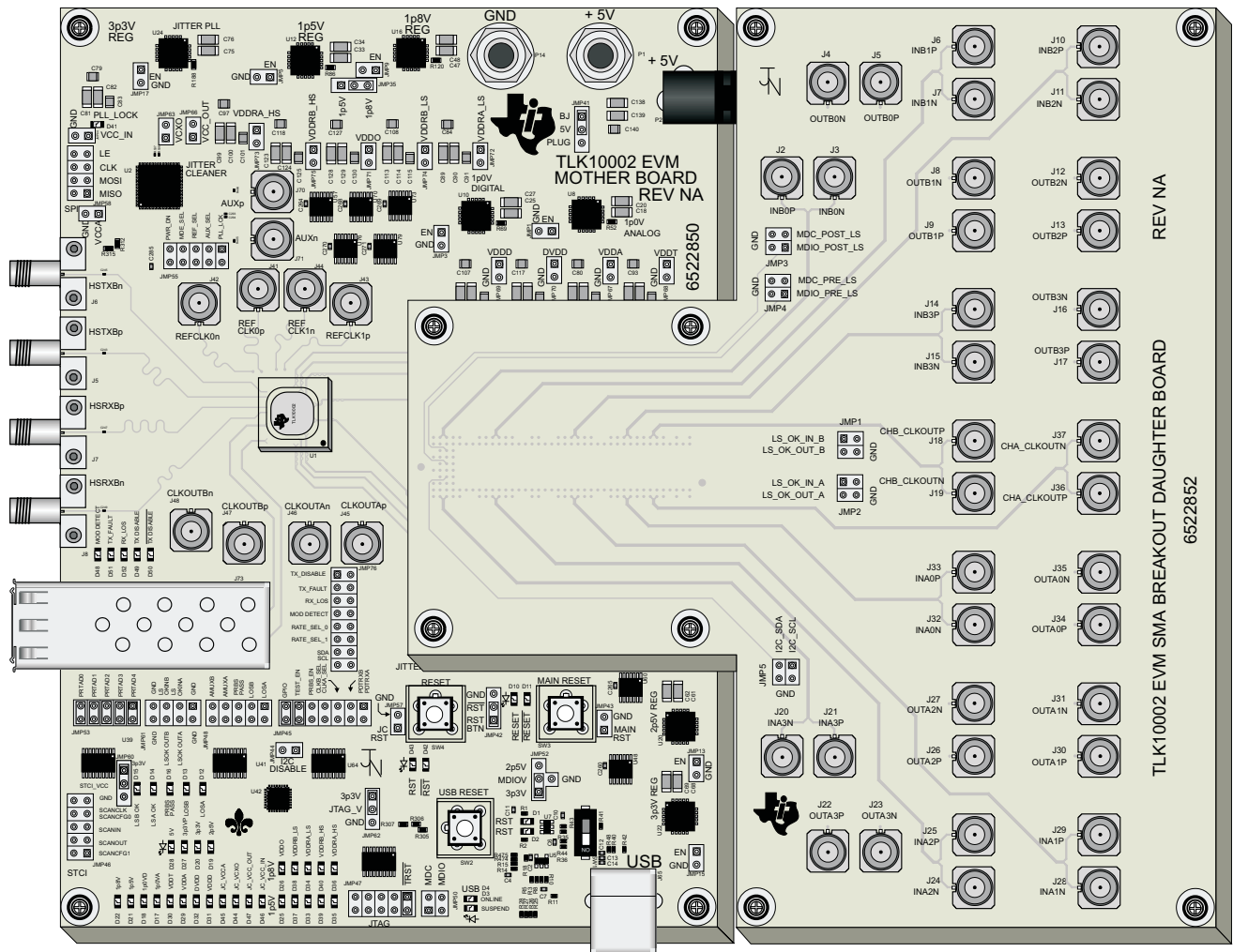



Figure 8. TLK10002EVM Motherboard and SMA Breakout Board

10 TLK10002EVM Motherboard Schematics

<p>NOTES:</p> <ol style="list-style-type: none"> 1. PLACE NET NAMES ON ALL JUMPERS AND HEADERS. 2. PLACE ALL PARTS OTHER THAN SMP CONNECTORS ON A 0 OR 90 DEGREE ORIENTATION. 3. SERIAL DATA SHOULD BE ROUTED AS SINGLE-ENDED 50 OHM TRANSMISSION LINES ON OUTSIDE LAYERS. ROUTING DISTANCE SHOULD BE 3 INCHES OR LESS. 4. USE ROGERS MATERIAL FOR OUTSIDE LAYERS AND FR4-370 MATERIAL FOR INSIDE LAYERS. 5. SERIAL AND REFCLK NETS MUST MATCH WITHIN +/- 0.5 MILS 6. MATCH DIFFERENTIAL TRACE WIDTHS OF SERIAL AND REFCLK LINES WITH SMP/SMA PADS. 7. PLACE TI LOGO IN TOP SIDE METAL 	<table border="1" style="width: 100%; border-collapse: collapse; margin-bottom: 20px;"> <thead> <tr> <th colspan="3">REVISIONS</th> </tr> <tr> <th>ECR</th> <th>ECR NUMBER</th> <th>DATE</th> </tr> </thead> <tbody> <tr> <td> </td> <td>-----</td> <td>xx/xx/xx</td> </tr> </tbody> </table> <div style="border: 1px solid black; padding: 10px; margin: 20px auto; width: 80%;"> <p style="text-align: center; margin: 0;">SCHEMATIC SHEET INDEX:</p> <p>SHEET 01: TLK10002 CHAR COVER SHEET AND NOTES SHEET 02: USB INTERFACE SHEET 03: 1P0V, 1P5V, 1P8V REGULATORS SHEET 04: 2P5V, 3P3V REGULATORS SHEET 05: POWER DISTRIBUTION SHEET 06: DEVICE POWER AND GROUND SHEET 07: GLOBAL SIGNALS SHEET 08: MDIO, JTAG, AND I2C INTERFACE SHEET 09: CLOCKS SHEET 10: JITTER CLEANER CONTROL SHEET 11: LOW SPEED DATA SIGNALS SHEET 12: HIGH SPEED DATA SIGNALS SHEET 13: 1P0V, 2P0V, 3P3V REG LEDS SHEET 14: 1P5V, 1P8V REG LEDS SHEET 15: 5V, 3P3V PLL, AND VDDO LEDS SHEET 16: VDDA, VDDT, VDDD, DVDD LEDS SHEET 17: VDDRA LEDS SHEET 18: VDDRB LEDS SHEET 19: JITTER CLEANER POWER LEDS SHEET 20: BOARD TO BOARD CONNECTOR</p> </div> <div style="text-align: right; margin-top: 20px;">  <table border="1" style="margin-left: 10px;"> <tr> <td colspan="2" style="text-align: center;">TEXAS INSTRUMENTS</td> </tr> <tr> <td colspan="2" style="font-size: small;">SCHEMATIC TITLE</td> </tr> <tr> <td colspan="2" style="text-align: center;">TLK10002 EVM MOTHER BOARD</td> </tr> <tr> <td colspan="2" style="font-size: small;">PAGE TITLE</td> </tr> <tr> <td colspan="2" style="text-align: center;">COVER PAGE AND NOTES</td> </tr> <tr> <td style="font-size: x-small;">ENGINEER</td> <td style="font-size: x-small;">DATE</td> </tr> <tr> <td style="font-size: x-small;">J. NERGER</td> <td style="font-size: x-small;">11/18/10</td> </tr> <tr> <td style="font-size: x-small;">LAYOUT</td> <td style="font-size: x-small;">DATE</td> </tr> <tr> <td style="font-size: x-small;">G. ROTH</td> <td style="font-size: x-small;">11/18/10</td> </tr> <tr> <td style="font-size: x-small;">RELEASED</td> <td style="font-size: x-small;">DATE</td> </tr> <tr> <td style="font-size: x-small;">J. NERGER</td> <td style="font-size: x-small;">11/18/10</td> </tr> <tr> <td style="font-size: x-small;">SIZE</td> <td style="font-size: x-small;">DOCUMENT NUMBER</td> </tr> <tr> <td style="font-size: x-small;">B</td> <td style="font-size: x-small;">6522850</td> </tr> <tr> <td style="font-size: x-small;">REV</td> <td style="font-size: x-small;">SHEET</td> </tr> <tr> <td style="font-size: x-small;">NA</td> <td style="font-size: x-small;">1 of 20</td> </tr> </table> </div>	REVISIONS			ECR	ECR NUMBER	DATE		-----	xx/xx/xx	TEXAS INSTRUMENTS		SCHEMATIC TITLE		TLK10002 EVM MOTHER BOARD		PAGE TITLE		COVER PAGE AND NOTES		ENGINEER	DATE	J. NERGER	11/18/10	LAYOUT	DATE	G. ROTH	11/18/10	RELEASED	DATE	J. NERGER	11/18/10	SIZE	DOCUMENT NUMBER	B	6522850	REV	SHEET	NA	1 of 20
REVISIONS																																								
ECR	ECR NUMBER	DATE																																						
	-----	xx/xx/xx																																						
TEXAS INSTRUMENTS																																								
SCHEMATIC TITLE																																								
TLK10002 EVM MOTHER BOARD																																								
PAGE TITLE																																								
COVER PAGE AND NOTES																																								
ENGINEER	DATE																																							
J. NERGER	11/18/10																																							
LAYOUT	DATE																																							
G. ROTH	11/18/10																																							
RELEASED	DATE																																							
J. NERGER	11/18/10																																							
SIZE	DOCUMENT NUMBER																																							
B	6522850																																							
REV	SHEET																																							
NA	1 of 20																																							

TLK10002 DATA SHEET REVISION: 0.7
 DATA SHEET LAST UPDATED ON: 09/27/10

Figure 9. Cover Page and Index, Sheet 1 of 20

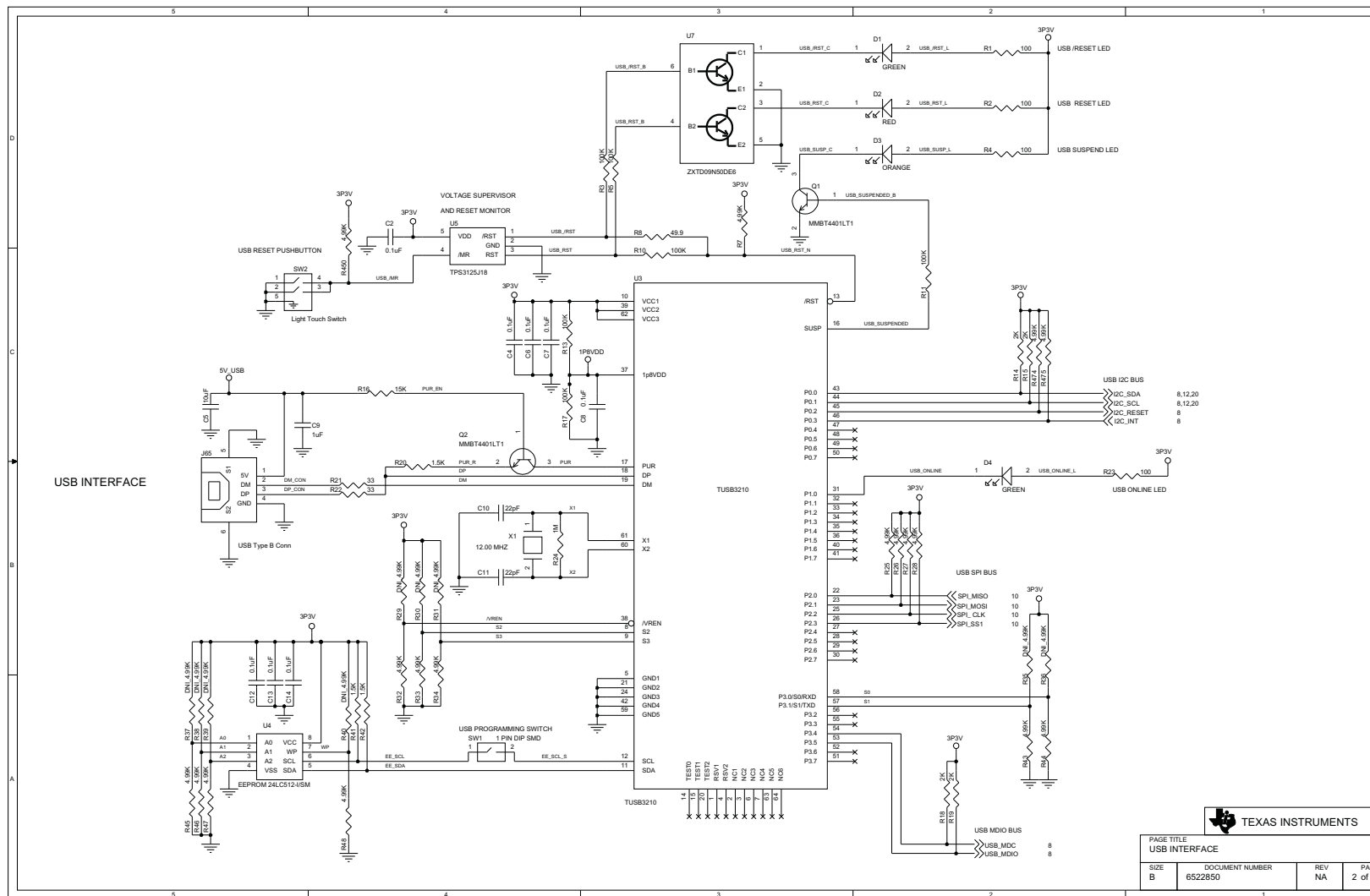

Figure 10. USB Interface, Sheet 2 of 20

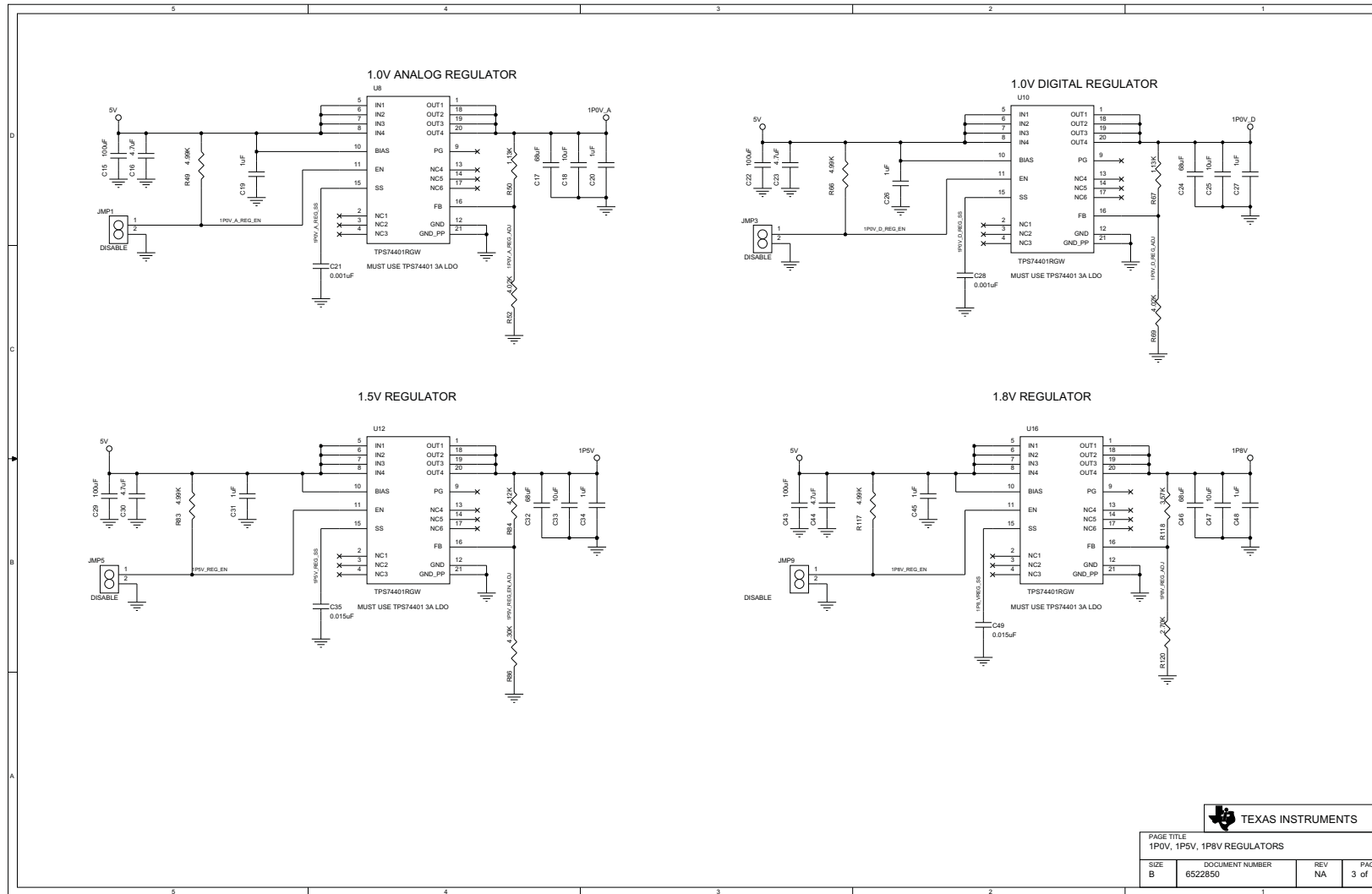
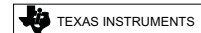

Figure 11. 1P0V, 1P5V, and 1P8V Regulators, Sheet 3 of 20



PAGE TITLE			
1P0V, 1P5V, 1P8V REGULATORS			
SIZE	DOCUMENT NUMBER	REV	PAGE
B	6522850	NA	3 of 2

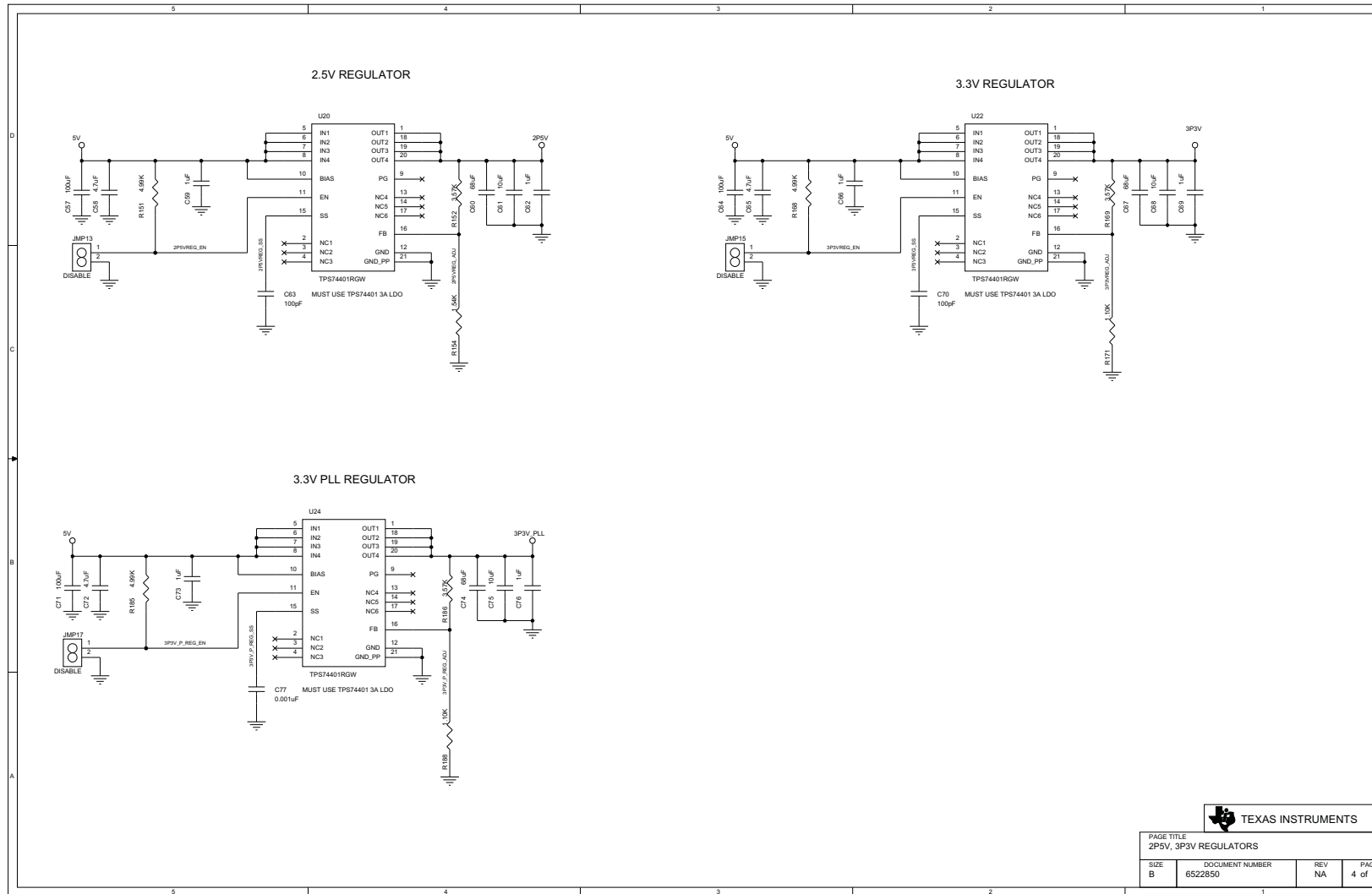

Figure 12. 2P5V and 3P3V Regulators, Sheet 4 of 20

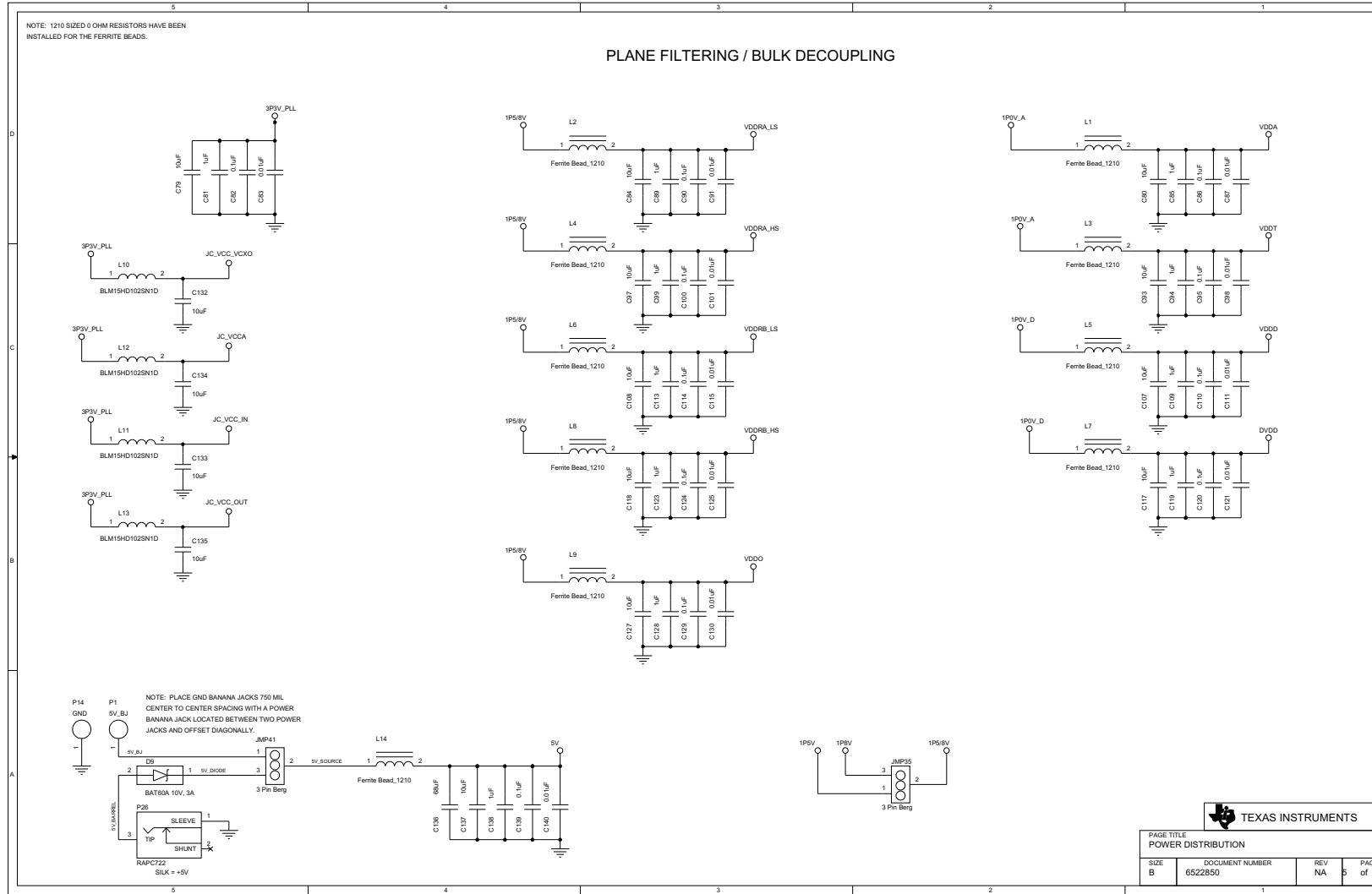

Figure 13. Power Distribution, Sheet 5 of 20

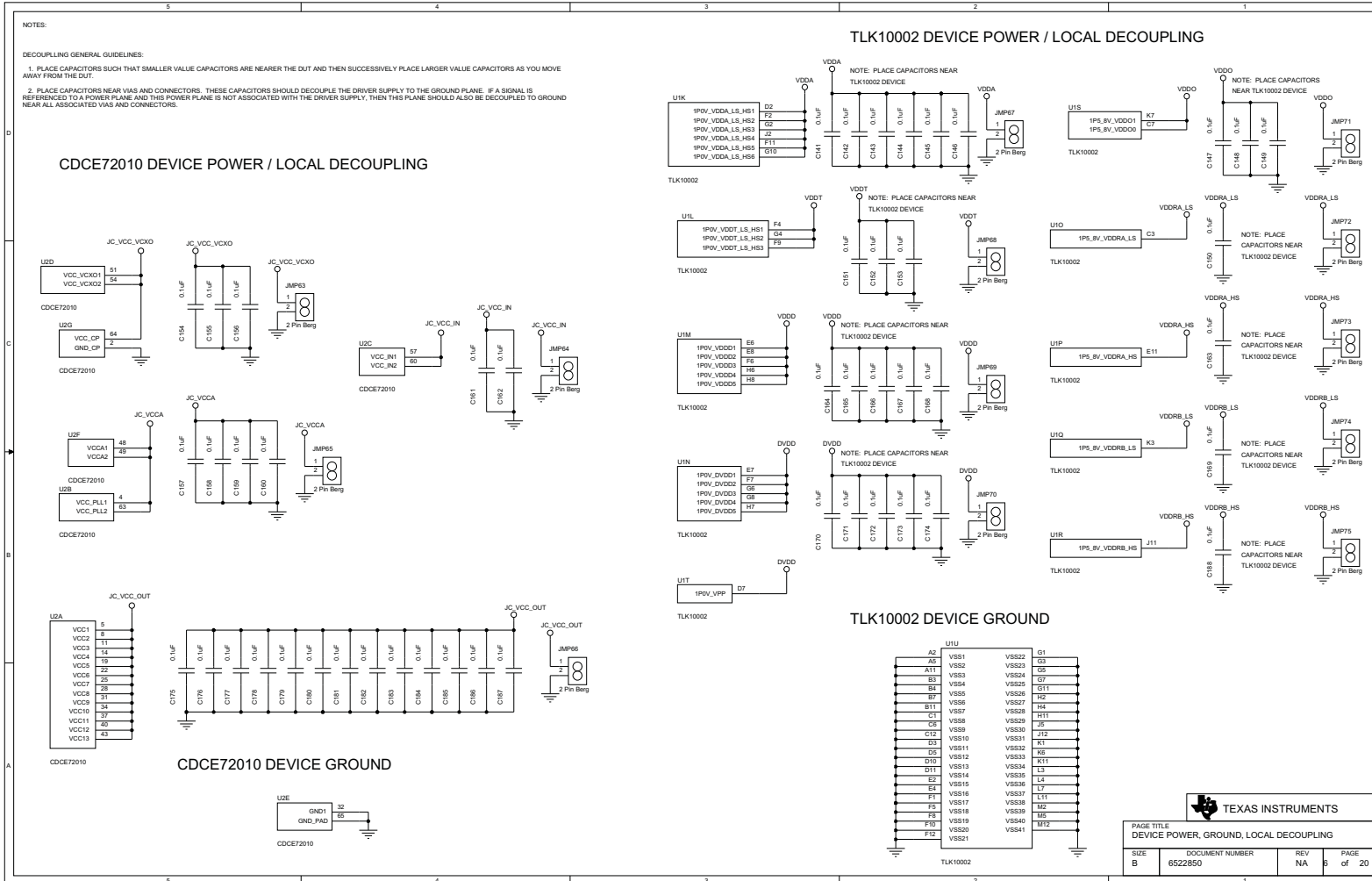

Figure 14. Device Power, Ground, and Local Decoupling, Sheet 6 of 20

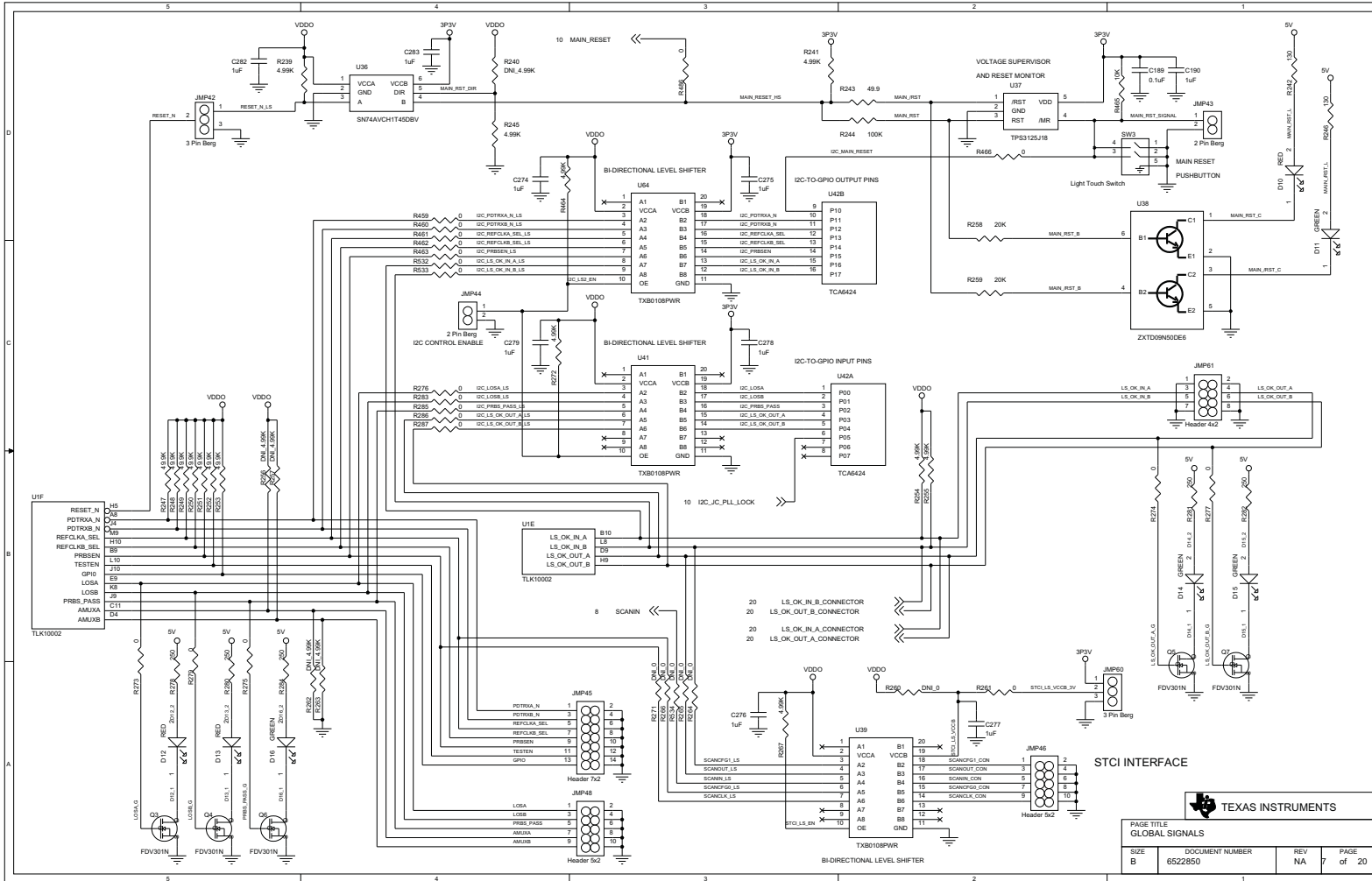
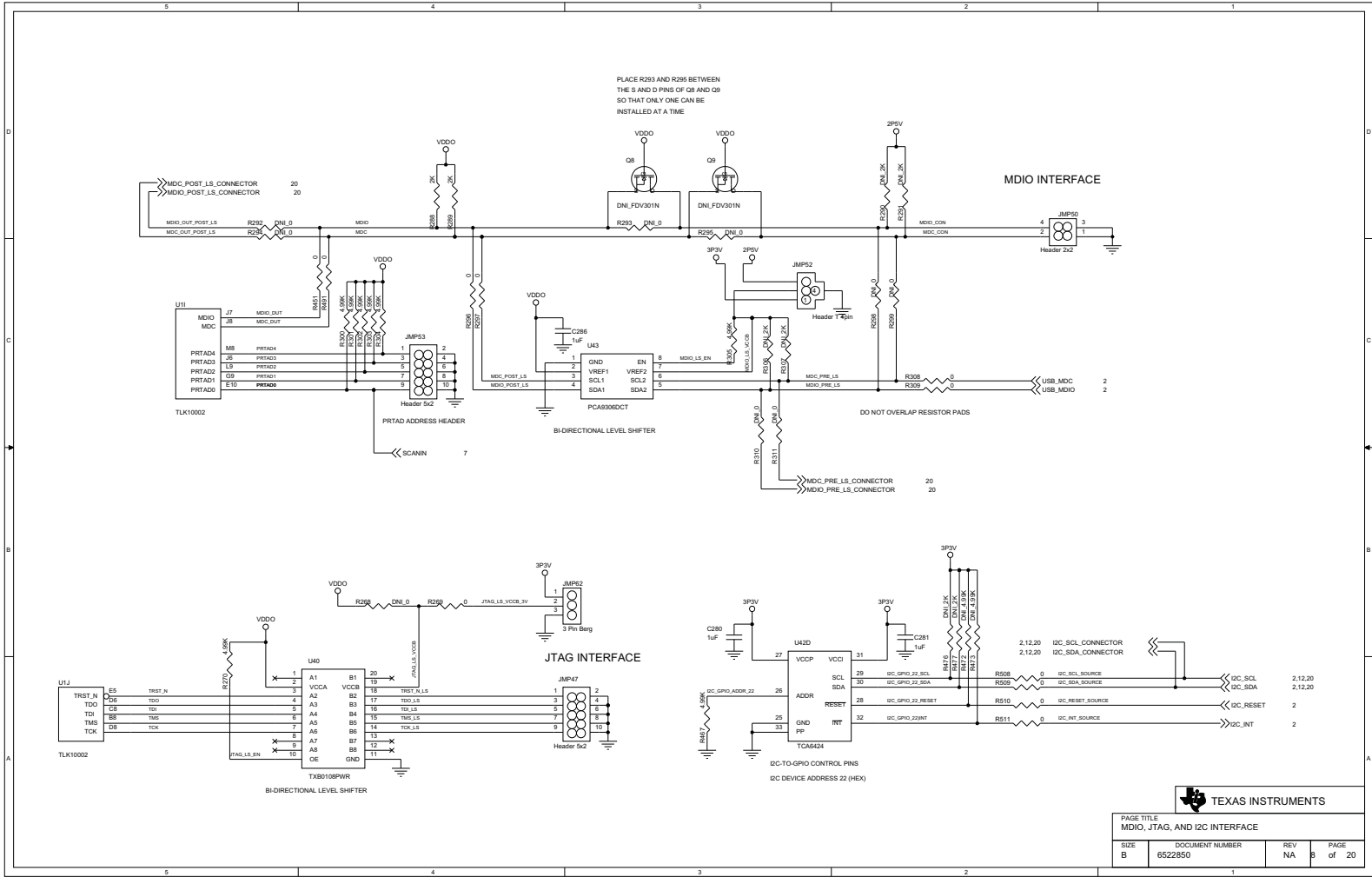
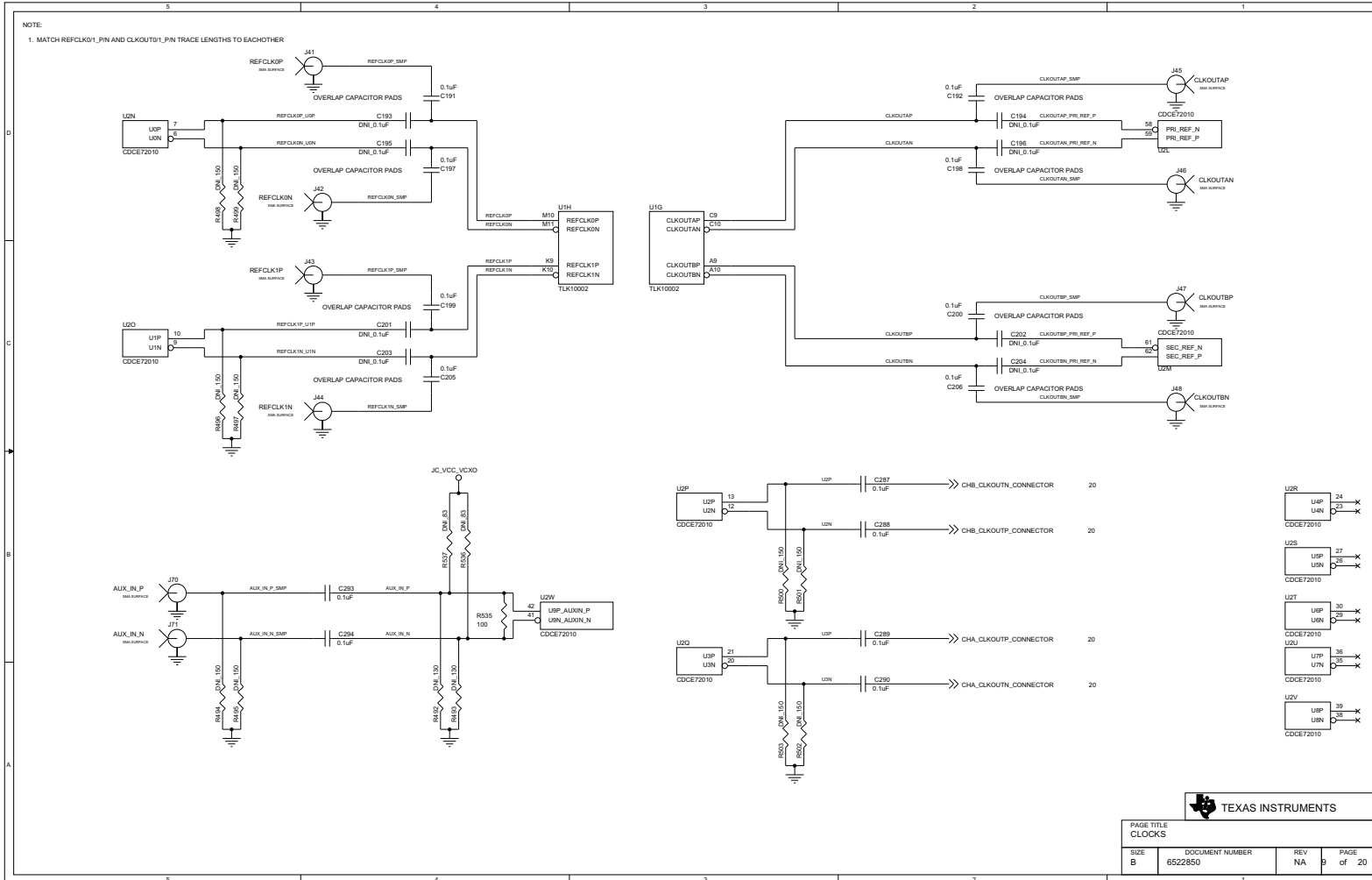

Figure 15. Global Signals, Sheet 7 of 20





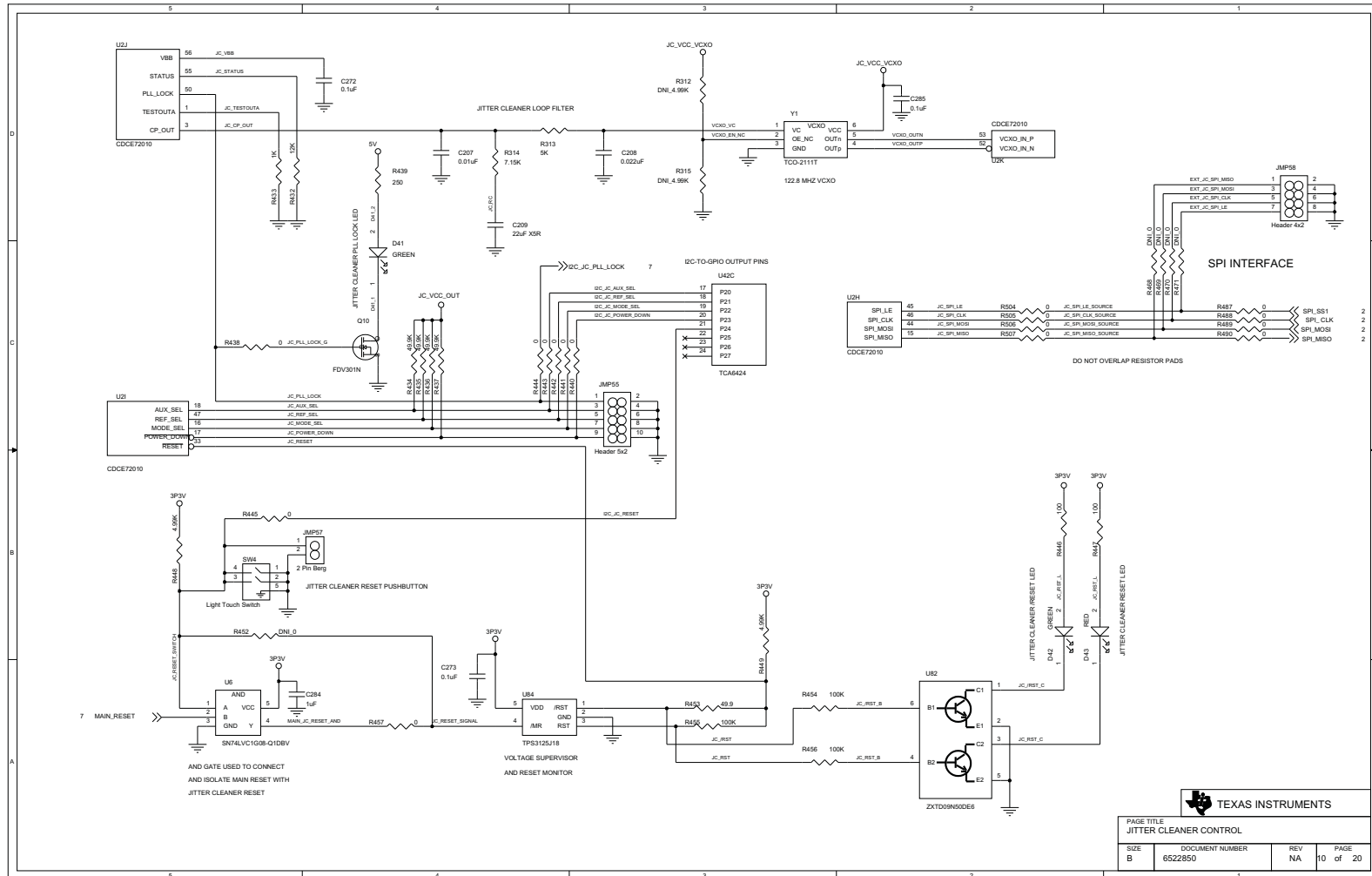

Figure 18. Jitter Cleaner Control, Sheet 10 of 20

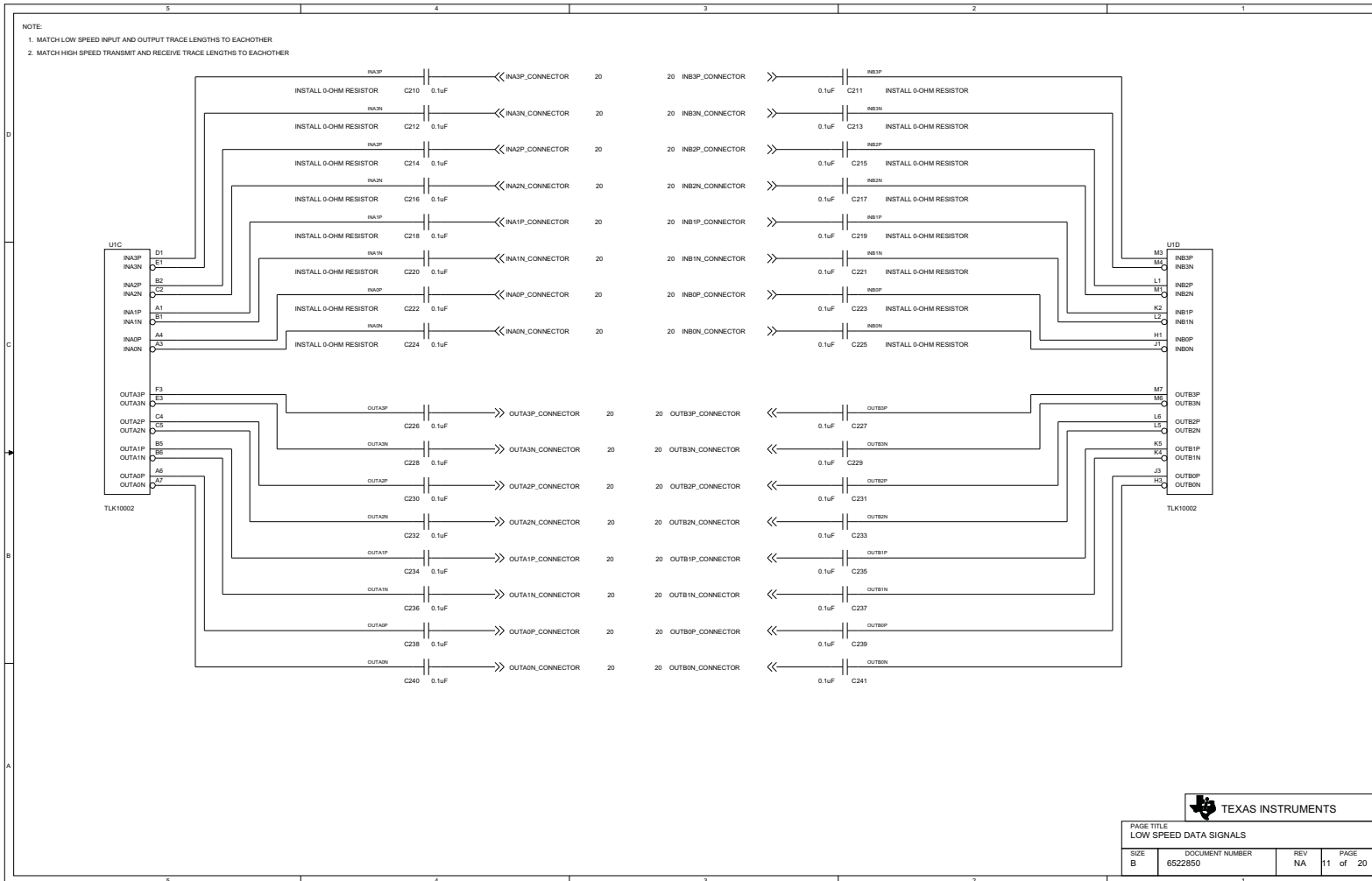

Figure 19. Low-Speed Data Signals, Sheet 11 of 20

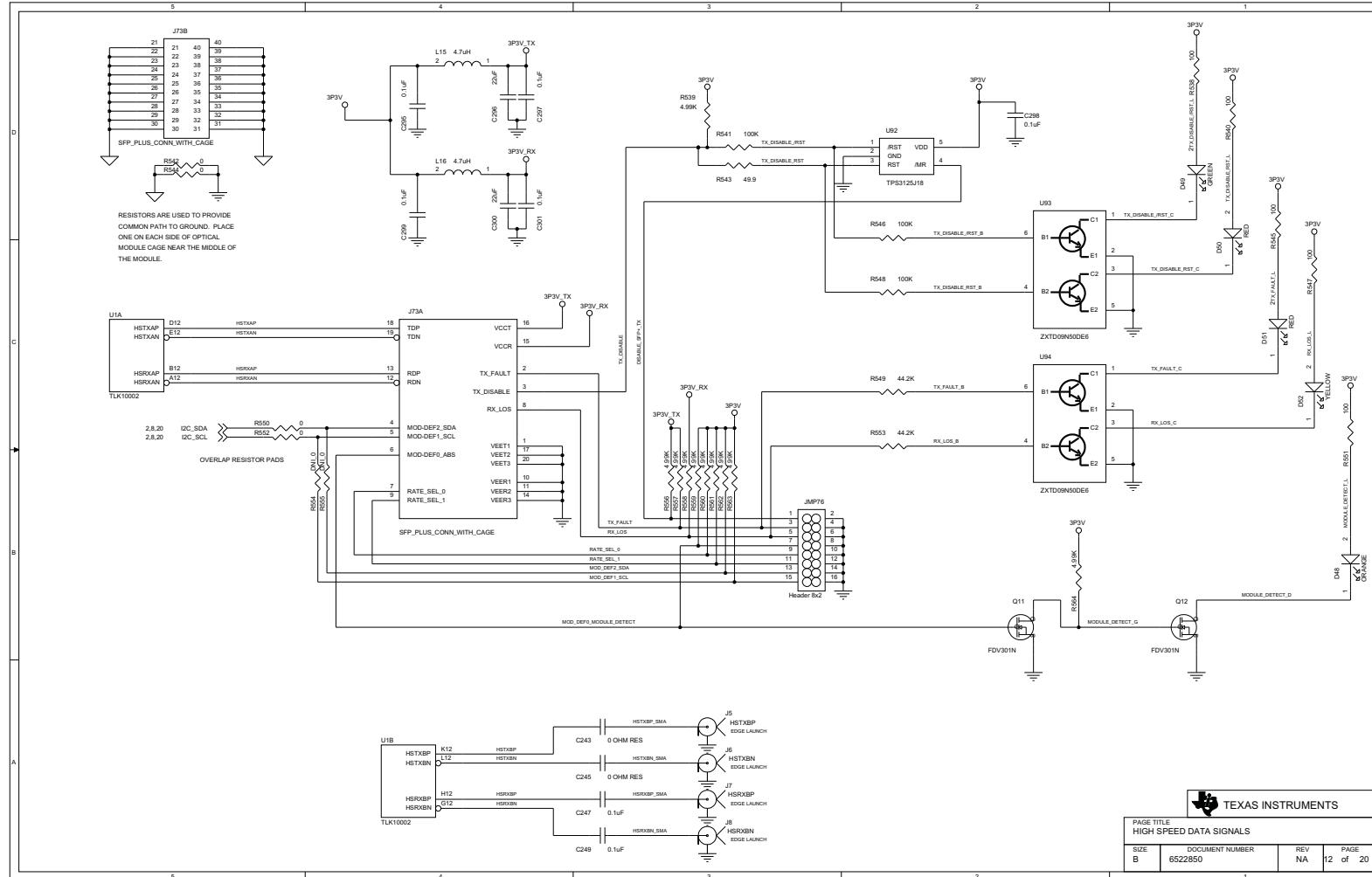

Figure 20. High-Speed Data Signals, Sheet 12 of 20

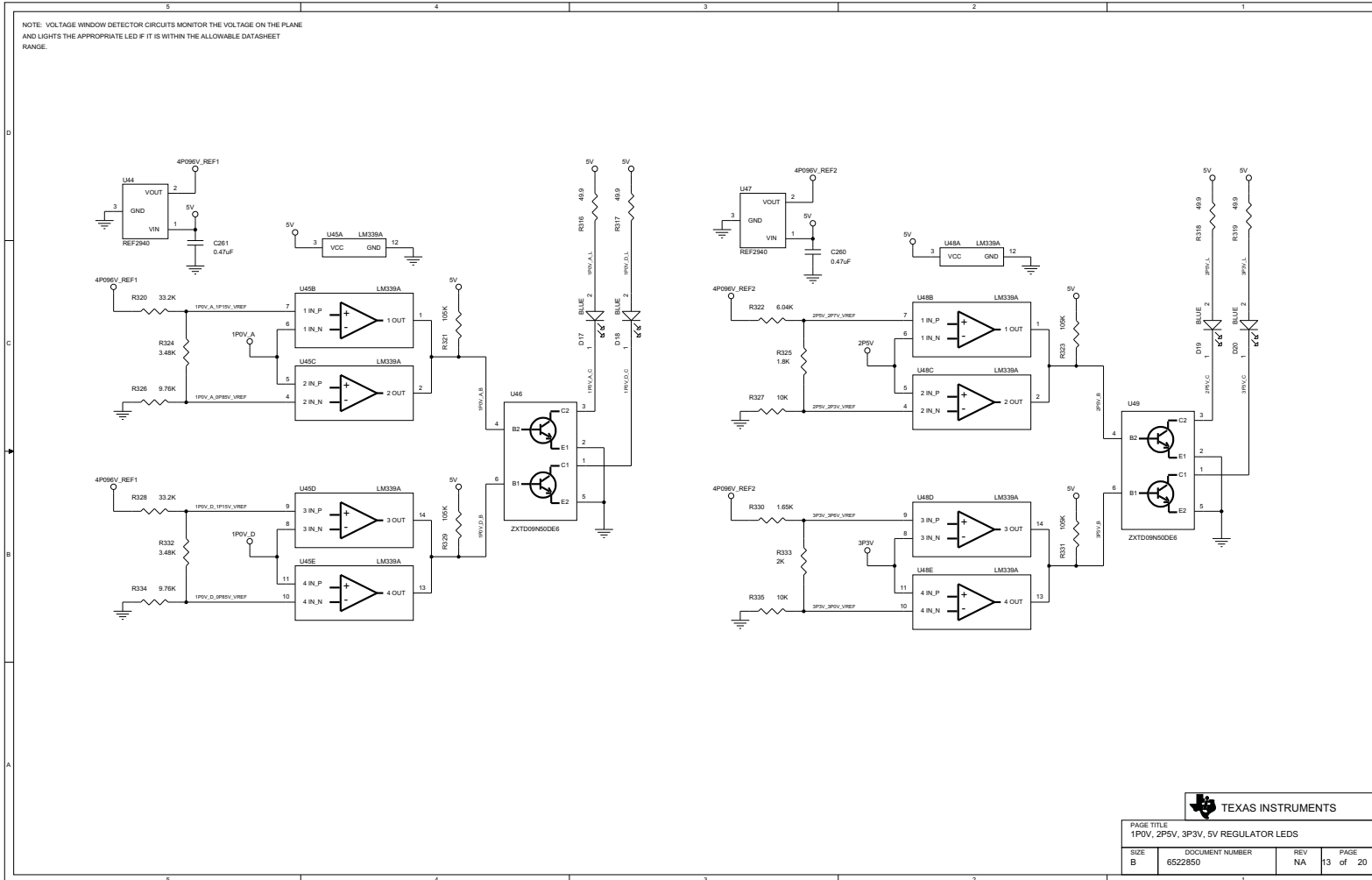

Figure 21. 1P0V, 2P5V, and 3P3V Regulator LEDs, Sheet 13 of 20

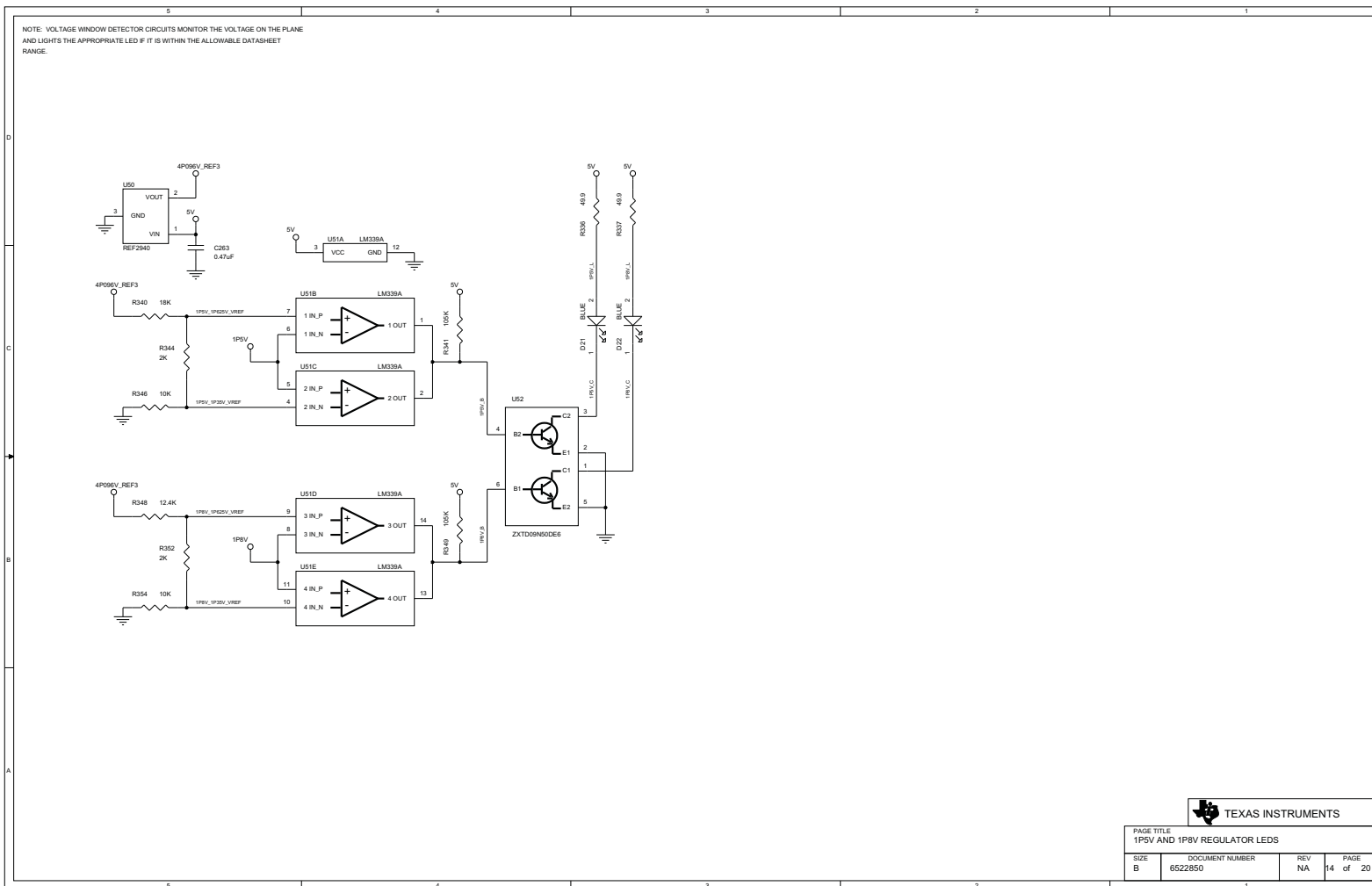

Figure 22. 1P5/8V Regulator LEDs, Sheet 14 of 20

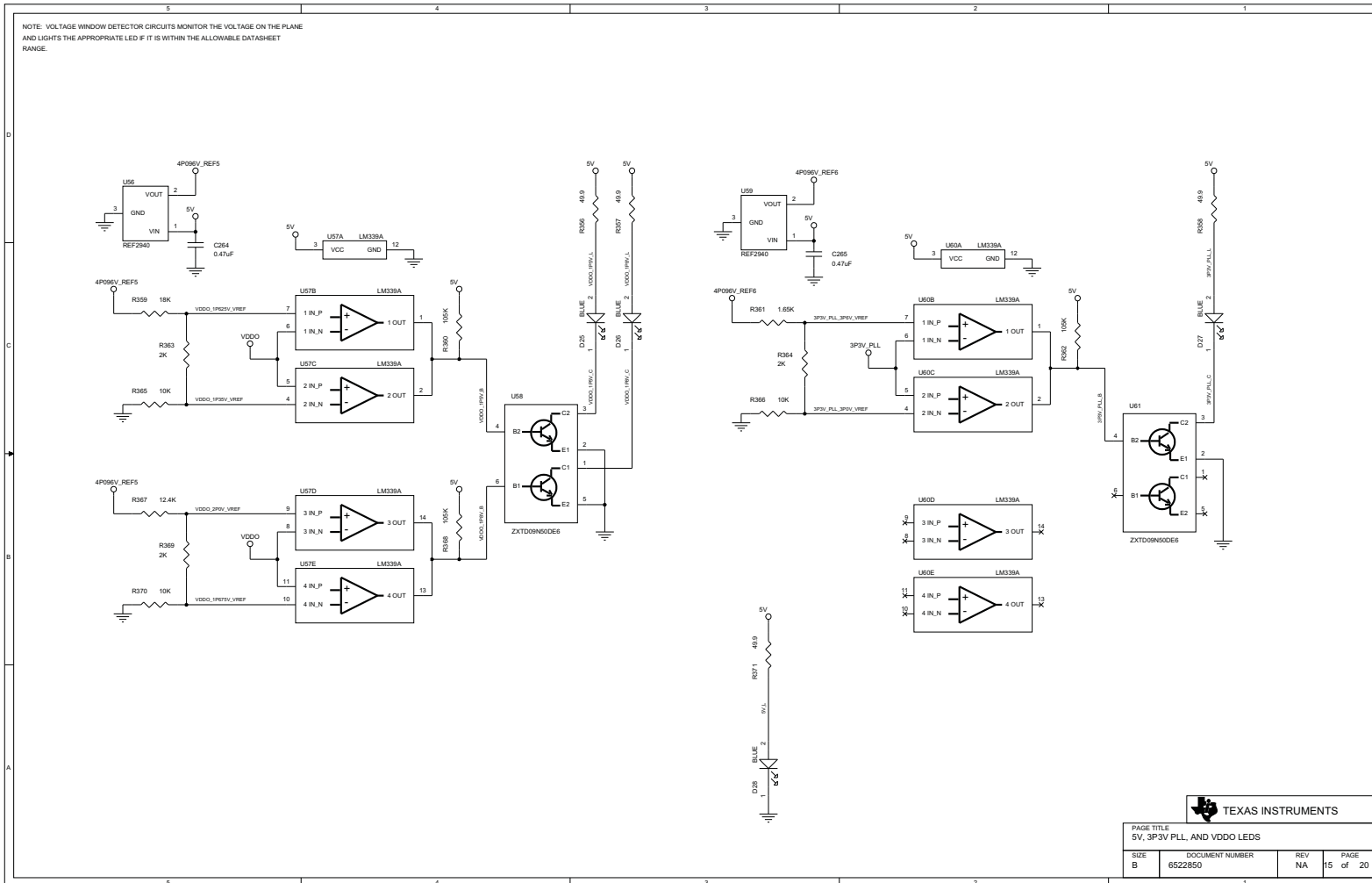
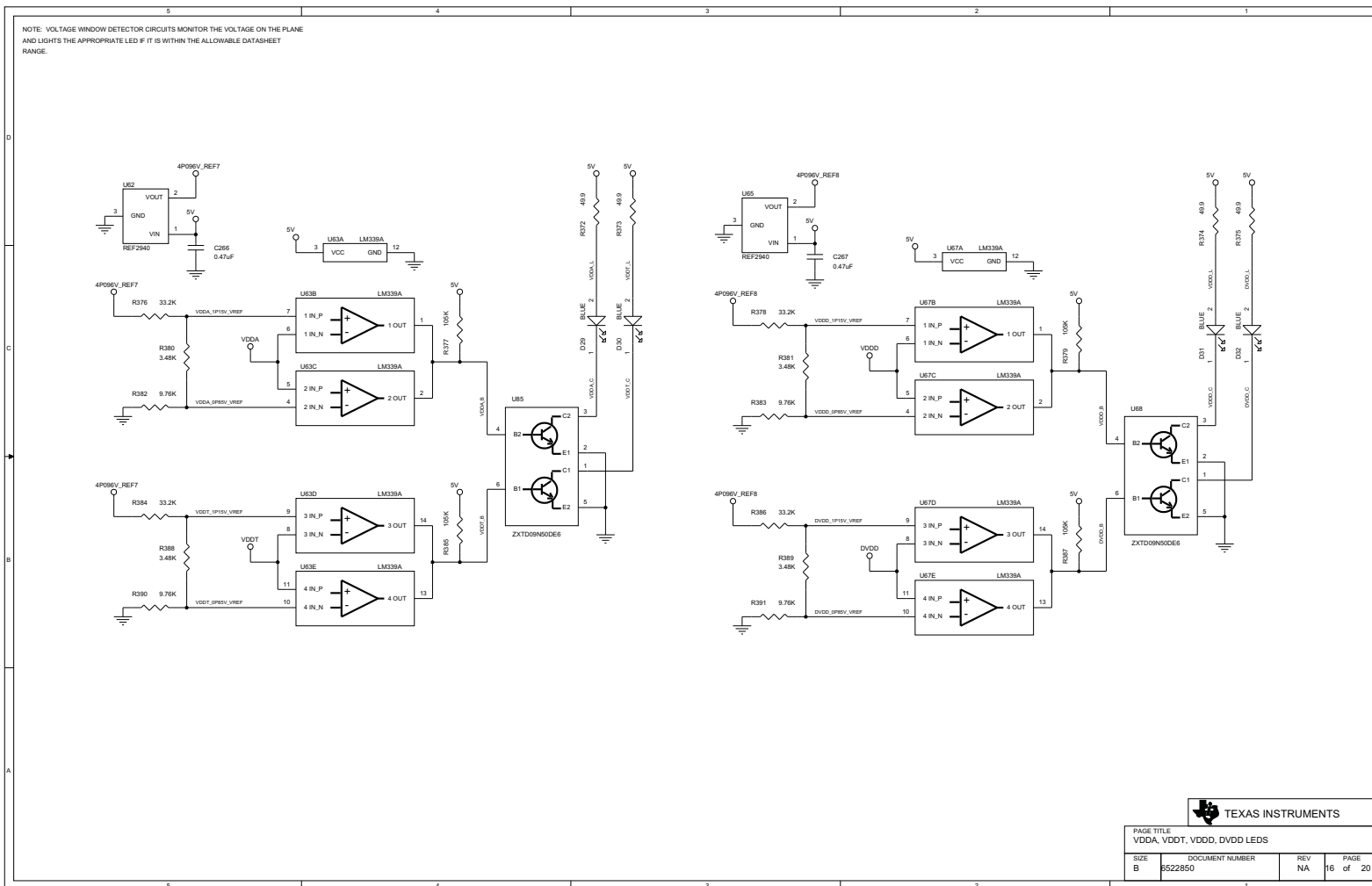

Figure 23. 5-V, 3P3V_PLL, and VDDO LEDs, Sheet 15 of 20



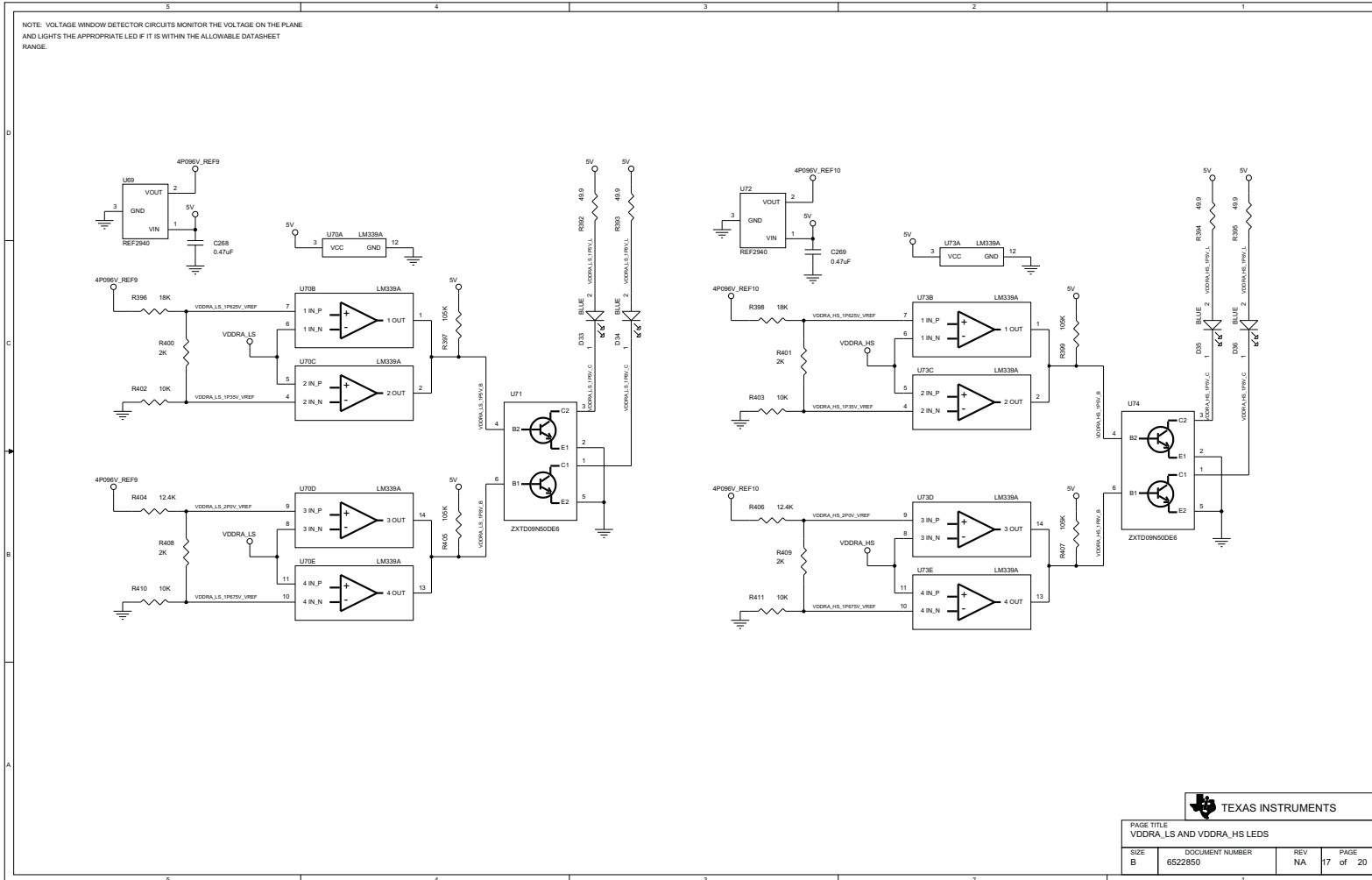

Figure 25. VDDRA LEDs, Sheet 17 of 20

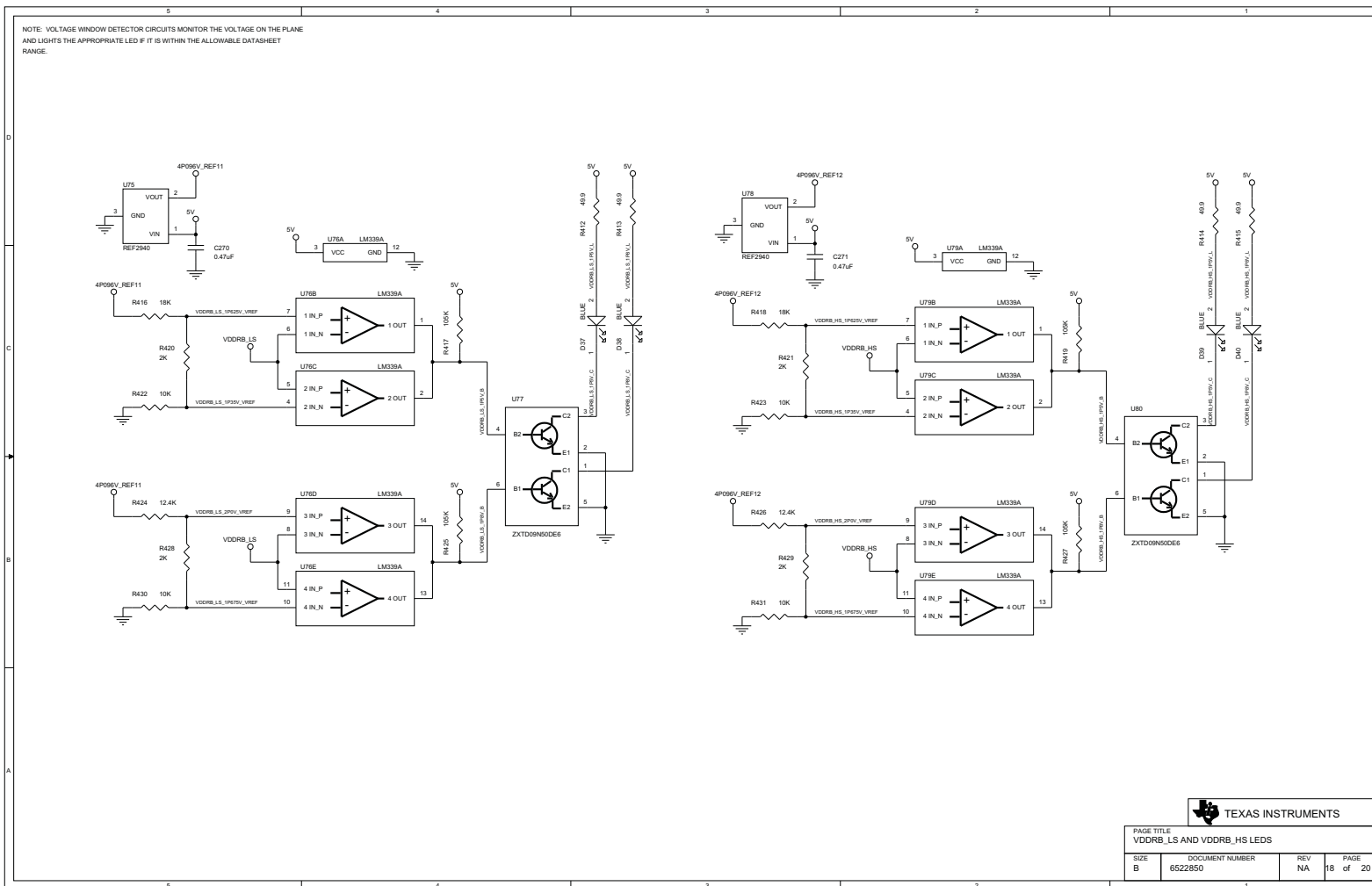

Figure 26. VDDR_B LEDs, Sheet 18 of 20

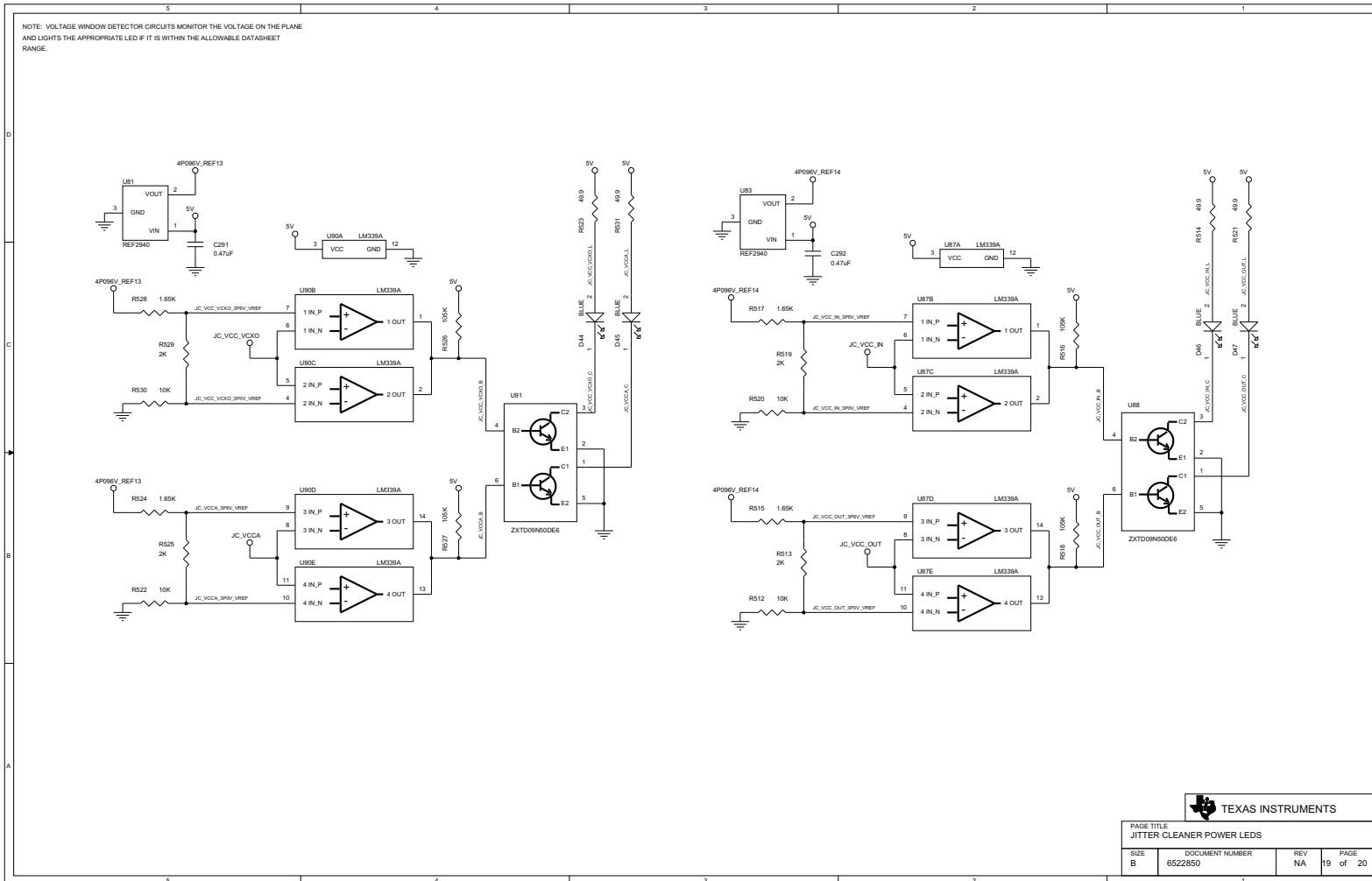

Figure 27. Jitter Cleaner Power LEDs, Sheet 19 of 20

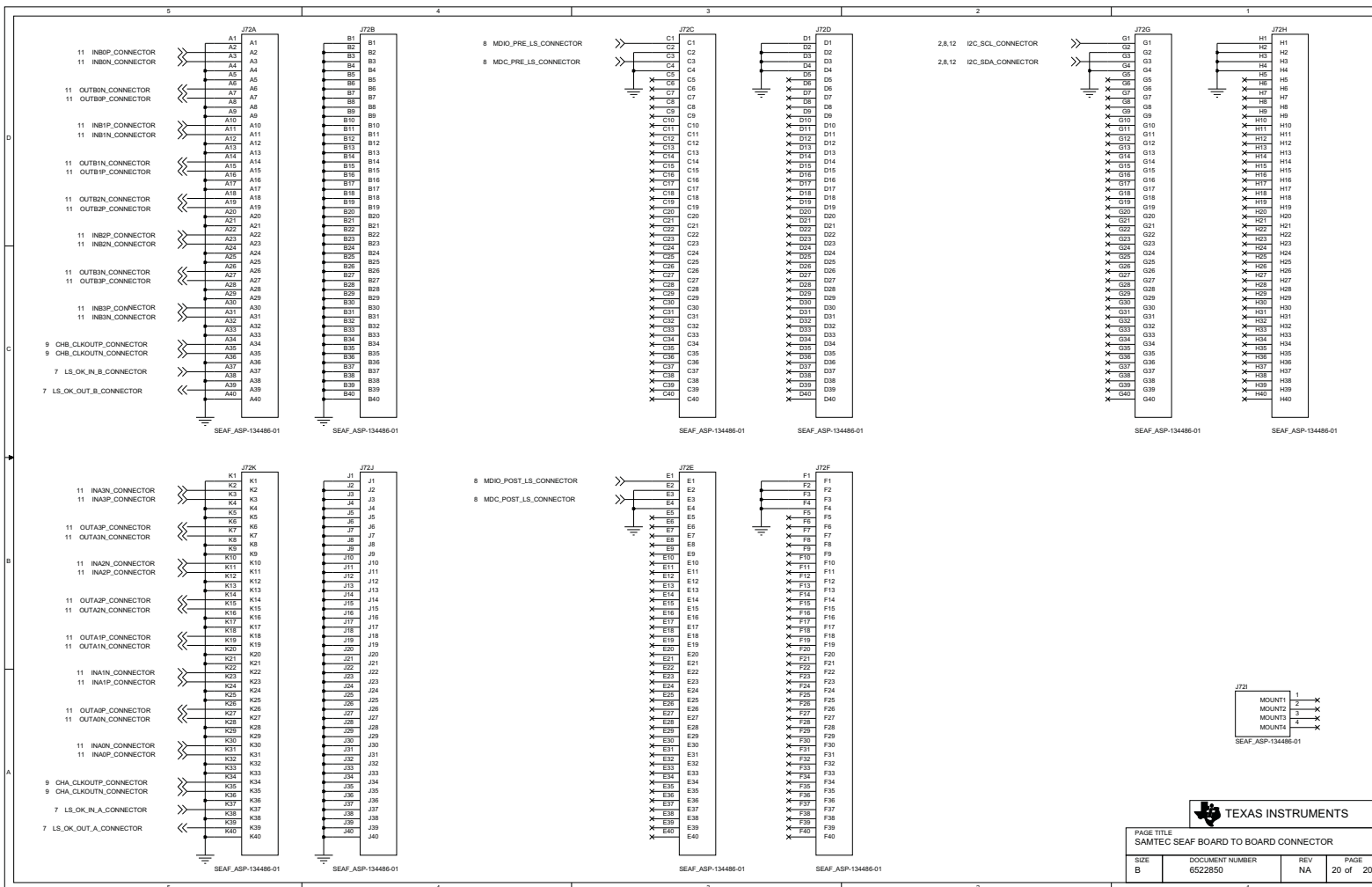

Figure 28. Board-To-Board Connector, Sheet 20 of 20

11 TLK10002EVM Motherboard Bill of Materials

Table 1. TLK10002EVM Motherboard Bill of Materials

Item	Qty	Reference	Value	Part	Part Number	Manufacturer
1	58	C191, C192, C193, C194, C195, C196, C197, C198, C199, C200, C201, C202, C203, C204, C205, C206, C210, C211, C212, C213, C214, C215, C216, C217, C218, C219, C220, C221, C222, C223, C224, C225, C226, C227, C228, C229, C230, C231, C232, C233, C234, C235, C236, C237, C238, C239, C240, C241, C243, C245, C247, C249, C287, C288, C289, C290, C293, C294	0.1µF	0201 CAP	C0201X5R6R3-104KNE	Venkel
2	64	C2, C4, C6, C7, C8, C12, C13, C14, C141, C142, C143, C144, C145, C146, C147, C148, C149, C150, C151, C152, C153, C154, C155, C156, C157, C158, C159, C160, C161, C162, C163, C164, C165, C166, C167, C168, C169, C170, C171, C172, C173, C174, C175, C176, C177, C178, C179, C180, C181, C182, C183, C184, C185, C186, C187, C188, C189, C272, C285, C295, C297, C298, C299, C301	0.1µF	0402 CAP	C0402X7R160-104KNE	Venkel
3	13	C260, C261, C263, C264, C265, C266, C267, C268, C269, C270, C271, C291, C292	0.47µF	0402 CAP	C0402X5R6R3-474KNE	Venkel
4	14	C9, C190, C274, C275, C276, C277, C278, C279, C280, C281, C282, C283, C284, C286	1.0µF	0402 CAP	C0402X5R6R3-105KNE	Venkel
5	2	C10, C11	22pF	0402 CAP	C0402COG500-220JNE	Venkel
6	1	C208	0.022µF	0603 CAP	GRM188R72A223KAC4D	Murata Electronics North America
7	1	C273	0.1µF	0603 CAP	C0603X7R500-104KNE	Venkel
8	7	C19, C26, C31, C45, C59, C66, C73	1.0µF	0603 CAP	C1608X7R1C105K	TDK Corporation
9	1	C207	10000pF	0603 CAP	C1608X7R1H103K	TDK Corporation
10	7	C21, C28, C35, C49, C63, C70, C77	1000pF	0603 CAP	C0603X7R101-102KNE	Venkel
11	1	C5	10µF	0603 CAP	ECJ-1VBOJ106M	Panasonic
12	7	C16, C23, C30, C44, C58, C65, C72	4.7µF	0603 CAP	C0603C475K8PACTU	Kemet
13	11	C83, C87, C91, C98, C101, C111, C115, C121, C125, C130, C140	0.01µF	0805 CAP	GRM21BR72A103KA01L	Murata Electronics North America
14	15	C79, C80, C84, C93, C97, C107, C108, C117, C118, C127, C132, C133, C134, C135, C137	10µF	0805 CAP	EMK212BJ106KG-T	Taiyo Yuden
15	2	C296, C300	22µF	0805 CAP	C0805C226M9PACTU	Kemet
16	11	C82, C86, C90, C95, C100, C110, C114, C120, C124, C129, C139	0.1µF	1206 CAP	C1206C104J5RACTU	Kemet
17	18	C20, C27, C34, C48, C62, C69, C76, C81, C85, C89, C94, C99, C109, C113, C119, C123, C128, C138	1.0µF	1206 CAP	C1206X7R250-105KNE	Venkel
18	7	C18, C25, C33, C47, C61, C68, C75	10µF	1206 CAP	C1206X7R160-106KNE	Venkel
19	1	C209	22µF	1206 CAP	GCM31CR70J226KE23L	Murata Electronics North America
20	8	C17, C24, C32, C46, C60, C67, C74, C136	68µF	1210 CAP	C3225X5R0J686M	TDK Corporation
21	7	C15, C22, C29, C43, C57, C64, C71	100µF	1812 CAP	GRM43SR60J107ME20L	Murata Electronics North America

Table 1. TLK10002EVM Motherboard Bill of Materials (continued)

Item	Qty	Reference	Value	Part	Part Number	Manufacturer
22	6	R296, R297, R308, R309, R451, R491	0.0 (Zero Ohm)	0201 RES	CR0201-20W-000T	Venkel
23	1	R535	100	0201 RES	ERJ-1GEF1000C	Panasonic - ECG
24	41	R273, R274, R275, R276, R277, R279, R283, R285, R286, R287, R438, R440, R441, R442, R443, R444, R445, R457, R459, R460, R461, R462, R463, R466, R486, R487, R488, R489, R490, R504, R505, R506, R507, R508, R509, R510, R511, R532, R533, R550, R552	0.0 (Zero Ohm)	0402 RES	ERJ-2GE0R00X	Panasonic - ECG
25	1	R433	1.00K	0402 RES	RG1005P-102-B-T5	Susumu Co Ltd
26	1	R24	1.00M	0402 RES	CR0402-16W-1004FT	Venkel
27	3	R20, R41, R42	1.50K	0402 RES	RG1005P-152-B-T5	Susumu
28	6	R330, R361, R515, R517, R524, R528	1.65K	0402 RES	ERJ-2RKF1651X	Panasonic - ECG
29	1	R325	1.80K	0402 RES	RG1005P-182-B-T5	Susumu Co Ltd
30	19	R327, R335, R346, R354, R365, R366, R370, R402, R403, R410, R411, R422, R423, R430, R431, R512, R520, R522, R530	10.0K	0402 RES	RG1005P-103-B-T5	Susumu Co Ltd
31	5	R1, R2, R4, R23, R551	100	0402 RES	RG1005P-101-B-T5	Susumu Co Ltd
32	10	R3, R5, R10, R11, R13, R17, R454, R456, R546, R548	100K	0402 RES	RG1005P-104-B-T5	Susumu
33	25	R321, R323, R329, R331, R341, R349, R360, R362, R368, R377, R379, R385, R387, R397, R399, R405, R407, R417, R419, R425, R427, R516, R518, R526, R527	105K	0402 RES	ERJ-2RKF1053X	Panasonic - ECG
34	1	R432	12.0K	0402 RES	RG1005P-123-B-T5	Susumu
35	6	R348, R367, R404, R406, R424, R426	12.4K	0402 RES	RG1005P-1242-B-T5	Susumu Co Ltd
36	1	R16	15.0K	0402 RES	RG1005P-153-B-T5	Susumu
37	6	R340, R359, R396, R398, R416, R418	18.0K	0402 RES	RG1005P-183-B-T5	Susumu Co Ltd
38	22	R14, R15, R18, R19, R333, R344, R352, R363, R364, R369, R400, R401, R408, R409, R420, R421, R428, R429, R513, R519, R525, R529	2.00K	0402 RES	RG1005P-202-B-T5	Susumu
39	2	R258, R259	20.0K	0402 RES	RG1005P-203-B-T5	Susumu
40	6	R278, R280, R281, R282, R284, R439	249	0402 RES	RR0510P-2490-D	Susumu Co Ltd
41	6	R324, R332, R380, R381, R388, R389	3.48K	0402 RES	ERJ-2RKF3481X	Panasonic - ECG
42	2	R21, R22	33	0402 RES	RR0510R-330-D	Susumu Co Ltd
43	6	R320, R328, R376, R378, R384, R386	33.2K	0402 RES	RR0510P-3322-D	Panasonic - ECG
44	46	R7, R25, R26, R27, R28, R32, R33, R34, R43, R44, R45, R46, R47, R48, R245, R247, R248, R249, R250, R251, R252, R253, R254, R255, R270, R300, R301, R302, R303, R304, R434, R435, R436, R437, R450, R474, R475, R556, R557, R558, R559, R560, R561, R562, R563, R564	4.99K	0402 RES	RG1005P-4991-B-T5	Susumu Co Ltd
45	2	R549, R553	44.2K	0402 RES	TNPW040244K2BEED	Vishay/Dale
46	1	R8	49.9	0402 RES	RG1005P-49R9-B-T5	Susumu Co Ltd

Table 1. TLK1002EVM Motherboard Bill of Materials (continued)

Item	Qty	Reference	Value	Part	Part Number	Manufacturer
47	1	R322	6.04K	0402 RES	RG1005P-6041-B-T5	Susumu Co Ltd
48	6	R326, R334, R382, R383, R390, R391	9.76K	0402 RES	RG1005P-9761-B-T5	Susumu Co Ltd
49	2	R261, R269	0.0 (Zero Ohm)	0603 RES	ERJ-3GEY0R00V	Panasonic - ECG
50	2	R171, R188	1.10K	0603 RES	RG1608P-112-B-T5	Susumu Co Ltd
51	2	R50, R67	1.13K	0603 RES	RR0816P-1131-D-06H	Susumu Co Ltd
52	1	R154	1.54K	0603 RES	RR0816P-1541-D-19H	Susumu Co Ltd
53	1	R465	10.0K	0603 RES	ERA-3AEB103V	Panasonic - ECG
54	6	R446, R447, R538, R540, R545, R547	100	0603 RES	RG1608P-101-B-T5	Susumu Co Ltd
55	3	R244, R455, R541	100K	0603 RES	TNPW06031003BT9	Vishay/Dale
56	2	R242, R246	130	0603 RES	RG1608P-131-B-T5	Susumu Co Ltd
57	2	R288, R289	2.00K	0603 RES	RN731JTTD2001B25	KOA Speer
58	1	R120	2.67K	0603 RES	RG1608P-2671-B-T5	Susumu Co Ltd
59	4	R118, R152, R169, R186	3.57K	0603 RES	RG1608P-3571-B-T5	Susumu Co Ltd
60	2	R52, R69	4.02K	0603 RES	RG1608P-4021-B-T5	Susumu Co Ltd
61	1	R84	4.12K	0603 RES	RG1608P-4121-B-T5	Susumu Co Ltd
62	1	R86	4.30K	0603 RES	RG1608P-432-B-T5	Susumu Co Ltd
63	17	R49, R66, R83, R117, R151, R168, R185, R239, R241, R267, R272, R305, R448, R449, R464, R467, R539	4.99K	0603 RES	RG1608P-4991-B-T5	Susumu Co Ltd
64	1	R313	4.99K	0603 RES	RG1608P-4991-B-T5	Susumu Co Ltd
65	29	R243, R316, R317, R318, R319, R336, R337, R356, R357, R358, R371, R372, R373, R374, R375, R392, R393, R394, R395, R412, R413, R414, R415, R453, R514, R521, R523, R531, R543	49.9	0603 RES	RG1608P-49R9-B-T1	Susumu Co Ltd
66	1	R314	7.15K	0603 RES	RG1608P-7151-B-T5	Susumu Co Ltd
67	2	R542, R544	0.0 (Zero Ohm)	0805 RES	RC0805JR-070RL	Yageo America
68	10	L1, L2, L3, L4, L5, L6, L7, L8, L9, L14	0.0 (Zero Ohm)	1210 RES	RK73Z2ETTE	KOA Speer
69	4	L10, L11, L12, L13	1000uH	0603 600mA IND	BLM18HE102SN1D	Murata Electronics North
70	2	L15, L16	4.7µH	1210 220mA IND	NLV32T-4R7J-PF	TDK Corporation
71	26	D17, D18, D19, D20, D21, D22, D25, D26, D27, D28, D29, D30, D31, D32, D33, D34, D35, D36, D37, D38, D39, D40, D44, D45, D46, D47	LED - Blue	C170	HSMR-C170	Avago Technologies US Inc.
72	9	D1, D4, D11, D14, D15, D16, D41, D42, D49	LED - Green	C170	HSMG-C170	Avago Technologies US Inc.
73	2	D3, D48	LED - Orange	C170	HSMD-C170	Avago Technologies US Inc.
74	7	D2, D10, D12, D13, D43, D50, D51	LED - Red	C170	SML-LXT0805IW-TR	Lumex Opto/Components
75	1	D52	LED - Yellow	C170	SML-LXT0805YW-TR	Lumex Opto/Components
76	1	D9	Zener Diode 3A, 10V	SOD-323	BAT 60A E6327	Infineon Technologies
77	8	Q3, Q4, Q5, Q6, Q7, Q10, Q11, Q12	NFET	SOT-23	FDV301N	Fairchild Semiconductor
78	2	Q1, Q2	NPN	SOT-23-3	MMBT4401	Fairchild Semiconductor

Table 1. TLK10002EVM Motherboard Bill of Materials (continued)

Item	Qty	Reference	Value	Part	Part Number	Manufacturer
79	18	U7, U38, U46, U49, U52, U58, U61, U68, U71, U74, U77, U80, U82, U85, U88, U91, U93, U94	Dual NPN	SOT-23-6	ZXTD09N50DE6TA	Zetex Inc
80	13	U45, U48, U51, U57, U60, U63, U67, U70, U73, U76, U79, U87, U90	Differential Comparator	14-TSSOP	LM339APWR	Texas Instruments
81	1	U1	10Gbps SerDes	144-BGA	TLK10002	Texas Instruments
82	4	U39, U40, U41, U64	Bi-Directional Level Shifter	20-TSSOP	TXB0108PWR	Texas Instruments
83	7	U8, U10, U12, U16, U20, U22, U24	Adjustable LDO	20-VQFN	TPS74401RGWT	Texas Instruments
84	1	U42	I2C to GPIO Expander	32-QFN	TCA6424RGJR	Texas Instruments
85	1	U3	USB Microcontroller	64-LQFP	TUSB3210PM	Texas Instruments
86	1	U2	Jitter Cleaner	64-QFN	CDCE72010RGCT	Texas Instruments
87	1	U4	512Kb EEPROM	8-SOIC	24LC512-I/SM	Microchip Technology
88	1	U43	Bi-Directional Level Shifter	8-SSOP	PCA9306DCTR	Texas Instruments
89	13	U44, U47, U50, U56, U59, U62, U65, U69, U72, U75, U78, U81, U83	Precision Voltage Reference	SOT-23-3	REF2940AIDBZT	Texas Instruments
90	1	U6	2-Input AND Gate	SOT-23-5	SN74LVC1G08DBVR	Texas Instruments
91	4	U5, U37, U84, U92	Voltage Supervisor with Manual Reset	SOT-23-5	TPS3125J18DBVR	Texas Instruments
92	1	U36	Bi-Directional Level Shifter	SOT-23-6	SN74AVCH1T45DCKR	Texas Instruments
93	1	Y1	122.88 MHz VCXO	13.9mmX8.75mm	TCO-2111T 122.8800MHZ	Toyocom
94	1	X1	12.000MHz Crystal	SMD	ECS-120-32-5PVX	ECS Inc
95	3	SW2, SW3, SW4	Momentary Push Button Switch	6.00mm x 6.00mm	EVQ-PBE05R	Panasonic - ECG
96	1	SW1	1-Position Dip Switch	SMT	SDA01H0SB	ITT Cannon - CK
97	1	J73	SFP+ Connector	SMT	1888247-1	Amp/Tyco
98	1	J72	Board-to-Board Connector	SMT	ASP-134486-01	Samtec
99	23	JMP1, JMP3, JMP5, JMP9, JMP13, JMP15, JMP17, JMP43, JMP44, JMP57, JMP63, JMP64, JMP65, JMP66, JMP67, JMP68, JMP69, JMP70, JMP71, JMP72, JMP73, JMP74, JMP75	1 X 2	0.1"	HTSW-150-08-G-S	Samtec
100	5	JMP35, JMP41, JMP42, JMP60, JMP62	1 X 3	0.1"	HTSW-150-08-G-S	Samtec
101	1	JMP52	1 X 4 T	0.1"	HTSW-150-08-G-S	Samtec
102	1	JMP45	2 X 7	0.1x0.1"	HTSW-150-08-G-D	Samtec
103	5	JMP46, JMP47, JMP48, JMP53, JMP55	2 X 5	0.1x0.1"	HTSW-150-08-G-D	Samtec
104	1	JMP50	2 X 2	0.1x0.1"	HTSW-150-08-G-D	Samtec
105	2	JMP58, JMP61	2 X 4	0.1x0.1"	HTSW-150-08-G-D	Samtec
106	1	JMP76	2 X 8	0.1x0.1"	HTSW-150-08-G-D	Samtec
107	1	P26	Power Jack	2.1mm	PJ-002AH	CUI Inc
108	2	P1, P14	Banana Plug - Metal	4mm	108-0740 -001	Emerson Network Pwr Co
109	1	J65	USB - B Type	B Type	897-43-004-90-000000	Mill-Max Manufacturing Co
110	4	J5, J6, J7, J8	Edge Launch SMA	RF Screw Type	32K243-40ML5	Rosenberger
111	10	J41, J42, J43, J44, J45, J46, J47, J48, J70, J71	Surface Mount SMA	T/H_SMT SMA	32K141-40ML5	Rosenberger

Table 1. TLK10002EVM Motherboard Bill of Materials (continued)

Item	Qty	Reference	Value	Part	Part Number	Manufacturer
112	4	Standoff	10mm	10,15) .400	SO-1015-03-01-02	Samtec
113	4	Screws	4-40/0.25"- Screws	4-40/0.25"- Screws	PMSSS 440 0025 PH	Building Fasteners
114	4	Standoff	0.5"	0.5"	2027	Keystone Electronics
115	18	Shunt	0.1" SP	0.1" SP	151-8000-E	Kobiconn
116	60	R298, R299, R536, R537, R492, R493, R494, R495, R496, R497, R498, R499, R500, R501, R502, R503, R264, R265, R266, R271, R452, R468, R469, R470, R471, R534, R554, R555, R476, R477, R29, R30, R31, R35, R36, R37, R38, R39, R40, R240, R256, R257, R262, R263, R472, R473, R260, R268, R292, R293, R294, R295, R310, R311, R290, R291, R306, R307, R312, R315	DNI			
117	2	Q8, Q9	DNI			

12 TLK1002EVM Motherboard Layout

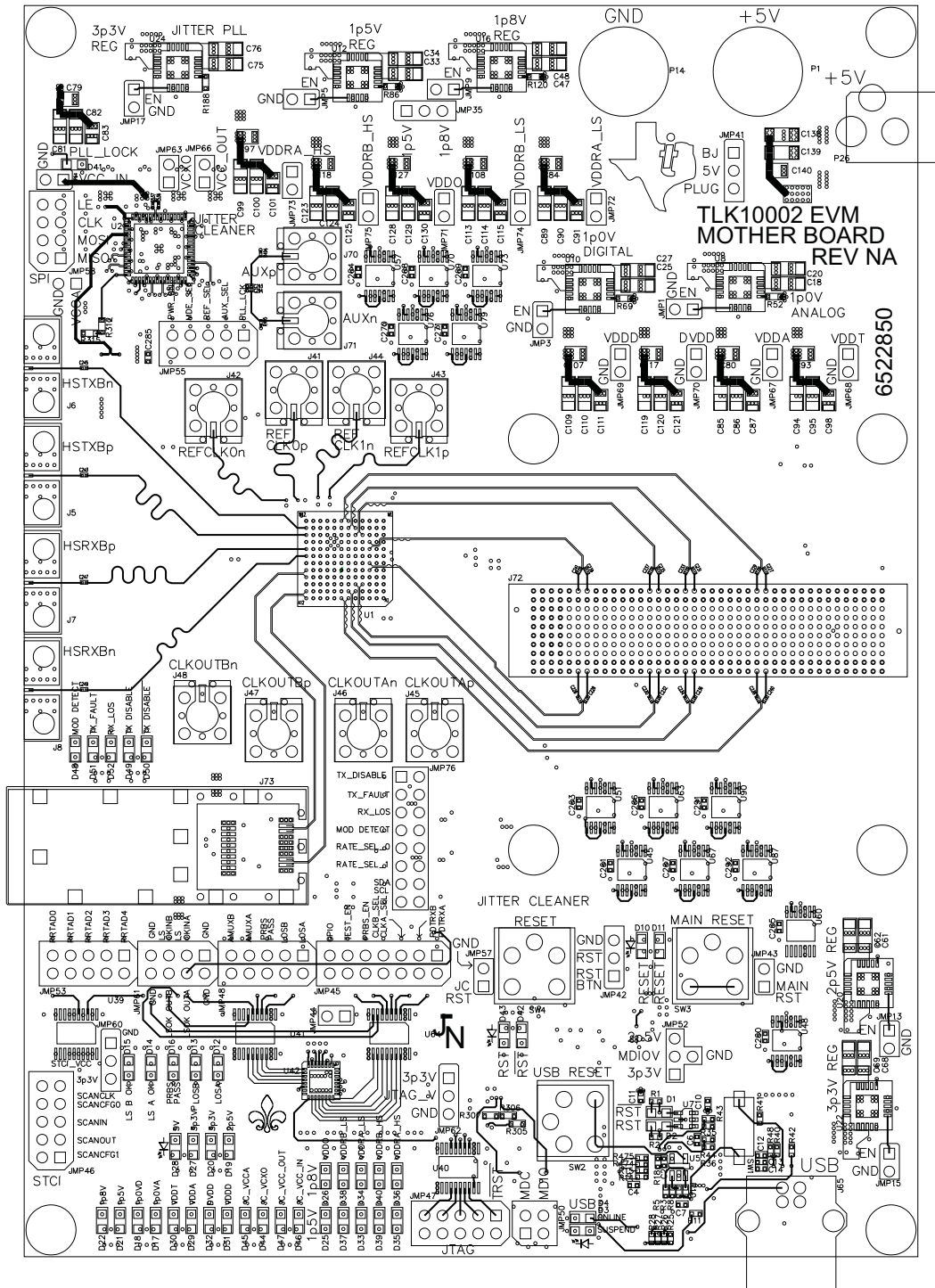

Figure 29. Top Signal, Layer 1

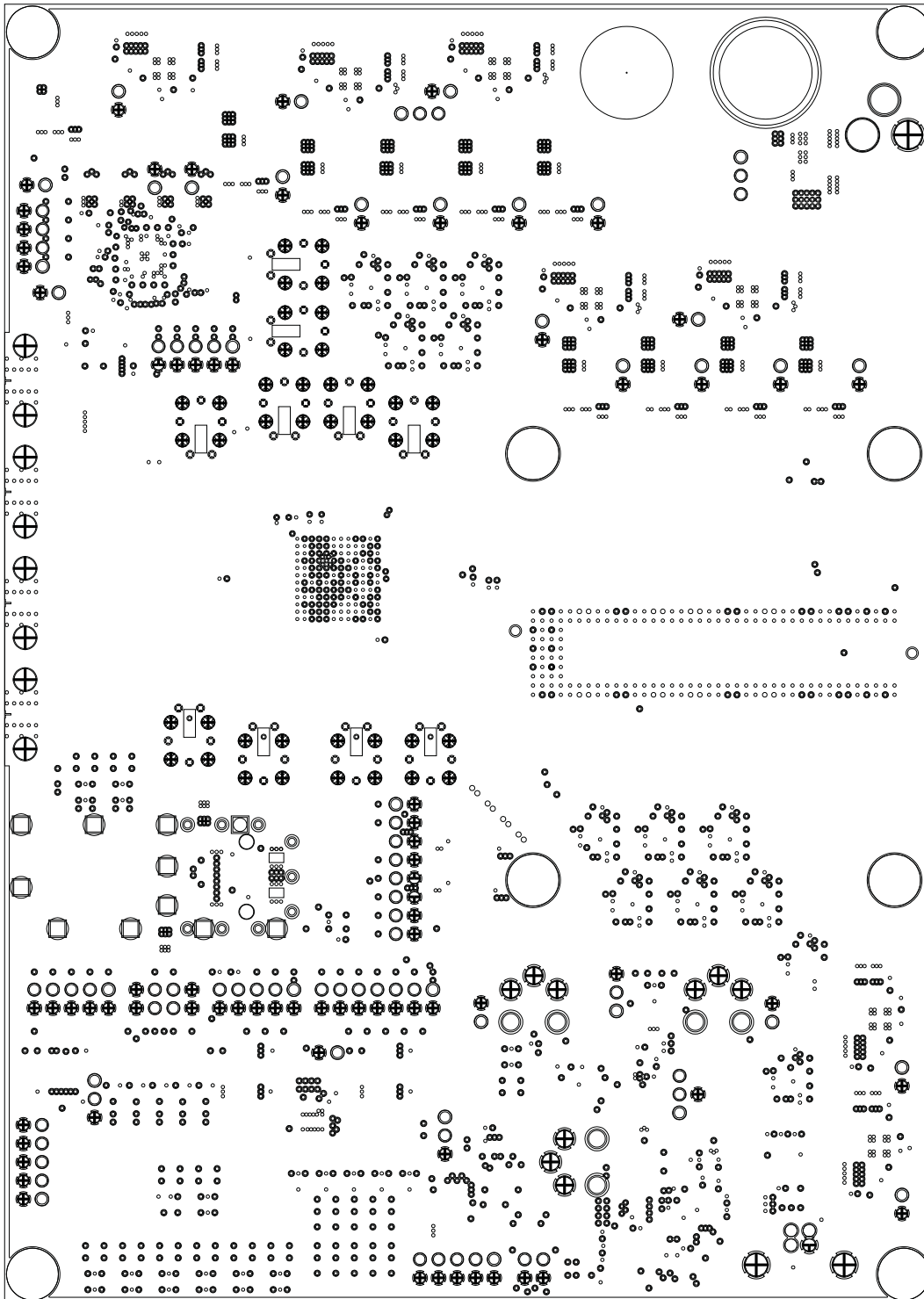

Figure 30. Internal Ground, Layer 2

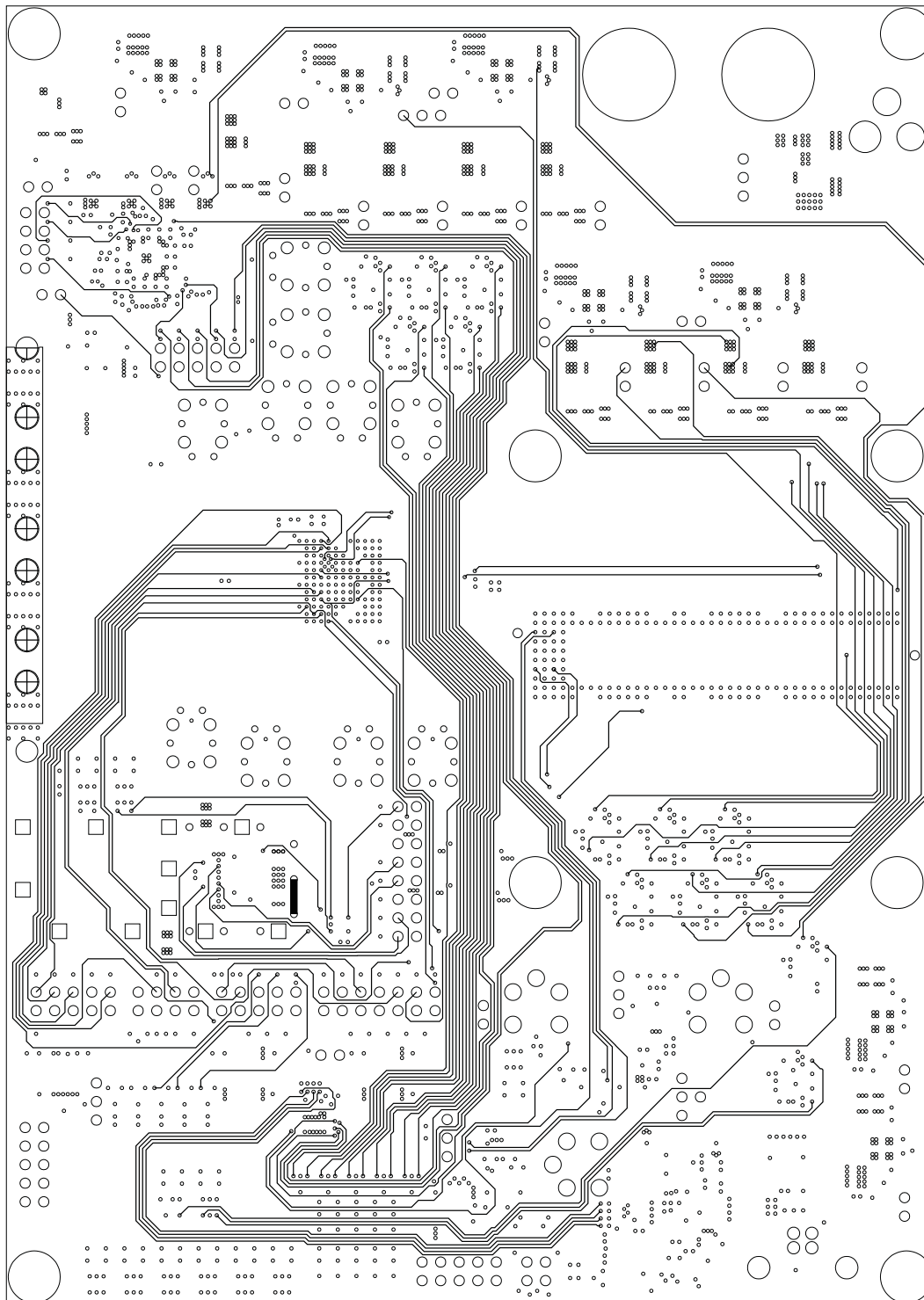

Figure 31. Internal Signal, Layer 3

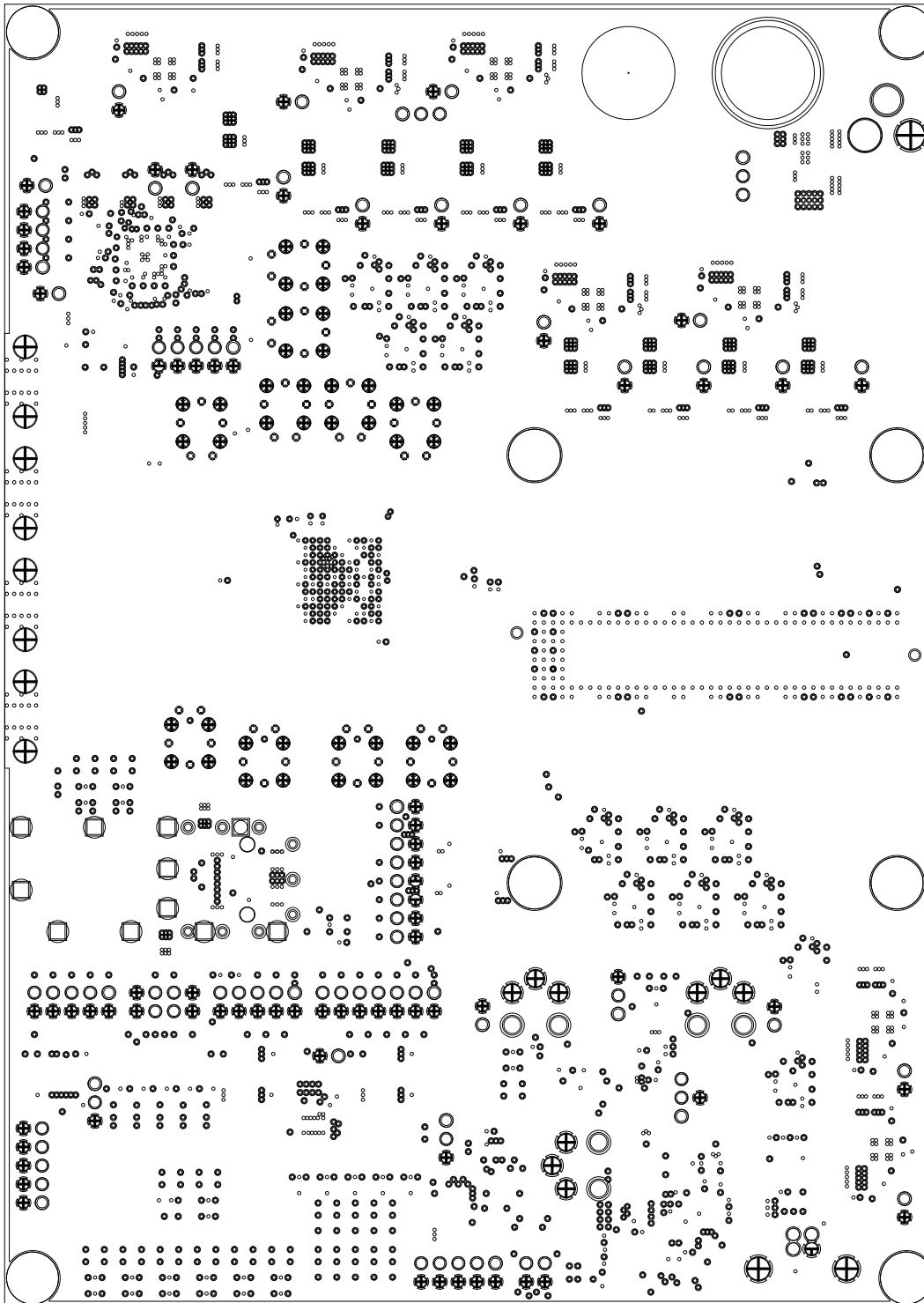

Figure 32. Internal Ground, Layers 4, 6, 7, 9, 11, and 13

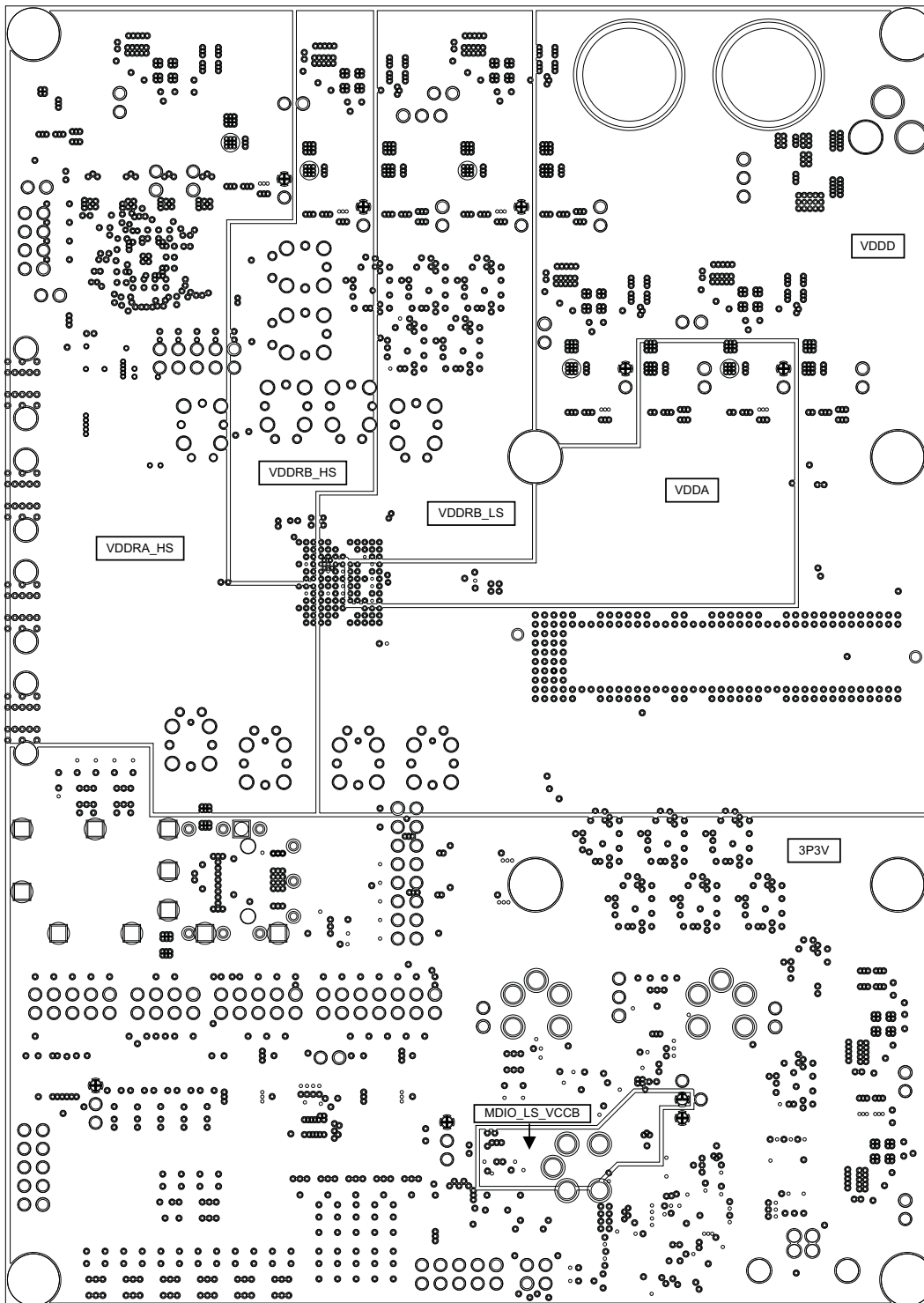

Figure 33. Internal Power, Layer 5

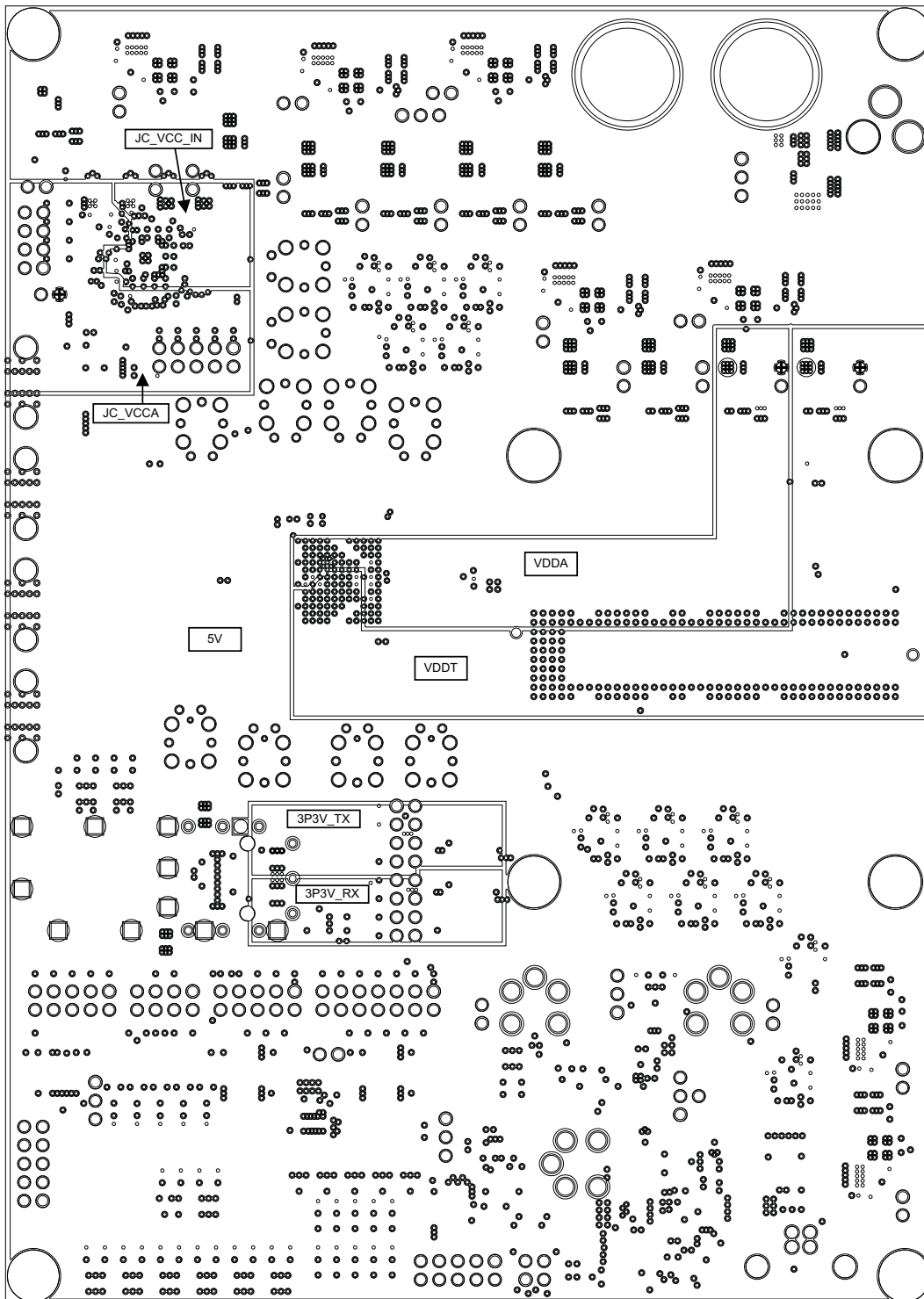

Figure 34. Internal Power, Layer 8

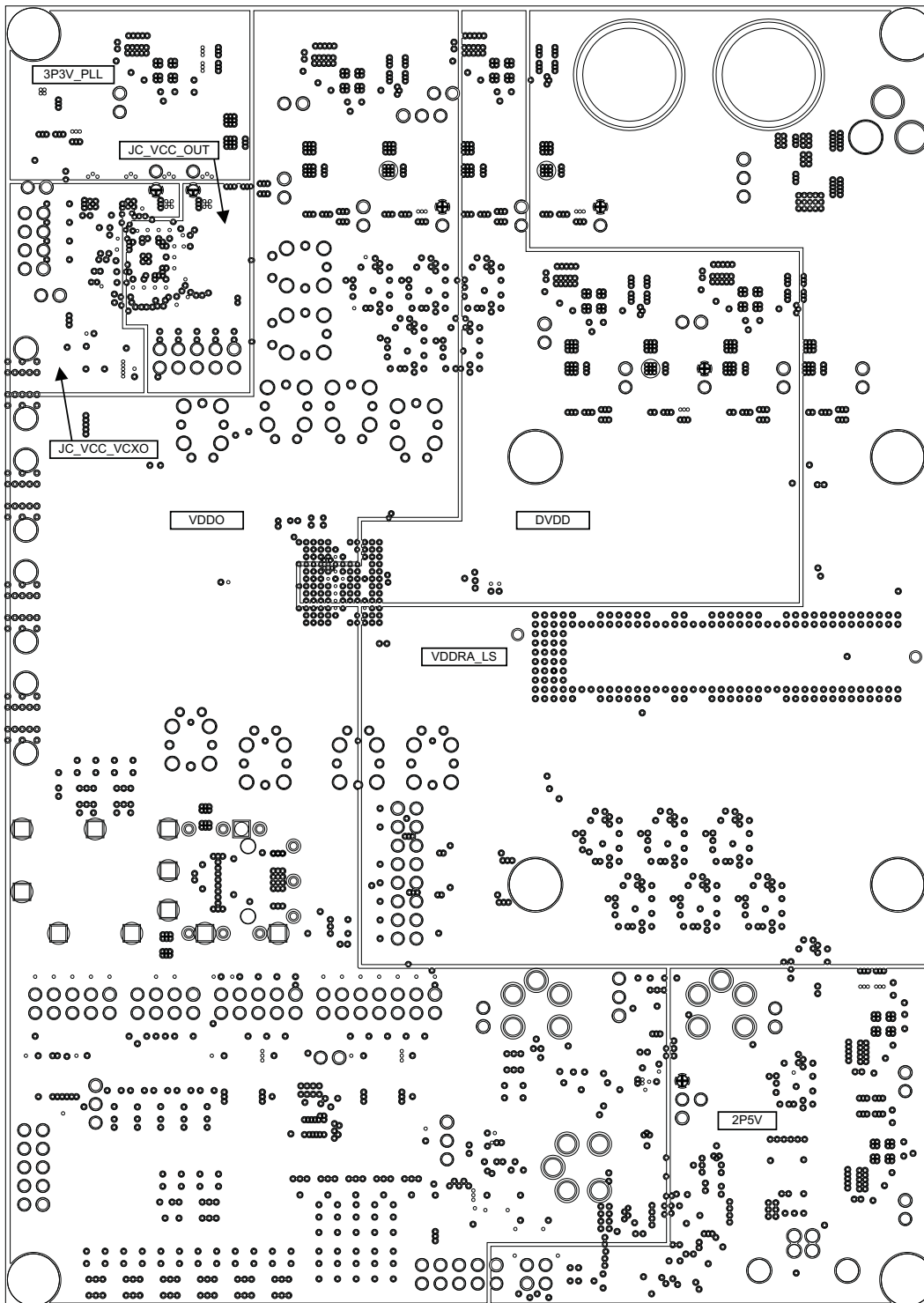

Figure 35. Internal Power, Layer 10

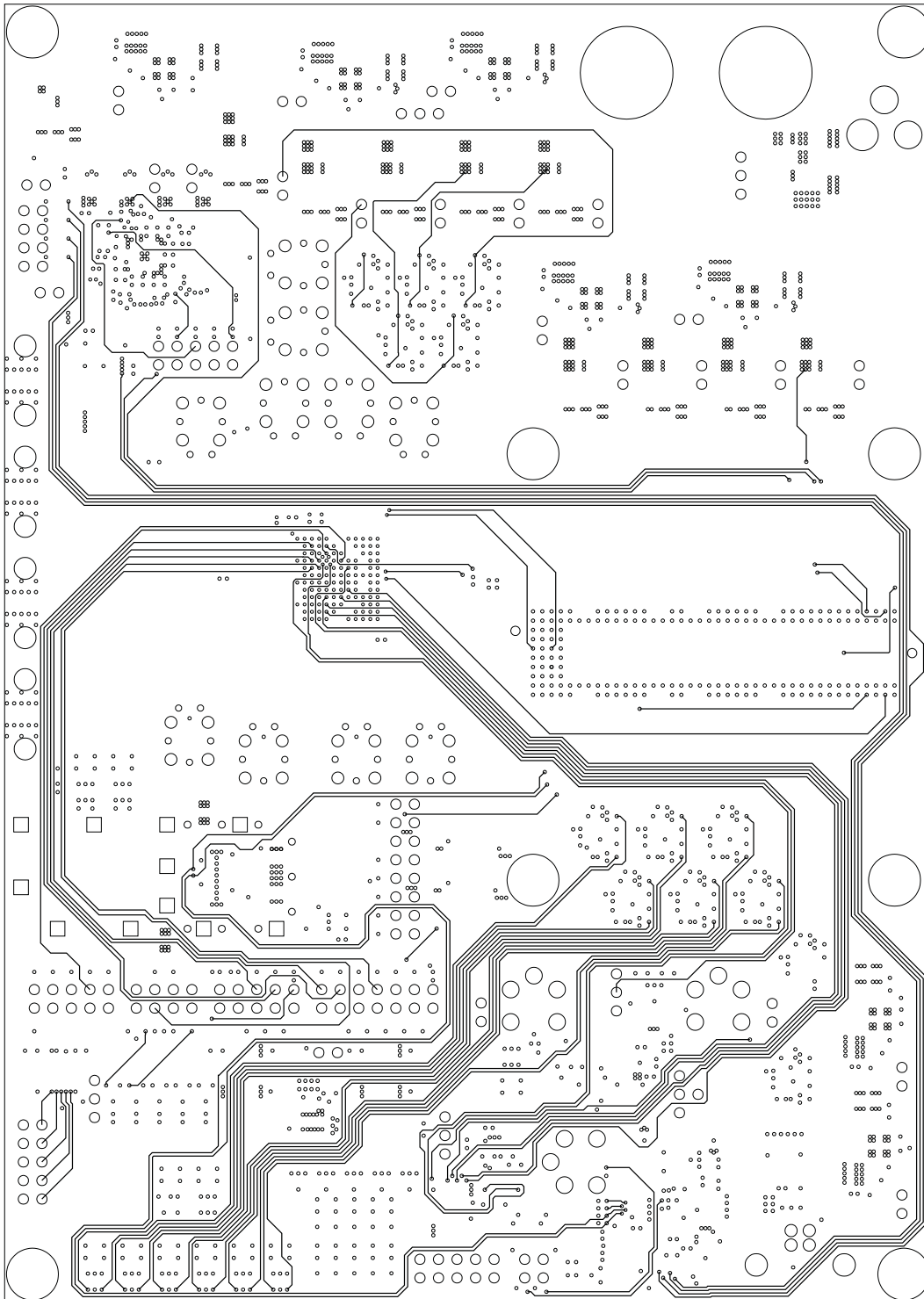

Figure 36. Internal Signal, Layer 12

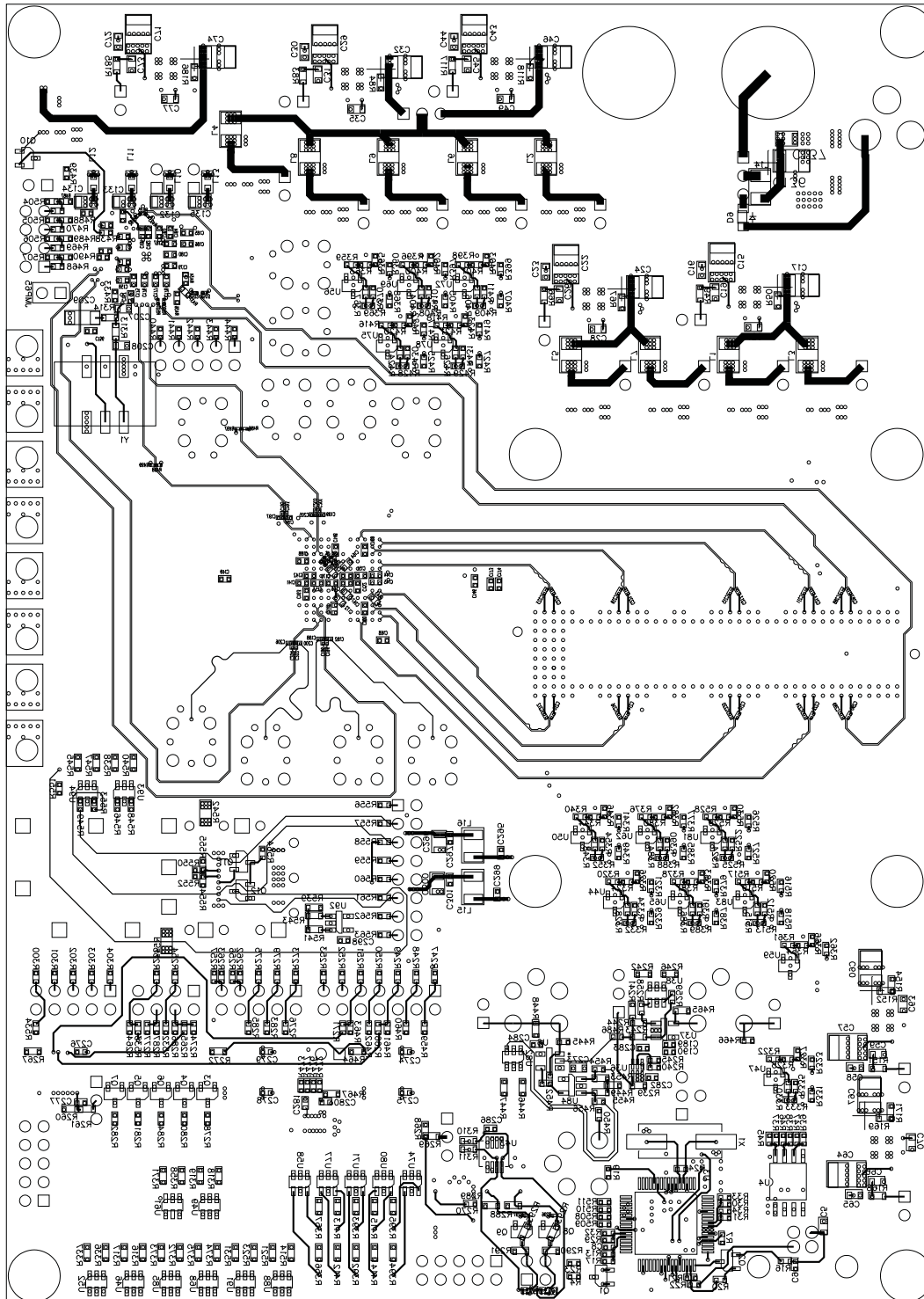

Figure 37. Bottom Signal, Layer 14, Top View

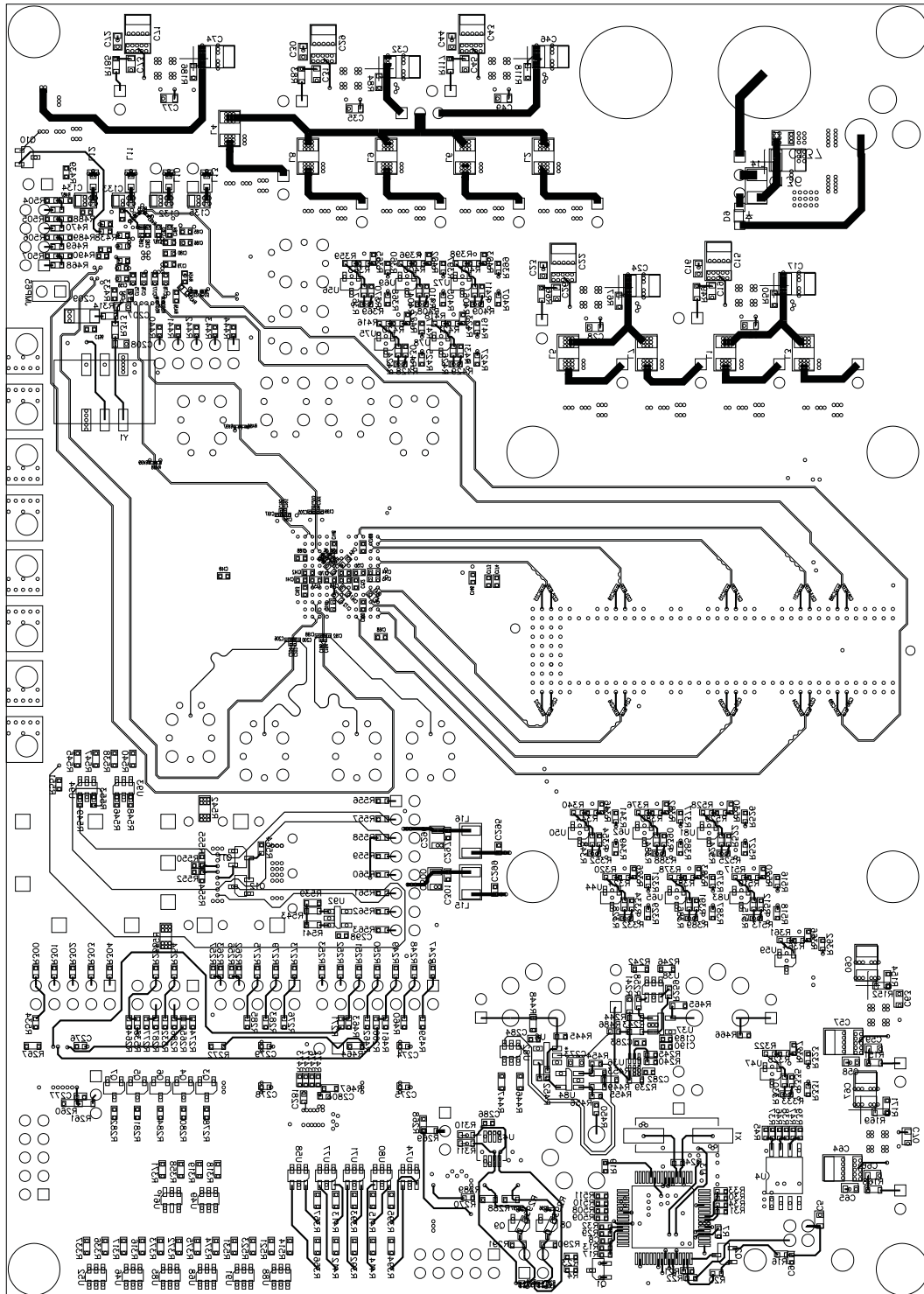

Figure 38. Bottom Signal, Layer 14, Flipped View

Table 2. TLK10002EVM Motherboard Layer Construction

SUBCLASS NAME	TYPE	MATERIAL	THICKNESS (MIL)	DIELECTRIC CONSTANT	LOSS TANGENT	WIDTH (MIL)	COUPLING TYPE/SPACING (MIL)	IMPEDANCE ⁽¹⁾ (Ω)
	SURFACE	AIR		1	0			
TOP	CONDUCTOR	COPPER	1.9	2.8	0	4.50	Edge/3.00	98.821
	DIELECTRIC	Rogers	5	3.6	0.035			
L2_GND	PLANE	COPPER	1.2	1	0			
	DIELECTRIC	FR-4	5	4.1	0.035			
L3_SIG2	CONDUCTOR	COPPER	1.2	1	0	6.00	NONE/NONE	48.85
	DIELECTRIC	FR-4	10	4.1	0.035			
L4_GND	PLANE	COPPER	1.2	1	0			
	DIELECTRIC	FR-4	5	4.1	0.035			
L5_PWR	CONDUCTOR	COPPER	1.2	1	0			
	DIELECTRIC	FR-4	5	4.1	0.035			
L6_GND	PLANE	COPPER	1.2	1	0			
	DIELECTRIC	FR-4	5	4.1	0.035			
L7_GND	PLANE	COPPER	1.2	1	0			
	DIELECTRIC	FR-4	10	4.1	0.035			
L8_PWR	PLANE	COPPER	1.2	1	0			
	DIELECTRIC	FR-4	5	4.1	0.035			
L9_GND	PLANE	COPPER	1.2	1	0			
	DIELECTRIC	FR-4	5	4.1	0.035			
L10_PWR	PLANE	COPPER	1.2	1	0			
	DIELECTRIC	FR-4	5	4.1	0.035			
L11_GND	PLANE	COPPER	1.2	1	0			
	DIELECTRIC	FR-4	10	4.1	0.035			
L12_SIG3	CONDUCTOR	COPPER	1.2	1	0	6.0	NONE/NONE	48.588
	DIELECTRIC	FR-4	5	4.1	0.035			
L13_GND	PLANE	COPPER	1.2	1	0			
	DIELECTRIC	Rogers	5	4.1	0.035			
BOTTOM	CONDUCTOR	COPPER	1.9	1	0	10	NONE/NONE	49.737
	SURFACE	AIR						

⁽¹⁾ The Impedance is set to be slightly less than 50 Ω or 100 Ω on the traces in order to compensate for slight over-etching during the manufacturing process. The end impedance after etching should result in a 50 or 100- Ω Impedance. Always consult with your board manufacturer for their process/design requirements to ensure the desired impedance is achieved.

13 TLK10002EVM FPGA Daughterboard Schematics

<p>NOTES:</p> <ol style="list-style-type: none"> 1. PLACE NET NAMES ON ALL JUMPERS AND HEADERS. 2. PLACE ALL PARTS OTHER THAN SMA CONNECTORS ON A 0 OR 90 DEGREE ORIENTATION. 3. SERIAL DATA SHOULD BE ROUTED AS 100 OHM DIFFERENTIALLY COUPLED OR SINGLE-ENDED 50 OHM TRANSMISSION LINES ON OUTSIDE LAYERS. ROUTING DISTANCE SHOULD BE 5 INCHES OR LESS. ALL OTHER DATA LINES SHOULD BE 50 OHM IMPEDANCE ON INTERNAL OR EXTERNAL LAYERS. ROUTED POWER SHOULD BE A MINIMUM OF 40 MILS WIDE. 4. USE ROGERS MATERIAL FOR OUTSIDE LAYERS AND FR4-370 MATERIAL FOR INSIDE LAYERS. 5. SERIAL AND REFCLK NETS MUST MATCH WITHIN +/- 0.5 MILS 6. MATCH DIFFERENTIAL TRACE WIDTHS OF SERIAL AND REFCLK LINES WITH SMP/SMA PADS. 7. PLACE TI LOGO, BOARD NAME, JN COMBO LOGO, AND THE BOARD NUMBER IN TOP SIDE METAL. 	<table border="1" style="width: 100%; border-collapse: collapse;"> <thead> <tr> <th colspan="3">REVISIONS</th> </tr> <tr> <th>ECR</th> <th>ECR NUMBER</th> <th>DATE</th> </tr> </thead> <tbody> <tr> <td> </td> <td>-----</td> <td>xx/xx/xx</td> </tr> </tbody> </table>	REVISIONS			ECR	ECR NUMBER	DATE		-----	xx/xx/xx																							
REVISIONS																																	
ECR	ECR NUMBER	DATE																															
	-----	xx/xx/xx																															
<div style="border: 1px solid black; padding: 10px; width: fit-content; margin: 0 auto;"> <p>SCHEMATIC SHEET INDEX:</p> <hr style="width: 50%; margin: 5px auto;"/> <p>SHEET 01: SPARTAN-6 BOARD COVER SHEET AND NOTES SHEET 02: USB INTERFACE SHEET 03: REGULATORS SHEET 04: FPGA POWER AND GROUND SHEET 05: FPGA CONFIGURATION SHEET 06: FPGA MULTI-GIGABIT TRANSCEIVERS SHEET 07: TI PROGRAMMED RESOURCES 1 SHEET 08: TI PROGRAMMED RESOURCES 2 SHEET 09: FPGA USER PROGRAMMABLE RESOURCES 1 SHEET 10: FPGA USER PROGRAMMABLE RESOURCES 2 SHEET 11: FPGA NO CONNECTS SHEET 12: BOARD TO BOARD CONNECTOR SHEET 13: 1P2V SUPPLY LEDS SHEET 14: 1P8V AND 2P5V SUPPLY LEDS SHEET 15: 3P3V AND 5V SUPPLY LEDS</p> </div>																																	
<p>TLK10002 DATA SHEET REVISION: 0.7 DATA SHEET LAST UPDATED ON: 09/27/10</p>	<div style="text-align: right;">  <table border="1" style="margin-left: 10px; border-collapse: collapse;"> <tr> <th colspan="2">TEXAS INSTRUMENTS</th> </tr> <tr> <td colspan="2" style="font-size: small;">SCHEMATIC TITLE</td> </tr> <tr> <td colspan="2">TLK10002 EVM</td> </tr> <tr> <td colspan="2">SPARTAN-6 FPGA DAUGHTER BOARD</td> </tr> <tr> <td colspan="2" style="font-size: small;">PAGE TITLE</td> </tr> <tr> <td colspan="2">COVER SHEET AND NOTES</td> </tr> <tr> <td style="font-size: x-small;">ENGINEER</td> <td style="font-size: x-small;">DATE</td> </tr> <tr> <td>J. NERGER</td> <td>11/15/10</td> </tr> <tr> <td style="font-size: x-small;">LAYOUT</td> <td style="font-size: x-small;">DATE</td> </tr> <tr> <td>J. NERGER</td> <td>11/15/10</td> </tr> <tr> <td style="font-size: x-small;">RELEASED</td> <td style="font-size: x-small;">DATE</td> </tr> <tr> <td>J. NERGER</td> <td>11/15/10</td> </tr> <tr> <td style="font-size: x-small;">SIZE</td> <td style="font-size: x-small;">DOCUMENT NUMBER</td> </tr> <tr> <td>B</td> <td>6522851</td> </tr> <tr> <td style="font-size: x-small;">REV</td> <td style="font-size: x-small;">SHEET</td> </tr> <tr> <td>NA</td> <td>1 of 15</td> </tr> </table> </div>	TEXAS INSTRUMENTS		SCHEMATIC TITLE		TLK10002 EVM		SPARTAN-6 FPGA DAUGHTER BOARD		PAGE TITLE		COVER SHEET AND NOTES		ENGINEER	DATE	J. NERGER	11/15/10	LAYOUT	DATE	J. NERGER	11/15/10	RELEASED	DATE	J. NERGER	11/15/10	SIZE	DOCUMENT NUMBER	B	6522851	REV	SHEET	NA	1 of 15
TEXAS INSTRUMENTS																																	
SCHEMATIC TITLE																																	
TLK10002 EVM																																	
SPARTAN-6 FPGA DAUGHTER BOARD																																	
PAGE TITLE																																	
COVER SHEET AND NOTES																																	
ENGINEER	DATE																																
J. NERGER	11/15/10																																
LAYOUT	DATE																																
J. NERGER	11/15/10																																
RELEASED	DATE																																
J. NERGER	11/15/10																																
SIZE	DOCUMENT NUMBER																																
B	6522851																																
REV	SHEET																																
NA	1 of 15																																

Figure 39. Cover Page and Index, Sheet 1 of 15

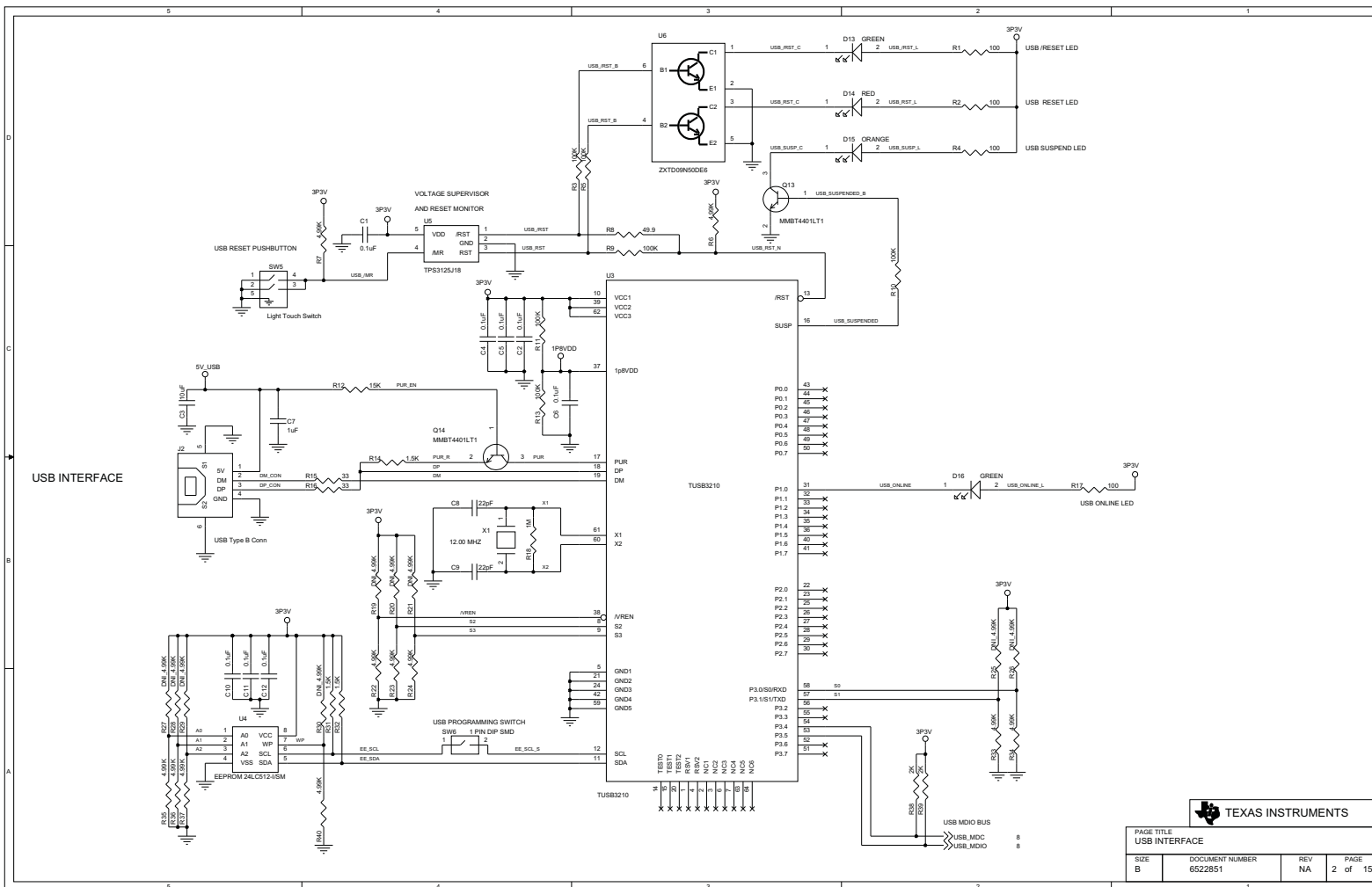

Figure 40. USB Interface, Sheet 2 of 15

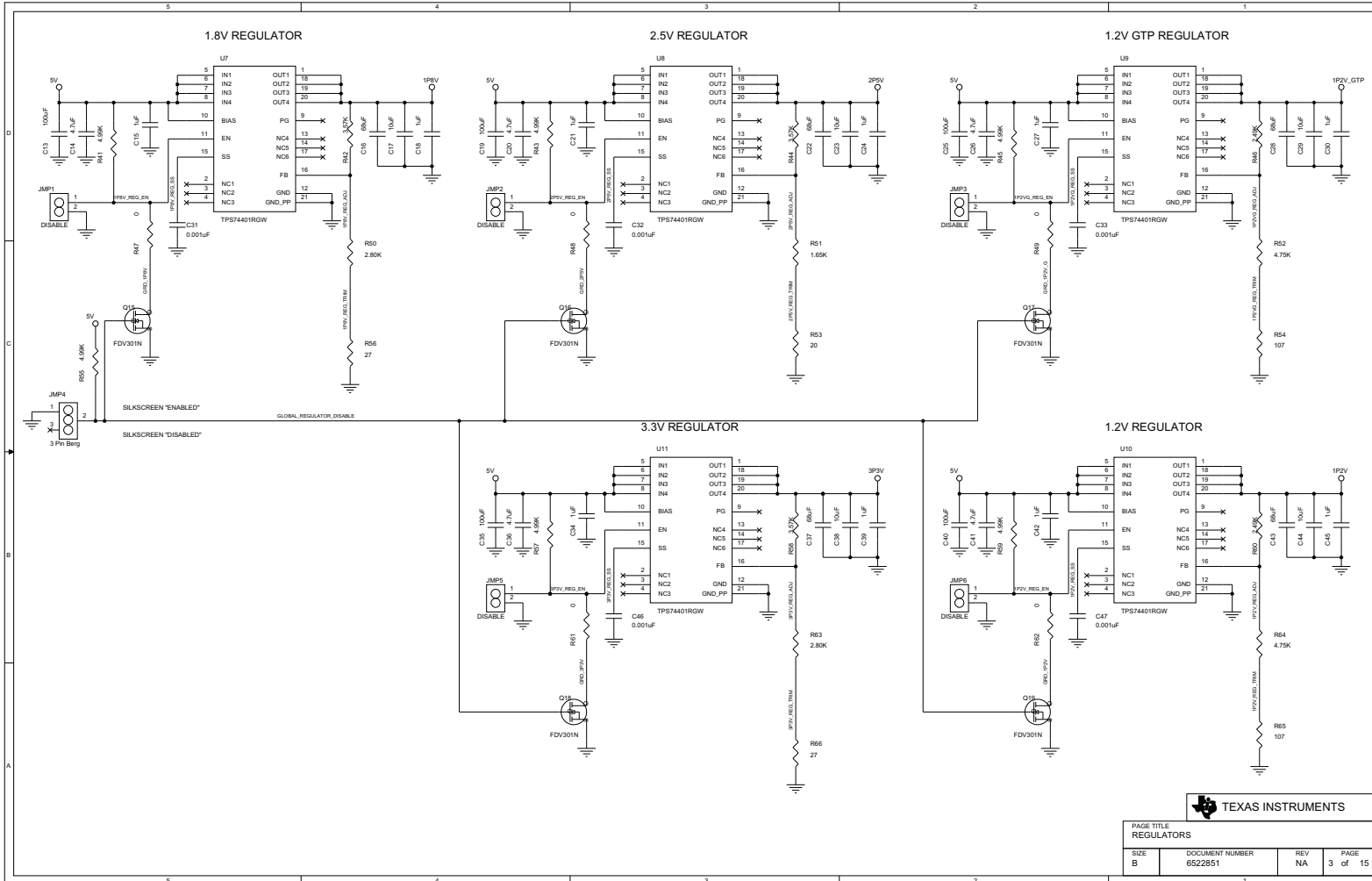

Figure 41. Regulators, Sheet 3 of 15

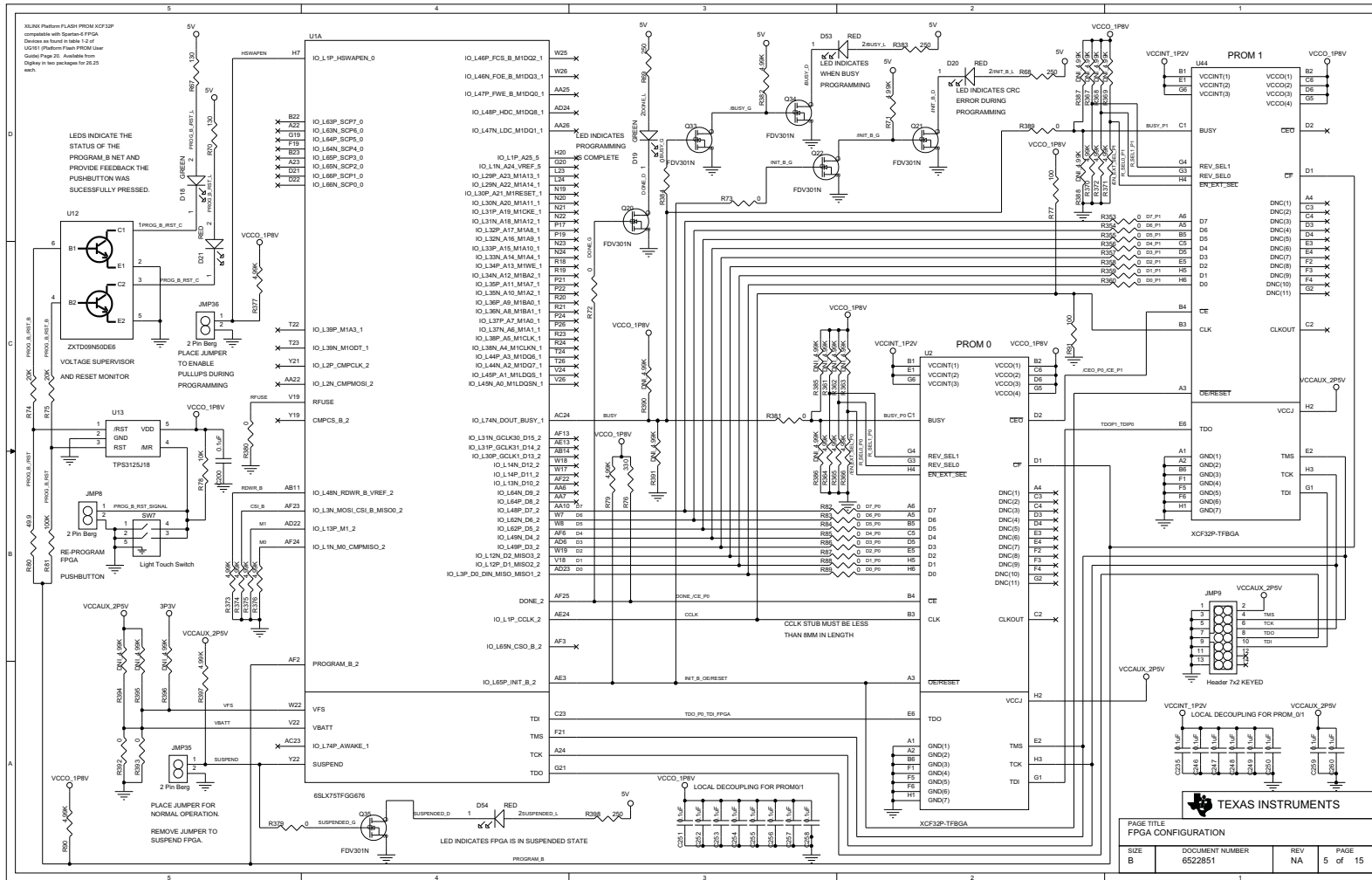

Figure 43. FPGA Configuration, Sheet 5 of 15

TLK10002EVM FPGA Daughterboard Schematics

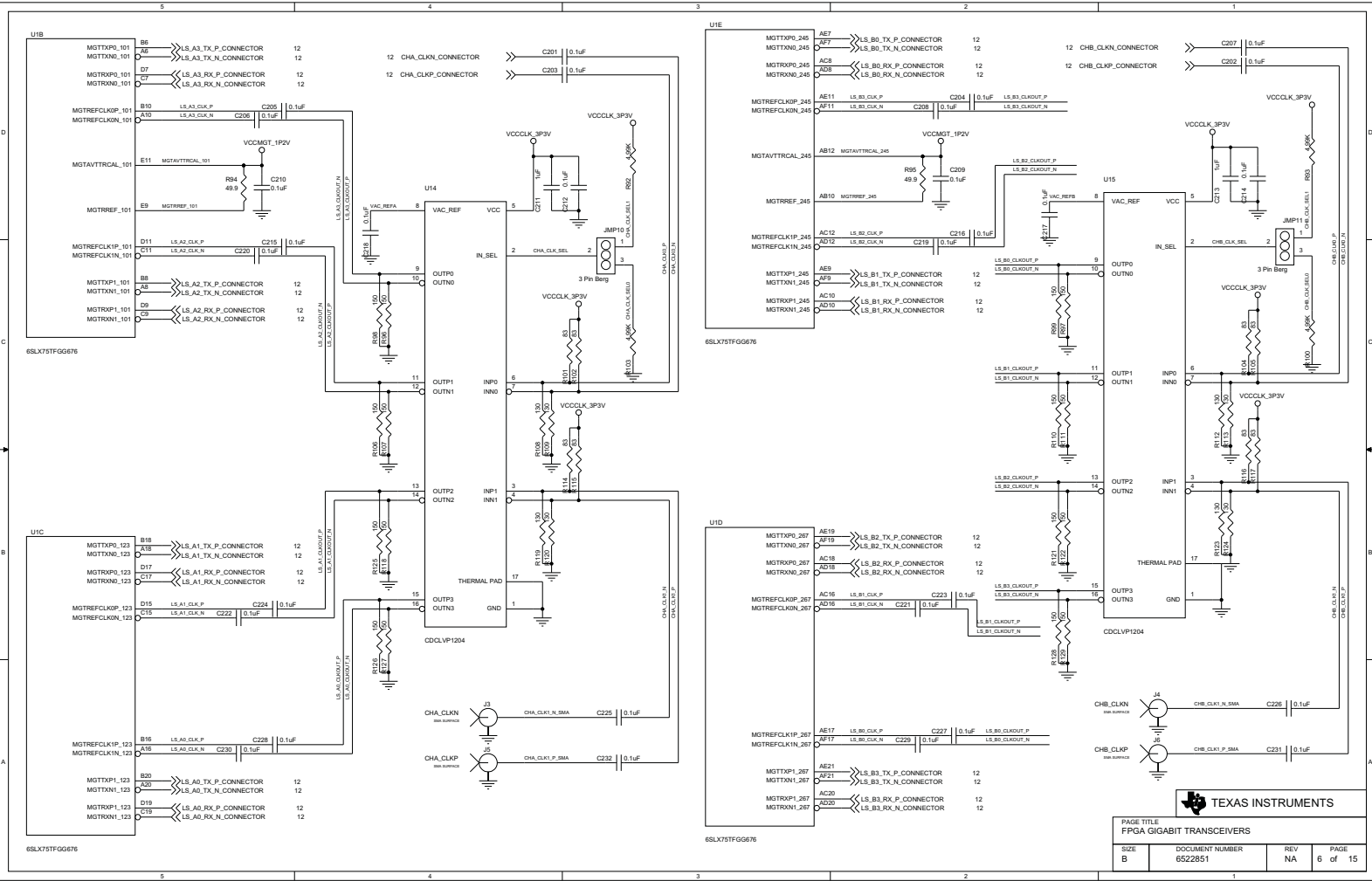

Figure 44. FPGA Gigabit Transceivers, Sheet 6 of 15

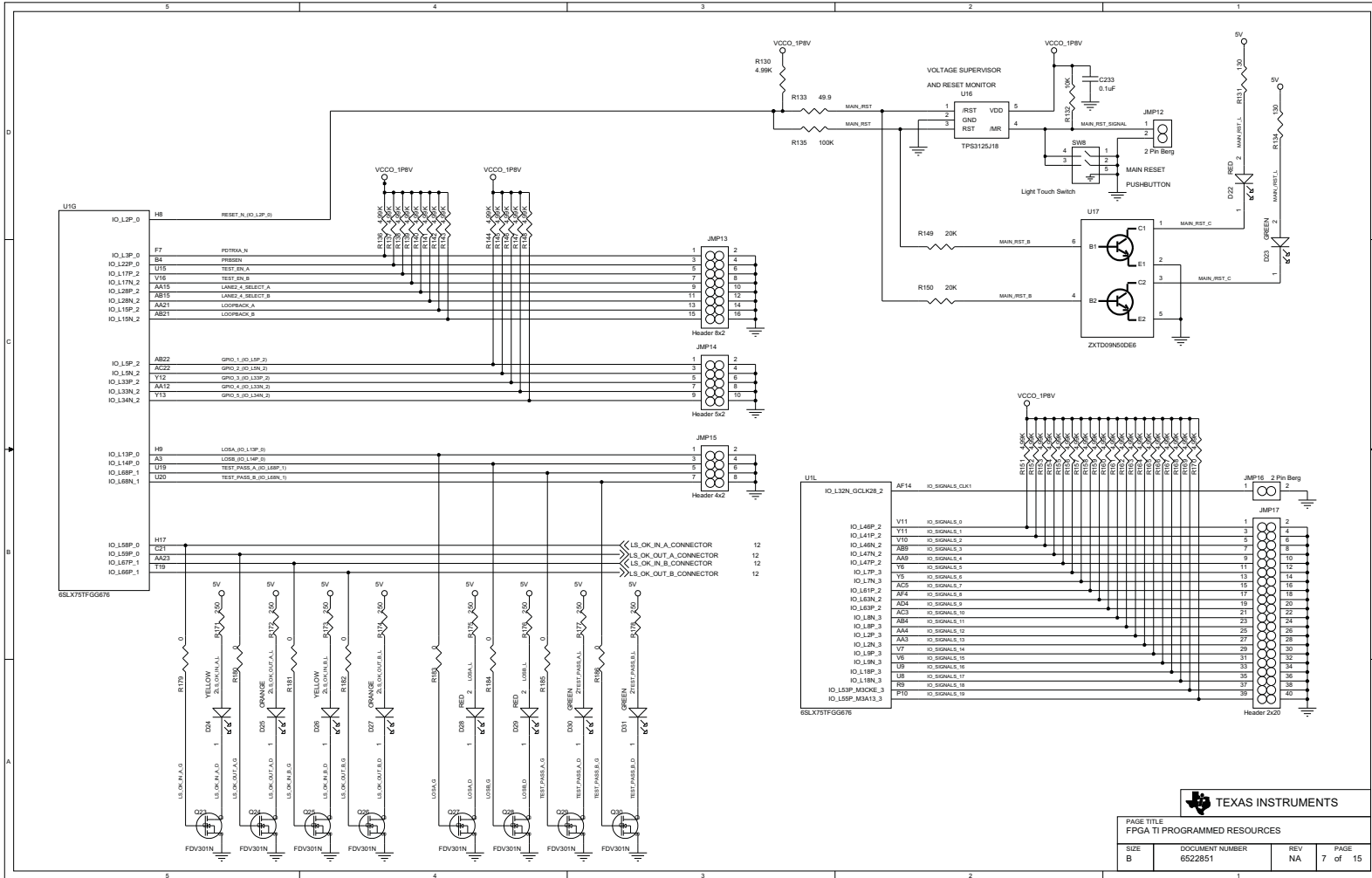

Figure 45. TI-Programmed Resources 1, Sheet 7 of 15

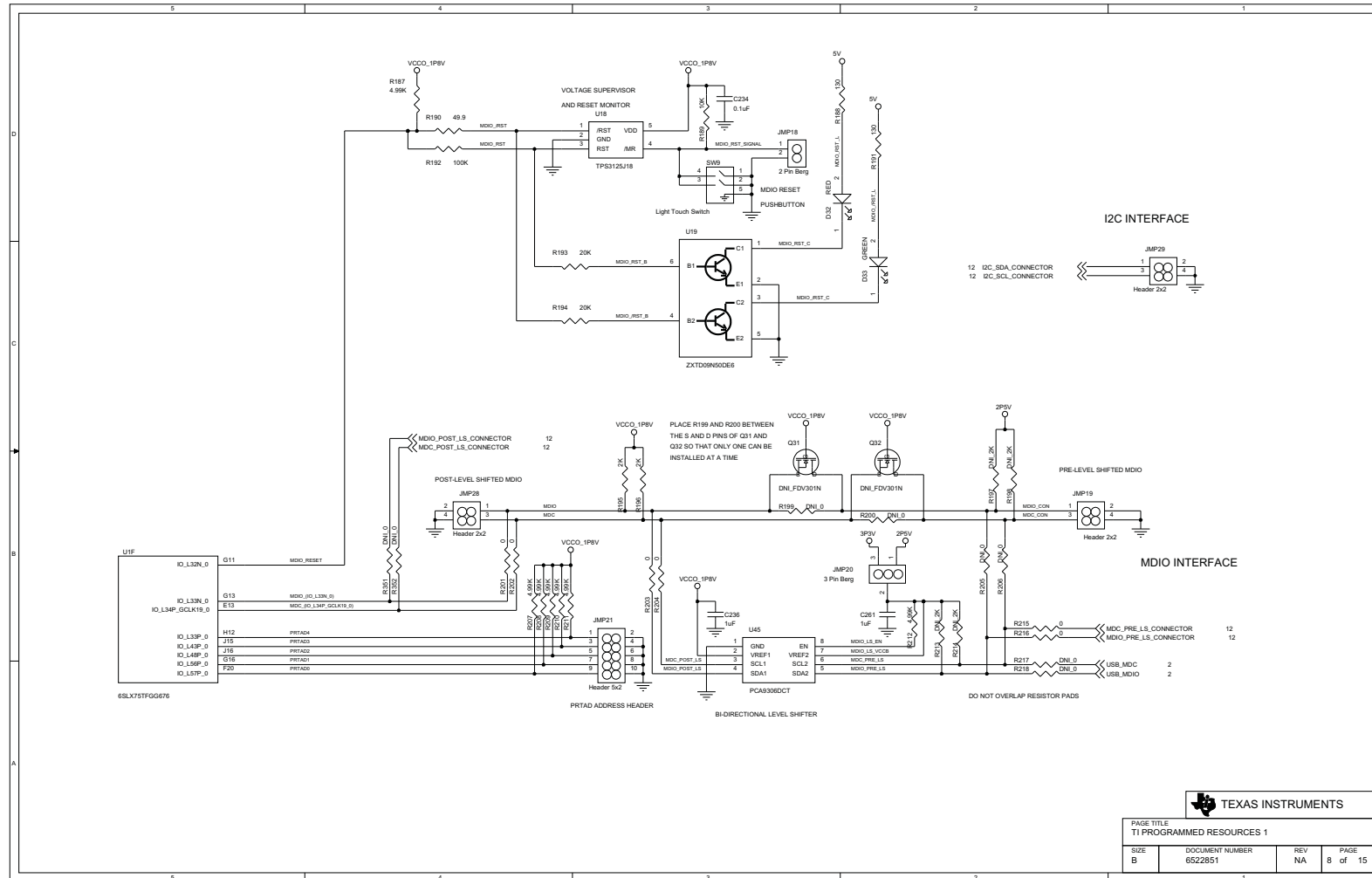

Figure 46. TI-Programmed Resources 2, Sheet 8 of 15

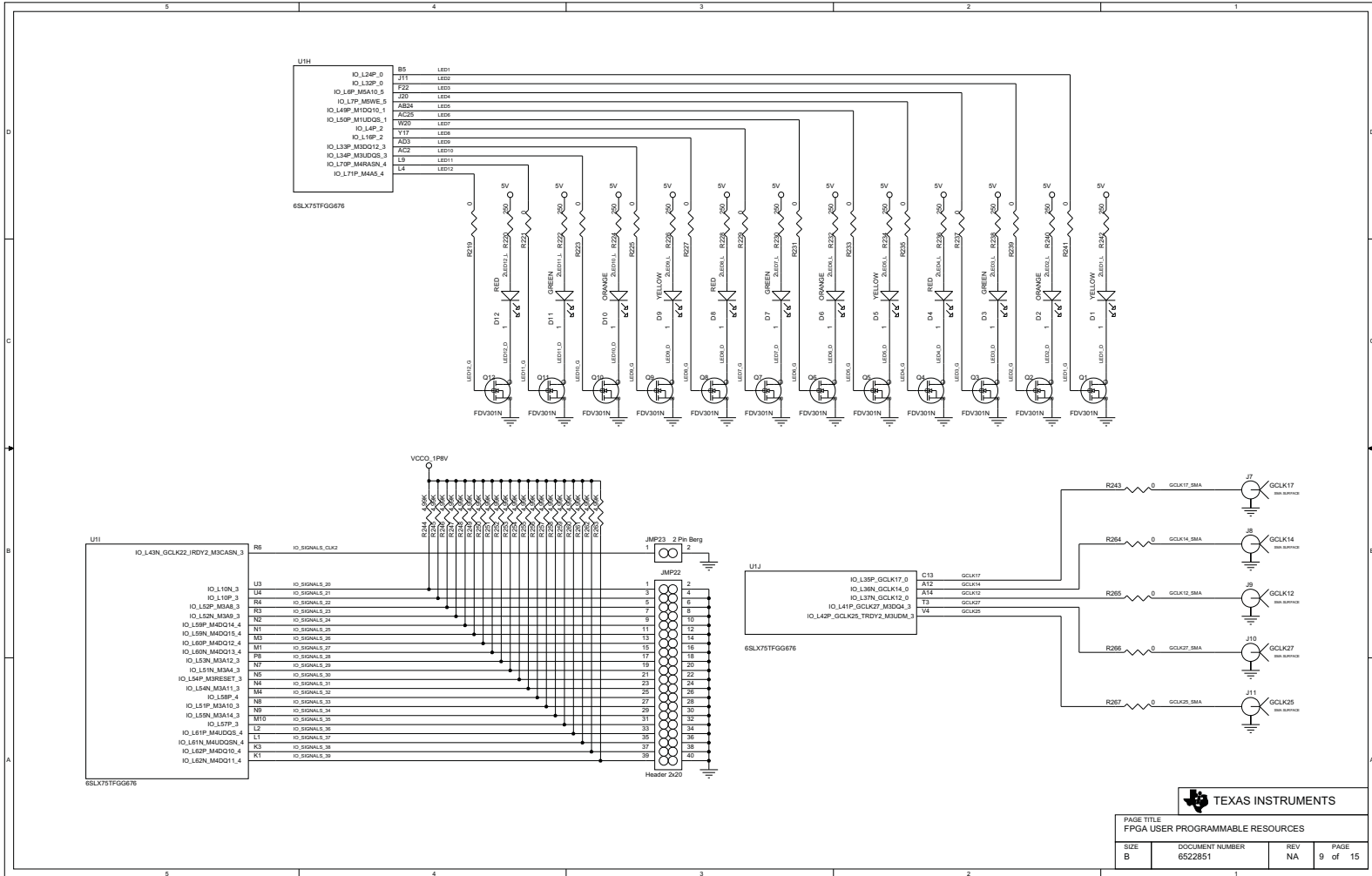

Figure 47. User Programmable Resources 1, Sheet 9 of 15

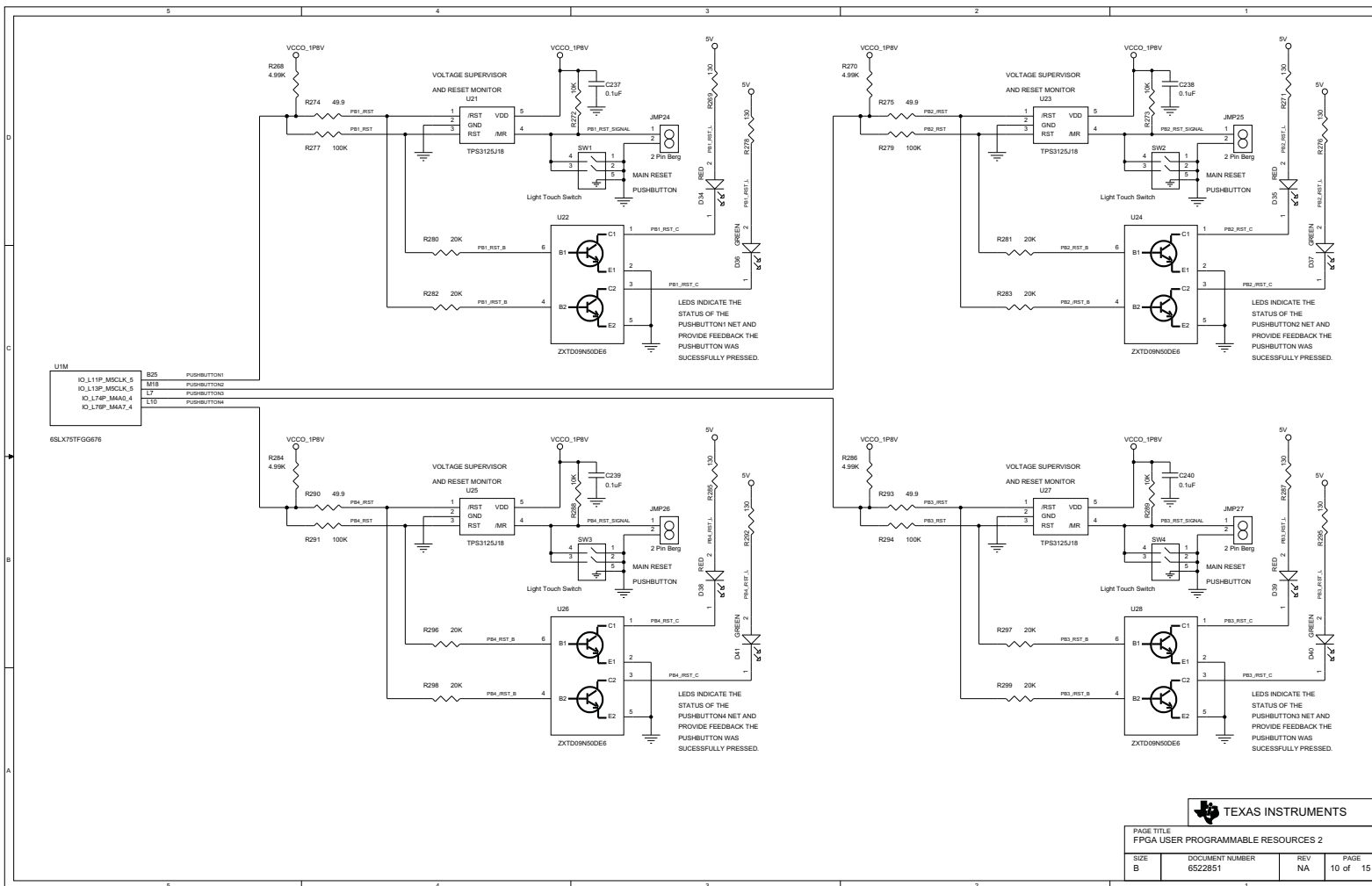

Figure 48. User-Programmable Resources 2, Sheet 10 of 15

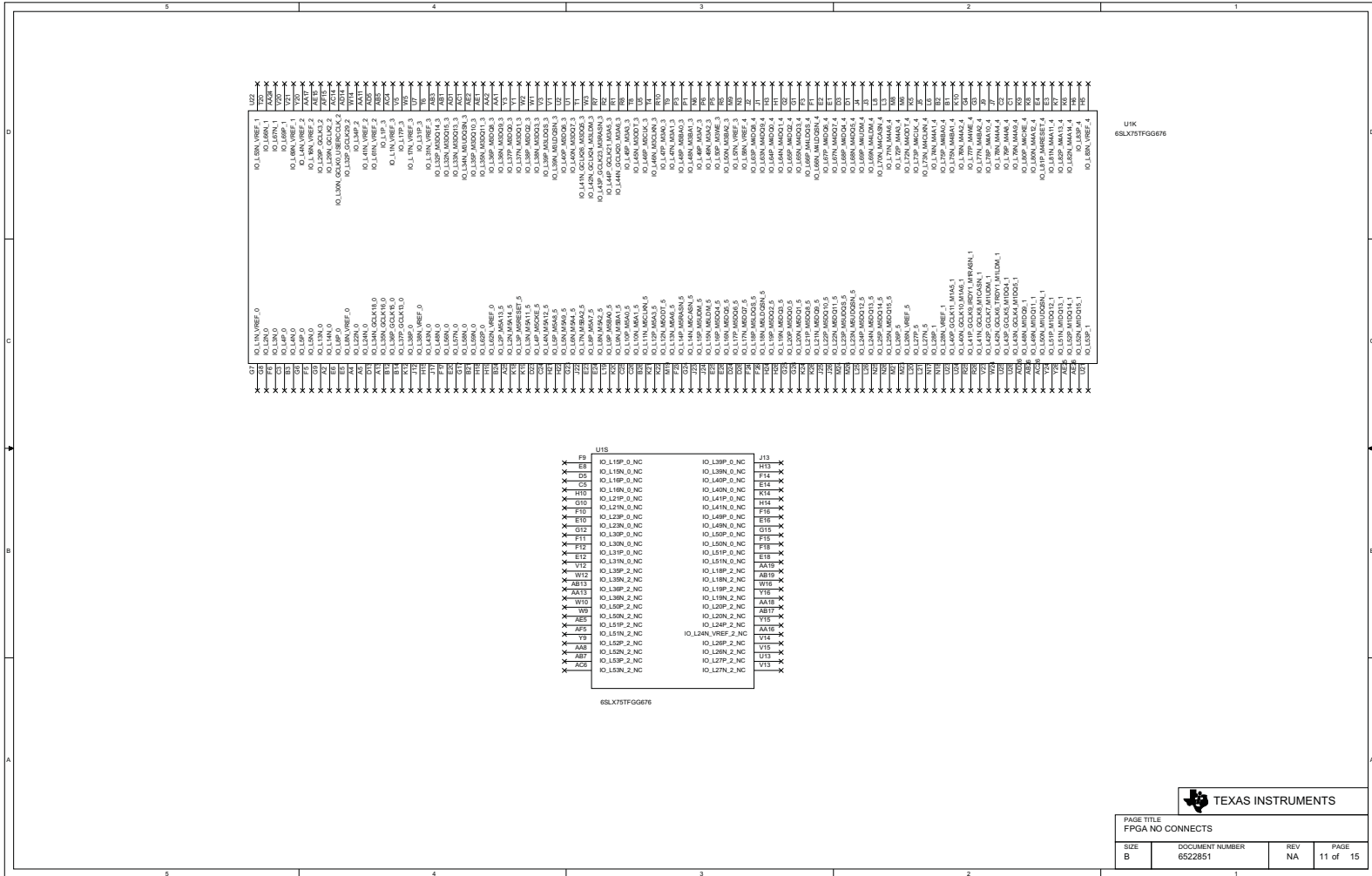

Figure 49. FPGA No Connects, Sheet 11 of 15

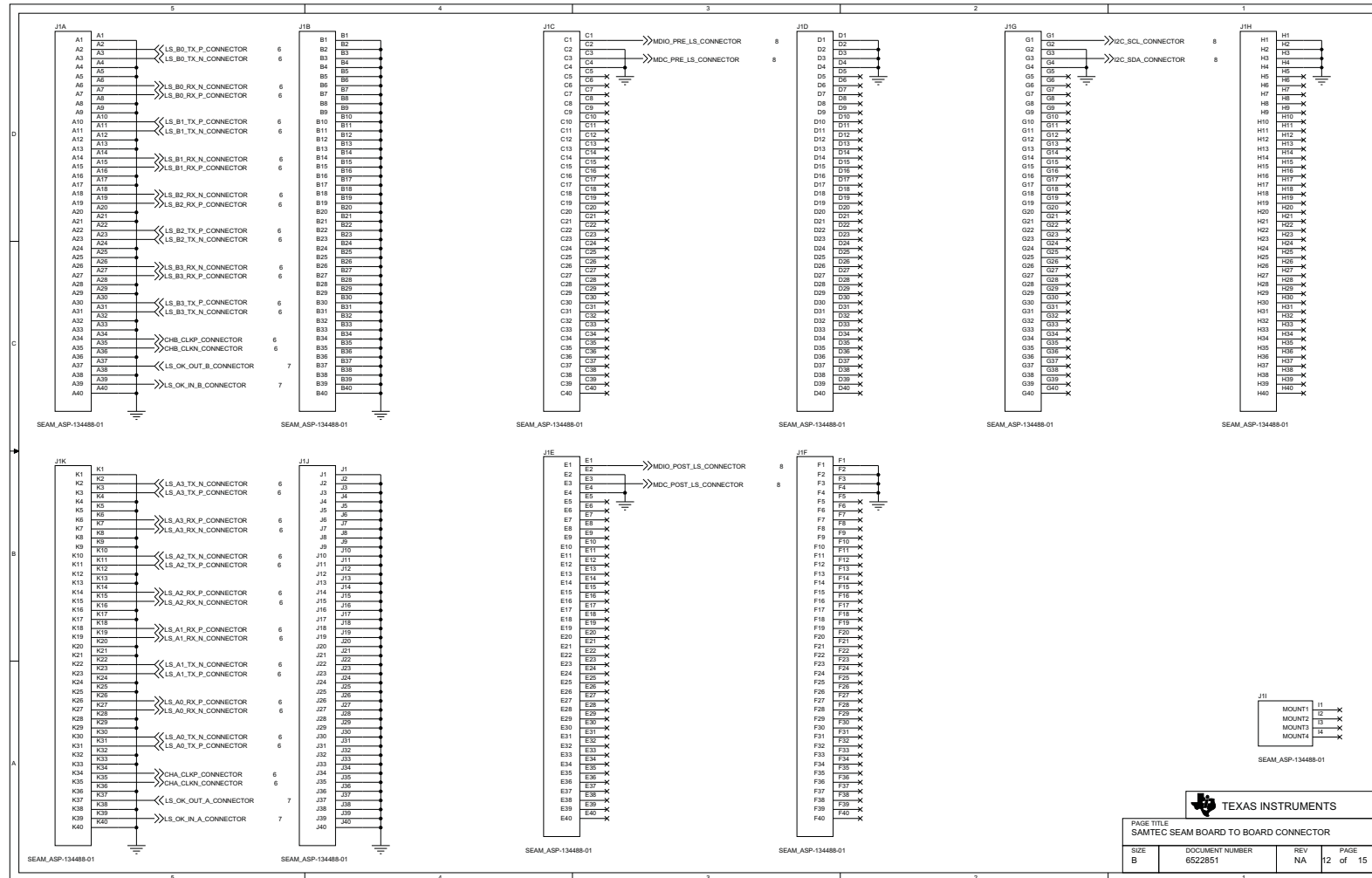

Figure 50. Board-to-Board Connector, Sheet 12 of 15

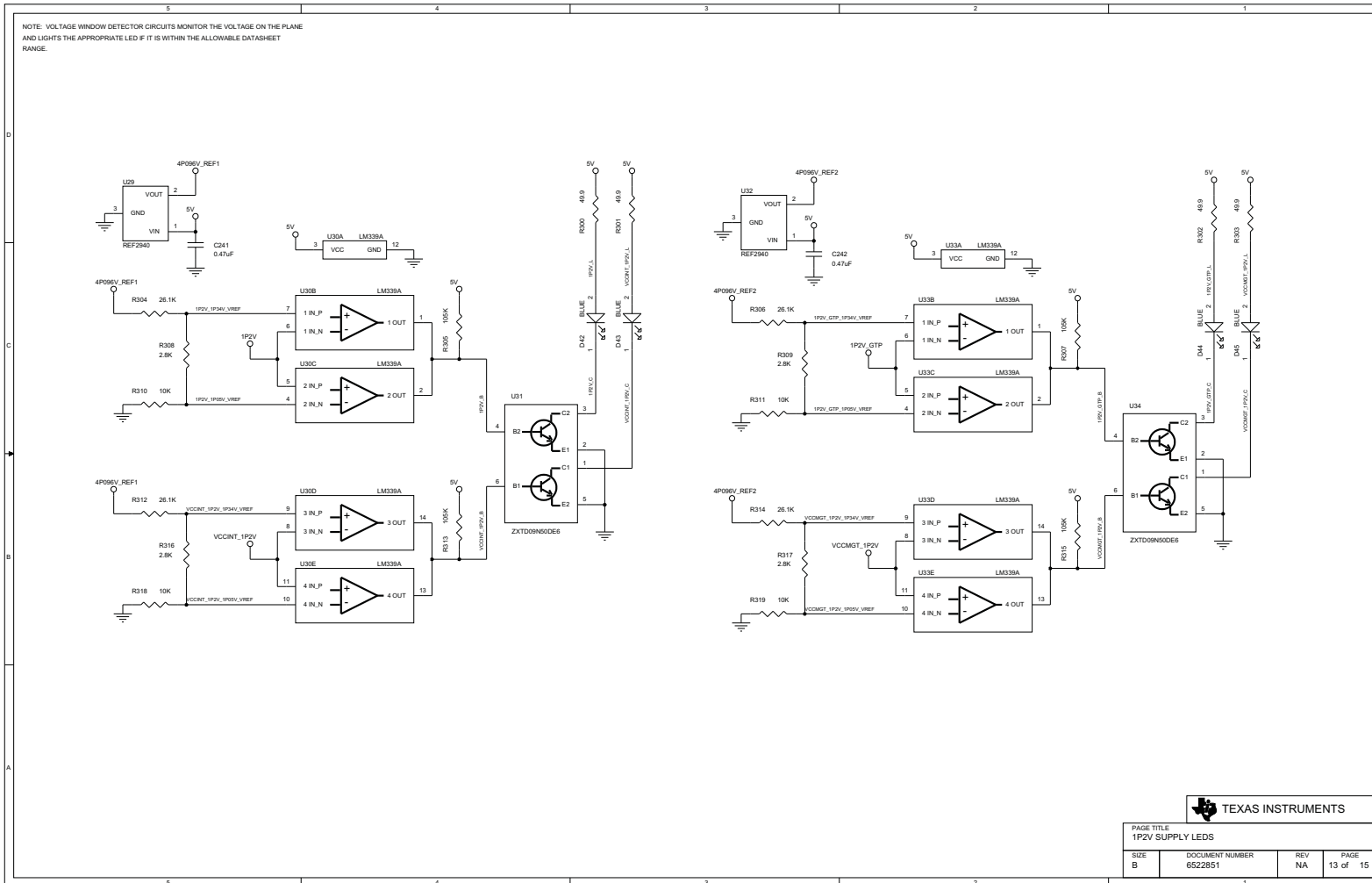

Figure 51. 1P2V LEDs, Sheet 13 of 15

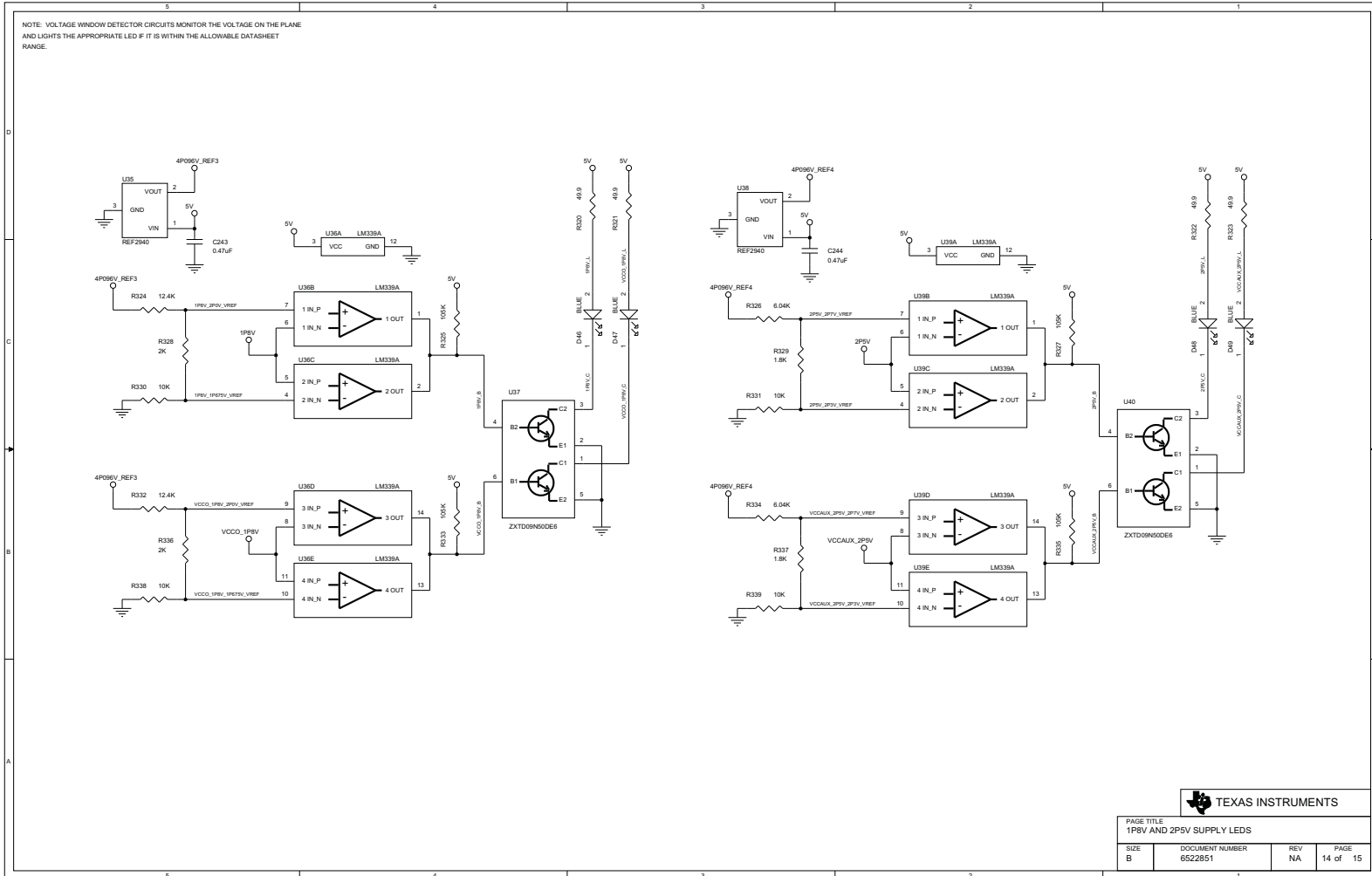

Figure 52. 1P8V and 2P5V LEDs, Sheet 14 of 15

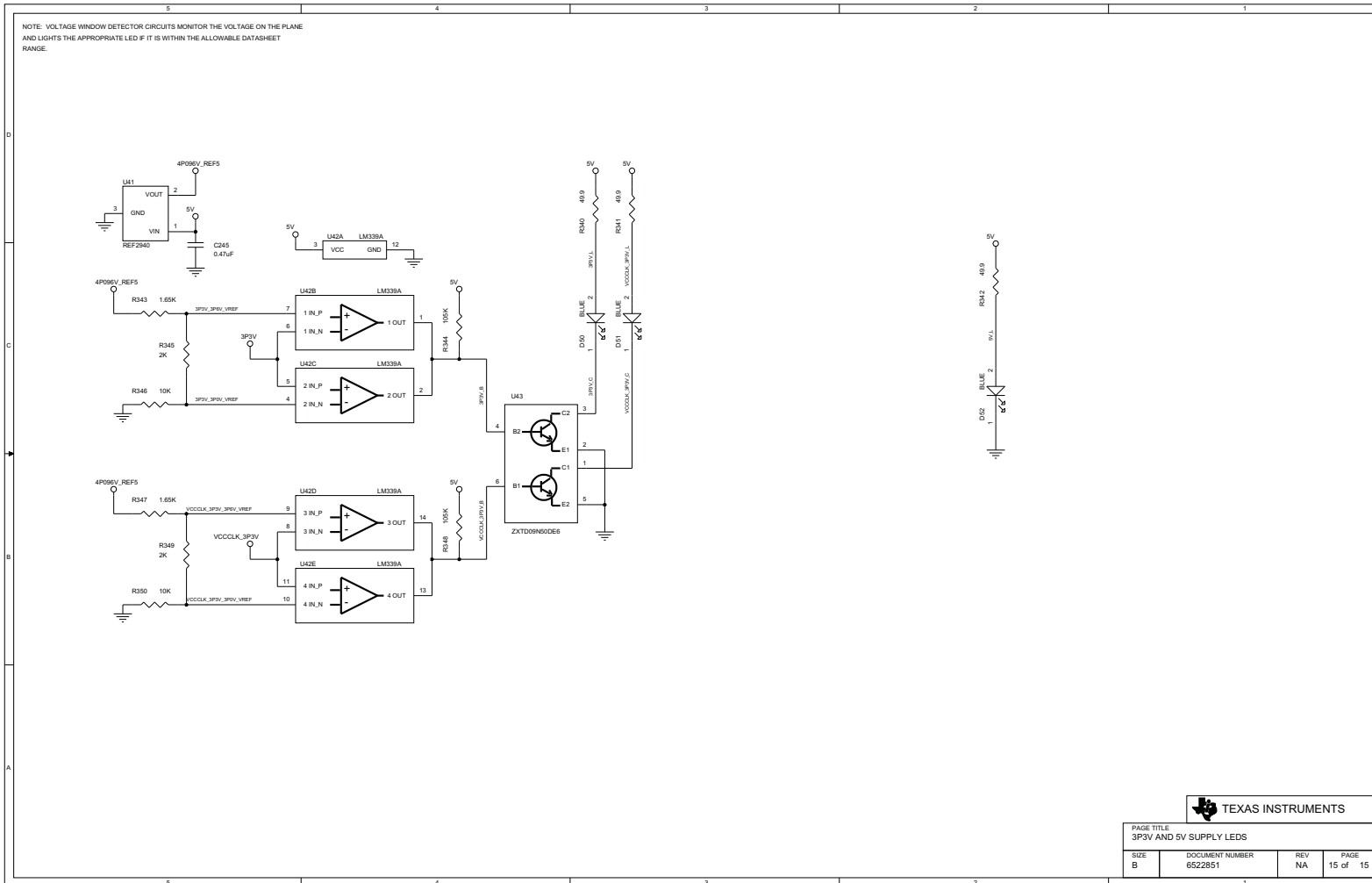

Figure 53. 3P3V and 5-V LEDs, Sheet 15 of 15

14 TLK10002EVM FPGA Daughterboard Bill of Materials
Table 3. TLK10002EVM FPGA Daughterboard Bill of Materials

Item	Qty	Reference	Value	Part	Part Number	Manufacturer
1	24	C201, C202, C203, C204, C205, C206, C207, C208, C215, C216, C219, C220, C221, C222, C223, C224, C225, C226, C227, C228, C229, C230, C231, C232	0.1 μ F	0201 CAP	C0201X5R6R3-104KNE	Venkel
2	164	C1, C2, C4, C5, C6, C10, C11, C12, C73, C74, C75, C76, C77, C78, C79, C80, C81, C82, C83, C84, C85, C86, C87, C88, C89, C90, C91, C92, C93, C94, C95, C96, C97, C98, C99, C100, C101, C102, C103, C104, C105, C106, C107, C108, C109, C110, C111, C112, C113, C114, C115, C116, C117, C118, C119, C120, C121, C122, C123, C124, C125, C126, C127, C128, C129, C130, C131, C132, C133, C134, C135, C136, C137, C138, C139, C140, C141, C142, C143, C144, C145, C146, C147, C148, C149, C150, C151, C152, C153, C154, C155, C156, C157, C158, C159, C160, C161, C162, C163, C164, C165, C166, C167, C168, C169, C170, C171, C172, C173, C174, C175, C176, C177, C178, C179, C180, C181, C182, C183, C184, C185, C186, C187, C188, C189, C190, C191, C192, C193, C194, C195, C196, C197, C198, C199, C200, C209, C210, C212, C214, C217, C218, C233, C234, C235, C237, C238, C239, C240, C246, C247, C248, C249, C250, C251, C252, C253, C254, C255, C256, C257, C258, C259, C260	0.1 μ F	0402 CAP	C0402X7R160-104KNE	Venkel
3	5	C241, C242, C243, C244, C245	0.47 μ F	0402 CAP	C0402X5R6R3-474KNE	Venkel
4	5	C7, C211, C213, C236, C261	1.0 μ F	0402 CAP	C0402X5R6R3-105KNE	Venkel
5	2	C8, C9	22pF	0402 CAP	C0402COG500-220JNE	Venkel
6	5	C15, C21, C27, C34, C42	1.0 μ F	0603 CAP	C1608X7R1C105K	TDK Corporation
7	5	C31, C32, C33, C46, C47	1000pF	0603 CAP	C0603X7R101-102KNE	Venkel
8	1	C3	10 μ F	0603 CAP	ECJ-1VB0J106M	Panasonic
9	5	C14, C20, C26, C36, C41	4.7 μ F	0603 CAP	C0603C475K8PACTU	Kemet

Table 3. TLK10002EVM FPGA Daughterboard Bill of Materials (continued)

Item	Qty	Reference	Value	Part	Part Number	Manufacturer
10	6	C51, C56, C60, C64, C67, C72	0.01 μ F	0805 CAP	GRM21BR72A103KA01L	Murata Electronics North America
11	6	C49, C55, C59, C63, C68, C71	0.1 μ F	1206 CAP	C1206C104J5RACTU	Kemet
12	11	C18, C24, C30, C39, C45, C50, C54, C58, C62, C66, C70	1.0 μ F	1206 CAP	C1206X7R250-105KNE	Venkel
13	11	C17, C23, C29, C38, C44, C48, C53, C57, C61, C65, C69	10 μ F	1206 CAP	C1206X7R160-106KNE	Venkel
14	6	C16, C22, C28, C37, C43, C52	68 μ F	1210 CAP	C3225X5R0J686M	TDK Corporation
15	5	C13, C19, C25, C35, C40	100 μ F	1812 CAP	GRM43SR60J107ME20L	Murata Electronics North America
16	18	R82, R83, R84, R85, R86, R87, R88, R89, R353, R354, R355, R356, R357, R358, R359, R360, R381, R389	0.0 (Zero Ohm)	0201 RES	CR0201-20W-000T	Venkel
17	8	R108, R109, R112, R113, R119, R120, R123, R124	130	0201 RES	RR0306P-131-D	Susumu Co Ltd
18	16	R96, R97, R98, R99, R106, R107, R110, R111, R118, R121, R122, R125, R126, R127, R128, R129	150	0201 RES	ERJ-1GEF1500C	Panasonic - ECG
19	8	R101, R102, R104, R105, R114, R115, R116, R117	82.5	0201 RES	ERJ-1GEF82R5C	Panasonic - ECG
20	38	R72, R73, R179, R180, R181, R182, R183, R184, R185, R186, R201, R202, R203, R204, R215, R216, R219, R221, R223, R225, R227, R229, R231, R233, R235, R237, R239, R241, R243, R264, R265, R266, R267, R379, R380, R384, R392, R393	0.0 (Zero Ohm)	0402 RES	ERJ-2GE0R00X	Panasonic - ECG
21	1	R18	1.00M	0402 RES	CR0402-16W-1004FT	Venkel
22	3	R14, R31, R32	1.50K	0402 RES	RG1005P-152-B-T5	Susumu
23	2	R343, R347	1.65K	0402 RES	ERJ-2RKF1651X	Panasonic - ECG
24	2	R329, R337	1.80K	0402 RES	RG1005P-182-B-T5	Susumu Co Ltd
25	17	R78, R132, R189, R272, R273, R288, R289, R310, R311, R318, R319, R330, R331, R338, R339, R346, R350	10.0K	0402 RES	RG1005P-103-B-T5	Susumu Co Ltd
26	6	R1, R2, R4, R17, R77, R91	100	0402 RES	RG1005P-101-B-T5	Susumu Co Ltd
27	13	R3, R5, R9, R10, R11, R13, R81, R135, R192, R277, R279, R291, R294	100K	0402 RES	RG1005P-104-B-T5	Susumu
28	10	R305, R307, R313, R315, R325, R327, R333, R335, R344, R348	105K	0402 RES	ERJ-2RKF1053X	Panasonic - ECG

Table 3. TLK10002EVM FPGA Daughterboard Bill of Materials (continued)

Item	Qty	Reference	Value	Part	Part Number	Manufacturer
29	2	R324, R332	12.4K	0402 RES	RG1005P-1242-B-T5	Susumu Co Ltd
30	14	R67, R70, R131, R134, R188, R191, R269, R271, R276, R278, R285, R287, R292, R295	130	0402 RES	RG1005P-131-B-T5	Susumu Co Ltd
31	1	R12	15.0K	0402 RES	RG1005P-153-B-T5	Susumu
32	8	R38, R39, R195, R196, R328, R336, R345, R349	2.00K	0402 RES	RG1005P-202-B-T5	Susumu
33	4	R308, R309, R316, R317	2.80K	0402 RES	RG1005P-2801-B-T5	Susumu Co Ltd
34	14	R74, R75, R149, R150, R193, R194, R280, R281, R282, R283, R296, R297, R298, R299	20.0K	0402 RES	RG1005P-203-B-T5	Susumu
35	24	R68, R69, R171, R172, R173, R174, R175, R176, R177, R178, R220, R222, R224, R226, R228, R230, R232, R234, R236, R238, R240, R242, R383, R398	249	0402 RES	RR0510P-2490-D	Susumu Co Ltd
36	4	R304, R306, R312, R314	26.1K	0402 RES	RG1005P-2612-B-T5	Susumu Co Ltd
37	2	R15, R16	33	0402 RES	RR0510R-330-D	Susumu Co Ltd
38	1	R76	330	0402 RES	RG1005P-331-B-T5	Susumu Co Ltd
39	95	R6, R7, R22, R23, R24, R33, R34, R35, R36, R37, R40, R71, R79, R90, R92, R93, R100, R103, R130, R136, R137, R138, R139, R140, R141, R142, R143, R144, R145, R146, R147, R148, R151, R152, R153, R154, R155, R156, R157, R158, R159, R160, R161, R162, R163, R164, R165, R166, R167, R168, R169, R170, R187, R207, R208, R209, R210, R211, R244, R245, R246, R247, R248, R249, R250, R251, R252, R253, R254, R255, R256, R257, R258, R259, R260, R261, R262, R263, R268, R270, R284, R286, R364, R365, R366, R370, R371, R372, R373, R374, R375, R376, R377, R382, R397	4.99K	0402 RES	RG1005P-4991-B-T5	Susumu Co Ltd
40	21	R8, R80, R94, R95, R133, R190, R274, R275, R290, R293, R300, R301, R302, R303, R320, R321, R322, R323, R340, R341, R342	49.9	0402 RES	RG1005P-49R9-B-T5	Susumu Co Ltd
41	2	R326, R334	6.04K	0402 RES	RG1005P-6041-B-T5	Susumu Co Ltd
42	5	R47, R48, R49, R61, R62	0.0 (Zero Ohm)	0603 RES	ERJ-3GEY0R00V	Panasonic - ECG

Table 3. TLK10002EVM FPGA Daughterboard Bill of Materials (continued)

Item	Qty	Reference	Value	Part	Part Number	Manufacturer
43	1	R51	1.65K	0603 RES	RG1608P-1651-B-T5	Susumu Co Ltd
44	2	R54, R65	107	0603 RES	RR0816P-1070-B-T5-04A	Susumu Co Ltd
45	2	R46, R60	2.49K	0603 RES	RG1608P-2491-B-T5	Susumu Co Ltd
46	1	R50	2.80K	0603 RES	RR0816P-2801-D-44H	Susumu Co Ltd
47	1	R63	1.10K	0603 RES	RG1608P-112-B-T5	Susumu Co Ltd
48	1	R53	20	0603 RES	RR0816Q-200-D	Susumu Co Ltd
49	2	R56, R66	27	0603 RES	CR0603-16W-27R0FT	Venkel
50	3	R42, R44, R58	3.57K	0603 RES	RG1608P-3571-B-T5	Susumu Co Ltd
51	2	R52, R64	4.75K	0603 RES	RG1608P-4751-B-T5	Susumu Co Ltd
52	7	R41, R43, R45, R55, R57, R59, R212	4.99K	0603 RES	RG1608P-4991-B-T5	Susumu Co Ltd
53	6	L1, L2, L3, L4, L5, L6	0.0 (Zero Ohm)	1210 RES	RK73Z2ETTE	KOA Speer
54	11	D42, D43, D44, D45, D46, D47, D48, D49, D50, D51, D52	LED - Blue Diffused	C170	HSMR-C170	Avago Technologies US
55	15	D3, D7, D11, D13, D16, D18, D19, D23, D30, D31, D33, D36, D37, D40, D41	LED - Green Diffused	C170	HSMG-C170	Avago Technologies US
56	6	D2, D6, D10, D15, D25, D27	LED - Orange Diffused	C170	HSMD-C170	Avago Technologies US
57	16	D4, D8, D12, D14, D20, D21, D22, D28, D29, D32, D34, D35, D38, D39, D53, D54	LED - Red Diffused	C170	SML-LXT0805IW-TR	Lumex Opto/Components
58	5	D1, D5, D9, D24, D26	LED - Yellow	C170	SML-LXT0805YW-TR	Lumex Opto/Components
59	1	D17	Zener Diode	SOD-323	BAT 60A E6327	Infineon Technologies
60	31	Q1, Q2, Q3, Q4, Q5, Q6, Q7, Q8, Q9, Q10, Q11, Q12, Q15, Q16, Q17, Q18, Q19, Q20, Q21, Q22, Q23, Q24, Q25, Q26, Q27, Q28, Q29, Q30, Q33, Q34, Q35	NFET	SOT-23	FDV301N	Fairchild Semiconductor
61	2	Q13, Q14	NPN	SOT-23-3	MMBT4401	Fairchild Semiconductor
62	13	U6, U12, U17, U19, U22, U24, U26, U28, U31, U34, U37, U40, U43	Dual NPN	SOT-23-6	ZXTD09N50DE6TA	Zetex Inc
63	5	U30, U33, U36, U39, U42	Differential Comparator	14-TSSOP	LM339APWR	Texas Instruments
64	2	U14, U15	Clock Buffer	16-HQFN	CDCLVP1204	Texas Instruments
65	5	U7, U8, U9, U10, U11	Adjustable LDO	20-VQFN	TPS74401RGWT	Texas Instruments
66	2	U2, U44	32MB EEPROM	48-CSBGA	XCF32PFSG48C	Xilinx Inc
67	1	U3	USB Microcontroller	64-LQFP	TUSB3210PM	Texas Instruments
68	1	U1	Spartan-6 FPGA	676-BGA	6SLX75TFGG676	Xilinx Inc
69	1	U4	512KB EEPROM	8-SOIC	24LC512-I/SM	Microchip Technology

Table 3. TLK10002EVM FPGA Daughterboard Bill of Materials (continued)

Item	Qty	Reference	Value	Part	Part Number	Manufacturer
70	1	U45	Bi-Directional Level Shifter	8-SSOP	PCA9306DCTR	Texas Instruments
71	5	U29, U32, U35, U38, U41	Precision Voltage Reference	SOT-23-3	REF2940AIDBZT	Texas Instruments
72	8	U5, U13, U16, U18, U21, U23, U25, U27	Voltage Supervisor with manual Reset	SOT-23-5	TPS3125J18DBVR	Texas Instruments
73	1	X1	12.000MHz Crystal	SMD	ECS-120-32-5PVX	ECS Inc
74	8	SW1, SW2, SW3, SW4, SW5, SW7, SW8, SW9	Momentary Push Button	6.00mm x 6.00mm	EVQ-PBE05R	Panasonic - ECG
75	1	SW6	1-Pos Dip Switch	SMT	SDA01H0SB	ITT Cannon - C&K
76	1	J1	Board to Board Connector	SMT	ASP-134488-01	Samtec
77	21	JMP1, JMP2, JMP3, JMP5, JMP6, JMP8, JMP12, JMP16, JMP18, JMP23, JMP24, JMP25, JMP26, JMP27, JMP30, JMP31, JMP32, JMP33, JMP34, JMP35, JMP36	1 X 2	0.1"	HTSW-150-08-G-S	Samtec
78	5	JMP4, JMP7, JMP10, JMP11, JMP20	1 X 3	0.1"	HTSW-150-08-G-S	Samtec
79	1	JMP9	14 Pin - Shrouded	0.1" SP	N2514-6002RB	3M
80	3	JMP19, JMP28, JMP29	2 X 2	0.1x0.1"	HTSW-150-08-G-D	Samtec
81	1	JMP15	2 X 4	0.1x0.1"	HTSW-150-08-G-D	Samtec
82	2	JMP14, JMP21	2 X 5	0.1x0.1"	HTSW-150-08-G-D	Samtec
83	1	JMP13	2 X 8	0.1x0.1"	HTSW-150-08-G-D	Samtec
84	2	JMP17, JMP22	2 X 20	0.1x0.1"	HTSW-150-08-G-D	Samtec
85	1	P2	Power Jack	2.1mm	PJ-002AH	CUI Inc
86	2	P1, P3	Banana Plug - Metal	4mm	108-0740 -001	Emerson Network Pwr Co
87	1	J2	USB - B Type	B Type	897-43-004-90-000000	Mill-Max Manufacturing Co
88	9	J3, J4, J5, J6, J7, J8, J9, J10, J11	Surface Mount SMA	T/H_SMT SMA	32K141-40ML5	Rosenberger
89	4	Screws	4-40/0.25"- Screws	Phillips	PMSSS 440 0025 PH	Building Fasteners
90	4	Standoff	1" Standoff	Round Threaded	2031	Keystone Electronics
91	18	Shunt	Shunt	0.1" SP	151-8000-E	Kobiconn
92	36	R205, R206, R217, R218, R351, R352, R197, R198, R19, R20, R21, R25, R26, R27, R28, R29, R30, R361, R362, R363, R367, R368, R369, R385, R386, R387, R388, R390, R391, R394, R395, R396, R199, R200, R213, R214	DNI			
93	2	Q31, Q32	DNI			

15 TLK1002EVM FPGA Daughterboard Layout

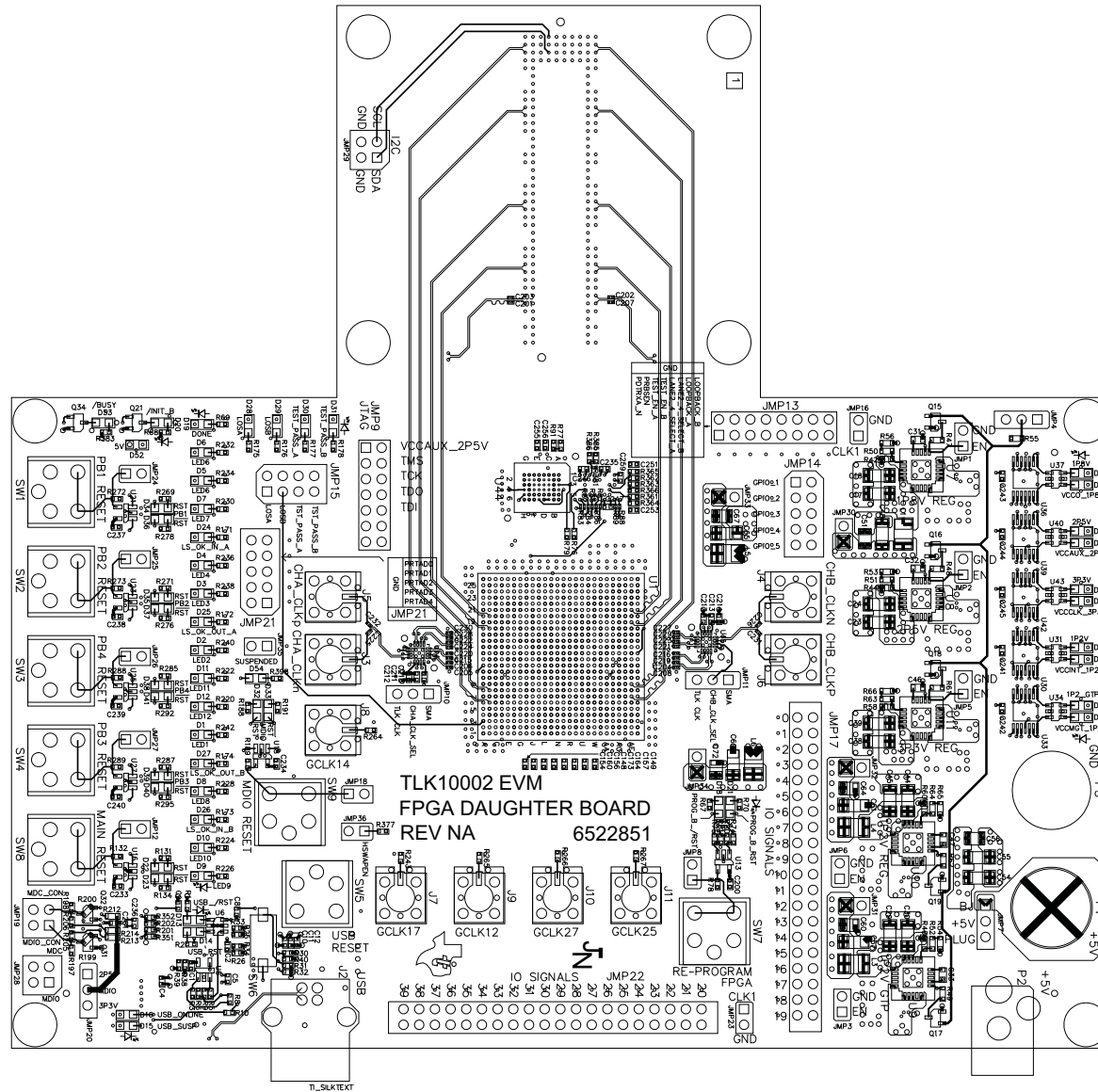

Figure 54. Top Signal, Layer 1

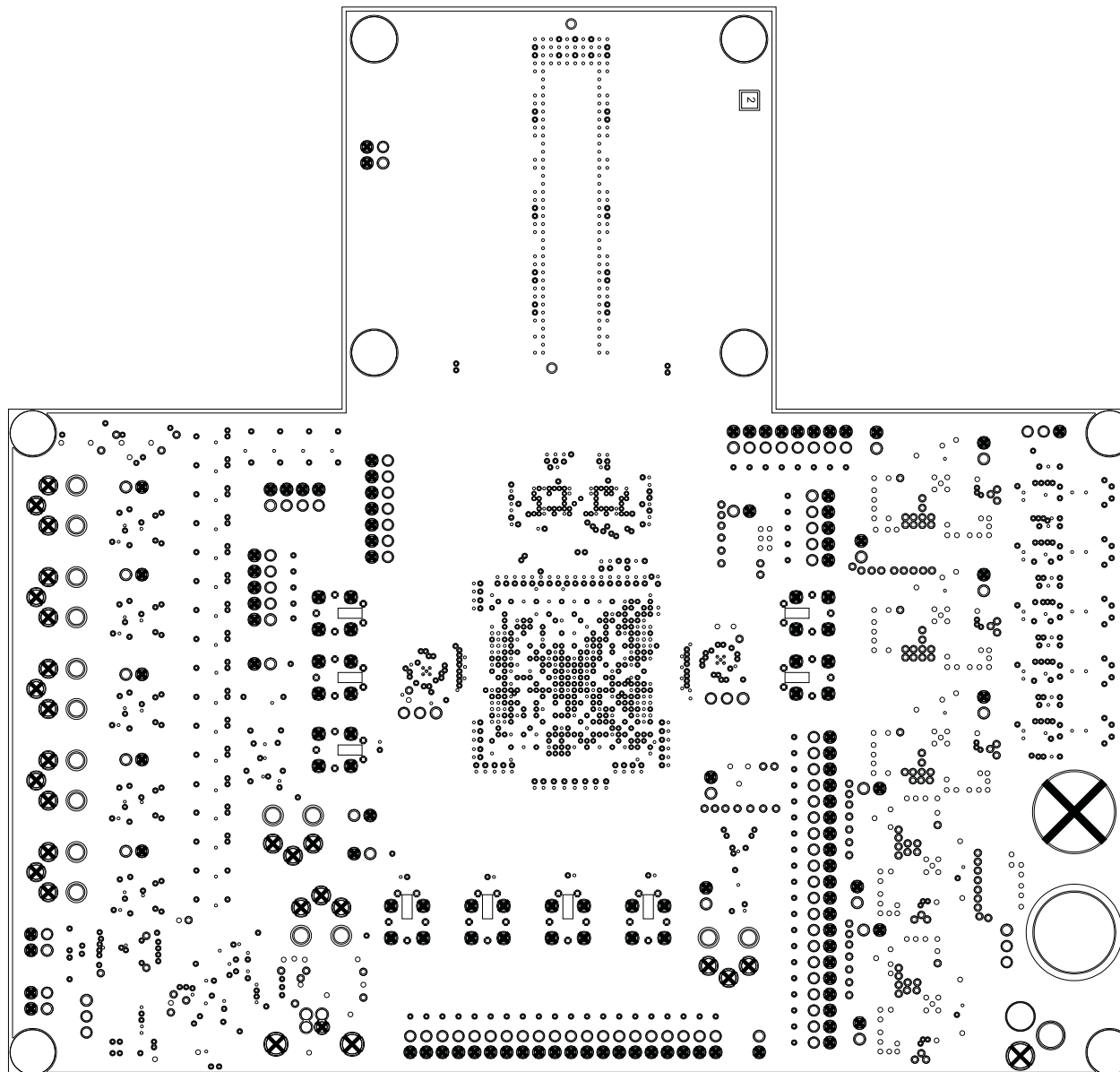

Figure 55. Internal Ground, Layer 2

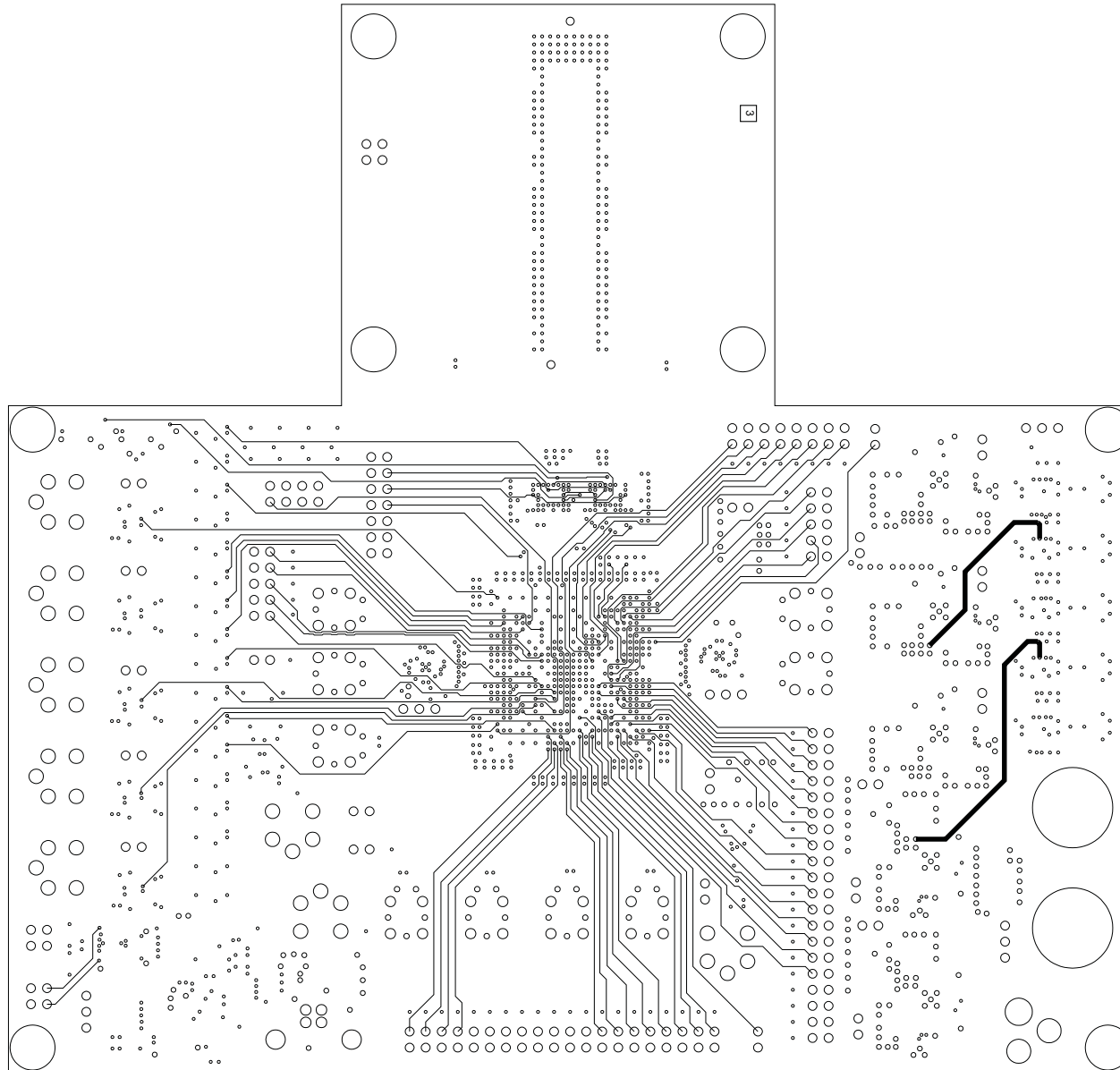

Figure 56. Internal Signal, Layer 3

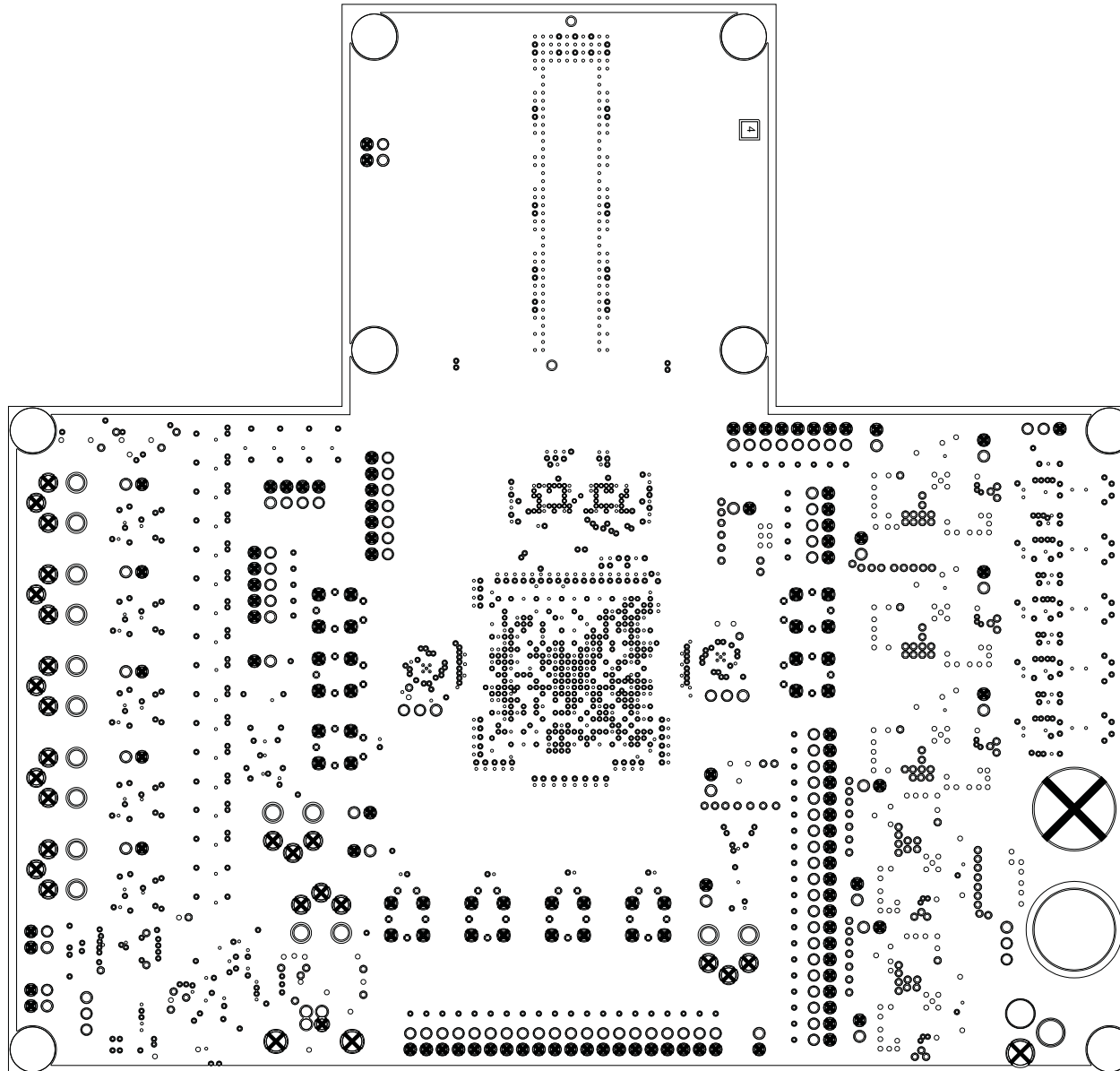

Figure 57. Internal Ground, Layers 4, 6, 7, 9, 11, and 13

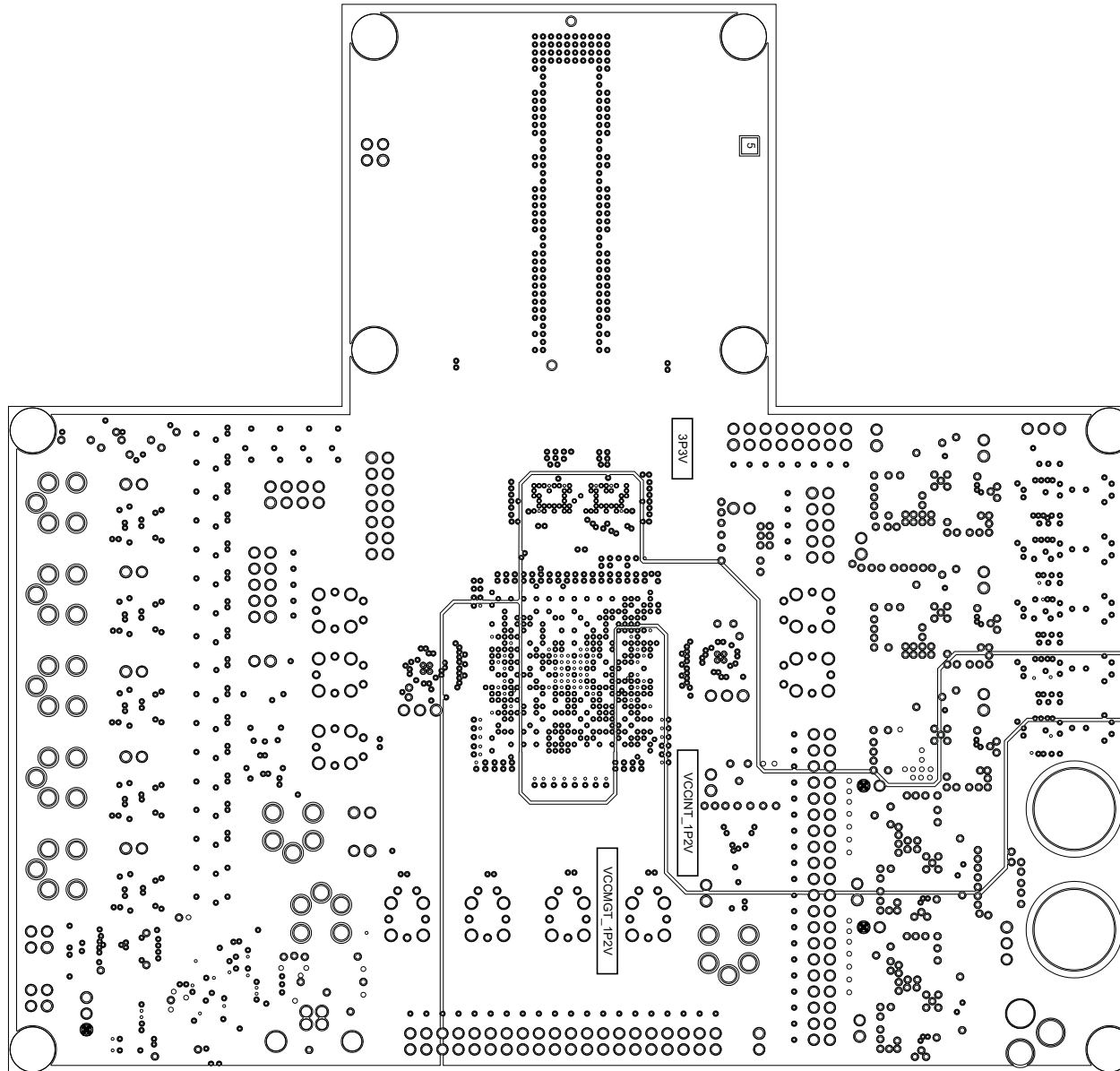

Figure 58. Internal Power, Layer 5

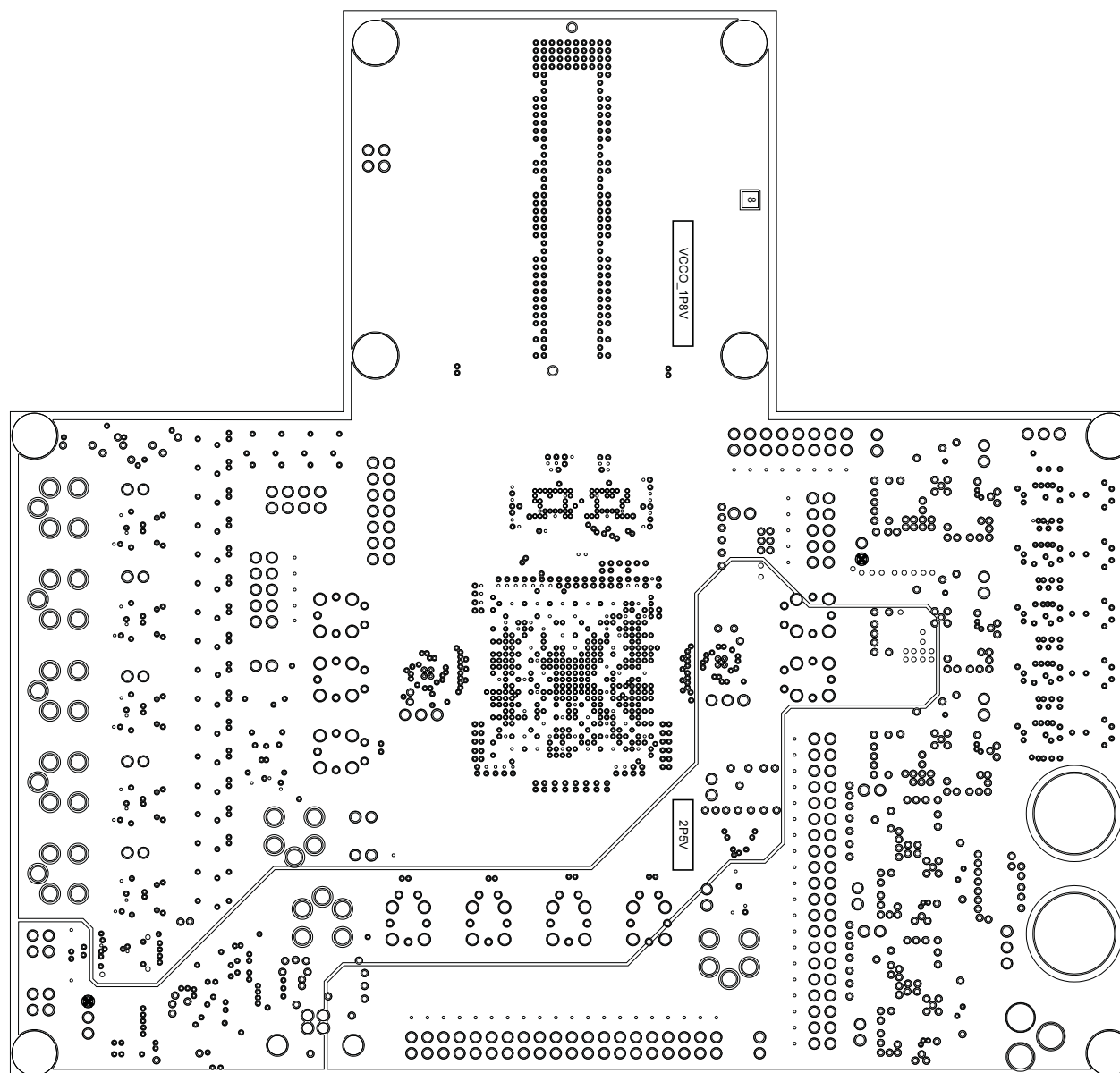

Figure 59. Internal Power, Layer 8

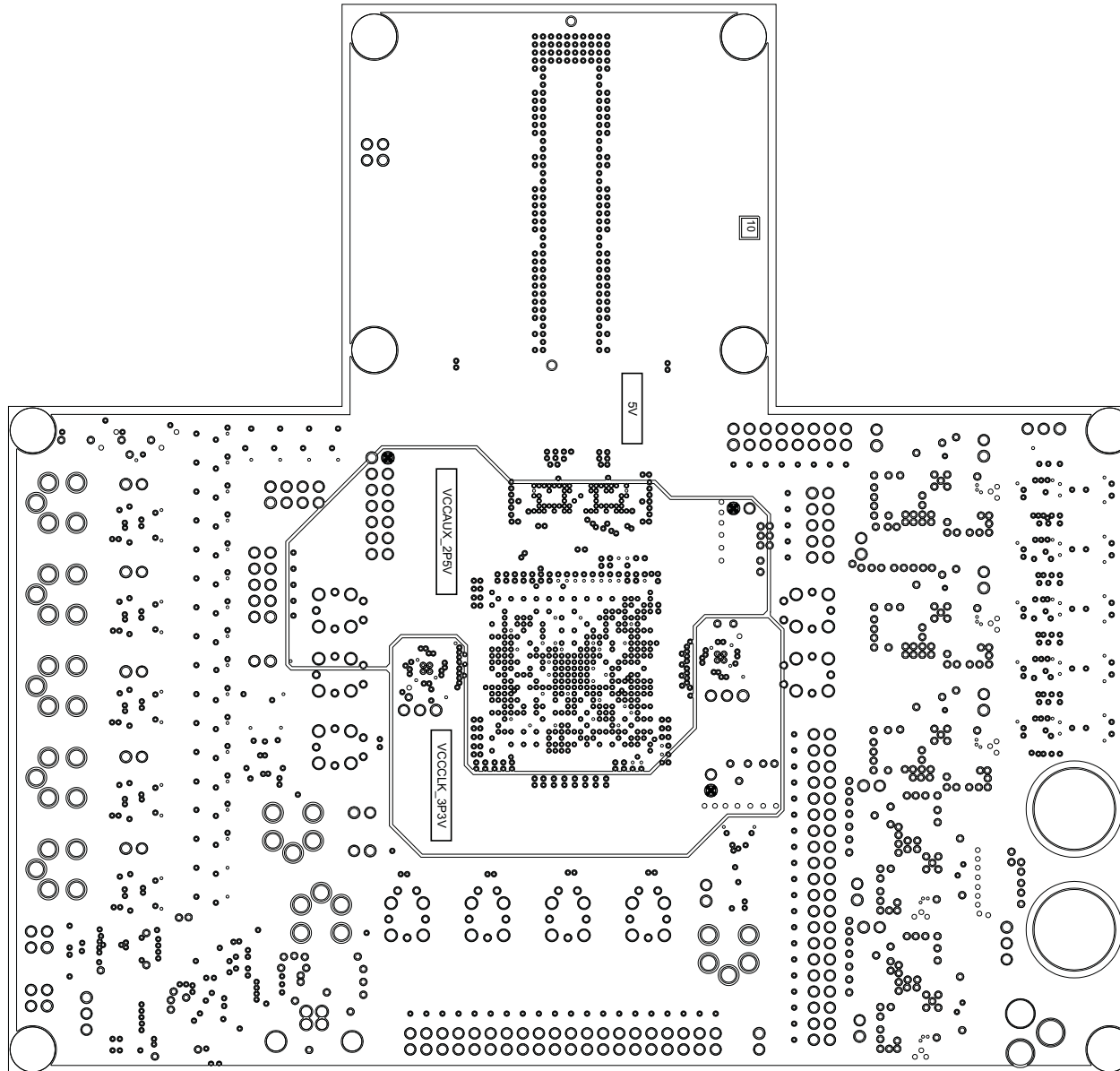

Figure 60. Internal Power, Layer 10

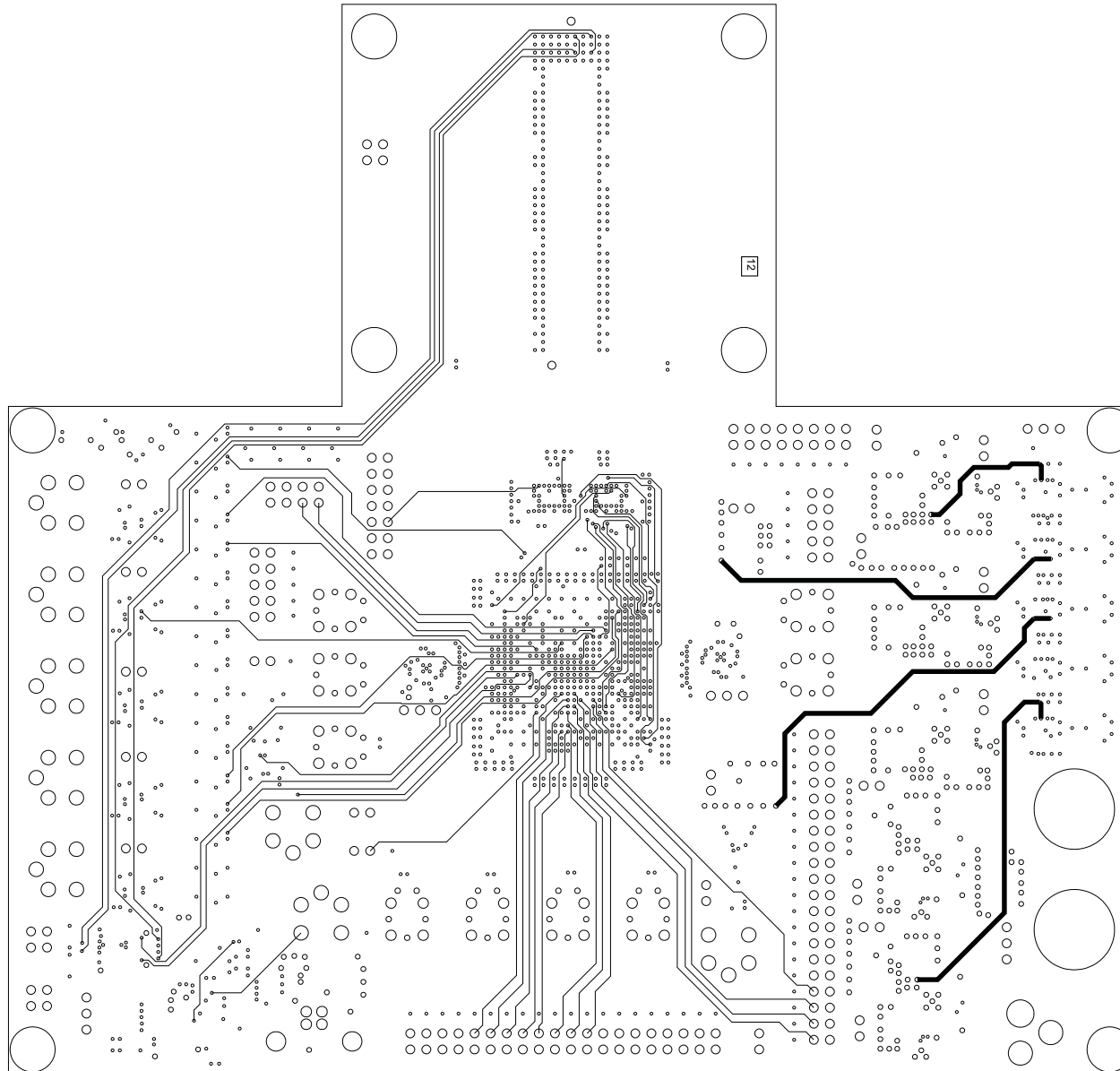

Figure 61. Internal Signal, Layer 12

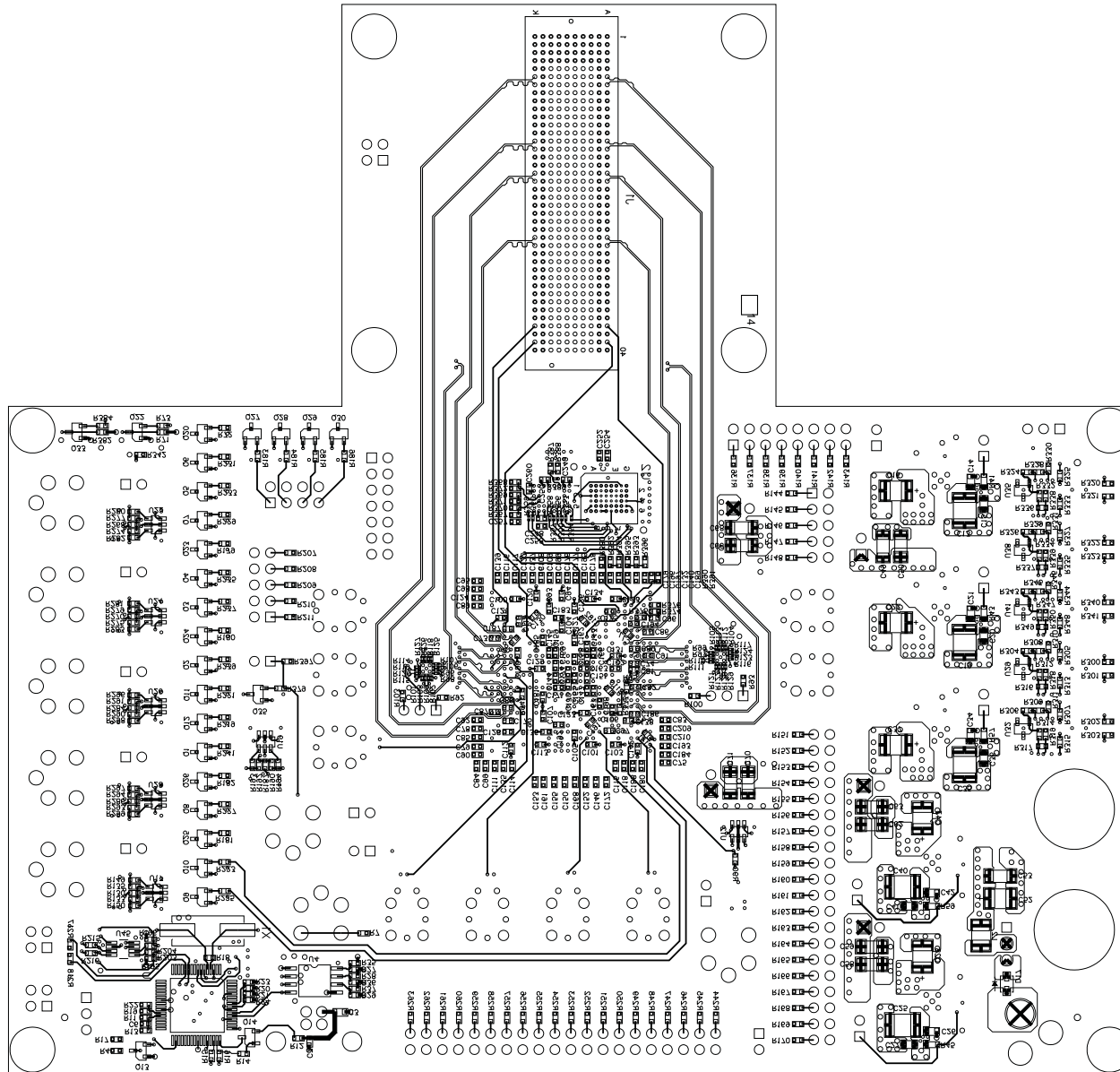

Figure 62. Bottom Signal, Layer 14, Top View

Table 4. TLK10002EVM FPGA Daughterboard Layer Construction

SUBCLASS NAME	TYPE	MATERIAL	THICKNESS (MIL)	DIELECTRIC CONSTANT	LOSS TANGENT	WIDTH (MIL)	COUPLING TYPE/SPACING (MIL)	IMPEDANCE ⁽¹⁾ (Ω)
	SURFACE	AIR		1	0			
TOP	CONDUCTOR	COPPER	1.96	4.1	0	6.00	Edge/5.00	97.298
	DIELECTRIC	FR-4	5	4.1	0.035			
L2_GND	PLANE	COPPER	1.2	1	0			
	DIELECTRIC	FR-4	5	4.1	0.035			
L3_SIG2	CONDUCTOR	COPPER	1.2	1	0	5.00	NONE/NONE	49.7
	DIELECTRIC	FR-4	10	4.1	0.035			
L4_GND	PLANE	COPPER	1.2	1	0			
	DIELECTRIC	FR-4	5	4.1	0.035			
L5_PWR	CONDUCTOR	COPPER	1.2	1	0			
	DIELECTRIC	FR-4	5	4.1	0.035			
L6_GND	PLANE	COPPER	1.2	1	0			
	DIELECTRIC	FR-4	5	4.1	0.035			
L7_GND	PLANE	COPPER	1.2	1	0			
	DIELECTRIC	FR-4	10	4.1	0.035			
L8_PWR	PLANE	COPPER	1.2	1	0			
	DIELECTRIC	FR-4	5	4.1	0.035			
L9_GND	PLANE	COPPER	1.2	1	0			
	DIELECTRIC	FR-4	5	4.1	0.035			
L10_PWR	PLANE	COPPER	1.2	1	0			
	DIELECTRIC	FR-4	5	4.1	0.035			
L11_GND	PLANE	COPPER	1.2	1	0			
	DIELECTRIC	FR-4	10	4.1	0.035			
L12_SIG3	CONDUCTOR	COPPER	1.2	1	0	5.0	NONE/NONE	49.7
	DIELECTRIC	FR-4	5	4.1	0.035			
L13_GND	PLANE	COPPER	1.2	1	0			
	DIELECTRIC	FR-4	5	4.1	0.035			
BOTTOM	CONDUCTOR	COPPER	1.96	1	0	9.50	NONE/NONE	48.425
	SURFACE	AIR						

⁽¹⁾ The Impedance is set to be slightly less than 50 Ω or 100 Ω on the traces in order to compensate for slight over-etching during the manufacturing process. The end impedance after etching should result in a 50 or 100- Ω Impedance. Always consult with your board manufacturer for their process/design requirements to ensure the desired impedance is achieved.

16 TLK10002EVM SMA Breakout Board Schematics



<p>NOTES:</p> <ol style="list-style-type: none"> 1. PLACE NET NAMES ON ALL JUMPERS AND HEADERS. 2. PLACE ALL PARTS OTHER THAN SMA CONNECTORS ON A 0 OR 90 DEGREE ORIENTATION. 3. SERIAL DATA SHOULD BE ROUTED AS 100 OHM DIFFERENTIALLY COUPLED OR SINGLE-ENDED 50 OHM TRANSMISSION LINES ON OUTSIDE LAYERS. ROUTING DISTANCE SHOULD BE 5 INCHES OR LESS. ALL OTHER DATA LINES SHOULD BE 50 OHM IMPEDANCE ON INTERNAL OR EXTERNAL LAYERS. ROUTED POWERS SHOULD BE A MINIMUM OF 40 MILS WIDE. 4. USE FR-4/370 MATERIAL FOR ALL LAYERS. 5. SERIAL AND REFCLK NETS MUST MATCH WITHIN +/- 0.5 MILS. 6. MATCH DIFFERENTIAL TRACE WIDTHS OF SERIAL AND REFCLK LINES WITH SMP/SMA PADS. 7. PLACE TI LOGO, BOARD NAME, JNCOMBO LOGO AND THE BOARD NUMBER IN TOP SIDE METAL. 	<table border="1" style="width: 100%; border-collapse: collapse;"> <thead> <tr> <th colspan="3">REVISIONS</th> </tr> <tr> <th>ECR</th> <th>ECR NUMBER</th> <th>DATE</th> </tr> </thead> <tbody> <tr> <td> </td> <td>----</td> <td>xx/xx/xx</td> </tr> </tbody> </table>	REVISIONS			ECR	ECR NUMBER	DATE		----	xx/xx/xx																																			
REVISIONS																																													
ECR	ECR NUMBER	DATE																																											
	----	xx/xx/xx																																											
<div style="border: 1px solid black; padding: 10px; width: fit-content; margin: 0 auto;"> <p>SCHEMATIC SHEET INDEX:</p> <p>SHEET 01: TLK10002 EVM SMA BREAKOUT DAUGHTER BOARD COVER SHEET AND NOTES</p> <p>SHEET 02: CHANNEL A SIGNALS</p> <p>SHEET 03: CHANNEL B SIGNALS</p> <p>SHEET 04: COMMON SIGNALS</p> </div>																																													
<p>TLK10002 DATA SHEET REVISION: 0.7</p> <p>DATA SHEET LAST UPDATED ON: 09/27/10</p>	<table border="1" style="width: 100%; border-collapse: collapse;"> <tr> <td colspan="2" style="text-align: center;"></td> <td colspan="2" style="text-align: center;">TEXAS INSTRUMENTS</td> </tr> <tr> <td colspan="4" style="text-align: center;">SCHEMATIC TITLE</td> </tr> <tr> <td colspan="4" style="text-align: center;">TLK10002 EVM SMA BREAKOUT DAUGHTER BOARD</td> </tr> <tr> <td colspan="4" style="text-align: center;">PAGE TITLE</td> </tr> <tr> <td colspan="4" style="text-align: center;">COVER PAGE AND NOTES</td> </tr> <tr> <td style="font-size: small;">ENGINEER</td> <td style="font-size: small;">DATE</td> <td style="font-size: small;">SIZE</td> <td style="font-size: small;">DOCUMENT NUMBER</td> </tr> <tr> <td>J. NERGER</td> <td>11/09/10</td> <td>B</td> <td>0522051</td> </tr> <tr> <td style="font-size: small;">LAYOUT</td> <td style="font-size: small;">DATE</td> <td style="font-size: small;">REV</td> <td style="font-size: small;">SHEET</td> </tr> <tr> <td>J. NERGER</td> <td>11/09/10</td> <td>NA</td> <td>1 of 4</td> </tr> <tr> <td style="font-size: small;">RELEASED</td> <td style="font-size: small;">DATE</td> <td colspan="2"></td> </tr> <tr> <td>J. NERGER</td> <td>11/09/10</td> <td colspan="2"></td> </tr> </table>			TEXAS INSTRUMENTS		SCHEMATIC TITLE				TLK10002 EVM SMA BREAKOUT DAUGHTER BOARD				PAGE TITLE				COVER PAGE AND NOTES				ENGINEER	DATE	SIZE	DOCUMENT NUMBER	J. NERGER	11/09/10	B	0522051	LAYOUT	DATE	REV	SHEET	J. NERGER	11/09/10	NA	1 of 4	RELEASED	DATE			J. NERGER	11/09/10		
		TEXAS INSTRUMENTS																																											
SCHEMATIC TITLE																																													
TLK10002 EVM SMA BREAKOUT DAUGHTER BOARD																																													
PAGE TITLE																																													
COVER PAGE AND NOTES																																													
ENGINEER	DATE	SIZE	DOCUMENT NUMBER																																										
J. NERGER	11/09/10	B	0522051																																										
LAYOUT	DATE	REV	SHEET																																										
J. NERGER	11/09/10	NA	1 of 4																																										
RELEASED	DATE																																												
J. NERGER	11/09/10																																												

Figure 63. Cover Page and Index, Sheet 1 of 4

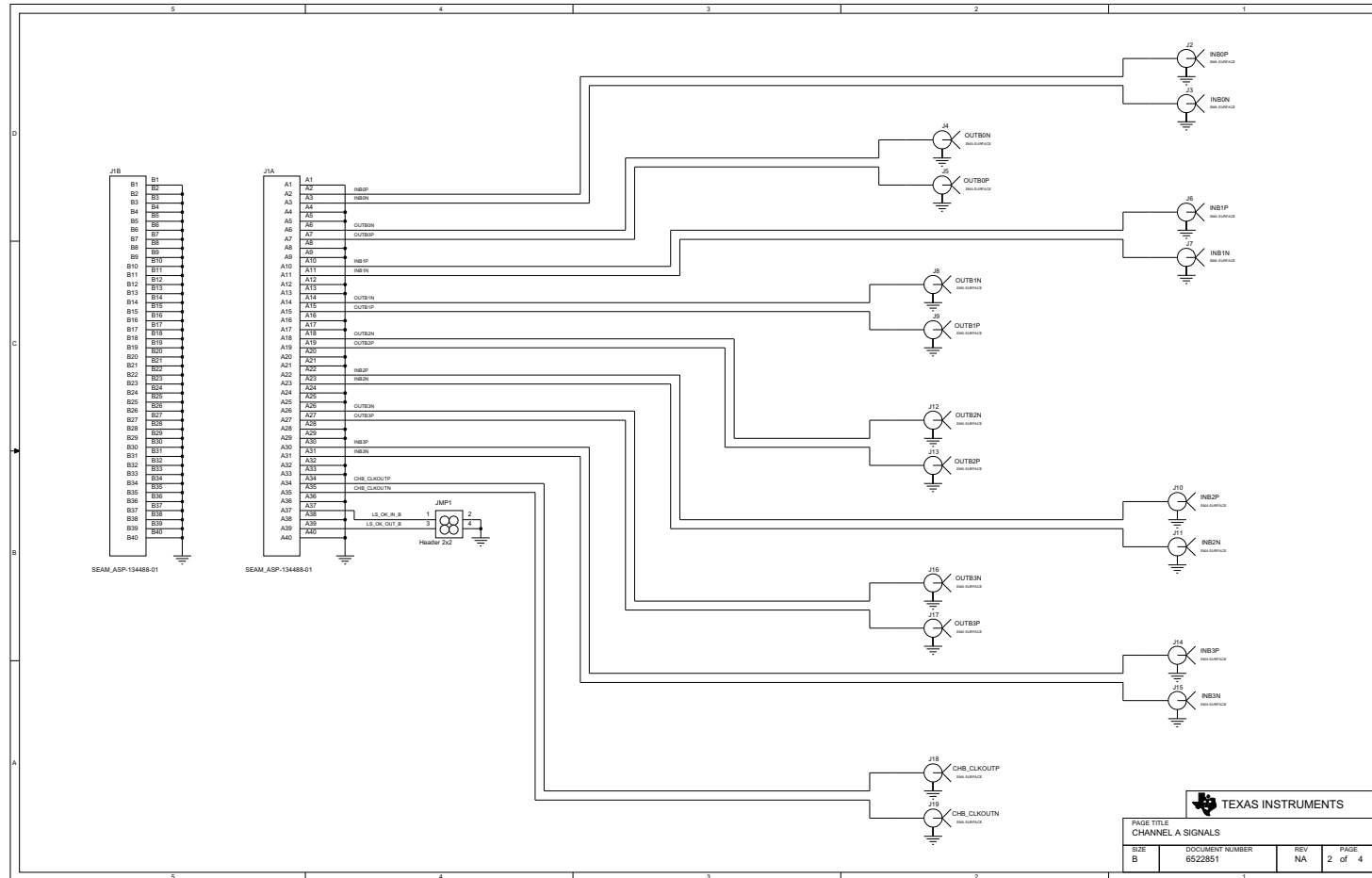

Figure 64. Channel-A Signals, Sheet 2 of 4

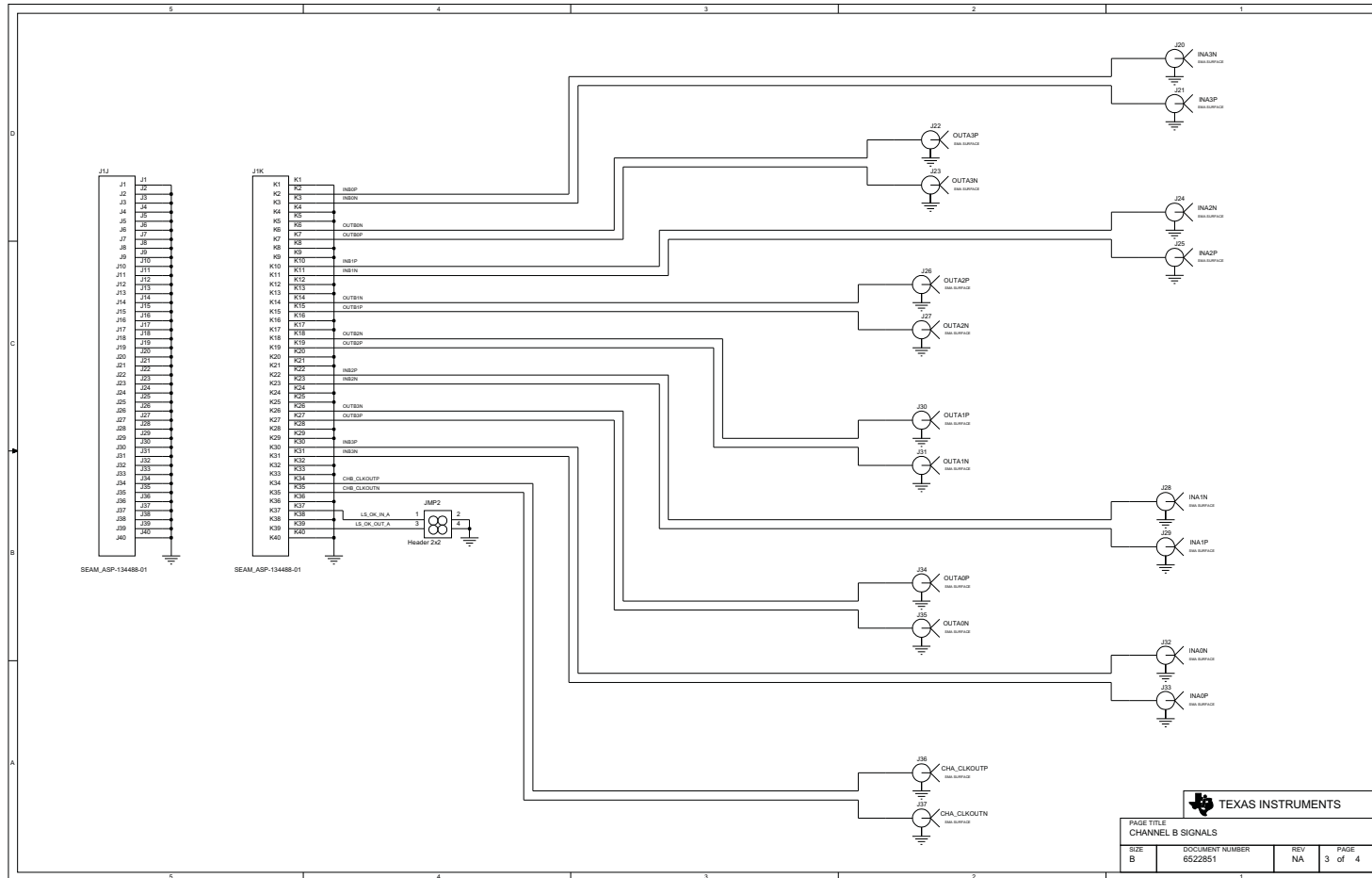

Figure 65. Channel-B Signals, Sheet 3 of 4

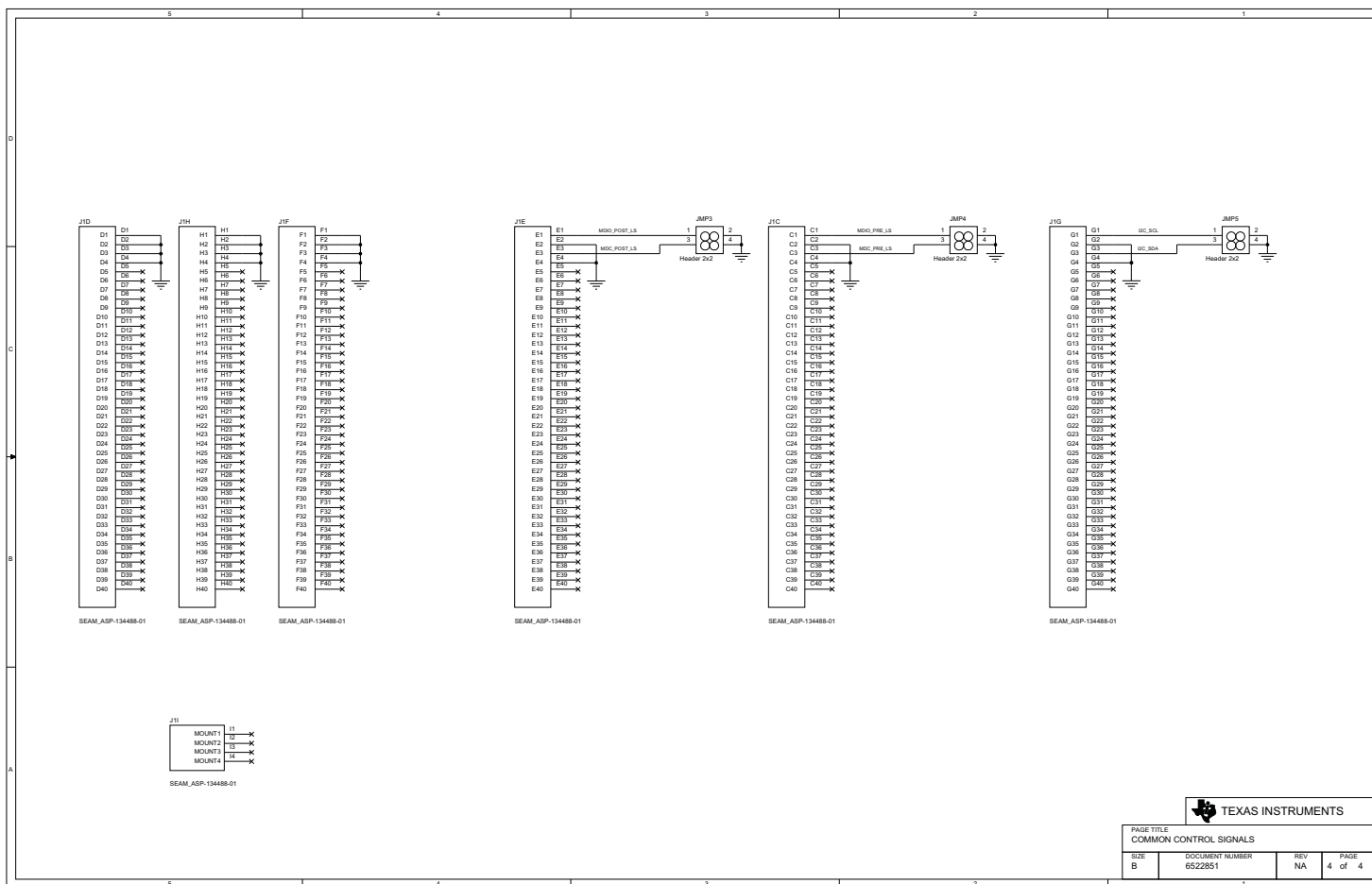

Figure 66. Common Signals, Sheet 4 of 4

Table 5. TLK10002EVM SMA Breakout Board Bill of Materials

Item	Qty	Reference	Value	Part	Part_Number	Manufacturer
1	1	J1	Board to Board Connector	SMT	ASP-134488-01	Samtec
2	5	JMP1, JMP2, JMP3, JMP4, JMP5	2 X 2	0.1x0.1"	HTSW-150-08-G-D	Samtec
3	36	J2, J3, J4, J5, J6, J7, J8, J9, J10, J11, J12, J13, J14, J15, J16, J17, J18, J19, J20, J21, J22, J23, J24, J25, J26, J27, J28, J29, J30, J31, J32, J33, J34, J35, J36, J37	Surface Mount SMA	T/H_SMT SMA	32K141-40ML5	Rosenberger
4	4	Screws	4-40/0.25"- Screws	Philips	PMSSS 440 0025 PH	Building Fasteners
5	4	Standoff	1" Standoff	Round Threaded	2031	Keystone Electronics
6	2	Shunt	Shunt	0.1" SP	151-8000-E	Kobiconn

17 TLK10002EVM SMA Breakout Board Layout

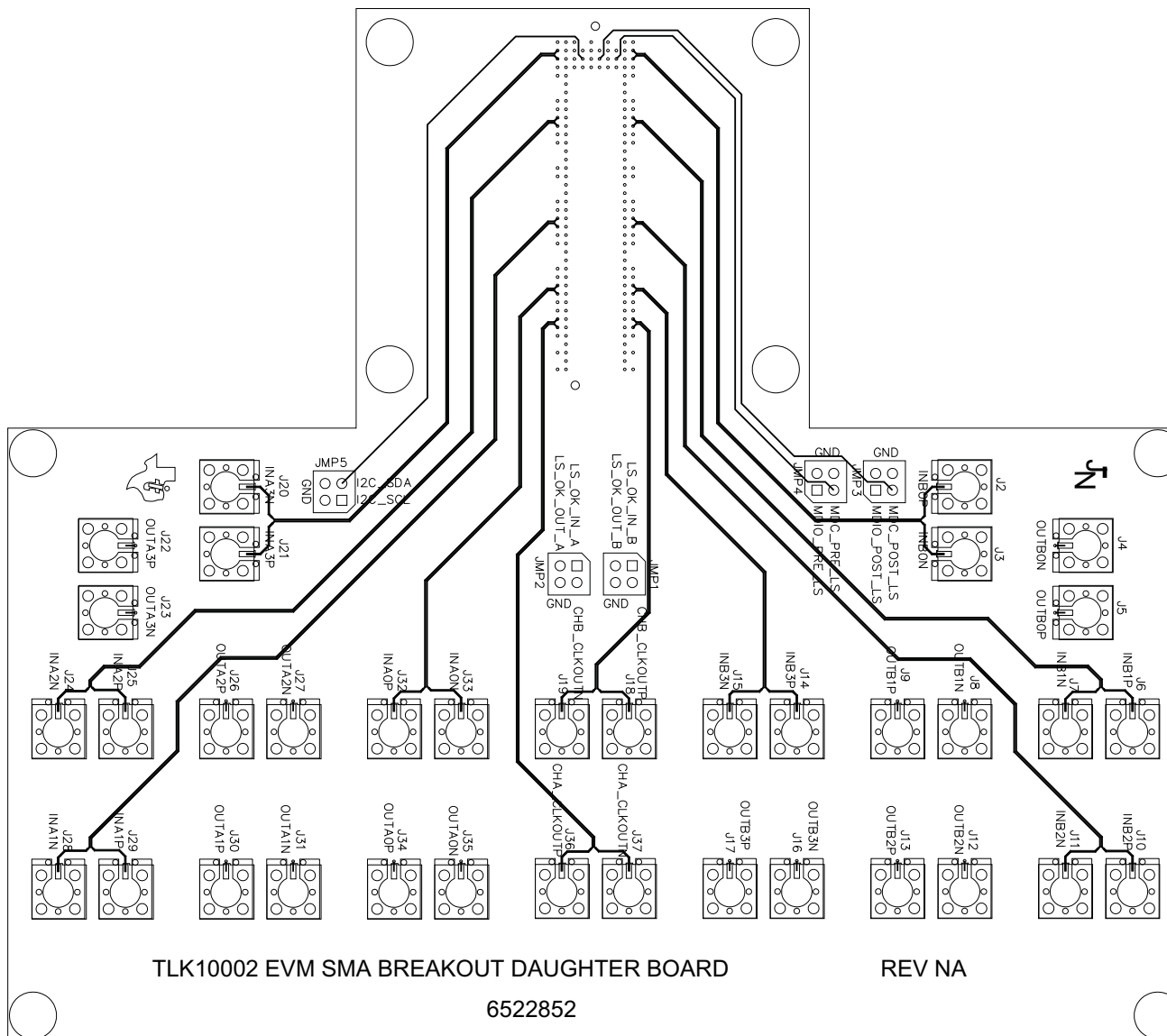

Figure 67. Top Signal, Layer 1

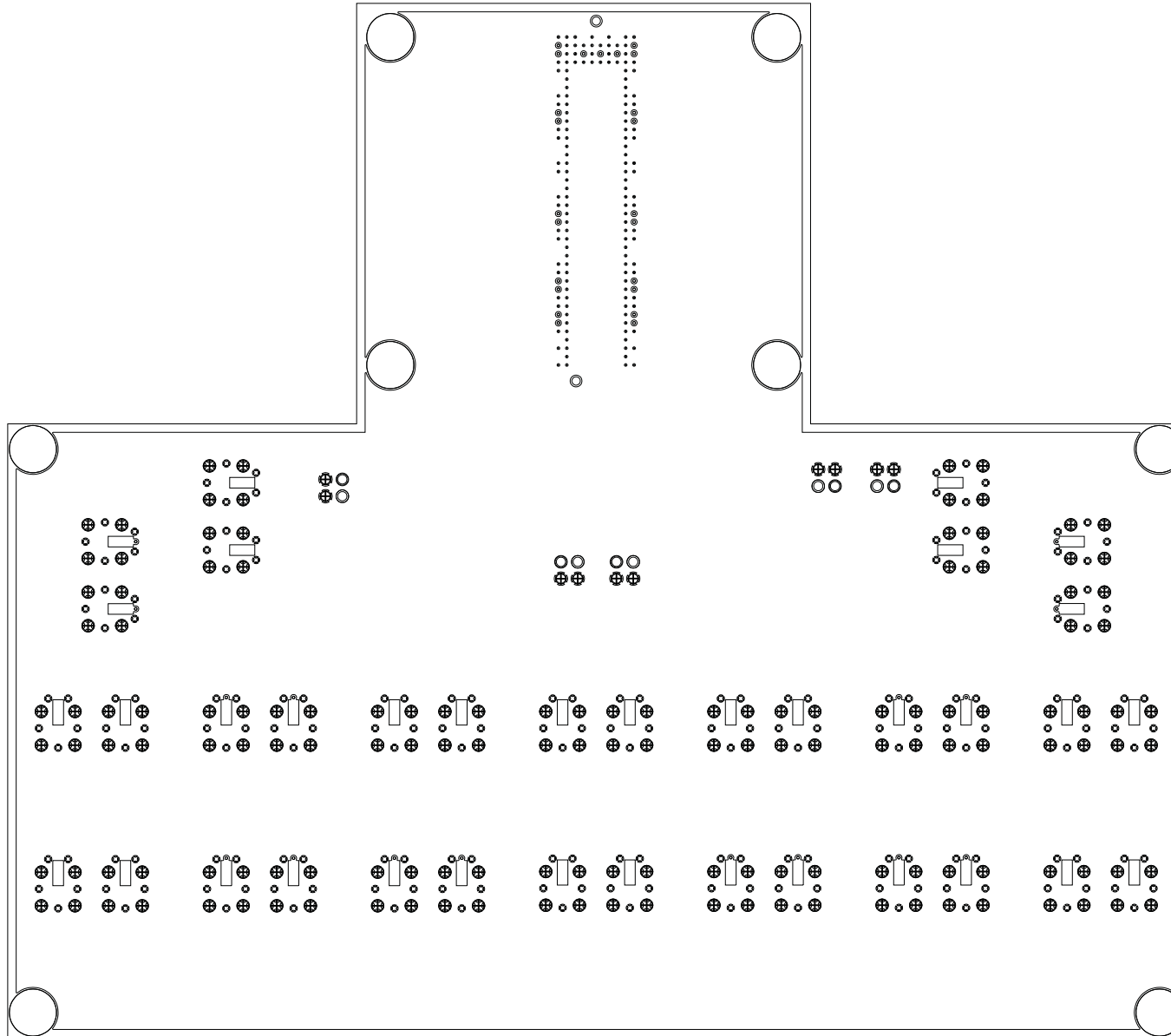

Figure 68. Internal Ground, Layer 2

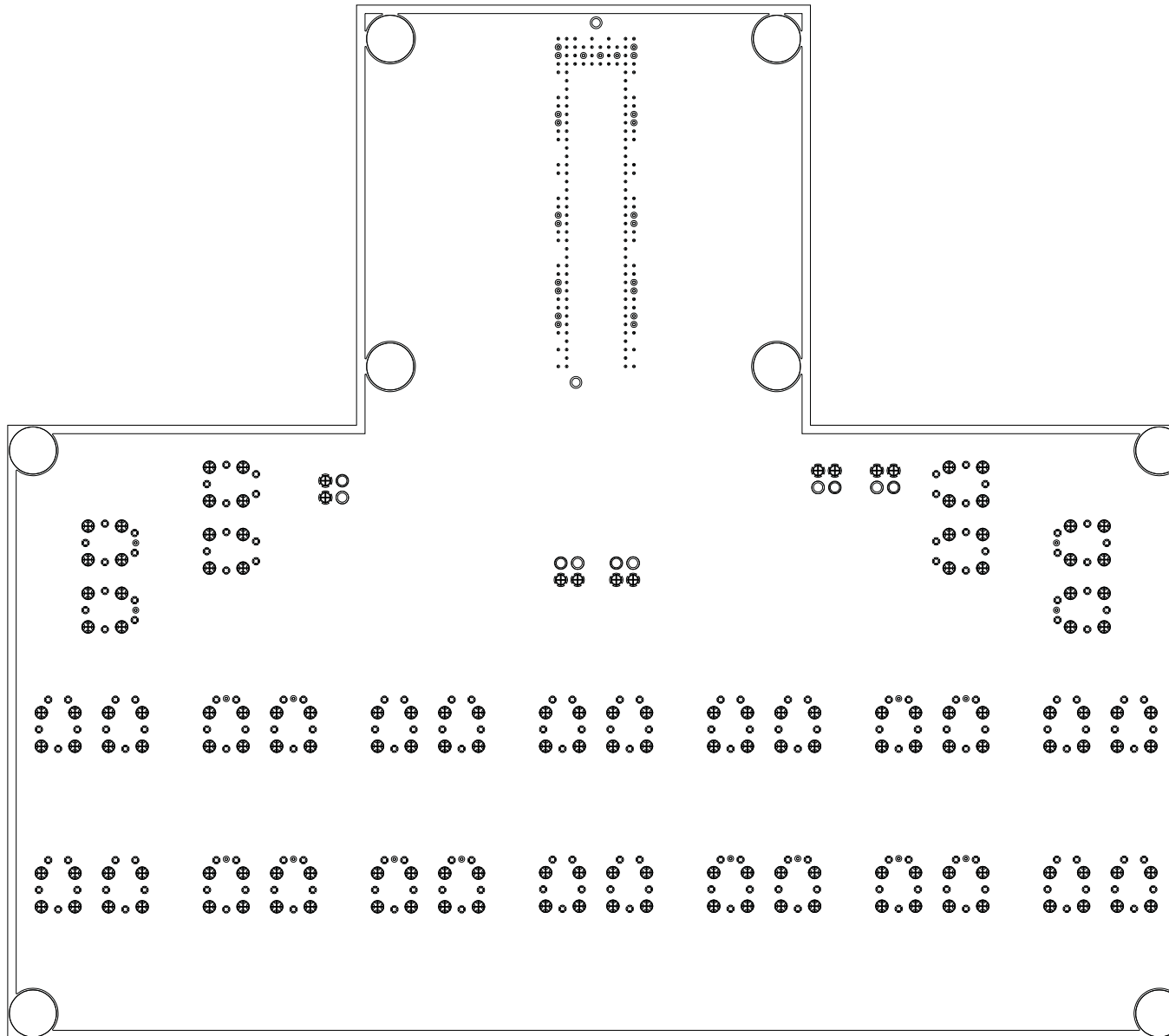

Figure 69. Internal GND, Layers 3, 4, and 5

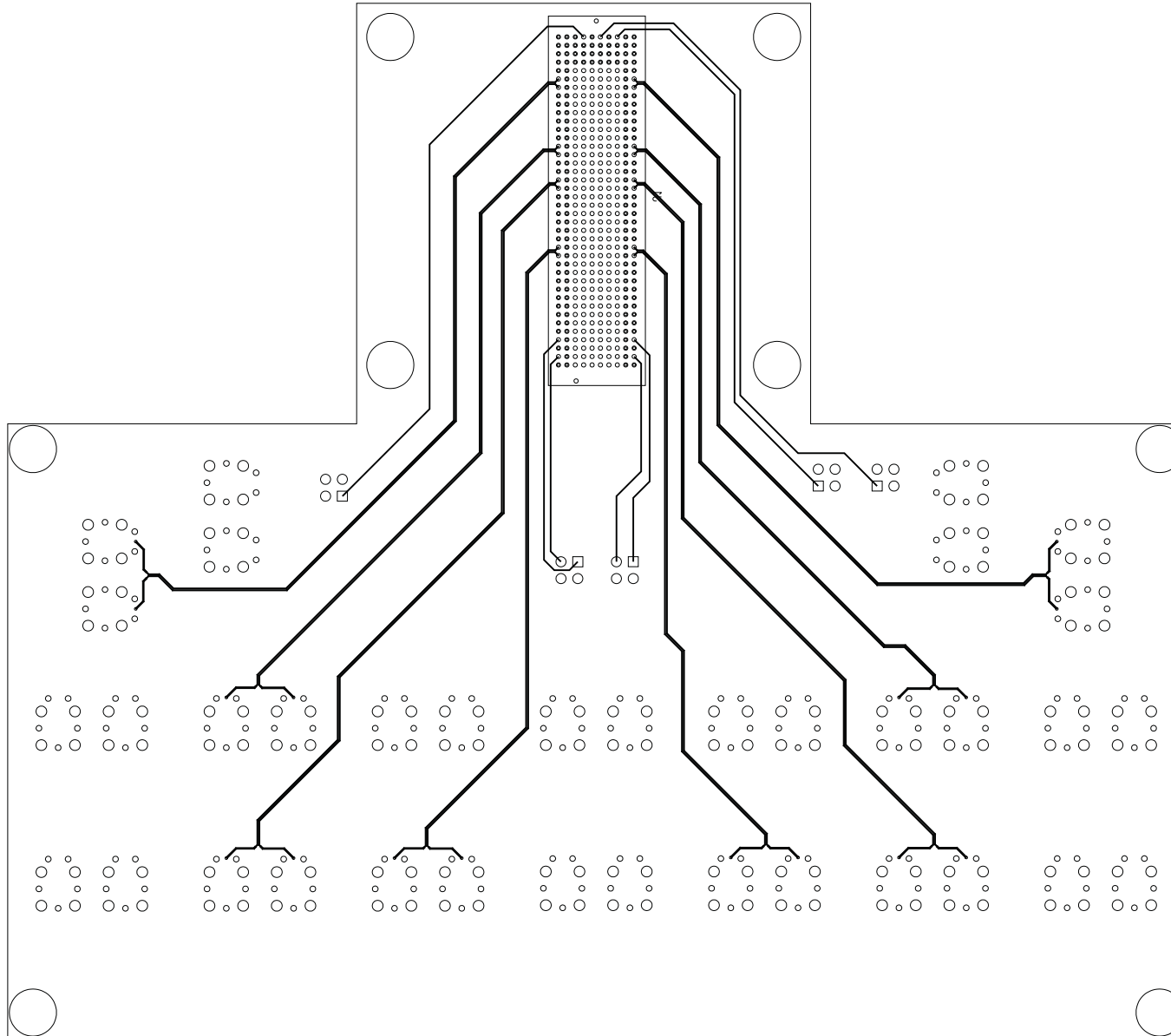

Figure 70. Bottom Signal, Layer 6

Table 6. TLK10002EVM SMA Breakout Board Layer Construction

SUBCLASS NAME	TYPE	MATERIAL	THICKNESS (MIL)	DIELECTRIC CONSTANT	LOSS TANGENT	WIDTH (MIL)	COUPLING TYPE/SPACING (MIL)	IMPEDANCE ⁽¹⁾ (Ω)
	SURFACE	AIR		1	0			
TOP	CONDUCTOR	COPPER	1.96	4.1	0	6.00	Edge/5.00	97.298
	DIELECTRIC	FR-4	5	4.1	0.035			
L2_GND1	PLANE	COPPER	1.2	1	0			
	DIELECTRIC	FR-4	5	4.1	0.035			
L3_GND2	PLANE	COPPER	1.2	1	0			
	DIELECTRIC	FR-4	4	4.1	0.035			
L4_GND3	PLANE	COPPER	1.2	1	0			
	DIELECTRIC	FR-4	20	4.1	0.035			
L13_GND4	PLANE	COPPER	1.2	1	0			
	DIELECTRIC	FR-4	5	4.1	0.035			
BOTTOM	CONDUCTOR	COPPER	1.96	1	0	9.50	NONE/NONE	48.425
	SURFACE	AIR						

⁽¹⁾ The Impedance is set to be slightly less than 50 Ω or 100 Ω on the traces in order to compensate for slight over-etching during the manufacturing process. The end impedance after etching should result in a 50 or 100- Ω Impedance. Always consult with your board manufacturer for their process/design requirements to ensure the desired impedance is achieved.

Evaluation Board/Kit Important Notice

Texas Instruments (TI) provides the enclosed product(s) under the following conditions:

This evaluation board/kit is intended for use for **ENGINEERING DEVELOPMENT, DEMONSTRATION, OR EVALUATION PURPOSES ONLY** and is not considered by TI to be a finished end-product fit for general consumer use. Persons handling the product(s) must have electronics training and observe good engineering practice standards. As such, the goods being provided are not intended to be complete in terms of required design-, marketing-, and/or manufacturing-related protective considerations, including product safety and environmental measures typically found in end products that incorporate such semiconductor components or circuit boards. This evaluation board/kit does not fall within the scope of the European Union directives regarding electromagnetic compatibility, restricted substances (RoHS), recycling (WEEE), FCC, CE or UL, and therefore may not meet the technical requirements of these directives or other related directives.

Should this evaluation board/kit not meet the specifications indicated in the User's Guide, the board/kit may be returned within 30 days from the date of delivery for a full refund. **THE FOREGOING WARRANTY IS THE EXCLUSIVE WARRANTY MADE BY SELLER TO BUYER AND IS IN LIEU OF ALL OTHER WARRANTIES, EXPRESSED, IMPLIED, OR STATUTORY, INCLUDING ANY WARRANTY OF MERCHANTABILITY OR FITNESS FOR ANY PARTICULAR PURPOSE.**

The user assumes all responsibility and liability for proper and safe handling of the goods. Further, the user indemnifies TI from all claims arising from the handling or use of the goods. Due to the open construction of the product, it is the user's responsibility to take any and all appropriate precautions with regard to electrostatic discharge.

EXCEPT TO THE EXTENT OF THE INDEMNITY SET FORTH ABOVE, NEITHER PARTY SHALL BE LIABLE TO THE OTHER FOR ANY INDIRECT, SPECIAL, INCIDENTAL, OR CONSEQUENTIAL DAMAGES.

TI currently deals with a variety of customers for products, and therefore our arrangement with the user **is not exclusive.**

TI assumes **no liability for applications assistance, customer product design, software performance, or infringement of patents or services described herein.**

Please read the User's Guide and, specifically, the Warnings and Restrictions notice in the User's Guide prior to handling the product. This notice contains important safety information about temperatures and voltages. For additional information on TI's environmental and/or safety programs, please contact the TI application engineer or visit www.ti.com/esh.

No license is granted under any patent right or other intellectual property right of TI covering or relating to any machine, process, or combination in which such TI products or services might be or are used.

FCC Warning

This evaluation board/kit is intended for use for **ENGINEERING DEVELOPMENT, DEMONSTRATION, OR EVALUATION PURPOSES ONLY** and is not considered by TI to be a finished end-product fit for general consumer use. It generates, uses, and can radiate radio frequency energy and has not been tested for compliance with the limits of computing devices pursuant to part 15 of FCC rules, which are designed to provide reasonable protection against radio frequency interference. Operation of this equipment in other environments may cause interference with radio communications, in which case the user at his own expense will be required to take whatever measures may be required to correct this interference.

EVM Warnings and Restrictions

It is important to operate this EVM within the input voltage range of 0 V to 6 V and the output voltage range of 0 V to 1.8 V .

Exceeding the specified input range may cause unexpected operation and/or irreversible damage to the EVM. If there are questions concerning the input range, please contact a TI field representative prior to connecting the input power.

Applying loads outside of the specified output range may result in unintended operation and/or possible permanent damage to the EVM. Please consult the EVM User's Guide prior to connecting any load to the EVM output. If there is uncertainty as to the load specification, please contact a TI field representative.

During normal operation, some circuit components may have case temperatures greater than 70° C. The EVM is designed to operate properly with certain components above 70° C as long as the input and output ranges are maintained. These components include but are not limited to linear regulators, switching transistors, pass transistors, and current sense resistors. These types of devices can be identified using the EVM schematic located in the EVM User's Guide. When placing measurement probes near these devices during operation, please be aware that these devices may be very warm to the touch.

Mailing Address: Texas Instruments, Post Office Box 655303, Dallas, Texas 75265
Copyright © 2011, Texas Instruments Incorporated

IMPORTANT NOTICE

Texas Instruments Incorporated and its subsidiaries (TI) reserve the right to make corrections, modifications, enhancements, improvements, and other changes to its products and services at any time and to discontinue any product or service without notice. Customers should obtain the latest relevant information before placing orders and should verify that such information is current and complete. All products are sold subject to TI's terms and conditions of sale supplied at the time of order acknowledgment.

TI warrants performance of its hardware products to the specifications applicable at the time of sale in accordance with TI's standard warranty. Testing and other quality control techniques are used to the extent TI deems necessary to support this warranty. Except where mandated by government requirements, testing of all parameters of each product is not necessarily performed.

TI assumes no liability for applications assistance or customer product design. Customers are responsible for their products and applications using TI components. To minimize the risks associated with customer products and applications, customers should provide adequate design and operating safeguards.

TI does not warrant or represent that any license, either express or implied, is granted under any TI patent right, copyright, mask work right, or other TI intellectual property right relating to any combination, machine, or process in which TI products or services are used. Information published by TI regarding third-party products or services does not constitute a license from TI to use such products or services or a warranty or endorsement thereof. Use of such information may require a license from a third party under the patents or other intellectual property of the third party, or a license from TI under the patents or other intellectual property of TI.

Reproduction of TI information in TI data books or data sheets is permissible only if reproduction is without alteration and is accompanied by all associated warranties, conditions, limitations, and notices. Reproduction of this information with alteration is an unfair and deceptive business practice. TI is not responsible or liable for such altered documentation. Information of third parties may be subject to additional restrictions.

Resale of TI products or services with statements different from or beyond the parameters stated by TI for that product or service voids all express and any implied warranties for the associated TI product or service and is an unfair and deceptive business practice. TI is not responsible or liable for any such statements.

TI products are not authorized for use in safety-critical applications (such as life support) where a failure of the TI product would reasonably be expected to cause severe personal injury or death, unless officers of the parties have executed an agreement specifically governing such use. Buyers represent that they have all necessary expertise in the safety and regulatory ramifications of their applications, and acknowledge and agree that they are solely responsible for all legal, regulatory and safety-related requirements concerning their products and any use of TI products in such safety-critical applications, notwithstanding any applications-related information or support that may be provided by TI. Further, Buyers must fully indemnify TI and its representatives against any damages arising out of the use of TI products in such safety-critical applications.

TI products are neither designed nor intended for use in military/aerospace applications or environments unless the TI products are specifically designated by TI as military-grade or "enhanced plastic." Only products designated by TI as military-grade meet military specifications. Buyers acknowledge and agree that any such use of TI products which TI has not designated as military-grade is solely at the Buyer's risk, and that they are solely responsible for compliance with all legal and regulatory requirements in connection with such use.

TI products are neither designed nor intended for use in automotive applications or environments unless the specific TI products are designated by TI as compliant with ISO/TS 16949 requirements. Buyers acknowledge and agree that, if they use any non-designated products in automotive applications, TI will not be responsible for any failure to meet such requirements.

Following are URLs where you can obtain information on other Texas Instruments products and application solutions:

Products

Audio	www.ti.com/audio
Amplifiers	amplifier.ti.com
Data Converters	dataconverter.ti.com
DLP® Products	www.dlp.com
DSP	dsp.ti.com
Clocks and Timers	www.ti.com/clocks
Interface	interface.ti.com
Logic	logic.ti.com
Power Mgmt	power.ti.com
Microcontrollers	microcontroller.ti.com
RFID	www.ti-rfid.com
RF/IF and ZigBee® Solutions	www.ti.com/lprf

Applications

Communications and Telecom	www.ti.com/communications
Computers and Peripherals	www.ti.com/computers
Consumer Electronics	www.ti.com/consumer-apps
Energy and Lighting	www.ti.com/energy
Industrial	www.ti.com/industrial
Medical	www.ti.com/medical
Security	www.ti.com/security
Space, Avionics and Defense	www.ti.com/space-avionics-defense
Transportation and Automotive	www.ti.com/automotive
Video and Imaging	www.ti.com/video
Wireless	www.ti.com/wireless-apps

TI E2E Community Home Page

e2e.ti.com

Mailing Address: Texas Instruments, Post Office Box 655303, Dallas, Texas 75265
Copyright © 2011, Texas Instruments Incorporated