

# Fly-Buck™ Solution

Multiple well-regulated isolated outputs without optocoupler



## Quad Output Reference Design for Industrial PLC I/O Modules

The LM5017 family of Wide  $V_{IN}$  buck converters deliver enhanced reliability for high-voltage systems. The PMP7993.1 quad output reference design features a single-sided board design with a small solution area designed for space-constrained applications.

### Key Features

- Wide  $V_{IN}$  range up to 100 V
- Integrated HS and LS FETs
- Isolated Fly-Buck™ topology
- Primary side feedback

### Target Applications

- Industrial PLC
- Smart meter
- Motor drive
- 48V telecom systems

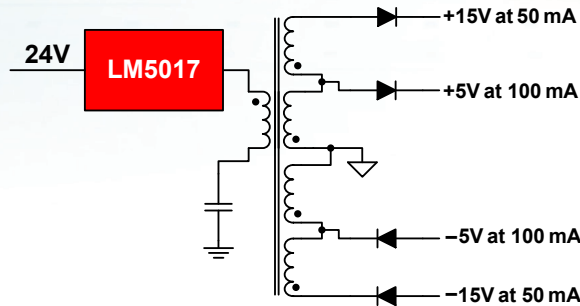

LM5017 quad output circuit diagram

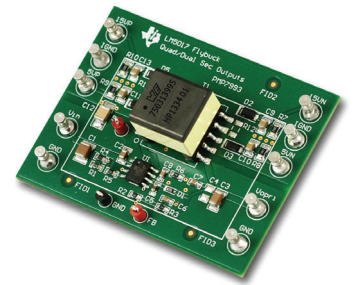

PMP7993.1 board with tiny 40 x 28 mm solution area

### Featured Products

Part	$V_{IN}$ Range (V)	$I_o$ Range (mA)	Package
LM5017	9-100	600	SO-8, WSON
LM5018	9-100	300	SO-8, WSON
LM5019	9-100	100	SO-8, WSON
LM25017	9-48	650	SO-8, WSON
LM25018	9-48	325	SO-8, WSON
LM25019	9-48	100	SO-8, WSON

For samples and more information, please visit:

- Wide  $V_{IN}$  Products: [ti.com/widevin](http://ti.com/widevin)
- LM5017 Details: [ti.com/LM5017](http://ti.com/LM5017)
- Reference Design Information: [ti.com/PMP7993](http://ti.com/PMP7993)

# Flyback Transformers for Texas Instruments LM5017



## Series Common Characteristics

- Low cost and high efficiency
- Operating temp: -40° to +125°C
- Dielectric withstand voltage of 1500V<sub>AC</sub> for 1 minute
- Excellent leakage inductance and interwinding capacitance performance

## Applications

- Industrial controls
- Isolated low power drivers & regulators
- Programmable Logic Circuits, Smart e-meters
- Bias power supplies for gate drives and op-amps
- Isolated interface power: RS-422, RS-485, CAN

## 750313995 Flyback Transformer

- Quad output: +/-15V, +/-5V
- EP13 SMD

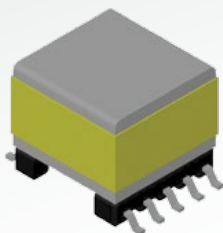

### Quad Output Dimensions & Footprint

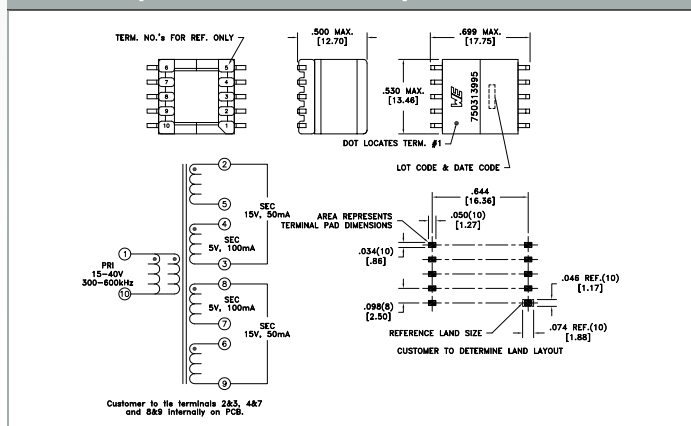

## Electrical Properties

Order Code	Package Size	U <sub>i</sub> (V <sub>AC</sub> )	L (mH)	I <sub>SAT</sub> (A)	N <sub>PRI</sub> :N <sub>SEC</sub> :N <sub>AUX</sub>	f <sub>switch</sub> (kHz)	U <sub>out1</sub> (V)	I <sub>O1</sub> (A)	U <sub>out2</sub> (V)	I <sub>O2</sub> (A)	U <sub>out3</sub> (V)	I <sub>O3</sub> (A)	U <sub>AUX</sub>	U <sub>T</sub> (kV <sub>AC</sub> )
750313995	EP13	15-40	0.05	1.5	1.5 : 1 : 2	300-600	5	0.10	5	0.10	15	0.05	15/0.05A	1500

## 750314225 Flyback Transformer

- Dual output: +/-5V
- EP10 SMD

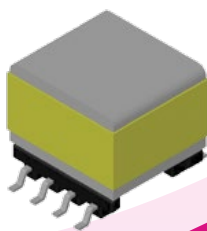

### Dual Output Dimensions & Footprint

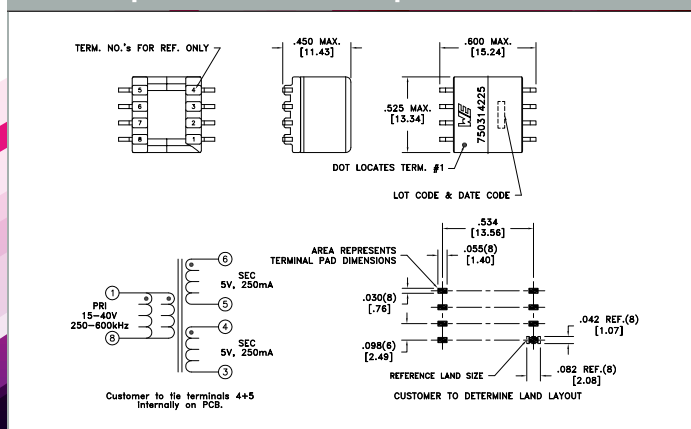

## 750314226 Flyback Transformer

- Dual output: +/-15V
- EP10 SMD

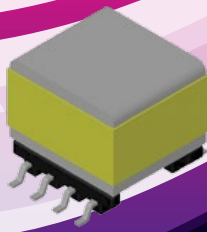

## Electrical Properties

Order Code	Package Size	U <sub>i</sub> (V <sub>AC</sub> )	L (mH)	I <sub>SAT</sub> (A)	N <sub>PRI</sub> :N <sub>SEC</sub> :N <sub>AUX</sub>	f <sub>switch</sub> (kHz)	U <sub>out1</sub> (V)	I <sub>O1</sub> (A)	U <sub>out2</sub> (V)	I <sub>O2</sub> (A)	U <sub>out3</sub> (V)	I <sub>O3</sub> (A)	U <sub>AUX</sub>	U <sub>T</sub> (kV <sub>AC</sub> )
750314225	EP10	15-40	0.05	1.3	1.5 : 1	250-600	5	0.25	5	0.25	-	-	-	1500
750314226	EP10	15-40	0.05	1.2	2 : 1	250-600	15	0.15	15	0.15	-	-	-	1500

## IMPORTANT NOTICE

Texas Instruments Incorporated and its subsidiaries (TI) reserve the right to make corrections, enhancements, improvements and other changes to its semiconductor products and services per JESD46, latest issue, and to discontinue any product or service per JESD48, latest issue. Buyers should obtain the latest relevant information before placing orders and should verify that such information is current and complete. All semiconductor products (also referred to herein as "components") are sold subject to TI's terms and conditions of sale supplied at the time of order acknowledgment.

TI warrants performance of its components to the specifications applicable at the time of sale, in accordance with the warranty in TI's terms and conditions of sale of semiconductor products. Testing and other quality control techniques are used to the extent TI deems necessary to support this warranty. Except where mandated by applicable law, testing of all parameters of each component is not necessarily performed.

TI assumes no liability for applications assistance or the design of Buyers' products. Buyers are responsible for their products and applications using TI components. To minimize the risks associated with Buyers' products and applications, Buyers should provide adequate design and operating safeguards.

TI does not warrant or represent that any license, either express or implied, is granted under any patent right, copyright, mask work right, or other intellectual property right relating to any combination, machine, or process in which TI components or services are used. Information published by TI regarding third-party products or services does not constitute a license to use such products or services or a warranty or endorsement thereof. Use of such information may require a license from a third party under the patents or other intellectual property of the third party, or a license from TI under the patents or other intellectual property of TI.

Reproduction of significant portions of TI information in TI data books or data sheets is permissible only if reproduction is without alteration and is accompanied by all associated warranties, conditions, limitations, and notices. TI is not responsible or liable for such altered documentation. Information of third parties may be subject to additional restrictions.

Resale of TI components or services with statements different from or beyond the parameters stated by TI for that component or service voids all express and any implied warranties for the associated TI component or service and is an unfair and deceptive business practice. TI is not responsible or liable for any such statements.

Buyer acknowledges and agrees that it is solely responsible for compliance with all legal, regulatory and safety-related requirements concerning its products, and any use of TI components in its applications, notwithstanding any applications-related information or support that may be provided by TI. Buyer represents and agrees that it has all the necessary expertise to create and implement safeguards which anticipate dangerous consequences of failures, monitor failures and their consequences, lessen the likelihood of failures that might cause harm and take appropriate remedial actions. Buyer will fully indemnify TI and its representatives against any damages arising out of the use of any TI components in safety-critical applications.

In some cases, TI components may be promoted specifically to facilitate safety-related applications. With such components, TI's goal is to help enable customers to design and create their own end-product solutions that meet applicable functional safety standards and requirements. Nonetheless, such components are subject to these terms.

No TI components are authorized for use in FDA Class III (or similar life-critical medical equipment) unless authorized officers of the parties have executed a special agreement specifically governing such use.

Only those TI components which TI has specifically designated as military grade or "enhanced plastic" are designed and intended for use in military/aerospace applications or environments. Buyer acknowledges and agrees that any military or aerospace use of TI components which have **not** been so designated is solely at the Buyer's risk, and that Buyer is solely responsible for compliance with all legal and regulatory requirements in connection with such use.

TI has specifically designated certain components as meeting ISO/TS16949 requirements, mainly for automotive use. In any case of use of non-designated products, TI will not be responsible for any failure to meet ISO/TS16949.

### Products

Audio	<a href="http://www.ti.com/audio">www.ti.com/audio</a>
Amplifiers	<a href="http://amplifier.ti.com">amplifier.ti.com</a>
Data Converters	<a href="http://dataconverter.ti.com">dataconverter.ti.com</a>
DLP® Products	<a href="http://www.dlp.com">www.dlp.com</a>
DSP	<a href="http://dsp.ti.com">dsp.ti.com</a>
Clocks and Timers	<a href="http://www.ti.com/clocks">www.ti.com/clocks</a>
Interface	<a href="http://interface.ti.com">interface.ti.com</a>
Logic	<a href="http://logic.ti.com">logic.ti.com</a>
Power Mgmt	<a href="http://power.ti.com">power.ti.com</a>
Microcontrollers	<a href="http://microcontroller.ti.com">microcontroller.ti.com</a>
RFID	<a href="http://www.ti-rfid.com">www.ti-rfid.com</a>
OMAP Applications Processors	<a href="http://www.ti.com/omap">www.ti.com/omap</a>
Wireless Connectivity	<a href="http://www.ti.com/wirelessconnectivity">www.ti.com/wirelessconnectivity</a>

### Applications

Automotive and Transportation	<a href="http://www.ti.com/automotive">www.ti.com/automotive</a>
Communications and Telecom	<a href="http://www.ti.com/communications">www.ti.com/communications</a>
Computers and Peripherals	<a href="http://www.ti.com/computers">www.ti.com/computers</a>
Consumer Electronics	<a href="http://www.ti.com/consumer-apps">www.ti.com/consumer-apps</a>
Energy and Lighting	<a href="http://www.ti.com/energy">www.ti.com/energy</a>
Industrial	<a href="http://www.ti.com/industrial">www.ti.com/industrial</a>
Medical	<a href="http://www.ti.com/medical">www.ti.com/medical</a>
Security	<a href="http://www.ti.com/security">www.ti.com/security</a>
Space, Avionics and Defense	<a href="http://www.ti.com/space-avionics-defense">www.ti.com/space-avionics-defense</a>
Video and Imaging	<a href="http://www.ti.com/video">www.ti.com/video</a>

### TI E2E Community

[e2e.ti.com](http://e2e.ti.com)