

bq28z610EVM 1- to 2-Series Li-Ion Battery Pack Manager Evaluation Module

This evaluation module (EVM) is a complete evaluation system for the bq28z610 or bq294502 battery management system. The EVM includes one bq28z610 and bq294502 circuit module and a link to Windows® based PC software. The circuit module includes one bq28z610 integrated circuit (IC), one bq294502 IC, and all other onboard components necessary to monitor and predict capacity, perform cell balancing, monitor critical parameters, protect the cells from overcharge, over-discharge, short-circuit, and over-current in 1- or 2-series cell Li-Ion or Li-Polymer battery packs. The circuit module connects directly across the cells in a battery. With the EV2300 or EV2400 interface board and software, the user can read the bq28z610 data registers, program the chipset for different pack configurations, log cycling data for further evaluation, and evaluate the overall functionality of the solution under different charge and discharge conditions using HDQ communication protocol.

Contents

1	Features.....	2
	1.1 Kit Contents.....	2
	1.2 Ordering Information	2
	1.3 Documentation	2
	1.4 bq28z610 and bq294502 Circuit Module Performance Specification Summary	2
2	bq28z610EVM Quick Start Guide	3
	2.1 Items Needed for EVM Setup and Evaluation	3
	2.2 Software Installation	3
	2.3 EVM Connections Module Connections	3
3	Battery Management Studio.....	6
	3.1 Starting the Program	6
	3.2 Registers Screen.....	7
	3.3 Data Memory Screen.....	8
	3.4 Calibration Screen	8
	3.5 Authentication Screen	11
	3.6 Chemistry Selection.....	11
	3.7 Firmware Screen	13
	3.8 Advanced Comm I ² C Screen	14
	3.9 Watch Screen.....	14
	3.10 Data Graph Screen	15
	3.11 Error Screen	15
4	Circuit Module Physical Layouts and Bill of Materials.....	16
	4.1 Board Layout.....	16
	4.2 Bill of Materials and Schematic.....	19
	4.3 Testing Fuse-Blowing Circuit	22

List of Figures

1	bq28z610 Circuit Module Connection to Cells and System Load or Charger	4
2	Cell Connection Configuration	4
3	Registers Screen.....	6
4	Battery Management Studio Supported Targets	7
5	Data Memory Screen.....	8
6	Calibration Screen	9

7	Authentication Screen	11
8	Chemistry Screen	12
9	Firmware Screen	13
10	Advanced Comm I ² C Screen	14
11	Watch Screen.....	15
12	Data Graph Screen	15
13	Error Screen	15
14	Top Silk Screen.....	16
15	Bottom Silk Screen.....	16
16	Top Assembly.....	17
17	Bottom Assembly.....	17
18	Top Layer.....	18
19	Bottom Layer.....	18
20	Schematic	21

1 Features

- Complete evaluation system for the bq28z610EVM 1- to 2-Series Battery Pack Manager Evaluation Module and bq294502 independent overvoltage protection IC
- Populated circuit module for quick setup
- Software that allows data logging for system analysis

1.1 Kit Contents

- bq28z610 and bq294502 circuit module
- Cable to connect the EVM to an EV2300 or EV2400 Communications Interface adapter

1.2 Ordering Information

For complete ordering information, see the product page at www.ti.com.

Table 1. Ordering Information

EVM PART NUMBER	CHEMISTRY	CONFIGURATION	CAPACITY
bq28z610EVM	Li-Ion	1-, 2-cell	Any

1.3 Documentation

For information on the bq28z610 and bq294502 device firmware and hardware, see the following documentation:

- *bq28z610 Impedance Track™ Gas Gauge for 1-Series to 2-Series Li-Ion/Li-Polymer Battery Packs* ([SLUSAS3](#))
- *bq28z610 Technical Reference Manual* ([SLUUA65](#))
- *bq2945xx Overvoltage Protection For 2-Series and 3-Series Cell Li-Ion Batteries* ([SLUSAJ3](#))
- *bq294502 EVM User's Guide* ([SLUU659](#))

1.4 bq28z610 and bq294502 Circuit Module Performance Specification Summary

This section summarizes the performance specifications of the bq28z610 and bq294502 EVM.

Table 2. Performance Specification Summary

SPECIFICATION	MINIMUM	TYPICAL	MAXIMUM	UNITS
Input voltage Pack+ to Pack-	3	7	25	V
Charge and discharge current	0	2	7	A

2 bq28z610EVM Quick Start Guide

This section provides the step-by-step procedures required to use a new EVM and configure it for operation in a laboratory environment.

2.1 Items Needed for EVM Setup and Evaluation

- bq28z610 and bq294502 circuit module
- EV2300 or EV2400 communications interface adapter
- Cable to connect the EVM to an EV2300 or EV2400 communications interface adapter
- USB cable to connect the communications interface adapter to the computer
- Computer setup with Windows® XP, or higher, operating system
- Access to the Internet to download the Battery Management Studio software setup program
- One or two battery cells or 1-kΩ resistors to configure a cell simulator
- A DC power supply that can supply 8.4 V and 2 A (constant current and constant voltage capability is desirable)

2.2 Software Installation

Find the latest software version in the bq28z610 tool folder on www.ti.com. Use the following steps to install the bq28z610 Battery Management Studio software:

1. Download and run the Battery Management Studio setup program from the Development Tools section of the bq28z610EVM product folder on www.ti.com. See [Section 3](#) for detailed information on using the tools in the Battery Management Studio.
2. If the Communications Interface Adapter was not previously installed, after the bqStudio installation, a TI USB DRIVER INSTALLER pops up. Click **Yes** for the agreement message and follow its instructions. Two drivers are associated with the EV2300 and an additional file may be required for the EV2400. Follow the instructions to install both. Do not reboot the computer, even if asked to do so.
3. Plug the communications interface adapter into a USB port using the USB cable. The Windows® system may show a prompt that new hardware has been found. When asked, "Can Windows connect to Windows Update to search for software?", select "No, not this time", and click **Next**. In the next dialog window, it indicates "This wizard helps you install software for: TI USB Firmware Updater". Select "Install the software automatically (Recommended)" and click **Next**. It is common for the next screen to be the Confirm File Replace screen. Click **No** to continue. If this screen does not appear, then go to the next step. After Windows® indicates that the installation was finished, a similar dialog window pops up to install the second driver. Proceed with the same installation preference as the first one. The second driver is TI USB bq80xx Driver.

2.3 EVM Connections Module Connections

This section covers the hardware connections for the EVM. See [Figure 1](#).

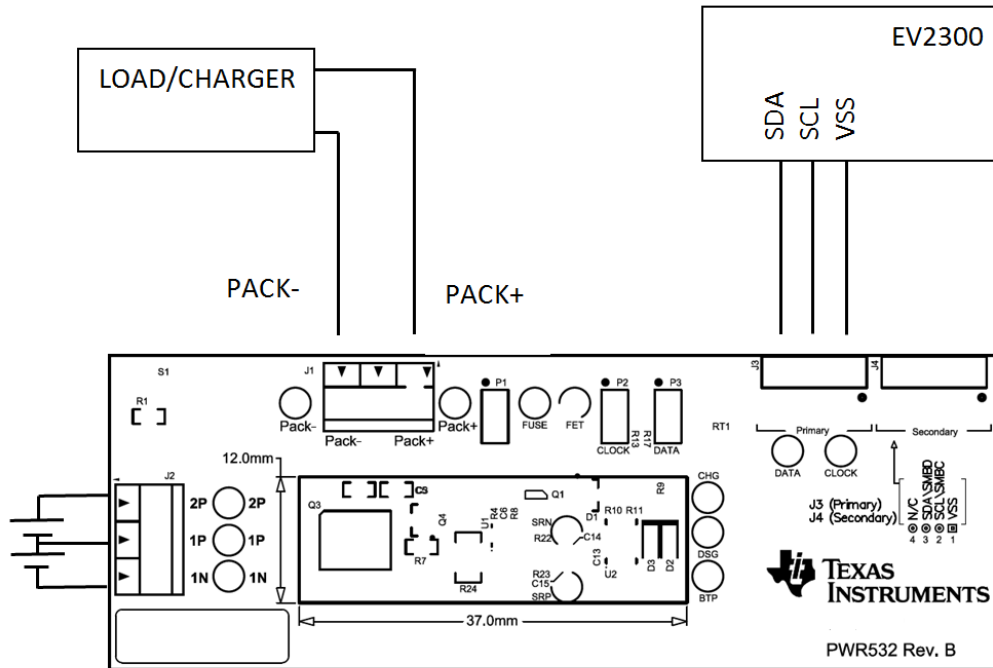

Figure 1. bq28z610 Circuit Module Connection to Cells and System Load or Charger

- Direct connection to the cells: 1N (BAT-), 1P, 2P (BAT+)
 Attach the cells to the J2 terminal block. A specific cell connection sequence is not required, although it is a good practice to start with lowest cell in the stack (cell1) and then add cell 2. The U1 and U2 devices should not get damaged by other cell connection sequences, but there is a possibility that the bq294502 could blow the fuse in a module that has one. Attaching cells starting with cell 1 should eliminate this risk.

Number of Cells	J2 Terminal Block Connections				
	1N		1P		2P
1	⊖	-cell1+	⊖	short	⊖
2	⊖	-cell1+	⊖	-cell2+	⊖

Figure 2. Cell Connection Configuration

A resistor cell simulator can be used instead of battery cells. Connect a resistor between each of the contacts on the J2 connector; that is, from 1N to 1P and from 1P to 2P. If being used for a 1-series configuration no resistor is needed, simply short 1P and 2P. A power supply can provide power to the cell simulator. Set the power supply to the desired cell voltage x the number of cells and attach the ground wire to 1N and the positive wire to 2P. For example, for a 2-series configuration with a 3.6-V cell voltage, set the power supply to $2 \times 3.6 = 7.2$ V.

- I²C™ (SDA, SCL)

Attach the communications interface adapter cable to J3 and to the I²C™ port on the EV2300.

NOTE: If the EV2300 is used, ensure that shunts are placed on P2 and P3 jumpers to enable the onboard pull-up resistors. The EV2400 has internal pull-up resistors if it is used.

- System load and charger connections across PACK+ and PACK–

Attach the load or power supply to the J1 terminal block. The positive terminal of the load or power supply wire should be connected to the terminal block position labeled PACK+. The ground wire for the load or power supply should be connected to the other terminal block position labeled PACK–.

- Wake-up the device up from SHUTDOWN (WAKE)

Press the **Wake** pushbutton switch S1 to temporarily connect BAT+ to PACK+. This applies voltage to the PACK pin on the bq28z610 to power-up the regulators and start the initialization sequence.

- Parameter setup

The default data flash default settings is configured for 2-series Li-Ion cells. The user should change the | Data Memory | Settings | DA Configuration register to set up the number of series cells to match the physical pack configuration by clearing the CCO flag for 1-series configuration or setting it for 2-series configuration. This provides basic functionality to the setup. Other data flash parameters should also be updated to fine tune the gauge to the pack. See the *bq28z610 Technical Reference Manual (SLUUA65)* for help with setting the parameters.

3 Battery Management Studio

3.1 Starting the Program

Run Battery Management Studio from the Start | Programs | Texas Instruments | Battery Management Studio sequence or the Battery Management Studio shortcut. As long as the device has been woken up from shutdown mode by momentarily pressing button **S1** or applying a charger voltage, the gauge will be automatically detected and the register screen will appear as seen in **Figure 3**. If your device contains an earlier firmware version, then auto detection of the device may not occur. If that happens, on the window that pops up as shown in **Figure 4**, select any bq28z610 .bqz file. This action will enable the program to get started and the user can update the firmware using the latest .srec file for the device downloadable from the product folder of the gauge at www.ti.com.

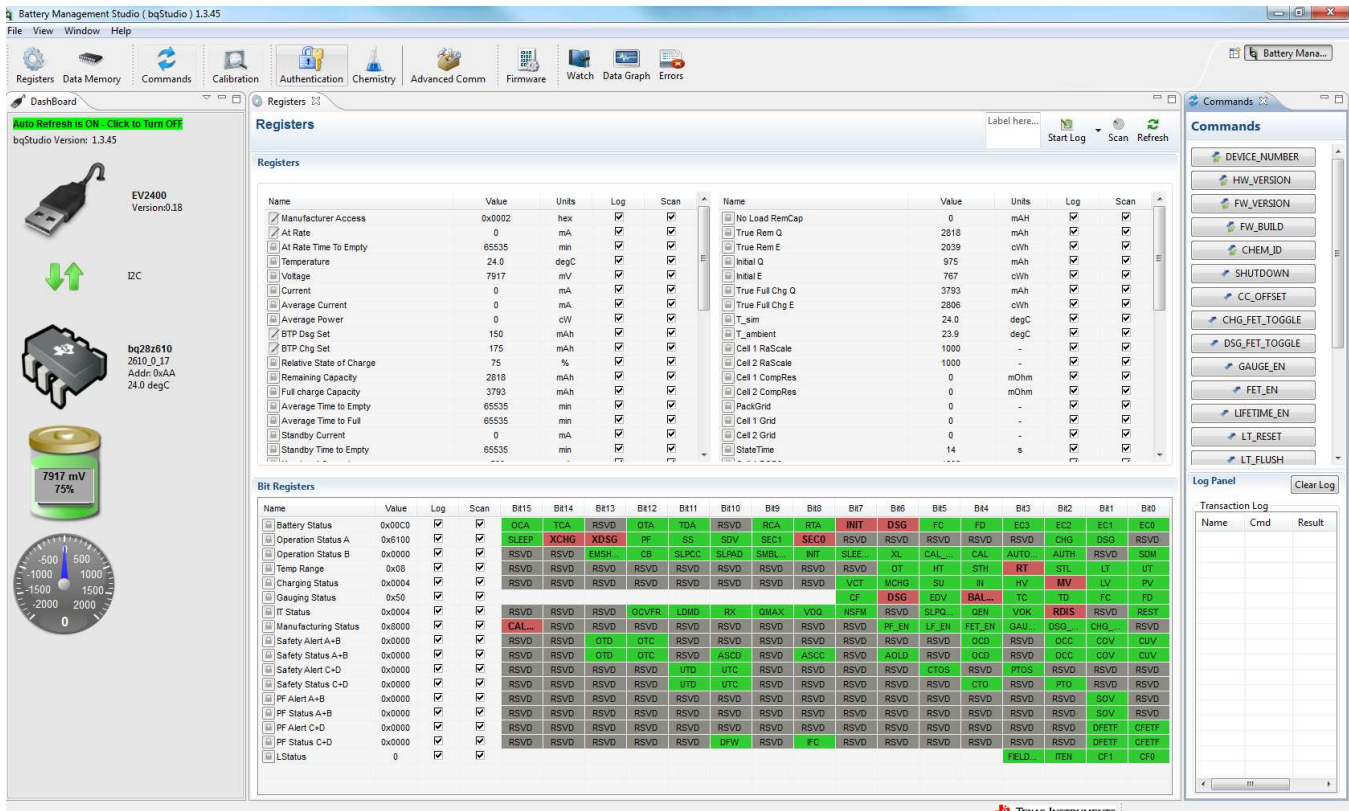

Figure 3. Registers Screen

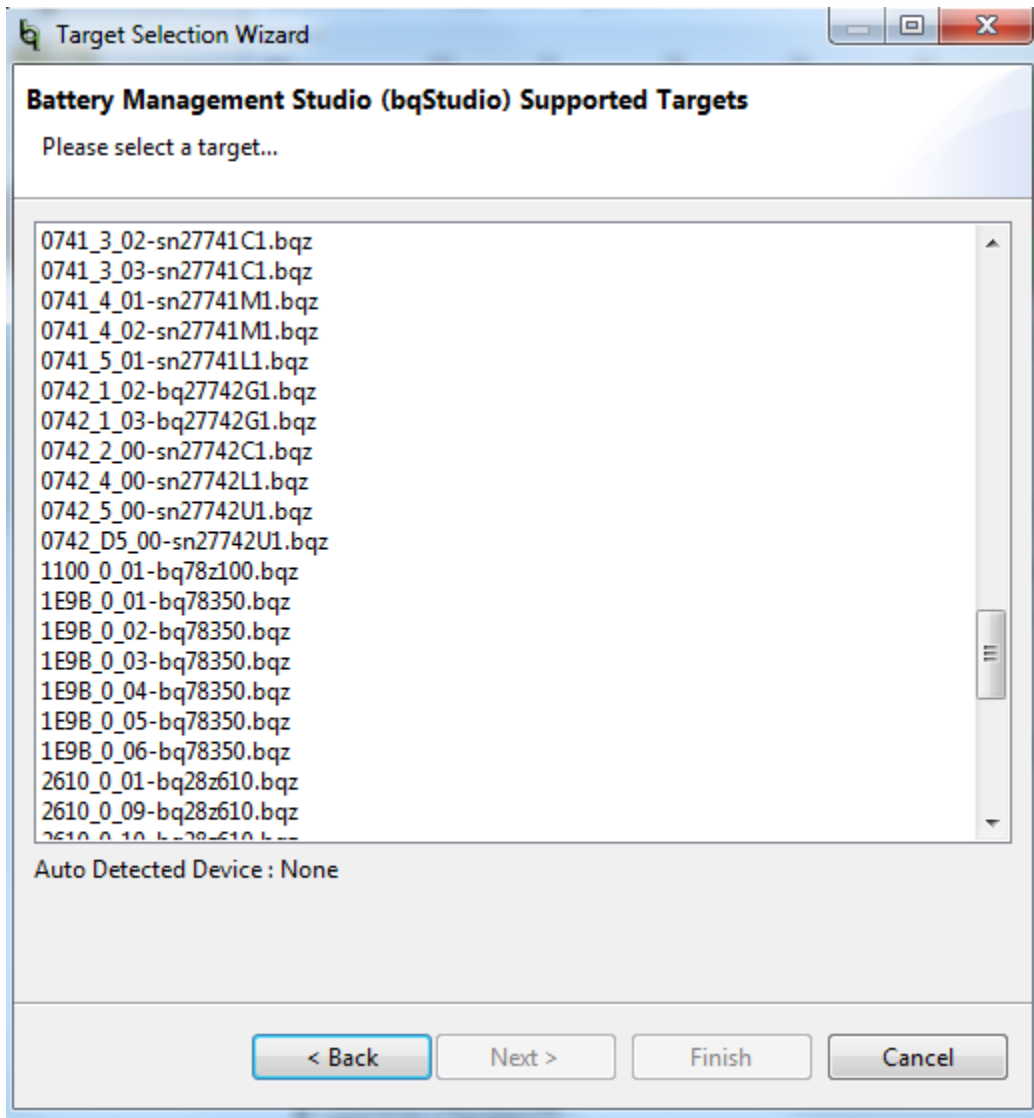

Figure 4. Battery Management Studio Supported Targets

3.2 Registers Screen

The Registers section contains parameters used to monitor gauging. The Bit Registers section provides bit level picture of status and fault registers. A green flag indicates that the bit is 0 (low state) and a red flag indicates that the bit is 1 (high state). A greyed out bit indicated that bit is reserved. Data begins to appear once the **Refresh** (single-time scan) button is selected, or it scans continuously if the **Scan** button is selected. The continuous scanning period can be set via the | Windows | preferences | register selections.

The battery management Studio program provides a logging function which logs all the values of the parameters in the Register section if running the program in "Show basic view mode". In order to selectively choose the parameters of Register section that are scanned and logged, the user needs to set Battery Management Studio to "Show Advanced view mode". This mode can be set via | Windows | preferences | All Global Settings | Show Advanced Views. Uncheck the fields that are not needed to be scanned or logged. To enable logging, select the **Log** button; this causes the **Scan** button to be selected. When logging is stopped, the **Scan** button is still selected and has to be manually deselected.

3.3 Data Memory Screen

The bq28z610 data flash comes configured per the default settings detailed in the bq28z610 TRM. Ensure that the settings are correctly changed to match the pack and application for the solution being evaluated. For ease of configuration, a text file with a gg.csv extension can be extracted, modified and imported back on the device. Use the export and import buttons as seen in [Figure 5](#) to export and import gg.csv files. The auto export button enables gg files to be exported periodically at intervals. This is useful when debugging issues with the gauge. A write all command is necessary if a gg.csv file is imported to ensure that all the changes made on the gg.csv file are effected on the gauge. The read all command is used to read back all of the data written to the gauge so that the changes made can be verified. The filter/search field enables the user to search for a particular parameter in the data memory content.

NOTE: Do not make modifications to the gg.csv file using Microsoft Excel® as it makes changes to file, which bqStudio rejects. Make sure to use a text editor like notepad or similar to edit a gg.csv file.

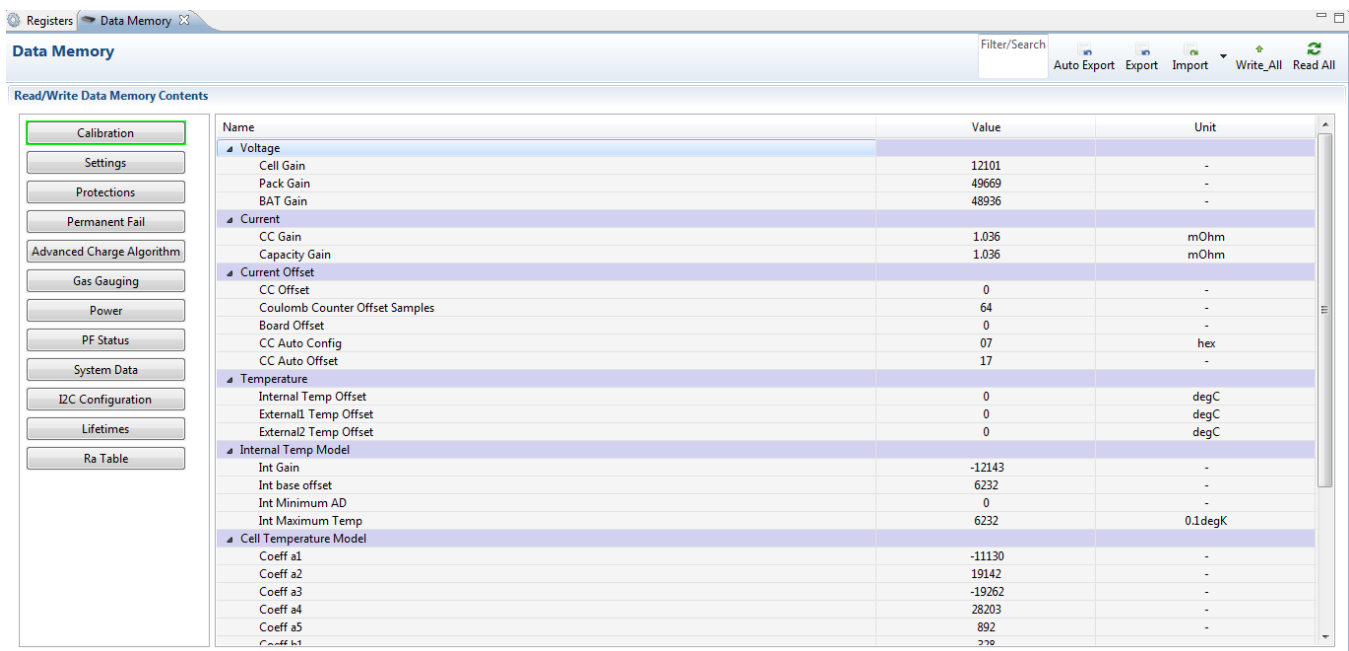

Figure 5. Data Memory Screen

3.4 Calibration Screen

The voltages, temperatures, and currents should be calibrated to provide good gauging performance. Press the **Calibration** button while in the “Show Advanced view mode” to select the **Advanced Calibration** window. See [Figure 6](#). If in the “Show basic view mode”, the basic calibration window shows when the **Calibration** button is clicked. The **Advanced Calibration** window enables the internal temperature sensor as well as the external thermistor to be calibrated.

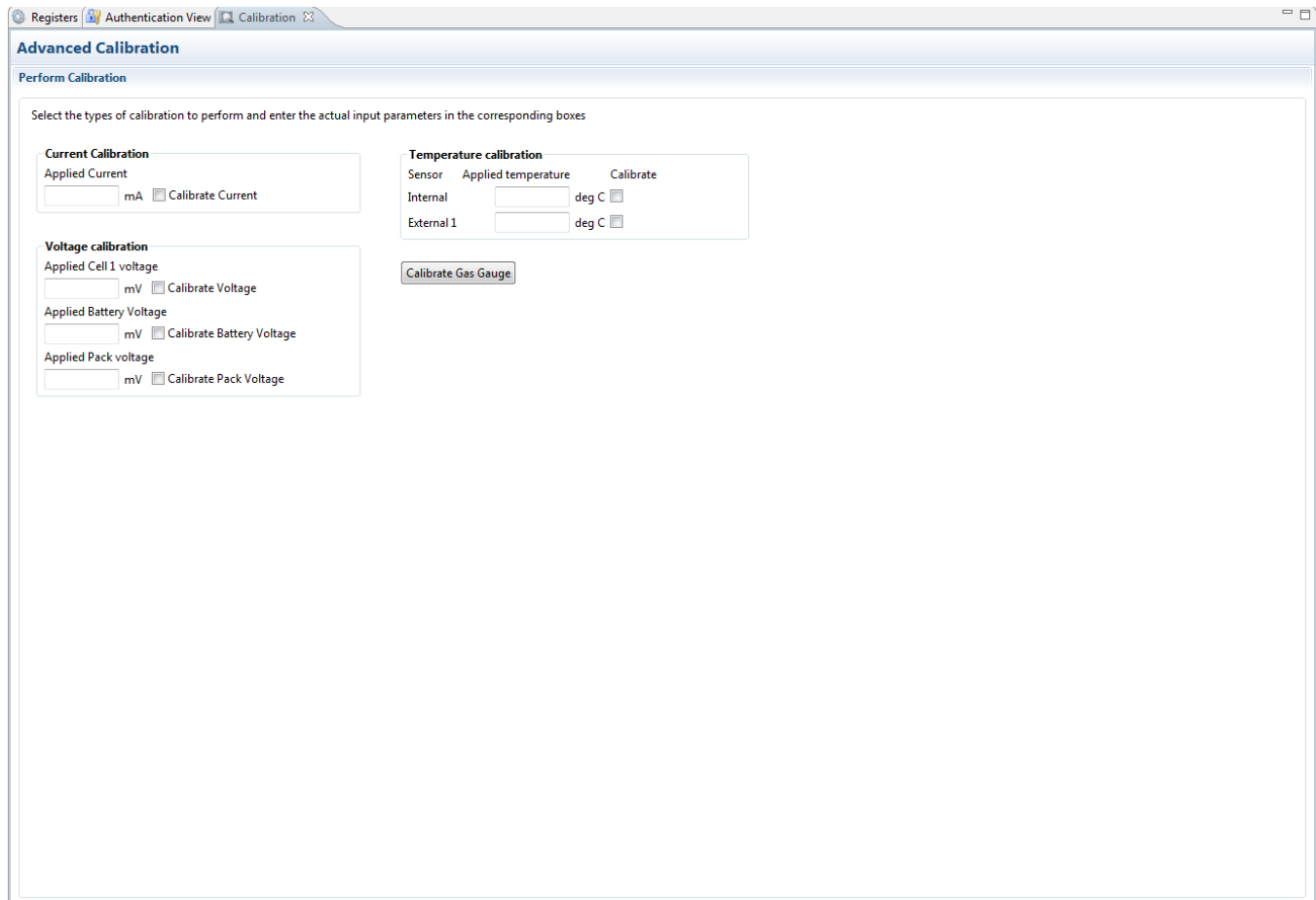

Figure 6. Calibration Screen

3.4.1 Voltage Calibration

- Measure the voltage from Cell 1 to 1N and enter this value in the *Applied Cell 1 Voltage* field and select the **Calibrate Voltage** box.
- Measure the voltage from Bat+ (2P) to Bat– (2N) and enter this value in the *Applied Battery Voltage* field and select the **Calibrate Battery Voltage** box.
- Measure the voltage from Pack+ to Pack– and enter this value in the *Applied Pack Voltage* field and select the **Calibrate Pack Voltage** box. If the voltage is not present, then turn the charge and discharge FETs on by entering a 0x22 command in the Manufacturer Access register on the **Register** screen.
- Press the **Calibrate Gas Gauge** button to calibrate the voltage measurement system.
- Deselect the **Calibrate Voltage** boxes after voltage calibration has completed.

3.4.2 Temperature Calibration

- Enter the room temperature in each of the *Applied Temperature* fields and select the **Calibrate** box for each thermistor to be calibrated. The temperature values must be entered in degrees Celsius.
- Press the **Calibrate Gas Gauge** button to calibrate the temperature measurement system.
- Deselect the **Calibrate** boxes after temperature calibration has completed.

3.4.3 Current Calibration

The Board Offset calibration option is not offered in Battery Management Studio, because it is not required when using the bq28z610EVM. The Board Offset calibration option is available in bqProduction.

- Connect and measure a 2-A current source from 1N (-) and Pack- to calibrate without using the FETs. (TI does not recommend calibration using the FETs.)
- Enter -2000 in the *Applied Current* field and select the **Calibrate Current** box.
- Press the **Calibrate Gas Gauge** button to calibrate.
- Deselect the **Calibrate Current** box after current calibration has completed.

3.5 Authentication Screen

The bq28z610 supports SHA-1 HMAC authentication with the host system. The authentication screen of bqStudio allows for the SHA-1 calculator to be tested, perform gauge authentication by the host and change the gauge authentication key.

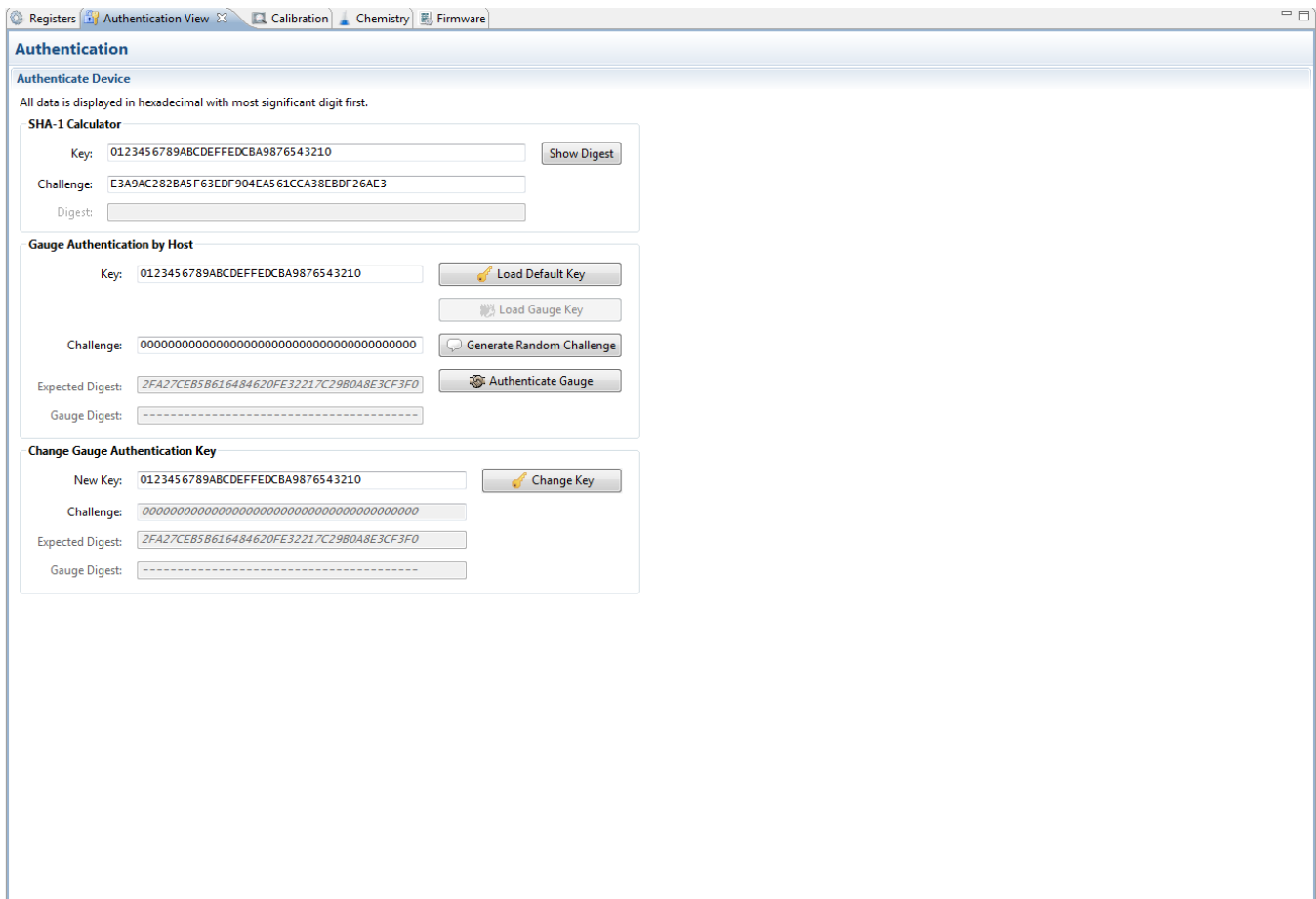

Figure 7. Authentication Screen

3.6 Chemistry Selection

The chemistry file contains parameters that the simulations use to model the cell and its operating profile. It is critical to program a Chemistry ID that matches the cell into the device. Some of these parameters can be viewed in the Data Flash section of the Battery Management Studio.

Press the **Chemistry** button to select the **Chemistry** window.

- The table can be sorted by clicking the desired column. For example: Click the *Chemistry ID* column header.
- Select the ChemID that matches your cell from the table (see [Figure 8](#)).
- Press **Update Chemistry from Database** to update the chemistry in the device.

Registers Chemistry

Chemistry Programming

Program Battery Chemistry

Most Li-ion cells use LiCoO2 cathode and graphitized carbon anode, which is supported by the default firmware in the Impedance track fuel gauges. This tool allows the fuel gauge to be set up for various alternate battery chemistries. Use this tool to load settings for any alternate chemistry if your cell manufacturer indicates that their cells use a different chemistry than LiCoO2 cathode and graphite anode.

Note : Right Click on the selected chemistry to apply it to individual cells. The menu appears only if the fw supports individual cell chemistries.

Manufacturer	Model	Chemistry ID	Description
360FLY	PR-693231 (815mAh)	1318	LiCoO2/carbon 11
A&TB	LGR18650OU	0100	LiCoO2/graphitized carbon (default)
A01	ALP8A002 (3430mAh)	0207	NiCoMn/carbon 2
A123	APR18650M1 (1100 mAh)	0404	LiFePO4/carbon
A123	26650MLB (2500mAh)	0434	LiFePO4/carbon
A123	ANR26650M1-B (2500mAh)	0440	LiFePO4/carbon
A123	ANR26650M1-B Consult TI before use (2500...	0453	LiFePO4/carbon
A123 Systems	26650A	0400	LiFePO4/carbon
A123Systems	A123 (20000mAh)	6105	NIMH
AA Portable Power	LFP-18650-1500 (1500 mAh)	0439	LiFePO4/carbon
AAPortable	26650 (3300mAh)	0451	LiFePO4/carbon
AAPortable	8790160 (10000mAh)	0456	LiFePO4/carbon
Acebel	ECFV1260 (60Ah)	0807	Lead Acid
AEnergy	AE1004765 (3500mAh)	0131	LiCoO2/carbon 4
AEnergy	AE583696PM1HR (2150 mAh)	0222	PSS, LiNiO2 with Co, Mn doping
AET	TP2000-1SPL (2000mAh)	0190	LiCoO2/carbon 11
AGM	INR34600K2 (7500mAh)	0210	NiCoMn/carbon
AISIPU	3872C8 (5100mAh)	1335	LiCoO2/carbon 11
AISIPU	856360 (4750mAh)	3636	LiMn2O4 (Co,Ni)/carbon, 4.35V
ALE	045062 (2300 mAh)	1254	LiNiCoMnO2/SGenNo1, 4.2V
ALE	ALE073470 (1700mAh)	2047	NiCoMn/carbon
Alees	26700FE (3300mAh)	0411	LiFePO4/carbon
Alees	A2770102 (13000mAh)	0412	LiFePO4/carbon
Amita	LPC 776285M	0204	NiCoMn/carbon
Amita	LPC5099130L (5120 mAh)	0304	NiCoMn/carbon, 4.2V
Amita	LPC776825I (2700 mAh)	0304	NiCoMn/carbon, 4.2V
Amprius	45057 (2300mAh)	2045	NiCoMn/carbon
ATL	604396	0100	LiCoO2/graphitized carbon (default)
ATL	laminare 554490	0103	LiCoO2/carbon 2
ATL	604396 (M1-V4 / Obsolete)	0105	LiCoO2/carbon 3
ATL	laminare 606168 (M42-V2)	0105	LiCoO2/carbon 3

Update Chemistry from Database Update Chemistry from External File...

Chemistry Version : 461

Figure 8. Chemistry Screen

3.7 Firmware Screen

Press the **Firmware** button to select the **Firmware Update** window. This window allows the user to export and import the device firmware.

3.7.1 Programming the Flash Memory

The upper section of the Firmware screen is used to initialize the device by loading the default .srec into the flash memory (see [Figure 9](#)).

- Search for the .srec file using the **Browse** button.
- Select the **Execute after programming** box to automatically return the device to NORMAL mode after programming has completed.
- Press the **Program** button and wait for the download to complete.

3.7.2 Exporting the Flash Memory

The lower section of the Firmware screen is used to export all of the flash memory from the device (see [Figure 9](#)).

- Press the **Browse** button and enter an .srec filename.
- Press the **Read Srec** to save the flash memory contents to the file. Wait for the download to complete.

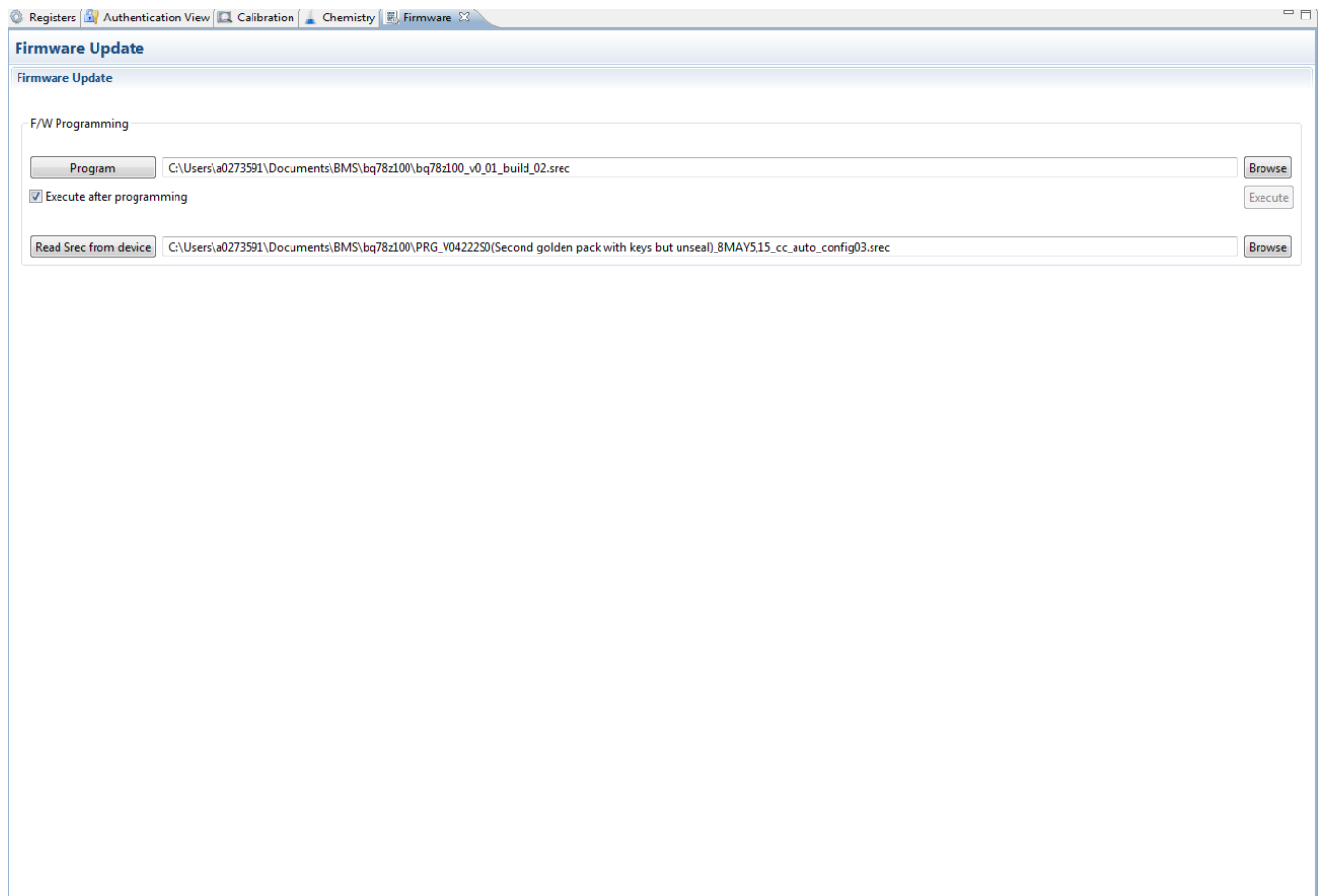

Figure 9. Firmware Screen

3.8 Advanced Comm I²C Screen

Press the **Advanced Comm I²C** button to select the **Advanced Comm I²C** window. This tool provides access to parameters using I²C and Manufacturing Access commands. See [Figure 10](#). The transaction log screen shows the history of sent commands.

NOTE: I²C commands are sent in Little Endian format.

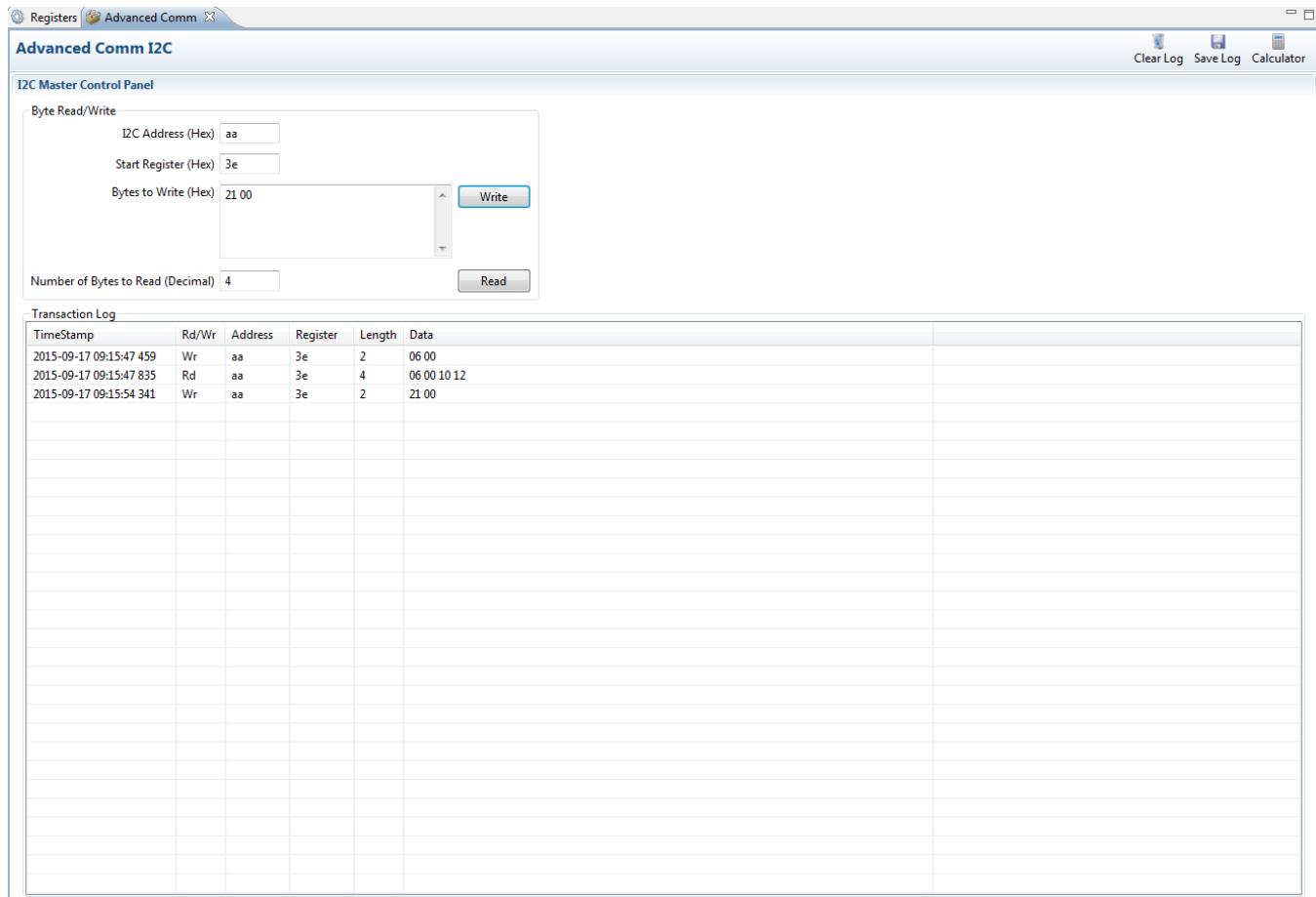

Figure 10. Advanced Comm I²C Screen

Examples:

Reading an I²C Command.

- Read chemical ID (0x 0006).
 - Write to mac address 3e Command 06 00 (see [Figure 10](#)).
 - Read 4 bytes.
 - The result returned is 10 12, which is little endian for chem id 1210.

Sending a MAC *Gauging()* to enable IT via *ManufacturerAccess()*.

- With Impedance Track™ disabled, send *Gauging()* (0x0021) to *ManufacturerAccess()*.
 - Write to mac address 3e command 21 00 (see [Figure 10](#)).

3.9 Watch Screen

This enables monitoring of specific registers and data memory items at user specified time intervals. By clicking the add register or add data memory item, these will be added to the table of values to be tracked.

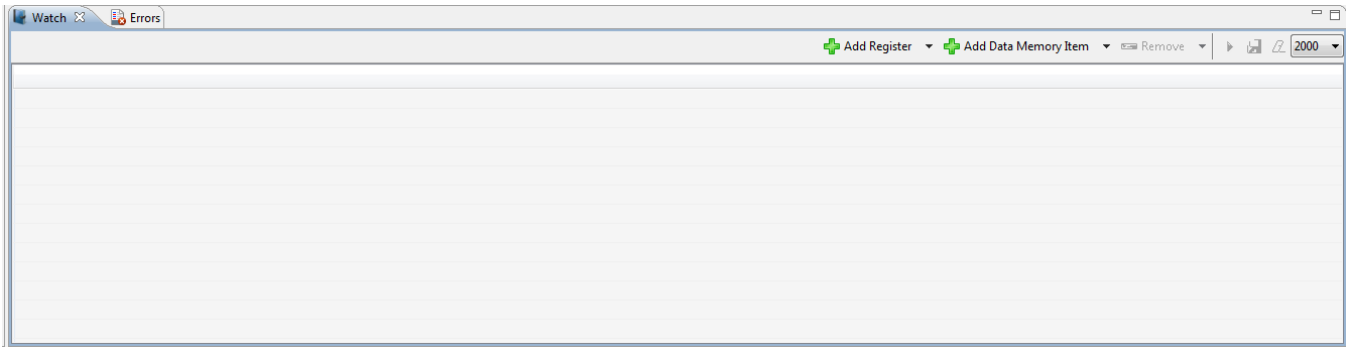

Figure 11. Watch Screen

3.10 Data Graph Screen

This enables specified registers and data memory items to be plotted in a graph real time based on a specific time interval chosen as shown in [Figure 12](#).

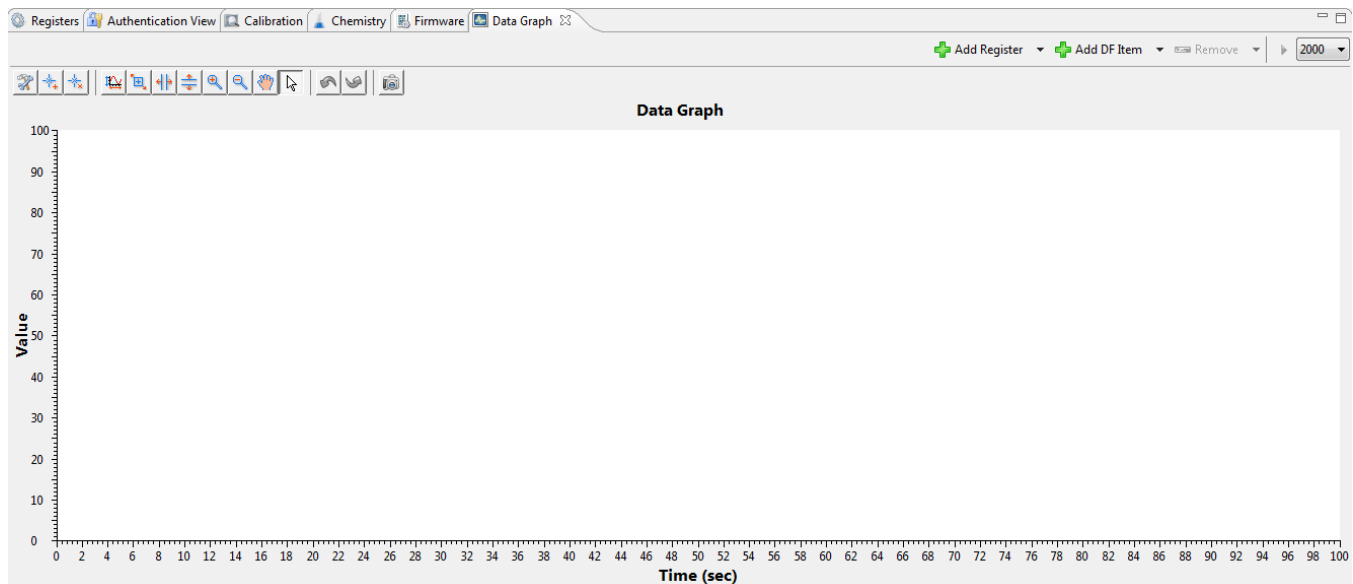

Figure 12. Data Graph Screen

3.11 Error Screen

This keeps track of any error that may occur with bqStudio during usage.

Message	View	Operation	TimeStamp

Figure 13. Error Screen

4 Circuit Module Physical Layouts and Bill of Materials

This section contains the printed-circuit board (PCB) layout, bill of materials, and assembly drawings for the bq28z610/bq294502 circuit modules.

4.1 Board Layout

This section shows the dimensions, PCB layers (see Figure 14 through Figure 19), and assembly drawing for the bq28z610 modules.

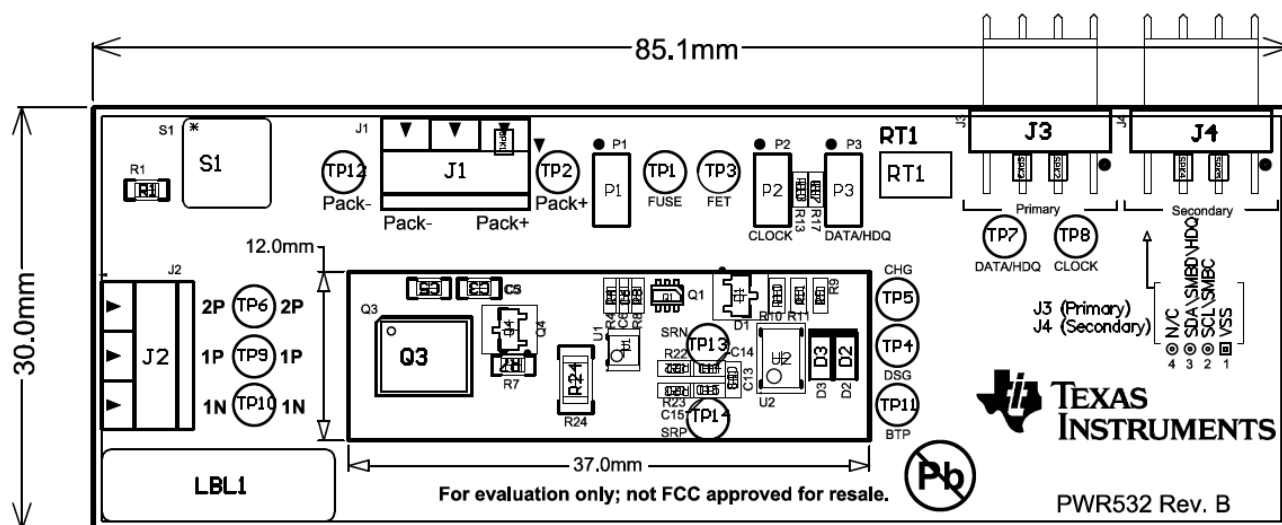

Figure 14. Top Silk Screen

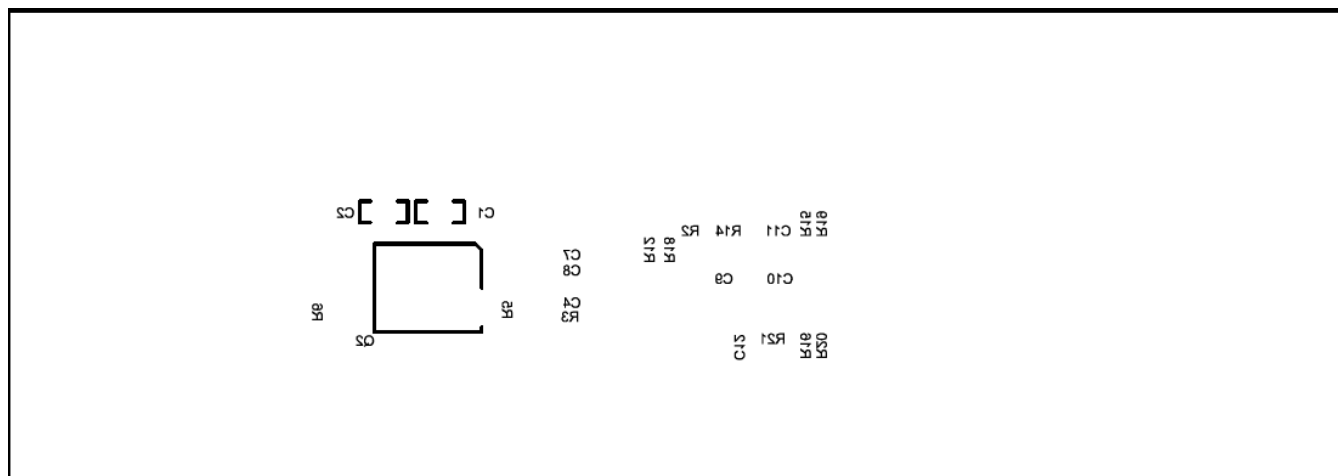

Figure 15. Bottom Silk Screen

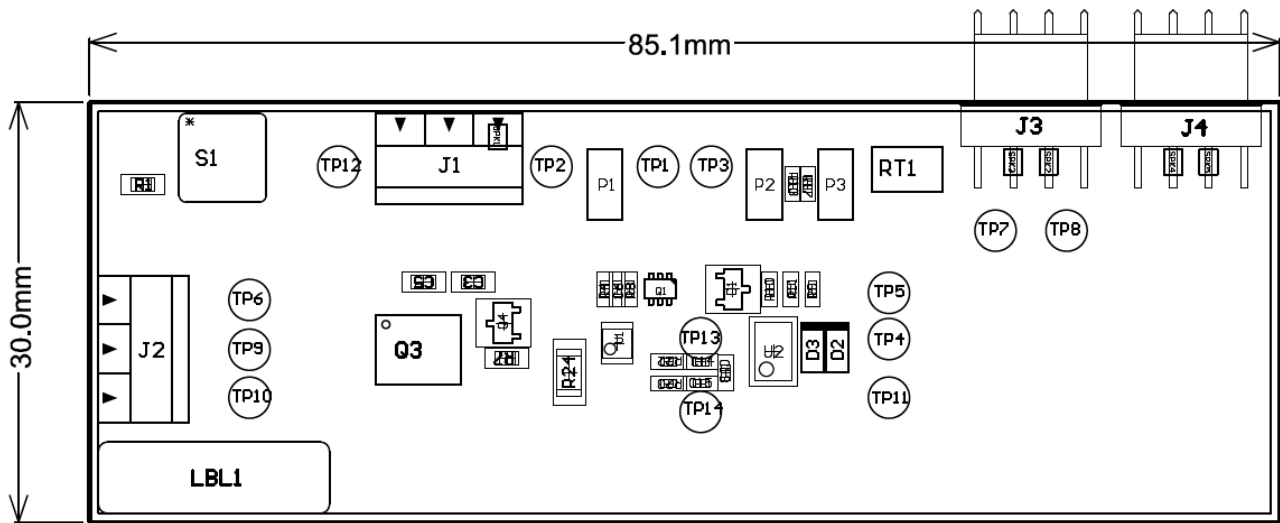

Figure 16. Top Assembly

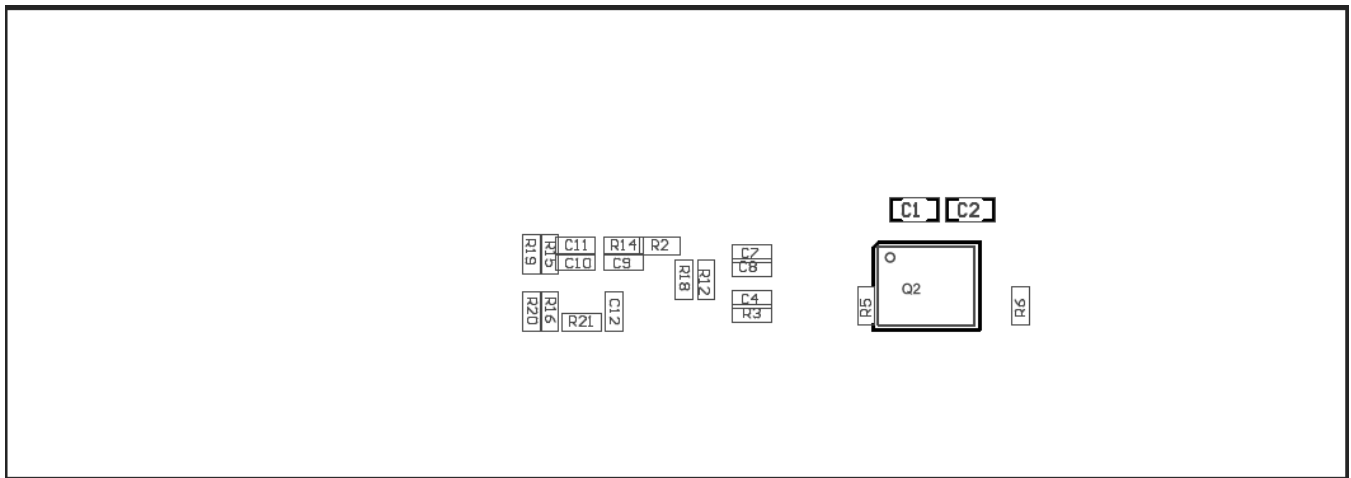

Figure 17. Bottom Assembly

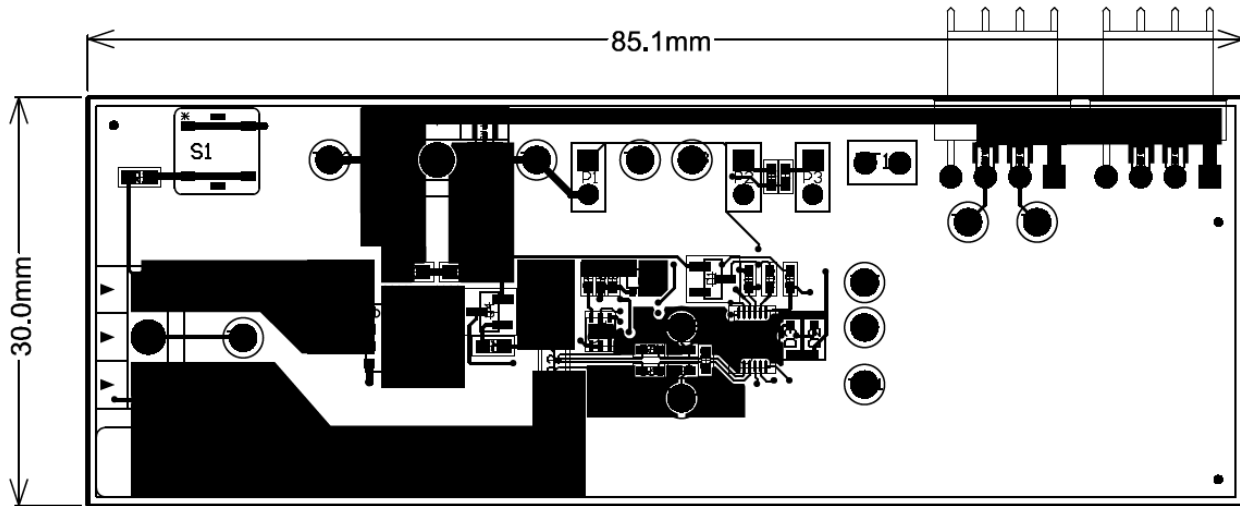

Figure 18. Top Layer

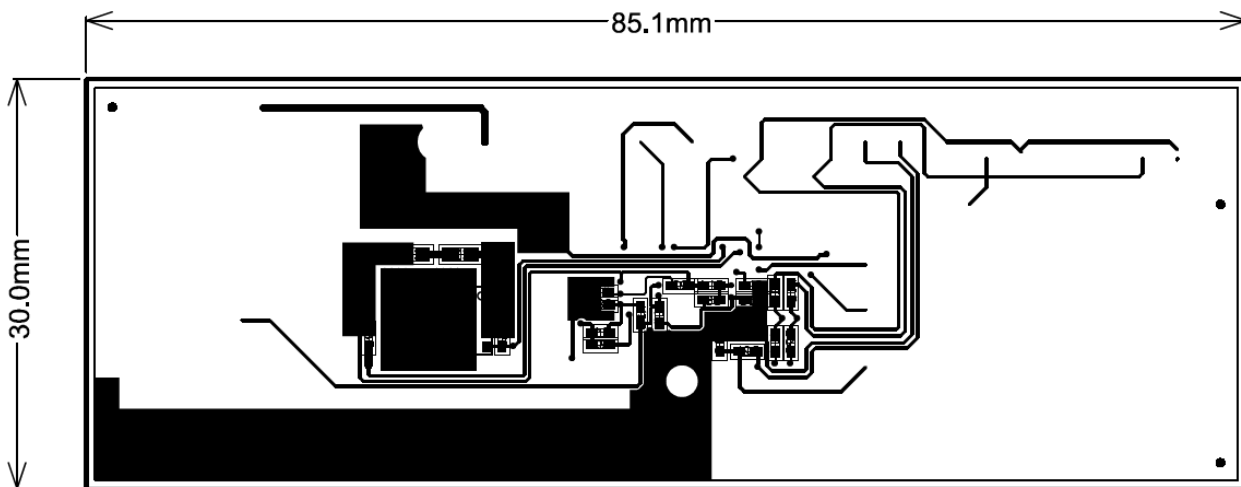

Figure 19. Bottom Layer

4.2 Bill of Materials and Schematic

Table 3. Bill of Materials

Designator	Quantity	Value	Description	Package Reference	PartNumber	Manufacturer
C1, C2, C3, C5	4	0.1 μ F	Capacitor, Ceramic, 50 V, X7R, 10%	0603	CL10B104KB8SFNC	Samsung Electromechanics
C4, C6, C7, C8, C10, C13	6	0.1 μ F	Capacitor, Ceramic Chip, 16 V, X7R, 10%	0402	CL05B104KO5NNNC	Samsung Electromechanics
C9	1	1 μ F	Capacitor, Ceramic Chip, 16 V, X5R, 10%	0402	CL05A105KO5NNNC	Samsung Electromechanics
C11	1	2.2 μ F	Capacitor, Ceramic Chip, 16 V, X5R, 20%	0402	C1005X5R1C225M050 BC	TDK Corporation
D1	1	BAS16-7-F	Diode, Ultrafast, 75V, 0.3A, SOT-23	SOT-23	BAS16-7-F	Diodes Inc.
D2, D3	2	MM3Z5V6C	Diode, Zener, 5.6V, 200 mW	SOD323	MM3Z5V6C	Fairchild
J1, J2	2	ED555/3DS	Terminal Block, 3-pin, 6-A, 3.5 mm	0.41 x 0.25 inch	ED555/3DS	OST
J3	1		Header (friction lock), 100 mil, 4x1, R/A, TH	4x1 R/A Header	22-05-3041	Molex
P1, P2, P3	3	PEC02SAAN	Header, male 2-Pin, 100-mil spacing	0.100 x 2	PEC02SAAN	Sullins
Q1	1	SI1414DH-T1-GE3	MOSFET, Nch, 30 V, 4 A, 46 m Ω	SC-70	SI1414DH-T1-GE3	Vishay
Q2, Q3	2	25 V	MOSFET, N-CH, 25 V, 52 A, SON 5x6 mm	SON 5x6mm	CSD16412Q5A	Texas Instruments
Q4	1	2N7002K-T1-E3	MOSFET, Nch, 60 V, 300 mA, 2 Ω	SOT23	2N7002K-T1-E3	Vishay
R1	1	1K	Resistor, Chip, 1/10-W, 5%	0603	RC1608J102CS	Samsung Electromechanics
R2, R15, R16, R18, R19, R20, R22, R23	8	100	Resistor, Chip, 1/16W, 5%	0402	RC1005J101CS	Samsung Electromechanics
R3, R4, R12	3	1k	Resistor, Chip, 1/16W, 5%	0402	RC1005J102CS	Samsung Electromechanics
R5, R6	2	10M	Resistor, Chip, 1/16W, 5%	0402	RC1005J106CS	Samsung Electromechanics
R7	1	10K	Resistor, Chip, 1/10-W, 5%	0603	RC1608J103CS	Samsung Electromechanics
R8	1	100k	Resistor, Chip, 1/16W, 5%	0402	RC1005J104CS	Samsung Electromechanics
R9, R10, R13, R17	4	5.1k	Resistor, Chip, 1/16W, 5%	0402	RC1005J512CS	Samsung Electromechanics
R11	1	10	Resistor, Chip, 1/16W, 5%	0402	RC1005J100CS	Samsung Electromechanics
R14	1	4.99	Resistor, Chip, 1/16W, 5%	0402	CRCW04024R99FKED	Vishay Dale
R24	1	0.001 50 ppm	Resistor, Metal Foil, 1 watt, \pm 1%	1206	CSNL1206FT1L00	Vishay
RT1	1	10 K	Thermistor, NTC, 3 A	0.095 X 0.150 inch	103AT-2	Semitec
S1	1	EVQ-PLHA15	Switch, Push button, Momentary, 1P1T, 50 mA, 12 V	0.200 x 0.200 inch	EVQ-PLHA15	Panasonic
SPK1, SPK2, SPK3, SPK4, SPK5	5		Gap, 0.010" space	0.020 x 0.020 inch		
TP1, TP3, TP4, TP5, TP7, TP8, TP10, TP12, TP13, TP14	10	Black	Test Point, TH, Miniature, Black	0.100 x 0.100 inch	5001	Keystone
TP2, TP6, TP9	3	Red	Test Point, TH, Miniature, Red	0.100 x 0.100 inch	5000	Keystone

Table 3. Bill of Materials (continued)

Designator	Quantity	Value	Description	Package Reference	PartNumber	Manufacturer
U1	1	BQ294502DRVR	Overvoltage Protection Device for 2 to 3 Cell Li-Ion Batteries, with 4.35 V OVP, -40 to 85 °C, 6-pin SON (DRV), Green (RoHS & no Sb/Br)	DRV0006A	BQ294502DRVR	Texas Instruments
U2	1	bq28z610DRZ	1-Cell to 2-Series Cell Programmable Battery Manager, DRZ0012A	DRZ0012A	bq28z610DRZ	Texas Instruments
C12	0	1 µF	Capacitor, Ceramic Chip, 16 V, X5R, 10%	0402	CL05A105KO5NNNC	Samsung Electromechanics
C14, C15	0	0.1 µF	Capacitor, Ceramic Chip, 16 V, X7R, 10%	0402	CL05B104KO5NNNC	Samsung Electromechanics
J4	0		Header (friction lock), 100mil, 4x1, R/A, TH	4x1 R/A Header	22-05-3041	Molex
R21	0	330k	Resistor, Chip, 1/16W, 5%	0402	RC1005J334CS	Samsung Electromechanics
TP11	0	Black	Test Point, TH, Miniature, Black	0.100 x 0.100 inch	5001	Keystone

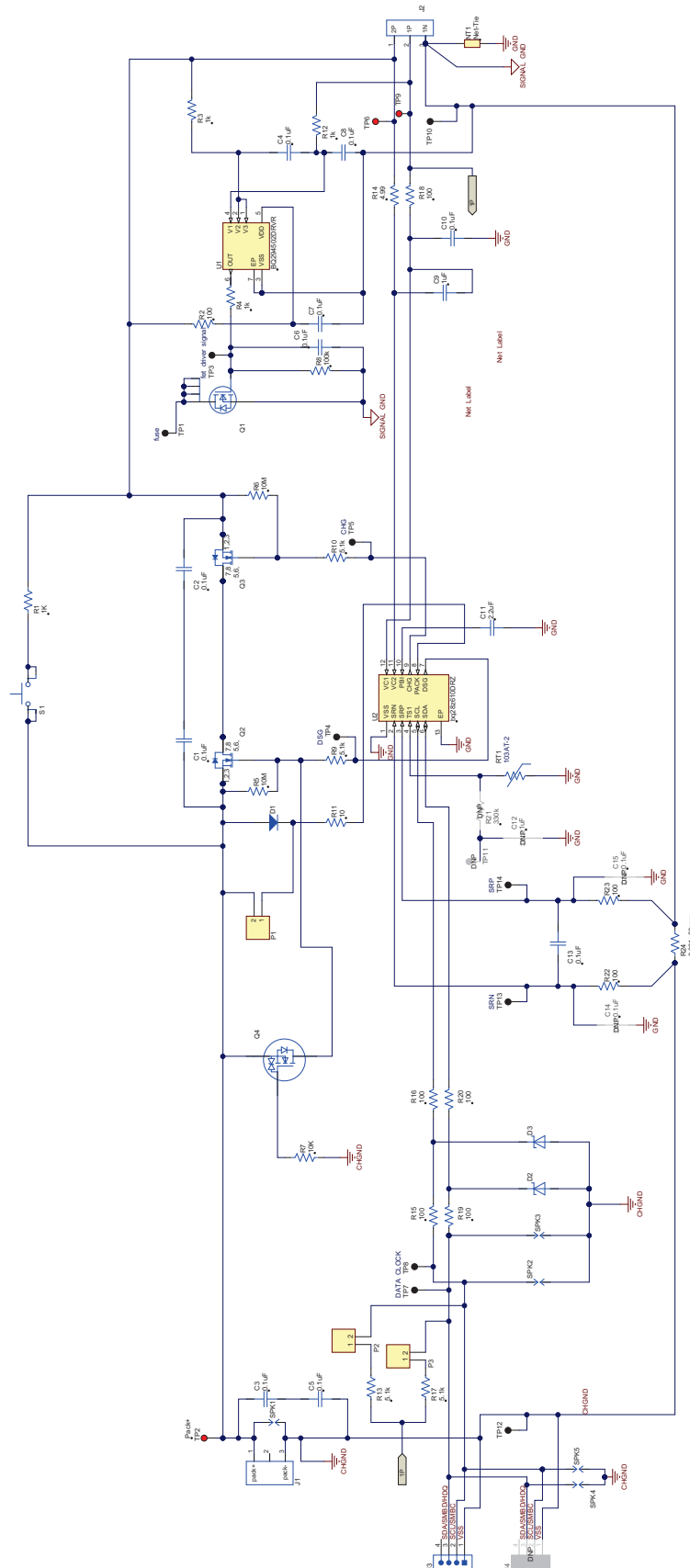

Figure 20. Schematic

4.3 Testing Fuse-Blowing Circuit

To prevent the loss of board functionality during the fuse-blowing test, the actual chemical fuse is not provided in the circuit. FET Q1 drives TP1 low if a fuse-blow condition occurs; thus, monitoring TP1 can be used to test this condition.

Revision History

NOTE: Page numbers for previous revisions may differ from page numbers in the current version.

Date	Revision	Notes
November 2015	*	Initial Release

STANDARD TERMS AND CONDITIONS FOR EVALUATION MODULES

1. *Delivery:* TI delivers TI evaluation boards, kits, or modules, including any accompanying demonstration software, components, or documentation (collectively, an "EVM" or "EVMs") to the User ("User") in accordance with the terms and conditions set forth herein. Acceptance of the EVM is expressly subject to the following terms and conditions.
 - 1.1 EVMs are intended solely for product or software developers for use in a research and development setting to facilitate feasibility evaluation, experimentation, or scientific analysis of TI semiconductor products. EVMs have no direct function and are not finished products. EVMs shall not be directly or indirectly assembled as a part or subassembly in any finished product. For clarification, any software or software tools provided with the EVM ("Software") shall not be subject to the terms and conditions set forth herein but rather shall be subject to the applicable terms and conditions that accompany such Software
 - 1.2 EVMs are not intended for consumer or household use. EVMs may not be sold, sublicensed, leased, rented, loaned, assigned, or otherwise distributed for commercial purposes by Users, in whole or in part, or used in any finished product or production system.
2. *Limited Warranty and Related Remedies/Disclaimers:*
 - 2.1 These terms and conditions do not apply to Software. The warranty, if any, for Software is covered in the applicable Software License Agreement.
 - 2.2 TI warrants that the TI EVM will conform to TI's published specifications for ninety (90) days after the date TI delivers such EVM to User. Notwithstanding the foregoing, TI shall not be liable for any defects that are caused by neglect, misuse or mistreatment by an entity other than TI, including improper installation or testing, or for any EVMs that have been altered or modified in any way by an entity other than TI. Moreover, TI shall not be liable for any defects that result from User's design, specifications or instructions for such EVMs. Testing and other quality control techniques are used to the extent TI deems necessary or as mandated by government requirements. TI does not test all parameters of each EVM.
 - 2.3 If any EVM fails to conform to the warranty set forth above, TI's sole liability shall be at its option to repair or replace such EVM, or credit User's account for such EVM. TI's liability under this warranty shall be limited to EVMs that are returned during the warranty period to the address designated by TI and that are determined by TI not to conform to such warranty. If TI elects to repair or replace such EVM, TI shall have a reasonable time to repair such EVM or provide replacements. Repaired EVMs shall be warranted for the remainder of the original warranty period. Replaced EVMs shall be warranted for a new full ninety (90) day warranty period.
3. *Regulatory Notices:*
 - 3.1 *United States*
 - 3.1.1 *Notice applicable to EVMs not FCC-Approved:*

This kit is designed to allow product developers to evaluate electronic components, circuitry, or software associated with the kit to determine whether to incorporate such items in a finished product and software developers to write software applications for use with the end product. This kit is not a finished product and when assembled may not be resold or otherwise marketed unless all required FCC equipment authorizations are first obtained. Operation is subject to the condition that this product not cause harmful interference to licensed radio stations and that this product accept harmful interference. Unless the assembled kit is designed to operate under part 15, part 18 or part 95 of this chapter, the operator of the kit must operate under the authority of an FCC license holder or must secure an experimental authorization under part 5 of this chapter.
 - 3.1.2 *For EVMs annotated as FCC – FEDERAL COMMUNICATIONS COMMISSION Part 15 Compliant:*

CAUTION

This device complies with part 15 of the FCC Rules. Operation is subject to the following two conditions: (1) This device may not cause harmful interference, and (2) this device must accept any interference received, including interference that may cause undesired operation.

Changes or modifications not expressly approved by the party responsible for compliance could void the user's authority to operate the equipment.

FCC Interference Statement for Class A EVM devices

NOTE: This equipment has been tested and found to comply with the limits for a Class A digital device, pursuant to part 15 of the FCC Rules. These limits are designed to provide reasonable protection against harmful interference when the equipment is operated in a commercial environment. This equipment generates, uses, and can radiate radio frequency energy and, if not installed and used in accordance with the instruction manual, may cause harmful interference to radio communications. Operation of this equipment in a residential area is likely to cause harmful interference in which case the user will be required to correct the interference at his own expense.

FCC Interference Statement for Class B EVM devices

NOTE: This equipment has been tested and found to comply with the limits for a Class B digital device, pursuant to part 15 of the FCC Rules. These limits are designed to provide reasonable protection against harmful interference in a residential installation. This equipment generates, uses and can radiate radio frequency energy and, if not installed and used in accordance with the instructions, may cause harmful interference to radio communications. However, there is no guarantee that interference will not occur in a particular installation. If this equipment does cause harmful interference to radio or television reception, which can be determined by turning the equipment off and on, the user is encouraged to try to correct the interference by one or more of the following measures:

- Reorient or relocate the receiving antenna.
- Increase the separation between the equipment and receiver.
- Connect the equipment into an outlet on a circuit different from that to which the receiver is connected.
- Consult the dealer or an experienced radio/TV technician for help.

3.2 Canada

3.2.1 For EVMs issued with an Industry Canada Certificate of Conformance to RSS-210

Concerning EVMs Including Radio Transmitters:

This device complies with Industry Canada license-exempt RSS standard(s). Operation is subject to the following two conditions: (1) this device may not cause interference, and (2) this device must accept any interference, including interference that may cause undesired operation of the device.

Concernant les EVMs avec appareils radio:

Le présent appareil est conforme aux CNR d'Industrie Canada applicables aux appareils radio exempts de licence. L'exploitation est autorisée aux deux conditions suivantes: (1) l'appareil ne doit pas produire de brouillage, et (2) l'utilisateur de l'appareil doit accepter tout brouillage radioélectrique subi, même si le brouillage est susceptible d'en compromettre le fonctionnement.

Concerning EVMs Including Detachable Antennas:

Under Industry Canada regulations, this radio transmitter may only operate using an antenna of a type and maximum (or lesser) gain approved for the transmitter by Industry Canada. To reduce potential radio interference to other users, the antenna type and its gain should be so chosen that the equivalent isotropically radiated power (e.i.r.p.) is not more than that necessary for successful communication. This radio transmitter has been approved by Industry Canada to operate with the antenna types listed in the user guide with the maximum permissible gain and required antenna impedance for each antenna type indicated. Antenna types not included in this list, having a gain greater than the maximum gain indicated for that type, are strictly prohibited for use with this device.

Concernant les EVMs avec antennes détachables

Conformément à la réglementation d'Industrie Canada, le présent émetteur radio peut fonctionner avec une antenne d'un type et d'un gain maximal (ou inférieur) approuvé pour l'émetteur par Industrie Canada. Dans le but de réduire les risques de brouillage radioélectrique à l'intention des autres utilisateurs, il faut choisir le type d'antenne et son gain de sorte que la puissance isotrope rayonnée équivalente (p.i.r.e.) ne dépasse pas l'intensité nécessaire à l'établissement d'une communication satisfaisante. Le présent émetteur radio a été approuvé par Industrie Canada pour fonctionner avec les types d'antenne énumérés dans le manuel d'usage et ayant un gain admissible maximal et l'impédance requise pour chaque type d'antenne. Les types d'antenne non inclus dans cette liste, ou dont le gain est supérieur au gain maximal indiqué, sont strictement interdits pour l'exploitation de l'émetteur.

3.3 Japan

3.3.1 *Notice for EVMs delivered in Japan:* Please see http://www.tij.co.jp/lstds/ti_ja/general/eStore/notice_01.page 日本国内に輸入される評価用キット、ボードについては、次のところをご覧ください。
http://www.tij.co.jp/lstds/ti_ja/general/eStore/notice_01.page

3.3.2 *Notice for Users of EVMs Considered "Radio Frequency Products" in Japan:* EVMs entering Japan may not be certified by TI as conforming to Technical Regulations of Radio Law of Japan.

If User uses EVMs in Japan, not certified to Technical Regulations of Radio Law of Japan, User is required by Radio Law of Japan to follow the instructions below with respect to EVMs:

1. Use EVMs in a shielded room or any other test facility as defined in the notification #173 issued by Ministry of Internal Affairs and Communications on March 28, 2006, based on Sub-section 1.1 of Article 6 of the Ministry's Rule for Enforcement of Radio Law of Japan,
2. Use EVMs only after User obtains the license of Test Radio Station as provided in Radio Law of Japan with respect to EVMs, or
3. Use of EVMs only after User obtains the Technical Regulations Conformity Certification as provided in Radio Law of Japan with respect to EVMs. Also, do not transfer EVMs, unless User gives the same notice above to the transferee. Please note that if User does not follow the instructions above, User will be subject to penalties of Radio Law of Japan.

【無線電波を送信する製品の開発キットをお使いになる際の注意事項】 開発キットの中には技術基準適合証明を受けていないものがあります。技術適合証明を受けていないものご使用に際しては、電波法遵守のため、以下のいずれかの措置を取っていただく必要がありますのでご注意ください。

1. 電波法施行規則第6条第1項第1号に基づく平成18年3月28日総務省告示第173号で定められた電波暗室等の試験設備でご使用いただく。
2. 実験局の免許を取得後ご使用いただく。
3. 技術基準適合証明を取得後ご使用いただく。

なお、本製品は、上記の「ご使用にあたっての注意」を譲渡先、移転先に通知しない限り、譲渡、移転できないものとします。

上記を遵守頂けない場合は、電波法の罰則が適用される可能性があることをご留意ください。日本テキサス・インスツルメンツ株式会社
東京都新宿区西新宿 6 丁目 2 4 番 1 号
西新宿三井ビル

3.3.3 *Notice for EVMs for Power Line Communication:* Please see http://www.tij.co.jp/llds/ti_ja/general/eStore/notice_02.page
電力線搬送波通信についての開発キットをお使いになる際の注意事項については、次のところをご覧ください。http://www.tij.co.jp/llds/ti_ja/general/eStore/notice_02.page

4 *EVM Use Restrictions and Warnings:*

4.1 EVMS ARE NOT FOR USE IN FUNCTIONAL SAFETY AND/OR SAFETY CRITICAL EVALUATIONS, INCLUDING BUT NOT LIMITED TO EVALUATIONS OF LIFE SUPPORT APPLICATIONS.

4.2 User must read and apply the user guide and other available documentation provided by TI regarding the EVM prior to handling or using the EVM, including without limitation any warning or restriction notices. The notices contain important safety information related to, for example, temperatures and voltages.

4.3 *Safety-Related Warnings and Restrictions:*

4.3.1 User shall operate the EVM within TI's recommended specifications and environmental considerations stated in the user guide, other available documentation provided by TI, and any other applicable requirements and employ reasonable and customary safeguards. Exceeding the specified performance ratings and specifications (including but not limited to input and output voltage, current, power, and environmental ranges) for the EVM may cause personal injury or death, or property damage. If there are questions concerning performance ratings and specifications, User should contact a TI field representative prior to connecting interface electronics including input power and intended loads. Any loads applied outside of the specified output range may also result in unintended and/or inaccurate operation and/or possible permanent damage to the EVM and/or interface electronics. Please consult the EVM user guide prior to connecting any load to the EVM output. If there is uncertainty as to the load specification, please contact a TI field representative. During normal operation, even with the inputs and outputs kept within the specified allowable ranges, some circuit components may have elevated case temperatures. These components include but are not limited to linear regulators, switching transistors, pass transistors, current sense resistors, and heat sinks, which can be identified using the information in the associated documentation. When working with the EVM, please be aware that the EVM may become very warm.

4.3.2 EVMs are intended solely for use by technically qualified, professional electronics experts who are familiar with the dangers and application risks associated with handling electrical mechanical components, systems, and subsystems. User assumes all responsibility and liability for proper and safe handling and use of the EVM by User or its employees, affiliates, contractors or designees. User assumes all responsibility and liability to ensure that any interfaces (electronic and/or mechanical) between the EVM and any human body are designed with suitable isolation and means to safely limit accessible leakage currents to minimize the risk of electrical shock hazard. User assumes all responsibility and liability for any improper or unsafe handling or use of the EVM by User or its employees, affiliates, contractors or designees.

4.4 User assumes all responsibility and liability to determine whether the EVM is subject to any applicable international, federal, state, or local laws and regulations related to User's handling and use of the EVM and, if applicable, User assumes all responsibility and liability for compliance in all respects with such laws and regulations. User assumes all responsibility and liability for proper disposal and recycling of the EVM consistent with all applicable international, federal, state, and local requirements.

5. *Accuracy of Information:* To the extent TI provides information on the availability and function of EVMs, TI attempts to be as accurate as possible. However, TI does not warrant the accuracy of EVM descriptions, EVM availability or other information on its websites as accurate, complete, reliable, current, or error-free.

6. *Disclaimers:*
- 6.1 EXCEPT AS SET FORTH ABOVE, EVMS AND ANY WRITTEN DESIGN MATERIALS PROVIDED WITH THE EVM (AND THE DESIGN OF THE EVM ITSELF) ARE PROVIDED "AS IS" AND "WITH ALL FAULTS." TI DISCLAIMS ALL OTHER WARRANTIES, EXPRESS OR IMPLIED, REGARDING SUCH ITEMS, INCLUDING BUT NOT LIMITED TO ANY IMPLIED WARRANTIES OF MERCHANTABILITY OR FITNESS FOR A PARTICULAR PURPOSE OR NON-INFRINGEMENT OF ANY THIRD PARTY PATENTS, COPYRIGHTS, TRADE SECRETS OR OTHER INTELLECTUAL PROPERTY RIGHTS.
- 6.2 EXCEPT FOR THE LIMITED RIGHT TO USE THE EVM SET FORTH HEREIN, NOTHING IN THESE TERMS AND CONDITIONS SHALL BE CONSTRUED AS GRANTING OR CONFERRING ANY RIGHTS BY LICENSE, PATENT, OR ANY OTHER INDUSTRIAL OR INTELLECTUAL PROPERTY RIGHT OF TI, ITS SUPPLIERS/LICENSORS OR ANY OTHER THIRD PARTY, TO USE THE EVM IN ANY FINISHED END-USER OR READY-TO-USE FINAL PRODUCT, OR FOR ANY INVENTION, DISCOVERY OR IMPROVEMENT MADE, CONCEIVED OR ACQUIRED PRIOR TO OR AFTER DELIVERY OF THE EVM.
7. *USER'S INDEMNITY OBLIGATIONS AND REPRESENTATIONS.* USER WILL DEFEND, INDEMNIFY AND HOLD TI, ITS LICENSORS AND THEIR REPRESENTATIVES HARMLESS FROM AND AGAINST ANY AND ALL CLAIMS, DAMAGES, LOSSES, EXPENSES, COSTS AND LIABILITIES (COLLECTIVELY, "CLAIMS") ARISING OUT OF OR IN CONNECTION WITH ANY HANDLING OR USE OF THE EVM THAT IS NOT IN ACCORDANCE WITH THESE TERMS AND CONDITIONS. THIS OBLIGATION SHALL APPLY WHETHER CLAIMS ARISE UNDER STATUTE, REGULATION, OR THE LAW OF TORT, CONTRACT OR ANY OTHER LEGAL THEORY, AND EVEN IF THE EVM FAILS TO PERFORM AS DESCRIBED OR EXPECTED.
8. *Limitations on Damages and Liability:*
- 8.1 *General Limitations.* IN NO EVENT SHALL TI BE LIABLE FOR ANY SPECIAL, COLLATERAL, INDIRECT, PUNITIVE, INCIDENTAL, CONSEQUENTIAL, OR EXEMPLARY DAMAGES IN CONNECTION WITH OR ARISING OUT OF THESE TERMS AND CONDITIONS OR THE USE OF THE EVMS PROVIDED HEREUNDER, REGARDLESS OF WHETHER TI HAS BEEN ADVISED OF THE POSSIBILITY OF SUCH DAMAGES. EXCLUDED DAMAGES INCLUDE, BUT ARE NOT LIMITED TO, COST OF REMOVAL OR REINSTALLATION, ANCILLARY COSTS TO THE PROCUREMENT OF SUBSTITUTE GOODS OR SERVICES, RETESTING, OUTSIDE COMPUTER TIME, LABOR COSTS, LOSS OF GOODWILL, LOSS OF PROFITS, LOSS OF SAVINGS, LOSS OF USE, LOSS OF DATA, OR BUSINESS INTERRUPTION. NO CLAIM, SUIT OR ACTION SHALL BE BROUGHT AGAINST TI MORE THAN ONE YEAR AFTER THE RELATED CAUSE OF ACTION HAS OCCURRED.
- 8.2 *Specific Limitations.* IN NO EVENT SHALL TI'S AGGREGATE LIABILITY FROM ANY WARRANTY OR OTHER OBLIGATION ARISING OUT OF OR IN CONNECTION WITH THESE TERMS AND CONDITIONS, OR ANY USE OF ANY TI EVM PROVIDED HEREUNDER, EXCEED THE TOTAL AMOUNT PAID TO TI FOR THE PARTICULAR UNITS SOLD UNDER THESE TERMS AND CONDITIONS WITH RESPECT TO WHICH LOSSES OR DAMAGES ARE CLAIMED. THE EXISTENCE OF MORE THAN ONE CLAIM AGAINST THE PARTICULAR UNITS SOLD TO USER UNDER THESE TERMS AND CONDITIONS SHALL NOT ENLARGE OR EXTEND THIS LIMIT.
9. *Return Policy.* Except as otherwise provided, TI does not offer any refunds, returns, or exchanges. Furthermore, no return of EVM(s) will be accepted if the package has been opened and no return of the EVM(s) will be accepted if they are damaged or otherwise not in a resalable condition. If User feels it has been incorrectly charged for the EVM(s) it ordered or that delivery violates the applicable order, User should contact TI. All refunds will be made in full within thirty (30) working days from the return of the components(s), excluding any postage or packaging costs.
10. *Governing Law:* These terms and conditions shall be governed by and interpreted in accordance with the laws of the State of Texas, without reference to conflict-of-laws principles. User agrees that non-exclusive jurisdiction for any dispute arising out of or relating to these terms and conditions lies within courts located in the State of Texas and consents to venue in Dallas County, Texas. Notwithstanding the foregoing, any judgment may be enforced in any United States or foreign court, and TI may seek injunctive relief in any United States or foreign court.

Mailing Address: Texas Instruments, Post Office Box 655303, Dallas, Texas 75265
Copyright © 2015, Texas Instruments Incorporated

IMPORTANT NOTICE

Texas Instruments Incorporated and its subsidiaries (TI) reserve the right to make corrections, enhancements, improvements and other changes to its semiconductor products and services per JESD46, latest issue, and to discontinue any product or service per JESD48, latest issue. Buyers should obtain the latest relevant information before placing orders and should verify that such information is current and complete. All semiconductor products (also referred to herein as "components") are sold subject to TI's terms and conditions of sale supplied at the time of order acknowledgment.

TI warrants performance of its components to the specifications applicable at the time of sale, in accordance with the warranty in TI's terms and conditions of sale of semiconductor products. Testing and other quality control techniques are used to the extent TI deems necessary to support this warranty. Except where mandated by applicable law, testing of all parameters of each component is not necessarily performed.

TI assumes no liability for applications assistance or the design of Buyers' products. Buyers are responsible for their products and applications using TI components. To minimize the risks associated with Buyers' products and applications, Buyers should provide adequate design and operating safeguards.

TI does not warrant or represent that any license, either express or implied, is granted under any patent right, copyright, mask work right, or other intellectual property right relating to any combination, machine, or process in which TI components or services are used. Information published by TI regarding third-party products or services does not constitute a license to use such products or services or a warranty or endorsement thereof. Use of such information may require a license from a third party under the patents or other intellectual property of the third party, or a license from TI under the patents or other intellectual property of TI.

Reproduction of significant portions of TI information in TI data books or data sheets is permissible only if reproduction is without alteration and is accompanied by all associated warranties, conditions, limitations, and notices. TI is not responsible or liable for such altered documentation. Information of third parties may be subject to additional restrictions.

Resale of TI components or services with statements different from or beyond the parameters stated by TI for that component or service voids all express and any implied warranties for the associated TI component or service and is an unfair and deceptive business practice. TI is not responsible or liable for any such statements.

Buyer acknowledges and agrees that it is solely responsible for compliance with all legal, regulatory and safety-related requirements concerning its products, and any use of TI components in its applications, notwithstanding any applications-related information or support that may be provided by TI. Buyer represents and agrees that it has all the necessary expertise to create and implement safeguards which anticipate dangerous consequences of failures, monitor failures and their consequences, lessen the likelihood of failures that might cause harm and take appropriate remedial actions. Buyer will fully indemnify TI and its representatives against any damages arising out of the use of any TI components in safety-critical applications.

In some cases, TI components may be promoted specifically to facilitate safety-related applications. With such components, TI's goal is to help enable customers to design and create their own end-product solutions that meet applicable functional safety standards and requirements. Nonetheless, such components are subject to these terms.

No TI components are authorized for use in FDA Class III (or similar life-critical medical equipment) unless authorized officers of the parties have executed a special agreement specifically governing such use.

Only those TI components which TI has specifically designated as military grade or "enhanced plastic" are designed and intended for use in military/aerospace applications or environments. Buyer acknowledges and agrees that any military or aerospace use of TI components which have **not** been so designated is solely at the Buyer's risk, and that Buyer is solely responsible for compliance with all legal and regulatory requirements in connection with such use.

TI has specifically designated certain components as meeting ISO/TS16949 requirements, mainly for automotive use. In any case of use of non-designated products, TI will not be responsible for any failure to meet ISO/TS16949.

Products

Audio	www.ti.com/audio
Amplifiers	amplifier.ti.com
Data Converters	dataconverter.ti.com
DLP® Products	www.dlp.com
DSP	dsp.ti.com
Clocks and Timers	www.ti.com/clocks
Interface	interface.ti.com
Logic	logic.ti.com
Power Mgmt	power.ti.com
Microcontrollers	microcontroller.ti.com
RFID	www.ti-rfid.com
OMAP Applications Processors	www.ti.com/omap
Wireless Connectivity	www.ti.com/wirelessconnectivity

Applications

Automotive and Transportation	www.ti.com/automotive
Communications and Telecom	www.ti.com/communications
Computers and Peripherals	www.ti.com/computers
Consumer Electronics	www.ti.com/consumer-apps
Energy and Lighting	www.ti.com/energy
Industrial	www.ti.com/industrial
Medical	www.ti.com/medical
Security	www.ti.com/security
Space, Avionics and Defense	www.ti.com/space-avionics-defense
Video and Imaging	www.ti.com/video

TI E2E Community

e2e.ti.com