

TPS65313-Q1 Device CISPR-25 EMC Test Results

ABSTRACT

The TPS65313-Q1 device is a power management integrated circuit (PMIC) for safety-relevant automotive applications with features supporting up to ASIL-C level. This device integrates a wide-input voltage off-battery buck regulator (BUCK1, 3.1-A rated), a low-voltage buck regulator (BUCK2, 2-A rated), and a 5-V boost converter (BOOST, 0.6-A rated). All the regulators are switching at 2.2-MHz and this device comes with a small package (40 pin QFN, 6-mm × 6-mm). This device also features an integrated adaptively randomized spread spectrum (ARSS) modulation for regulator switching clock to improve system level EMC performance.

This application report presents CISPR-25 Conducted Emission (CE) and Radiated Emission (RE) test results for the TPS65313-Q1 EVM and demonstrates how CISPR-25 class-5 limits can be met for this device.

Contents

1	Schematics and Printed Circuit Board Description	3
2	Description of Test Setup	4
3	Test Results	6
4	Conclusion	12
5	References	12

List of Figures

1	VIN/VBAT Filter Used on the TPS65313-EVM	3
2	Test Setup for Conducted Emission Measurement	5
3	Test Setup for Radiated Emission Measurement: 150-kHz to 30-MHz (Monopole Rod Antenna)	5
4	Test Setup for Radiated Emission Measurement: 30-MHz to 200-MHz (Vertical Bicon Antenna)	5
5	Test Setup for Radiated Emission Measurement: 30-MHz to 200-MHz (Horizontal Bicon Antenna)	5
6	Test Setup for Radiated Emission Measurement: 200-MHz to 1000-MHz (Vertical Log Antenna)	5
7	Test Setup for Radiated Emission Measurement: 200-MHz to 1000-MHz (Horizontal Log Antenna)	5
8	CE – Ambient: Line Side.....	6
9	CE – Ambient: Return Side.....	6
10	CE Line Side: E2_1 EVM Variant	6
11	CE Return Side: E2_1 EVM Variant	6
12	CE Line Side: E2_7 EVM Variant	6
13	CE Return Side: E2_7 EVM Variant	6
14	CE Line Side: E2_1 EVM Variant With SSM Enabled.....	6
15	CE Return Side: E2_1 EVM Variant With SSM Enabled.....	6
16	CE Line Side: E7_1 EVM Variant With SSM Enabled.....	6
17	CE Return Side: E7_1 EVM Variant With SSM Enabled	6
18	RE – 150-KHz to 30-MHz, Monopole Antenna: Ambient	8
19	RE – 150-KHz to 30-MHz, Monopole Antenna: E2_1 EVM Variant	8
20	RE – 150-KHz to 30-MHz, Monopole Antenna: E2_7 EVM Variant	8
21	RE – 150-KHz to 30-MHz, Monopole Antenna: E2_1 EVM Variant With SSM Enabled.....	8
22	RE – 150-KHz to 30-MHz, Monopole Antenna: E2_7 EVM Variant With SSM Enabled.....	8

23	RE – 30-MHz to 200-MHz, Bicon Vertical: Ambient	9
24	RE – 30-MHz to 200-MHz, Bicon Horizontal: Ambient	9
25	RE – 30-MHz to 200-MHz, Bicon Vertical: E2_1 EVM Variant	9
26	RE – 30-MHz to 200-MHz, Bicon Vertical: E2_7 EVM Variant	9
27	RE – 30-MHz to 200-MHz, Bicon Horizontal: E2_1 EVM Variant	9
28	RE – 30-MHz to 200-MHz, Bicon Horizontal: E2_7 EVM Variant	9
29	RE – 30-MHz to 200-MHz, Bicon Vertical: E2_1 EVM Variant With SSM Enabled.....	9
30	RE – 30-MHz to 200-MHz, Bicon Vertical: E2_7 EVM Variant With SSM Enabled.....	9
31	RE – 30-MHz to 200-MHz, Bicon Horizontal: E2_1 EVM Variant With SSM Enabled	9
32	RE – 30-MHz to 200-MHz, Bicon Horizontal: E2_7 EVM Variant With SSM Enabled	9
33	RE – 200-MHz to 1-GHz, Log Vertical: Ambient	11
34	RE – 200-MHz to 1-GHz, Log Horizontal: Ambient	11
35	RE – 200-MHz to 1-GHz, Log Vertical: E2_1 EVM Variant	11
36	RE – 200-MHz to 1-GHz, Log Vertical: E2_7 EVM Variant	11
37	RE – 200-MHz to 1-GHz, Log Horizontal: E2_1 EVM Variant	11
38	RE – 200-MHz to 1-GHz, Log Horizontal: E2_7 EVM Variant	11
39	RE – 200-MHz to 1-GHz, Log Vertical E2_1 EVM Variant With SSM Enabled.....	11
40	RE – 200-MHz to 1-GHz, Log Vertical: E2_7 EVM Variant With SSM Enabled	11
41	RE – 200-MHz to 1-GHz, Log Horizontal: E2_1 EVM Variant With SSM Enabled.....	11
42	RE– 200-MHz to 1-GHz, Log Horizontal: E2_7 EVM Variant With SSM Enabled.....	11

List of Tables

1	TPS65313-Q1 Device Configuration on EVM.....	3
2	EMI Receiver Settings for CE Measurements	4
3	EMI Receiver Settings for RE Measurements	4

Trademarks

All trademarks are the property of their respective owners.

1 Schematics and Printed Circuit Board Description

The TPS65313-EVM is designed with the purpose of passing the automotive-specific CISPR25 Class-5 Conducted and Radiated Emission tests. To improve the EMI performance of the device, an input filter is added to attenuate noise generated by the converter on the input voltage node. A snubber, together with a small boot resistor (between PHx and BOOTx pins), is added to the switching node of the device to attenuate high frequency components. Table 1 lists the device configuration used on the TPS65313-EVM for this testing. Figure 1 shows the VIN/VBAT filter used on the EVM for this testing. For detailed schematics and PCB layout information, refer to [TPS65313-EVM User's Guide](#).

Table 1. TPS65313-Q1 Device Configuration on EVM

Parameter	Value
V _{IN} / VBAT Input Voltage	12.5-V (Fully charged automotive battery)
VBUCK1 output voltage	3.3-V
VBUCK2 output voltage	1.8-V
VBOOST output voltage	5.0-V
F _{sw} Switching Frequency	2.2-MHz
Internal Spread spectrum mode	Enabled or disabled through the SPI interface

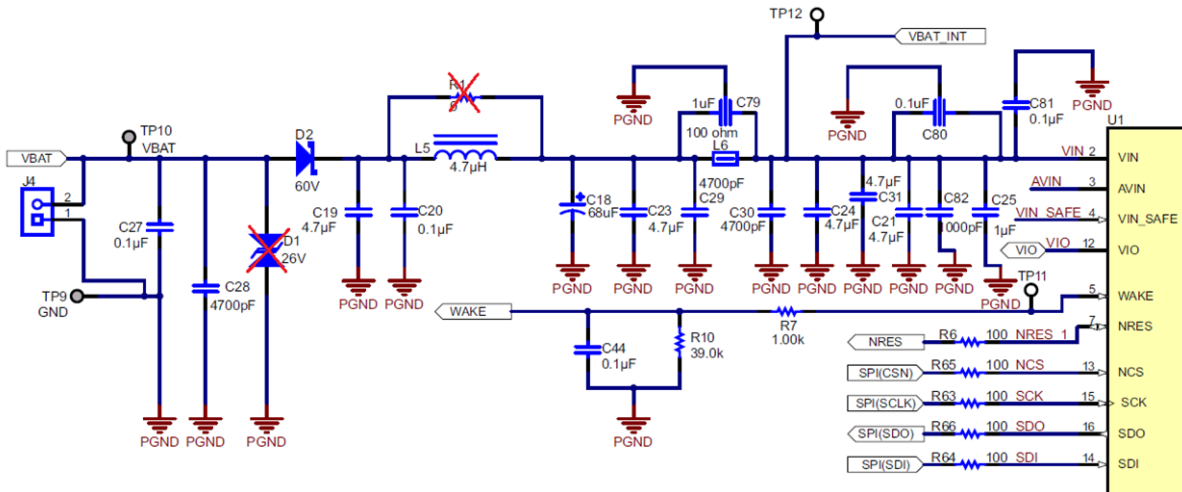

Figure 1. VIN/VBAT Filter Used on the TPS65313-EVM

2 Description of Test Setup

A fully compliant anechoic chamber and equipment is used for this testing and is carried out according to CISPR-25 test specifications. Two different TPS65313-EVM hardware BOM configurations (E2_1 and E2_7) is used for testing to study the impact of different external components on the EMC results. On each EVM, testing is done with and without spread spectrum enable options configured through SPI register settings.

E2_1: EVM without ferrite bead (L6, C79), without 3T capacitor (C80), without snubbers, without boot resistors. This is the base configuration without any external EMC measures with standard input supply filter.

E2_7: EVM with ferrite bead (L6) on VIN and VSUP2, with 100-nF 3T (C80) capacitor at VIN pin, with snubber (10- Ω , 1.2-nF snubber circuit used on each regulator), with boot resistors (10- Ω on each regulator boot pin).

For CE measurements, both line side (12-V battery positive side) and return side (12-V battery negative/ground side) measurements are done. Ambient measurements are done with the device in off state.

2.1 Test Conditions:

- Input supply:
 - Fully charged 12-V car battery.
 - Measured input supply current on E2_1 EVM = 505-mA.
 - Measured input supply current on E2_7 EVM = 545-mA.
- Load on each regulators:
 - BUCK1 = 5- Ω resistive load.
 - BUCK2 = 1.8- Ω resistive load and BOOST= 56- Ω resistive load.
 - Including BUCK2 and BOOST load, BUCK1 has around 1.5-A load current.
- [Table 2](#) shows EMI receiver settings for the conducted emission measurements.

Table 2. EMI Receiver Settings for CE Measurements

Frequency Range	Resolution Bandwidth	Step size	Measurement time
150-kHz – 30-MHz	9-kHz	5-kHz	50-ms/Pts
30-MHz – 108-MHz	120-kHz	50-kHz	5-ms/Pts

- [Table 3](#) shows EMI receiver settings for Radiated Emission measurement.

Table 3. EMI Receiver Settings for RE Measurements

Frequency Range	Resolution Bandwidth	Step size	Measurement time
150-kHz – 30-MHz	9-kHz	5-kHz	50-ms/Pts
30-MHz – 200-MHz	120-kHz	50-kHz	5-ms/Pts
200-MHz – 1-GHz	120-kHz	50-kHz	5-ms/Pts

2.2 Test Setup Photos:



Figure 2. Test Setup for Conducted Emission Measurement

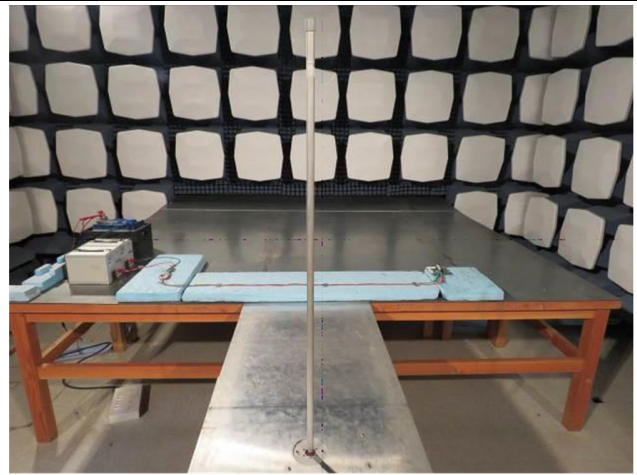

Figure 3. Test Setup for Radiated Emission Measurement: 150-kHz to 30-MHz (Monopole Rod Antenna)

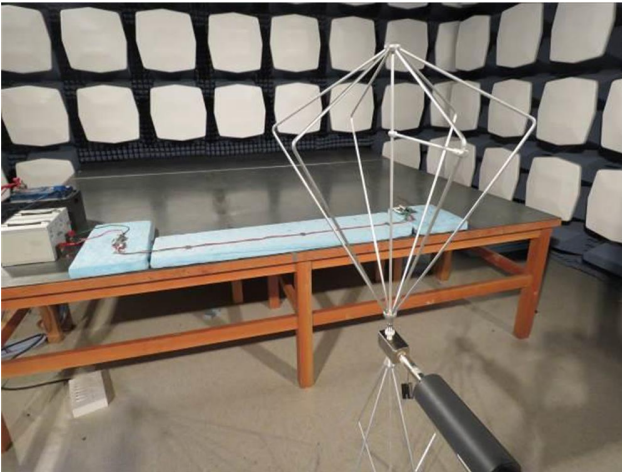

Figure 4. Test Setup for Radiated Emission Measurement: 30-MHz to 200-MHz (Vertical Bicon Antenna)

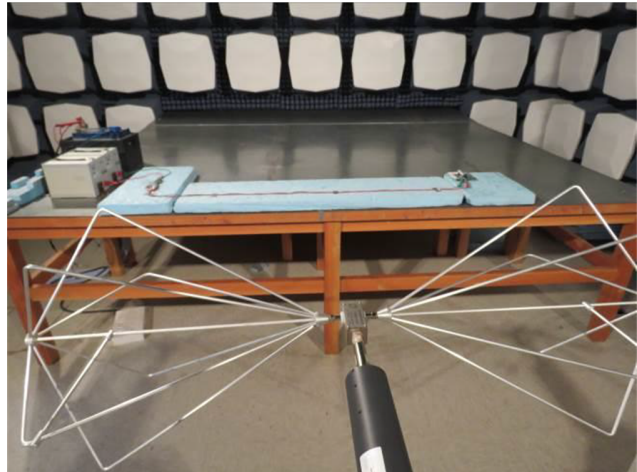

Figure 5. Test Setup for Radiated Emission Measurement: 30-MHz to 200-MHz (Horizontal Bicon Antenna)



Figure 6. Test Setup for Radiated Emission Measurement: 200-MHz to 1000-MHz (Vertical Log Antenna)



Figure 7. Test Setup for Radiated Emission Measurement: 200-MHz to 1000-MHz (Horizontal Log Antenna)

2.3 Pass or Fail Criteria

1. Any peaks below the average limit are an automatic pass.
2. Any peaks above the peak limit are an automatic fail.
3. When the peak is below the peak limit and if the average is below the average limit, it is considered a pass.

3 Test Results

3.1 Conducted Emission Results

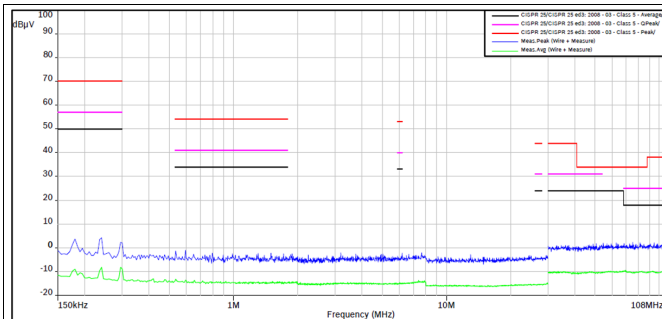

Figure 8. CE – Ambient: Line Side

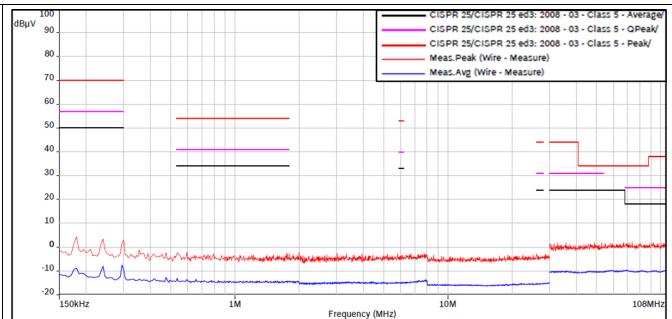

Figure 9. CE – Ambient: Return Side

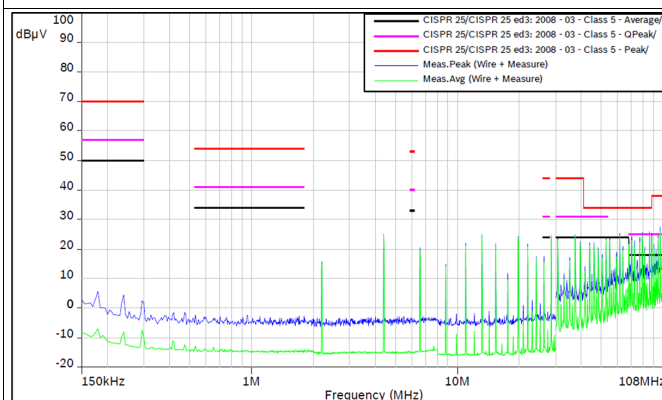

Figure 10. CE Line Side: E2_1 EVM Variant

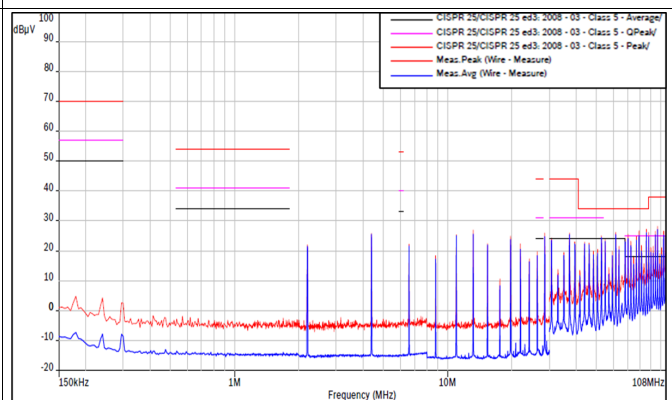

Figure 11. CE Return Side: E2_1 EVM Variant

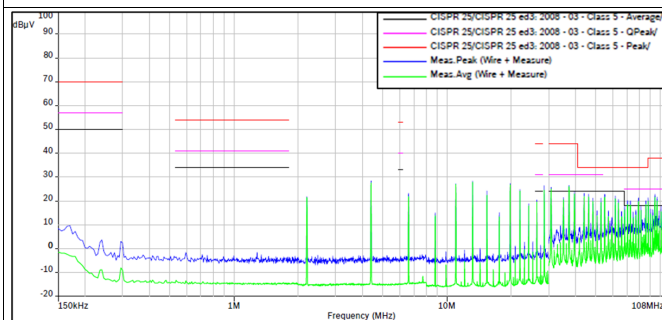

Figure 12. CE Line Side: E2_7 EVM Variant

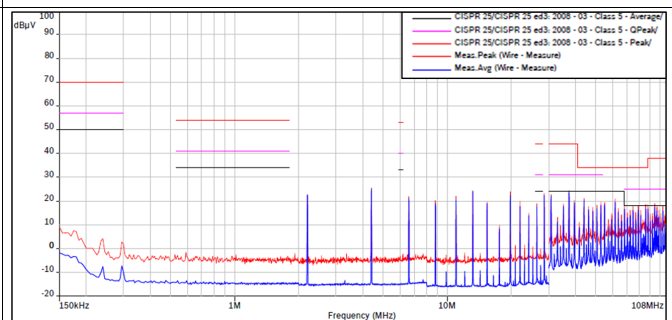

Figure 13. CE Return Side: E2_7 EVM Variant

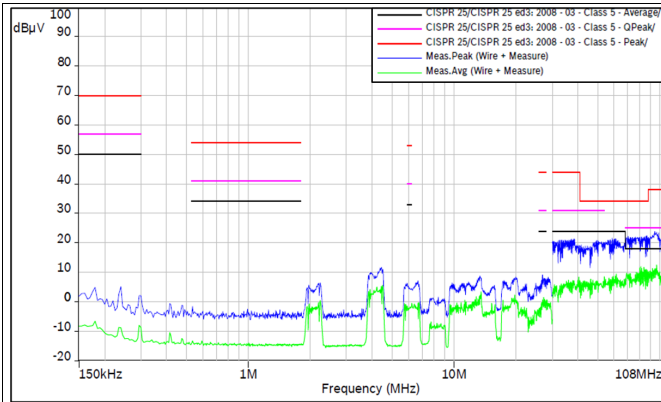

Figure 14. CE Line Side: E2_1 EVM Variant With SSM Enabled

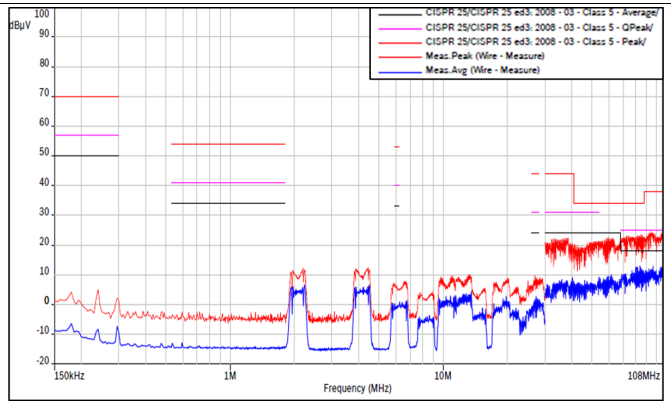

Figure 15. CE Return Side: E2_1 EVM Variant With SSM Enabled

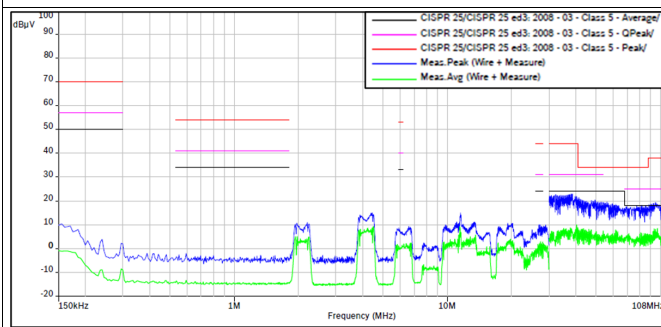

Figure 16. CE Line Side: E7_1 EVM Variant With SSM Enabled

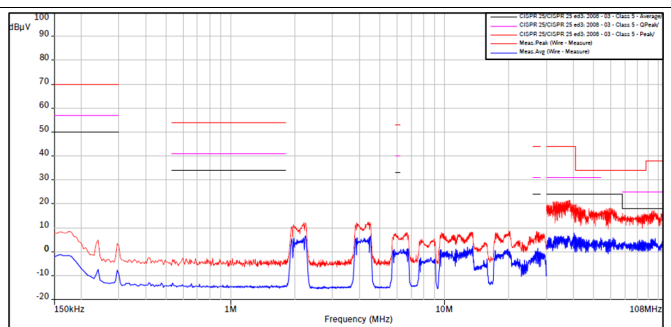

Figure 17. CE Return Side: E7_1 EVM Variant With SSM Enabled

3.2 Radiated Emission (RE) – 150-KHz to 30-MHz, Rod Antenna

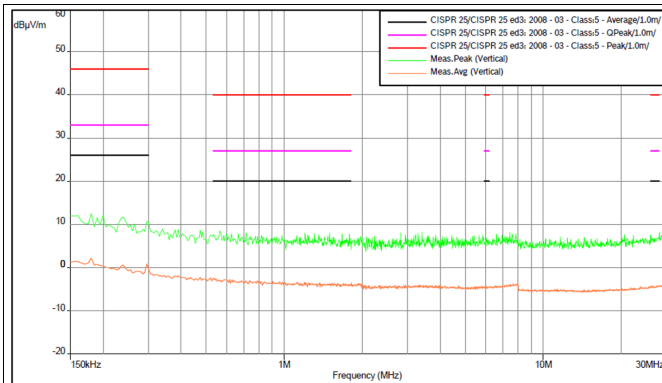

Figure 18. RE – 150-KHz to 30-MHz, Monopole Antenna: Ambient

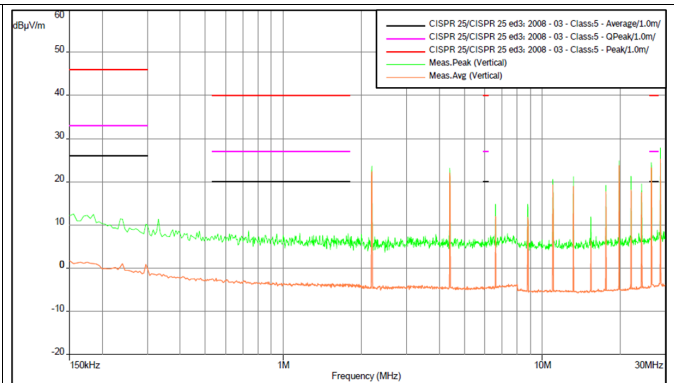

Figure 19. RE – 150-KHz to 30-MHz, Monopole Antenna: E2_1 EVM Variant

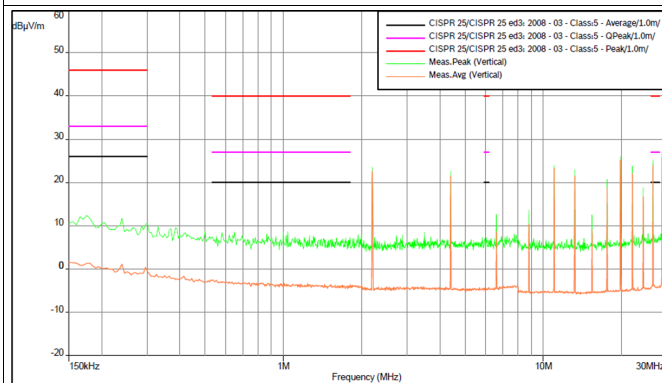

Figure 20. RE – 150-KHz to 30-MHz, Monopole Antenna: E2_7 EVM Variant

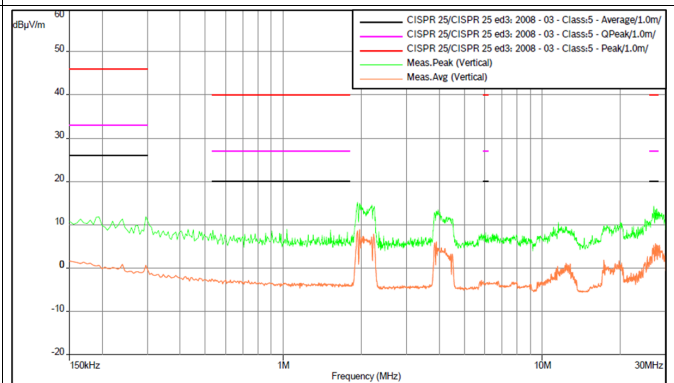

Figure 21. RE – 150-KHz to 30-MHz, Monopole Antenna: E2_1 EVM Variant With SSM Enabled

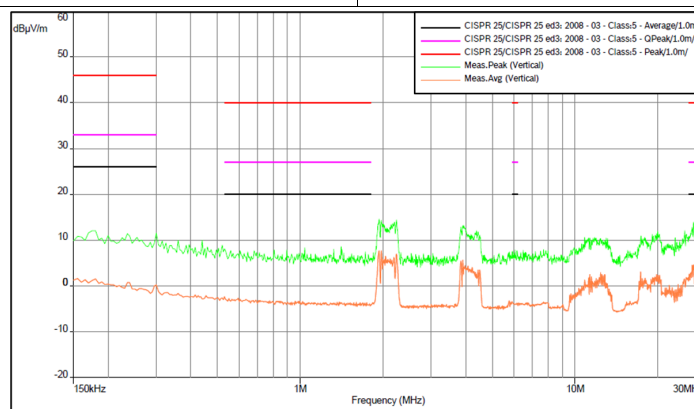

Figure 22. RE – 150-KHz to 30-MHz, Monopole Antenna: E2_7 EVM Variant With SSM Enabled

3.3 Radiated Emission (RE) – 30-MHz to 200-MHz, Bicon Antenna Results

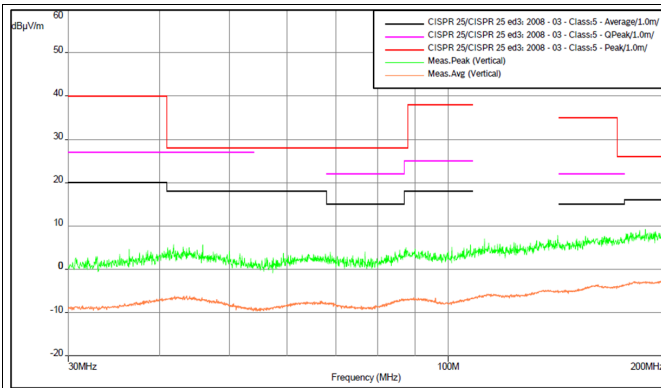

Figure 23. RE – 30-MHz to 200-MHz, Bicon Vertical: Ambient

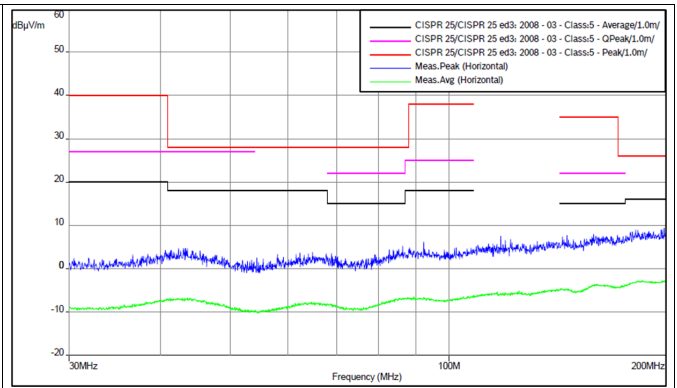

Figure 24. RE – 30-MHz to 200-MHz, Bicon Horizontal: Ambient

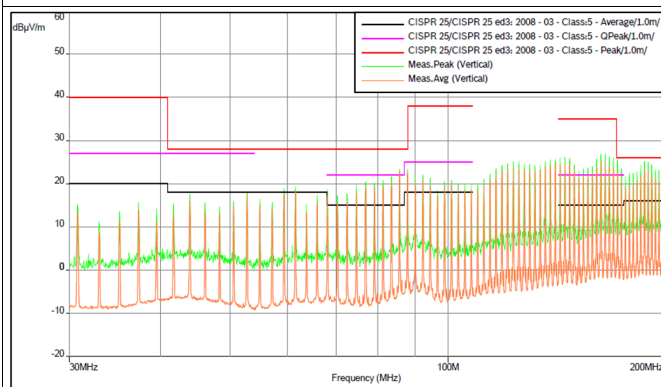

Figure 25. RE – 30-MHz to 200-MHz, Bicon Vertical: E2_1 EVM Variant

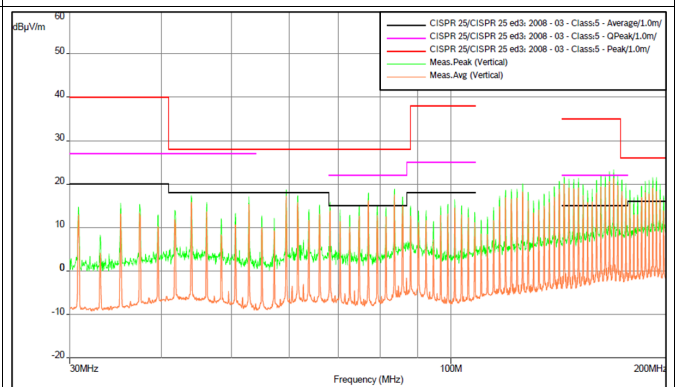

Figure 26. RE – 30-MHz to 200-MHz, Bicon Vertical: E2_7 EVM Variant

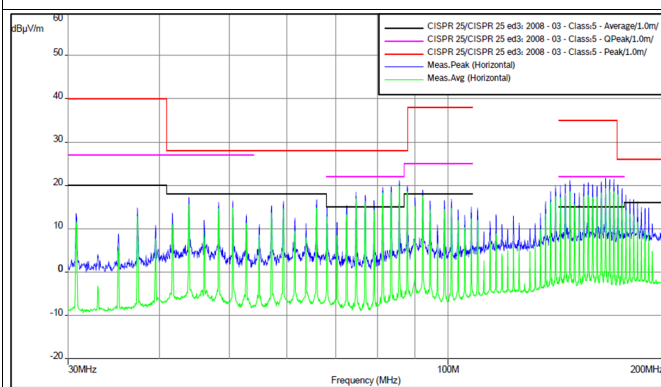

Figure 27. RE – 30-MHz to 200-MHz, Bicon Horizontal: E2_1 EVM Variant

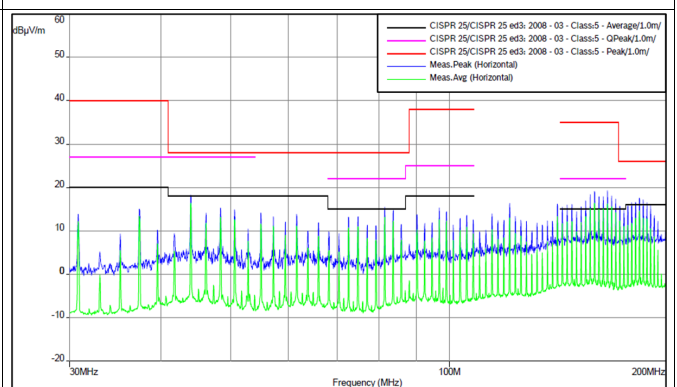

Figure 28. RE – 30-MHz to 200-MHz, Bicon Horizontal: E2_7 EVM Variant

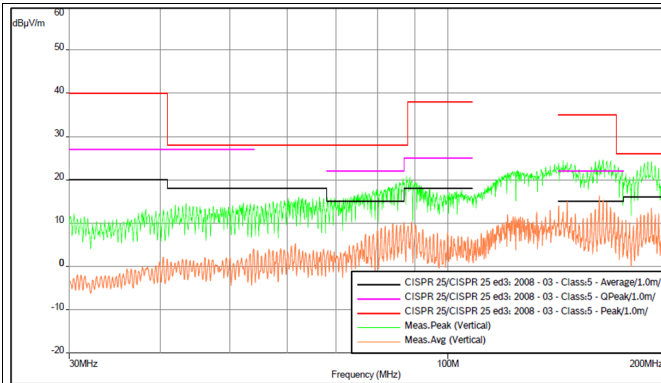

Figure 29. RE – 30-MHz to 200-MHz, Bicon Vertical: E2_1 EVM Variant With SSM Enabled

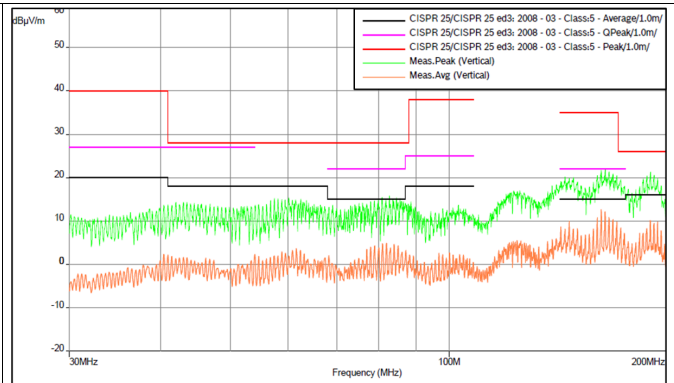

Figure 30. RE – 30-MHz to 200-MHz, Bicon Vertical: E2_7 EVM Variant With SSM Enabled

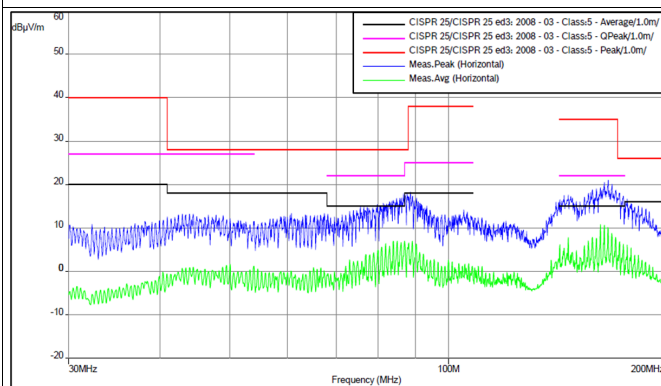

Figure 31. RE – 30-MHz to 200-MHz, Bicon Horizontal: E2_1 EVM Variant With SSM Enabled

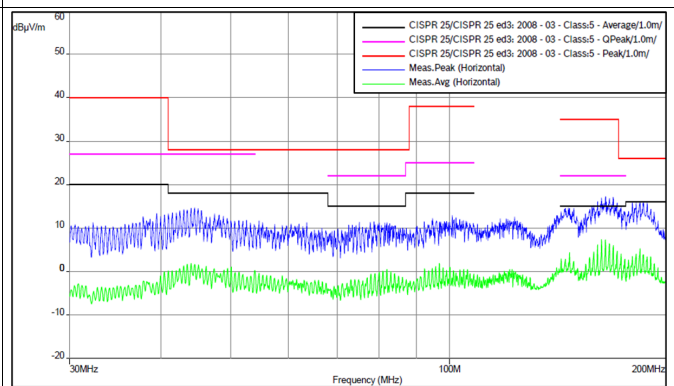

Figure 32. RE – 30-MHz to 200-MHz, Bicon Horizontal: E2_7 EVM Variant With SSM Enabled

3.4 Radiated Emission (RE) – 200-MHz to 1-GHz, Log antenna Results

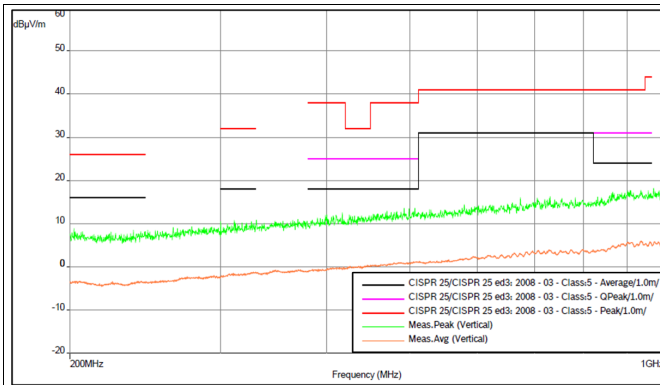

Figure 33. RE – 200-MHz to 1-GHz, Log Vertical: Ambient

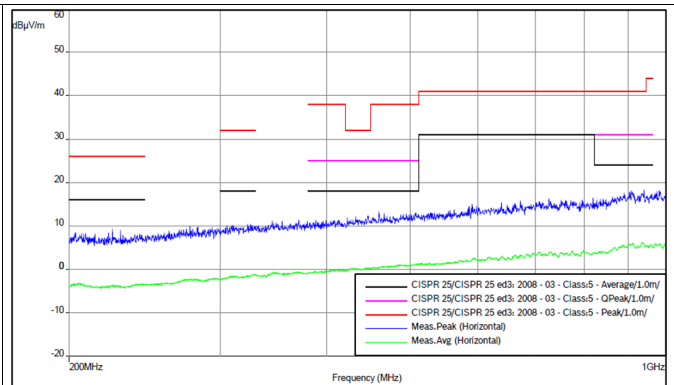

Figure 34. RE – 200-MHz to 1-GHz, Log Horizontal: Ambient

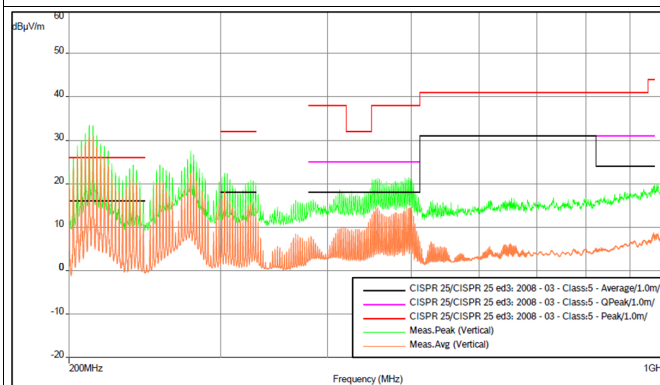

Figure 35. RE – 200-MHz to 1-GHz, Log Vertical: E2_1 EVM Variant

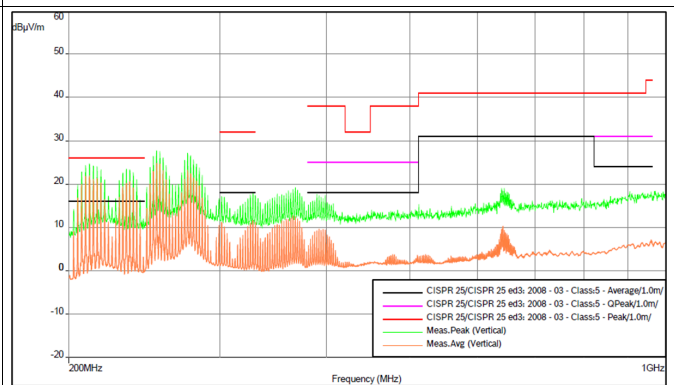

Figure 36. RE – 200-MHz to 1-GHz, Log Vertical: E2_7 EVM Variant

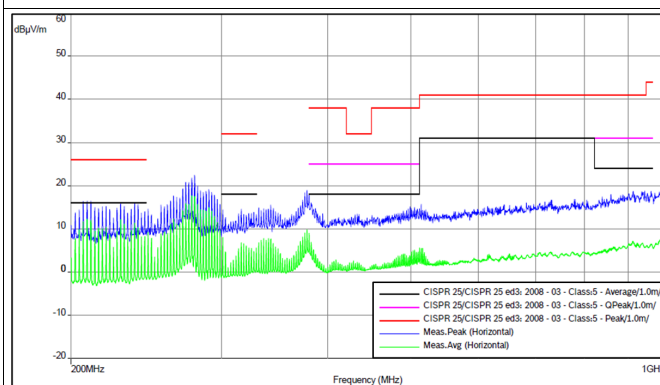

Figure 37. RE – 200-MHz to 1-GHz, Log Horizontal: E2_1 EVM Variant

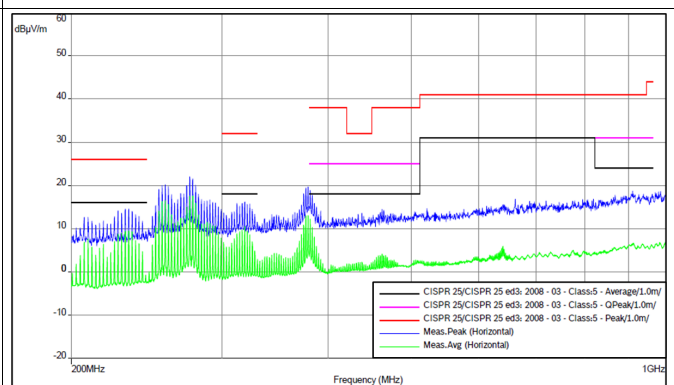

Figure 38. RE – 200-MHz to 1-GHz, Log Horizontal: E2_7 EVM Variant

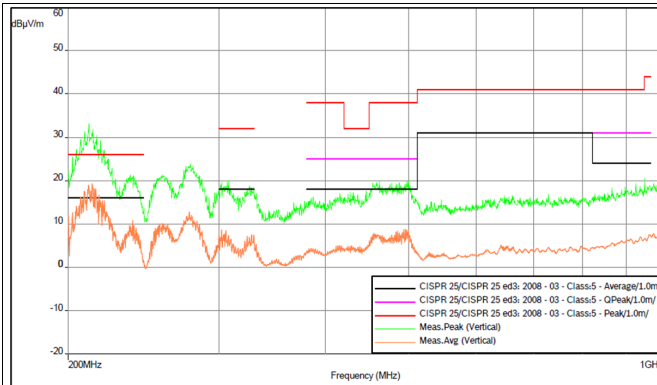

Figure 39. RE – 200-MHz to 1-GHz, Log Vertical E2_1 EVM Variant With SSM Enabled

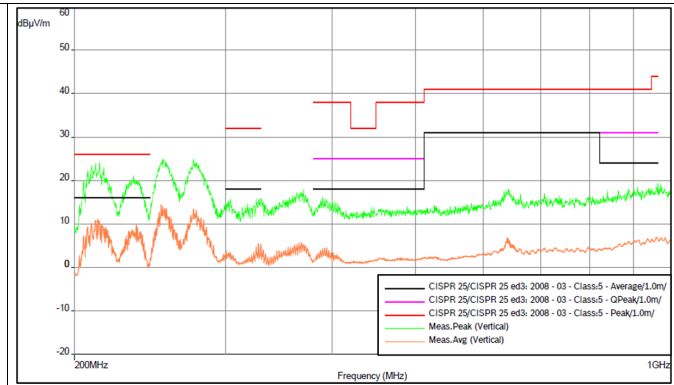

Figure 40. RE – 200-MHz to 1-GHz, Log Vertical: E2_7 EVM Variant With SSM Enabled

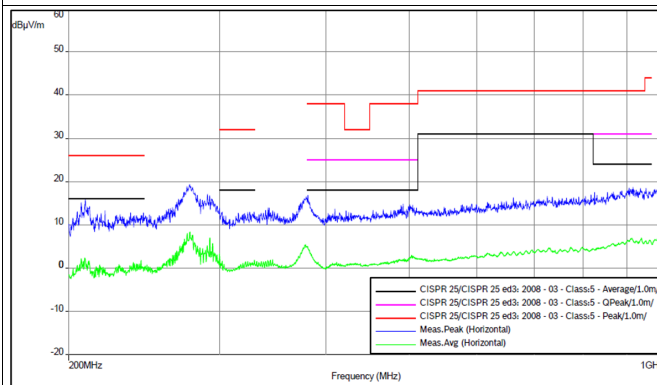

Figure 41. RE – 200-MHz to 1-GHz, Log Horizontal: E2_1 EVM Variant With SSM Enabled

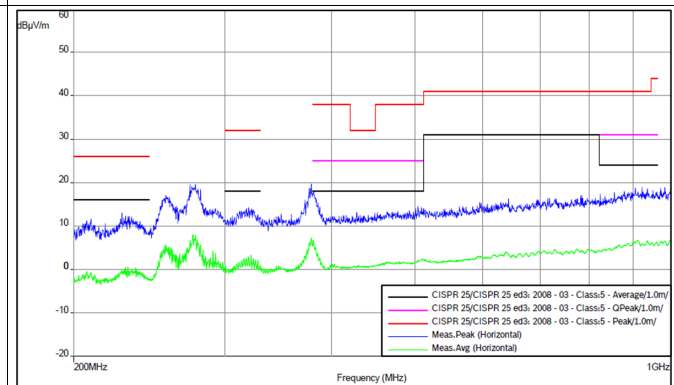

Figure 42. RE– 200-MHz to 1-GHz, Log Horizontal: E2_7 EVM Variant With SSM Enabled

4 Conclusion

- On the E2_7 EVM Variant, with given test conditions, with EMC counter measures like snubber, Boot resistor and SSM enable, CISPR-25 class-5 limits are passing with > 3-dBuV/m margin.
- On the E2_1 EVM Variant, with given test conditions, without EMC counter measures like snubber, Boot resistor and SSM enable, CISPR-25 class-5 is marginally failing at certain spot frequencies. But CISPR-25, class-4 limits are passing with good margin.
- EMC results can vary considerably based on the PCB, BOM and application conditions and hence these results are just for the reference and TI does not give any guarantee on the EMC results. Customers should verify the EMC performance on their board and optimize it to fulfill their requirements.

5 References

1. Texas Instruments, [TPS65313-EVM User's Guide](#).

IMPORTANT NOTICE AND DISCLAIMER

TI PROVIDES TECHNICAL AND RELIABILITY DATA (INCLUDING DATASHEETS), DESIGN RESOURCES (INCLUDING REFERENCE DESIGNS), APPLICATION OR OTHER DESIGN ADVICE, WEB TOOLS, SAFETY INFORMATION, AND OTHER RESOURCES "AS IS" AND WITH ALL FAULTS, AND DISCLAIMS ALL WARRANTIES, EXPRESS AND IMPLIED, INCLUDING WITHOUT LIMITATION ANY IMPLIED WARRANTIES OF MERCHANTABILITY, FITNESS FOR A PARTICULAR PURPOSE OR NON-INFRINGEMENT OF THIRD PARTY INTELLECTUAL PROPERTY RIGHTS.

These resources are intended for skilled developers designing with TI products. You are solely responsible for (1) selecting the appropriate TI products for your application, (2) designing, validating and testing your application, and (3) ensuring your application meets applicable standards, and any other safety, security, or other requirements. These resources are subject to change without notice. TI grants you permission to use these resources only for development of an application that uses the TI products described in the resource. Other reproduction and display of these resources is prohibited. No license is granted to any other TI intellectual property right or to any third party intellectual property right. TI disclaims responsibility for, and you will fully indemnify TI and its representatives against, any claims, damages, costs, losses, and liabilities arising out of your use of these resources.

TI's products are provided subject to TI's Terms of Sale (www.ti.com/legal/termsofsale.html) or other applicable terms available either on ti.com or provided in conjunction with such TI products. TI's provision of these resources does not expand or otherwise alter TI's applicable warranties or warranty disclaimers for TI products.

Mailing Address: Texas Instruments, Post Office Box 655303, Dallas, Texas 75265
Copyright © 2020, Texas Instruments Incorporated