

EVM User's Guide: TUSB2E221EVM

TUSB2E221 Evaluation Module



Description

The TUSB2E221EVM is designed to facilitate evaluation and validate the performance of the TUSB2E221 2-port eUSB repeater. The TUSB2E221EVM incorporates two micro-A/B USB 2.0 ports to connect to USB compliant hosts, hubs or devices. The EVM also has two sets of SMP connectors to interface with another eUSB2 PHY or test equipment.

Features

- Plug and play design
- The evaluation module (EVM) is powered by USB or Wall Power
- All device pin configuration options can be evaluated on the EVM
- I²C interface accessible

Applications

- [Communications equipment](#)
- [Enterprise systems](#)
- [Notebooks and desktops](#)
- [Industrial](#)
- [Tablets](#)
- [Portable electronics](#)

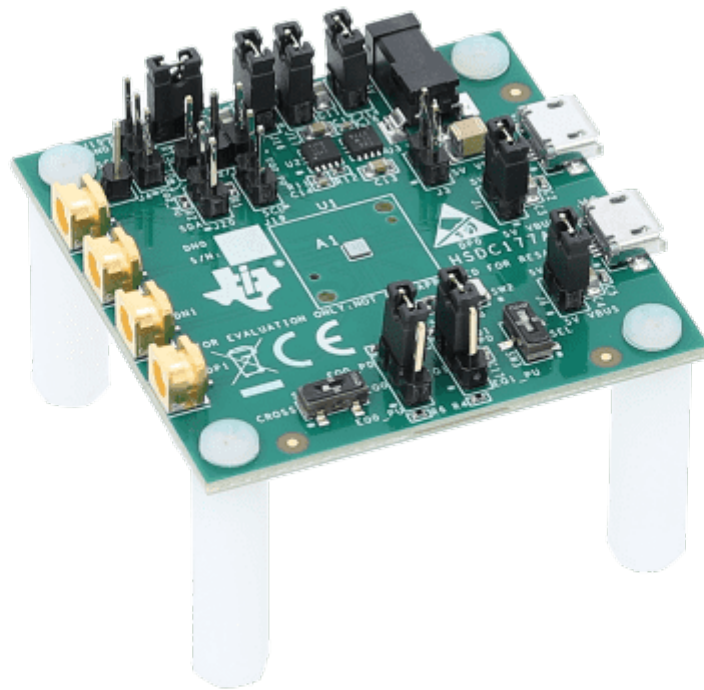

1 Evaluation Module Overview

1.1 Introduction

This user's guide covers the features, operating conditions, and configuration of the TUSB2E221 evaluation module (EVM). The TUSB2E221 supports low speed (LS), full speed (FS), and high speed (HS) operation and supports host, peripheral, and dual-role applications.

This user's guide contains information and support documentation for the TUSB2E221 evaluation module (EVM). Included are the schematics, PCB layouts, and bill of materials of the TUSB2E221EVM. Throughout this document, the terms evaluation board, evaluation module, and EVM are synonymous with the TUSB2E221EVM.

1.2 Kit Contents

This EVM kit contains the following items:

- TUSB2E221EVM board

The user needs to provide one or two micro USB cables and one or two sets of SMP cables, as well as a 5V power source for the EVM.

1.3 Specification

The TUSB2E221 device is designed to comply with the Embedded USB2 (eUSB2) Physical Layer Supplement to the USB Revision 2.0 Specification published by the USB-IF. This specification defines three primary states for a eUSB repeater: default, host, and peripheral states. After powering on the EVM, the TUSB2E221 is in the default state and awaiting configuration as a host or peripheral repeater. Configuration occurs over the eUSB interface by either the eUSB Host or eUSB device. For more information about configuration, refer to the Embedded USB2 (eUSB2) Physical Layer Supplement to the USB Revision 2.0 Specification.

The diagrams shown below describe the system setup using the TUSB2E221EVM with an eUSB host or an eUSB peripheral.

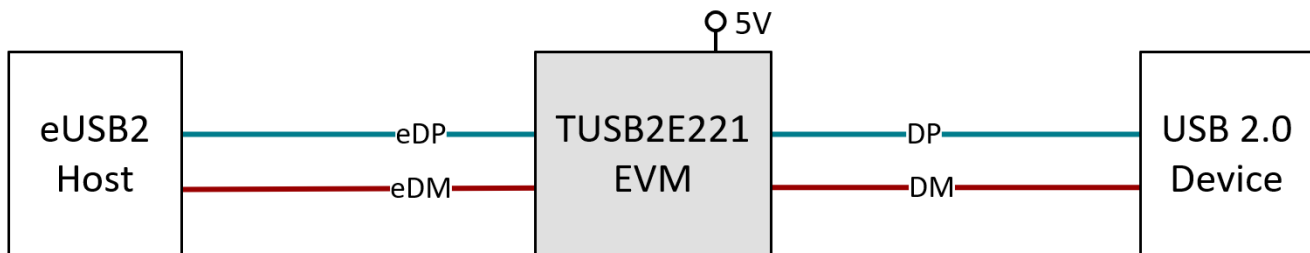

Figure 1-1. TUSB2E221EVM Host Repeater Diagram

In the default state, the TUSB2E221 does not forward eUSB or USB packets. When an eUSB2 host is connected to the eUSB ports of the TUSB2E221EVM, the repeater must be configured as a host repeater by the eUSB host. A 5V power source must be provided to the EVM to power to the device.

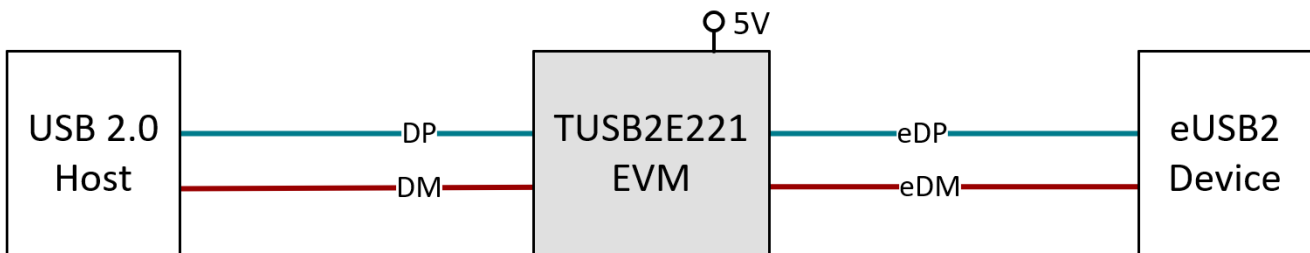

Figure 1-2. TUSB2E221EVM Self-powered Peripheral Repeater Diagram

When the eUSB ports are connected to an eUSB device, as shown [Figure 1-2](#), the TUSB2E221 must be configured as a peripheral repeater. In a self-powered configuration, an external 5V source is provided.

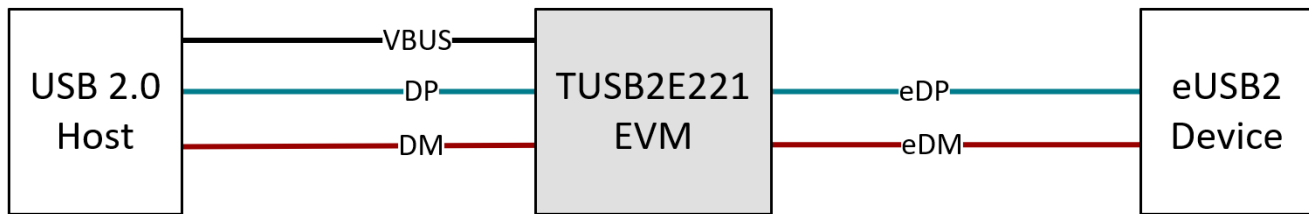

Figure 1-3. TUSB2E221EVM Bus-powered Peripheral Repeater Diagram

A 5V power source can also be provided by the USB bus. When VBUS is used to power the EVM, VBUS is referred to a *bus-powered* application. An eUSB device is still attached to the eUSB port of the TUSB2E221EVM, so the EVM must be configured as a peripheral repeater.

1.4 Device Information

The TUSB2E221EVM is designed to support the TUSB2E221 eUSB repeater in either eUSB host or peripheral applications. Various headers are located on the EVM with prepopulated headers to support configuring the TUSB2E221.

Two LDOs are also present on the TUSB2E221EVM to generate the 3.3V and 1.8V supplies to the TUSB2E221. The TPS73633 steps down the 5V supply to 3.3V to provide power to the TUSB2E221 as well as the TPS73601. The TPS73601 uses the 3.3V supply and steps down the voltage further to 1.8V again for the TUSB2E221 supply and the I/O input voltage used for configuration.

2 Hardware

2.1 Getting Started

Evaluation of the TUSB2E221EVM requires a 5V power source, a USB connection, and an eUSB2 connection. This section assumes that the TUSB2E221EVM jumpers are in placed in the default state as described in [Table 2-1](#).

Table 2-1. TUSB2E221EVM Default Jumper Configuration

Designator	Default Position	Description
J1	1-2	VBUS to J5 micro-USB Port A connector
J3	1-2	5V Rail and DC Jack to VBUS
J4	N/A	I2C interface
J6	N/A	VBUS to J10 micro-USB Port B connector
J7	2-3	EQ1 low
J12	2-3	EQ0 low
J14	1-2	5V input to 3.3V LDO
J15	1-2	1.8V supply rail to 1.8V IO rail
J16	1-2	1.8V LDO output to 1.8V supply rail
J17	1-2	3.3V supply rail to 1.8V LDO
J18	N/A	EQ2 floating
J19	1-2	I2C SDA pullup resistor
J20	1-2	I2C SCL pullup resistor
SW1	2-1 (Left)	Set in 2-1 position (left)
SW3	2-3 (Top)	Set in 2-3 position (top)

The following test procedure describes how to integrate the EVM into a eUSB system and begin evaluation. Before getting started, make sure that power is not supplied to the system and proper ESD protective measures are in place.

1. **Connect to eUSB Port 0-** The TUSB2E221EVM has two eUSB ports to connect to an eUSB host or device via SMP cable. The eUSB host or device is responsible for configuring TUSB2E221 through the eUSB interface as described in [Section 1.3](#).
2. **Connect to USB Port A** - The two micro-AB USB ports on the EVM connect to a USB host or device. If the TUSB2E221 was configured as a device repeater in step 1, then attach a USB host to USB Port A. If configured as a host, then attach a USB device.
3. **Provide 5V power to the EVM** - There are multiple ways to provide 5V to the EVM. For more information on the various power modes refer to section [Section 2.2.1](#).
4. **Power on the system, or issue a reset** - After power-on, the eUSB host or device automatically configures the repeater and establish a connection through the eUSB and USB interfaces. The TUSB2E221EVM also incorporates an external reset push button in addition to a regular power reset circuit.

2.2 EVM Configuration

There are many ways to configure the TUSB2E221EVM to fit various applications. The power supply can be external or provided by VBUS. The GPIO pins and I2C interface of the TUSB2E221 allow for configuration of signal conditioning settings. I2C mode is enabled by default on the EVM through the jumpers installed on J19 and J20. To access the I2C interface, attach a 1.8V I2C controller to the SDA, SCL and GND pins on header J4. The 7-bit I2C target address is 0x4F.

Note

Rev A. of the TUSB2E221EVM has SCL and SDA reversed from what is shown in the schematic. SCL is pin 1 of J4, and SDA is pin 2.

2.2.1 Power Modes

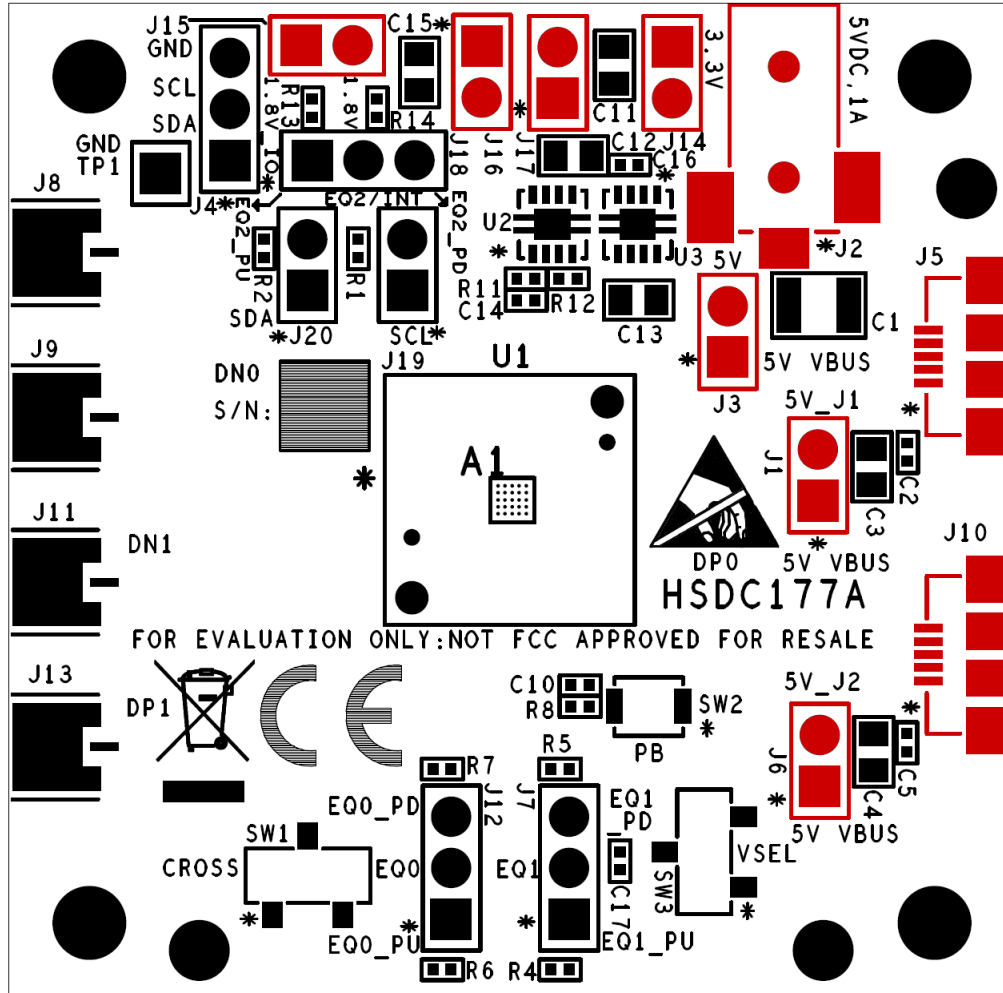

Figure 2-1. TUSB2E221EVM Power Configuration Overview

The TUSB2E221 requires two supply voltages during normal operation. The 3.3V and 1.8V supply can be provided directly from an external source on pin 1 of the J14 and J16 headers. The TUSB2E221EVM also includes two onboard LDOs which generate 3.3V and 1.8V from a 5V power supply. The 5V supply can be provided through the micro-AB USB connectors, or provided via a 5V wall power supply.

2.2.1.1 Self-Powered Configuration

The TUSB2E221EVM 5V power supply can be provided from a DC power supply provided by CUI, Digikey# 102-3584-N, or similar.

External Power Supply or Power Accessory Requirements:

Nom Output Voltage: 5 VDC

Max Output Current: 3000mA

Efficiency Level CoC Tier 2

Before providing power to the EVM, make sure that 5V is not already being provided to the EVM through the USB bus. Configure the EVM jumpers as shown in [Table 2-2](#) to disable bus-power and enable wall power.

Table 2-2. EVM Wall Power Configuration

Designator	Installed	Description
J1	No	VBUS to J5 micro-USB Port A connector
J3	Yes	5V Rail and DC Jack to VBUS
J6	No	VBUS to J10 micro-USB Port B connector
J14	Yes	5V input to 3.3V LDO
J15	Yes	1.8V supply rail to 1.8V IO rail
J16	Yes	1.8V LDO output to 1.8V supply rail
J17	Yes	3.3V supply rail to 1.8V LDO

After configuring the EVM, plug the DC adapter into the DC jack at J2 on the EVM. Using this method to provide power is useful while the TUSB2E221 is configured as either a self-powered device or a host.

2.2.1.2 Bus-powered Configuration

When VBUS is provided through the micro-USB connector, the TUSB2E221EVM does not require an external 5V supply. Make sure that 5V is not already being provided to the EVM through other sources by configuring the EVM headers as shown in [Table 2-3](#).

Table 2-3. EVM Bus Power Configuration

Designator	Installed	Description
J1	Yes	VBUS to J5 micro-USB Port A connector
J3	No	5V Rail and DC Jack to VBUS
J6	Yes	VBUS to J10 micro-USB Port B connector
J14	Yes	5V input to 3.3V LDO
J15	Yes	1.8V supply rail to 1.8V IO rail
J16	Yes	1.8V LDO output to 1.8V supply rail
J17	Yes	3.3V supply rail to 1.8V LDO

After configuring the EVM, plug the USB host into either the J1 or J6 micro-USB connector. Using this method to provide power is useful while the TUSB2E221 is configured as a bus-powered device.

2.2.1.3 External Power

Alternately to providing a 5V power source to the TUSB2E221EVM, a 3.3V and 1.8V power supply can be provided directly to the TUSB2E221 device.

Before providing power to the EVM, make sure that power is not already being provided through the USB bus or DC power jack. Configure the EVM jumpers as shown in [Table 2-4](#) to disable the 3.3V and 1.8V LDOs and allow direct external power.

Table 2-4. EVM External Power Configuration

Designator	Installed	Description
J1	No	VBUS to J5 micro-USB Port A connector
J3	No	5V Rail and DC Jack to VBUS
J6	No	VBUS to J10 micro-USB Port B connector
J14	No	5V input to 3.3V LDO
J15	Yes	1.8V supply rail to 1.8V IO rail
J16	No	1.8V LDO output to 1.8V supply rail
J17	No	3.3V supply rail to 1.8V LDO

After configuring the EVM, attach the 3.3V power supply to pin 1 of J14, and attach 1.8V pin 1 of J16. Using this method to provide power is useful when evaluating the power consumption of the TUSB2E221. Current and voltage measurements can be made on the 3.3V and 1.8V rails provided to the EVM.

2.2.2 Functional Modes

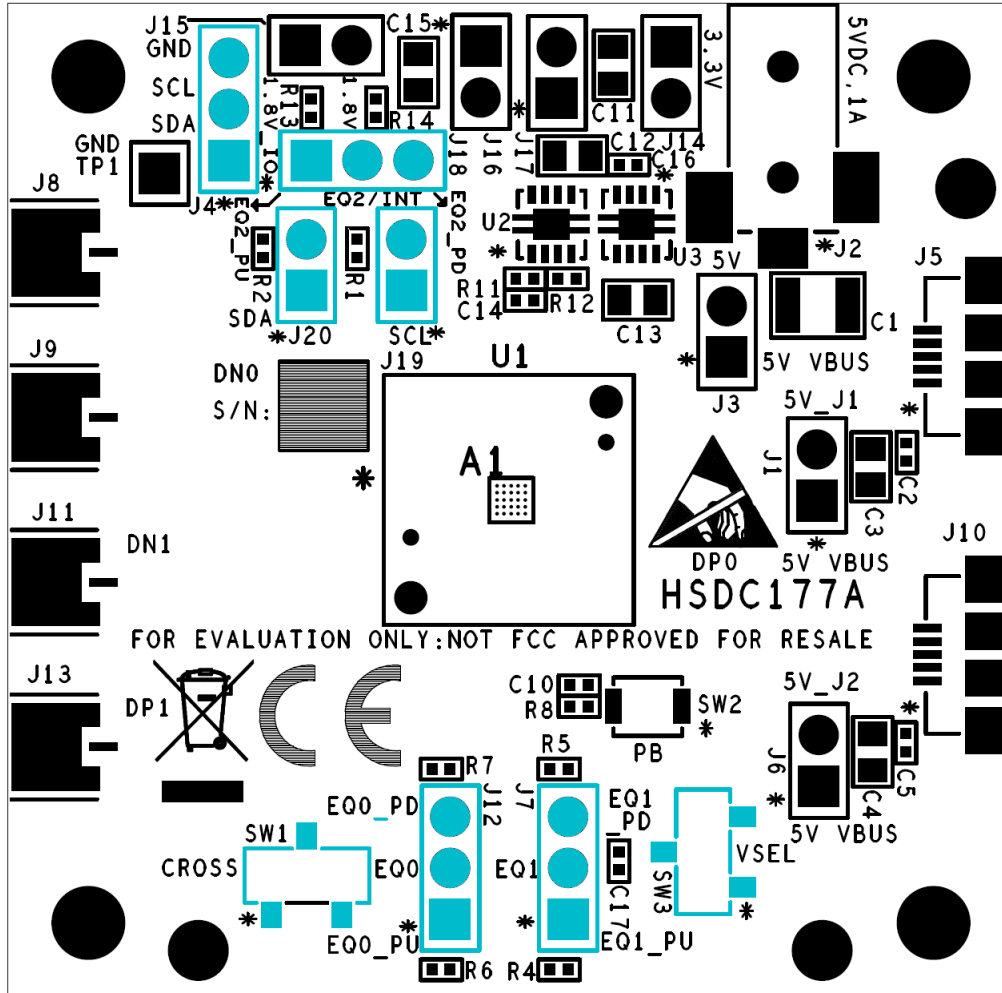

Figure 2-2. TUSB2E221EVM Configuration Overview

The TUSB2E221 has 3 functional modes, I2C-enabled, GPIO, and UART. Figure 2-2 show the locations of each header and switch used to configure the TUSB2E221.

2.2.2.1 I2C-Enabled Repeater Mode

In I2C-enabled repeater mode, the EVM can be configured through register settings. EQ0 and EQ1 must be set high. When set low, the repeater is configured for UART mode and does not forward eUSB or USB packages.

Table 2-5. I2C-enabled Repeater Mode Jumper Configuration

Designator	Jumper Position	Description
J7	2-3	EQ1 set low
J12	2-3	EQ0 set low
J19	1-2	SDA pulled high via 1Kohm resistor
J20	1-2	SLC pulled high via 1Kohm resistor

2.2.2.2 GPIO Repeater Mode

In GPIO repeater mode, the I2C interface is disabled, and signal conditioning settings can be set by modifying the EQ0, EQ1, and EQ2 pins. These pins are sampled at startup.

Table 2-6. GPIO Repeater Mode Jumper Configuration

Designator	Jumper Position	Description
J7	N/A	Set EQ1 to desired signal conditioning settings.
J12	N/A	Set EQ0 to desired signal conditioning settings.
J19	N/A	Do not populate jumper, SDA floating.
J20	N/A	Do not populate jumper, SCL floating.

2.2.2.3 UART Mode

In UART mode, the TUSB2E11 acts a 3.3V to 1.2V level shifter to support in-system debug. UART mode can be set per-port as described in the TUSB2E221 data sheet. In the configuration below, both eUSB-USB ports are set to UART mode.

Table 2-7. UART mode jumper configuration

Designator	Jumper Position	Description
J7	1-2	EQ1 set high
J12	1-2	EQ0 set high
J19	1-2	SDA pulled high via 1Kohm resistor
J20	1-2	SLC pulled high via 1Kohm resistor

2.2.3 I/O and Interrupts

After the TUSB2E221 has been configured into I2C mode, the EQ0, EQ1, and EQ2/INT pins become programmable I/O pins. These can be useful in situations where system debug is necessary, or side-band signaling is needed.

The TUSB2E221 can be configured to use either 1.8V or 1.2V I/O voltages. SW2 on the EVM controls the VIOSEL pin. To modify the signaling refer to [Table 2-8](#). Changing this setting modifies the threshold voltage of the EQ0, EQ1, EQ2/INT, SCL and SDA pins.

Table 2-8. TUSB2E221EVM I/O Voltage Switch

SW3 position	I/O voltage
1-2 (bottom)	1.2V
2-3 (top)	1.8V

The TUSB2E221 also has a cross-point mux which allows the eUSB-USB signal path to between Port 0 of the eUSB port to Port 0 of the USB port as shown in [Table 2-9](#).

Table 2-9. TUSB2E221EVM Mux Configuration

SW1 position	eUSB/USB port mapping
1-2 (left)	eUSB0->USBA eUSB1->USBB
2-3 (right)	eUSB0->USBB eUSB1->USBA

3 Hardware Design Files

3.1 Schematic

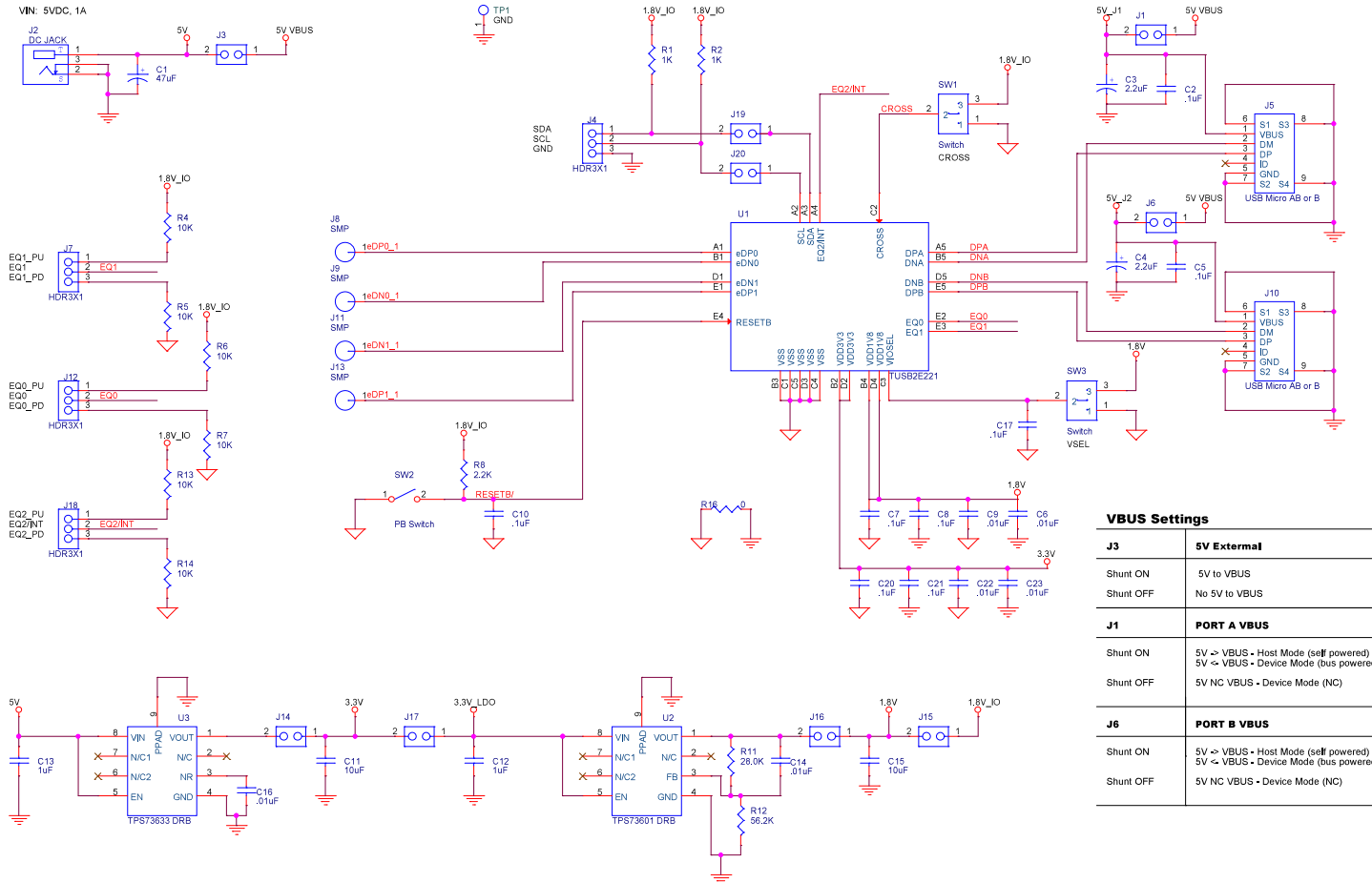

VBUS Settings

J3	5V External
Shunt ON	5V to VBUS
Shunt OFF	No 5V to VBUS
J1	PORT A VBUS
Shunt ON	5V → VBUS - Host Mode (self powered)
Shunt OFF	5V ← VBUS - Device Mode (bus powered)
Shunt OFF	5V NC VBUS - Device Mode (NC)
J6	PORT B VBUS
Shunt ON	5V → VBUS - Host Mode (self powered)
Shunt OFF	5V ← VBUS - Device Mode (bus powered)
Shunt OFF	5V NC VBUS - Device Mode (NC)

Figure 3-1. TUSB2E221EVM Schematic

3.2 Board Layout

The TUSB2E221EVM was laid out with the following considerations:

- USB 2.0 signals impedance controlled 90Ω differential $\pm 5\%$.
- eUSB2 signals impedance controlled 45Ω signal ended $\pm 5\%$.
- USB 2.0 and eUSB2 signal pairs routed with matched trace lengths and minimal vias.
- All other signals to be impedance controlled $45\Omega \pm 10\%$ or $50\Omega \pm 10\%$.

General information about the PCB is provided below:

- Finished board thickness: $.062 \pm 10\%$ – necessary for socket
- Copper weight: 1oz start internal, 1/2 oz start external
- Laminate material: FR4 Polyclad 370 or equivalent

A four layer stack-up was used for the TUSB2E221EVM.

Drill notes on board stack up to account for the small BGA breakout:

1. L1 – L2 (laser drill) used for small pitch BGA break out.
2. L2 – L3 (mechanical drill) completes the small pitch BGA breakout.
3. L3 – L4 (laser drill) for VPP.

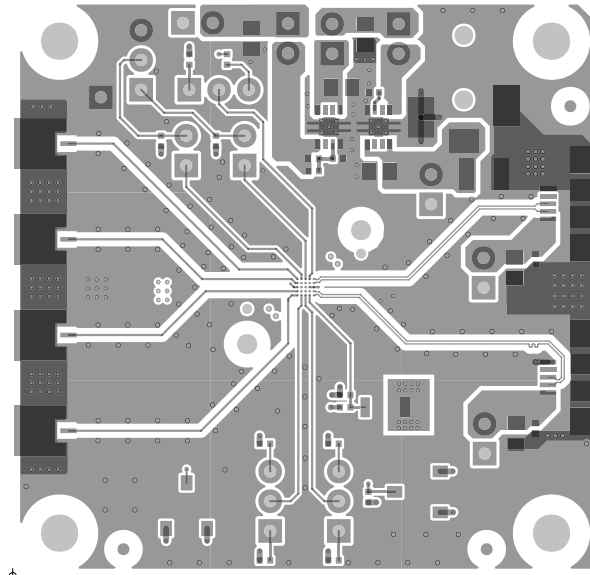

Figure 3-2. TUSB2E221EVM PCB Top Layer

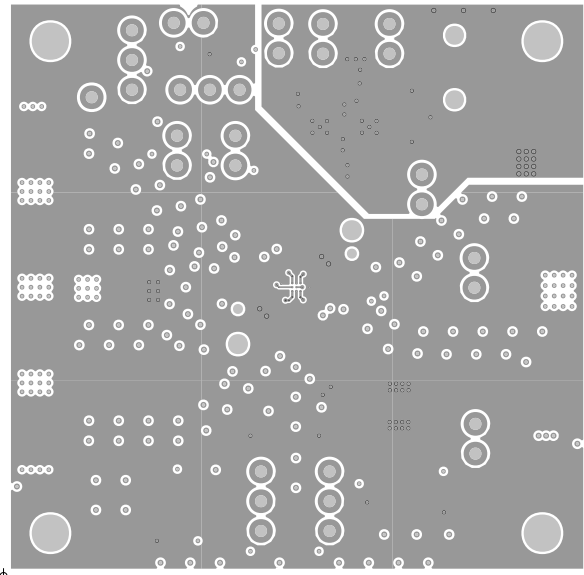

Figure 3-3. TUSB2E221EVM PCB Layer 2 (Ground Plane)

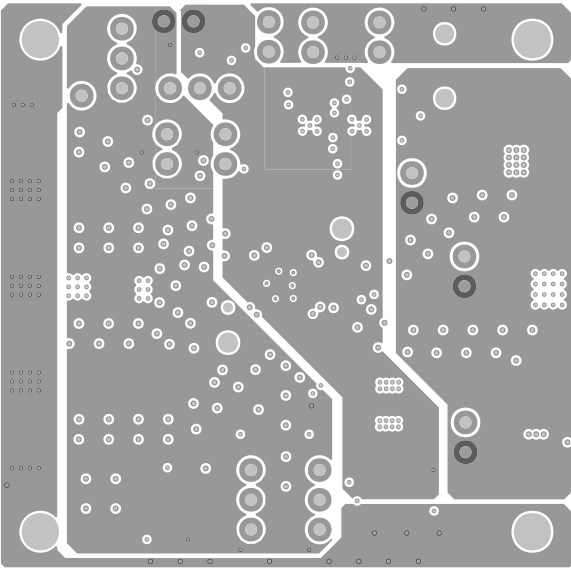

Figure 3-4. TUSB2E221EVM PCB Layer 3 (Power Plane)

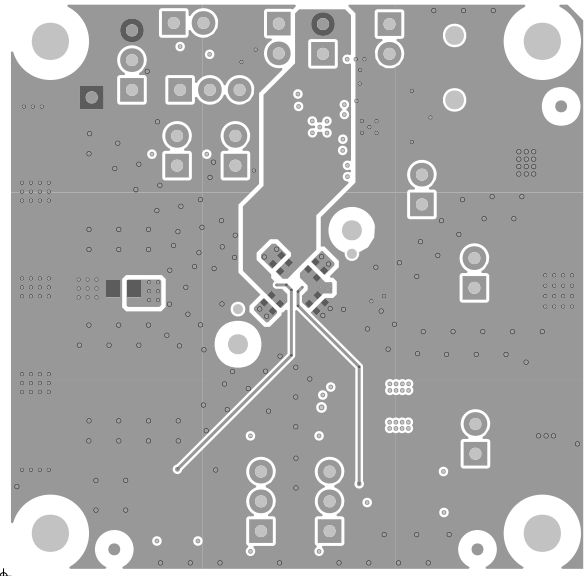

Figure 3-5. TUSB2E221EVM Layer 4 (Bottom)

3.3 Bill of Materials

The default devices installed on the TUSB2E221EVM are listed in this section.

Table 3-1. Bill of Materials

DESIGNATOR	QTY	VALUE	PART NUMBER	MANUFACTURER
C1	1	47uF	C3225X5R1A476M250AC	TDK
C2,C5,C7,C8,C10,C17,C20,C21	8	.1uF	CC0402KRX5R6BB104	Yageo
C3,C4	2	2.2uF	CGA4J3X7R1C225K125AB	TDK
C6,C9,C14,C16,C22,C23	6	.01uF	C0402C103K3RAC7867	Kemet
C11,C15	2	10uF	C0805C106K8PAC7800	Kemet
C12,C13	2	1uF	C0805C105K4RAC7800	Kemet
J1,J3,J6,J14,J15,J16,J17,J19,J20	9	HDR2X1	PEC02SAAN	Sullins
J2	1	DC JACK	PJ1-022-SMT-TR	CUI
J4,J7,J12,J18	4	HDR3X1	PEC03SAAN	Sullins
J5,J10	2	USB Micro AB or B	10104111-0001LF	Amphenol FCI
J8,J9,J11,J13	4	SMP	19S201-40ML5	Rosenberger
PCB1	1	HSDC177	HSDC124	Any
R1,R2	2	1K	RT0402BRE071KL	Yageo
R4,R5,R6,R7,R13,R14	6	10K	RC0402JR-0710KL	Yageo
R8	1	2.2K	RC0402FR-072K2L	Yageo
R11	1	28.0K	RC0402FR-0728KL	Yageo
R12	1	56.2K	RT0402BRD0756K2L	Yageo
R16	1	0	RC0805JR-070RL	Yageo
SCRW1,SCRW2,SCRW3,SCRW4	4	NY PMS 440 005 PH	NY PMS 440 0050 PH	B&F Fastener
SHNT1,SHNT2,SHNT3,SHNT4,SHNT5,SHNT6,SHNT7,SHNT8	8	QPC02SXGN-RC	QPC02SXGN-RC	Sullins
STDOFF1,STDOFF2,STDOFF3,STDOFF4	4	1902E	1902E	Keystone
SW1,SW3	2	Switch	CJS-1201TB	Nidec Copal
SW2	1	PB Switch	B3U-1000P	OMRON
TP1	1	TEST POINT	PEC01SAAN	Sullins
U1	1	TUSB2E221	TUSB2E2211001YCGR	Texas Instruments
U2	1	TPS73601 DRB	TPS73601DRBR	Texas Instruments
U3	1	TPS73633 DRB	TPS73633DRBR	Texas Instruments

4 Additional Information

4.1 Trademarks

All trademarks are the property of their respective owners.

STANDARD TERMS FOR EVALUATION MODULES

1. *Delivery:* TI delivers TI evaluation boards, kits, or modules, including any accompanying demonstration software, components, and/or documentation which may be provided together or separately (collectively, an "EVM" or "EVMs") to the User ("User") in accordance with the terms set forth herein. User's acceptance of the EVM is expressly subject to the following terms.
 - 1.1 EVMs are intended solely for product or software developers for use in a research and development setting to facilitate feasibility evaluation, experimentation, or scientific analysis of TI semiconductors products. EVMs have no direct function and are not finished products. EVMs shall not be directly or indirectly assembled as a part or subassembly in any finished product. For clarification, any software or software tools provided with the EVM ("Software") shall not be subject to the terms and conditions set forth herein but rather shall be subject to the applicable terms that accompany such Software
 - 1.2 EVMs are not intended for consumer or household use. EVMs may not be sold, sublicensed, leased, rented, loaned, assigned, or otherwise distributed for commercial purposes by Users, in whole or in part, or used in any finished product or production system.
2. *Limited Warranty and Related Remedies/Disclaimers:*
 - 2.1 These terms do not apply to Software. The warranty, if any, for Software is covered in the applicable Software License Agreement.
 - 2.2 TI warrants that the TI EVM will conform to TI's published specifications for ninety (90) days after the date TI delivers such EVM to User. Notwithstanding the foregoing, TI shall not be liable for a nonconforming EVM if (a) the nonconformity was caused by neglect, misuse or mistreatment by an entity other than TI, including improper installation or testing, or for any EVMs that have been altered or modified in any way by an entity other than TI, (b) the nonconformity resulted from User's design, specifications or instructions for such EVMs or improper system design, or (c) User has not paid on time. Testing and other quality control techniques are used to the extent TI deems necessary. TI does not test all parameters of each EVM. User's claims against TI under this Section 2 are void if User fails to notify TI of any apparent defects in the EVMs within ten (10) business days after delivery, or of any hidden defects with ten (10) business days after the defect has been detected.
 - 2.3 TI's sole liability shall be at its option to repair or replace EVMs that fail to conform to the warranty set forth above, or credit User's account for such EVM. TI's liability under this warranty shall be limited to EVMs that are returned during the warranty period to the address designated by TI and that are determined by TI not to conform to such warranty. If TI elects to repair or replace such EVM, TI shall have a reasonable time to repair such EVM or provide replacements. Repaired EVMs shall be warranted for the remainder of the original warranty period. Replaced EVMs shall be warranted for a new full ninety (90) day warranty period.

WARNING

Evaluation Kits are intended solely for use by technically qualified, professional electronics experts who are familiar with the dangers and application risks associated with handling electrical mechanical components, systems, and subsystems.

User shall operate the Evaluation Kit within TI's recommended guidelines and any applicable legal or environmental requirements as well as reasonable and customary safeguards. Failure to set up and/or operate the Evaluation Kit within TI's recommended guidelines may result in personal injury or death or property damage. Proper set up entails following TI's instructions for electrical ratings of interface circuits such as input, output and electrical loads.

NOTE:

EXPOSURE TO ELECTROSTATIC DISCHARGE (ESD) MAY CAUSE DEGRADATION OR FAILURE OF THE EVALUATION KIT; TI RECOMMENDS STORAGE OF THE EVALUATION KIT IN A PROTECTIVE ESD BAG.

3 Regulatory Notices:

3.1 United States

3.1.1 Notice applicable to EVMs not FCC-Approved:

FCC NOTICE: This kit is designed to allow product developers to evaluate electronic components, circuitry, or software associated with the kit to determine whether to incorporate such items in a finished product and software developers to write software applications for use with the end product. This kit is not a finished product and when assembled may not be resold or otherwise marketed unless all required FCC equipment authorizations are first obtained. Operation is subject to the condition that this product not cause harmful interference to licensed radio stations and that this product accept harmful interference. Unless the assembled kit is designed to operate under part 15, part 18 or part 95 of this chapter, the operator of the kit must operate under the authority of an FCC license holder or must secure an experimental authorization under part 5 of this chapter.

3.1.2 For EVMs annotated as FCC – FEDERAL COMMUNICATIONS COMMISSION Part 15 Compliant:

CAUTION

This device complies with part 15 of the FCC Rules. Operation is subject to the following two conditions: (1) This device may not cause harmful interference, and (2) this device must accept any interference received, including interference that may cause undesired operation.

Changes or modifications not expressly approved by the party responsible for compliance could void the user's authority to operate the equipment.

FCC Interference Statement for Class A EVM devices

NOTE: This equipment has been tested and found to comply with the limits for a Class A digital device, pursuant to part 15 of the FCC Rules. These limits are designed to provide reasonable protection against harmful interference when the equipment is operated in a commercial environment. This equipment generates, uses, and can radiate radio frequency energy and, if not installed and used in accordance with the instruction manual, may cause harmful interference to radio communications. Operation of this equipment in a residential area is likely to cause harmful interference in which case the user will be required to correct the interference at his own expense.

FCC Interference Statement for Class B EVM devices

NOTE: This equipment has been tested and found to comply with the limits for a Class B digital device, pursuant to part 15 of the FCC Rules. These limits are designed to provide reasonable protection against harmful interference in a residential installation. This equipment generates, uses and can radiate radio frequency energy and, if not installed and used in accordance with the instructions, may cause harmful interference to radio communications. However, there is no guarantee that interference will not occur in a particular installation. If this equipment does cause harmful interference to radio or television reception, which can be determined by turning the equipment off and on, the user is encouraged to try to correct the interference by one or more of the following measures:

- Reorient or relocate the receiving antenna.
- Increase the separation between the equipment and receiver.
- Connect the equipment into an outlet on a circuit different from that to which the receiver is connected.
- Consult the dealer or an experienced radio/TV technician for help.

3.2 Canada

3.2.1 For EVMs issued with an Industry Canada Certificate of Conformance to RSS-210 or RSS-247

Concerning EVMs Including Radio Transmitters:

This device complies with Industry Canada license-exempt RSSs. Operation is subject to the following two conditions:

(1) this device may not cause interference, and (2) this device must accept any interference, including interference that may cause undesired operation of the device.

Concernant les EVMs avec appareils radio:

Le présent appareil est conforme aux CNR d'Industrie Canada applicables aux appareils radio exempts de licence. L'exploitation est autorisée aux deux conditions suivantes: (1) l'appareil ne doit pas produire de brouillage, et (2) l'utilisateur de l'appareil doit accepter tout brouillage radioélectrique subi, même si le brouillage est susceptible d'en compromettre le fonctionnement.

Concerning EVMs Including Detachable Antennas:

Under Industry Canada regulations, this radio transmitter may only operate using an antenna of a type and maximum (or lesser) gain approved for the transmitter by Industry Canada. To reduce potential radio interference to other users, the antenna type and its gain should be so chosen that the equivalent isotropically radiated power (e.i.r.p.) is not more than that necessary for successful communication. This radio transmitter has been approved by Industry Canada to operate with the antenna types listed in the user guide with the maximum permissible gain and required antenna impedance for each antenna type indicated. Antenna types not included in this list, having a gain greater than the maximum gain indicated for that type, are strictly prohibited for use with this device.

Concernant les EVMs avec antennes détachables

Conformément à la réglementation d'Industrie Canada, le présent émetteur radio peut fonctionner avec une antenne d'un type et d'un gain maximal (ou inférieur) approuvé pour l'émetteur par Industrie Canada. Dans le but de réduire les risques de brouillage radioélectrique à l'intention des autres utilisateurs, il faut choisir le type d'antenne et son gain de sorte que la puissance isotrope rayonnée équivalente (p.i.r.e.) ne dépasse pas l'intensité nécessaire à l'établissement d'une communication satisfaisante. Le présent émetteur radio a été approuvé par Industrie Canada pour fonctionner avec les types d'antenne énumérés dans le manuel d'usage et ayant un gain admissible maximal et l'impédance requise pour chaque type d'antenne. Les types d'antenne non inclus dans cette liste, ou dont le gain est supérieur au gain maximal indiqué, sont strictement interdits pour l'exploitation de l'émetteur.

3.3 Japan

3.3.1 *Notice for EVMs delivered in Japan:* Please see http://www.tij.co.jp/lstds/ti_ja/general/eStore/notice_01.page 日本国内に輸入される評価用キット、ボードについては、次のところをご覧ください。

<https://www.ti.com/ja-jp/legal/notice-for-evaluation-kits-delivered-in-japan.html>

3.3.2 *Notice for Users of EVMs Considered "Radio Frequency Products" in Japan:* EVMs entering Japan may not be certified by TI as conforming to Technical Regulations of Radio Law of Japan.

If User uses EVMs in Japan, not certified to Technical Regulations of Radio Law of Japan, User is required to follow the instructions set forth by Radio Law of Japan, which includes, but is not limited to, the instructions below with respect to EVMs (which for the avoidance of doubt are stated strictly for convenience and should be verified by User):

1. Use EVMs in a shielded room or any other test facility as defined in the notification #173 issued by Ministry of Internal Affairs and Communications on March 28, 2006, based on Sub-section 1.1 of Article 6 of the Ministry's Rule for Enforcement of Radio Law of Japan,
2. Use EVMs only after User obtains the license of Test Radio Station as provided in Radio Law of Japan with respect to EVMs, or
3. Use of EVMs only after User obtains the Technical Regulations Conformity Certification as provided in Radio Law of Japan with respect to EVMs. Also, do not transfer EVMs, unless User gives the same notice above to the transferee. Please note that if User does not follow the instructions above, User will be subject to penalties of Radio Law of Japan.

【無線電波を送信する製品の開発キットをお使いになる際の注意事項】 開発キットの中には技術基準適合証明を受けていないものがあります。技術適合証明を受けていないものご使用に際しては、電波法遵守のため、以下のいずれかの措置を取っていただく必要がありますのでご注意ください。

1. 電波法施行規則第6条第1項第1号に基づく平成18年3月28日総務省告示第173号で定められた電波暗室等の試験設備でご使用いただく。
2. 実験局の免許を取得後ご使用いただく。
3. 技術基準適合証明を取得後ご使用いただく。

なお、本製品は、上記の「ご使用にあたっての注意」を譲渡先、移転先に通知しない限り、譲渡、移転できないものとします。

上記を遵守頂けない場合は、電波法の罰則が適用される可能性があることをご留意ください。日本テキサス・イ

ンスツルメンツ株式会社

東京都新宿区西新宿 6 丁目 2 4 番 1 号

西新宿三井ビル

3.3.3 *Notice for EVMs for Power Line Communication:* Please see http://www.tij.co.jp/lstds/ti_ja/general/eStore/notice_02.page

電力線搬送波通信についての開発キットをお使いになる際の注意事項については、次のところをご覧ください。 <https://www.ti.com/ja-jp/legal/notice-for-evaluation-kits-for-power-line-communication.html>

3.4 European Union

3.4.1 *For EVMs subject to EU Directive 2014/30/EU (Electromagnetic Compatibility Directive):*

This is a class A product intended for use in environments other than domestic environments that are connected to a low-voltage power-supply network that supplies buildings used for domestic purposes. In a domestic environment this product may cause radio interference in which case the user may be required to take adequate measures.

-
- 4 *EVM Use Restrictions and Warnings:*
 - 4.1 EVMS ARE NOT FOR USE IN FUNCTIONAL SAFETY AND/OR SAFETY CRITICAL EVALUATIONS, INCLUDING BUT NOT LIMITED TO EVALUATIONS OF LIFE SUPPORT APPLICATIONS.
 - 4.2 User must read and apply the user guide and other available documentation provided by TI regarding the EVM prior to handling or using the EVM, including without limitation any warning or restriction notices. The notices contain important safety information related to, for example, temperatures and voltages.
 - 4.3 *Safety-Related Warnings and Restrictions:*
 - 4.3.1 User shall operate the EVM within TI's recommended specifications and environmental considerations stated in the user guide, other available documentation provided by TI, and any other applicable requirements and employ reasonable and customary safeguards. Exceeding the specified performance ratings and specifications (including but not limited to input and output voltage, current, power, and environmental ranges) for the EVM may cause personal injury or death, or property damage. If there are questions concerning performance ratings and specifications, User should contact a TI field representative prior to connecting interface electronics including input power and intended loads. Any loads applied outside of the specified output range may also result in unintended and/or inaccurate operation and/or possible permanent damage to the EVM and/or interface electronics. Please consult the EVM user guide prior to connecting any load to the EVM output. If there is uncertainty as to the load specification, please contact a TI field representative. During normal operation, even with the inputs and outputs kept within the specified allowable ranges, some circuit components may have elevated case temperatures. These components include but are not limited to linear regulators, switching transistors, pass transistors, current sense resistors, and heat sinks, which can be identified using the information in the associated documentation. When working with the EVM, please be aware that the EVM may become very warm.
 - 4.3.2 EVMs are intended solely for use by technically qualified, professional electronics experts who are familiar with the dangers and application risks associated with handling electrical mechanical components, systems, and subsystems. User assumes all responsibility and liability for proper and safe handling and use of the EVM by User or its employees, affiliates, contractors or designees. User assumes all responsibility and liability to ensure that any interfaces (electronic and/or mechanical) between the EVM and any human body are designed with suitable isolation and means to safely limit accessible leakage currents to minimize the risk of electrical shock hazard. User assumes all responsibility and liability for any improper or unsafe handling or use of the EVM by User or its employees, affiliates, contractors or designees.
 - 4.4 User assumes all responsibility and liability to determine whether the EVM is subject to any applicable international, federal, state, or local laws and regulations related to User's handling and use of the EVM and, if applicable, User assumes all responsibility and liability for compliance in all respects with such laws and regulations. User assumes all responsibility and liability for proper disposal and recycling of the EVM consistent with all applicable international, federal, state, and local requirements.
 5. *Accuracy of Information:* To the extent TI provides information on the availability and function of EVMs, TI attempts to be as accurate as possible. However, TI does not warrant the accuracy of EVM descriptions, EVM availability or other information on its websites as accurate, complete, reliable, current, or error-free.
 6. *Disclaimers:*
 - 6.1 EXCEPT AS SET FORTH ABOVE, EVMS AND ANY MATERIALS PROVIDED WITH THE EVM (INCLUDING, BUT NOT LIMITED TO, REFERENCE DESIGNS AND THE DESIGN OF THE EVM ITSELF) ARE PROVIDED "AS IS" AND "WITH ALL FAULTS." TI DISCLAIMS ALL OTHER WARRANTIES, EXPRESS OR IMPLIED, REGARDING SUCH ITEMS, INCLUDING BUT NOT LIMITED TO ANY EPIDEMIC FAILURE WARRANTY OR IMPLIED WARRANTIES OF MERCHANTABILITY OR FITNESS FOR A PARTICULAR PURPOSE OR NON-INFRINGEMENT OF ANY THIRD PARTY PATENTS, COPYRIGHTS, TRADE SECRETS OR OTHER INTELLECTUAL PROPERTY RIGHTS.
 - 6.2 EXCEPT FOR THE LIMITED RIGHT TO USE THE EVM SET FORTH HEREIN, NOTHING IN THESE TERMS SHALL BE CONSTRUED AS GRANTING OR CONFERRING ANY RIGHTS BY LICENSE, PATENT, OR ANY OTHER INDUSTRIAL OR INTELLECTUAL PROPERTY RIGHT OF TI, ITS SUPPLIERS/LICENSORS OR ANY OTHER THIRD PARTY, TO USE THE EVM IN ANY FINISHED END-USER OR READY-TO-USE FINAL PRODUCT, OR FOR ANY INVENTION, DISCOVERY OR IMPROVEMENT, REGARDLESS OF WHEN MADE, CONCEIVED OR ACQUIRED.
 7. *USER'S INDEMNITY OBLIGATIONS AND REPRESENTATIONS.* USER WILL DEFEND, INDEMNIFY AND HOLD TI, ITS LICENSORS AND THEIR REPRESENTATIVES HARMLESS FROM AND AGAINST ANY AND ALL CLAIMS, DAMAGES, LOSSES, EXPENSES, COSTS AND LIABILITIES (COLLECTIVELY, "CLAIMS") ARISING OUT OF OR IN CONNECTION WITH ANY HANDLING OR USE OF THE EVM THAT IS NOT IN ACCORDANCE WITH THESE TERMS. THIS OBLIGATION SHALL APPLY WHETHER CLAIMS ARISE UNDER STATUTE, REGULATION, OR THE LAW OF TORT, CONTRACT OR ANY OTHER LEGAL THEORY, AND EVEN IF THE EVM FAILS TO PERFORM AS DESCRIBED OR EXPECTED.

8. *Limitations on Damages and Liability:*

8.1 *General Limitations.* IN NO EVENT SHALL TI BE LIABLE FOR ANY SPECIAL, COLLATERAL, INDIRECT, PUNITIVE, INCIDENTAL, CONSEQUENTIAL, OR EXEMPLARY DAMAGES IN CONNECTION WITH OR ARISING OUT OF THESE TERMS OR THE USE OF THE EVMS , REGARDLESS OF WHETHER TI HAS BEEN ADVISED OF THE POSSIBILITY OF SUCH DAMAGES. EXCLUDED DAMAGES INCLUDE, BUT ARE NOT LIMITED TO, COST OF REMOVAL OR REINSTALLATION, ANCILLARY COSTS TO THE PROCUREMENT OF SUBSTITUTE GOODS OR SERVICES, RETESTING, OUTSIDE COMPUTER TIME, LABOR COSTS, LOSS OF GOODWILL, LOSS OF PROFITS, LOSS OF SAVINGS, LOSS OF USE, LOSS OF DATA, OR BUSINESS INTERRUPTION. NO CLAIM, SUIT OR ACTION SHALL BE BROUGHT AGAINST TI MORE THAN TWELVE (12) MONTHS AFTER THE EVENT THAT GAVE RISE TO THE CAUSE OF ACTION HAS OCCURRED.

8.2 *Specific Limitations.* IN NO EVENT SHALL TI'S AGGREGATE LIABILITY FROM ANY USE OF AN EVM PROVIDED HEREUNDER, INCLUDING FROM ANY WARRANTY, INDEMNITY OR OTHER OBLIGATION ARISING OUT OF OR IN CONNECTION WITH THESE TERMS, , EXCEED THE TOTAL AMOUNT PAID TO TI BY USER FOR THE PARTICULAR EVM(S) AT ISSUE DURING THE PRIOR TWELVE (12) MONTHS WITH RESPECT TO WHICH LOSSES OR DAMAGES ARE CLAIMED. THE EXISTENCE OF MORE THAN ONE CLAIM SHALL NOT ENLARGE OR EXTEND THIS LIMIT.

9. *Return Policy.* Except as otherwise provided, TI does not offer any refunds, returns, or exchanges. Furthermore, no return of EVM(s) will be accepted if the package has been opened and no return of the EVM(s) will be accepted if they are damaged or otherwise not in a resalable condition. If User feels it has been incorrectly charged for the EVM(s) it ordered or that delivery violates the applicable order, User should contact TI. All refunds will be made in full within thirty (30) working days from the return of the components(s), excluding any postage or packaging costs.

10. *Governing Law:* These terms and conditions shall be governed by and interpreted in accordance with the laws of the State of Texas, without reference to conflict-of-laws principles. User agrees that non-exclusive jurisdiction for any dispute arising out of or relating to these terms and conditions lies within courts located in the State of Texas and consents to venue in Dallas County, Texas. Notwithstanding the foregoing, any judgment may be enforced in any United States or foreign court, and TI may seek injunctive relief in any United States or foreign court.

Mailing Address: Texas Instruments, Post Office Box 655303, Dallas, Texas 75265
Copyright © 2023, Texas Instruments Incorporated

IMPORTANT NOTICE AND DISCLAIMER

TI PROVIDES TECHNICAL AND RELIABILITY DATA (INCLUDING DATA SHEETS), DESIGN RESOURCES (INCLUDING REFERENCE DESIGNS), APPLICATION OR OTHER DESIGN ADVICE, WEB TOOLS, SAFETY INFORMATION, AND OTHER RESOURCES "AS IS" AND WITH ALL FAULTS, AND DISCLAIMS ALL WARRANTIES, EXPRESS AND IMPLIED, INCLUDING WITHOUT LIMITATION ANY IMPLIED WARRANTIES OF MERCHANTABILITY, FITNESS FOR A PARTICULAR PURPOSE OR NON-INFRINGEMENT OF THIRD PARTY INTELLECTUAL PROPERTY RIGHTS.

These resources are intended for skilled developers designing with TI products. You are solely responsible for (1) selecting the appropriate TI products for your application, (2) designing, validating and testing your application, and (3) ensuring your application meets applicable standards, and any other safety, security, regulatory or other requirements.

These resources are subject to change without notice. TI grants you permission to use these resources only for development of an application that uses the TI products described in the resource. Other reproduction and display of these resources is prohibited. No license is granted to any other TI intellectual property right or to any third party intellectual property right. TI disclaims responsibility for, and you will fully indemnify TI and its representatives against, any claims, damages, costs, losses, and liabilities arising out of your use of these resources.

TI's products are provided subject to [TI's Terms of Sale](#) or other applicable terms available either on [ti.com](https://www.ti.com) or provided in conjunction with such TI products. TI's provision of these resources does not expand or otherwise alter TI's applicable warranties or warranty disclaimers for TI products.

TI objects to and rejects any additional or different terms you may have proposed.

Mailing Address: Texas Instruments, Post Office Box 655303, Dallas, Texas 75265
Copyright © 2024, Texas Instruments Incorporated