

# LM5181 Bipolar + and - 18 V Output Design for Signal Chains in PLC Applications



## ABSTRACT

This application note describes a dual output design using the LM5181 PSR fly-back DC/DC converter. A dual isolated output voltage rail of + and - 18 V at up to 65 mA is provided from an input voltage of 16 V to 32 V. A bi-polar voltage rail is required for powering op-amps in many diverse signal chain applications.

## Table of Contents

<b>1 Introduction</b> .....	2
<b>2 Schematic</b> .....	3
<b>3 Test Results</b> .....	4
3.1 Cross-regulation.....	7
<b>4 Bill of Materials</b> .....	8
<b>5 References</b> .....	10

## List of Figures

Figure 2-1. Test Schematic.....	3
Figure 3-1. Efficiency.....	4
Figure 3-2. Positive Rail Output Voltage.....	4
Figure 3-3. Negative Rail Output Voltage.....	4
Figure 3-4. Switching Frequency.....	4
Figure 3-5. Load Transient.....	4
Figure 3-6. No Load Input Supply Current.....	4
Figure 3-7. Switch Node.....	5
Figure 3-8. Switch Node.....	5
Figure 3-9. Switch Node.....	5
Figure 3-10. Switch Node.....	5
Figure 3-11. Switch Node.....	5
Figure 3-12. Switch Node.....	5
Figure 3-13. Switch Node.....	6
Figure 3-14. Positive Output Voltage Ripple.....	6
Figure 3-15. Positive Output Voltage Ripple.....	6
Figure 3-16. Positive Output Voltage Ripple.....	6
Figure 3-17. Positive Rail Load Regulation.....	7
Figure 3-18. Negative Rail Load Regulation.....	7

## List of Tables

Table 1-1. Design Ratings.....	2
Table 1-2. Output Voltage Options.....	2
Table 4-1. Bill of Materials (BOM).....	8

## Trademarks

All trademarks are the property of their respective owners.

## 1 Introduction

This application report describes a dual output design using the LM5181 PSR fly-back DC/DC converter. A dual isolated output voltage rail of +/- 18 V at up to 65 mA is provided from an input voltage of 16 V to 32 V; see [Table 1-1](#) . A bi-polar voltage rail is required for powering op-amps in many diverse signal chain applications. The design was implemented by modifying a standard dual output LM5180-Q1 EVM, found here: [LM5180EVM\\_DUAL](#). Performance results, along with the schematic and BOM can be found within this report.

Although this design highlights the LM5181, other devices in this family can also be used, such as the LM5181-Q1, LM5180, and LM5180-Q1. Other common op-amp supply voltages are easily accommodated by making the changes shown in [Table 1-2](#). For precision, low noise applications, the [TPS7A39](#) dual LDO can be used as a post regulator.

**Table 1-1. Design Ratings**

Output Voltage	Input Voltage	Output Current
+/- 18 V	16 V to 32 V	65 mA (each rail)

**Table 1-2. Output Voltage Options**

Output Voltage	R6	R5
+/- 18 V	121 k $\Omega$	453 k $\Omega$
+/- 15 V	100 k $\Omega$	383 k $\Omega$
+/- 12 V	80.6 k $\Omega$	309 k $\Omega$

## 2 Schematic

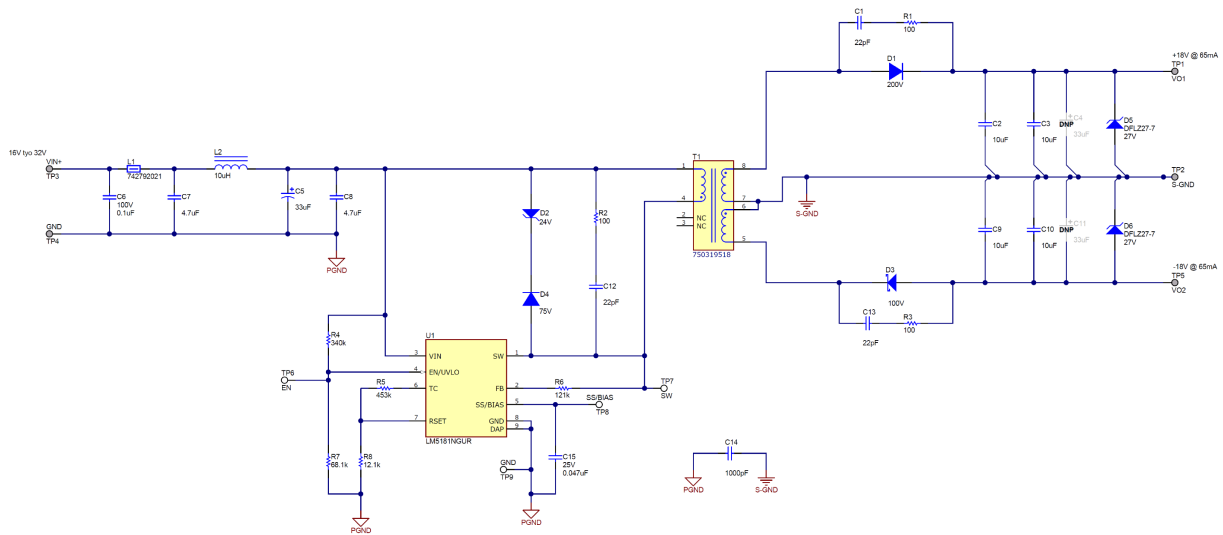


Figure 2-1. Test Schematic

### 3 Test Results

The data in the following graphs were taken with a common load connected between the positive and negative output voltage rails. Output current refers to the common load current. This data is valid for an ambient temperature of 25°C.

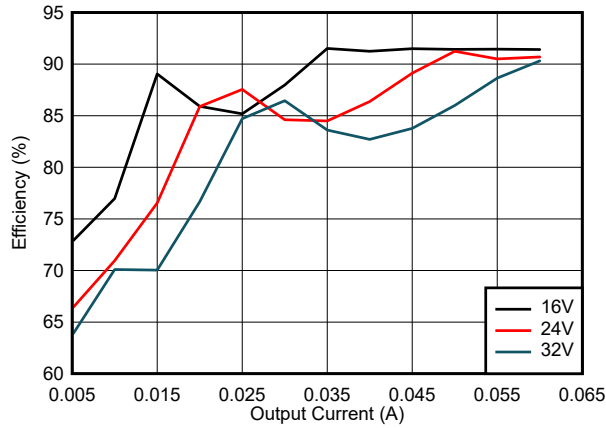


Figure 3-1. Efficiency

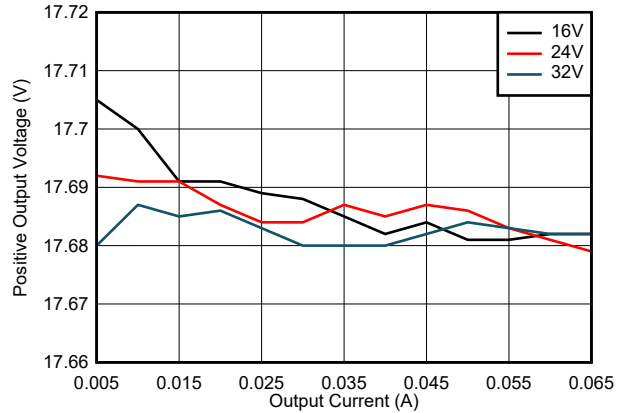


Figure 3-2. Positive Rail Output Voltage

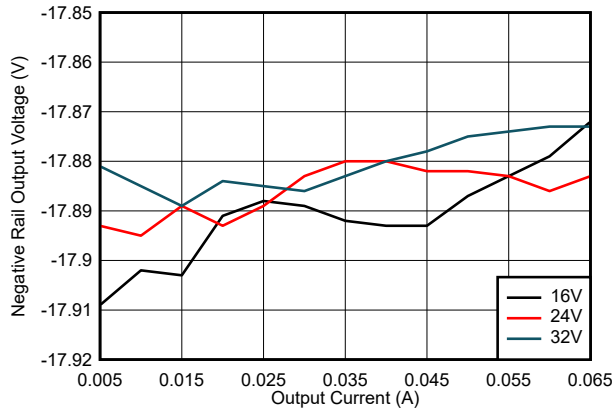


Figure 3-3. Negative Rail Output Voltage

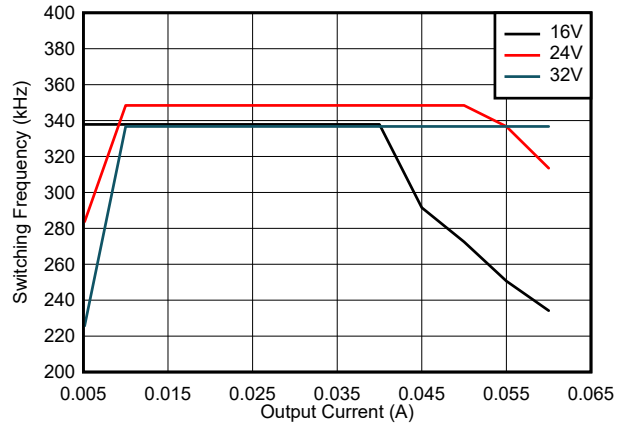


Figure 3-4. Switching Frequency

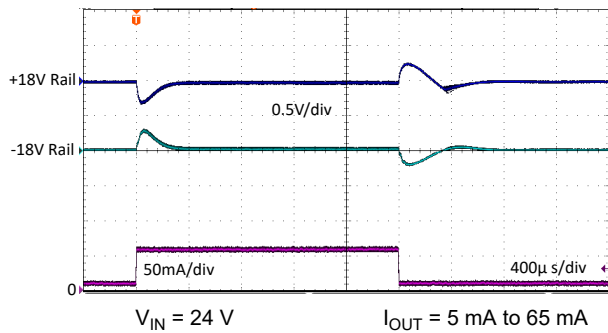


Figure 3-5. Load Transient

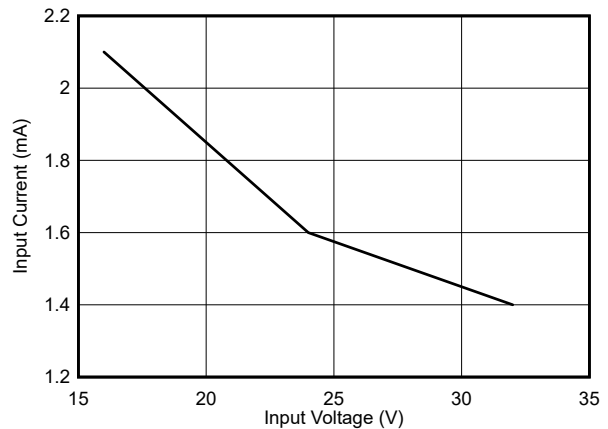
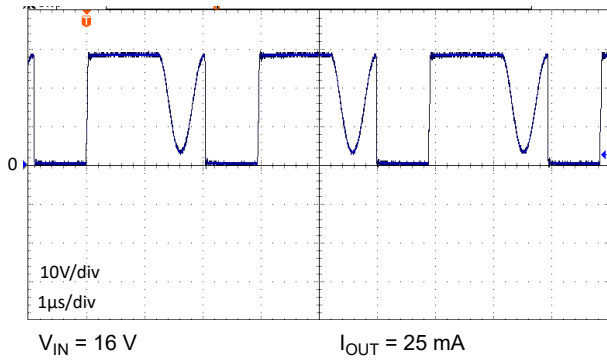
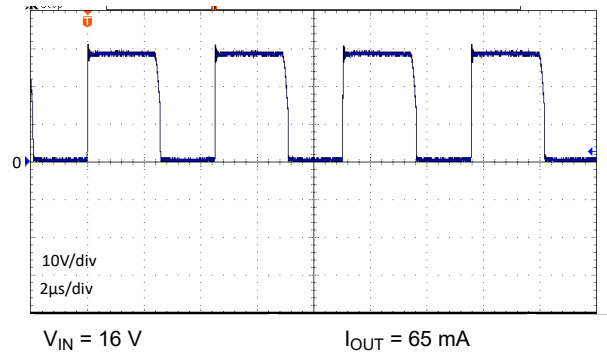


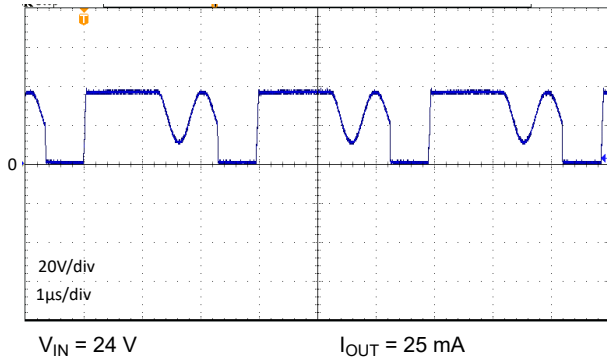
Figure 3-6. No Load Input Supply Current



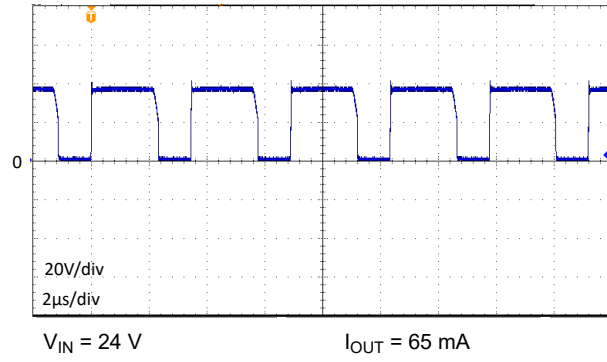
**Figure 3-7. Switch Node**



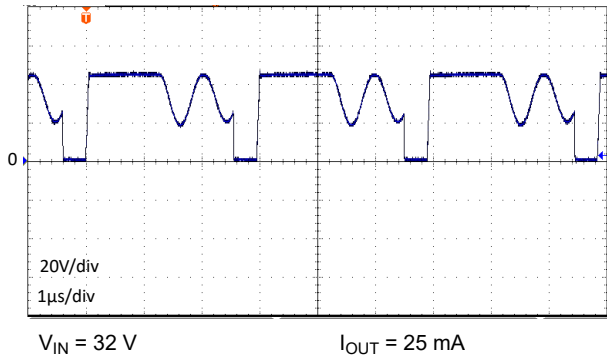
**Figure 3-8. Switch Node**



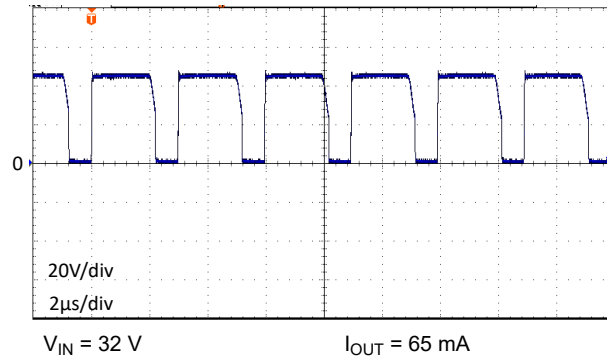
**Figure 3-9. Switch Node**



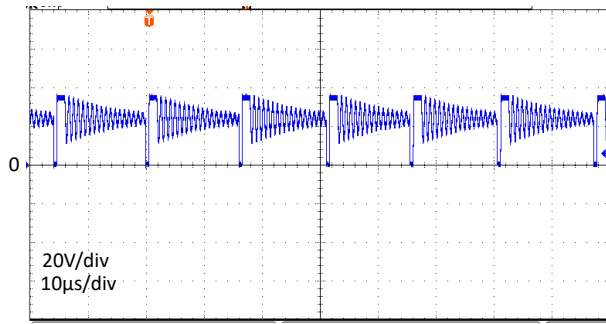
**Figure 3-10. Switch Node**



**Figure 3-11. Switch Node**

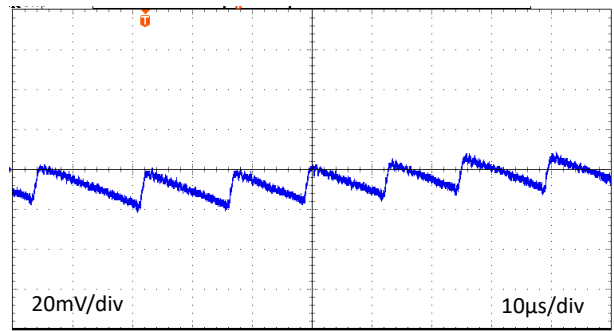


**Figure 3-12. Switch Node**



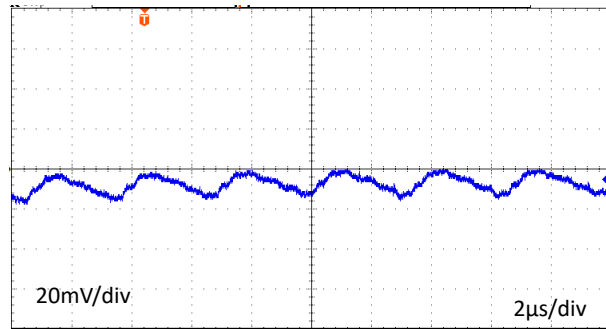
$V_{IN} = 24\text{ V}$   $I_{OUT} = 5\text{ mA}$

**Figure 3-13. Switch Node**



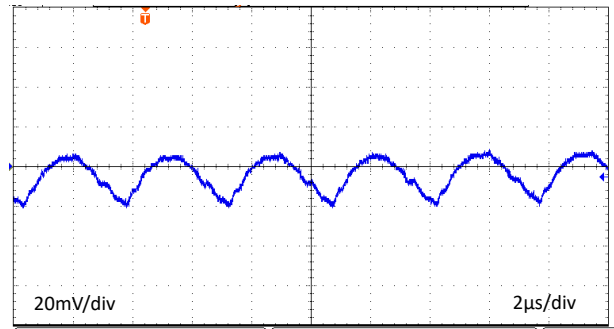
$V_{IN} = 24\text{ V}$   $I_{OUT} = 5\text{ mA}$

**Figure 3-14. Positive Output Voltage Ripple**



$V_{IN} = 24\text{ V}$   $I_{OUT} = 25\text{ mA}$

**Figure 3-15. Positive Output Voltage Ripple**

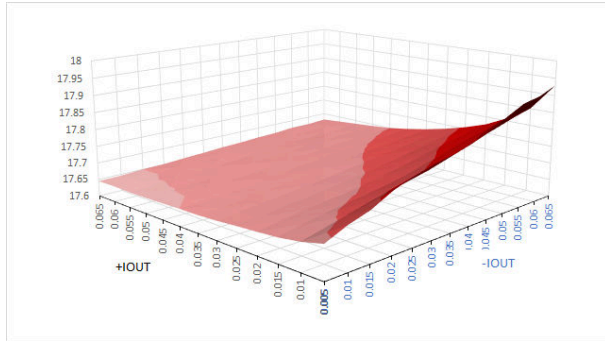


$V_{IN} = 24\text{ V}$   $I_{OUT} = 65\text{ mA}$

**Figure 3-16. Positive Output Voltage Ripple**

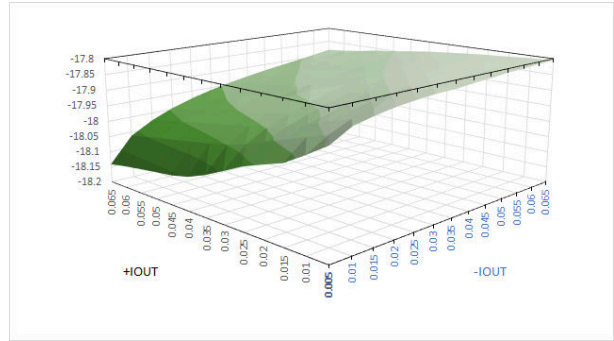
### 3.1 Cross-regulation

The following results were obtained by independently varying the load current on both the positive and negative rail. In this way a measure of the typical cross regulation performance is illustrated.



$V_{IN} = 24\text{ V}$

**Figure 3-17. Positive Rail Load Regulation**



$V_{IN} = 24\text{ V}$

**Figure 3-18. Negative Rail Load Regulation**

## 4 Bill of Materials

**Table 4-1. Bill of Materials (BOM)**

Designator	Quantity	Description	Package	PartNumber	Manufacturer
C1	1	CAP, CERM, 22 pF, 250 V, +/- 5%, C0G/NP0, AEC-Q200 Grade 1, 0603	0603	251R14S220JV4T	Johanson Technology
C2, C3, C9, C10	4	CAP, CERM, 10 uF, 25 V, +/- 10%, X7R, 1206	1206	GRM31CR71E106KA12L	MuRata
C5	1	CAP, AL, 33 uF, 100 V, +/- 20%, 0.7 ohm, AEC-Q200 Grade 2, SMD	SMT Radial G	EEE-FK2A330P	Panasonic
C6	1	CAP, CERM, 0.1 uF, 100 V, +/- 10%, X7S, AEC-Q200 Grade 1, 0603	0603	CGA3E3X7S2A104K080AB	TDK
C7, C8	2	CAP, CERM, 4.7 uF, 100 V, +/- 10%, X7S, 1210	1210	GRM32DC72A475KE01L	MuRata
C12, C13	2	CAP, CERM, 22 pF, 100 V, +/- 5%, C0G/NP0, 0603	0603	GRM1885C2A220JA01D	MuRata
C14	1	CAP, CERM, 1000 pF, 2000 V, +/- 10%, X7R, 1206_190	1206_190	202R18W102KV4E	Johanson Technology
C15	1	CAP, CERM, 0.047 uF, 25 V, +/- 10%, X7R, AEC-Q200 Grade 1, 0603	0603	GCM188R71E473KA37D	MuRata
D1	1	Diode, Superfast Rectifier, 200 V, 1 A, AEC-Q101, 2.8x1.8mm	2.8x1.8mm	US1DFA	Fairchild Semiconductor
D2	1	Diode, Zener, 24 V, 1 W, PowerDI123	PowerDI123	DFLZ24-7	Diodes Inc.
D3	1	Diode, Schottky, 100 V, 1 A, AEC-Q101, SOD-123W	SOD-123W	PMEG10010ELRX	Nexperia
D4	1	Diode, Ultrafast, 75 V, 0.25 A, SOD-323	SOD-323	CMDD4448	Central Semiconductor
D5, D6	2	Diode, Zener, 27 V, 1 W, PowerDI123	PowerDI123	DFLZ27-7	Diodes Inc.
L1	1	Ferrite Bead, 22 ohm @ 100 MHz, 6 A, 0805	0805	742792021	Würth Elektronik
L2	1	Inductor, Shielded Drum Core, Ferrite, 10 uH, 1 A, 0.12 ohm, SMD	WE-TPC-M1	744042100	Würth Elektronik
R1, R3	2	RES, 100, 1%, 0.1 W, AEC-Q200 Grade 0, 0603	0603	CRCW0603100RFKEA	Vishay-Dale
R2	1	RES, 100, 1%, 0.1 W, 0603	0603	CRCW0603100RFKEA	Vishay-Dale
R4	1	RES, 340 k, 1%, 0.1 W, AEC-Q200 Grade 0, 0603	0603	CRCW0603340KFKEA	Vishay-Dale



**Table 4-1. Bill of Materials (BOM) (continued)**

Designator	Quantity	Description	Package	PartNumber	Manufacturer
R5	1	RES, 453 k, 1%, 0.1 W, 0603	0603	RC0603FR-07453KL	Yageo
R6	1	RES, 121 k, 1%, 0.1 W, 0603	0603	RC0603FR-07121KL	Yageo
R7	1	RES, 68.1 k, 1%, 0.1 W, AEC-Q200 Grade 0, 0603	0603	CRCW060368K1FKEA	Vishay-Dale
R8	1	RES, 12.1 k, 1%, 0.1 W, 0603	0603	CRCW060312K1FKEA	Vishay-Dale
T1	1	TRANSFORMER	SMT8_8MM6_8MM26	750319518	Würth Electronics
TP1, TP2, TP3, TP4, TP5	5	Terminal, Turret, TH, Double	Keystone1573-2	1573-2	Keystone
TP6, TP7, TP8, TP9	4	Test Point, Miniature, SMT	Testpoint_Keystone_Miniature	5015	Keystone
U1	1	65-VIN PSR Flyback DC/DC Converter with 100-V, 0.75-A Integrated MOSFET	WSON8	LM5181NGUR	Texas Instruments
C4, C11	0	CAP, TA, 33 uF, 25 V, +/- 10%, 0.09 ohm, SMD	7343-31	T495D336K025ATE090	Kemet

## 5 References

- Texas Instruments, [LM5180 65-VIN no-opto Flyback Converter with 100-V, 1.5-A Integrated MOSFET](#) data sheet.
- Texas Instruments, [LM5181 65-VIN no-opto Flyback Converter with 100-V, 0.75-A Integrated MOSFET](#) data sheet.
- Texas Instruments, [LM25184 42-VIN no-opto Flyback Converter with 65-V, 4.1-A Integrated MOSFET](#) data sheet.
- Texas Instruments, [LM5180EVM-DUAL Wide VIN PSR Flyback Converter Dual-Output Evaluation module](#) data sheet.
- Texas Instruments, [TPS7A39 150-mA, 33-V, Low-noise, High-PSRR, Dual-Channel Positive and Negative Low-Dropout Voltage Regulator](#) data sheet.
- Texas Instruments, [Selecting Output Caps to Optimize Ripple and Stability in PSR Flyback Converters](#) data sheet.
- Texas Instruments, [How an Auxless PSR-Flyback Converter can Increase PLC Reliability and Density](#) data sheet.

## IMPORTANT NOTICE AND DISCLAIMER

TI PROVIDES TECHNICAL AND RELIABILITY DATA (INCLUDING DATA SHEETS), DESIGN RESOURCES (INCLUDING REFERENCE DESIGNS), APPLICATION OR OTHER DESIGN ADVICE, WEB TOOLS, SAFETY INFORMATION, AND OTHER RESOURCES "AS IS" AND WITH ALL FAULTS, AND DISCLAIMS ALL WARRANTIES, EXPRESS AND IMPLIED, INCLUDING WITHOUT LIMITATION ANY IMPLIED WARRANTIES OF MERCHANTABILITY, FITNESS FOR A PARTICULAR PURPOSE OR NON-INFRINGEMENT OF THIRD PARTY INTELLECTUAL PROPERTY RIGHTS.

These resources are intended for skilled developers designing with TI products. You are solely responsible for (1) selecting the appropriate TI products for your application, (2) designing, validating and testing your application, and (3) ensuring your application meets applicable standards, and any other safety, security, regulatory or other requirements.

These resources are subject to change without notice. TI grants you permission to use these resources only for development of an application that uses the TI products described in the resource. Other reproduction and display of these resources is prohibited. No license is granted to any other TI intellectual property right or to any third party intellectual property right. TI disclaims responsibility for, and you will fully indemnify TI and its representatives against, any claims, damages, costs, losses, and liabilities arising out of your use of these resources.

TI's products are provided subject to [TI's Terms of Sale](#) or other applicable terms available either on [ti.com](http://ti.com) or provided in conjunction with such TI products. TI's provision of these resources does not expand or otherwise alter TI's applicable warranties or warranty disclaimers for TI products.

TI objects to and rejects any additional or different terms you may have proposed.

Mailing Address: Texas Instruments, Post Office Box 655303, Dallas, Texas 75265  
Copyright © 2022, Texas Instruments Incorporated