

LMR360xxxEVM User's Guide

The Texas Instruments LMR36015A and LMR36006B evaluation modules (EVM) help designers evaluate the operation and performance of the LMR36015 and LMR36006 wide-input buck regulators. The LMR36015 is an easy-to-use synchronous step-down DC/DC converter capable of driving up to 1.5 A of load current from an input voltage of up to 60 V. The LMR36006 uses the same EVM PCB and components, but the current limit is modified to 0.6 A. The LMR360xxxEVMS feature a selectable output voltage of 3.3 V or 5 V and a switching frequency of 400 kHz and 1 MHz. See the [LMR36006](#) and [LMR36015](#) data sheets for additional features, detailed descriptions, and available options.

The EVM options are found in [Table 1](#).

Table 1. Device and Package Configurations

EVM	U1	FREQUENCY	Output Current
LMR36015AEVM	LMR36015	400 kHz	1.5 A
LMR36006BEVM	LMR36006	1 MHz	600 mA

Contents

1	Posts, Probes, and Jumpers	3
2	Operation	5
3	Schematic.....	6
4	Board Layout	7
5	Bill of Materials	13
6	Test Results.....	14

List of Figures

1	EVM Board Connections.....	3
2	Jumper Locations.....	4
3	LMR360xxxEVM Schematic.....	6
4	Top View of EVM	7
5	EVM Top Copper Layer.....	8
6	EVM Mid Layer One.....	9
7	EVM Mid Layer Two	10
8	EVM Bottom Copper Layer	11
9	EVM Bottom View.....	12
10	LMR36015AEVM 5 V _{OUT} Efficiency	14
11	LMR36015AEVM 3.3 V _{OUT} Efficiency	14
12	LMR36015AEVM 5 V _{OUT} Load Regulation	14
13	LMR36015AEVM 3.3 V _{OUT} Load Regulation	14
14	LMR36015AEVM 5 V _{OUT} Load Transient, 24 V _{IN} , I _{OUT} = 0 A to 1.5 A, T _R = T _F = 1 μs.....	15
15	LMR36015AEVM 3.3 V _{OUT} Load Transient, 24 V _{IN} , I _{OUT} = 0 A to 1.5 A, T _R = T _F = 1 μs.....	15
16	LMR36015AEVM 5 V _{OUT} Start-Up Waveform, 24 V _{IN} , 1.5 A Load	15
17	LMR36015AEVM 3.3 V _{OUT} Start-Up Waveform, 24 V _{IN} , 1.5 A Load	15
18	LMR36006BEVM 5 V _{OUT} Efficiency	16
19	LMR36006BEVM 3.3 V _{OUT} Efficiency	16

20	LMR36006BEVM 5 V _{OUT} Load Regulation	16
21	LMR36006BEVM 3.3 V _{OUT} Load Regulation	16
22	LMR36006BEVM 5 V _{OUT} Load Transient, 24 V _{IN} , I _{OUT} = 0 A to 0.6 A, T _R = T _F = 1 μs.....	17
23	LMR36006BEVM 3.3 V _{OUT} Load Transient, 24 V _{IN} , I _{OUT} = 0 A to 0.6 A, T _R = T _F = 1 μs.....	17
24	LMR36006BEVM 5 V _{OUT} Start-Up Waveform, 24 V _{IN} , 1.5 A Load	17
25	LMR36006BEVM 3.3 V _{OUT} Start-Up Waveform, 24 V _{IN} , 1.5 A Load	17

List of Tables

1	Device and Package Configurations	1
2	Bill of Materials	13

Trademarks

All trademarks are the property of their respective owners.

1 Posts, Probes, and Jumpers

This section describes the test points and connectors on the EVM and how to properly connect, set up, and use the LMR36015AEVM and the LMR36006BEVM.

1.1 Screw Terminal Connectors

The screw terminals on the top of the board can be used for connecting to the input and output of the EVM. See [Figure 1](#) for the screw terminal connections. The functions of the screw terminal connections are:

- **VIN** - Input supply to EVM. Connect to a suitable input supply. See [LMR36006 data sheet](#) and [LMR36015 data sheet](#) for input supply requirements.
- **GND** - System ground.
- **IN+** - Input supply to EVM including an EMI filter. Connect to a suitable input supply. See [LMR36006 data sheet](#) and [LMR36015 data sheet](#) for input supply requirements.
- **IN-** - System ground including an EMI filter.
- **VOUT** - Output of EVM — connect to desired load.

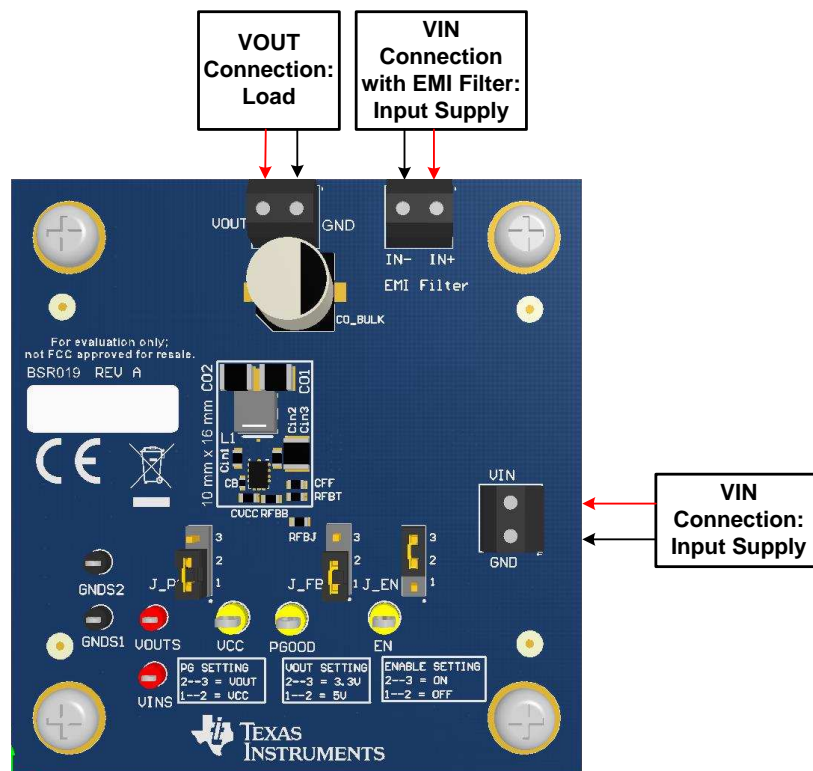

Figure 1. EVM Board Connections

1.2 Jumpers

See [Figure 2](#) for jumper locations.

- **EN** - This jumper allows the ENABLE input to be connected to either GND (OFF) or VIN (ON). The 2-to-3 position enables the device; while the 1-to-2 position disables the device. Remove this jumper to allow an external logic signal to control the EN function.
- **VOUT** - Use this jumper to select one of the two pre-defined output voltages. The 2-to-3 position provides a 3.3-V output; while the 1-to-2 position provides a 5-V output.
- **PGOOD** - Use this jumper to select the PGOOD pullup configuration. PGOOD can be connected to either VOUT or VCC. The 2-to-3 position connects PGOOD to VOUT, while the 1-to-2 position connects PGOOD to VCC.

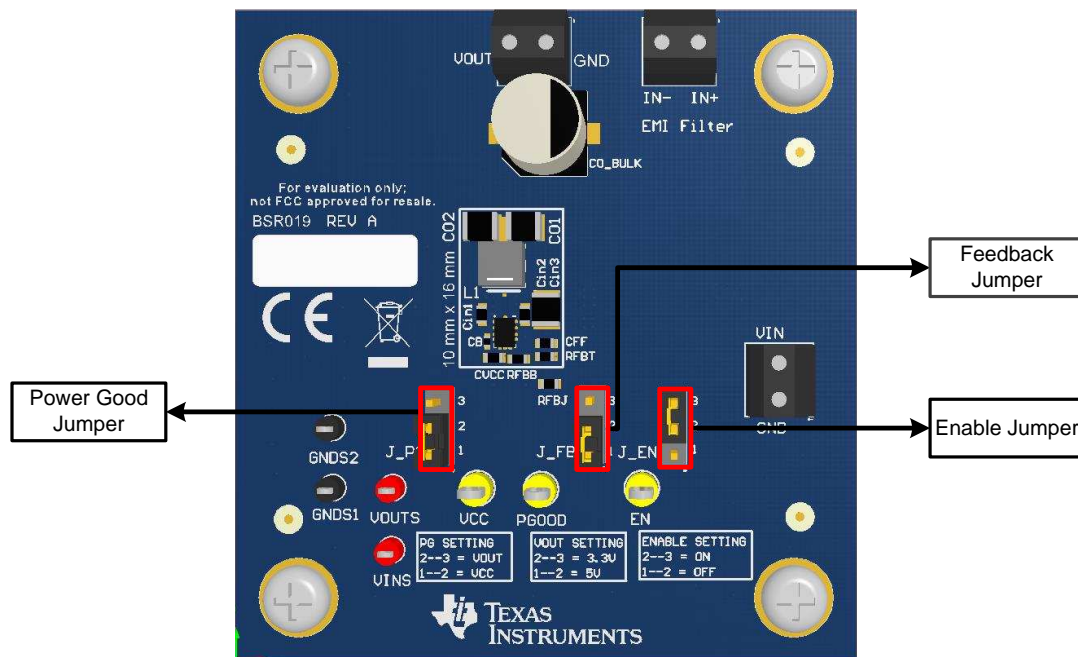

Figure 2. Jumper Locations

1.3 Test Points

- **VOUTS** - Output voltage sense connection; connect to DMM. Also, use for frequency response analyzer connection.
- **VINS** - Input voltage sense connection; connect to DMM.
- **GNDS1 and GNDS2** - Ground sense point for analog measurements; connect to DMM.
- **VCC** - Test point to measure internal VCC of device; approximately 5 V.
- **EN** - Connection for external EN logic input. Remove EN jumper and connect controlling logic to EN test point for external enable control.
- **PGOOD** - Power-good flag output. This test point is connected to VCC or VOUT through a 100-k Ω resistor. The power-good function can be monitored at this test point.

2 Operation

2.1 Quick Start

1. Connect the voltage supply between VIN and GND screw terminal connectors using short and thick wires.
2. Connect the load between VOUT and GND screw terminal connectors using short and thick wires.
3. Set the supply voltage at an appropriate level between 4.2 V to 60 V. Set the current limit of the supply to an appropriate level.
4. Turn on the power supply. With the default configuration, the EVM powers up and provides $V_{OUT} = 5\text{ V}$.
5. Monitor the output voltage. The maximum load current must be 1.5 A with the LMR36015 device or 600 mA with the LMR36006 device.

2.2 Efficiency Measurement

1. Connect power supply to VIN and GND screw terminal connectors and make sure the power supply provides sufficient current.

NOTE: There is no reverse polarity protection or fuse on the evaluation board.

2. Connect electronic load to VOUT and GND screw terminal connectors. For all power wires it is preferable to use twisted lab wires. If the power supply wires are very long > 50 cm, solder an additional 470- μF , 100-V bulk capacitor to posts VIN and GND. Use sufficient power wires to avoid voltage drops, and use short sense probe connection for the measurement.

NOTE: These sense lines are not designed to carry power.

3. To accurately sense input and output voltage use the test points VINS, VOUTS, and GNDS. Alternatively, sense wires can be soldered directly over input capacitors C_{IN1} or C_{IN2} and the output capacitors C_{O1} or C_{O2} .
4. Make sure the IC is enabled by having jumper J5 set to [EN-VIN] and check that test point EN is driven high. While measuring I_Q (unloaded input current) remove all the input and output voltage probes that are most likely causing additional current draw.

2.3 Measure Load Transient

1. Connect power supply to VIN and GND screw terminal connectors, and make sure the power supply can provide sufficient peak current.

NOTE: There is no reverse polarity protection or fuse on the evaluation board.

2. Connect transient load to VOUT and GND screw terminal connectors. For all power wires use preferable twisted lab wires. If the power supply wires are very long > 50 cm, solder an additional 470- μF , 100-V bulk capacitor to posts VIN and GND. Use short sense probe connection for the measurement.
3. To accurately sense the output voltage, place the scope probe directly over the output capacitors C_{O1} or C_{O2} . Make sure to connect scope probe GND ring directly to the output capacitor GND pad for minimal ground loop. Ground loops can introduce ringing in observed waveforms, which is an artifact and not present on the PCB. Alternatively, use differential probe over output capacitors C_{O1} or C_{O2} . Do not use wires to differential probe and always probe directly with shortest possible pins. Make sure the IC is enabled by having jumper J5 set to [EN-VIN] and check test point EN is driven high and not drooping during the load transient.

3 Schematic

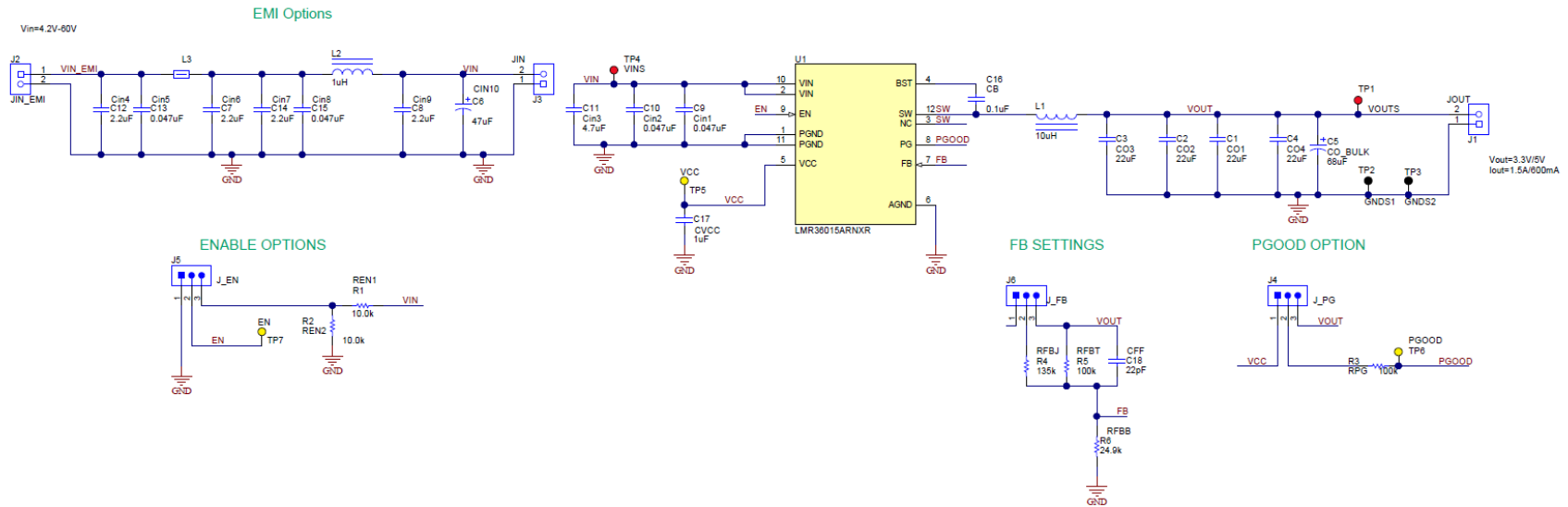

Figure 3. LMR360xxxEVM Schematic

4 Board Layout

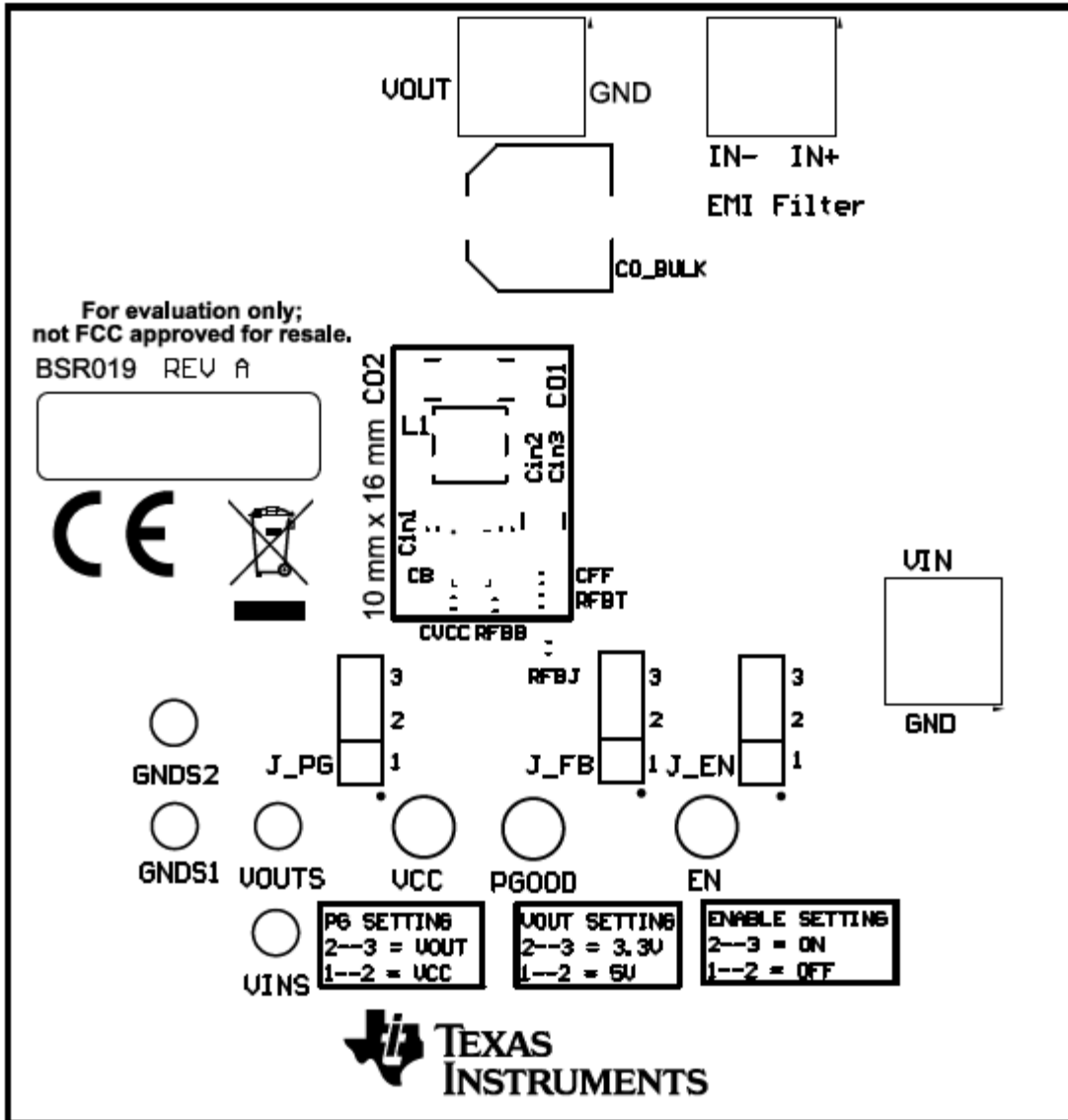

Figure 4. Top View of EVM

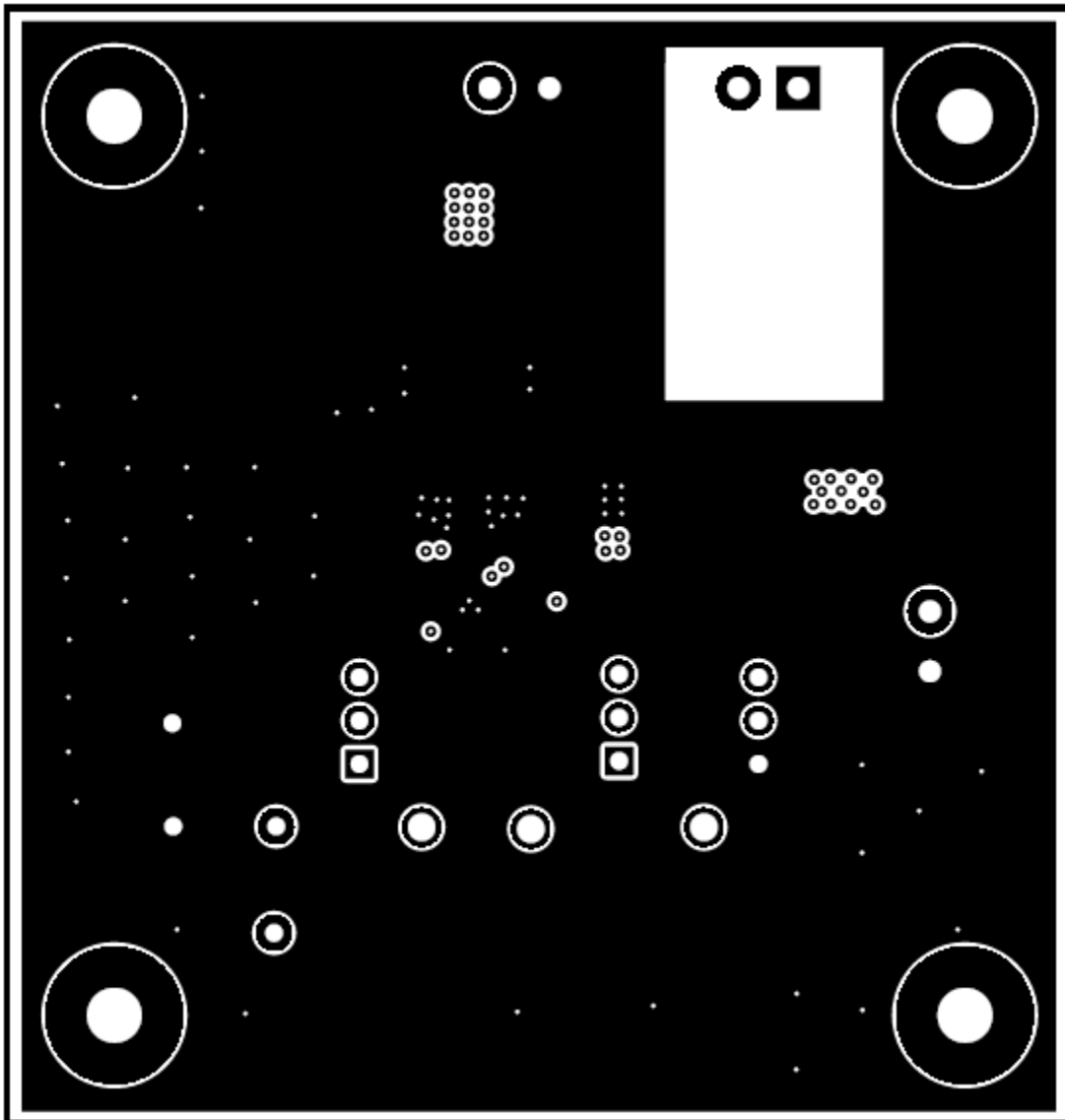

Figure 5. EVM Top Copper Layer

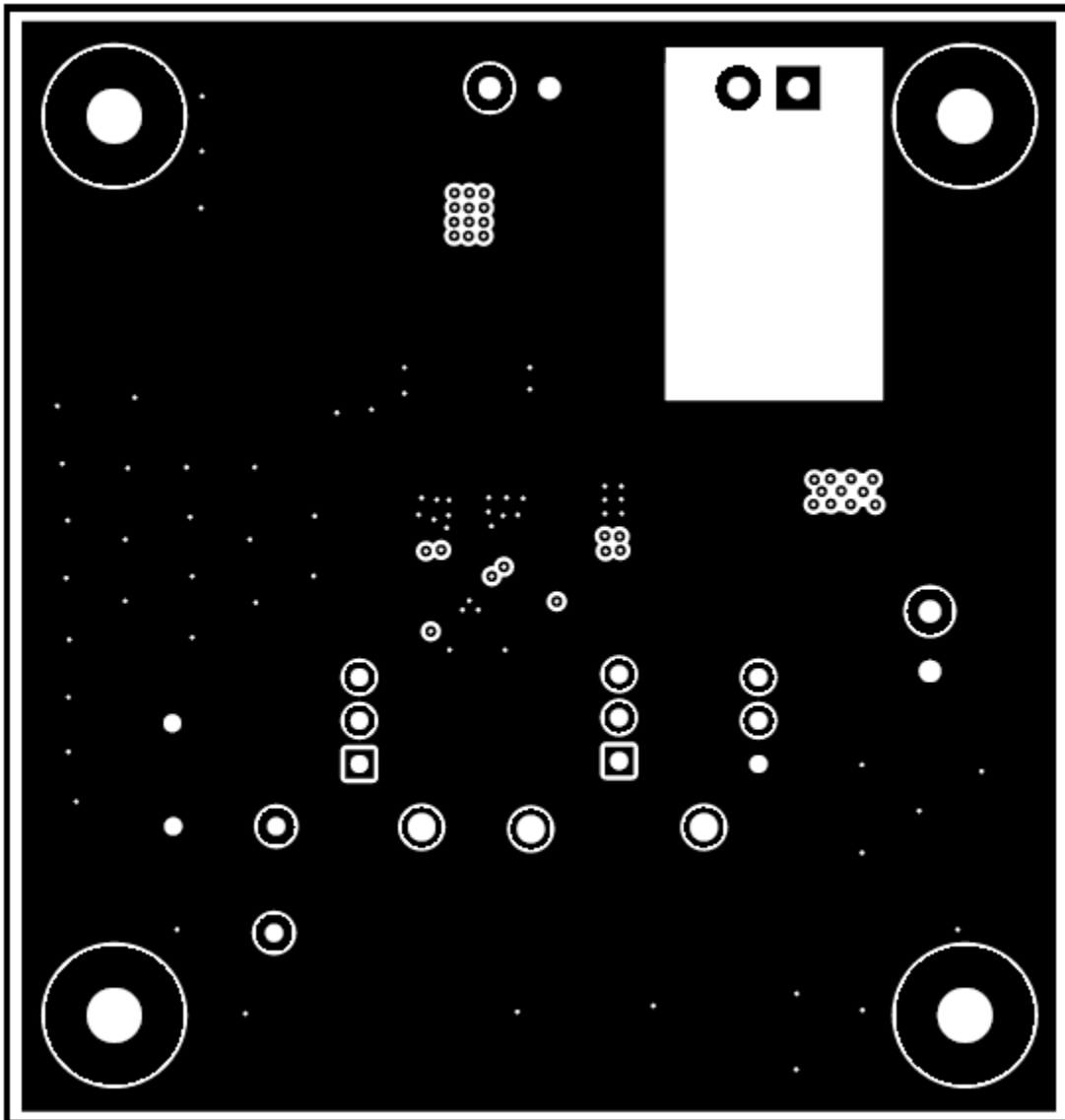

Figure 6. EVM Mid Layer One

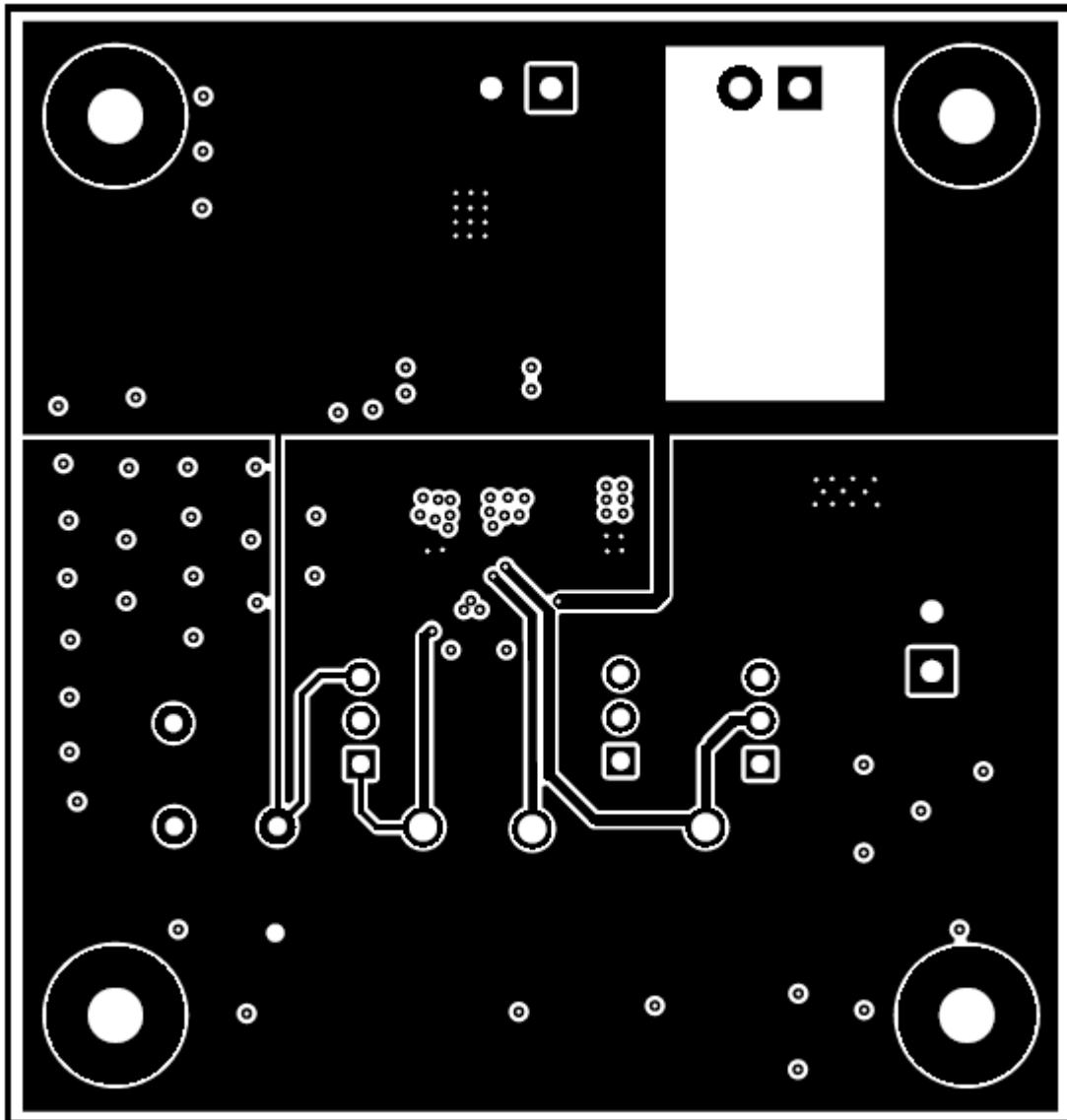

Figure 7. EVM Mid Layer Two

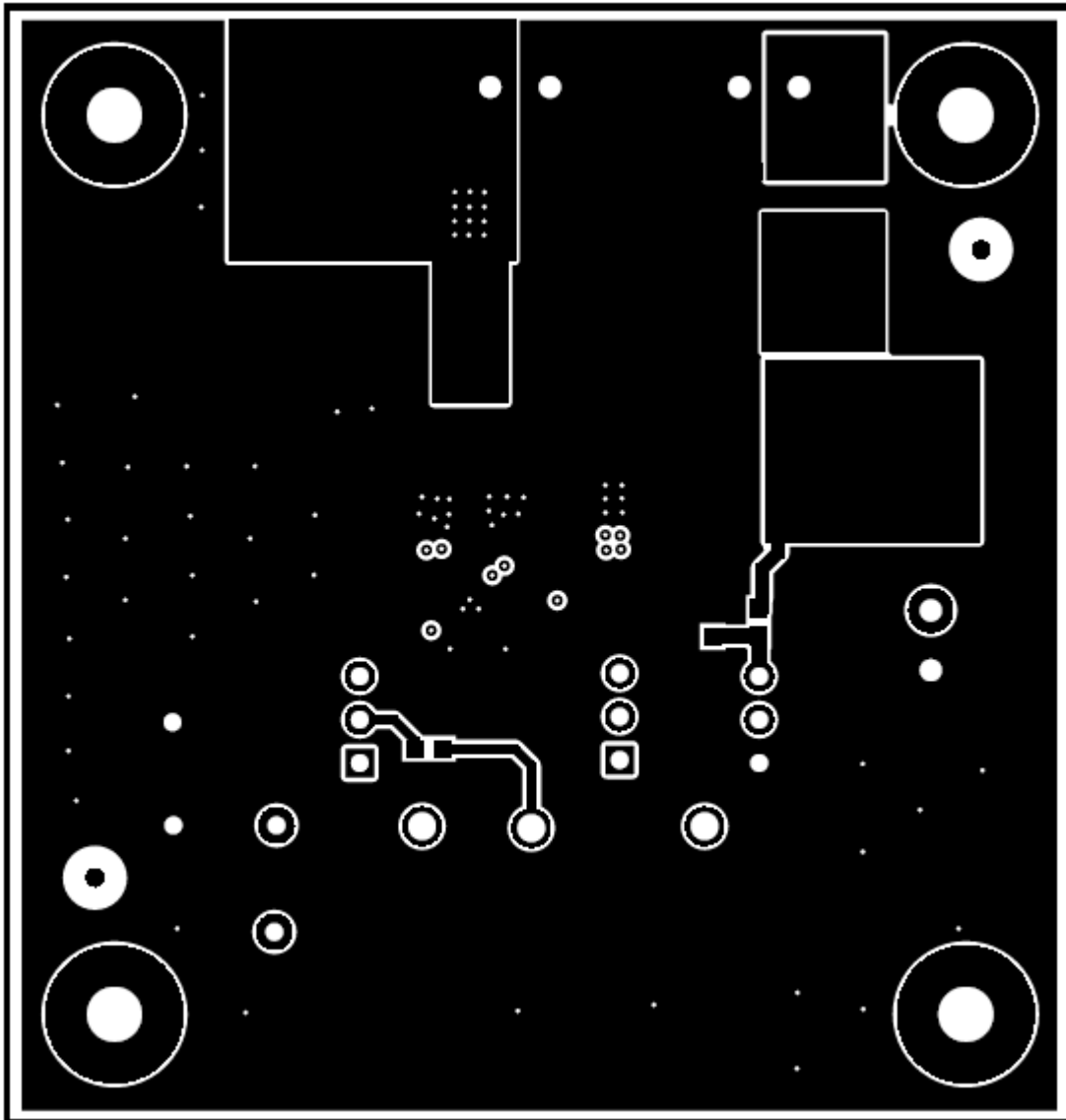

Figure 8. EVM Bottom Copper Layer

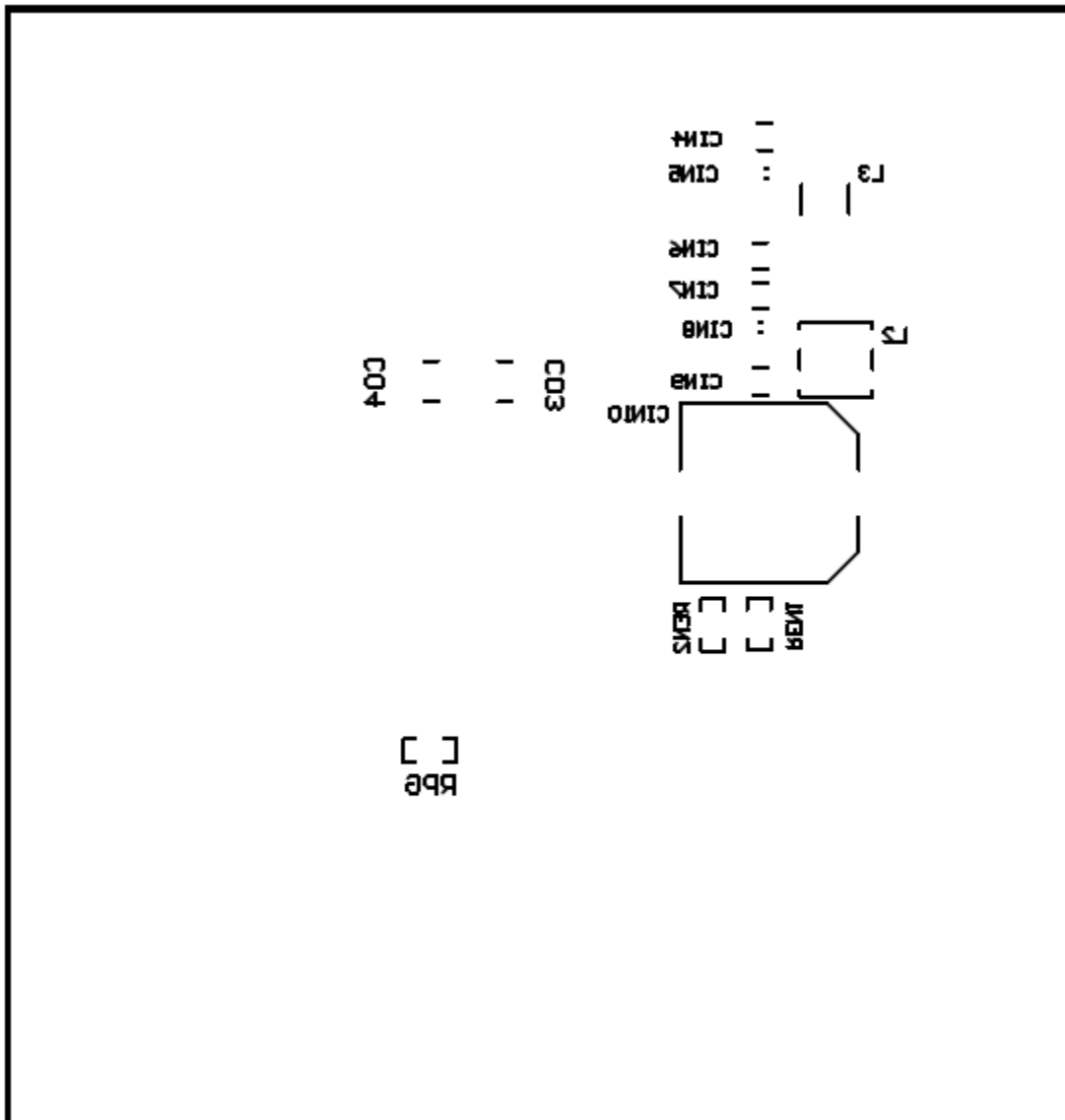

Figure 9. EVM Bottom View

5 Bill of Materials

Table 2. Bill of Materials

Designator	Description	Manufacturer	Part Number	Quantity
C5	CAP, AL, 68 μ F, 63 V, +/- 20%, 0.65 ohm, AEC-Q200 Grade 2, SMD	Panasonic	EEE-FK1J680UP	0
C9, C10	CAP, CERM, 0.047 μ F, 100 V, +/- 10%, X7S, 0603	TDK	CGA3E3X7S2A473K080AB	2
C11	CAP, CERM, 4.7 μ F, 100 V, +/- 10%, X7S, AEC-Q200 Grade 1, 1210	TDK	CGA6M3X7S2A475K200A	1
C16	CAP, CERM, 0.1 μ F, 25 V, +/- 10%, X7R, 0402	MuRata	GRM155R71E104KE14D	1
C17	CAP, CERM, 1 μ F, 25 V, +/- 10%, X7R, 0603	TDK	C1608X7R1E105K080AB	1
C18	CAP, CERM, 22 pF, 50 V, +/- 5%, COG/NP0, AEC-Q200 Grade 1, 0603	TDK	CGA3E2C0G1H220J080AA	1
H1, H2, H3, H4	Machine Screw, Round, #4-40 x 1/4, Nylon, Philips panhead	B&F Fastener Supply	NY PMS 440 0025 PH	2
H5, H6, H7, H8	Standoff, Hex, 0.5"L #4-40 Nylon	Keystone	1902C	4
J1, J2, J3	Terminal Block, 3.5mm Pitch, 2x1, TH	On-Shore Technology	ED555/2DS	3
J4, J5, J6	Header, 100mil, 3x1, Gold, TH	Samtec	HTSW-103-07-G-S	3
LBL1	Thermal Transfer Printable Labels, 0.650" W x 0.200" H - 10,000 per roll	Brady	THT-14-423-10	1
R1, R2	RES, 10.0 k, 1%, 0.1 W, 0603	Vishay-Dale	CRCW060310K0FKEA	2
R3	RES, 100 k, 1%, 0.1 W, 0603	Vishay-Dale	CRCW0603100KFKEA	1
R4	RES, 135 k, 0.1%, 0.1 W, 0603	Yageo America	RT0603BRD07135KL	1
R5	RES, 100 k, 1%, 0.1 W, 0603	Yageo America	RC0603FR-07100KL	1
R6	RES, 24.9 k, 1%, 0.1 W, 0603	Vishay-Dale	CRCW060324K9FKEA	1
SH-J1, SH-J2, SH-J3	Shunt, 100mil, Gold plated, Black	3M	969102-0000-DA	3
TP1, TP4	Test Point, Multipurpose, Red, TH	Keystone	5000	2
TP2, TP3	Test Point, Multipurpose, Black, TH	Keystone	5001	2
TP5, TP6, TP7	Test Point, Multipurpose, Yellow, TH	Keystone	5014	3
LMR36015AEVM: Adjustable 3.3V/5V Output, 400kHz, 1.5A				
U1	4.2V to 60V, 1.5A Synchronous Step-Down	Texas Instruments	LMR36015	1
L1	Inductor, Shielded, Composite, 10 μ H, 3 A, 0.084 ohm, SMD	Coilcraft	XAL4040-153MEB	1
L2	Inductor, Shielded, Composite, 1 μ H, 8.75 A, 0.01 ohm, SMD	Coilcraft	XAL4040-102MEB	1
L3	Ferrite Bead, 600 ohm @ 100 MHz, 3 A, 1210	Taiyo Yuden	FBMH3225HM601NT	1
C1, C2, C3, C4	CAP, CERM, 22 μ F, 16 V, +/- 10%, X7R, 1210	MuRata	GRM32ER71C226KE18L	4
C6	CAP, AL, 47 μ F, 80 V, +/- 20%, 0.7 ohm, SMD	Chemi-Con	EMZA800ADA470MJA0G	1
C7, C8, C12, C14	CAP, CERM, 2.2 μ F, 100 V, +/- 10%, X7R, 1206	MuRata	GRM31CR72A225KA73L	4
C13, C15	CAP, CERM, 0.047 μ F, 100 V, +/- 10%, X7S, 0603	TDK	CGA3E3X7S2A473K080AB	2
LMR36006BEVM: Adjustable 3.3V/5V Output, 1MHz, 0.6A				
U1	4.2V to 60V, 0.6A Synchronous Step-Down	Texas Instruments	LMR36006	1
L1	Inductor, Shielded, Composite, 15 μ H, 2.8 A, 0.109 ohm, SMD	Coilcraft	XAL4040-153MEB	1
C1, C2, C3	CAP, CERM, 22 μ F, 16 V, +/- 10%, X7R, 1210	MuRata	GRM32ER71C226KE18L	3

6 Test Results

Section 6.1 details the test results from the LMR36015AEVM variant. Section 6.2 details the test results from the LMR36006BEVM.

6.1 LMR36015AEVM Test Results

The LMR36015AEVM variant is used for all figures from Figure 10 to Figure 17 variant.

6.1.1 Efficiency and Load Regulation

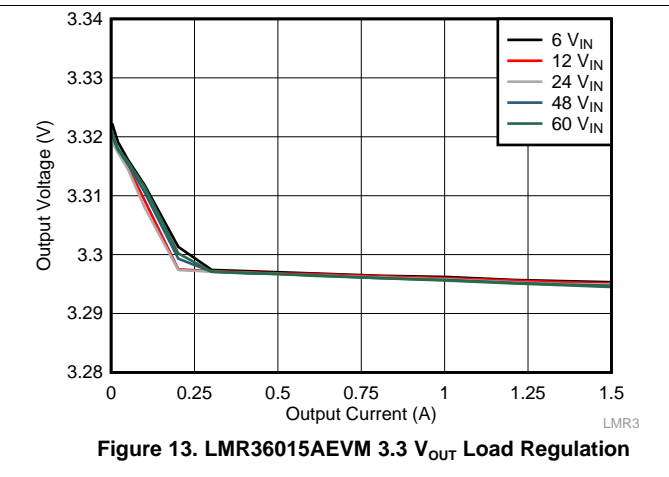
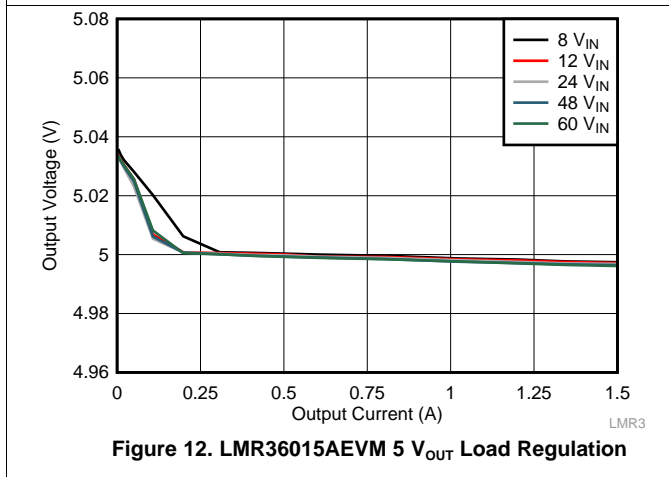
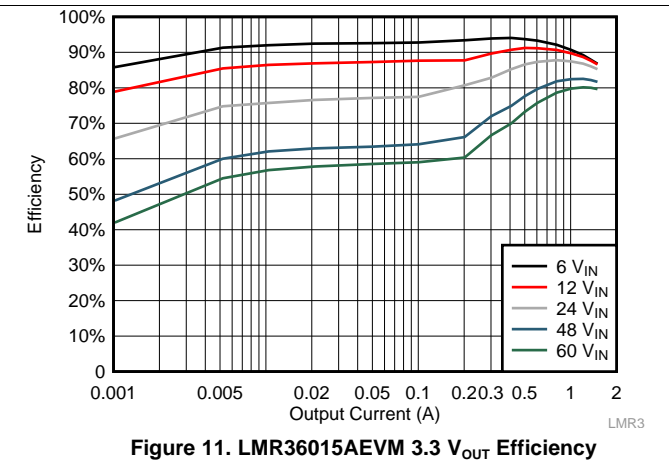
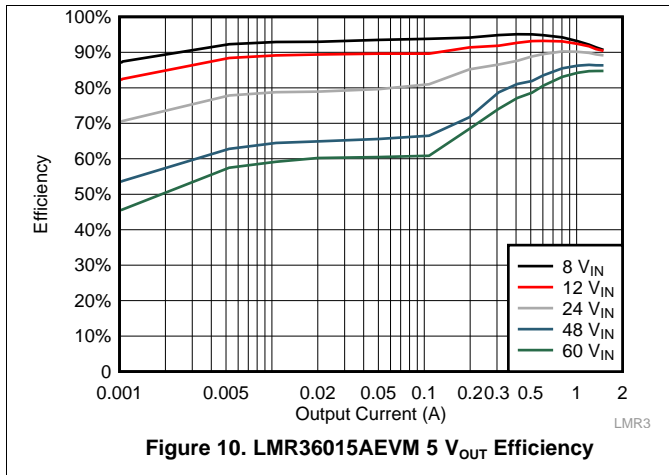

6.1.2 Load Transients

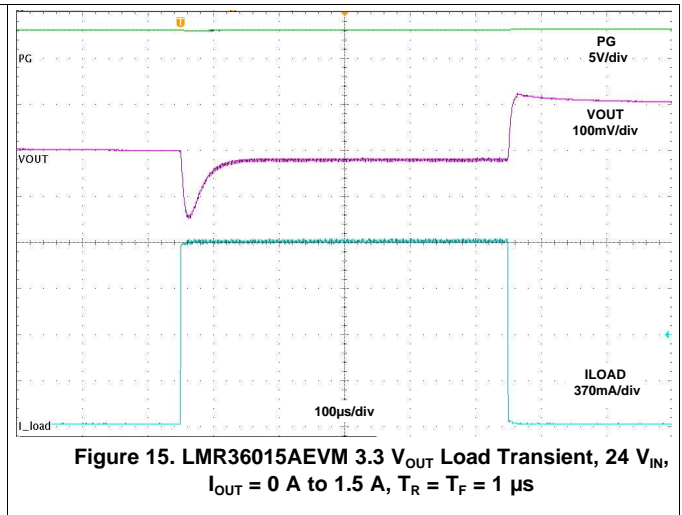
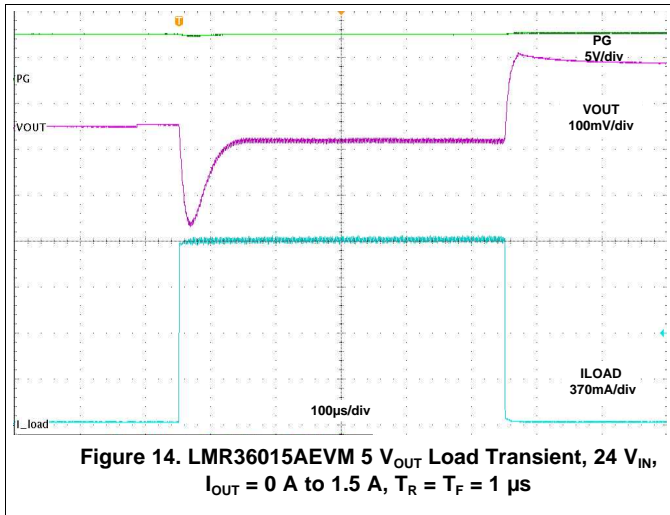

6.1.3 Start Up Waveforms

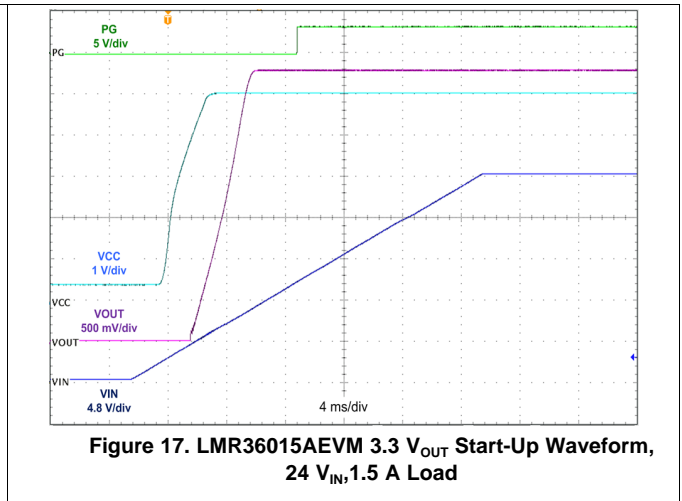
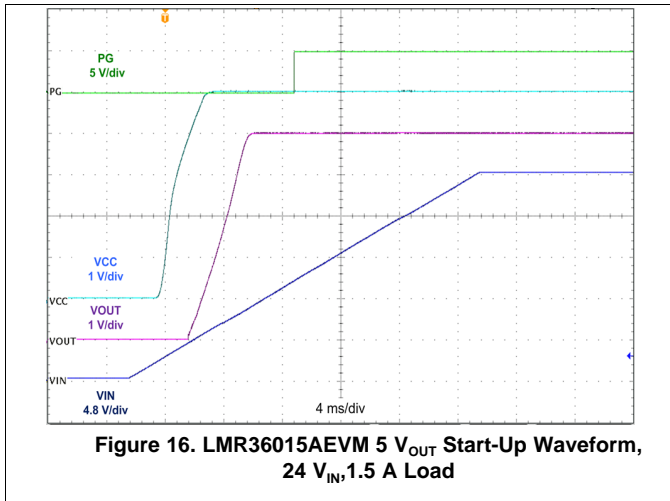

6.2 LMR36006BEVM Test Results

The LMR36006BEVM variant is used for all figures from [Figure 18](#) to [Figure 25](#).

6.2.1 Efficiency and Load Regulation

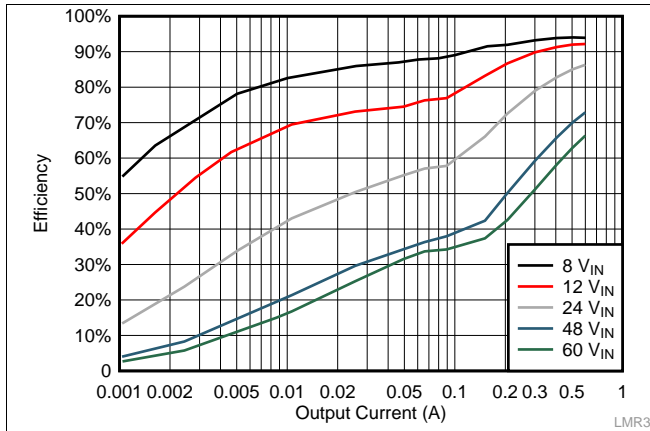

Figure 18. LMR36006BEVM 5 V_{OUT} Efficiency

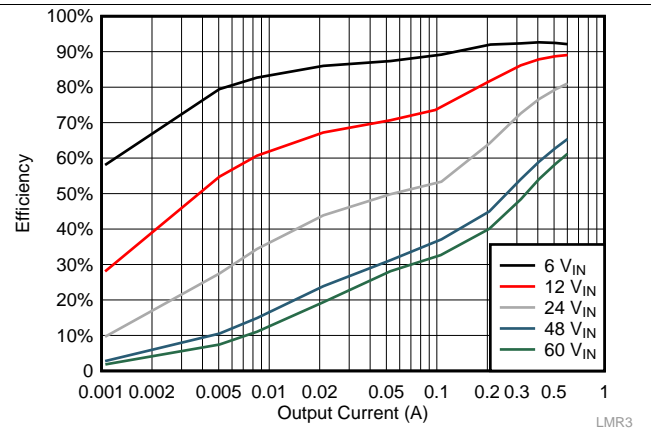

Figure 19. LMR36006BEVM 3.3 V_{OUT} Efficiency

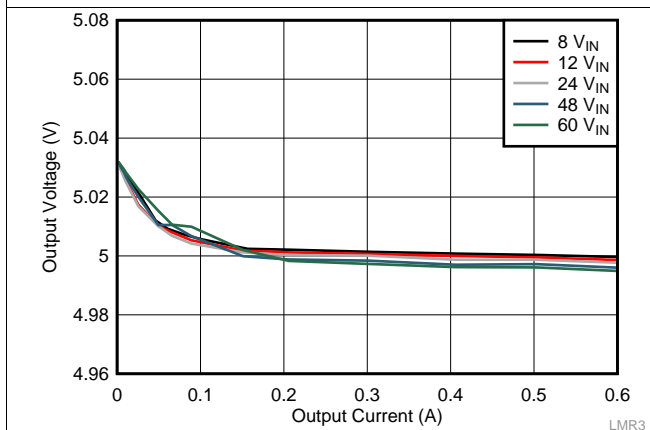

Figure 20. LMR36006BEVM 5 V_{OUT} Load Regulation

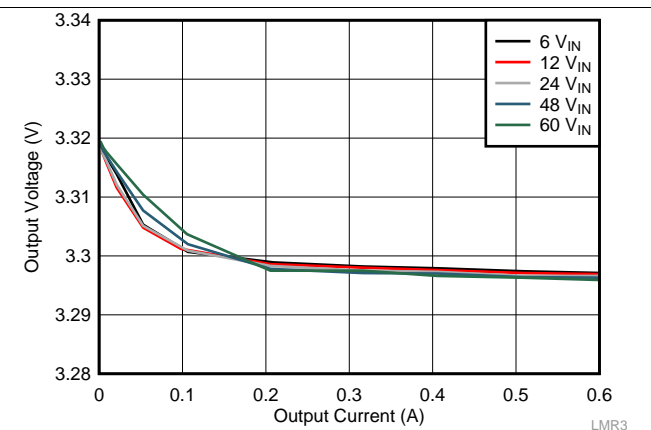
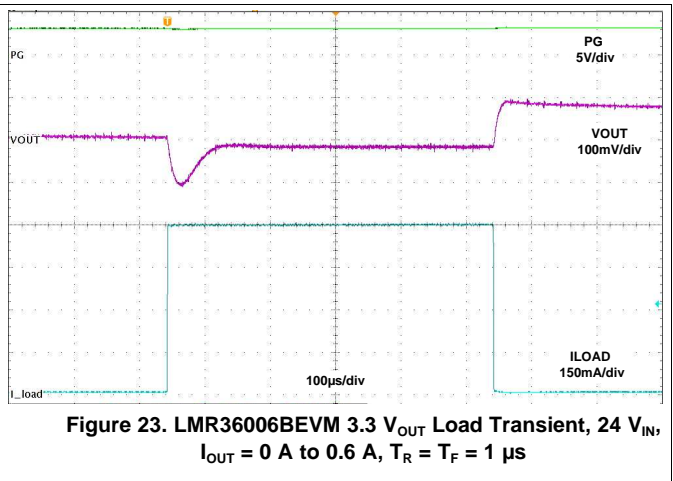
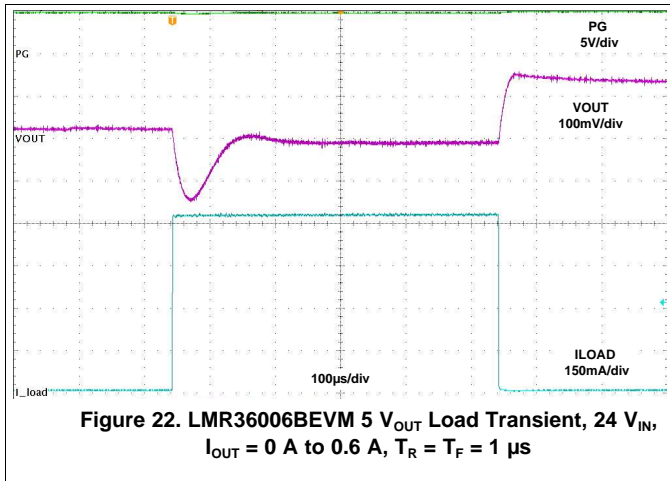
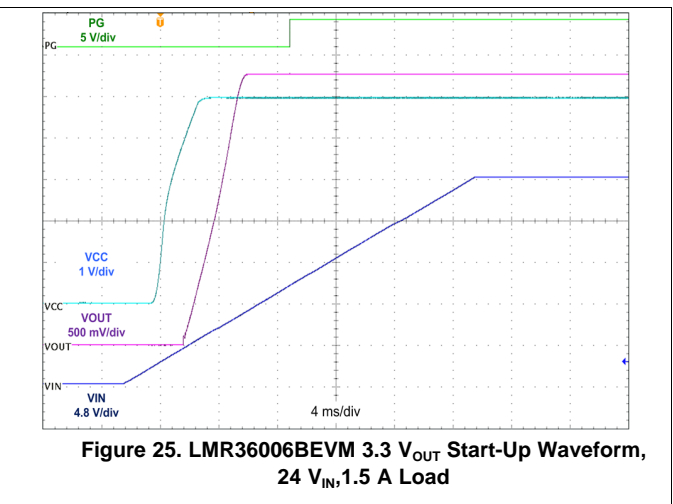
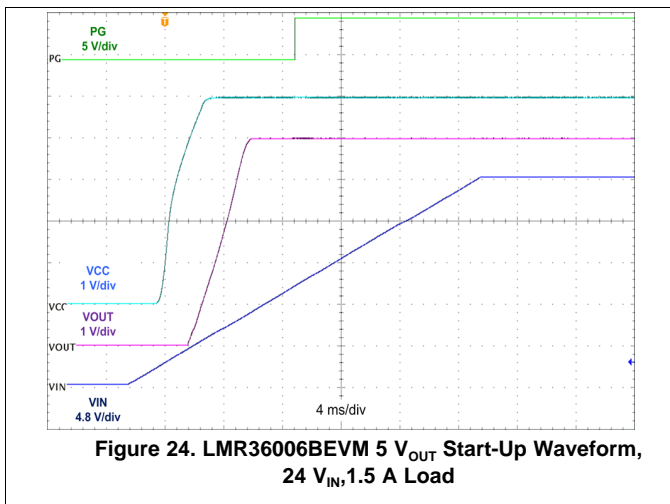

Figure 21. LMR36006BEVM 3.3 V_{OUT} Load Regulation

6.2.2 Load Transients



6.2.3 Start Up Waveforms



IMPORTANT NOTICE AND DISCLAIMER

TI PROVIDES TECHNICAL AND RELIABILITY DATA (INCLUDING DATASHEETS), DESIGN RESOURCES (INCLUDING REFERENCE DESIGNS), APPLICATION OR OTHER DESIGN ADVICE, WEB TOOLS, SAFETY INFORMATION, AND OTHER RESOURCES "AS IS" AND WITH ALL FAULTS, AND DISCLAIMS ALL WARRANTIES, EXPRESS AND IMPLIED, INCLUDING WITHOUT LIMITATION ANY IMPLIED WARRANTIES OF MERCHANTABILITY, FITNESS FOR A PARTICULAR PURPOSE OR NON-INFRINGEMENT OF THIRD PARTY INTELLECTUAL PROPERTY RIGHTS.

These resources are intended for skilled developers designing with TI products. You are solely responsible for (1) selecting the appropriate TI products for your application, (2) designing, validating and testing your application, and (3) ensuring your application meets applicable standards, and any other safety, security, or other requirements. These resources are subject to change without notice. TI grants you permission to use these resources only for development of an application that uses the TI products described in the resource. Other reproduction and display of these resources is prohibited. No license is granted to any other TI intellectual property right or to any third party intellectual property right. TI disclaims responsibility for, and you will fully indemnify TI and its representatives against, any claims, damages, costs, losses, and liabilities arising out of your use of these resources.

TI's products are provided subject to TI's Terms of Sale (www.ti.com/legal/termsofsale.html) or other applicable terms available either on ti.com or provided in conjunction with such TI products. TI's provision of these resources does not expand or otherwise alter TI's applicable warranties or warranty disclaimers for TI products.

Mailing Address: Texas Instruments, Post Office Box 655303, Dallas, Texas 75265
Copyright © 2018, Texas Instruments Incorporated