

# LM706A0-Q1 Buck Converter Evaluation Module



## Description

The LM706A0QEVM high-density EVM is designed to use a regulated or non-regulated high-voltage input rail ranging from 8V to 65V to produce a tightly regulated output voltage of 3.3V at load currents up to 10A. This wide  $V_{IN}$  range DC/DC device offers outsized voltage rating and operating margin to withstand supply rail voltage transients.

The free-running switching frequency is 400kHz and is synchronizable to an external clock signal at a higher or lower frequency. The power-train passive components selected for this EVM, including buck inductors and ceramic input and output capacitors, are automotive AEC-Q200 rated and are available from multiple component vendors.

## Features

- Wide input voltage operating range of 8V to 65V
- 1% accurate fixed 3.3V, 5V, or adjustable output down to 0.8V
- Switching frequency of 400kHz externally synchronizable up or down by 20%
- Full-load efficiency of 89.3% at 12V<sub>IN</sub>, 88.1% at 24V<sub>IN</sub> and 85.4% at 48V<sub>IN</sub>
- 260 $\mu$ A operating current at 48V<sub>IN</sub>
- Designed for low Electromagnetic Interference (EMI)

- Dual-random spread spectrum EMI mitigation
- Meets CISPR 25 Class 5 and UNECE Reg 10 EMI standards
- Peak current-mode control architecture provides fast line and load transient response
  - Integrated slope compensation adaptive with switching frequency
  - Forced pulsed width modulation (FPWM) or pulsed frequency modulation (PFM) operation
  - Optional internal or external loop compensation
- Integrated high-side and low-side power MOSFETs
- Overcurrent protection (OCP) with hiccup mode for sustained overload conditions
- SYNCOUT signal 180° out-of-phase with internal clock
- Power-Good signal with 100k $\Omega$  pullup resistor to VCC
- Internal 3ms soft start
- Fully assembled, tested, and proven PCB layout

## Applications

- High-current [automotive electronic systems](#)
- [ADAS](#) and [body electronics](#)
- [Infotainment systems](#) and [instrument clusters](#)
- [Automotive HEV/EV powertrain systems](#)

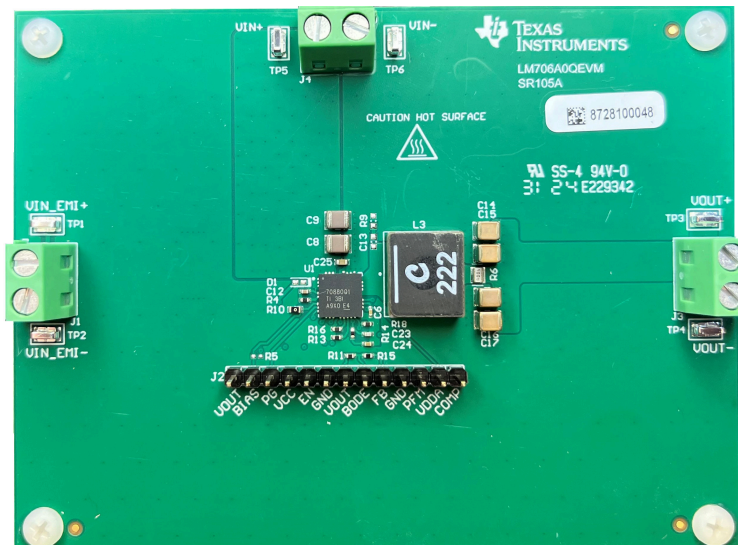

## 1 Evaluation Module Overview

### 1.1 Introduction

The [LM706A0QEVM](#) evaluation module (EVM) is a synchronous, buck, DC/DC regulator that employs synchronous rectification to achieve high conversion efficiency in a small footprint. The EVM operates over a wide input voltage range of 8V to 65V, providing a regulated output of 3.3V. The output voltage has better than 1% setpoint accuracy and is adjusted by modifying the feedback resistor values, permitting the user to customize the output voltage as needed.

The [LM706A0-Q1](#) synchronous buck converter used in the EVM has the following features:

- Wide input voltage (wide  $V_{IN}$ ) range of 4.5V to 65V
- Spread spectrum modulation for lower EMI
- Wide duty cycle range with low  $t_{ON(min)}$  and  $t_{OFF(min)}$
- Ultra-low shutdown and no-load standby quiescent currents
- Multiphase capability
- Peak current-mode control loop architecture
- Integrated, high-current MOSFETs
- Cycle-by-cycle overcurrent protection with hiccup

### 1.2 Kit Contents

- LM706A0QEVM Circuit Board
- EVM Disclaimer Read Me
- Prototype EVM Disclaimer Read Me

### 1.3 Specification

The following figure shows the schematic of an LM706A0-Q1-based synchronous buck converter.

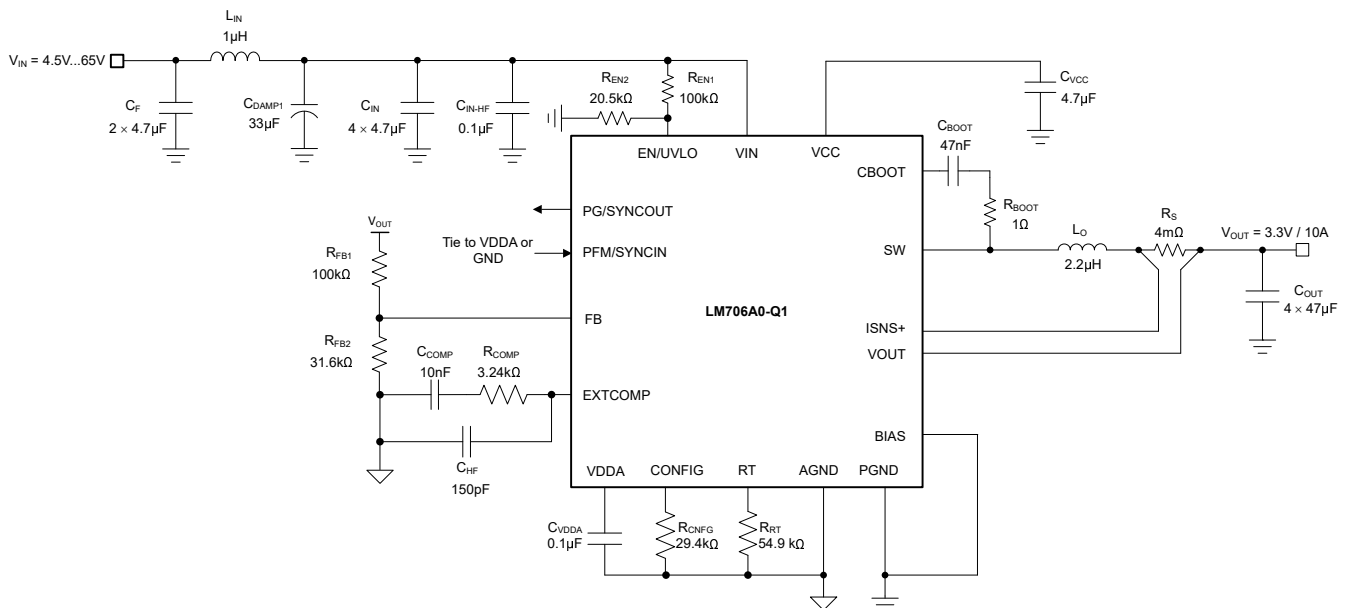

Figure 1-1. LM706A0-Q1 Synchronous Buck Regulator Simplified Schematic

### 1.4 Device Information

The free-running switching frequency of the EVM is 400kHz and is synchronizable to a higher or lower frequency, if required. VCC and gate drive UVLO protects the regulator at low input voltage conditions, and EN pin supports application-specific power-up and power-down requirements. The [LM706A0-Q1](#) is available in a 29-pin VQFN package with 6mm x 6mm footprint to enable DC/DC devices with high density and low component count. See the [LM706A0-Q1 65V, 10A, Automotive, High-Efficiency Buck Converter Optimized for High Power Density data sheet](#) for more information.

## 2 Hardware

### 2.1 Test Setup and Procedure

#### 2.1.1 EVM Connections

Referencing the EVM connections described in [Table 2-1](#), the recommended test setup to evaluate the LM706A0-Q1 is shown in [Figure 2-1](#). Working at an ESD-protected workstation, make sure that any wrist straps, boot straps, or mats are connected and referencing the user to earth ground before handling the EVM.

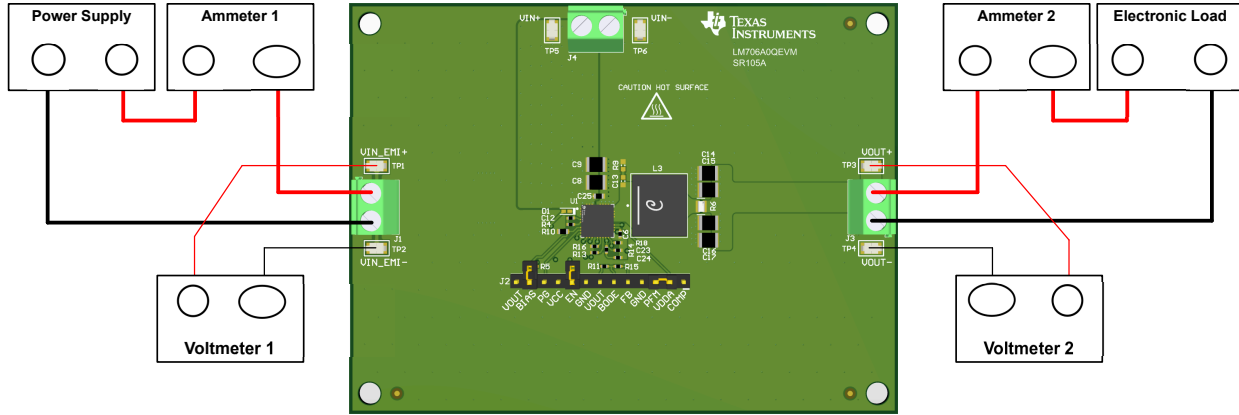

Figure 2-1. EVM Test Setup

#### Note

Refer to the [LM706A0-Q1 65V, 10A, Automotive, High-Efficiency Buck Converter Optimized for High Power Density](#) data sheet, [LM706A0-Q1 Quickstart Calculator](#), and [WEBENCH® Power Designer](#) for additional guidance pertaining to component selection and converter operation.

Table 2-1. EVM Power Connections

LABEL	DESCRIPTION
VIN_EMI+	Positive input voltage power and sense connection with EMI filter
VIN_EMI-	Positive input voltage power and sense connection with EMI filter
VIN+	Positive input voltage power and sense connection bypassing EMI filter
VIN-	Negative input voltage power and sense connection bypassing EMI filter
VOUT+	Positive output voltage power and sense connection
VOUT-	Negative output voltage power and sense connection

Table 2-2. EVM Signal Connections

LABEL	DESCRIPTION
VOUT	Output voltage
BIAS	Optional external bias supply for higher efficiency
PG	Power-Good indicator
VCC	Internally generated bias supply connection for the gate drivers
EN	ENABLE input – tie to GND to disable the device
GND	GND connection
VOUT	Output voltage
BODE	50Ω injection point for loop response
FB	FB node
GND	GND connection
PFM	PFM / FPWM selection and synchronization input
VDDA	Bias supply connection for the analog circuits
COMP	Error amplifier output

## 2.1.2 Test Equipment

**Voltage Source:** Use an input voltage source capable of supplying 0V to 65V and 12A.

### Multimeters:

- **Voltmeter 1:** Input voltage at VIN+ to VIN–. Set the voltmeter to an input impedance of 100M $\Omega$ .
- **Voltmeter 2:** Output voltage at VOUT to GND. Set the voltmeter to an input impedance of 100M $\Omega$ .
- **Ammeter 1:** Input current. Set the ammeter to 1-second aperture time.
- **Ammeter 2:** Output current. Set the ammeter to 1-second aperture time.

**Electronic Load:** The load must be an electronic constant-resistance (CR) or constant-current (CC) mode load capable of 0A<sub>DC</sub> to 15A<sub>DC</sub> at 3.3V. For a no-load input current measurement, disconnect the electronic load as the load can draw a small residual current.

**Oscilloscope:** With the scope set to 20MHz bandwidth and AC coupling, measure the output voltage ripple directly across an output capacitor with a short ground lead normally provided with the scope probe. Place the oscilloscope probe tip on the positive terminal of the output capacitor, holding the ground barrel of the probe through the ground lead to the negative terminal of the capacitor. TI does not recommend using a long-leaded ground connection because this action can induce additional noise given a large ground loop. To measure other waveforms, adjust the oscilloscope as needed.

**Safety:** Always use caution when touching any circuits that can be live or energized.

## 2.1.3 Recommended Test Setup

### 2.1.3.1 Input Connections

1. Prior to connecting the DC input source, set the current limit of the input supply to 0.1A maximum. Make sure the input source is initially set to 0V and connected to the VIN+ and VIN– connection points as shown in [Figure 2-1](#).
2. Connect voltmeter 1 at VIN+ and VIN– connection points to measure the input voltage.
3. Connect ammeter 1 to measure the input current and set to at least 1-second aperture time.

### 2.1.3.2 Output Connections

1. Connect electronic load to VOUT connection. Set the load to constant-resistance mode or constant-current mode at 0A before applying input voltage.
2. Connect voltmeter 2 at VOUT and GND connections to measure the output voltage.
3. Connect ammeter 2 to measure the output current.

## 2.1.4 Test Procedure

### 2.1.4.1 Line and Load Regulation, Efficiency

1. Set up the EVM as previously described.
2. Set the load to constant resistance or constant current mode and to sink 0A.
3. Increase input source from 0V to 48V; use voltmeter 1 to measure the input voltage.
4. Increase the current limit of the input supply to 15A.
5. Using voltmeter 2 to measure the output voltage, V<sub>OUT</sub>, vary the load current from 0A to 10A<sub>DC</sub>; V<sub>OUT</sub> must remain within the load regulation specification.
6. Set the load current to 5A (50% rated load) and vary the input source voltage from 8V to 65V; V<sub>OUT</sub> must remain within the line regulation specification.
7. Decrease load to 0A. Decrease input source voltage to 0V.

## 3 Implementation Results

### 3.1 Performance Data and Results

Figure 3-1 through Figure 3-15 present typical performance curves for the LM706A0QEVM. Because actual performance data can be affected by measurement techniques and environmental variables, these curves are presented for reference and can differ from actual field measurements.

#### 3.1.1 EVM Characteristics

The following table lists the electrical characteristics.

**Table 3-1. Electrical Performance Characteristics of EVM**

Parameter	Test Conditions		MIN	TYP	MAX	Unit
<b>INPUT CHARACTERISTICS</b>						
Input voltage range, $V_{IN}$	Operating		8	24	65	V
Input current, no load, $I_{IN-NL}$	$I_{OUT} = 0A$ , PFM tied to VDDA	$V_{IN} = 12V$	0.137		mA	
		$V_{IN} = 24V$	0.233			
		$V_{IN} = 48V$	0.435			
		$V_{IN} = 60V$	0.537			
Input current, shutdown, $I_{IN-OFF}$	$V_{EN} = 0V$ ,	$V_{IN} = 48V$	0.490		mA	
<b>OUTPUT CHARACTERISTICS</b>						
Output voltage, $V_{OUT}$ <sup>(1)</sup>			3.275	3.3	3.324	V
Output current, $I_{OUT}$	$V_{IN} = 8V$ to 60V, Airflow = 100 LFM <sup>(2)</sup>		0		10	A
Output voltage regulation, $\Delta V_{OUT}$	Load regulation	$I_{OUT} = 0A$ to 10A	0.1%			
	Line regulation	$V_{IN} = 8V$ to 60V	1%			
Output voltage ripple, $V_{OUT-AC}$	$V_{IN} = 48V$ , $I_{OUT} = 10A$		10		mVrms	
Output overcurrent protection, $I_{OCP}$	$V_{IN} = 48V$		12		A	
Soft-start time, $t_{SS}$			3		ms	
<b>SYSTEM CHARACTERISTICS</b>						
Switching frequency, $F_{SW-nom}$	$V_{IN} = 48V$		400		kHz	
PFM Light-load efficiency, $\eta_{LIGHT}$ <sup>(1)</sup>	$I_{OUT} = 1A$	$V_{IN} = 24V$	84.6%			
		$V_{IN} = 48V$	75.7%			
		$V_{IN} = 60V$	72.4%			
Half-load efficiency, $\eta_{HALF}$	$I_{OUT} = 5A$	$V_{IN} = 24V$	90.8%			
		$V_{IN} = 48V$	86.5%			
		$V_{IN} = 60V$	84.4%			
Full load efficiency, $\eta_{FULL}$	$I_{OUT} = 10A$	$V_{IN} = 24V$	88%			
		$V_{IN} = 48V$	85.3%			
		$V_{IN} = 60V$	83.9%			
LM706A0-Q1 junction temperature, $T_J$			-40		150	°C

- (1) The default output voltage of this EVM is 3.3V. Efficiency and other performance metrics can change based on operating input voltage, load currents, externally-connected output capacitors, and other parameters.
- (2) The recommended airflow when operating at input voltages greater than 60V is 100 LFM.

### 3.1.2 Conversion Efficiency

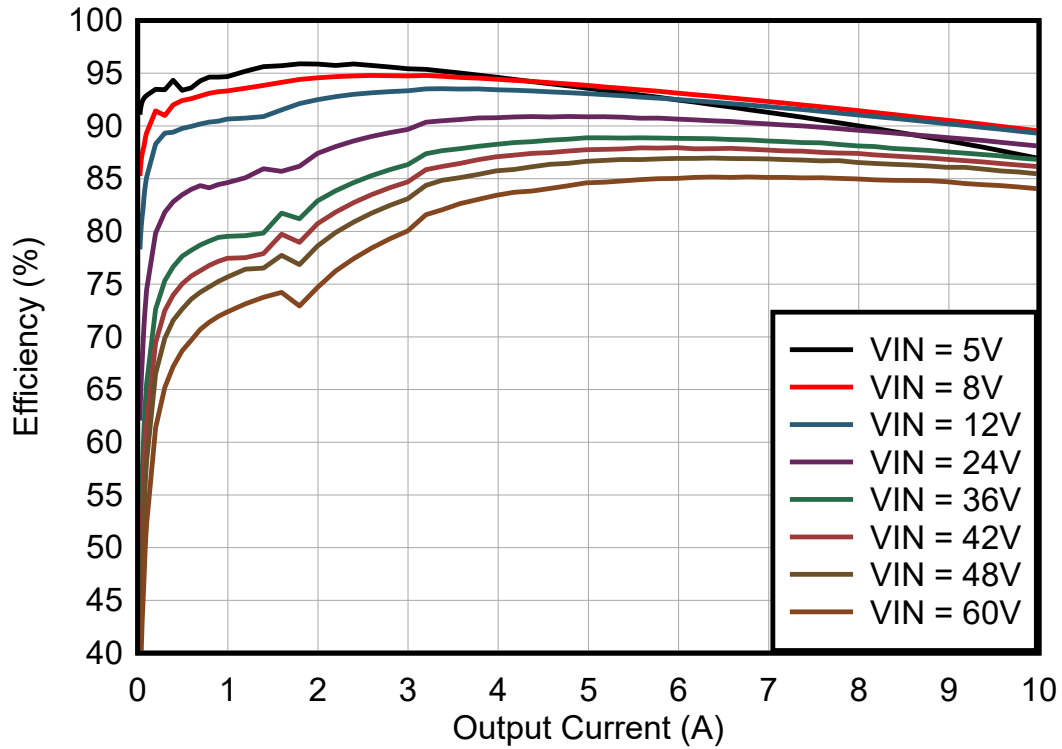

Figure 3-1. Efficiency,  $V_{IN} = V_{EN} = 5V$  to  $60V$ ,  $V_{OUT} = 3.3V$ , PFM Mode, Linear Scale

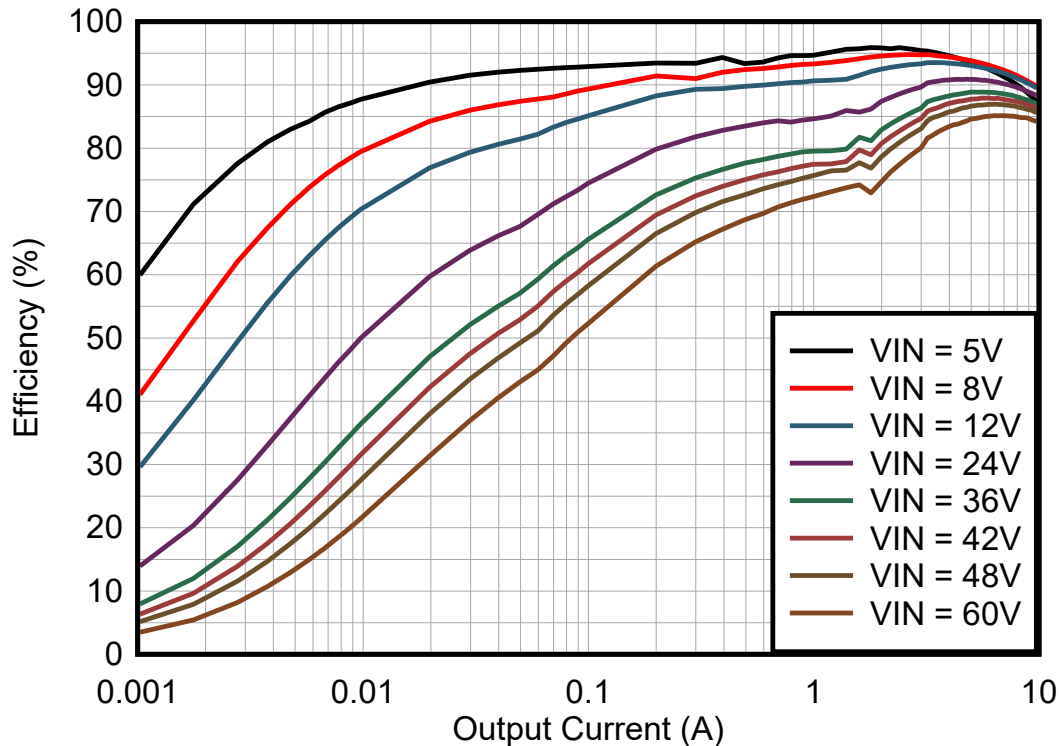

Figure 3-2. Efficiency,  $V_{IN} = V_{EN} = 5V$  to  $60V$ ,  $V_{OUT} = 3.3V$ , PFM Mode, Logarithmic Scale

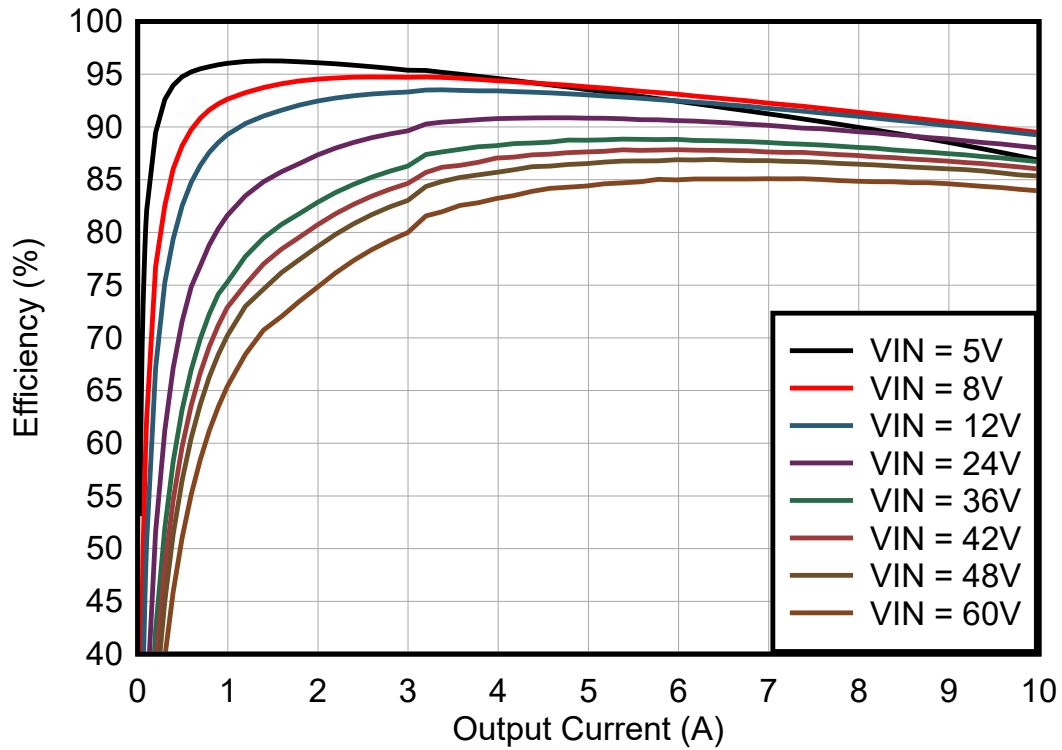

Figure 3-3. Efficiency,  $V_{IN} = V_{EN} = 5V$  to  $60V$ ,  $V_{OUT} = 3.3V$ , FPWM Mode, Linear Scale

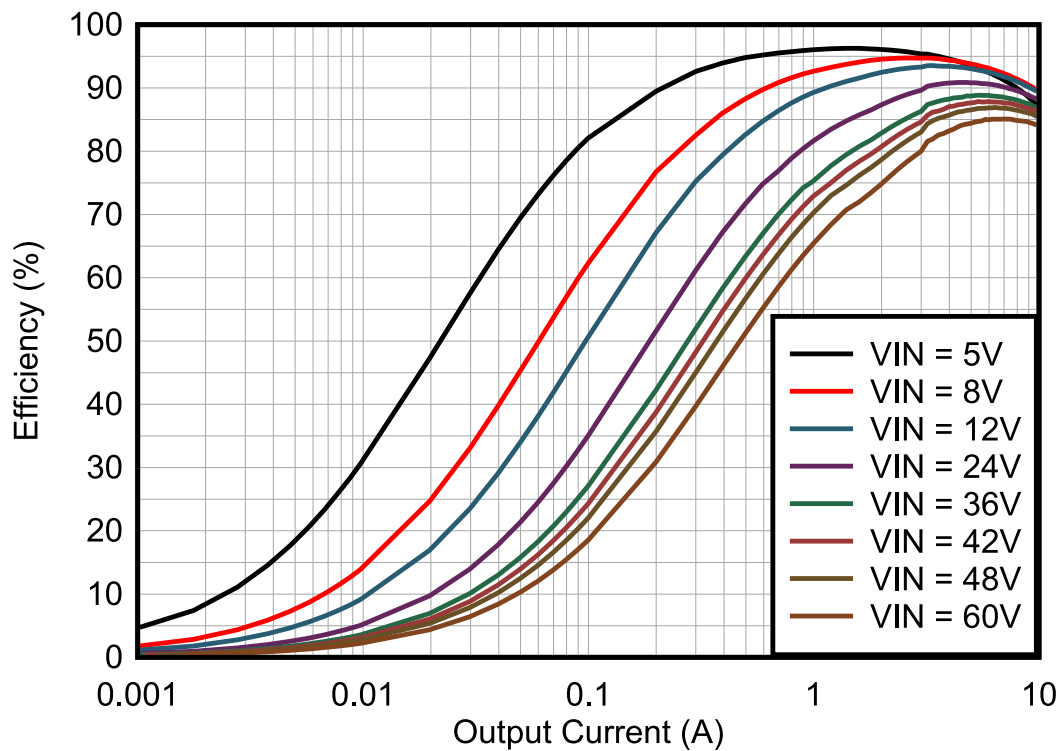

Figure 3-4. Efficiency,  $V_{IN} = V_{EN} = 5V$  to  $60V$ ,  $V_{OUT} = 3.3V$ , FPWM Mode, Logarithmic Scale

### 3.1.3 Operating Waveforms

#### 3.1.3.1 Switching

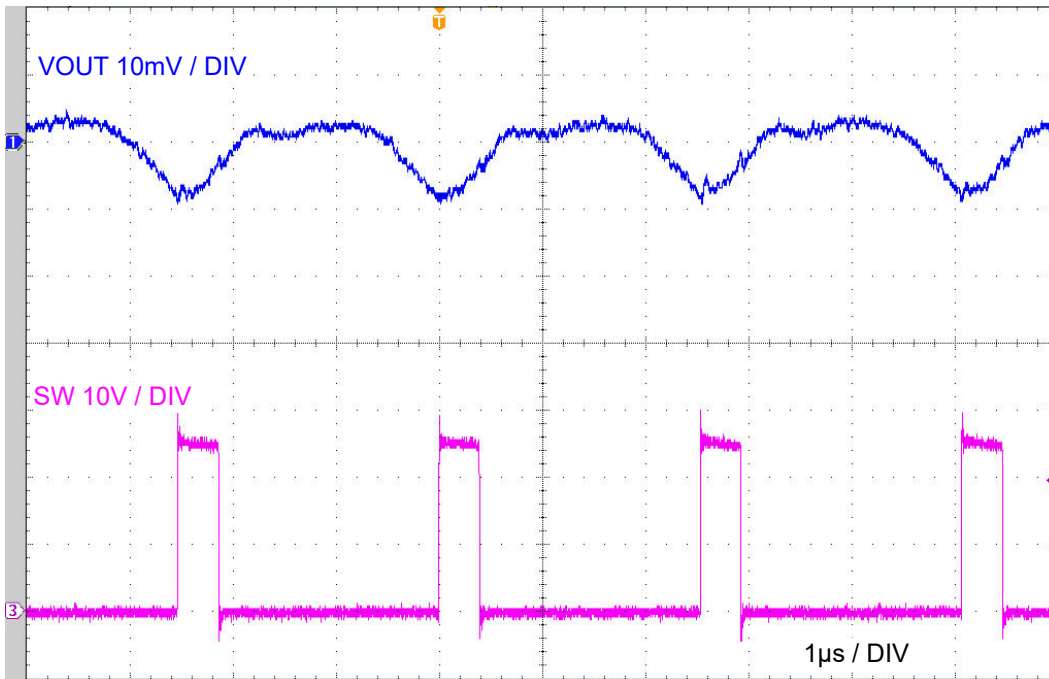

Figure 3-5. Steady State Operation,  $V_{IN} = 24V$ ,  $V_{OUT} = 3.3V$ ,  $I_{OUT} = 10A$ ,  $F_{SW} = 400kHz$

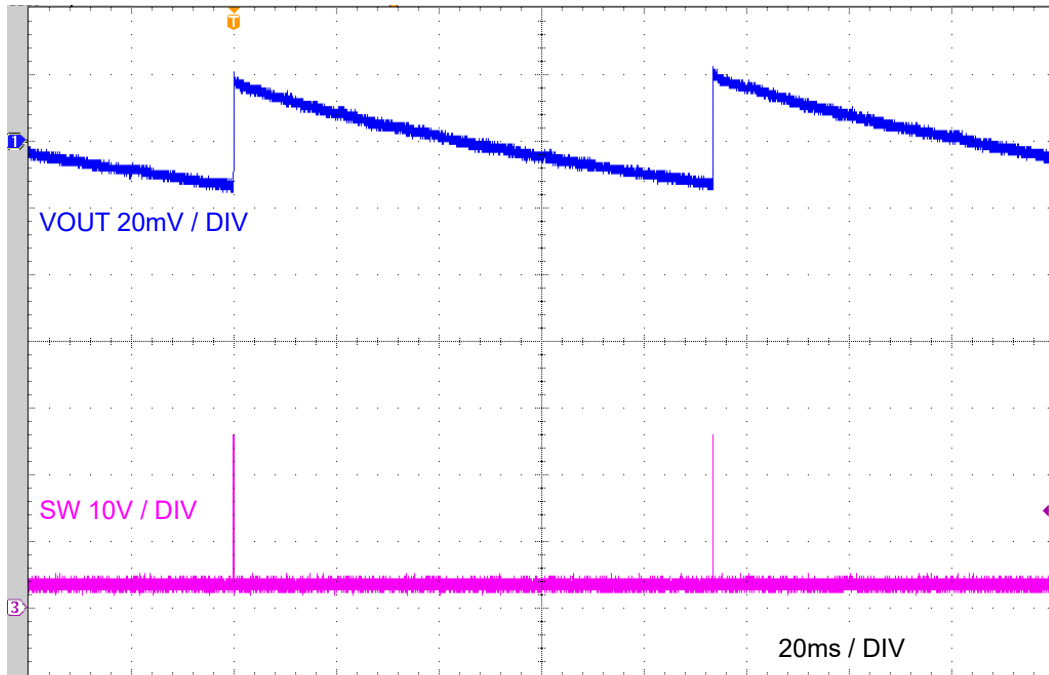

Figure 3-6. Steady State Operation in PFM Mode,  $V_{IN} = 24V$ ,  $V_{OUT} = 3.3V$ ,  $I_{OUT} = 0A$



### 3.1.3.2 Load Transient Response

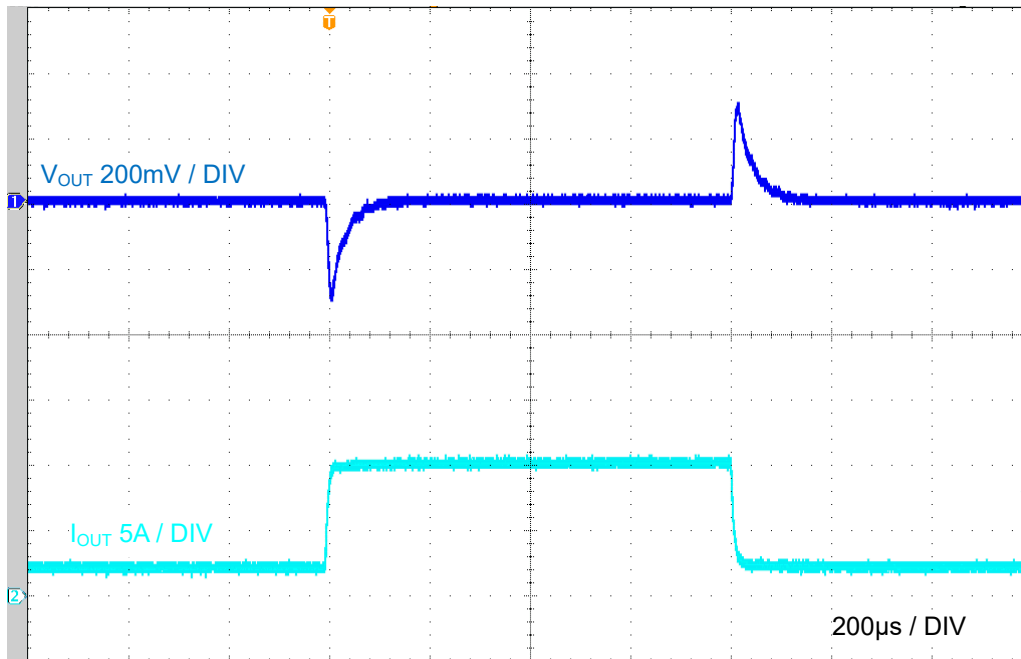

Figure 3-7. Load Transient Response,  $V_{IN} = 24V$ ,  $V_{OUT} = 3.3V$ ,  $F_{SW} = 400kHz$ , FPWM, 2A to 10A at 1A/ $\mu$ s

### 3.1.3.3 Short-Circuit Recovery

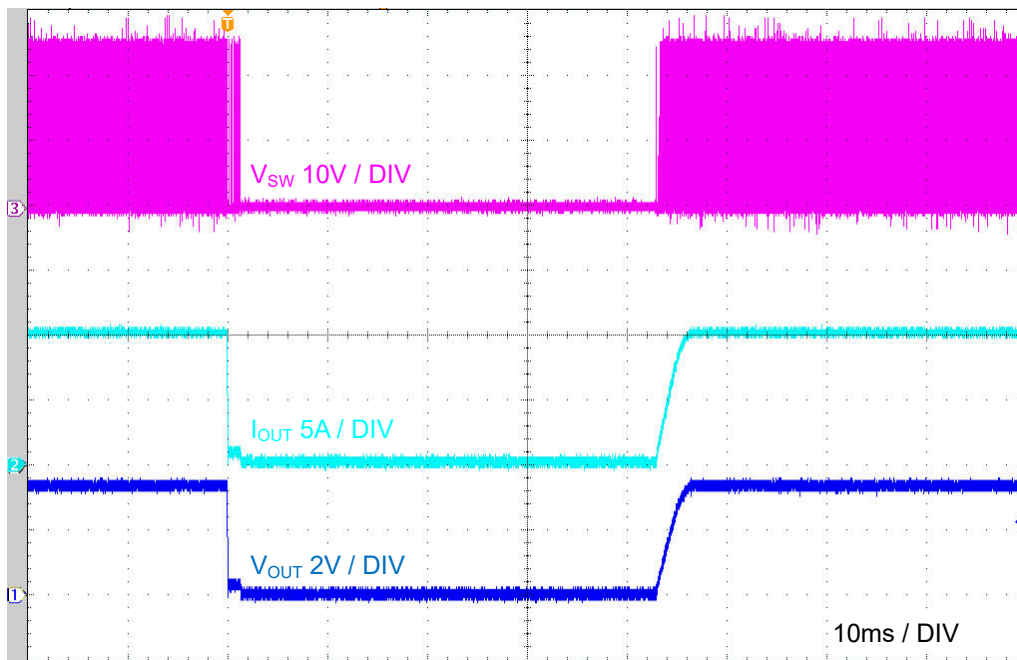

Figure 3-8. Short-Circuit Recovery  $V_{IN} = 24V$ ,  $V_{OUT} = 3.3V$ ,  $I_{OUT} = 10A$ ,  $F_{SW} = 400kHz$ , FPWM

### 3.1.3.4 Start-Up and Shutdown With EN

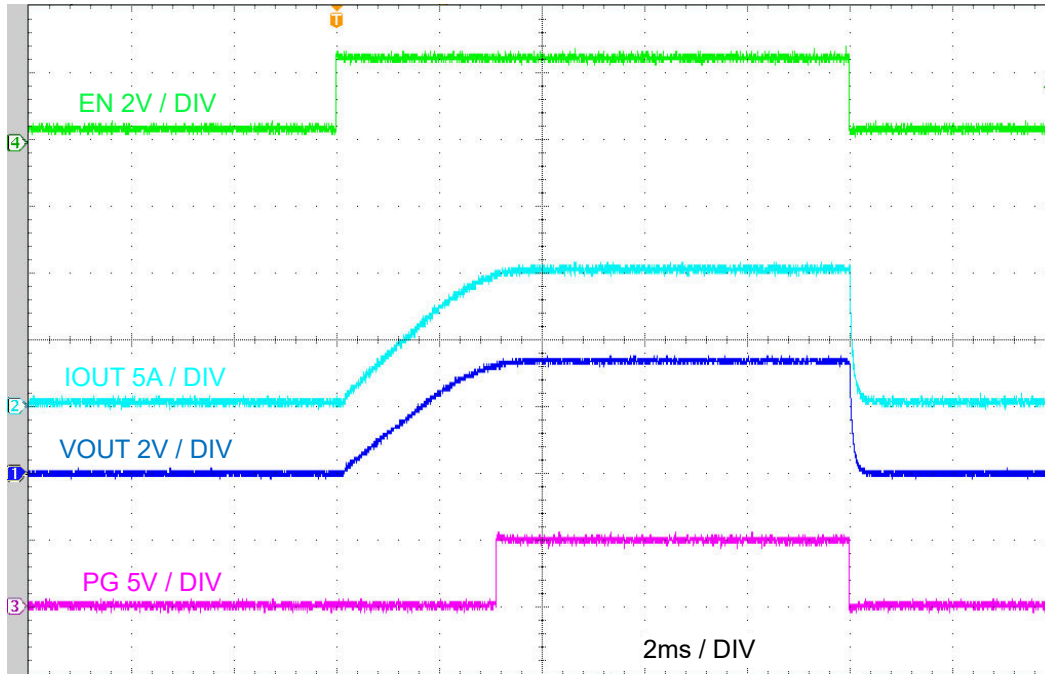

Figure 3-9. EN ON and OFF,  $V_{IN} = 24V$ ,  $V_{OUT} = 3.3V$ ,  $I_{OUT} = 10A$  Resistive Load,  $F_{SW} = 400kHz$ , FPWM

### 3.1.3.5 Start-Up With VIN

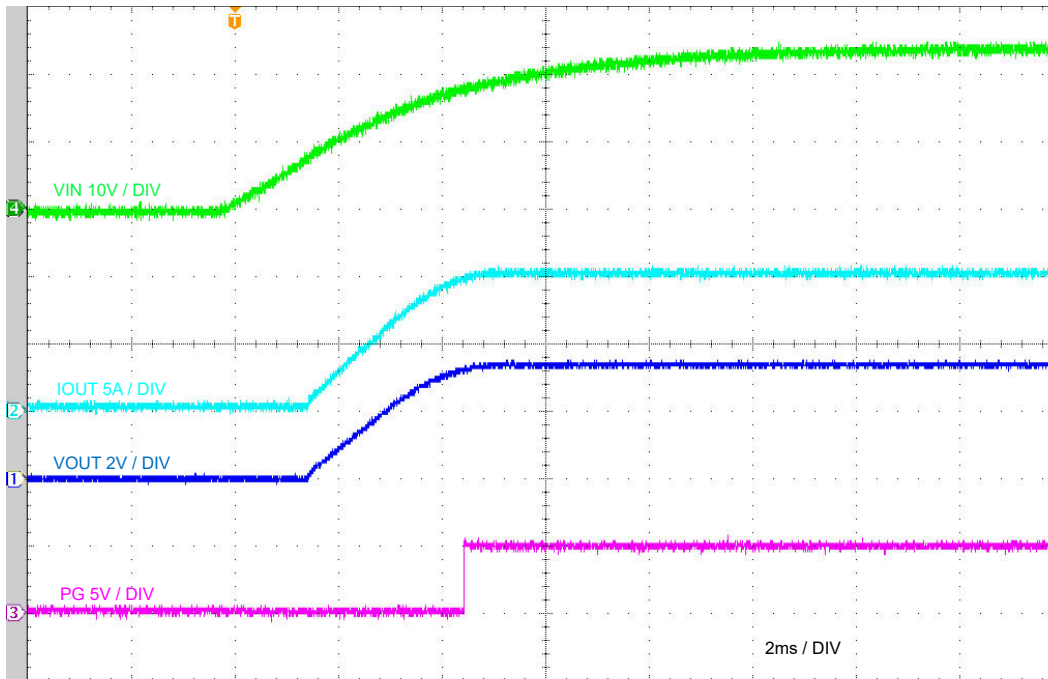
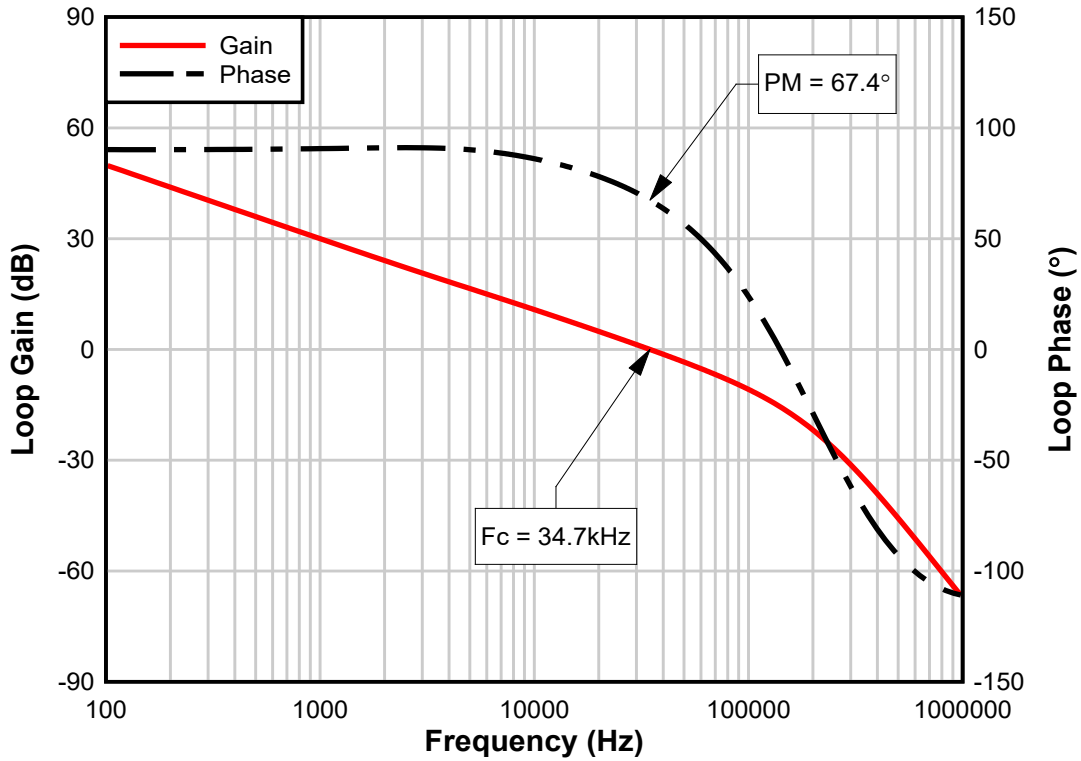

Figure 3-10. Start-Up,  $V_{IN} = 24V$ ,  $V_{OUT} = 3.3V$ ,  $I_{OUT} = 10A$  Resistive Load,  $F_{SW} = 400kHz$  FPWM

### 3.1.4 Bode Plot



$F_c$  = crossover frequency, PM = phase margin.

**Figure 3-11. Bode Plot,  $V_{IN} = 24\text{V}$ ,  $V_{OUT} = 3.3\text{V}$ ,  $I_{OUT} = 10\text{A}$  Resistive Load**

### 3.1.5 CISPR 25 EMI Performance

Figure 3-12 and Figure 3-13 presents the EMI performance of the LM706A0-Q1 EVM at 13.5V and 24V input with DRSS EMI mitigation disabled. Conducted emissions are measured over a frequency range of 150kHz to 108MHz using a 5μH LISN according to the CISPR 25 specification. CISPR 25 Class 5 peak and average limit lines are denoted in red. The purple and green spectra are measured using peak and average detection, respectively.

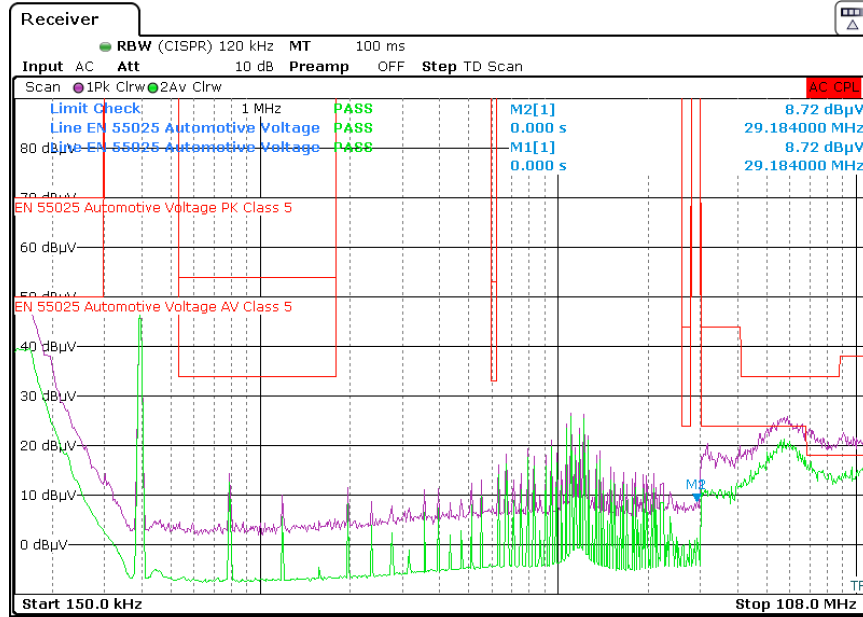

Figure 3-12. CISPR 25 Class 5 Conducted Emissions Plot, 150kHz to 108MHz,  $V_{IN} = 13.5V$ ,  $V_{OUT} = 3.3V$ ,  $I_{OUT} = 10A$  Resistive Load,  $F_{SW} = 400kHz$

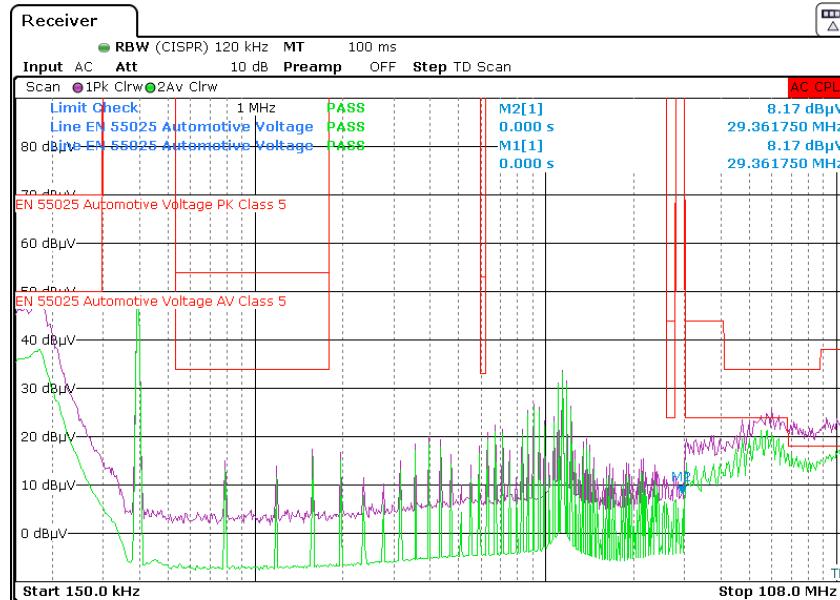

Figure 3-13. CISPR 25 Class 5 Conducted Emissions Plot, 150kHz to 108MHz,  $V_{IN} = 24V$ ,  $V_{OUT} = 3.3V$ ,  $I_{OUT} = 10A$  Resistive Load,  $F_{SW} = 400kHz$

### 3.1.6 Thermal Performance

Figure 3-14 and Figure 3-15 show the thermal performance image.

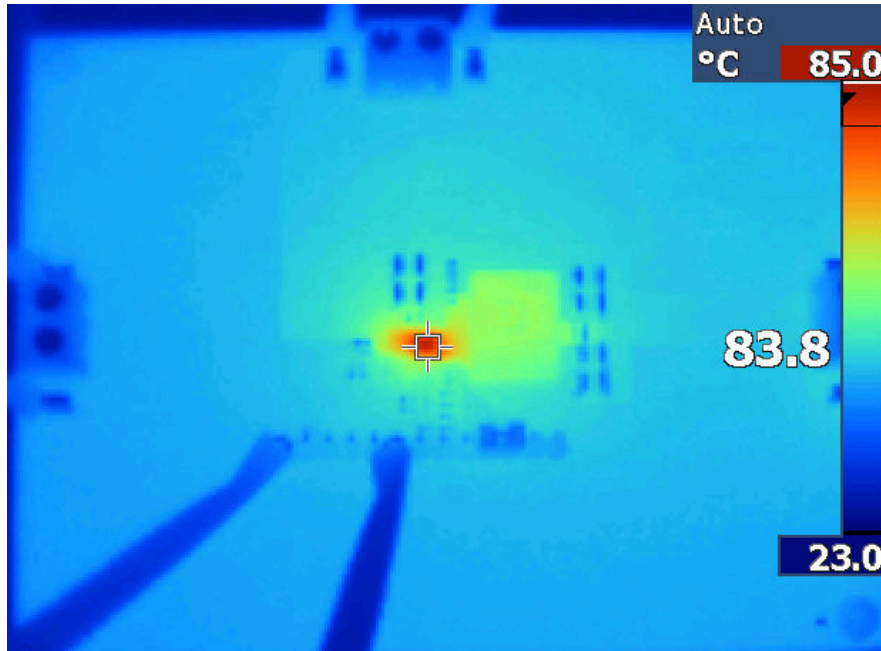

Figure 3-14. Thermal Performance,  $V_{IN} = 12V$ ,  $V_{OUT} = 3.3V$ ,  $I_{OUT} = 10A$ ,  $T_{amb} = 25^{\circ}C$ , No Airflow

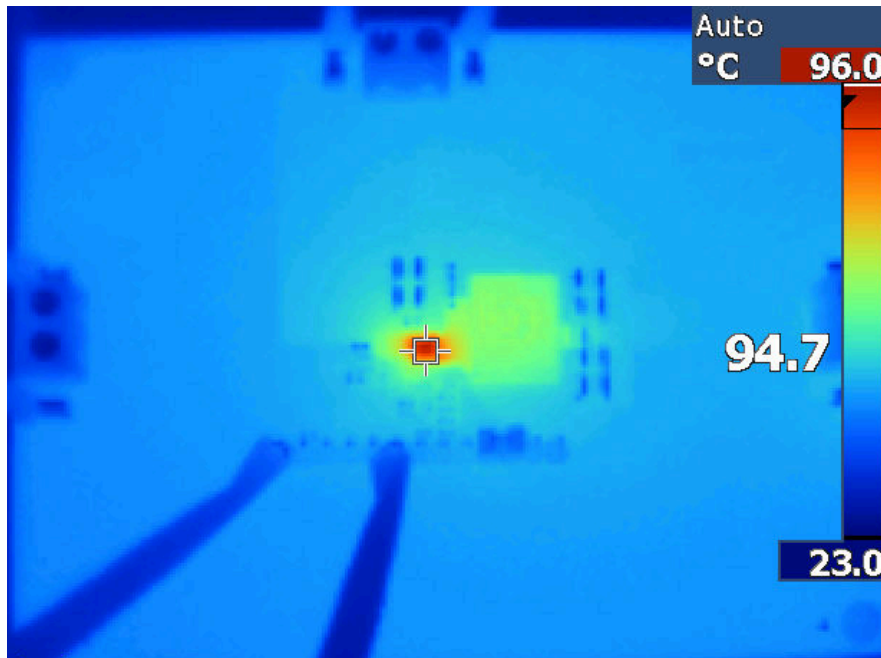

Figure 3-15. Thermal Performance,  $V_{IN} = 24V$ ,  $V_{OUT} = 3.3V$ ,  $I_{OUT} = 10A$ ,  $T_{amb} = 25^{\circ}C$ , No Airflow

## 4 Hardware Design Files

### 4.1 Schematic

The following image shows the EVM schematic.

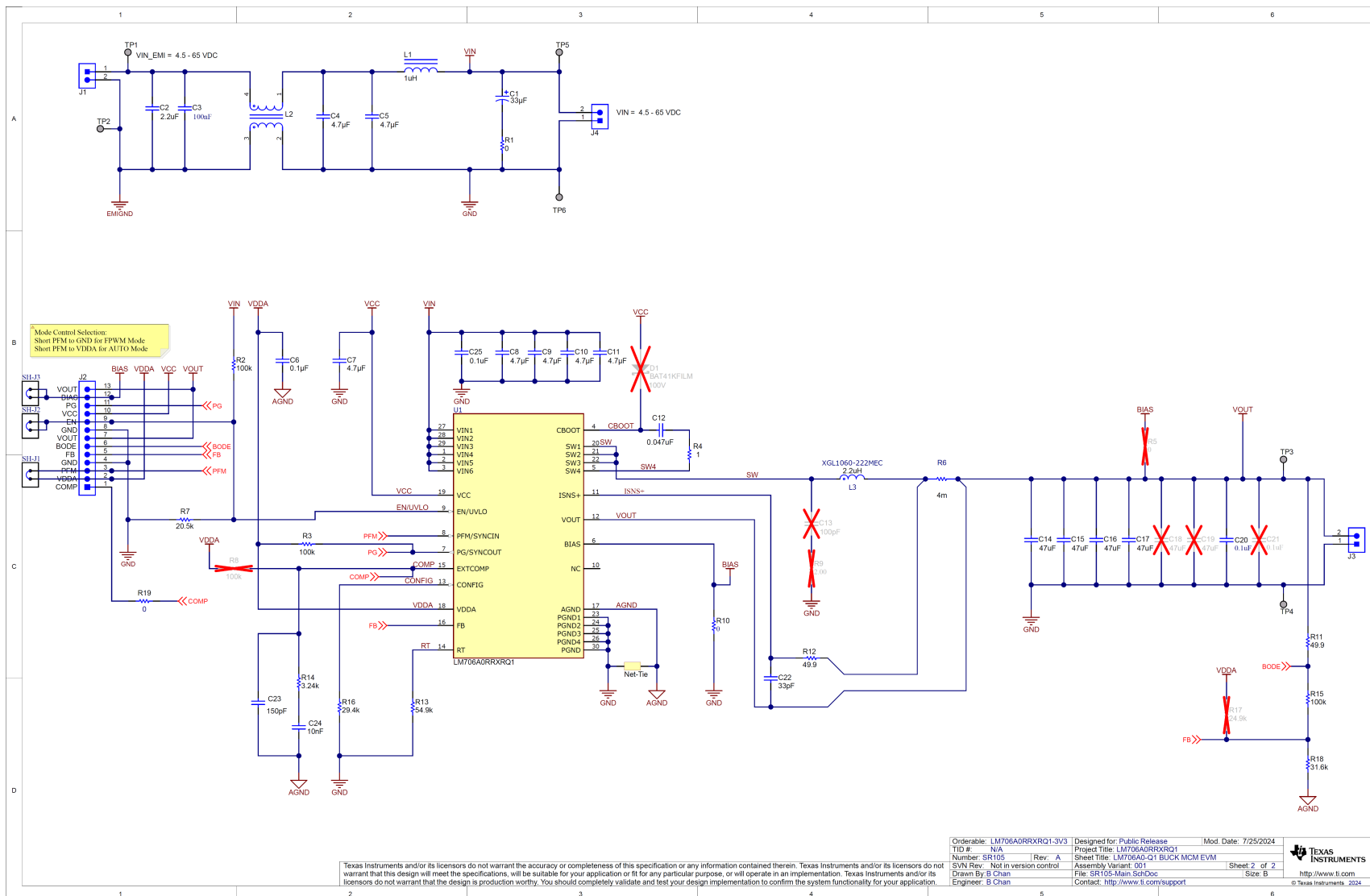

Figure 4-1. EVM Schematic

## 4.2 PCB Layout

Figure 4-2 through Figure 4-9 show the design of the LM706A0-Q1 EVM using a six-layer PCB with 2oz copper thickness.

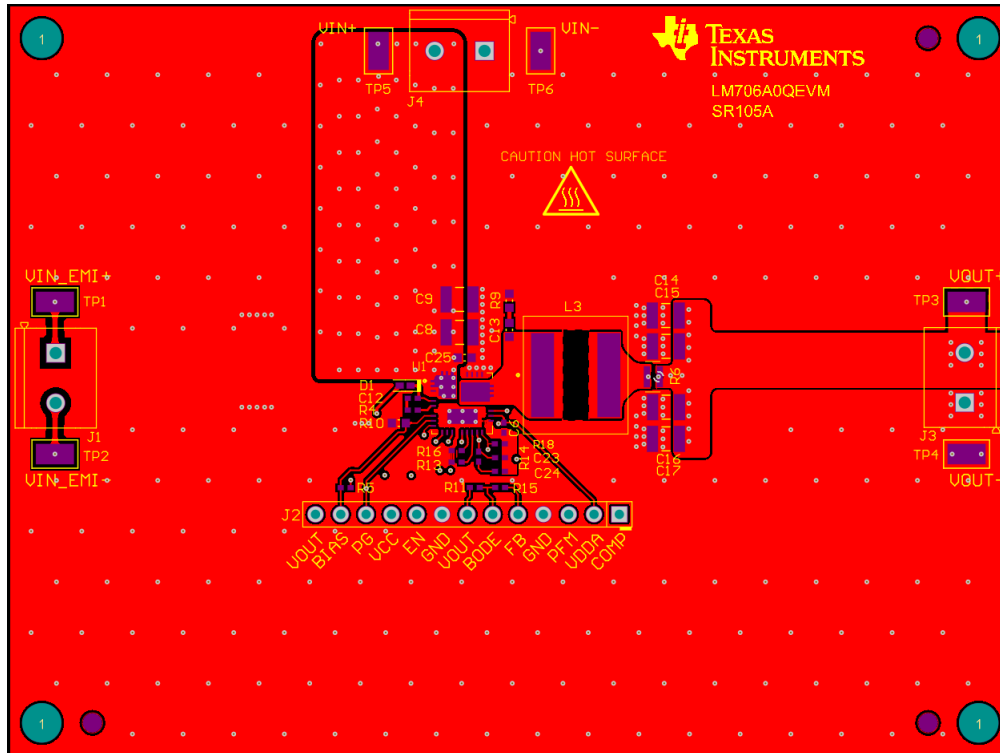

Figure 4-2. Top Copper (Top View)

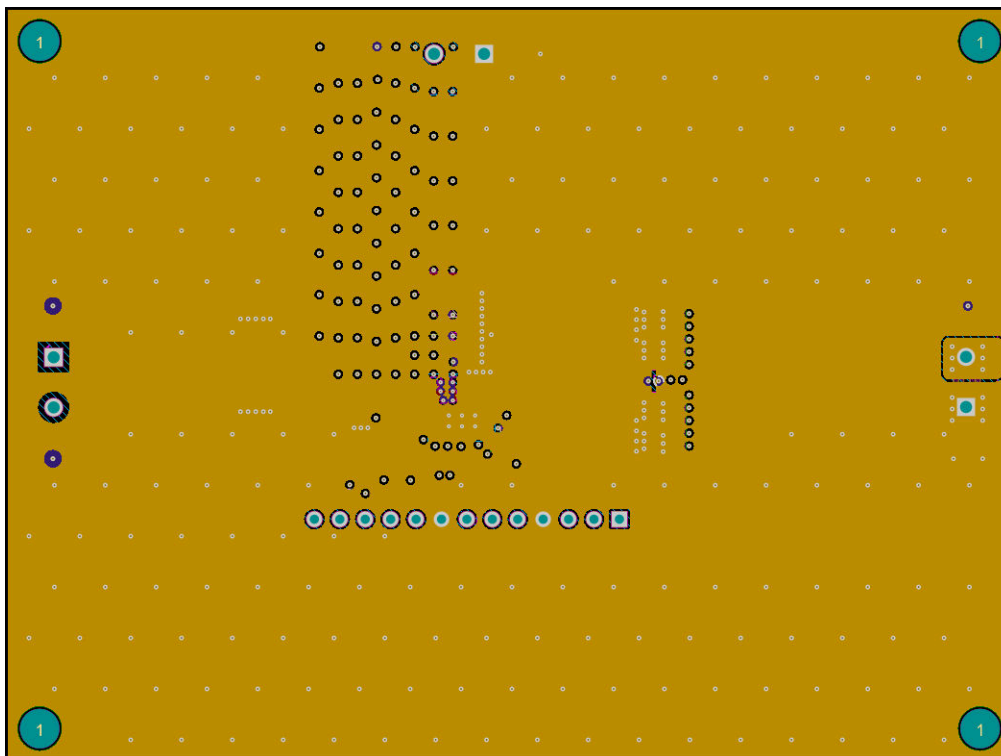

Figure 4-3. Layer 2 Copper (Top View)

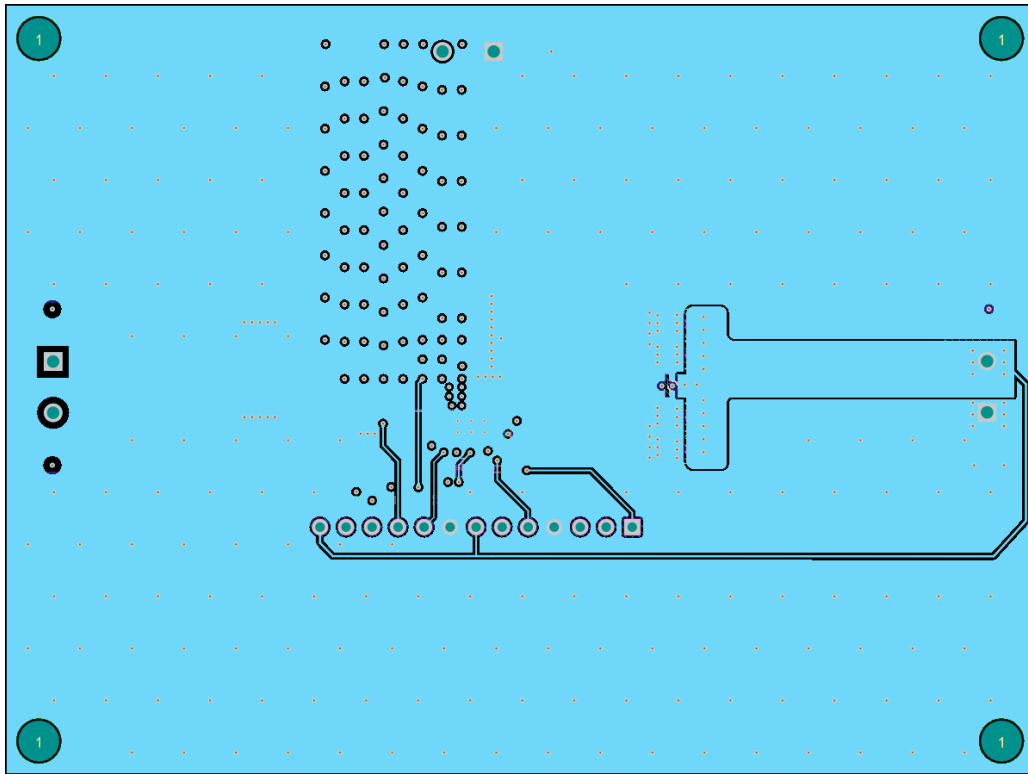

Figure 4-4. Layer 3 Copper (Top View)

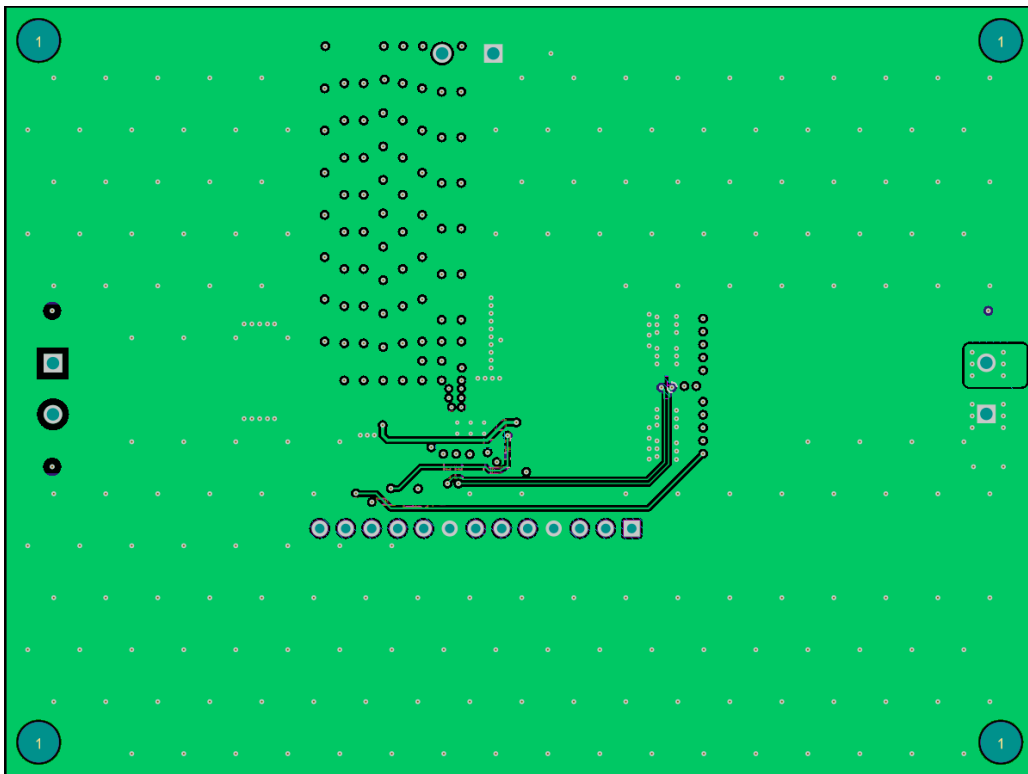

Figure 4-5. Layer 4 Copper (Top View)



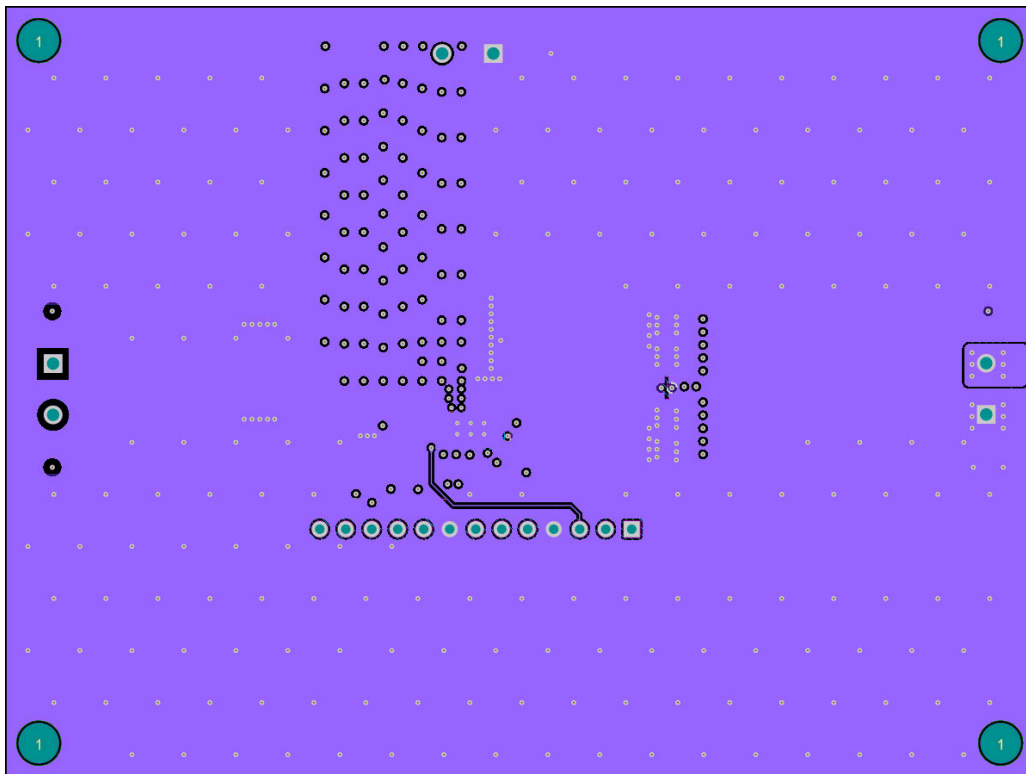

Figure 4-6. Layer 5 Copper (Top View)

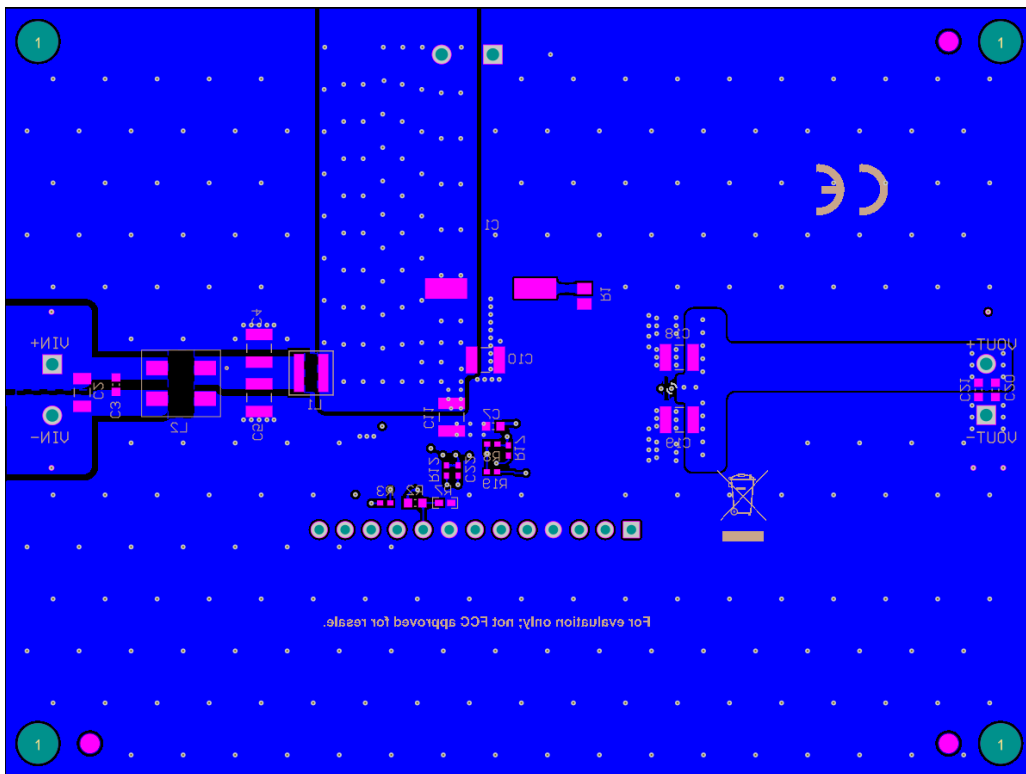

Figure 4-7. Bottom Copper (Top View)

### 4.2.1 Component Drawings

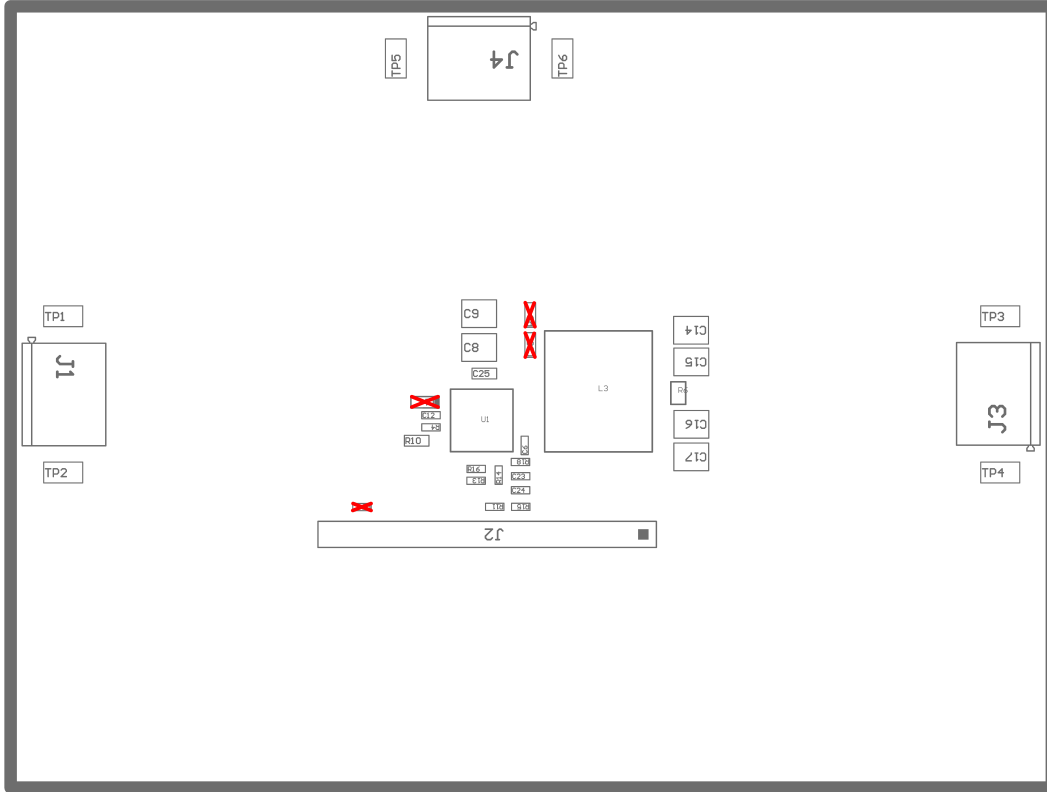

Figure 4-8. Top Component Drawing

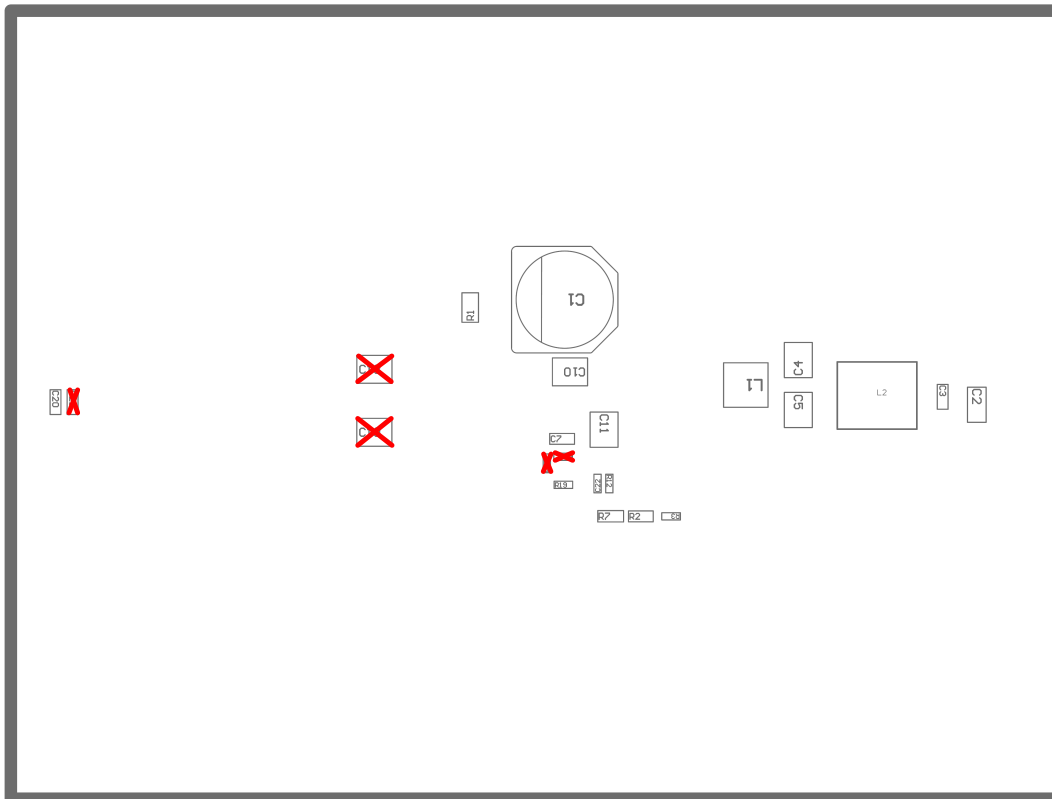

Figure 4-9. Bottom Component Drawing

### 4.2.2 Multi-Layer Stackup

#	Name	Material	Type	Weight	Thickness	Dk
	Top Overlay		Overlay			
	Top Solder	Solder Resist	Solder Mask		0.4mil	3.5
1	Top Layer		Signal	2oz	2.8mil	
	Dielectric1	FR4 Hi Tg	Core		9mil	4.8
2	Signal Layer 1		Signal	2oz	2.8mil	
	Dielectric 2	FR4 Hi Tg	Prepreg		9mil	4.2
3	Signal Layer 2		Signal	2oz	2.8mil	
	Dielectric 3	FR4 Hi Tg	Core		9mil	4.2
4	Signal Layer 3		Signal	2oz	2.8mil	
	Dielectric 4	FR4 Hi Tg	Prepreg		9mil	4.2
5	Signal Layer 4		Signal	2oz	2.8mil	
	Dielectric 5	FR4 Hi Tg	Core		9mil	4.2
6	Bottom Layer		Signal	2oz	2.8mil	
	Bottom Solder	Solder Resist	Solder Mask		0.4mil	3.5
	Bottom Overlay		Overlay			

Figure 4-10. Layer Stackup

### 4.3 Bill of Materials

**Table 4-1. Bill of Materials**

QTY	REF DES	DESCRIPTION	PART NUMBER	MFR
1	C1	Capacitor, Aluminum, 33μF, 100V, ±20%, 1Ω, AEC-Q200	EEE-TG2A330P	Panasonic
1	C2	Capacitor, Ceramic, 2.2μF, 100V, ±10%, X7S, 1206, AEC-Q200	CGA5L3X7S2A225K160AB	TDK
2	C3, C25	Capacitor, Ceramic, 0.1μF, 100V, ±10%, X7R, 0603, AEC-Q200	GCJ188R72A104KA01D	Murata
6	C4, C5, C8, C9, C10, C11	Capacitor, Ceramic, 4.7μF, 100V, ±10%, X7S, 1210, AEC-Q200	GCM32DC72A475KE02L	Murata
			CGA6M3X7S2A475K200AB	TDK
1	C6	Capacitor, Ceramic, 0.1μF, 10V, ±10%, X7R, 0402, AEC-Q200	C0402C104K8RACAUTO	Kemet
1	C7	Capacitor, Ceramic, 4.7μF, 10V, ±20%, X7R, 0603	GRM188Z71A475ME15D	Murata
1	C12	Capacitor, Ceramic, 0.1μF, 25V, ±10%, X7R, 0402	CGA2B3X7R1H473K050BB	TDK
4	C14, C15, C16, C17	Capacitor, Ceramic, 47μF, 10V, ±10%, X7R, 1210	GRM32ER71A476KE15L	Murata
1	C20	Capacitor, Ceramic, 0.1μF, 50V, ±10%, X7R, 0603 AEC-Q200	CGA3E2X7R1H104K080AA	TDK
1	C22	Capacitor, Ceramic, 33pF, 50V, ±5%, C0G/NP0, 0402, AEC-Q200	GCM1555C1H330JA16D	Murata
1	C23	Capacitor, Ceramic, 150pF, 50V, ±5%, C0G/NP0, 0402, AEC-Q200	CGA2B2C0G1H151J050BA	TDK
1	C24	Capacitor, Ceramic, 10nF, 50V, X7R, ±10%, 0402, AEC-Q200	CGA2B3X7R1H103K050BB	TDK
3	J1, J3, J4	Terminal Block, 2 position, 5mm, TH	1729018	Phoenix Contact
1	J2	Header, 100 mil, 13 × 1, Gold, TH	TSW-113-07-G-S	Samtec
1	L1	Inductor, shielded, 1μH, 12mΩ typical, 7.2A, SMD 4.1 × 4.1 × 2.1mm typical, AEC-Q200	74438356010	Würth Elektronik
1	L2	Common Mode Choke, 700Ω at 100MHz, 4A, 15mΩ, 7.0 × 6.0 × 3.8mm typical, AEC-Q200	CM7060P701R-10	Laird
1	L3	Inductor, 2.2μH, 4.3mΩ, 25.3A, 10 × 11.3 × 6mm typical, AEC-Q200	XGL1060-222MEC	Coilcraft
1	R1	Resistor, Chip, 0Ω, 1/8 W, 5%, 0805, AEC-Q200	ERJ-6GEY0R00V	Panasonic
1	R2	Resistor, Chip, 100kΩ, 1/10 W, 1%, 0603, AEC-Q200	CRCW0603100KFKEA	Vishay-Dale
1	R3	Resistor, Chip, 100kΩ, 1/16 W, 1%, 0402, AEC-Q200	RMCF0402FT100K	Stackpole Electronics Inc
1	R4	Resistor, Chip, 1Ω, 1/16 W, 1%, 0402, AEC-Q200	CRCW04021R00FKED	Vishay-Dale
1	R6	Resistor, Chip, 4mΩ, 1W Chip Resistor Wide, 1%, 0508, AEC-Q200, Current Sense Metal Foil	KRL2012E-M-R004-F-T5	Susumu
1	R7	Resistor, Chip, 20.5kΩ, 1/16 W, 1%, 0402, AEC-Q200	CRCW040220K5FKED	Vishay-Dale
1	R10	Resistor, Chip, 0Ω, 1/10 W, 1%, 0603, AEC-Q200	CRCW06030000Z0EA	Vishay-Dale
2	R11, R12	Resistor, Chip, 49.9Ω, 1/16 W, 1%, 0402, AEC-Q200	CRCW040249R9FKED	Vishay-Dale
1	R13	Resistor, Chip, 54.9kΩ, 1/16 W, 1%, 0402, AEC-Q200	CRCW040254K9FKED	Vishay-Dale
1	R14	Resistor, Chip, 3.24kΩ, 1/16 W, 1%, 0402, AEC-Q200	CRCW04023K24FKED	Vishay-Dale
1	R15	Resistor, Chip, 100kΩ, 1/16 W, 1%, 0402, AEC-Q200	CRCW0402100KFKEA	Vishay-Dale
1	R16	Resistor, Chip, 29.4kΩ, 1/16 W, 1%, 0402, AEC-Q200	CRCW040229K4FKED	Vishay-Dale
1	R18	Resistor, Chip, 31.6kΩ, 1/16 W, 1%, 0402, AEC-Q200	CRCW040231K6FKED	Vishay-Dale
1	R19	Resistor, Chip, 0Ω, 1/16 W, 5%, 0402, AEC-Q200	CRCW04020000Z0ED	Vishay-Dale
6	TP1, TP2, TP3, TP4, TP5, TP6	Test Point, Miniature, SMT	5019	Keystone
3	SH-J1, SH-J2, SHJ3	Single Operation 2.54mm Pitch Open Top Jumper Socket	M7582-05	Harwin
4	H3, H4, H5, H6	Standoff, Hex, 0.5"L #4-40 Nylon	1902C	Keystone
4	H7, H8, H9, H10	#4-40 Pan Head Machine Screw Phillips Drive Nylon	NY PMS 440 0038 PH	Building Fasteners
1	U1	IC, LM706A0-Q1, 65V, 10A Synchronous DC/DC Buck Converter with Ultra-Low IQ, VQFN-29	LM706A0QRRXRQ1	TI
1	PCB1	PCB, FR4, 6 layer, 2 oz	PCB	-

## 5 Compliance Information

### 5.1 Compliance and Certifications

[LM706A0QEVM EU Declaration of Conformity \(DoC\) for Restricting the use of Hazardous Substances \(RoHS\)](#)

## 6 Related Documentation

For related documentation, see the following:

- Texas Instruments, [LM706A0-Q1 65V, 10A, Automotive, High-Efficiency Buck Converter Optimized for High Power Density](#) data sheet
- Texas Instruments, [Reduce Buck Converter EMI and Voltage Stress by Minimizing Inductive Parasitics](#) analog applications journal
- Texas Instruments, [AN-2162 Simple Success with Conducted EMI from DC-DC Converters](#) application report
- White papers:
  - Texas Instruments, [Valuing Wide  \$V\_{IN}\$ , Low EMI Synchronous Buck Circuits for Cost-driven, Demanding Applications](#)
  - Texas Instruments, [An Overview of Conducted EMI Specifications for Power Supplies](#)
  - Texas Instruments, [An Overview of Radiated EMI Specifications for Power Supplies](#)

### 6.1 Supplemental Content

#### 6.1.1 Development Support

For development support, see the following:

- For TI's reference design library, visit [TI reference designs](#).
- For TI's WEBENCH Design Environments, visit the [WEBENCH® Design Center](#).
- LM706A0-Q1 DC/DC Converter [Quickstart Calculator](#).

#### 6.1.2 PCB Layout Resources

- Texas Instruments, [AN-1149 Layout Guidelines for Switching Power Supplies](#) application report
- Texas Instruments, [AN-1229 Simple Switcher PCB Layout Guidelines](#) application report
- Texas Instruments, [Constructing Your Power Supply – Layout Considerations](#) Power Supply Design seminar
- Texas Instruments, [Low Radiated EMI Layout Made SIMPLE with LM4360x and LM4600x](#) application report
- Power house blogs:
  - [High-Density PCB Layout of DC-DC Converters](#)

#### 6.1.3 Thermal Design Resources

- Texas Instruments, [AN-2020 Thermal Design by Insight, Not Hindsight](#) application report
- Texas Instruments, [AN-1520 A Guide to Board Layout for Best Thermal Resistance for Exposed Pad Packages](#) application report
- Texas Instruments, [Semiconductor and IC Package Thermal Metrics](#) application report
- Texas Instruments, [Thermal Design Made Simple with LM43603 and LM43602](#) application report
- Texas Instruments, [PowerPAD™ Thermally Enhanced Package](#) application report
- Texas Instruments, [PowerPAD™ Made Easy](#) application brief
- Texas Instruments, [Using New Thermal Metrics](#) application report

## 7 Additional Information

### 7.1 Trademarks

PowerPAD™ is a trademark of Texas Instruments.

All trademarks are the property of their respective owners.

## STANDARD TERMS FOR EVALUATION MODULES

1. *Delivery:* TI delivers TI evaluation boards, kits, or modules, including any accompanying demonstration software, components, and/or documentation which may be provided together or separately (collectively, an "EVM" or "EVMs") to the User ("User") in accordance with the terms set forth herein. User's acceptance of the EVM is expressly subject to the following terms.
  - 1.1 EVMs are intended solely for product or software developers for use in a research and development setting to facilitate feasibility evaluation, experimentation, or scientific analysis of TI semiconductors products. EVMs have no direct function and are not finished products. EVMs shall not be directly or indirectly assembled as a part or subassembly in any finished product. For clarification, any software or software tools provided with the EVM ("Software") shall not be subject to the terms and conditions set forth herein but rather shall be subject to the applicable terms that accompany such Software
  - 1.2 EVMs are not intended for consumer or household use. EVMs may not be sold, sublicensed, leased, rented, loaned, assigned, or otherwise distributed for commercial purposes by Users, in whole or in part, or used in any finished product or production system.
2. *Limited Warranty and Related Remedies/Disclaimers:*
  - 2.1 These terms do not apply to Software. The warranty, if any, for Software is covered in the applicable Software License Agreement.
  - 2.2 TI warrants that the TI EVM will conform to TI's published specifications for ninety (90) days after the date TI delivers such EVM to User. Notwithstanding the foregoing, TI shall not be liable for a nonconforming EVM if (a) the nonconformity was caused by neglect, misuse or mistreatment by an entity other than TI, including improper installation or testing, or for any EVMs that have been altered or modified in any way by an entity other than TI, (b) the nonconformity resulted from User's design, specifications or instructions for such EVMs or improper system design, or (c) User has not paid on time. Testing and other quality control techniques are used to the extent TI deems necessary. TI does not test all parameters of each EVM. User's claims against TI under this Section 2 are void if User fails to notify TI of any apparent defects in the EVMs within ten (10) business days after delivery, or of any hidden defects with ten (10) business days after the defect has been detected.
  - 2.3 TI's sole liability shall be at its option to repair or replace EVMs that fail to conform to the warranty set forth above, or credit User's account for such EVM. TI's liability under this warranty shall be limited to EVMs that are returned during the warranty period to the address designated by TI and that are determined by TI not to conform to such warranty. If TI elects to repair or replace such EVM, TI shall have a reasonable time to repair such EVM or provide replacements. Repaired EVMs shall be warranted for the remainder of the original warranty period. Replaced EVMs shall be warranted for a new full ninety (90) day warranty period.

### **WARNING**

**Evaluation Kits are intended solely for use by technically qualified, professional electronics experts who are familiar with the dangers and application risks associated with handling electrical mechanical components, systems, and subsystems.**

**User shall operate the Evaluation Kit within TI's recommended guidelines and any applicable legal or environmental requirements as well as reasonable and customary safeguards. Failure to set up and/or operate the Evaluation Kit within TI's recommended guidelines may result in personal injury or death or property damage. Proper set up entails following TI's instructions for electrical ratings of interface circuits such as input, output and electrical loads.**

**NOTE:**

**EXPOSURE TO ELECTROSTATIC DISCHARGE (ESD) MAY CAUSE DEGRADATION OR FAILURE OF THE EVALUATION KIT; TI RECOMMENDS STORAGE OF THE EVALUATION KIT IN A PROTECTIVE ESD BAG.**

### 3 Regulatory Notices:

#### 3.1 United States

##### 3.1.1 Notice applicable to EVMs not FCC-Approved:

**FCC NOTICE:** This kit is designed to allow product developers to evaluate electronic components, circuitry, or software associated with the kit to determine whether to incorporate such items in a finished product and software developers to write software applications for use with the end product. This kit is not a finished product and when assembled may not be resold or otherwise marketed unless all required FCC equipment authorizations are first obtained. Operation is subject to the condition that this product not cause harmful interference to licensed radio stations and that this product accept harmful interference. Unless the assembled kit is designed to operate under part 15, part 18 or part 95 of this chapter, the operator of the kit must operate under the authority of an FCC license holder or must secure an experimental authorization under part 5 of this chapter.

##### 3.1.2 For EVMs annotated as FCC – FEDERAL COMMUNICATIONS COMMISSION Part 15 Compliant:

#### **CAUTION**

This device complies with part 15 of the FCC Rules. Operation is subject to the following two conditions: (1) This device may not cause harmful interference, and (2) this device must accept any interference received, including interference that may cause undesired operation.

Changes or modifications not expressly approved by the party responsible for compliance could void the user's authority to operate the equipment.

#### **FCC Interference Statement for Class A EVM devices**

*NOTE: This equipment has been tested and found to comply with the limits for a Class A digital device, pursuant to part 15 of the FCC Rules. These limits are designed to provide reasonable protection against harmful interference when the equipment is operated in a commercial environment. This equipment generates, uses, and can radiate radio frequency energy and, if not installed and used in accordance with the instruction manual, may cause harmful interference to radio communications. Operation of this equipment in a residential area is likely to cause harmful interference in which case the user will be required to correct the interference at his own expense.*

#### **FCC Interference Statement for Class B EVM devices**

*NOTE: This equipment has been tested and found to comply with the limits for a Class B digital device, pursuant to part 15 of the FCC Rules. These limits are designed to provide reasonable protection against harmful interference in a residential installation. This equipment generates, uses and can radiate radio frequency energy and, if not installed and used in accordance with the instructions, may cause harmful interference to radio communications. However, there is no guarantee that interference will not occur in a particular installation. If this equipment does cause harmful interference to radio or television reception, which can be determined by turning the equipment off and on, the user is encouraged to try to correct the interference by one or more of the following measures:*

- Reorient or relocate the receiving antenna.
- Increase the separation between the equipment and receiver.
- Connect the equipment into an outlet on a circuit different from that to which the receiver is connected.
- Consult the dealer or an experienced radio/TV technician for help.

#### 3.2 Canada

##### 3.2.1 For EVMs issued with an Industry Canada Certificate of Conformance to RSS-210 or RSS-247

#### **Concerning EVMs Including Radio Transmitters:**

This device complies with Industry Canada license-exempt RSSs. Operation is subject to the following two conditions:

(1) this device may not cause interference, and (2) this device must accept any interference, including interference that may cause undesired operation of the device.

#### **Concernant les EVMs avec appareils radio:**

Le présent appareil est conforme aux CNR d'Industrie Canada applicables aux appareils radio exempts de licence. L'exploitation est autorisée aux deux conditions suivantes: (1) l'appareil ne doit pas produire de brouillage, et (2) l'utilisateur de l'appareil doit accepter tout brouillage radioélectrique subi, même si le brouillage est susceptible d'en compromettre le fonctionnement.

#### **Concerning EVMs Including Detachable Antennas:**

Under Industry Canada regulations, this radio transmitter may only operate using an antenna of a type and maximum (or lesser) gain approved for the transmitter by Industry Canada. To reduce potential radio interference to other users, the antenna type and its gain should be so chosen that the equivalent isotropically radiated power (e.i.r.p.) is not more than that necessary for successful communication. This radio transmitter has been approved by Industry Canada to operate with the antenna types listed in the user guide with the maximum permissible gain and required antenna impedance for each antenna type indicated. Antenna types not included in this list, having a gain greater than the maximum gain indicated for that type, are strictly prohibited for use with this device.

### Concernant les EVMs avec antennes détachables

Conformément à la réglementation d'Industrie Canada, le présent émetteur radio peut fonctionner avec une antenne d'un type et d'un gain maximal (ou inférieur) approuvé pour l'émetteur par Industrie Canada. Dans le but de réduire les risques de brouillage radioélectrique à l'intention des autres utilisateurs, il faut choisir le type d'antenne et son gain de sorte que la puissance isotrope rayonnée équivalente (p.i.r.e.) ne dépasse pas l'intensité nécessaire à l'établissement d'une communication satisfaisante. Le présent émetteur radio a été approuvé par Industrie Canada pour fonctionner avec les types d'antenne énumérés dans le manuel d'usage et ayant un gain admissible maximal et l'impédance requise pour chaque type d'antenne. Les types d'antenne non inclus dans cette liste, ou dont le gain est supérieur au gain maximal indiqué, sont strictement interdits pour l'exploitation de l'émetteur.

#### 3.3 Japan

3.3.1 *Notice for EVMs delivered in Japan:* Please see [http://www.tij.co.jp/lstds/ti\\_ja/general/eStore/notice\\_01.page](http://www.tij.co.jp/lstds/ti_ja/general/eStore/notice_01.page) 日本国内に輸入される評価用キット、ボードについては、次のところをご覧ください。

<https://www.ti.com/ja-jp/legal/notice-for-evaluation-kits-delivered-in-japan.html>

3.3.2 *Notice for Users of EVMs Considered "Radio Frequency Products" in Japan:* EVMs entering Japan may not be certified by TI as conforming to Technical Regulations of Radio Law of Japan.

If User uses EVMs in Japan, not certified to Technical Regulations of Radio Law of Japan, User is required to follow the instructions set forth by Radio Law of Japan, which includes, but is not limited to, the instructions below with respect to EVMs (which for the avoidance of doubt are stated strictly for convenience and should be verified by User):

1. Use EVMs in a shielded room or any other test facility as defined in the notification #173 issued by Ministry of Internal Affairs and Communications on March 28, 2006, based on Sub-section 1.1 of Article 6 of the Ministry's Rule for Enforcement of Radio Law of Japan,
2. Use EVMs only after User obtains the license of Test Radio Station as provided in Radio Law of Japan with respect to EVMs, or
3. Use of EVMs only after User obtains the Technical Regulations Conformity Certification as provided in Radio Law of Japan with respect to EVMs. Also, do not transfer EVMs, unless User gives the same notice above to the transferee. Please note that if User does not follow the instructions above, User will be subject to penalties of Radio Law of Japan.

【無線電波を送信する製品の開発キットをお使いになる際の注意事項】 開発キットの中には技術基準適合証明を受けていないものがあります。技術適合証明を受けていないものご使用に際しては、電波法遵守のため、以下のいずれかの措置を取っていただく必要がありますのでご注意ください。

1. 電波法施行規則第6条第1項第1号に基づく平成18年3月28日総務省告示第173号で定められた電波暗室等の試験設備でご使用いただく。
2. 実験局の免許を取得後ご使用いただく。
3. 技術基準適合証明を取得後ご使用いただく。

なお、本製品は、上記の「ご使用にあたっての注意」を譲渡先、移転先に通知しない限り、譲渡、移転できないものとします。

上記を遵守頂けない場合は、電波法の罰則が適用される可能性があることをご留意ください。日本テキサス・インスツルメンツ株式会社  
東京都新宿区西新宿 6 丁目 2 4 番 1 号  
西新宿三井ビル

3.3.3 *Notice for EVMs for Power Line Communication:* Please see [http://www.tij.co.jp/lstds/ti\\_ja/general/eStore/notice\\_02.page](http://www.tij.co.jp/lstds/ti_ja/general/eStore/notice_02.page)

電力線搬送波通信についての開発キットをお使いになる際の注意事項については、次のところをご覧ください。 <https://www.ti.com/ja-jp/legal/notice-for-evaluation-kits-for-power-line-communication.html>

#### 3.4 European Union

3.4.1 *For EVMs subject to EU Directive 2014/30/EU (Electromagnetic Compatibility Directive):*

This is a class A product intended for use in environments other than domestic environments that are connected to a low-voltage power-supply network that supplies buildings used for domestic purposes. In a domestic environment this product may cause radio interference in which case the user may be required to take adequate measures.



- 
- 4 *EVM Use Restrictions and Warnings:*
    - 4.1 EVMS ARE NOT FOR USE IN FUNCTIONAL SAFETY AND/OR SAFETY CRITICAL EVALUATIONS, INCLUDING BUT NOT LIMITED TO EVALUATIONS OF LIFE SUPPORT APPLICATIONS.
    - 4.2 User must read and apply the user guide and other available documentation provided by TI regarding the EVM prior to handling or using the EVM, including without limitation any warning or restriction notices. The notices contain important safety information related to, for example, temperatures and voltages.
    - 4.3 *Safety-Related Warnings and Restrictions:*
      - 4.3.1 User shall operate the EVM within TI's recommended specifications and environmental considerations stated in the user guide, other available documentation provided by TI, and any other applicable requirements and employ reasonable and customary safeguards. Exceeding the specified performance ratings and specifications (including but not limited to input and output voltage, current, power, and environmental ranges) for the EVM may cause personal injury or death, or property damage. If there are questions concerning performance ratings and specifications, User should contact a TI field representative prior to connecting interface electronics including input power and intended loads. Any loads applied outside of the specified output range may also result in unintended and/or inaccurate operation and/or possible permanent damage to the EVM and/or interface electronics. Please consult the EVM user guide prior to connecting any load to the EVM output. If there is uncertainty as to the load specification, please contact a TI field representative. During normal operation, even with the inputs and outputs kept within the specified allowable ranges, some circuit components may have elevated case temperatures. These components include but are not limited to linear regulators, switching transistors, pass transistors, current sense resistors, and heat sinks, which can be identified using the information in the associated documentation. When working with the EVM, please be aware that the EVM may become very warm.
      - 4.3.2 EVMs are intended solely for use by technically qualified, professional electronics experts who are familiar with the dangers and application risks associated with handling electrical mechanical components, systems, and subsystems. User assumes all responsibility and liability for proper and safe handling and use of the EVM by User or its employees, affiliates, contractors or designees. User assumes all responsibility and liability to ensure that any interfaces (electronic and/or mechanical) between the EVM and any human body are designed with suitable isolation and means to safely limit accessible leakage currents to minimize the risk of electrical shock hazard. User assumes all responsibility and liability for any improper or unsafe handling or use of the EVM by User or its employees, affiliates, contractors or designees.
    - 4.4 User assumes all responsibility and liability to determine whether the EVM is subject to any applicable international, federal, state, or local laws and regulations related to User's handling and use of the EVM and, if applicable, User assumes all responsibility and liability for compliance in all respects with such laws and regulations. User assumes all responsibility and liability for proper disposal and recycling of the EVM consistent with all applicable international, federal, state, and local requirements.
  5. *Accuracy of Information:* To the extent TI provides information on the availability and function of EVMs, TI attempts to be as accurate as possible. However, TI does not warrant the accuracy of EVM descriptions, EVM availability or other information on its websites as accurate, complete, reliable, current, or error-free.
  6. *Disclaimers:*
    - 6.1 EXCEPT AS SET FORTH ABOVE, EVMS AND ANY MATERIALS PROVIDED WITH THE EVM (INCLUDING, BUT NOT LIMITED TO, REFERENCE DESIGNS AND THE DESIGN OF THE EVM ITSELF) ARE PROVIDED "AS IS" AND "WITH ALL FAULTS." TI DISCLAIMS ALL OTHER WARRANTIES, EXPRESS OR IMPLIED, REGARDING SUCH ITEMS, INCLUDING BUT NOT LIMITED TO ANY EPIDEMIC FAILURE WARRANTY OR IMPLIED WARRANTIES OF MERCHANTABILITY OR FITNESS FOR A PARTICULAR PURPOSE OR NON-INFRINGEMENT OF ANY THIRD PARTY PATENTS, COPYRIGHTS, TRADE SECRETS OR OTHER INTELLECTUAL PROPERTY RIGHTS.
    - 6.2 EXCEPT FOR THE LIMITED RIGHT TO USE THE EVM SET FORTH HEREIN, NOTHING IN THESE TERMS SHALL BE CONSTRUED AS GRANTING OR CONFERRING ANY RIGHTS BY LICENSE, PATENT, OR ANY OTHER INDUSTRIAL OR INTELLECTUAL PROPERTY RIGHT OF TI, ITS SUPPLIERS/LICENSORS OR ANY OTHER THIRD PARTY, TO USE THE EVM IN ANY FINISHED END-USER OR READY-TO-USE FINAL PRODUCT, OR FOR ANY INVENTION, DISCOVERY OR IMPROVEMENT, REGARDLESS OF WHEN MADE, CONCEIVED OR ACQUIRED.
  7. *USER'S INDEMNITY OBLIGATIONS AND REPRESENTATIONS.* USER WILL DEFEND, INDEMNIFY AND HOLD TI, ITS LICENSORS AND THEIR REPRESENTATIVES HARMLESS FROM AND AGAINST ANY AND ALL CLAIMS, DAMAGES, LOSSES, EXPENSES, COSTS AND LIABILITIES (COLLECTIVELY, "CLAIMS") ARISING OUT OF OR IN CONNECTION WITH ANY HANDLING OR USE OF THE EVM THAT IS NOT IN ACCORDANCE WITH THESE TERMS. THIS OBLIGATION SHALL APPLY WHETHER CLAIMS ARISE UNDER STATUTE, REGULATION, OR THE LAW OF TORT, CONTRACT OR ANY OTHER LEGAL THEORY, AND EVEN IF THE EVM FAILS TO PERFORM AS DESCRIBED OR EXPECTED.

8. *Limitations on Damages and Liability:*

8.1 *General Limitations.* IN NO EVENT SHALL TI BE LIABLE FOR ANY SPECIAL, COLLATERAL, INDIRECT, PUNITIVE, INCIDENTAL, CONSEQUENTIAL, OR EXEMPLARY DAMAGES IN CONNECTION WITH OR ARISING OUT OF THESE TERMS OR THE USE OF THE EVMS , REGARDLESS OF WHETHER TI HAS BEEN ADVISED OF THE POSSIBILITY OF SUCH DAMAGES. EXCLUDED DAMAGES INCLUDE, BUT ARE NOT LIMITED TO, COST OF REMOVAL OR REINSTALLATION, ANCILLARY COSTS TO THE PROCUREMENT OF SUBSTITUTE GOODS OR SERVICES, RETESTING, OUTSIDE COMPUTER TIME, LABOR COSTS, LOSS OF GOODWILL, LOSS OF PROFITS, LOSS OF SAVINGS, LOSS OF USE, LOSS OF DATA, OR BUSINESS INTERRUPTION. NO CLAIM, SUIT OR ACTION SHALL BE BROUGHT AGAINST TI MORE THAN TWELVE (12) MONTHS AFTER THE EVENT THAT GAVE RISE TO THE CAUSE OF ACTION HAS OCCURRED.

8.2 *Specific Limitations.* IN NO EVENT SHALL TI'S AGGREGATE LIABILITY FROM ANY USE OF AN EVM PROVIDED HEREUNDER, INCLUDING FROM ANY WARRANTY, INDEMNITY OR OTHER OBLIGATION ARISING OUT OF OR IN CONNECTION WITH THESE TERMS, , EXCEED THE TOTAL AMOUNT PAID TO TI BY USER FOR THE PARTICULAR EVM(S) AT ISSUE DURING THE PRIOR TWELVE (12) MONTHS WITH RESPECT TO WHICH LOSSES OR DAMAGES ARE CLAIMED. THE EXISTENCE OF MORE THAN ONE CLAIM SHALL NOT ENLARGE OR EXTEND THIS LIMIT.

9. *Return Policy.* Except as otherwise provided, TI does not offer any refunds, returns, or exchanges. Furthermore, no return of EVM(s) will be accepted if the package has been opened and no return of the EVM(s) will be accepted if they are damaged or otherwise not in a resalable condition. If User feels it has been incorrectly charged for the EVM(s) it ordered or that delivery violates the applicable order, User should contact TI. All refunds will be made in full within thirty (30) working days from the return of the components(s), excluding any postage or packaging costs.

10. *Governing Law:* These terms and conditions shall be governed by and interpreted in accordance with the laws of the State of Texas, without reference to conflict-of-laws principles. User agrees that non-exclusive jurisdiction for any dispute arising out of or relating to these terms and conditions lies within courts located in the State of Texas and consents to venue in Dallas County, Texas. Notwithstanding the foregoing, any judgment may be enforced in any United States or foreign court, and TI may seek injunctive relief in any United States or foreign court.

Mailing Address: Texas Instruments, Post Office Box 655303, Dallas, Texas 75265  
Copyright © 2023, Texas Instruments Incorporated

## IMPORTANT NOTICE AND DISCLAIMER

TI PROVIDES TECHNICAL AND RELIABILITY DATA (INCLUDING DATA SHEETS), DESIGN RESOURCES (INCLUDING REFERENCE DESIGNS), APPLICATION OR OTHER DESIGN ADVICE, WEB TOOLS, SAFETY INFORMATION, AND OTHER RESOURCES "AS IS" AND WITH ALL FAULTS, AND DISCLAIMS ALL WARRANTIES, EXPRESS AND IMPLIED, INCLUDING WITHOUT LIMITATION ANY IMPLIED WARRANTIES OF MERCHANTABILITY, FITNESS FOR A PARTICULAR PURPOSE OR NON-INFRINGEMENT OF THIRD PARTY INTELLECTUAL PROPERTY RIGHTS.

These resources are intended for skilled developers designing with TI products. You are solely responsible for (1) selecting the appropriate TI products for your application, (2) designing, validating and testing your application, and (3) ensuring your application meets applicable standards, and any other safety, security, regulatory or other requirements.

These resources are subject to change without notice. TI grants you permission to use these resources only for development of an application that uses the TI products described in the resource. Other reproduction and display of these resources is prohibited. No license is granted to any other TI intellectual property right or to any third party intellectual property right. TI disclaims responsibility for, and you will fully indemnify TI and its representatives against, any claims, damages, costs, losses, and liabilities arising out of your use of these resources.

TI's products are provided subject to [TI's Terms of Sale](#) or other applicable terms available either on [ti.com](https://www.ti.com) or provided in conjunction with such TI products. TI's provision of these resources does not expand or otherwise alter TI's applicable warranties or warranty disclaimers for TI products.

TI objects to and rejects any additional or different terms you may have proposed.

Mailing Address: Texas Instruments, Post Office Box 655303, Dallas, Texas 75265  
Copyright © 2024, Texas Instruments Incorporated