

LM251772 Buck-Boost Controller Evaluation Module for USB-PD



Description

The [LM251772EVM-PD](#) demonstrates a flexible high power buck-boost design using the [LM251772](#). The evaluation module is configured to operate from an input voltage range of 9V to 36V and to produce a regulated 5V to 48V output with up to a 5A load current. The EVM operates with a switching frequency of 320kHz. Most of the device settings are easily adjusted or set through jumpers, like: operation mode (PSM or fPWM), bias supply, and external clock synchronization.

Get Started

1. Connect the EVM to the power supply and the load
2. Use the [USB2ANY](#) adapter to configure the GUI and I2C operation
3. Install the LM251772 configuration GUI

Features

- Wide input voltage range
- Ultra high (> 95%) peak power conversion efficiency

- Adjustable output voltage using feedback resistor divider or I2C interface
- Optional synchronization (SYNC)
- Easy configuration of current monitor or limiter
- Support for cable drop compensation
- Output disconnect support
- Programmable input undervoltage lockout (UVLO) threshold and hysteresis
- Output constant voltage (CV) and constant current (CC) options
- I2C interface with USB2ANY and GUI
- Setting of configuration resistor R_{CFG2} through DIP switches

Applications

- USB Type-C® power delivery
 - [Docking station](#)
 - [PC monitor](#)
 - [Desktop PC](#)
- Wireless charging
- [Industrial PC](#) and [rugged PC](#)
- [DC/DC Modules](#)

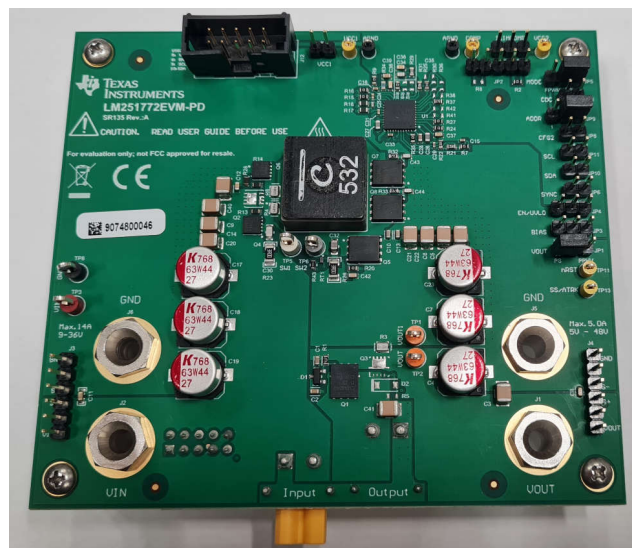

1 Evaluation Module Overview

1.1 Introduction

The [LM251772EVM-PD](#) evaluation module (EVM) is designed to conveniently evaluate the performance of the [LM251772](#) wide-V_{IN} buck-boost controller. The LM251772 is a wide-V_{IN} four switch buck-boost controller. The device provides a regulated output voltage if the input voltage is higher, equal to or lower as the adjusted output voltage. In power safe mode, the device supports superb efficiency over the full range of the output.

Through the optional usage of the I2C interface, the device covers additional parameters for configuration and adjustments of the switch mode power supply operation.

To check the performance, the I2C interface also allows for easy access to measure the typical signals of a buck-boost controller.

1.2 Kit Contents

- One LM25177EVM-PD PCB
- EVM Disclaimer Read Me

What is Not Included

The EVM does not include the USB2ANY interface.

Order the USB2ANY interface at [USB2ANY interface adapter](#).

1.3 Specification

Table 1-1. Board Specifications

Parameter	Value
Input voltage	9.0V to 36V
Output voltage	5V to 28V 5V to 48V (V _{in} > 16V)
Maximum output current	5A
Default switching frequency	320kHz
Board size (four layers)	4.1 inch × 3.6 inch

1.4 Device Information

The LM251772 is a four switch buck-boost controller. The device provides a regulated output voltage if the input voltage is higher, equal to or lower as the adjusted output voltage. In power safe mode, the device supports a superb efficiency over the full range of the output.

- Wide input range from 3.5V to 36V
- Output voltage 3.3V to 48V
- Peak current regulation scheme
- Dynamic output voltage tracking
 - Digital PWM tracking input
 - Analog tracking input
 - Via I2C interface programming
- Minimum quiescent current
 - Low shut down I_q of 3μA
 - Low operating I_q of 25μA
- Operation mode selection for high light load efficiency
 - Power save burst mode
 - μSleep power save mode
- Integrated high voltage supply LDO

2 Hardware Connector, Test Point, and Selection Switch Descriptions

This section provides the I/O connectors, jumpers, and test points of the EVM.

The power supply must be connected to input connectors J2 and J6.

The load must be connected to output connectors J1 and J5.

2.1 Connector Descriptions

Table 2-1. Connectors

Reference Designator	Description
J1	Output voltage positive connection
J2	Input voltage positive connection
J3	Input voltage positive and input voltage return test point
J4	Output voltage positive and output voltage return test point
J5	Output voltage return connection
J6	Input voltage return connection
J7	USB-PD controller EVM control connector
J9	USB-PD controller EVM power in connector
J10	USB-PD controller EVM power out connector
J11	CDC output connection
J12	I2C / USB2ANY connector (Not used for the LM25177222)

Table 2-2. USB-PD controller EVM control connector: J7

Pin	Function	Pin	Function
1	CDC: Current monitor signal	2	PTC: Temp sensor
3	PDCTRL_GOOD: Temp sensor supply	4	nFLT signal
5	EN/UVLO signal	6	I2C: SDA
7	GND	8	I2C: SCL
9	VCC1 (Connected via Jumper JP12)	10	GND

2.2 Jumper Descriptions

Table 2-3. Jumpers

Reference Designator	Pins	Description	Default Connection
JP1	Pin 1 to Pin 2	Connect VOUT before sense resistor	*
	Pin 2 to Pin 3	Connect VOUT after sense resistor	
JP2	Pin 1 to Pin 3	Can be used for Bode plot signal injection, when external voltage divider circuit is used	
	Pin 4 to Pin 5 (FB)	Connect FB to VCC2 (if R2 is not assembled) to use internal voltage divider circuit	
JP3	Pin 1 to Pin 2 (VOUT1)	Connect BIAS to VOUT1 (output of power stage)	
	Pin 2 to Pin 3 (VIN)	Connect BIAS to VIN	

Table 2-3. Jumpers (continued)

Reference Designator	Pins	Description	Default Connection
JP4	Pin 1 to Pin 2 (GND)	Connect EN/UVLO to GND	
	Pin 2 to Pin 3 (VIN)	Connect EN/UVLO to VIN	
JP5	Pin 1 to Pin 2 (GND)	Set MODE low: PSM mode	
	Pin 2 to Pin 3 (VCC2)	Set MODE high: FPWM mode	*
JP6	Pin 1 to Pin 2 (SYNC)	Set SYNC to GND	
JP7	Pin 1 to Pin 2 (GND)	Connect ILIMCOMP to GND	
	Pin 2 to Pin 3 (VCC2)	Connect ILIMCOMP to VCC2 (disable current limiter)	
	Open	Enable Current Limiter function	
JP8	Pin 2 to Pin 3 (CFG2)	Set CFG2 to GND	
JP9	Pin 1 to Pin 2 (ADDR/AGND)	Set I2C ENABLED Address 0x6A	
	Pin 2 to Pin 3 (ADDR/VCC2)	Set I2C ENABLED Address 0x6B	*
JP10	Pin 2 to Pin 3 (CFG3/SDA)	Set CFG3/SDA to GND	
JP11	Pin 1 to Pin 2 (CFG4/SCL)	Set CFG4/SCL to GND	
JP12	Pin 1 to Pin 2 (VCC1)	Connect VCC1 to interface header J7	

2.3 Test Point Descriptions

Table 2-4. Test Points

Reference Designator	Description
TP1	ISNSP test point
TP2	ISNSN test point
TP3 (VIN)	Input voltage positive test point
TP4	AGND test point
TP5	SW1
TP6	SW2
TP7	AGND test point
TP8 (GND)	Input voltage return test point
TP9	VCC2 test point
TP10	VCC1 test point
TP11	nRST test point
TP12	COMP test point
TP13	SS/ATRK test point

3 Implementation Results

3.1 Test Setup

Figure 3-1 shows a typical test setup to evaluate the LM251772EVM-PD.

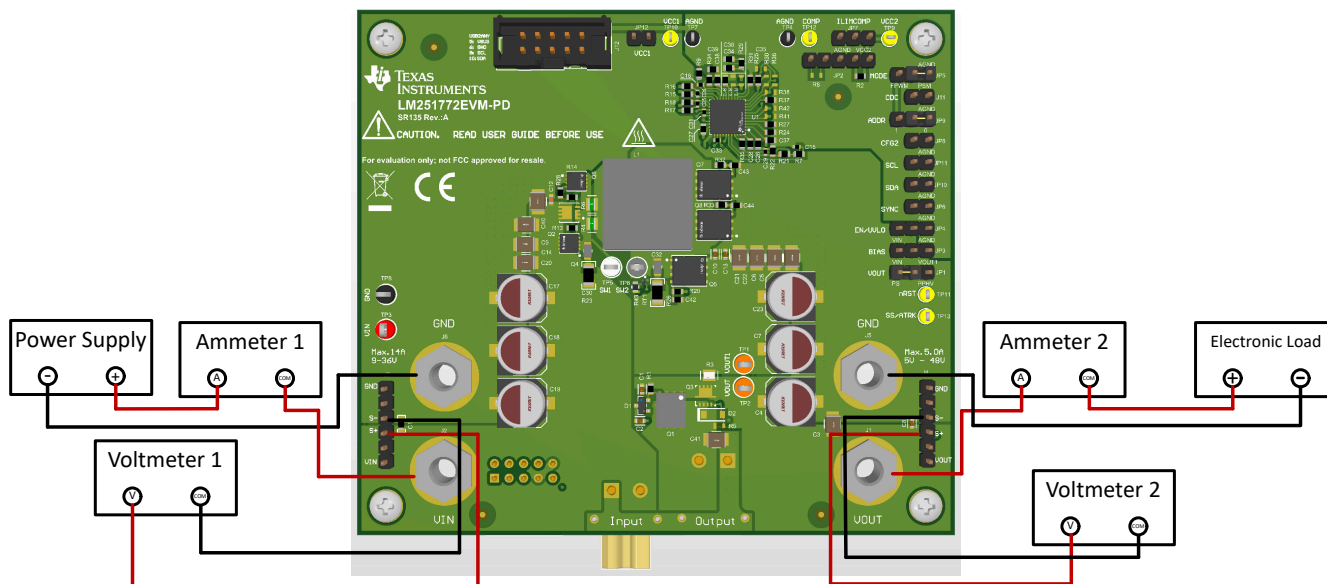

Figure 3-1. Typical EVM Connection Diagram

3.2 Test Procedure

1. Set the power supply current limit to 15 A.
2. Turn off the power supply.
3. Connect the positive output of the power supply to J2 and the negative output to J6.
4. Connect the load to J1 for the positive connection and J5 for the negative connection.
5. Set the power supply voltage to 8V and the electronic load to 0.1 A. Make sure the electronic load voltage is in regulation with a nominal 5V output.
6. Slowly increase the load while monitoring the output voltage between J4-VOUT and J4-GND. The output voltage must remain in regulation with a nominal 4V output as the load is increased up to 3A.
7. Slowly sweep the input voltage from 8V to 36V. The output voltage must remain in regulation with a nominal 5V output.
8. Set the output voltage to 48V via I2C and GUI
9. Increase the load to 5A.
10. Slowly sweep the input voltage from 36V to 20V. Make sure the output voltage remains in regulation with a nominal 48V output.
11. Decrease the input voltage down to 0V to shut down the buck-boost converter, and then turn off the load.

3.3 Precautions



CAUTION

Prolonged operation with low input at full power causes heating of the FETs (Q1 to Q8). Board surface is hot. Do not touch. Contact can cause burns.

3.4 Test Data and Performance Curves

3.4.1 Thermal Performance

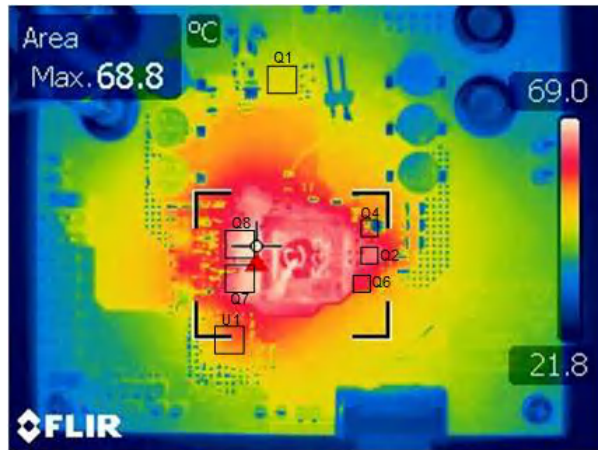

Figure 3-2. Thermal Image: $V_{IN} = 12.0V$, $V_{OUT} = 5.0V$, $I_{OUT} = 5.0A$, No Forced Air Cooling

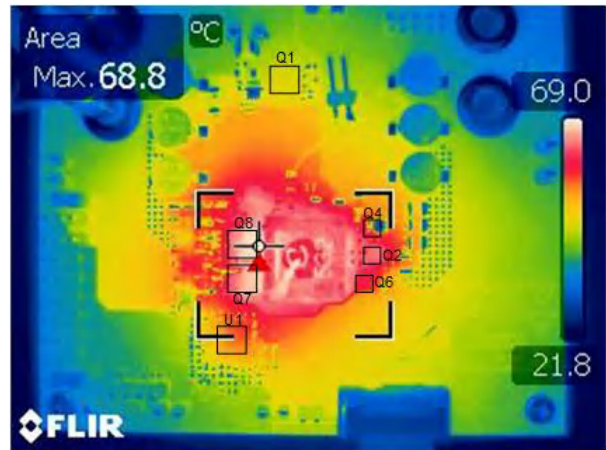

Figure 3-3. Thermal Image: $V_{IN} = 12.0V$, $V_{OUT} = 28.0V$, $I_{OUT} = 5.0A$, No Forced Air Cooling

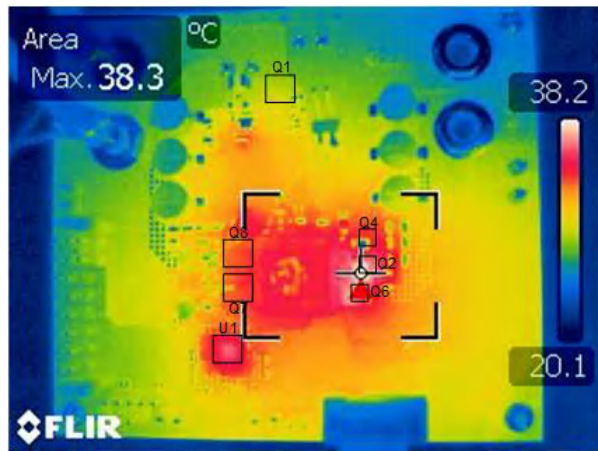

Figure 3-4. Thermal Image: $V_{IN} = 20.0V$, $V_{OUT} = 5.0V$, $I_{OUT} = 5.0A$, No Forced Air Cooling

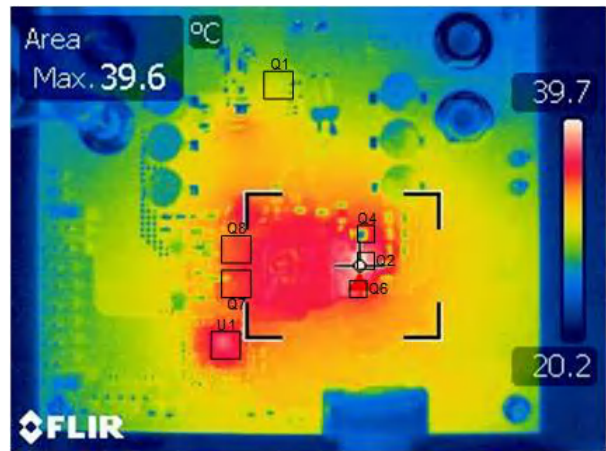

Figure 3-5. Thermal Image: $V_{IN} = 20.0V$, $V_{OUT} = 12.0V$, $I_{OUT} = 5.0A$, No Forced Air Cooling

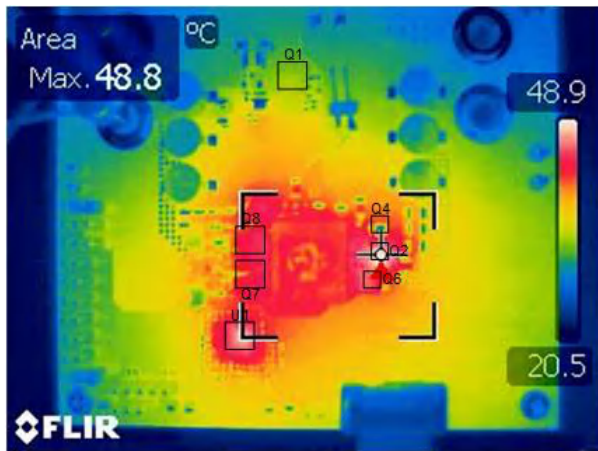

Figure 3-6. Thermal Image: $V_{IN} = 20.0V$, $V_{OUT} = 20.0V$, $I_{OUT} = 5.0A$, No Forced Air Cooling

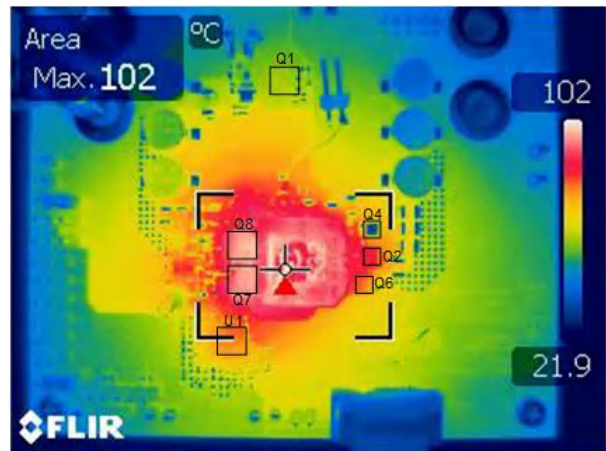

Figure 3-7. Thermal Image: $V_{IN} = 20.0V$, $V_{OUT} = 48.0V$, $I_{OUT} = 5.0A$, No Forced Air Cooling

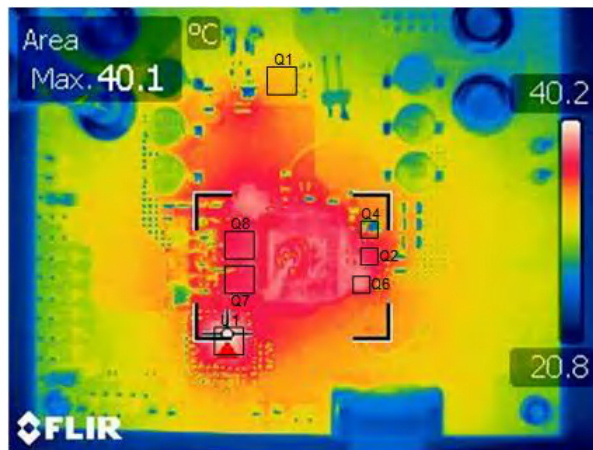

Figure 3-8. Thermal Image: $V_{IN} = 20.0V$, ILIM (Current Limiter) = 5.0A, Load = Short, No Forced Air Cooling

3.4.2 Efficiency

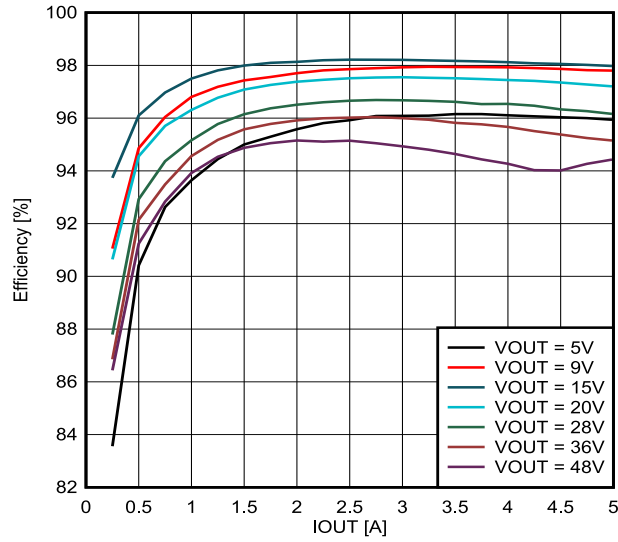

Figure 3-9. Efficiency Versus Output Current at $V_{in} = 20V$

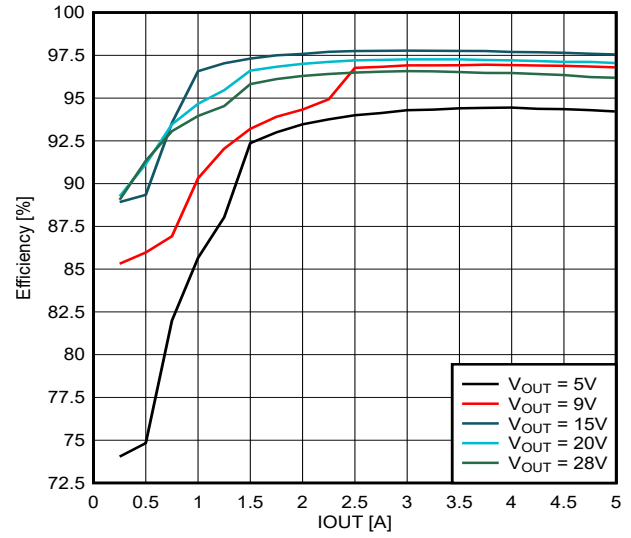

Figure 3-10. Efficiency Versus Output Current at $V_{in} = 12V$

3.4.3 Steady State Waveforms

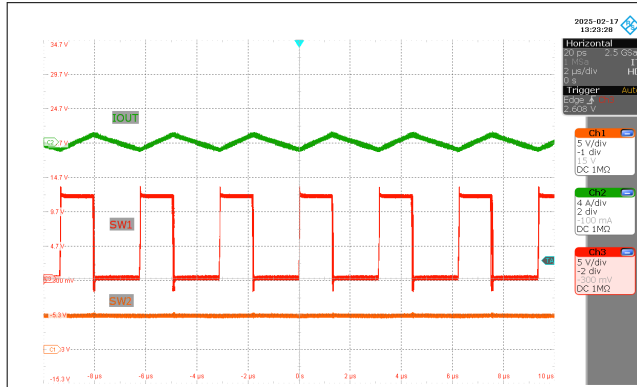

Figure 3-11. SW1, SW2, I_L ($V_{IN} = 12V$, $V_{OUT} = 5V$, $I_{OUT} = 0 A$)

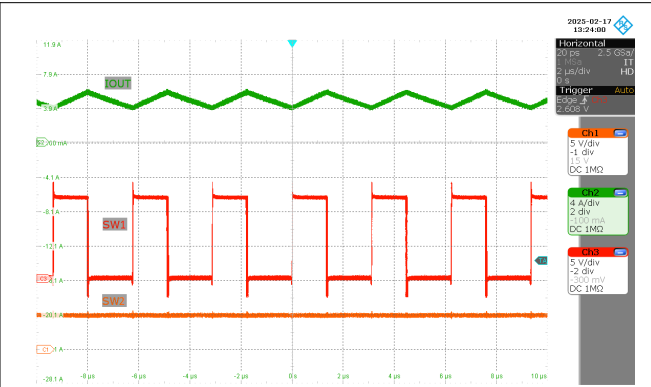

Figure 3-12. SW1, SW2, I_L ($V_{IN} = 12V$, $V_{OUT} = 5V$, $I_{OUT} = 5 A$)

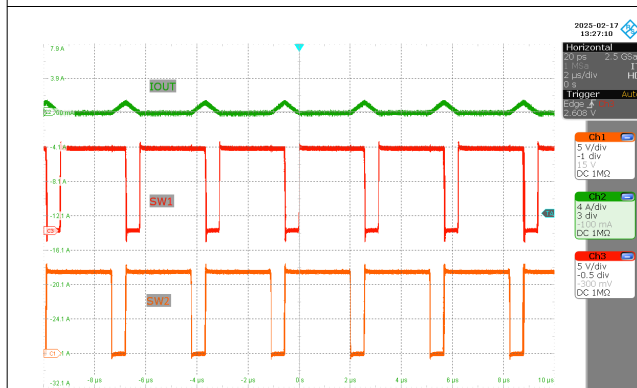

Figure 3-13. SW1, SW2, I_L ($V_{IN} = 12V$, $V_{OUT} = 12V$, $I_{OUT} = 0 A$)

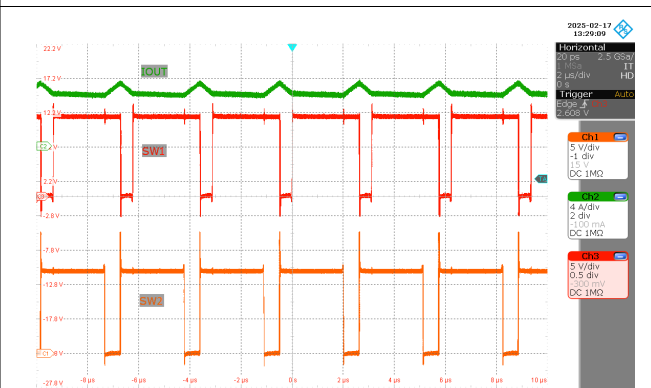

Figure 3-14. SW1, SW2, I_L ($V_{IN} = 12V$, $V_{OUT} = 12V$, $I_{OUT} = 5 A$)

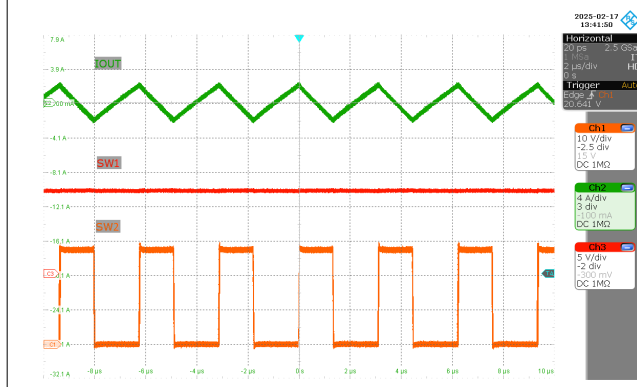

Figure 3-15. SW1, SW2, I_L ($V_{IN} = 12V$, $V_{OUT} = 28V$, $I_{OUT} = 0 A$)

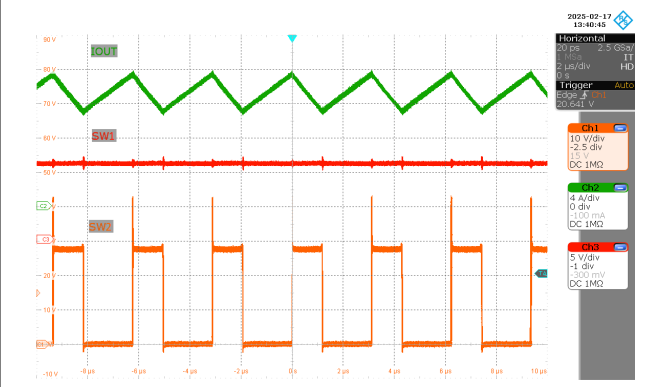

Figure 3-16. SW1, SW2, I_L ($V_{IN} = 12V$, $V_{OUT} = 28V$, $I_{OUT} = 5 A$)

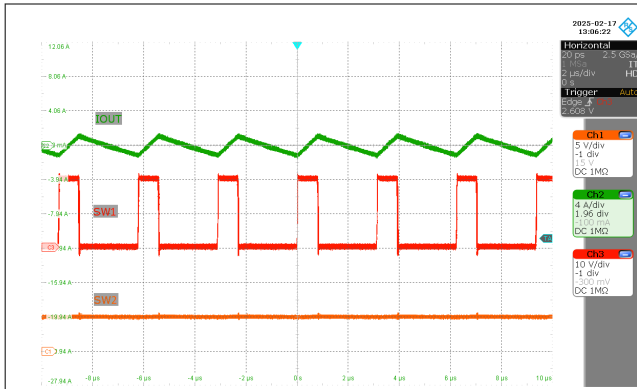

Figure 3-17. SW1, SW2, I_L ($V_{IN} = 20V$, $V_{OUT} = 5V$, $I_{OUT} = 0A$)

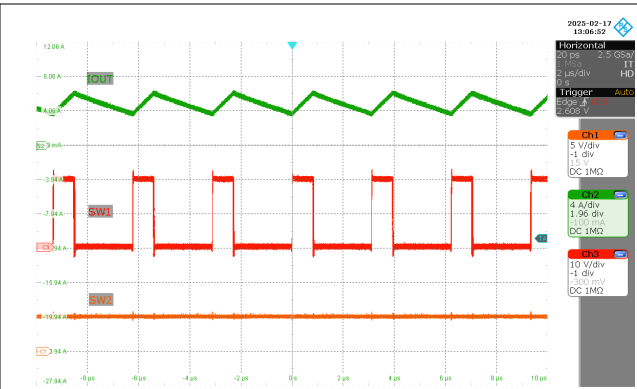

Figure 3-18. SW1, SW2, I_L ($V_{IN} = 20V$, $V_{OUT} = 5V$, $I_{OUT} = 5A$)

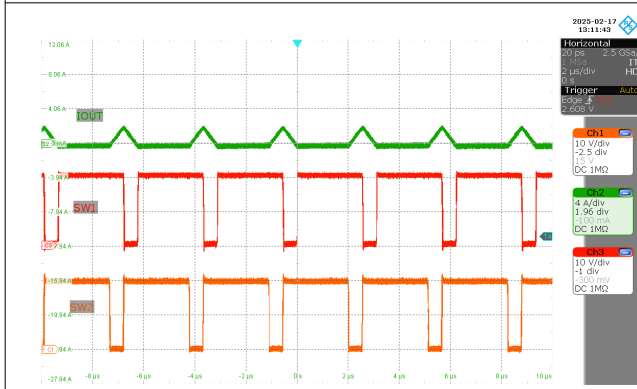

Figure 3-19. SW1, SW2, I_L ($V_{IN} = 20V$, $V_{OUT} = 20V$, $I_{OUT} = 0A$)

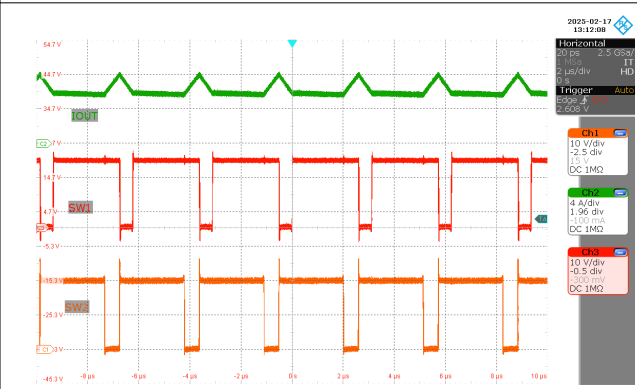

Figure 3-20. SW1, SW2, I_L ($V_{IN} = 20V$, $V_{OUT} = 20V$, $I_{OUT} = 5A$)

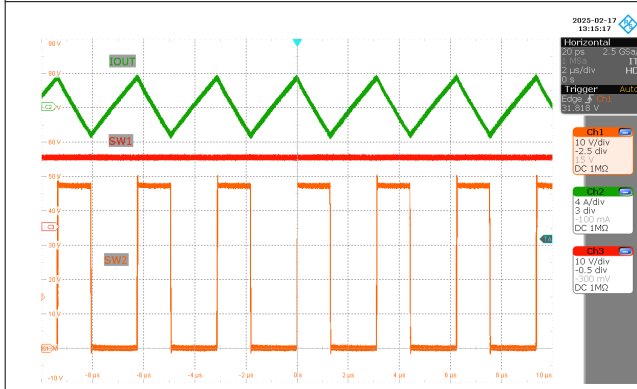

Figure 3-21. SW1, SW2, I_L ($V_{IN} = 20V$, $V_{OUT} = 48V$, $I_{OUT} = 0A$)

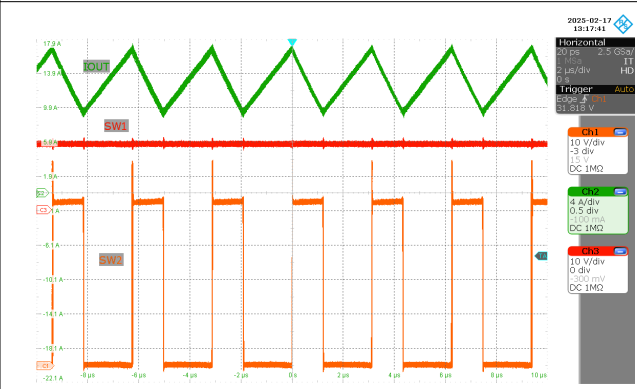

Figure 3-22. SW1, SW2, I_L ($V_{IN} = 20V$, $V_{OUT} = 48V$, $I_{OUT} = 5A$)

3.4.4 Step Load Response

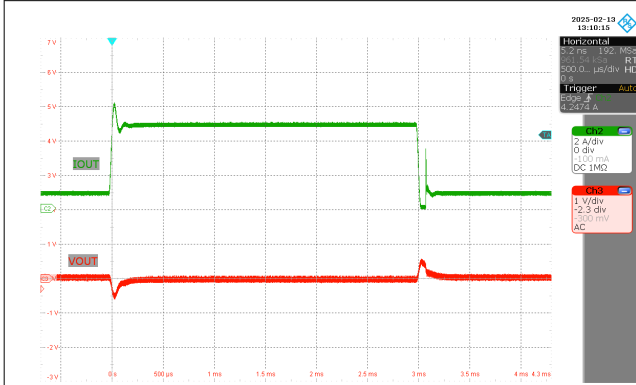

Figure 3-23. Load Step ($V_{IN} = 12\text{ V}$, $V_{OUT} = 5\text{ V}$, $I_{OUT} = 1\text{ A}$ – 5 A)

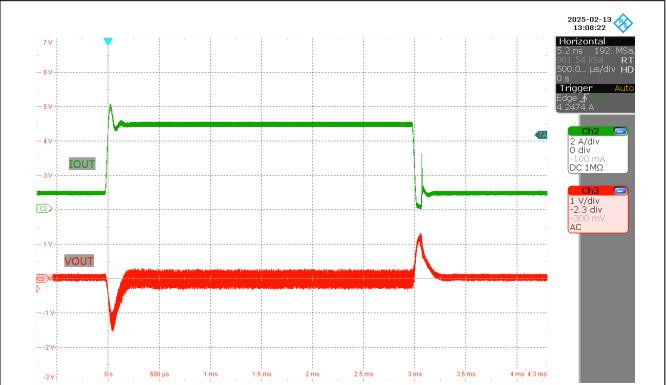

Figure 3-24. Load Step ($V_{IN} = 12\text{ V}$, $V_{OUT} = 28\text{ V}$, $I_{OUT} = 1\text{ A}$ – 5 A)

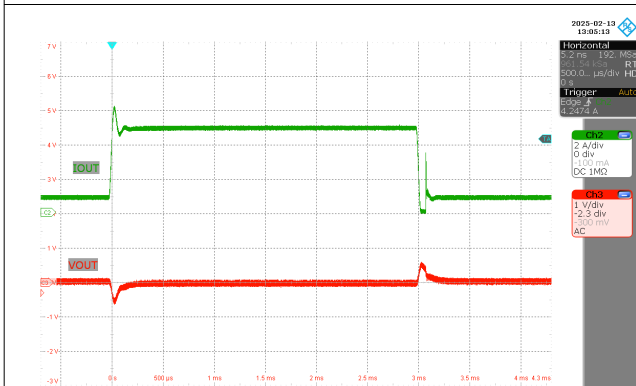

Figure 3-25. Load Step ($V_{IN} = 20\text{ V}$, $V_{OUT} = 5\text{ V}$, $I_{OUT} = 1\text{ A}$ – 5 A)

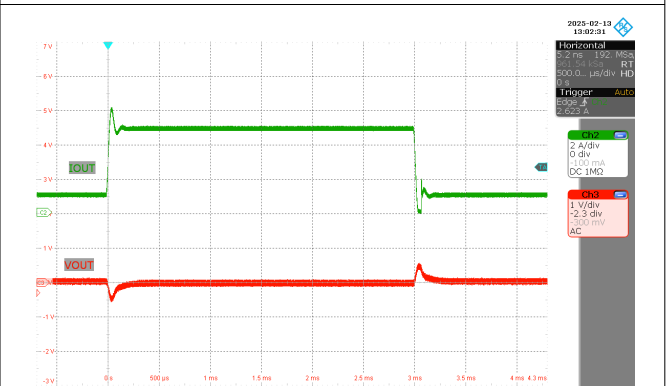

Figure 3-26. Load Step ($V_{IN} = 20\text{ V}$, $V_{OUT} = 12\text{ V}$, $I_{OUT} = 1\text{ A}$ – 5 A)

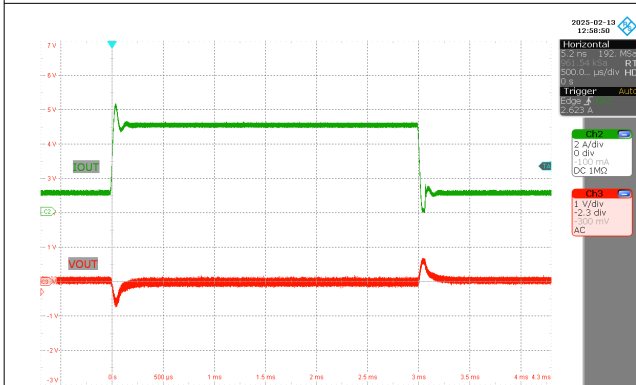

Figure 3-27. Load Step ($V_{IN} = 20\text{ V}$, $V_{OUT} = 20\text{ V}$, $I_{OUT} = 1\text{ A}$ – 5 A)

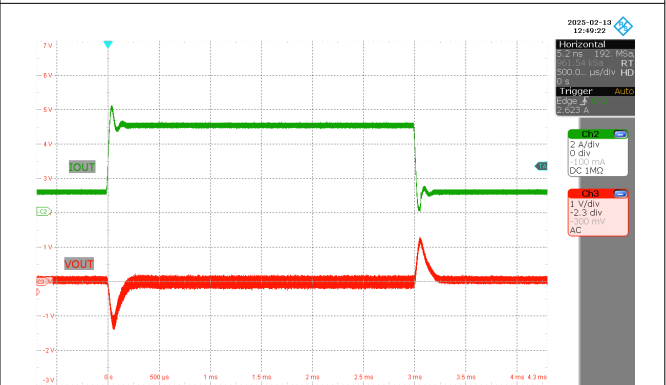

Figure 3-28. Load Step ($V_{IN} = 20\text{ V}$, $V_{OUT} = 48\text{ V}$, $I_{OUT} = 1\text{ A}$ – 5 A)

3.4.5 AC Loop Response Curves

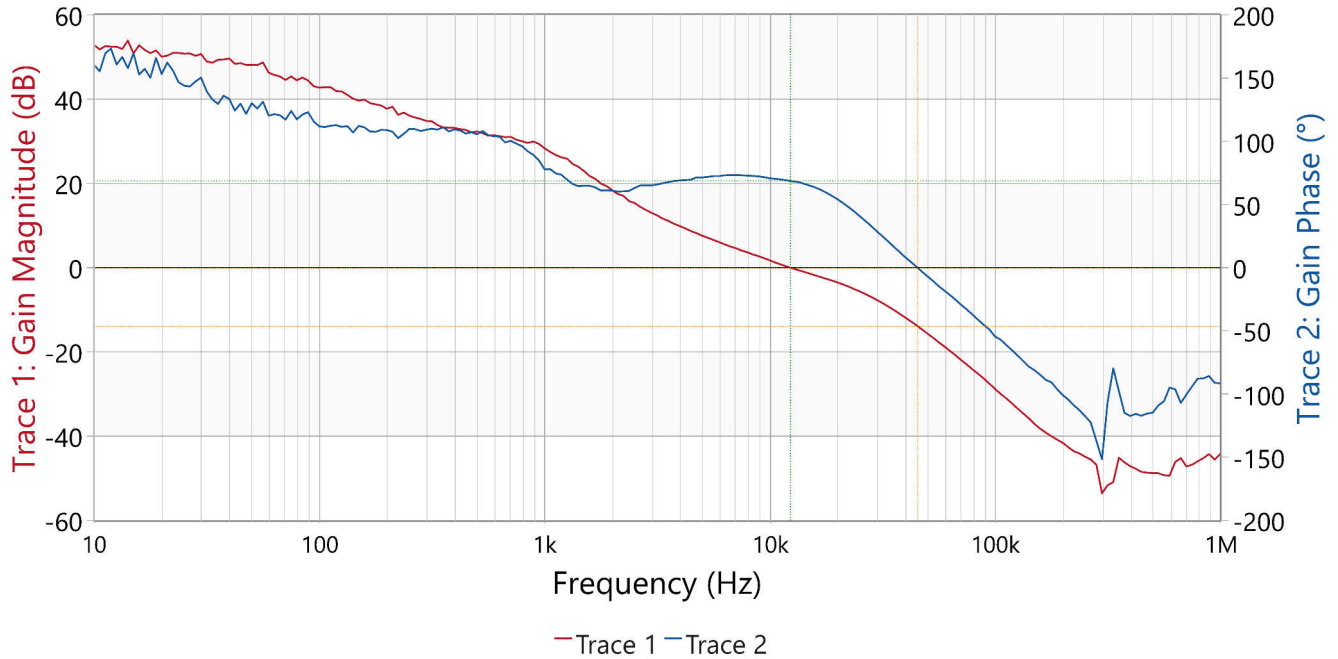

Figure 3-29. Control Loop Response, $V_{IN} = 12.0V$, $V_{OUT} = 5.0V$, $I_{OUT} = 5.0A$

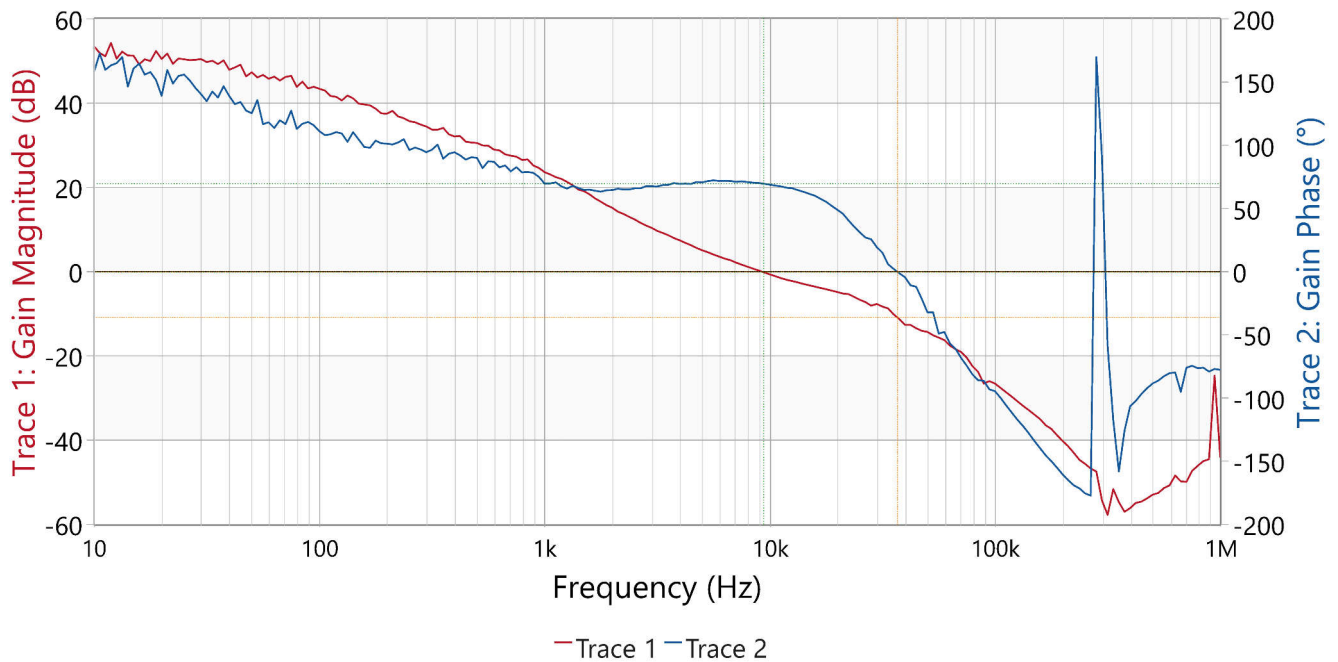

Figure 3-30. Control Loop Response, $V_{IN} = 12.0V$, $V_{OUT} = 12.0V$, $I_{OUT} = 5.0A$

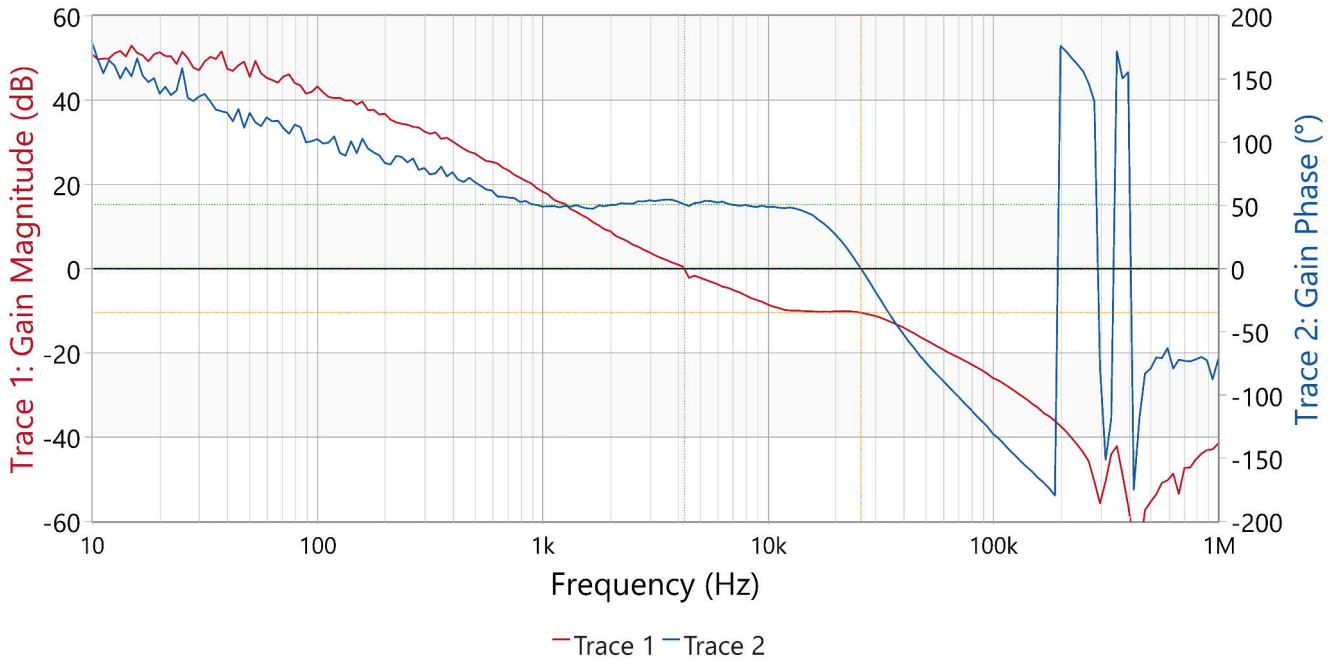

Figure 3-31. Control Loop Response, $V_{IN} = 12.0V$, $V_{OUT} = 28V$, $I_{OUT} = 5.0A$

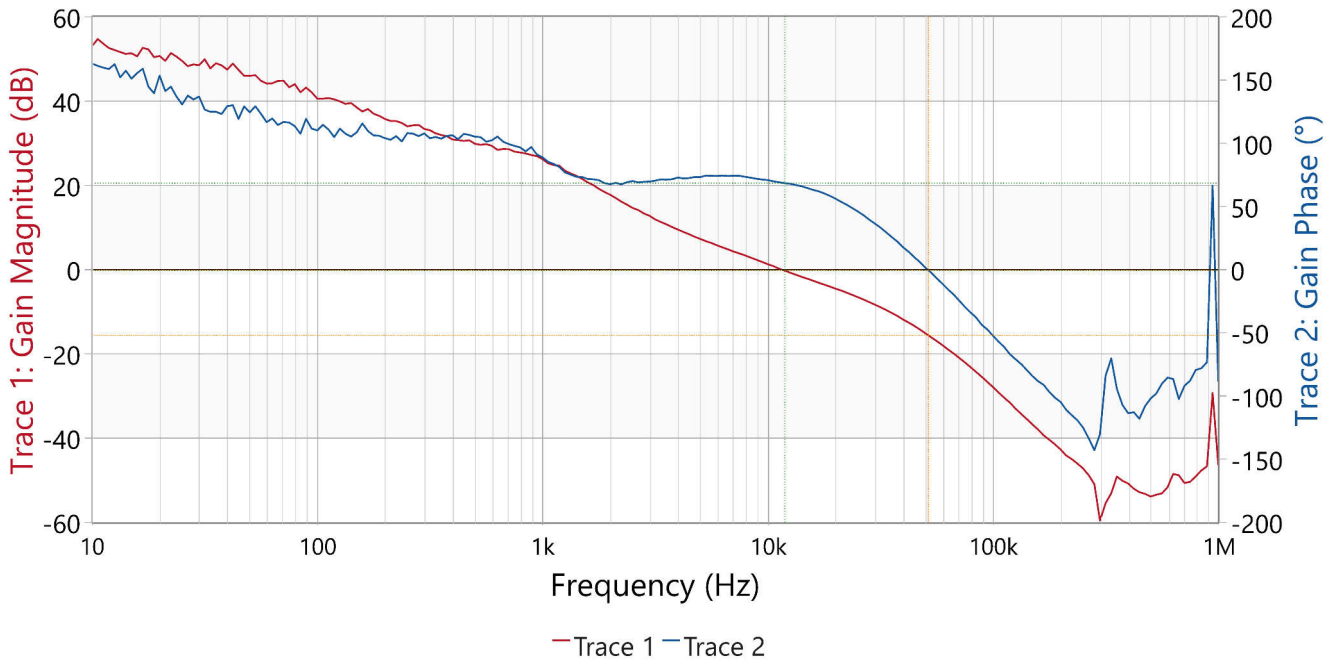

Figure 3-32. Control Loop Response, $V_{IN} = 20.0V$, $V_{OUT} = 5.0V$, $I_{OUT} = 5.0A$

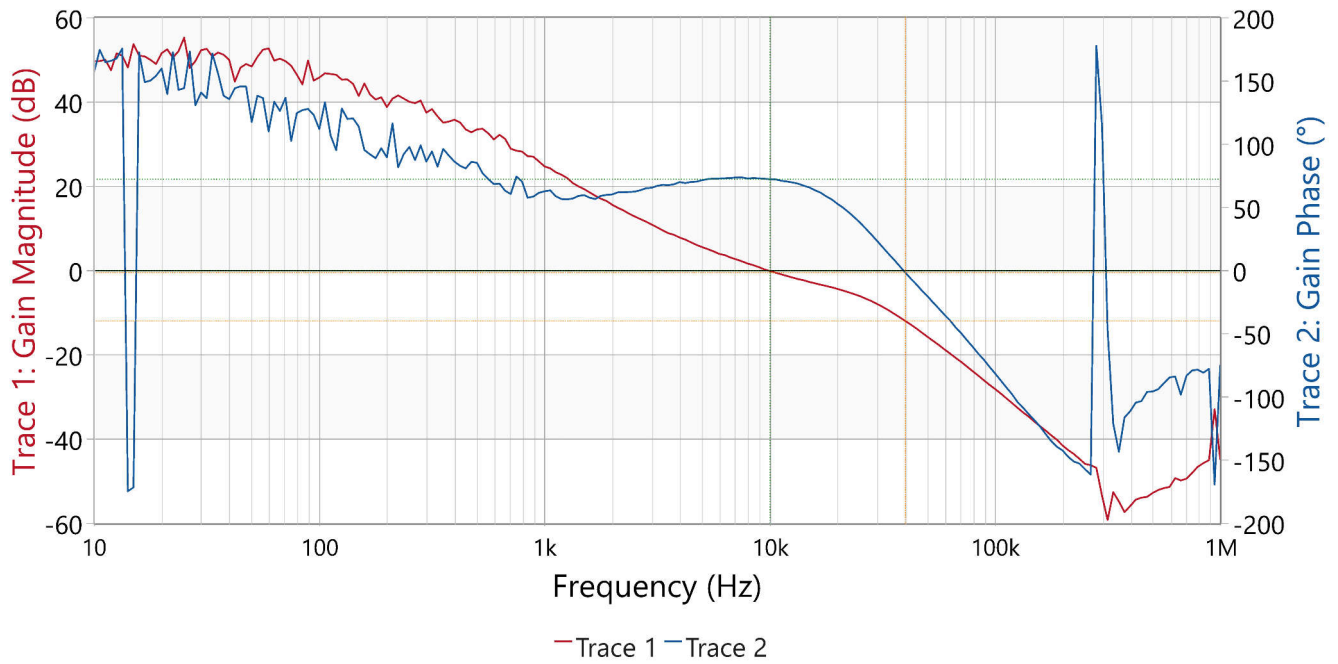

Figure 3-33. Control Loop Response, $V_{IN} = 20.0V$, $V_{OUT} = 20V$, $I_{OUT} = 5.0A$

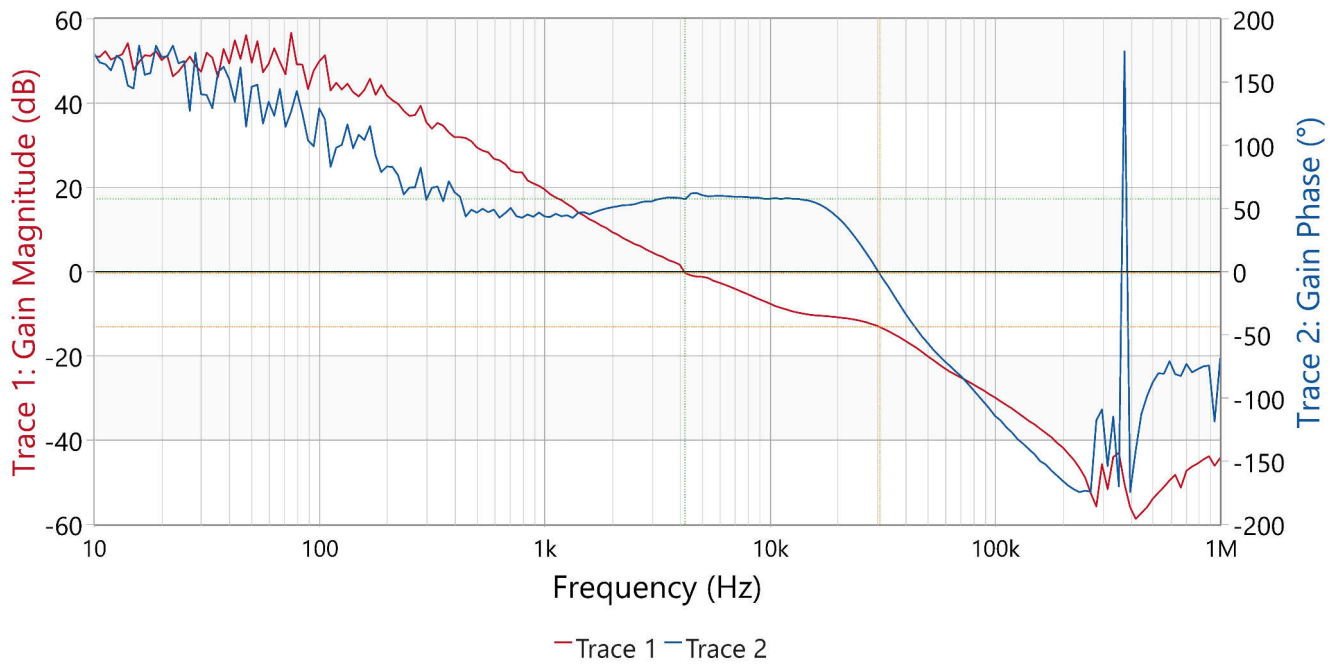

Figure 3-34. Control Loop Response, $V_{IN} = 20.0V$, $V_{OUT} = 48.0V$, $I_{OUT} = 5.0A$

4 Hardware Design Files

4.1 Schematic

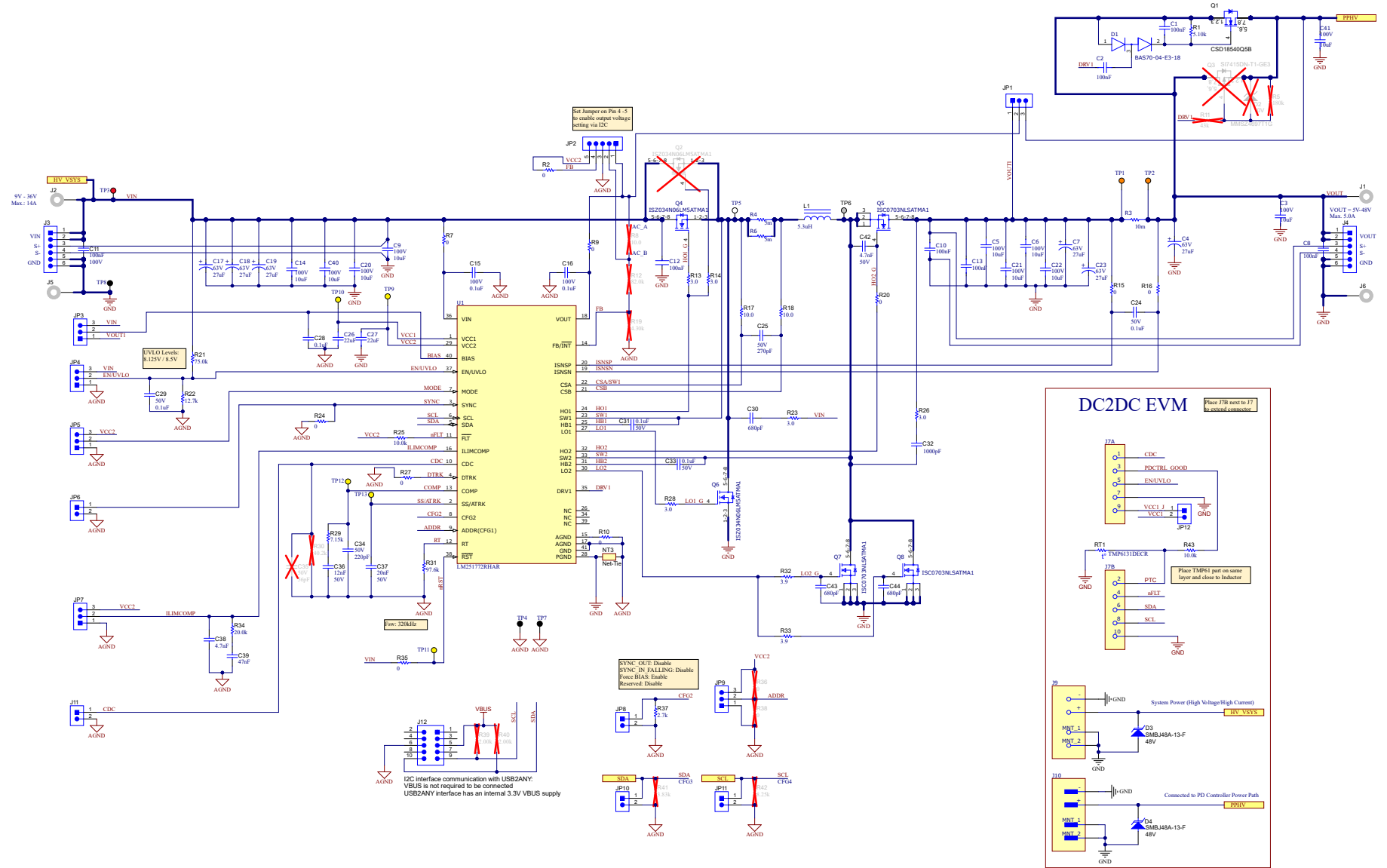

Figure 4-1. 4-Switch Buck-Boost Converter Schematic

4.2 Board Layout

Figure 4-2 through Figure 4-7 show the LM251772EVM-PD PCB design.

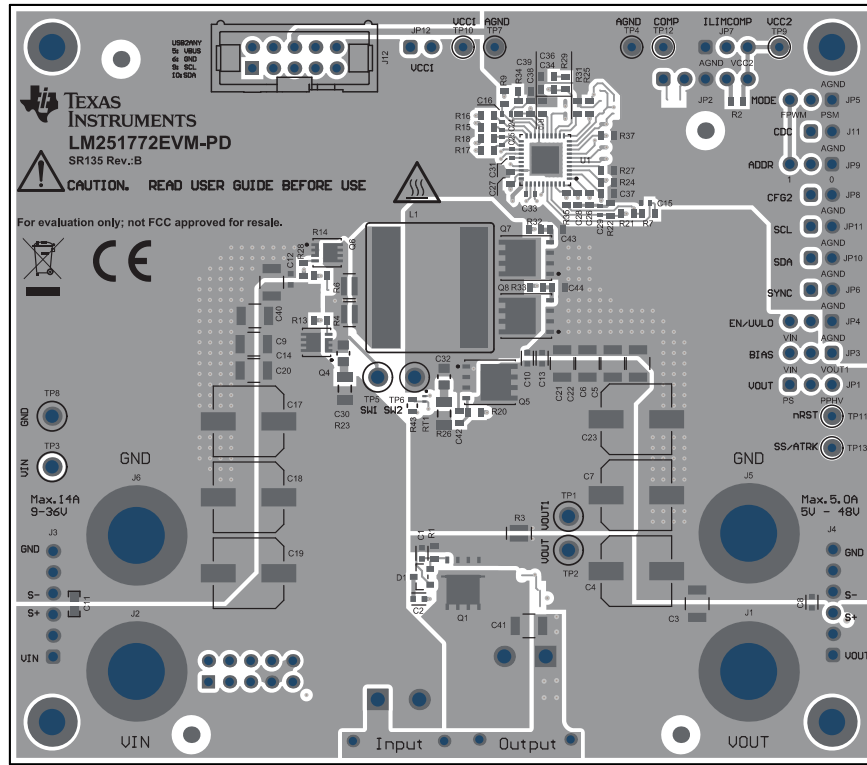

Figure 4-2. Top Silkscreen

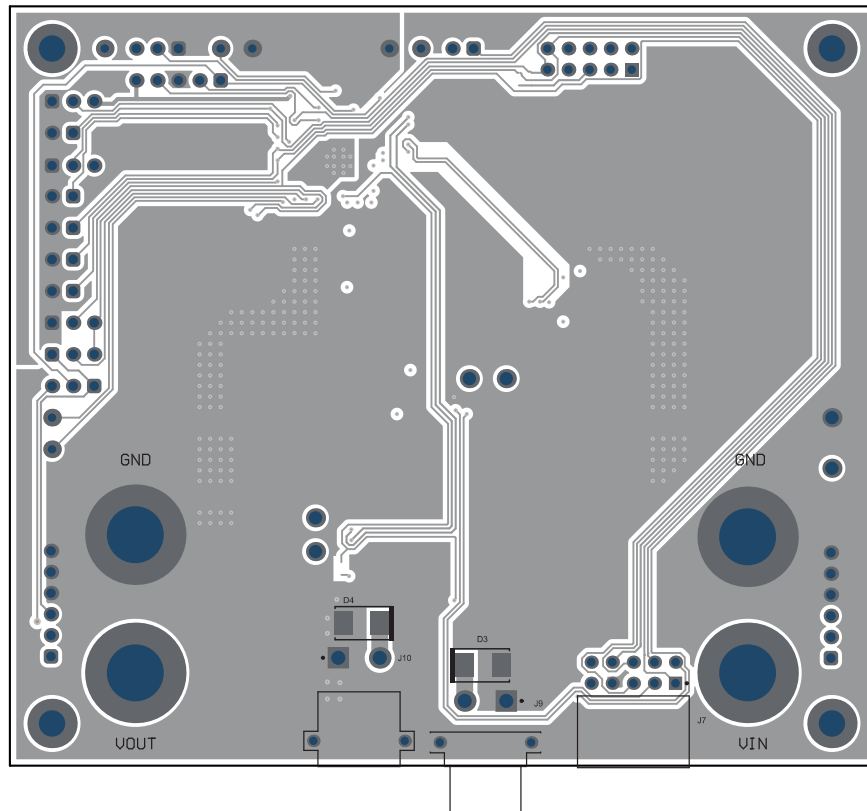

Figure 4-3. Bottom Silkscreen

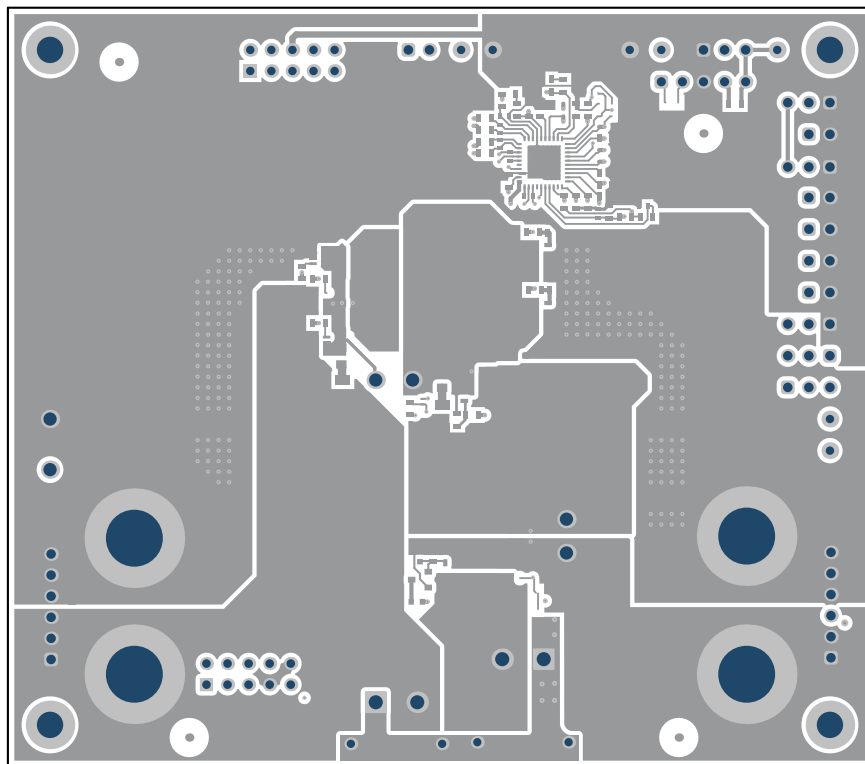

Figure 4-4. Top Layer

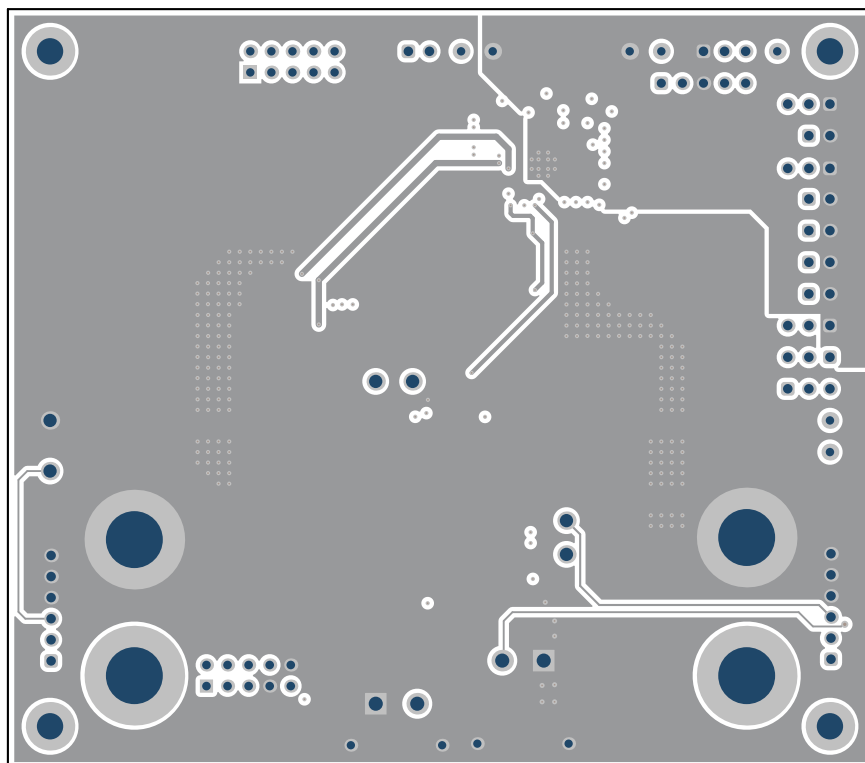

Figure 4-5. Mid-Layer 1

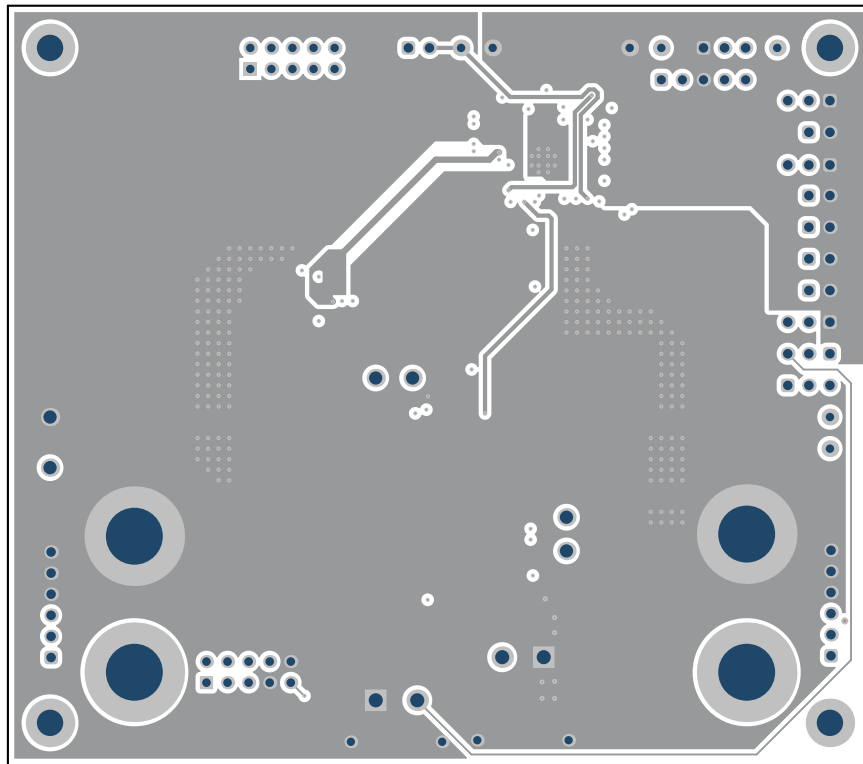

Figure 4-6. Mid-Layer 2

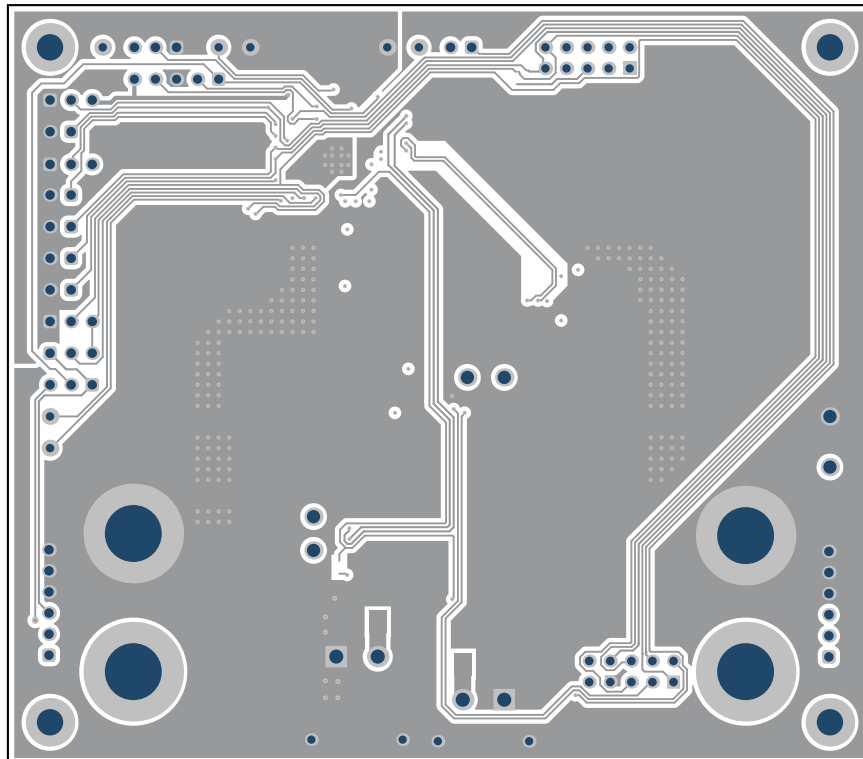

Figure 4-7. Bottom Layer

Note

On the PCB SR135A, capacitor C42 has a layout issue and is soldered directly to Q5.

4.3 Bill of Materials

Designator	Quantity	Value	PartNumber	Manufacturer	Description
C1, C2, C8, C10, C13	5		GRM188R72A104KA35D	Murata	0.1µF ±10% 100V Ceramic Capacitor X7R 0603 (1608 Metric)
C3, C5, C6, C9, C14, C20, C21, C22, C40, C41	10	10µF	C3225X7R2A106K250AC	TDK	10µF ±10% 100V Ceramic Capacitor X7R 1210 (3225 Metric)
C4, C7, C17, C18, C19, C23	6	27µF	A768KE276M1JLAE054	KEMET	Cap Aluminum Polymer 27uF 63V 20% Solder Cylindrical 54m Ohm 1175mA 2000 hr 125°C T/R
C11	1	0.1uF	GCJ188R72A104KA01D	MuRata	CAP, CERM, 0.1uF, 100V, +/- 10%, X7R, AEC-Q200 Grade 1, 0603
C12	1		GCM188L81H104KA57D	Murata Electronics North America	0.1µF ±10% 50V Ceramic Capacitor X8L 0603 (1608 Metric)
C15, C16	2	0.1uF	GRM155R62A104KE14D	MuRata	CAP, CERM, 0.1uF, 100V, +/- 10%, X5R, 0402
C24, C29	2	0.1uF	GRM155R71H104ME14D	MuRata	CAP, CERM, 0.1uF, 50V, +/- 20%, X7R, 0402
C25	1	270pF	GRM1555C1H271JA01D	MuRata	CAP, CERM, 270pF, 50V, +/- 5%, C0G/NP0, 0402
C26, C27	2	22µF	GRT188R61A226ME13D	Murata	Multi-Layer Ceramic Capacitor 22uF 10V X5R ±20% 0603 Paper T/R
C28	1	0.1uF	CGA3E3X7S2A104K080AB	TDK	CAP, CERM, 0.1uF, 100V, +/- 10%, X7S, AEC-Q200 Grade 1, 0603
C30	1	680pF	08051A681JAT2A	AVX	CAP, CERM, 680 pF, 100V, +/- 5%, C0G/NP0, 0805
C31, C33	2	0.1uF	GCM155R71H104KE02D	MuRata	CAP, CERM, 0.1uF, 50V, +/- 10%, X7R, AEC-Q200 Grade 1, 0402

Designator	Quantity	Value	PartNumber	Manufacturer	Description
C32	1	1000pF	C0805C102J1GACTU	Kemet	CAP, CERM, 1000pF, 100 V, +/- 5%, C0G/NP0, 0805
C34	1	220pF	06035A221FAT2A	AVX	CAP, CERM, 220pF, 50V, +/- 1%, C0G/NP0, 0603
C36	1	0.012uF	C0603C123K5RACTU	Kemet	CAP, CERM, 0.012uF, 50V, +/- 10%, X7R, AEC-Q200 Grade 1, 0603
C37	1	0.02uF	CC0603KRX7R9BB203	Yageo	CAP, CERM, 0.02uF, 50V, +/- 10%, X7R, 0603
C38	1	4700pF	06031C472JAT2A	AVX	CAP, CERM, 4700pF, 100V, +/- 5%, X7R, 0603
C39	1	0.047uF	06035C473JAT2A	AVX	CAP, CERM, 0.047uF, 50V, +/- 5%, X7R, 0603
C42	1	4700pF	C0603C472K5RACTU	Kemet	CAP, CERM, 4700pF, 50V, +/- 10%, X7R, 0603
C43, C44	2	680pF	C0603C681J5GACTU	Kemet	CAP, CERM, 680pF, 50V, +/- 5%, C0G/NP0, 0603
D1	1		BAS70-04-E3-18	Vishay	Diode Array 1 Pair Series Connection Schottky 70V 200mA (DC) Surface Mount TO-236-3, SC-59, SOT-23-3
D3, D4	2	48V	SMBJ48A-13-F	Diodes Inc.	Diode, TVS, Uni, 48V, 77.4 Vc, SMB
H1, H2, H3, H4	4		PMSSS 440 0025 PH	B&F Fastener Supply	MACHINE SCREW PAN PHILLIPS 4-40
J1, J2, J5, J6	4		108-0740-001	Cinch Connectivity	Standard Banana Jack, Uninsulated, 15A
J3, J4	2		61300611121	Würth Elektronik	Header, 2.54 mm, 6x1, Gold, TH
J7	1		SSW-105-02-G-D-RA	Samtec	10 Position Receptacle Connector 0.100" (2.54mm) Through Hole, Right Angle Gold

Designator	Quantity	Value	PartNumber	Manufacturer	Description
J9	1		XT30PW-F	Amass	Socket, DC supply, XT30, female, PIN: 2, on PCBs, THT, yellow, 15A
J10	1		XT30PW-M	Amass	Socket, DC supply, XT30, male, PIN: 2, on PCBs, THT, yellow, 15A, 500V
J11, JP6, JP8, JP10, JP11, JP12	6		61300211121	Würth Elektronik	Header, 2.54 mm, 2x1, Gold, TH
J12	1		N2510-6002-RB	3M	Header (shrouded), 100mil, 5x2, High-Temperature, Gold, TH
JP1, JP3, JP4, JP5, JP7, JP9	6		61300311121	Würth Elektronik	Header, 2.54 mm, 3x1, Gold, TH
JP2	1		61300511121	Würth Elektronik	Header, 2.54mm, 5x1, Gold, TH
L1	1	5.3uH	XAL1580-532MEB	Coilcraft	Inductor, Shielded, Composite, 5.3uH, 26.5A, 0.00435 ohm, SMD
Q1	1	60V	CSD18540Q5B	Texas Instruments	MOSFET, N-CH, 60V, 100A, DNK0008A (VSON-CLIP-8)
Q4, Q6	2		ISZ034N06LM5ATMA1	Infineon	N-Channel 60 V 19A (Ta), 112A (Tc) 2.5W (Ta), 83W (Tc) Surface Mount PG-TSDSON-8-26
Q5, Q7, Q8	3		ISC0703NLSATMA1	Infineon	MOSFET N-Channel 60 V 23A (Ta), 135A (Tc) 3W (Ta), 100W (Tc) Surface Mount PG-TDSON-8
R1	1	5.10k	RC0603FR-075K1L	Yageo	RES, 5.10k, 1%, 0.1W, 0603
R2, R7, R9, R10, R15, R16, R20, R24, R27, R35	10	0	RMCF0603ZT0R00	Stackpole Electronics Inc	RES, 0, 1%, 0.1W, AEC-Q200 Grade 0, 0603

Designator	Quantity	Value	PartNumber	Manufacturer	Description
R3	1	10m	KRL2012E-C-R010-F-T05	Susumu	10mOhms \pm 1% 1W Chip Resistor Wide 0805 (2012 Metric), 0508 Automotive AEC-Q200, Current Sense Metal Foil
R4, R6	2	5m	KRL2012E-M-R005-F-T5	Susumu	5mOhms \pm 1% 1W Chip Resistor Wide 0805 (2012 Metric), 0508 Automotive AEC-Q200, Current Sense Metal Foil
R13, R14, R28	3	3	CRCW06033R00JNEA	Vishay-Dale	RES, 3.0, 5%, 0.1W, AEC-Q200 Grade 0, 0603
R17, R18	2	10	CRCW060310R0FKEAHP	Vishay-Dale	RES, 10.0, 1%, 0.25W, AEC-Q200 Grade 0, 0603
R21	1	75.0k	RC0603FR-0775KL	Yageo	RES, 75.0k, 1%, 0.1 W, 0603
R22	1	12.7k	RC0603FR-0712K7L	Yageo	RES, 12.7k, 1%, 0.1W, 0603
R23, R26	2	3	CRCW12063R00JNEA	Vishay-Dale	RES, 3.0, 5%, 0.25W, AEC-Q200 Grade 0, 1206
R25	1	10.0k	RT0603BRD0710KL	Yageo America	RES, 10.0k, 0.1%, 0.1W, 0603
R29	1	7.15k	CRCW06037K15FKEA	Vishay-Dale	RES, 7.15k, 1%, 0.1W, AEC-Q200 Grade 0, 0603
R31	1	97.6k	RC0603FR-0797K6L	Yageo	RES, 97.6k, 1%, 0.1W, 0603
R32, R33	2	3.9	CRCW06033R90JNEA	Vishay-Dale	RES, 3.9, 5%, 0.1W, AEC-Q200 Grade 0, 0603
R34	1	20.0k	CRCW060320K0FKEA	Vishay-Dale	RES, 20.0k, 1%, 0.1W, AEC-Q200 Grade 0, 0603
R37	1	2.7k	CRCW06032K70JNEA	Vishay-Dale	RES, 2.7k, 5%, 0.1W, AEC-Q200 Grade 0, 0603
R43	1	10.0k	TNPW060310K0BEEA	Vishay-Dale	RES, 10.0k, 0.1%, 0.1W, AEC-Q200 Grade 1, 0603
RT1	1	10k	TMP6131DECR	Texas Instruments	\pm 1% tolerance 10k Ω linear thermistor available in 0402 and 0603 package options 2-X1SON -40 to 125

Designator	Quantity	Value	PartNumber	Manufacturer	Description
TP1, TP2	2		5013	Keystone Electronics	Test Point, Multipurpose, Orange, TH
TP3	1		5010	Keystone Electronics	Test Point, Multipurpose, Red, TH
TP4, TP7	2		5001	Keystone Electronics	Test Point, Miniature, Black, TH
TP5	1		5012	Keystone Electronics	Test Point, Multipurpose, White, TH
TP6	1		5128	Keystone Electronics	Test Point, Multipurpose, Grey, TH
TP8	1		5011	Keystone Electronics	Test Point, Multipurpose, Black, TH
TP9, TP10, TP11, TP12, TP13	5		5004	Keystone Electronics	Test Point, Miniature, Yellow, TH
U1	1		LM251772RHAR	Texas Instruments	55V 4-Switch Buck-Boost Controller with I2C interface
C35	0	56pF	06035A560FAT2A	AVX	CAP, CERM, 56pF, 50V, +/-1%, COG/NP0, 0603
D2	0	10V	MMSZ4697T1G	ON Semiconductor	Diode, Zener, 10V, 500mW, SOD-123
Q2	0		ISZ034N06LM5ATMA1	Infineon	N-Channel 60 V 19A (Ta), 112A (Tc) 2.5W (Ta), 83W (Tc) Surface Mount PG-TSDSON-8-26
Q3	0	-60V	SI7415DN-T1-GE3	Vishay-Siliconix	MOSFET, P-CH, -60V, -3.6A, PowerPAK 1212
R5	0	180k	CRCW0603180KJNEA	Vishay-Dale	RES, 180k, 5%, 0.1W, AEC-Q200 Grade 0, 0603
R8	0	10	RC0603FR-0710RL	Yageo	RES, 10.0, 1%, 0.1W, 0603
R11	0	43k	CRCW060343K0JNEA	Vishay-Dale	RES, 43k, 5%, 0.1W, AEC-Q200 Grade 0, 0603
R12	0	82.0k	RC0603FR-0782KL	Yageo	RES, 82.0k, 1%, 0.1W, 0603
R19	0	4.30k	RC0603FR-074K3L	Yageo	RES, 4.30k, 1%, 0.1W, 0603

Designator	Quantity	Value	PartNumber	Manufacturer	Description
R30	0	40.2k	CRCW060340K2FKEA	Vishay-Dale	RES, 40.2k, 1%, 0.1W, AEC-Q200 Grade 0, 0603
R36, R38	0	0	RMCF0603ZT0R00	Stackpole Electronics Inc	RES, 0, 1%, 0.1W, AEC-Q200 Grade 0, 0603
R39, R40	0	2.00k	RC0603FR-072KL	Yageo	RES, 2.00k, 1%, 0.1W, 0603
R41	0	3.83k	CRCW06033K83FKEA	Vishay-Dale	RES, 3.83k, 1%, 0.1W, AEC-Q200 Grade 0, 0603
R42	0	8.25k	RC0603FR-078K25L	Yageo	RES, 8.25k, 1%, 0.1W, 0603

5 Additional Information

Trademarks

USB Type-C® is a registered trademark of USB Implementers Forum.
All trademarks are the property of their respective owners.

STANDARD TERMS FOR EVALUATION MODULES

1. *Delivery:* TI delivers TI evaluation boards, kits, or modules, including any accompanying demonstration software, components, and/or documentation which may be provided together or separately (collectively, an "EVM" or "EVMs") to the User ("User") in accordance with the terms set forth herein. User's acceptance of the EVM is expressly subject to the following terms.
 - 1.1 EVMs are intended solely for product or software developers for use in a research and development setting to facilitate feasibility evaluation, experimentation, or scientific analysis of TI semiconductor products. EVMs have no direct function and are not finished products. EVMs shall not be directly or indirectly assembled as a part or subassembly in any finished product. For clarification, any software or software tools provided with the EVM ("Software") shall not be subject to the terms and conditions set forth herein but rather shall be subject to the applicable terms that accompany such Software
 - 1.2 EVMs are not intended for consumer or household use. EVMs may not be sold, sublicensed, leased, rented, loaned, assigned, or otherwise distributed for commercial purposes by Users, in whole or in part, or used in any finished product or production system.
2. *Limited Warranty and Related Remedies/Disclaimers:*
 - 2.1 These terms do not apply to Software. The warranty, if any, for Software is covered in the applicable Software License Agreement.
 - 2.2 TI warrants that the TI EVM will conform to TI's published specifications for ninety (90) days after the date TI delivers such EVM to User. Notwithstanding the foregoing, TI shall not be liable for a nonconforming EVM if (a) the nonconformity was caused by neglect, misuse or mistreatment by an entity other than TI, including improper installation or testing, or for any EVMs that have been altered or modified in any way by an entity other than TI, (b) the nonconformity resulted from User's design, specifications or instructions for such EVMs or improper system design, or (c) User has not paid on time. Testing and other quality control techniques are used to the extent TI deems necessary. TI does not test all parameters of each EVM. User's claims against TI under this Section 2 are void if User fails to notify TI of any apparent defects in the EVMs within ten (10) business days after delivery, or of any hidden defects with ten (10) business days after the defect has been detected.
 - 2.3 TI's sole liability shall be at its option to repair or replace EVMs that fail to conform to the warranty set forth above, or credit User's account for such EVM. TI's liability under this warranty shall be limited to EVMs that are returned during the warranty period to the address designated by TI and that are determined by TI not to conform to such warranty. If TI elects to repair or replace such EVM, TI shall have a reasonable time to repair such EVM or provide replacements. Repaired EVMs shall be warranted for the remainder of the original warranty period. Replaced EVMs shall be warranted for a new full ninety (90) day warranty period.

WARNING

Evaluation Kits are intended solely for use by technically qualified, professional electronics experts who are familiar with the dangers and application risks associated with handling electrical mechanical components, systems, and subsystems.

User shall operate the Evaluation Kit within TI's recommended guidelines and any applicable legal or environmental requirements as well as reasonable and customary safeguards. Failure to set up and/or operate the Evaluation Kit within TI's recommended guidelines may result in personal injury or death or property damage. Proper set up entails following TI's instructions for electrical ratings of interface circuits such as input, output and electrical loads.

NOTE:

EXPOSURE TO ELECTROSTATIC DISCHARGE (ESD) MAY CAUSE DEGRADATION OR FAILURE OF THE EVALUATION KIT; TI RECOMMENDS STORAGE OF THE EVALUATION KIT IN A PROTECTIVE ESD BAG.

3 Regulatory Notices:

3.1 United States

3.1.1 Notice applicable to EVMs not FCC-Approved:

FCC NOTICE: This kit is designed to allow product developers to evaluate electronic components, circuitry, or software associated with the kit to determine whether to incorporate such items in a finished product and software developers to write software applications for use with the end product. This kit is not a finished product and when assembled may not be resold or otherwise marketed unless all required FCC equipment authorizations are first obtained. Operation is subject to the condition that this product not cause harmful interference to licensed radio stations and that this product accept harmful interference. Unless the assembled kit is designed to operate under part 15, part 18 or part 95 of this chapter, the operator of the kit must operate under the authority of an FCC license holder or must secure an experimental authorization under part 5 of this chapter.

3.1.2 For EVMs annotated as FCC – FEDERAL COMMUNICATIONS COMMISSION Part 15 Compliant:

CAUTION

This device complies with part 15 of the FCC Rules. Operation is subject to the following two conditions: (1) This device may not cause harmful interference, and (2) this device must accept any interference received, including interference that may cause undesired operation.

Changes or modifications not expressly approved by the party responsible for compliance could void the user's authority to operate the equipment.

FCC Interference Statement for Class A EVM devices

NOTE: This equipment has been tested and found to comply with the limits for a Class A digital device, pursuant to part 15 of the FCC Rules. These limits are designed to provide reasonable protection against harmful interference when the equipment is operated in a commercial environment. This equipment generates, uses, and can radiate radio frequency energy and, if not installed and used in accordance with the instruction manual, may cause harmful interference to radio communications. Operation of this equipment in a residential area is likely to cause harmful interference in which case the user will be required to correct the interference at his own expense.

FCC Interference Statement for Class B EVM devices

NOTE: This equipment has been tested and found to comply with the limits for a Class B digital device, pursuant to part 15 of the FCC Rules. These limits are designed to provide reasonable protection against harmful interference in a residential installation. This equipment generates, uses and can radiate radio frequency energy and, if not installed and used in accordance with the instructions, may cause harmful interference to radio communications. However, there is no guarantee that interference will not occur in a particular installation. If this equipment does cause harmful interference to radio or television reception, which can be determined by turning the equipment off and on, the user is encouraged to try to correct the interference by one or more of the following measures:

- Reorient or relocate the receiving antenna.
- Increase the separation between the equipment and receiver.
- Connect the equipment into an outlet on a circuit different from that to which the receiver is connected.
- Consult the dealer or an experienced radio/TV technician for help.

3.2 Canada

3.2.1 For EVMs issued with an Industry Canada Certificate of Conformance to RSS-210 or RSS-247

Concerning EVMs Including Radio Transmitters:

This device complies with Industry Canada license-exempt RSSs. Operation is subject to the following two conditions:

(1) this device may not cause interference, and (2) this device must accept any interference, including interference that may cause undesired operation of the device.

Concernant les EVMs avec appareils radio:

Le présent appareil est conforme aux CNR d'Industrie Canada applicables aux appareils radio exempts de licence. L'exploitation est autorisée aux deux conditions suivantes: (1) l'appareil ne doit pas produire de brouillage, et (2) l'utilisateur de l'appareil doit accepter tout brouillage radioélectrique subi, même si le brouillage est susceptible d'en compromettre le fonctionnement.

Concerning EVMs Including Detachable Antennas:

Under Industry Canada regulations, this radio transmitter may only operate using an antenna of a type and maximum (or lesser) gain approved for the transmitter by Industry Canada. To reduce potential radio interference to other users, the antenna type and its gain should be so chosen that the equivalent isotropically radiated power (e.i.r.p.) is not more than that necessary for successful communication. This radio transmitter has been approved by Industry Canada to operate with the antenna types listed in the user guide with the maximum permissible gain and required antenna impedance for each antenna type indicated. Antenna types not included in this list, having a gain greater than the maximum gain indicated for that type, are strictly prohibited for use with this device.

Concernant les EVMs avec antennes détachables

Conformément à la réglementation d'Industrie Canada, le présent émetteur radio peut fonctionner avec une antenne d'un type et d'un gain maximal (ou inférieur) approuvé pour l'émetteur par Industrie Canada. Dans le but de réduire les risques de brouillage radioélectrique à l'intention des autres utilisateurs, il faut choisir le type d'antenne et son gain de sorte que la puissance isotrope rayonnée équivalente (p.i.r.e.) ne dépasse pas l'intensité nécessaire à l'établissement d'une communication satisfaisante. Le présent émetteur radio a été approuvé par Industrie Canada pour fonctionner avec les types d'antenne énumérés dans le manuel d'usage et ayant un gain admissible maximal et l'impédance requise pour chaque type d'antenne. Les types d'antenne non inclus dans cette liste, ou dont le gain est supérieur au gain maximal indiqué, sont strictement interdits pour l'exploitation de l'émetteur.

3.3 Japan

3.3.1 *Notice for EVMs delivered in Japan:* Please see http://www.tij.co.jp/lstds/ti_ja/general/eStore/notice_01.page 日本国内に輸入される評価用キット、ボードについては、次のところをご覧ください。

<https://www.ti.com/ja-jp/legal/notice-for-evaluation-kits-delivered-in-japan.html>

3.3.2 *Notice for Users of EVMs Considered "Radio Frequency Products" in Japan:* EVMs entering Japan may not be certified by TI as conforming to Technical Regulations of Radio Law of Japan.

If User uses EVMs in Japan, not certified to Technical Regulations of Radio Law of Japan, User is required to follow the instructions set forth by Radio Law of Japan, which includes, but is not limited to, the instructions below with respect to EVMs (which for the avoidance of doubt are stated strictly for convenience and should be verified by User):

1. Use EVMs in a shielded room or any other test facility as defined in the notification #173 issued by Ministry of Internal Affairs and Communications on March 28, 2006, based on Sub-section 1.1 of Article 6 of the Ministry's Rule for Enforcement of Radio Law of Japan,
2. Use EVMs only after User obtains the license of Test Radio Station as provided in Radio Law of Japan with respect to EVMs, or
3. Use of EVMs only after User obtains the Technical Regulations Conformity Certification as provided in Radio Law of Japan with respect to EVMs. Also, do not transfer EVMs, unless User gives the same notice above to the transferee. Please note that if User does not follow the instructions above, User will be subject to penalties of Radio Law of Japan.

【無線電波を送信する製品の開発キットをお使いになる際の注意事項】 開発キットの中には技術基準適合証明を受けていないものがあります。技術適合証明を受けていないものご使用に際しては、電波法遵守のため、以下のいずれかの措置を取っていただく必要がありますのでご注意ください。

1. 電波法施行規則第6条第1項第1号に基づく平成18年3月28日総務省告示第173号で定められた電波暗室等の試験設備でご使用いただく。
2. 実験局の免許を取得後ご使用いただく。
3. 技術基準適合証明を取得後ご使用いただく。

なお、本製品は、上記の「ご使用にあたっての注意」を譲渡先、移転先に通知しない限り、譲渡、移転できないものとします。

上記を遵守頂けない場合は、電波法の罰則が適用される可能性があることをご留意ください。日本テキサス・イ

ンスツルメンツ株式会社

東京都新宿区西新宿 6 丁目 2 4 番 1 号

西新宿三井ビル

3.3.3 *Notice for EVMs for Power Line Communication:* Please see http://www.tij.co.jp/lstds/ti_ja/general/eStore/notice_02.page

電力線搬送波通信についての開発キットをお使いになる際の注意事項については、次のところをご覧ください。 <https://www.ti.com/ja-jp/legal/notice-for-evaluation-kits-for-power-line-communication.html>

3.4 European Union

3.4.1 *For EVMs subject to EU Directive 2014/30/EU (Electromagnetic Compatibility Directive):*

This is a class A product intended for use in environments other than domestic environments that are connected to a low-voltage power-supply network that supplies buildings used for domestic purposes. In a domestic environment this product may cause radio interference in which case the user may be required to take adequate measures.

-
4. *EVM Use Restrictions and Warnings:*
 - 4.1 EVMS ARE NOT FOR USE IN FUNCTIONAL SAFETY AND/OR SAFETY CRITICAL EVALUATIONS, INCLUDING BUT NOT LIMITED TO EVALUATIONS OF LIFE SUPPORT APPLICATIONS.
 - 4.2 User must read and apply the user guide and other available documentation provided by TI regarding the EVM prior to handling or using the EVM, including without limitation any warning or restriction notices. The notices contain important safety information related to, for example, temperatures and voltages.
 - 4.3 *Safety-Related Warnings and Restrictions:*
 - 4.3.1 User shall operate the EVM within TI's recommended specifications and environmental considerations stated in the user guide, other available documentation provided by TI, and any other applicable requirements and employ reasonable and customary safeguards. Exceeding the specified performance ratings and specifications (including but not limited to input and output voltage, current, power, and environmental ranges) for the EVM may cause personal injury or death, or property damage. If there are questions concerning performance ratings and specifications, User should contact a TI field representative prior to connecting interface electronics including input power and intended loads. Any loads applied outside of the specified output range may also result in unintended and/or inaccurate operation and/or possible permanent damage to the EVM and/or interface electronics. Please consult the EVM user guide prior to connecting any load to the EVM output. If there is uncertainty as to the load specification, please contact a TI field representative. During normal operation, even with the inputs and outputs kept within the specified allowable ranges, some circuit components may have elevated case temperatures. These components include but are not limited to linear regulators, switching transistors, pass transistors, current sense resistors, and heat sinks, which can be identified using the information in the associated documentation. When working with the EVM, please be aware that the EVM may become very warm.
 - 4.3.2 EVMs are intended solely for use by technically qualified, professional electronics experts who are familiar with the dangers and application risks associated with handling electrical mechanical components, systems, and subsystems. User assumes all responsibility and liability for proper and safe handling and use of the EVM by User or its employees, affiliates, contractors or designees. User assumes all responsibility and liability to ensure that any interfaces (electronic and/or mechanical) between the EVM and any human body are designed with suitable isolation and means to safely limit accessible leakage currents to minimize the risk of electrical shock hazard. User assumes all responsibility and liability for any improper or unsafe handling or use of the EVM by User or its employees, affiliates, contractors or designees.
 - 4.4 User assumes all responsibility and liability to determine whether the EVM is subject to any applicable international, federal, state, or local laws and regulations related to User's handling and use of the EVM and, if applicable, User assumes all responsibility and liability for compliance in all respects with such laws and regulations. User assumes all responsibility and liability for proper disposal and recycling of the EVM consistent with all applicable international, federal, state, and local requirements.
 5. *Accuracy of Information:* To the extent TI provides information on the availability and function of EVMs, TI attempts to be as accurate as possible. However, TI does not warrant the accuracy of EVM descriptions, EVM availability or other information on its websites as accurate, complete, reliable, current, or error-free.
 6. *Disclaimers:*
 - 6.1 EXCEPT AS SET FORTH ABOVE, EVMS AND ANY MATERIALS PROVIDED WITH THE EVM (INCLUDING, BUT NOT LIMITED TO, REFERENCE DESIGNS AND THE DESIGN OF THE EVM ITSELF) ARE PROVIDED "AS IS" AND "WITH ALL FAULTS." TI DISCLAIMS ALL OTHER WARRANTIES, EXPRESS OR IMPLIED, REGARDING SUCH ITEMS, INCLUDING BUT NOT LIMITED TO ANY EPIDEMIC FAILURE WARRANTY OR IMPLIED WARRANTIES OF MERCHANTABILITY OR FITNESS FOR A PARTICULAR PURPOSE OR NON-INFRINGEMENT OF ANY THIRD PARTY PATENTS, COPYRIGHTS, TRADE SECRETS OR OTHER INTELLECTUAL PROPERTY RIGHTS.
 - 6.2 EXCEPT FOR THE LIMITED RIGHT TO USE THE EVM SET FORTH HEREIN, NOTHING IN THESE TERMS SHALL BE CONSTRUED AS GRANTING OR CONFERRING ANY RIGHTS BY LICENSE, PATENT, OR ANY OTHER INDUSTRIAL OR INTELLECTUAL PROPERTY RIGHT OF TI, ITS SUPPLIERS/LICENSORS OR ANY OTHER THIRD PARTY, TO USE THE EVM IN ANY FINISHED END-USER OR READY-TO-USE FINAL PRODUCT, OR FOR ANY INVENTION, DISCOVERY OR IMPROVEMENT, REGARDLESS OF WHEN MADE, CONCEIVED OR ACQUIRED.
 7. *USER'S INDEMNITY OBLIGATIONS AND REPRESENTATIONS.* USER WILL DEFEND, INDEMNIFY AND HOLD TI, ITS LICENSORS AND THEIR REPRESENTATIVES HARMLESS FROM AND AGAINST ANY AND ALL CLAIMS, DAMAGES, LOSSES, EXPENSES, COSTS AND LIABILITIES (COLLECTIVELY, "CLAIMS") ARISING OUT OF OR IN CONNECTION WITH ANY HANDLING OR USE OF THE EVM THAT IS NOT IN ACCORDANCE WITH THESE TERMS. THIS OBLIGATION SHALL APPLY WHETHER CLAIMS ARISE UNDER STATUTE, REGULATION, OR THE LAW OF TORT, CONTRACT OR ANY OTHER LEGAL THEORY, AND EVEN IF THE EVM FAILS TO PERFORM AS DESCRIBED OR EXPECTED.
-

8. *Limitations on Damages and Liability:*

8.1 *General Limitations.* IN NO EVENT SHALL TI BE LIABLE FOR ANY SPECIAL, COLLATERAL, INDIRECT, PUNITIVE, INCIDENTAL, CONSEQUENTIAL, OR EXEMPLARY DAMAGES IN CONNECTION WITH OR ARISING OUT OF THESE TERMS OR THE USE OF THE EVMS , REGARDLESS OF WHETHER TI HAS BEEN ADVISED OF THE POSSIBILITY OF SUCH DAMAGES. EXCLUDED DAMAGES INCLUDE, BUT ARE NOT LIMITED TO, COST OF REMOVAL OR REINSTALLATION, ANCILLARY COSTS TO THE PROCUREMENT OF SUBSTITUTE GOODS OR SERVICES, RETESTING, OUTSIDE COMPUTER TIME, LABOR COSTS, LOSS OF GOODWILL, LOSS OF PROFITS, LOSS OF SAVINGS, LOSS OF USE, LOSS OF DATA, OR BUSINESS INTERRUPTION. NO CLAIM, SUIT OR ACTION SHALL BE BROUGHT AGAINST TI MORE THAN TWELVE (12) MONTHS AFTER THE EVENT THAT GAVE RISE TO THE CAUSE OF ACTION HAS OCCURRED.

8.2 *Specific Limitations.* IN NO EVENT SHALL TI'S AGGREGATE LIABILITY FROM ANY USE OF AN EVM PROVIDED HEREUNDER, INCLUDING FROM ANY WARRANTY, INDEMNITY OR OTHER OBLIGATION ARISING OUT OF OR IN CONNECTION WITH THESE TERMS, , EXCEED THE TOTAL AMOUNT PAID TO TI BY USER FOR THE PARTICULAR EVM(S) AT ISSUE DURING THE PRIOR TWELVE (12) MONTHS WITH RESPECT TO WHICH LOSSES OR DAMAGES ARE CLAIMED. THE EXISTENCE OF MORE THAN ONE CLAIM SHALL NOT ENLARGE OR EXTEND THIS LIMIT.

9. *Return Policy.* Except as otherwise provided, TI does not offer any refunds, returns, or exchanges. Furthermore, no return of EVM(s) will be accepted if the package has been opened and no return of the EVM(s) will be accepted if they are damaged or otherwise not in a resalable condition. If User feels it has been incorrectly charged for the EVM(s) it ordered or that delivery violates the applicable order, User should contact TI. All refunds will be made in full within thirty (30) working days from the return of the components(s), excluding any postage or packaging costs.

10. *Governing Law:* These terms and conditions shall be governed by and interpreted in accordance with the laws of the State of Texas, without reference to conflict-of-laws principles. User agrees that non-exclusive jurisdiction for any dispute arising out of or relating to these terms and conditions lies within courts located in the State of Texas and consents to venue in Dallas County, Texas. Notwithstanding the foregoing, any judgment may be enforced in any United States or foreign court, and TI may seek injunctive relief in any United States or foreign court.

Mailing Address: Texas Instruments, Post Office Box 655303, Dallas, Texas 75265
Copyright © 2023, Texas Instruments Incorporated

IMPORTANT NOTICE AND DISCLAIMER

TI PROVIDES TECHNICAL AND RELIABILITY DATA (INCLUDING DATA SHEETS), DESIGN RESOURCES (INCLUDING REFERENCE DESIGNS), APPLICATION OR OTHER DESIGN ADVICE, WEB TOOLS, SAFETY INFORMATION, AND OTHER RESOURCES "AS IS" AND WITH ALL FAULTS, AND DISCLAIMS ALL WARRANTIES, EXPRESS AND IMPLIED, INCLUDING WITHOUT LIMITATION ANY IMPLIED WARRANTIES OF MERCHANTABILITY, FITNESS FOR A PARTICULAR PURPOSE OR NON-INFRINGEMENT OF THIRD PARTY INTELLECTUAL PROPERTY RIGHTS.

These resources are intended for skilled developers designing with TI products. You are solely responsible for (1) selecting the appropriate TI products for your application, (2) designing, validating and testing your application, and (3) ensuring your application meets applicable standards, and any other safety, security, regulatory or other requirements.

These resources are subject to change without notice. TI grants you permission to use these resources only for development of an application that uses the TI products described in the resource. Other reproduction and display of these resources is prohibited. No license is granted to any other TI intellectual property right or to any third party intellectual property right. TI disclaims responsibility for, and you will fully indemnify TI and its representatives against, any claims, damages, costs, losses, and liabilities arising out of your use of these resources.

TI's products are provided subject to [TI's Terms of Sale](#) or other applicable terms available either on [ti.com](https://www.ti.com) or provided in conjunction with such TI products. TI's provision of these resources does not expand or otherwise alter TI's applicable warranties or warranty disclaimers for TI products.

TI objects to and rejects any additional or different terms you may have proposed.

Mailing Address: Texas Instruments, Post Office Box 655303, Dallas, Texas 75265

Copyright © 2025, Texas Instruments Incorporated