

DMA and Radio Configuration

By Siri Johnsrud

Keywords

- *DMA*
- *Packet Handling Configuration*
- *Radio*
- *CC1110*
- *CC1111*
- *CC2510*
- *CC2511*

1 Introduction

The purpose of this design note is to describe how the DMA should be configured for the different packet formats supported by the radio.

In the following sections, an n in the register name represents the channel number 0, 1, 2, 3, or 4 if nothing else is stated.

Table of Contents

KEYWORDS	1
1 INTRODUCTION	1
2 ABBREVIATIONS	2
3 DMA CONFIGURATION	3
4 PACKET FORMAT	5
4.1 RADIO USING VARIABLE PACKET LENGTH MODE	5
4.1.1 <i>Maximum Length Filtering in RX Mode</i>	6
4.2 RADIO USING FIXED PACKET LENGTH MODE.....	8
5 USING THE WRONG CONFIGURATION	9
5.1 VARIABLE PACKET LENGTH MODE	9
5.2 FIXED PACKET LENGTH MODE	13
6 REFERENCES	17
7 GENERAL INFORMATION	18
7.1 DOCUMENT HISTORY.....	18

2 Abbreviations

CPU	Central Processing Unit
DMA	Direct Memory Access
ISR	Interrupt Service Routine
RF	Radio Frequency
RX	Receive
TX	Transmit

3 DMA Configuration

The DMA channel parameters have to be configured before a DMA channel can be armed and activated. These parameters are written in a special DMA configuration data structure in memory. The DMA configuration data structure consists of eight bytes and is described below. Please see the CC1110/CC1111 [1] and/or the CC2510/CC2511 [1] data sheet for more details.

- **Source Address (SRCADDR)**

This is the address where the DMA shall start to read data. In TX mode, this should be the address to a buffer in XDATA memory space, *txBuffer*, holding the data to be transmitted. In RX mode, this should be the address of the RF Data register, *RFD*.

- **Destination Address (DESTADDR)**

This is the address where the DMA shall start to write the data read from the source address. In TX mode, this should be the address of the RF Data register, *RFD*. In RX mode this should be the address to a buffer in XDATA memory space, *rxBuffer*, where the received data should be stored.

*Note: The size of *txBuffer* and *rxBuffer* must be equal to, or greater than, the maximum transfer count (see Table 1).*

- **Transfer Count (VLEN and LEN)**

The transfer count gives the number of bytes/words needed to be moved from source to destination. There are two parameters used for configuring the transfer count. These are VLEN and LEN. How these parameters should be set depends on the packet format of the radio packets and will be discussed in details in Section 4.

- **Byte or Word Transfer (WORDSIZE)**

The radio packet format is byte oriented, hence each DMA transfer should be one byte (*WORDSIZE = 0_b*).

- **Trigger Event (TRIG)**

When used to move data to and from the *RFD* register, the trigger event should be DMA trigger #19, which is the radio trigger. A trigger event will occur for each new byte the radio writes to the *RFD* register in RX mode and for each byte the radio reads from the *RFD* register in TX mode (*TRIG = 10011_b*).

- **Transfer Mode (TMODE)**

Since there is a trigger event for every byte transmitted/received, the transfer mode should be set to single mode (*TMODE = 00_b*). On each trigger, a single byte transfer occurs and the DMA channel awaits the next trigger.

- **Source Increment (SRCINC)**

- TX mode:

The source address is the address to a buffer in XDATA memory space, *txBuffer*, and the source address should be configured to increment by one after each transfer (*SRCINC = 01_b*).

- RX mode:

The source address is the address of the RF Data register, *RFD* and the source address should not change between transfers (*SRCINC = 00_b*).

- **Destination Increment (DESTINC)**

- TX mode:
The destination address is the address of the RF Data register, `RFD`, and the destination address should not be changed between transfers (`SRCINC = 00b`).
- RX mode:
The destination address is the address to a buffer in XDATA memory space, `rxBuffer`, and the destination address should be configured to increment by one after each transfer (`SRCINC = 01b`).

- **Interrupt Mask (IRQMASK)**

If this bit is set to 1, the CPU interrupt flag `IRCON.DMAIF` will be asserted when the transfer count is reached and an interrupt request will be generated if the corresponding CPU interrupt mask bit, `IEN1.DMAIE`, is 1. Note that the DMA interrupt flag `DMAIRQ.DMAIFn` will be set when transfer count is reached regardless of the `IRQMASK` bit.

- TX mode:
Since the DMA will be done transferring data to the `RFD` register before the radio is done transmitting the data on the air, the general RF interrupt associated with the `IRQ_DONE` flag should be used instead of the DMA interrupt to make sure that the radio is not turned off before the packet is properly transmitted (`IRQMASK = 0b`).
- RX mode:
In receive mode the radio and DMA interrupt will happen almost simultaneously except in the case where `PKTCTRL1.APPEND_STATUS = 0b` and `PKTCTRL0.CRC_EN = 1b`. In this case the DMA interrupt will happen before the RF interrupt. If one uses the RF interrupt one must be aware that this interrupt will also be executed in TX mode when a packet has been transmitted.

Note: If the radio implements maximum length filtering (`PKTCTRL0.LENGTH_CONFIG = 01b` and `PKTLEN ≠ 0xFF`) or address filtering (`PKTCTRL1.ADR_CHK ≠ 00b`), filtering of packets will cause the `IRQ_DONE` flag to be asserted, but will not give a DMA trigger (`DMAIRQ.DMAIFn` will not be asserted).

- **Mode 8 Setting (M8)**

This configuration is only applicable when doing byte transfers (`WORDSIZE = 0b`) and the transfer count is of variable length (`VLEN ≠ 000b` and `VLEN ≠ 111b`). When this is the case, this field determines whether to use seven or eight bits of the first byte in source data to determine the transfer count. To be compliant with the radio packet format (see Figure 1), all 8 bits should be used as the transfer length (`M8 = 0b`).

- **DMA Priority (PRIORITY)**

The DMA priority is used to determine the winner in the case of multiple simultaneous internal memory requests, and whether the DMA memory access should have priority or not over a simultaneous CPU memory access. The priority should be set to high (`PRIORITY = 10b`) when the DMA is used to move data to and from the `RFD` register, to avoid having the radio enter `TX_UNDERFLOW` or `RX_OVERFLOW` state. See the data sheets ([1] and [2]) for more details on the different radio control states.

4 Packet Format

The packet format supported by the radio is shown in Figure 1.

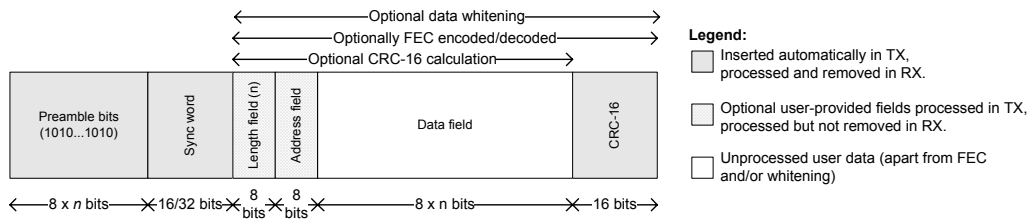

Figure 1. Packet Format

In addition to a preamble and a sync word (2 or 4 bytes long), the packet consist of an optional length byte n, an optional address byte, the payload, and an optional 2 byte CRC. The address byte is part of the payload and is not interpreted by the DMA. If the radio implements address filtering (`PKTCTRL1.ADR_CHK` \neq `00b`) and a packet is being discarded, RX mode will be restarted (regardless of the `MCSM1.RXOFF_MODE` setting), and the `RFIF.IRQ_DONE` flag will be asserted but the DMA will not be triggered.

4.1 Radio using Variable Packet Length Mode

Variable packet length mode is selected by setting `PKTCTRL0.LENGTH_CONFIG` = `01b`. In this mode, the length byte, n, is following the sync word in the packet ($1 \leq n \leq 255$). The packet length is defined as the payload data, excluding the length byte and the optional CRC bytes. The DMA has 4 different configurations which supports variable length transfer count and these are `VLEN` = {`001b`, `010b`, `011b`, `100b`} (see Figure 2).

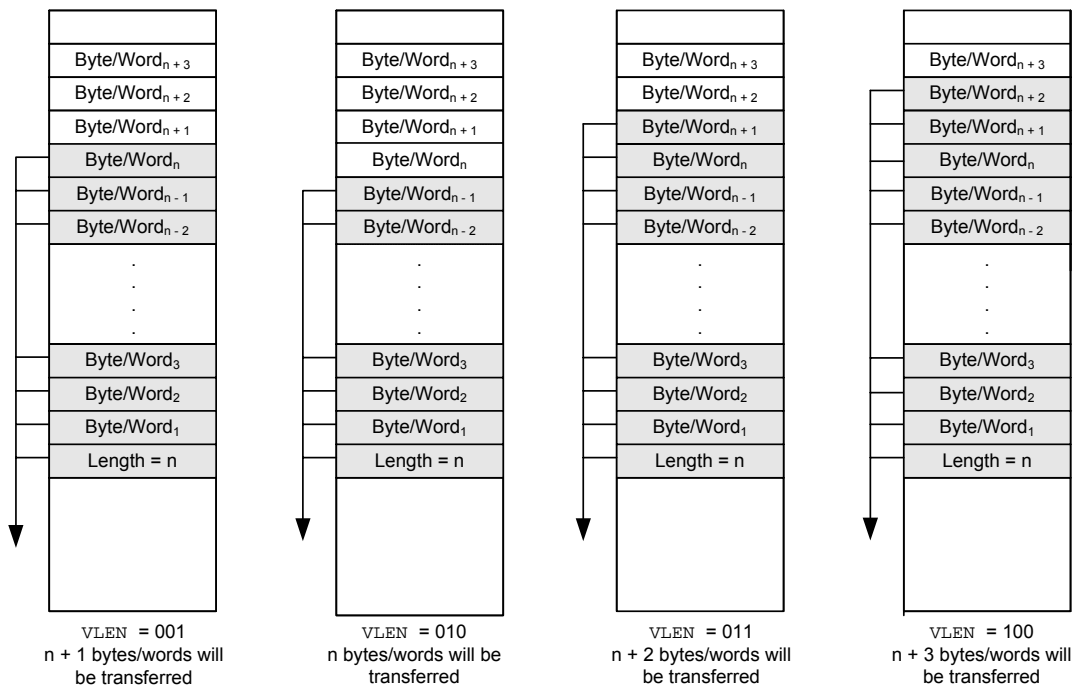

Figure 2. Variable Length Transfer Count Options

However, only two of these configurations are useful when moving data packets to and from the `RFD` register; `VLEN` = `001b` and `VLEN` = `100b`. Which one to use depends on the active mode of the radio (RX or TX) and on the `APPEND_STATUS` field in the `PKTCTRL1` register (RX mode only). Assume transmitting and receiving the data packet shown in Figure 3:

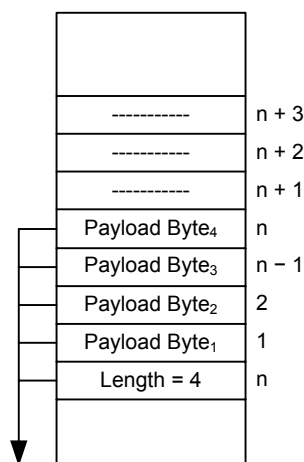

Figure 3. Variable Packet Length Mode (n = 4)

- TX mode:

A total of 5 (n + 1) bytes should be transmitted (1 length byte + n payload bytes) → $VLEN = 001_b$ (see Figure 2).
- RX mode
 - $PKTCTRL1.APPEND_STATUS = 0_b$:

Nothing is appended to the payload → $VLEN = 001_b$ (see Figure 2)
 - $PKTCTRL1.APPEND_STATUS = 1_b$:

Two bytes are appended to the received payload at position (n + 1) and position (n + 2). This means that a total of n + 3 bytes should be transmitted → $VLEN = 100_b$ (see Figure 2).

4.1.1 Maximum Length Filtering in RX Mode

Assume that the packets to be received are of variable length but the max length byte value is less than 255 ($n_{max} < 255$). In this case, maximum length filtering can be used in the radio to avoid receiving packets intended for other receivers (or noise). To enable maximum length filtering, $PKTLEN.PACKET_LENGTH$ should be set to n_{max} . In RX mode, the radio will discard packets with a length byte larger than n_{max} and RX mode will be restarted. The $RFIF.IRQ_DONE$ flag will be asserted but the DMA will not be triggered. See the data sheets ([1] and [2]) for more details on the different interrupt flags associated with the radio.

Note: The $PKTLEN$ register is not used by the radio in TX mode when configured for variable packet length mode ($PKTCTRL0.LENGTH_CONFIG = 01_b$).

When a DMA channel is configured to operate with variable length transfer counts, $VLEN = \{001_b, 010_b, 011_b, 100_b\}$, the transfer count will be limited to LEN bytes/words when $n \geq LEN$ (see Table 1). Table 2 shows the transfer count for different values of n when $LEN = 13$.

	Transfer Count			
	$VLEN = 001_b$	$VLEN = 010_b$	$VLEN = 011_b$	$VLEN = 100_b$
$n < LEN$	n + 1	n	n + 2	n + 3
$n \geq LEN$	LEN	LEN	LEN	LEN
Max Transfer Count	LEN	LEN	LEN + 1	LEN + 2

Table 1. Transfer Count

From Table 1 we see that when $VLEN = \{001_b, 011_b, 100_b\}$, LEN should be greater than n to make sure that the complete packet is transferred. When $VLEN = 010_b$, LEN can be set equal to n . Due to the maximum length filtering implemented in the radio, only packets with length byte $\leq n_{max}$ will trigger the DMA.

$LEN = n_{max} + 1$ when $VLEN = \{001_b, 011_b, 100_b\}$

$LEN = n_{max}$ when $VLEN = 010_b$

Example 1:

A transmitter transmits packets of variable lengths (see Figure 4) and the length byte will have a value n , where $1 \leq n \leq 255$. CRC is appended.

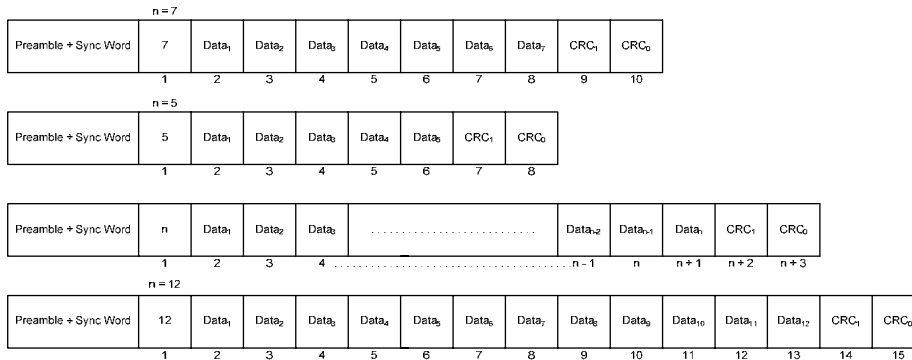

Figure 4. Packets Transmitted

- Transmitter Configuration:

The CRC bytes at the end of the packets are appended automatically by the radio, hence the DMA controller should be configured to transfer the length byte and the data bytes to the RFD register → $VLEN = 001_b$ (transfer count is $n + 1$).

$LEN = n_{max} + 1 = 255 + 1 = 256$ → $LEN = 0000100000000_b$

$PKTLEN = xxxxxxxx_b$ (don't care)

- Receiver Configuration:

The receiver has $PKTCTRL1.APPEND_STATUS = 1_b$ meaning that 2 status bytes are appended to the payload. The CRC bytes are processed and removed automatically, hence they will never appear in the RFD register. By default, $PKTLEN = 255$, and the receiver will accept all packets with a valid sync word (there are 8 different sync word qualifier modes configured through $MDMCFG.SYNC_MODE$) See the data sheets ([1] and [2]) for more details.

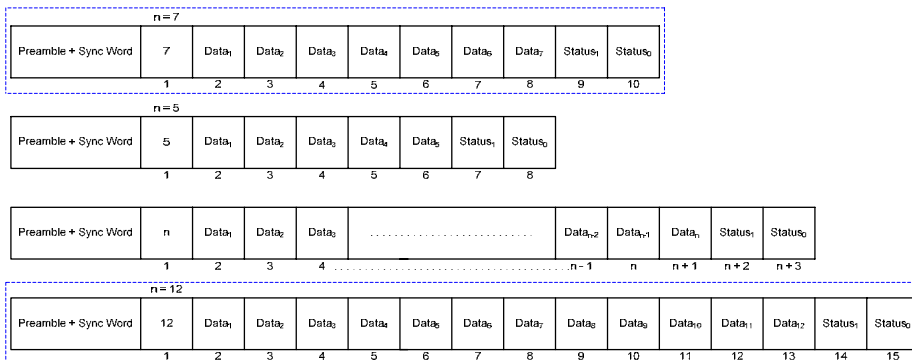

Figure 5. Packets Received

A receiver is e.g. only interested in packets where $n = \{7, 12\}$ (see Figure 5), hence maximum length filtering is enabled $\rightarrow \text{PKTLEN} = n_{\text{max}} = 12 \rightarrow \text{PKTLEN} = 00001100_{\text{b}}$. This means that if the radio receives a length byte greater than 12, the packet will be discarded and nothing will be put in the RFD register \rightarrow the DMA will not be triggered.

$\text{VLEN} = 100_{\text{b}}$, (transfer count is $n + 3$)

$\text{LEN} = n_{\text{max}} + 1 = 12 + 1 = 13 \rightarrow \text{LEN} = 0000000001101_{\text{b}}$

Note: All packets with length byte ≤ 12 will be received by the radio and trigger the DMA. Filtering of packets with length byte not equal to 7 or 12 must be implemented in software.

4.2 Radio using Fixed Packet Length Mode

Fixed packet length mode is selected by setting $\text{PKTCTRL0.LENGTH_CONFIG} = 00_{\text{b}}$. In this mode the packet does not contain a length byte, and the PKTLEN register determines how many bytes will be transmitted/received ($1 \leq \text{PKTLEN} \leq 255$). By setting $\text{VLEN} = \{000_{\text{b}}, 111_{\text{b}}\}$ the DMA will be configured for fixed length transfer count, and the transfer count is given by the LEN setting (see Figure 6).

- TX mode:
 - $\text{LEN} = \text{PKTLEN}$
- RX mode:
 - $\text{PKTCTRL1.APPEND_STATUS} = 0_{\text{b}}$:
 - $\text{LEN} = \text{PKTLEN}$
 - $\text{PKTCTRL1.APPEND_STATUS} = 1_{\text{b}}$:
 - $\text{LEN} = \text{PKTLEN} + 2$

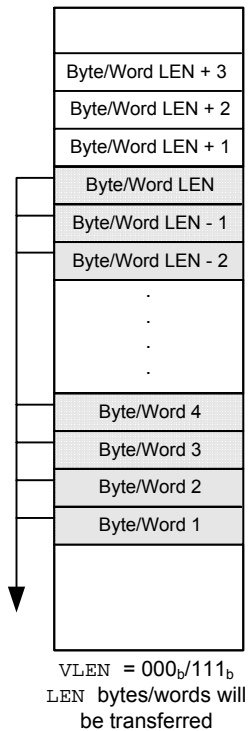

Figure 6. Fixed Length Transfer Count

5 Using the Wrong Configuration

The following two sections (Section 5.1 and Section 5.2) will show what will happen if there is a mismatch between the radio configuration and the DMA configuration with respect to how many bytes should be transferred. In RX mode, the radio will enter RX_OVERFLOW state if the radio tries to write more data to the RFD register than what the DMA will read from the same register. In TX mode, the radio will enter TX_UNDERFLOW state if the radio tries to read more data from the RFD register than what the DMA writes to the same register. The RFIF.IRQ_RXOVF flag will be asserted if RX_OVERFLOW state is entered while the RFIF.IRQ_TXUVF flag will be asserted when TX_UNDERFLOW state is entered. In both cases, the RFIF.IRQ_DONE flag will be set to 1.

5.1 Variable Packet Length Mode

In this section Example 1, page 7, will be used to show what might happens if the transfer count configuration of the DMA channel is not correct.

- RX Settings:
 - PKTLEN = $n_{\max} = 12$
 - LEN = $n_{\max} + 1 = 12 + 1 = 13$
 - VLEN = 100_b

Table 2 shows the transfer count, i.e. how many bytes the DMA will transfer, for different VLEN settings and different length bytes, n, given that LEN = 13. Maximum transfer counts for the different VLEN settings are emphasized in **bold**.

			Transfer Count			
	n	LEN	VLEN = 001 _b	VLEN = 010 _b	VLEN = 011 _b	VLEN = 100 _b
n < LEN	1	13	2	1	3	4
	2	13	3	2	4	5
	3	13	4	3	5	6
	4	13	5	4	6	7
	5	13	6	5	7	8
	6	13	7	6	8	9
	7	13	8	7	9	10
	8	13	9	8	10	11
	9	13	10	9	11	12
	10	13	11	10	12	13
	11	13	12	11	13	14
	12	13	13	12	14	15
n ≥ LEN	13	13	13	13	13	13
	14	13	13	13	13	13

	.	13	13	13	13	13

	254	13	13	13	13	13
	255	13	13	13	13	13

Table 2. Transfer Count for Different VLEN Settings (LEN = 13 and n = {1, 2, . . . , 255})

Using the wrong VLEN setting, $VLEN = \{001_b, 010_b, 011_b\}$, will cause the DMA to complete the transfer (transfer count reached) before the radio is done writing data to the RFD register. Remember that $PKTCTRL1.APPEND_STATUS = 1_b$, meaning that the radio will try to write $n + 3$ bytes to this register.

Figure 7 shows the largest packet that will pass the maximum length filtering implemented in the radio when $PKTLEN = 12$.



Figure 7. Maximum Length Filtering

- VLEN = 001_b:

Transfer count is reached after Data₁₂ has been transferred from the RFD register. Neither RFIF.IRQ_DONE nor RFIF.IRQ_RXOVF is being asserted, as one should expect. The radio will be stuck in RX state (MARCSTATE = 0x0D), but it will not be able to receive any more data (see the errata notes [3] and [4] for more details).
- VLEN = 010_b:

Transfer count is reached after Data₁₁ has been transferred from the RFD register. Both RFIF.IRQ_DONE and RFIF.IRQ_RXOVF is being asserted. The radio will enter RX_OVERFLOW state (MARCSTATE = 0x11).
- VLEN = 011_b:

Transfer count is reached after Status₁ has been transferred from the RFD register. Neither RFIF.IRQ_DONE nor RFIF.IRQ_RXOVF is being asserted, as one should expect. The radio will be stuck in RX state (MARCSTATE = 0x0D), but it will not be able to receive any more data (see the errata notes [3] and [4] for more details).

If the correct VLEN setting is used, $VLEN = 100_b$, but maximum length filtering is not used on the radio ($PKTLEN = 255$), all packets received with length byte $n > 12$ will cause the radio to enter RX_OVERFLOW state.

- TX Settings:
 - PKTLEN = xxxxxxxx_b (don't care)
 - LEN = n_{max} + 1 = 255 + 1 = 256
 - VLEN = 001_b

			Transfer Count			
	n	LEN	VLEN = 001 _b	VLEN = 010 _b	VLEN = 011 _b	VLEN = 100 _b
n < LEN	1	256	2	1	3	4
	2	256	3	2	4	5
	3	256	4	3	5	6
	4	256	5	4	6	7
	5	256	6	5	7	8
	6	256	7	6	8	9
	7	256	8	7	9	10
	8	256	9	8	10	11
	9	256	10	9	11	12
	10	256	11	10	12	13
	11	256	12	11	13	14
	12	256	13	12	14	15
	13	256	14	13	15	16
	14	256	15	14	16	17

.	
.	256	n + 1	n	n + 2	n + 3	
.	
254	256	255	254	256	257	
255	256	256	255	257	258	

Table 3. Transfer Count for Different VLEN Settings (LEN = 256 and n = {1, 2, . . . , 255})

The radio is configured to use variable packet length mode, and will always read n + 1 bytes from the RFD register.

Assume setting VLEN = 010_b. In this case the transfer count will be reached when the radio has one more byte left to transmit, and the radio will enter TX_UNDERFLOW state (RFIF.IRQ_TXUNF = 1_b and MARCSTATE = 0x16). The only way to proceed is by issuing an SIDLE strobe command (RFST = 0x04).

If using VLEN = {001_b, 011_b}, the radio might also enter TX_UNDERFLOW state, but not before transmitting the subsequent packet.

Consider the following pseudo code:

```

//-----
//-----
// Transmit one radio packet every time the button is being pushed.
void main (void)
{
    // Init
    .
    // Init Radio
    // Init DMA
    // Enable RF interrupt (IRQ_DONE)

    while (TRUE)
    {
        // Wait for button to be pushed
        // Arm DMA
        // Strobe TX
    }
}
//-----
//-----
#pragma vector=RF_VECTOR
__interrupt void rf_IRQ(void)
{
    // Clear interrupt flag
    // Increment packet counter
}
//-----
//-----

```

The *txBuffer* containing the data to be transmitted is shown in Figure 8.



Figure 8. txBuffer

When using the correct VLEN setting (VLEN = 001_b), the transfer count is n + 1 = 6. The radio will transmit 6 bytes, meaning that it will trigger the DMA 6 times. By pushing the button twice, the radio packet shown in Figure 9 will be sent twice.

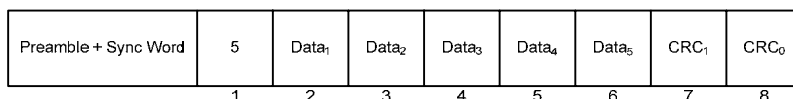

Figure 9. Packet Sent Twice when VLEN = 001_b

When VLEN = 011_b, the transfer count is 7. The radio, however, will only trigger the DMA 6 times. That means that the first time the button is pushed, the radio will transmit the packet shown in Figure 9 and an RF interrupt request will be generated. The DMA, however, has not yet reached its transfer count and awaits its last trigger; i.e. it is still armed (DMAARN.DMAARM_n = 1_b and DMAIRQ.DMAIF_n = 0_b). When the button is pushed the second time, the radio will trigger the DMA and the DMA will transfer the Data₆ byte (see Figure 8) to the RFD register. The DMA has now reached its transfer count and will be disarmed. The radio, however, will enter TX_UNDERFLOW state since it only received one byte from the DMA. The same scenario will occur when using VLEN = 011_b, but the DMA would transfer both Data₆ and Data₇ before being disarmed and causing the radio to enter TX_UNDERFLOW state.

Setting LEN < 256 when PKTLEN = 255 will cause the DMA to complete a transfer before the radio is done transmitting in cases where n ≥ LEN. This will make the radio enter TX_UNDERFLOW state.

5.2 Fixed Packet Length Mode

If the radio is configured for fixed packet length mode, as is the DMA, and $PkTLEN < LEN$ (or $PkTLEN + 2 < LEN$ in the case where $PkTCTRL1.APPEND_STATUS = 1_b$ and the radio is in RX mode), the DMA will expect more triggers than what the radio will provide. For the following examples, assume that *txBuffer* has the content as shown in Figure 8.

- TX mode:

The radio will be done transmitting a packet before the DMA transfer count is reached.

- o $LEN \text{ modulo } PkTLEN = 0$:

$LEN / PkTLEN = x$ (integer division) radio packets will be sent. The transfer count is reached after packet number x has been sent.

Note: The packets that are transmitted are not x equal packets, but x packets created from consecutive parts of txBuffer (see Figure 10).

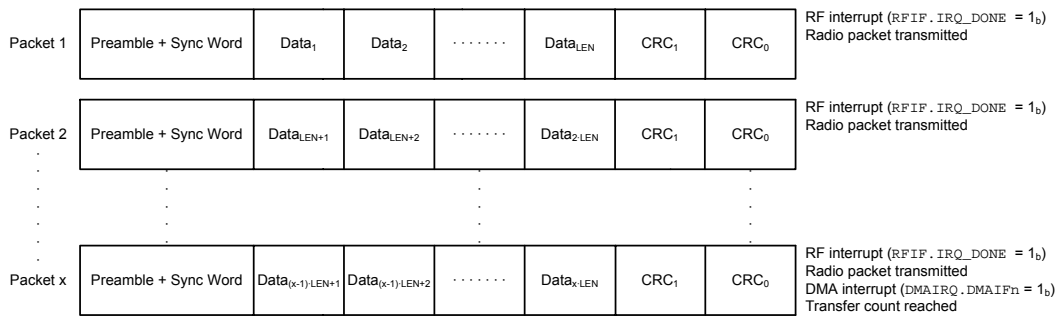

Figure 10. TX Mode; $PkTLEN < LEN$ and $(LEN \text{ modulo } PkTLEN) = 0$

- o $LEN \text{ modulo } PkTLEN = y$ ($y \neq 0$):

$LEN / n = x$ (integer division) radio packets will be sent before packet number $x + 1$ is tried transmitted. After y bytes of this packet have been transmitted, the radio will enter TX_UNDERFLOW state (see Example 2).

Example 2:

$LEN = 20$ and $PkTLEN = 7 \rightarrow$

$LEN / PkTLEN = 20 / 7 = 2$

$LEN \text{ modulo } PkTLEN = 20 \text{ modulo } 7 = 6$

Two 7 bytes long packets will be sent. For packet number three, only six bytes will be sent on the air before transfer count is reached and the radio enters TX_UNDERFLOW state.

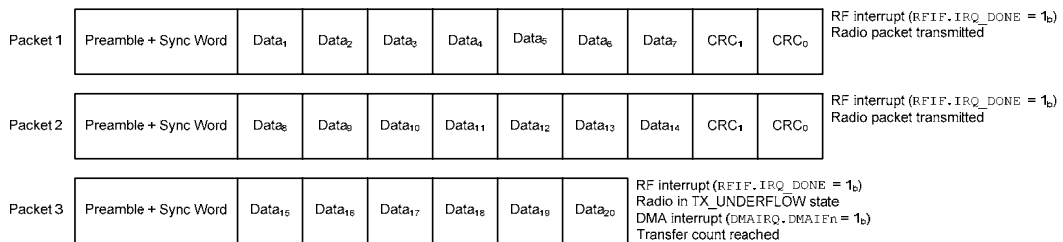

Figure 11. TX Mode; $PkTLEN < LEN$ and $(LEN \text{ modulo } PkTLEN) \neq 0$

- RX mode:

The radio will be done receiving a packet before the DMA transfer count is reached. If the radio is configured to enter IDLE state after a packet has been received ($MCSM1.RXOFF_MODE = 00_b$) and the application waits for the DMA interrupt before strobing RX again, the application will hang. If, however, the RF interrupt is used instead, or the radio is configured to stay in RX after a packet has been received ($MCSM1.RXOFF_MODE = 11_b$), the following will occur (assume that the transmitter is configured correctly and that the same packet is transmitted repeatedly):

- $PKTCTRL1.APPEND_STATUS = 0_b$:
 - $LEN \bmod PKTLEN = 0$:
 $LEN / PKTLEN = x$ (integer division) radio packets will be received and moved to rxBuffer. The transfer count is reached after packet number x has been received.

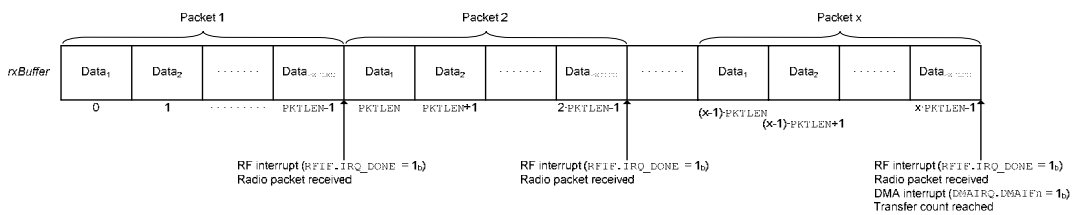

Figure 12. RX Mode; $PKTLEN < LEN$ and $(LEN \bmod PKTLEN) = 0$

- $LEN \bmod PKTLEN = y$ ($y \neq 0$):
 $LEN / n = x$ (integer division) radio packets will be received before packet number x + 1 is tried received. After y bytes of this packet have been received, the radio will enter `RX_OVERFLOW` state since transfer count is reached in the middle of a packet (see Figure 13).

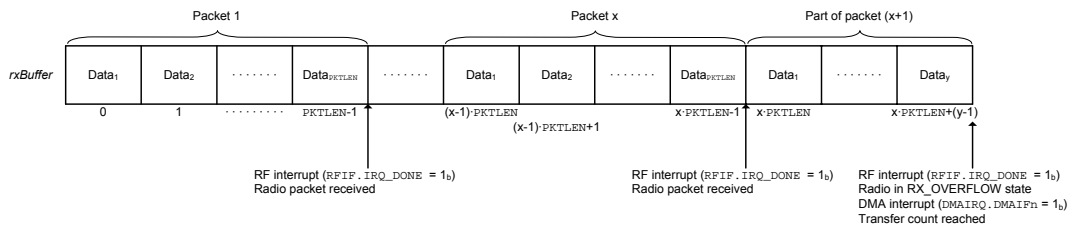

Figure 13. RX Mode; $PKTLEN < LEN$ and $(LEN \bmod PKTLEN) \neq 0$

- PKTCTRL1.APPEND_STATUS = 1_b:

Remember that when append status is enabled, LEN should be set to PKTLEN + 2.

- LEN = $x \cdot (\text{PKTLEN} + 2)$, where x is an integer:
 x radio packets will be received and moved to *rxBuffer*. The transfer count is reached after packet number x has been received. See Example 3 and Figure 14.

Example 3:

LEN = $x \cdot (\text{PKTLEN} + 2)$, PKTLEN = 3 and $x = 3$

LEN = 15

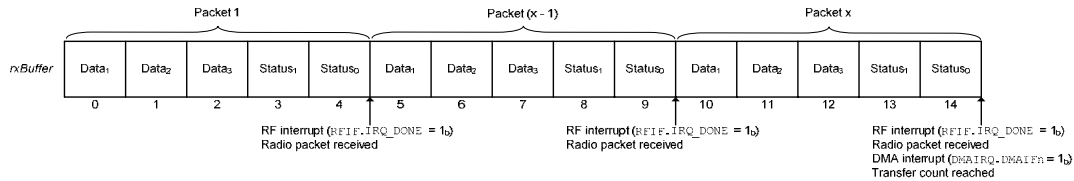

Figure 14. LEN = $x \cdot (\text{PKTLEN} + 2)$

- LEN = $x \cdot (\text{PKTLEN} + 2) - 1$ or LEN = $x \cdot (\text{PKTLEN} + 2) - 2$, where x is an integer:
 $x - 1$ radio packets will be received before packet number x is tried received. Transfer count will be reached either right before the first status byte is moved to *rxBuffer* or right after it has been moved. Neither RFIF.IRQ_DONE nor RFIF.IRQ_RX_OVF is being asserted, and the radio will be stuck in RX state (MARCSTATE = 0x0D), but it will not be able to receive any more data (see the errata notes [3] and [4] for more details). See Example 4 and Figure 15.

Example 4:

LEN = $x \cdot (\text{PKTLEN} + 2) - 1$, PKTLEN = 3 and $x = 3$

LEN = 14

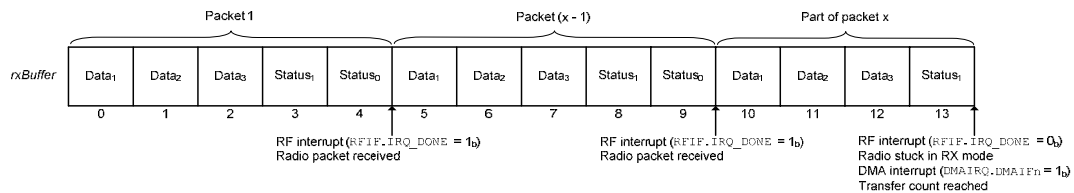

Figure 15. LEN = $x \cdot (\text{PKTLEN} + 2) - 1$

- LEN = $x \cdot (\text{PKTLEN} + 2) - y$, where $3 \leq y \leq (\text{PKTLEN} + 1)$ and x is an integer:
 $x - 1$ radio packets will be received before packet number x is tried received. When transfer count is reached, the radio will enter RX_OVERFLOW state. See Example 5 and Figure 16.

Example 5:

$$\text{LEN} = x \cdot (\text{PKTLEN} + 2) - y, \text{ PKTLEN} = 3, x = 3 \text{ and } y = 3$$

$$\text{LEN} = 12$$

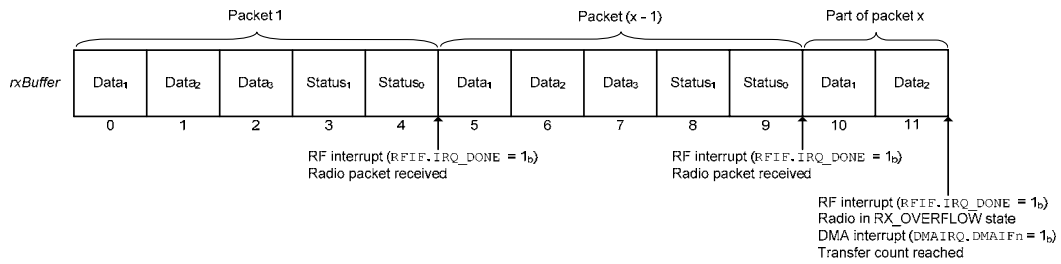

Figure 16. $\text{LEN} = x \cdot (\text{PKTLEN} + 2) - y$

If $\text{PKTLEN} > \text{LEN}$ (or $\text{PKTLEN} + 2 > \text{LEN}$ in the case where $\text{PKTCTRL1.APPEND_STATUS} = 1_b$ and the radio is in RX mode), the radio will enter TX_UNDERFLOW state from TX mode, and RX_OVERFLOW state from RX mode.

Note: In the case where the radio is in RX state and append status is enabled, the radio will get stuck in RX state if $\text{LEN} = \text{PKTLEN}$ or $\text{LEN} = \text{PKTLEN} + 1$ (see the errata notes [3] and [4] for more details).

6 References

- [1] CC1110Fx/CC1111Fx Low-Power SoC (System-on-Chip) with MCU, Memory, Sub-1 GHz RF Transceiver, and USB Controller ([cc1110f32.pdf](#))
- [2] CC2510Fx/CC2511Fx Low-Power SoC (System-on-Chip) with MCU, Memory, 2.4 GHz RF Transceiver, and USB Controller ([cc2510f32.pdf](#))
- [3] Errata Note CC1110Fx/CC1111Fx ([swrz022.pdf](#))
- [4] Errata Note CC2510Fx/CC2511Fx ([swrz014.pdf](#))

7 General Information

7.1 Document History

Revision	Date	Description/Changes
SWRA164A	2009.12.16	Additional info about the DMA and radio interrupts added to Section 3.
SWRA164	2007.12.17	Initial release.

IMPORTANT NOTICE

Texas Instruments Incorporated and its subsidiaries (TI) reserve the right to make corrections, modifications, enhancements, improvements, and other changes to its products and services at any time and to discontinue any product or service without notice. Customers should obtain the latest relevant information before placing orders and should verify that such information is current and complete. All products are sold subject to TI's terms and conditions of sale supplied at the time of order acknowledgment.

TI warrants performance of its hardware products to the specifications applicable at the time of sale in accordance with TI's standard warranty. Testing and other quality control techniques are used to the extent TI deems necessary to support this warranty. Except where mandated by government requirements, testing of all parameters of each product is not necessarily performed.

TI assumes no liability for applications assistance or customer product design. Customers are responsible for their products and applications using TI components. To minimize the risks associated with customer products and applications, customers should provide adequate design and operating safeguards.

TI does not warrant or represent that any license, either express or implied, is granted under any TI patent right, copyright, mask work right, or other TI intellectual property right relating to any combination, machine, or process in which TI products or services are used. Information published by TI regarding third-party products or services does not constitute a license from TI to use such products or services or a warranty or endorsement thereof. Use of such information may require a license from a third party under the patents or other intellectual property of the third party, or a license from TI under the patents or other intellectual property of TI.

Reproduction of TI information in TI data books or data sheets is permissible only if reproduction is without alteration and is accompanied by all associated warranties, conditions, limitations, and notices. Reproduction of this information with alteration is an unfair and deceptive business practice. TI is not responsible or liable for such altered documentation. Information of third parties may be subject to additional restrictions.

Resale of TI products or services with statements different from or beyond the parameters stated by TI for that product or service voids all express and any implied warranties for the associated TI product or service and is an unfair and deceptive business practice. TI is not responsible or liable for any such statements.

TI products are not authorized for use in safety-critical applications (such as life support) where a failure of the TI product would reasonably be expected to cause severe personal injury or death, unless officers of the parties have executed an agreement specifically governing such use. Buyers represent that they have all necessary expertise in the safety and regulatory ramifications of their applications, and acknowledge and agree that they are solely responsible for all legal, regulatory and safety-related requirements concerning their products and any use of TI products in such safety-critical applications, notwithstanding any applications-related information or support that may be provided by TI. Further, Buyers must fully indemnify TI and its representatives against any damages arising out of the use of TI products in such safety-critical applications.

TI products are neither designed nor intended for use in military/aerospace applications or environments unless the TI products are specifically designated by TI as military-grade or "enhanced plastic." Only products designated by TI as military-grade meet military specifications. Buyers acknowledge and agree that any such use of TI products which TI has not designated as military-grade is solely at the Buyer's risk, and that they are solely responsible for compliance with all legal and regulatory requirements in connection with such use.

TI products are neither designed nor intended for use in automotive applications or environments unless the specific TI products are designated by TI as compliant with ISO/TS 16949 requirements. Buyers acknowledge and agree that, if they use any non-designated products in automotive applications, TI will not be responsible for any failure to meet such requirements.

Following are URLs where you can obtain information on other Texas Instruments products and application solutions:

Products

Amplifiers	amplifier.ti.com
Data Converters	dataconverter.ti.com
DLP® Products	www.dlp.com
DSP	dsp.ti.com
Clocks and Timers	www.ti.com/clocks
Interface	interface.ti.com
Logic	logic.ti.com
Power Mgmt	power.ti.com
Microcontrollers	microcontroller.ti.com
RFID	www.ti-rfid.com
RF/IF and ZigBee® Solutions	www.ti.com/lprf

Applications

Audio	www.ti.com/audio
Automotive	www.ti.com/automotive
Broadband	www.ti.com/broadband
Digital Control	www.ti.com/digitalcontrol
Medical	www.ti.com/medical
Military	www.ti.com/military
Optical Networking	www.ti.com/opticalnetwork
Security	www.ti.com/security
Telephony	www.ti.com/telephony
Video & Imaging	www.ti.com/video
Wireless	www.ti.com/wireless

Mailing Address: Texas Instruments, Post Office Box 655303, Dallas, Texas 75265
Copyright © 2009, Texas Instruments Incorporated