

Logo2

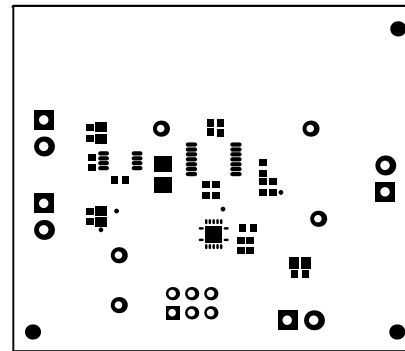

| | | | |
|----------------------------------|-----------------------|------------|--------------------------------|
| ALL ARTWORK VIEWED FROM TOP SIDE | BOARD #: TIPD192 | REV: E3 | SUN REV: Not In VersionControl |
| LAYER NAME = Top Overlay | TID #: TIPD192 | | |
| PLOT NAME = Top Overlay | GENERATED : 12/5/2016 | 2:23:48 PM | TEXAS INSTRUMENTS |

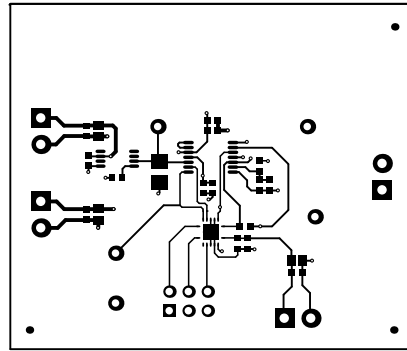

| | | | |
|----------------------------------|----------------------------------|-------------------|--------------------------------|
| ALL ARTWORK VIEWED FROM TOP SIDE | BOARD #: TIPD192 | REV: E3 | SUN REV: Not In VersionControl |
| LAYER NAME = Top Solder | TID #: TIPD192 | | |
| PLOT NAME = Top Solder Mask | GENERATED : 12/5/2016 2:23:49 PM | TEXAS INSTRUMENTS | |

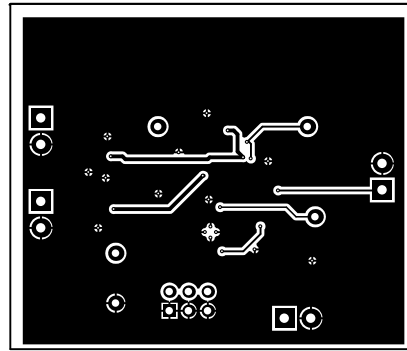

| | | | |
|----------------------------------|----------------------------------|-------------------|--------------------------------|
| ALL ARTWORK VIEWED FROM TOP SIDE | BOARD #: TIPD192 | REV: E3 | SUN REV: Not In VersionControl |
| LAYER NAME = Top Layer | TID #: TIPD192 | | |
| PLOT NAME = Top Layer | GENERATED : 12/5/2016 2:23:49 PM | TEXAS INSTRUMENTS | |



| | | | |
|----------------------------------|----------------------------------|-------------------|--------------------------------|
| ALL ARTWORK VIEWED FROM TOP SIDE | BOARD #: TIPD192 | REV: E3 | SUN REV: Not In VersionControl |
| LAYER NAME = Bottom Layer | TID #: TIPD192 | | |
| PLOT NAME = Bottom Layer | GENERATED : 12/5/2016 2:23:50 PM | TEXAS INSTRUMENTS | |

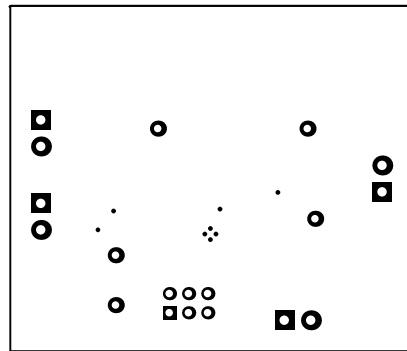

| | | | |
|----------------------------------|----------------------------------|-------------------|--------------------------------|
| ALL ARTWORK VIEWED FROM TOP SIDE | BOARD #: TIPD192 | REV: E3 | SUN REV: Not In VersionControl |
| LAYER NAME = Bottom Solder | TID #: TIPD192 | | |
| PLOT NAME = Bottom Solder Mask | GENERATED : 12/5/2016 2:23:51 PM | TEXAS INSTRUMENTS | |

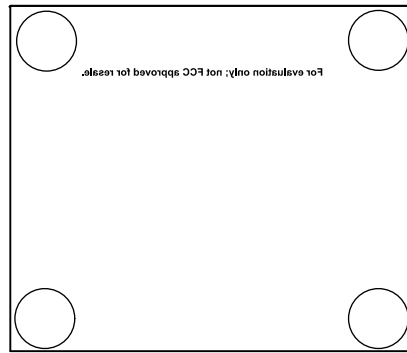

| | | | |
|----------------------------------|----------------------------------|-------------------|--------------------------------|
| ALL ARTWORK VIEWED FROM TOP SIDE | BOARD #: TIPD192 | REV: E3 | SUN REV: Not In VersionControl |
| LAYER NAME = Bottom Overlay | TID #: TIPD192 | | |
| PLOT NAME = Bottom Overlay | GENERATED : 12/5/2016 2:23:52 PM | TEXAS INSTRUMENTS | |

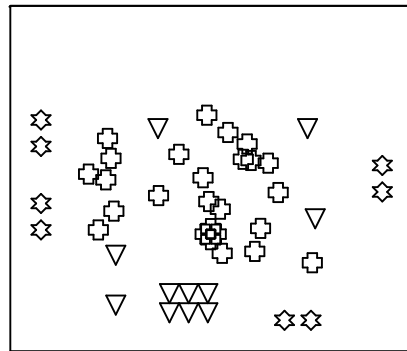

| Symbol | Quantity | Finished Hole Size | Plated | Hole Type |
|--------|----------|--------------------|--------|-----------|
| ⊙ | 26 | 16.00mil (0.254mm) | PTH | Round |
| ▽ | 11 | 40.00mil (1.016mm) | PTH | Round |
| ☆ | 8 | 50.00mil (1.270mm) | PTH | Round |
| | 45 Total | | | |

| | | | |
|----------------------------------|-----------------------|------------|--------------------------------|
| ALL ARTWORK VIEWED FROM TOP SIDE | BOARD #: TIPD192 | REV: E3 | SUN REV: Not In VersionControl |
| LAYER NAME = Drill Drawing | TID #: TIPD192 | | |
| PLOT NAME = Drill Drawing | GENERATED : 12/5/2016 | 2:23:53 PM | TEXAS INSTRUMENTS |

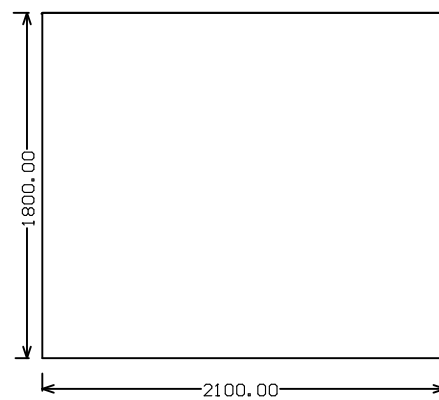

| | | | |
|----------------------------------|-----------------------|------------|--------------------------------|
| ALL ARTWORK VIEWED FROM TOP SIDE | BOARD #: TIPD192 | REV: E3 | SUN REV: Not In VersionControl |
| LAYER NAME = M2 Board Dimensions | TID #: TIPD192 | | |
| PLOT NAME = Board Dimensions | GENERATED : 12/5/2016 | 2:23:54 PM | TEXAS INSTRUMENTS |

IMPORTANT NOTICE FOR TI DESIGN INFORMATION AND RESOURCES

Texas Instruments Incorporated ("TI") technical, application or other design advice, services or information, including, but not limited to, reference designs and materials relating to evaluation modules, (collectively, "TI Resources") are intended to assist designers who are developing applications that incorporate TI products; by downloading, accessing or using any particular TI Resource in any way, you (individually or, if you are acting on behalf of a company, your company) agree to use it solely for this purpose and subject to the terms of this Notice.

TI's provision of TI Resources does not expand or otherwise alter TI's applicable published warranties or warranty disclaimers for TI products, and no additional obligations or liabilities arise from TI providing such TI Resources. TI reserves the right to make corrections, enhancements, improvements and other changes to its TI Resources.

You understand and agree that you remain responsible for using your independent analysis, evaluation and judgment in designing your applications and that you have full and exclusive responsibility to assure the safety of your applications and compliance of your applications (and of all TI products used in or for your applications) with all applicable regulations, laws and other applicable requirements. You represent that, with respect to your applications, you have all the necessary expertise to create and implement safeguards that (1) anticipate dangerous consequences of failures, (2) monitor failures and their consequences, and (3) lessen the likelihood of failures that might cause harm and take appropriate actions. You agree that prior to using or distributing any applications that include TI products, you will thoroughly test such applications and the functionality of such TI products as used in such applications. TI has not conducted any testing other than that specifically described in the published documentation for a particular TI Resource.

You are authorized to use, copy and modify any individual TI Resource only in connection with the development of applications that include the TI product(s) identified in such TI Resource. NO OTHER LICENSE, EXPRESS OR IMPLIED, BY ESTOPPEL OR OTHERWISE TO ANY OTHER TI INTELLECTUAL PROPERTY RIGHT, AND NO LICENSE TO ANY TECHNOLOGY OR INTELLECTUAL PROPERTY RIGHT OF TI OR ANY THIRD PARTY IS GRANTED HEREIN, including but not limited to any patent right, copyright, mask work right, or other intellectual property right relating to any combination, machine, or process in which TI products or services are used. Information regarding or referencing third-party products or services does not constitute a license to use such products or services, or a warranty or endorsement thereof. Use of TI Resources may require a license from a third party under the patents or other intellectual property of the third party, or a license from TI under the patents or other intellectual property of TI.

TI RESOURCES ARE PROVIDED "AS IS" AND WITH ALL FAULTS. TI DISCLAIMS ALL OTHER WARRANTIES OR REPRESENTATIONS, EXPRESS OR IMPLIED, REGARDING TI RESOURCES OR USE THEREOF, INCLUDING BUT NOT LIMITED TO ACCURACY OR COMPLETENESS, TITLE, ANY EPIDEMIC FAILURE WARRANTY AND ANY IMPLIED WARRANTIES OF MERCHANTABILITY, FITNESS FOR A PARTICULAR PURPOSE, AND NON-INFRINGEMENT OF ANY THIRD PARTY INTELLECTUAL PROPERTY RIGHTS.

TI SHALL NOT BE LIABLE FOR AND SHALL NOT DEFEND OR INDEMNIFY YOU AGAINST ANY CLAIM, INCLUDING BUT NOT LIMITED TO ANY INFRINGEMENT CLAIM THAT RELATES TO OR IS BASED ON ANY COMBINATION OF PRODUCTS EVEN IF DESCRIBED IN TI RESOURCES OR OTHERWISE. IN NO EVENT SHALL TI BE LIABLE FOR ANY ACTUAL, DIRECT, SPECIAL, COLLATERAL, INDIRECT, PUNITIVE, INCIDENTAL, CONSEQUENTIAL OR EXEMPLARY DAMAGES IN CONNECTION WITH OR ARISING OUT OF TI RESOURCES OR USE THEREOF, AND REGARDLESS OF WHETHER TI HAS BEEN ADVISED OF THE POSSIBILITY OF SUCH DAMAGES.

You agree to fully indemnify TI and its representatives against any damages, costs, losses, and/or liabilities arising out of your non-compliance with the terms and provisions of this Notice.

This Notice applies to TI Resources. Additional terms apply to the use and purchase of certain types of materials, TI products and services. These include; without limitation, TI's standard terms for semiconductor products (<http://www.ti.com/sc/docs/stdterms.htm>), [evaluation modules](#), and [samples](http://www.ti.com/sc/docs/sampterm.htm) (<http://www.ti.com/sc/docs/sampterm.htm>).

Mailing Address: Texas Instruments, Post Office Box 655303, Dallas, Texas 75265
Copyright © 2017, Texas Instruments Incorporated