

## CD74AC540, CDx4ACT54x, CDx4AC541 Octal Buffer/Line Drivers, 3-State

### 1 Features

- SCR-latchup-resistant CMOS process and circuit design
- Speed of bipolar FAST<sup>®</sup>/AS/S with significantly reduced power consumption
- Balanced propagation delays
- AC types feature 1.5V to 5.5V operation and balanced noise immunity at 30% of the supply.
- $\pm 24\text{mA}$  output drive current
  - Fanout to 15 FAST<sup>®</sup>ICs
  - Drives 50Ohm transmission lines

### 2 Description

The CD54/74AC540, -541, and CD54/74ACT540, -541 octal buffer/line drivers use the RCA ADVANCED

CMOS technology. The CD54/74AC/ACT540 are inverting 3-state buffers having two active-LOW output enables. The CD54/74AC/ACT541 are non-inverting 3-state buffers having two active-LOW output enables.

#### Device Information

PART NUMBER	PACKAGE <sup>(1)</sup>	PACKAGE SIZE <sup>(2)</sup>	BODY SIZE <sup>(3)</sup>
CD74AC540, CDx4ACT54x, CDx4AC541	DW (SOIC, 20)	12.8mm x 10.3mm	12.8mm x 7.5mm
	DB (SSOP, 20)	7.2mm x 7.8mm	7.2mm x 5.3mm
	N (PDIP, 20)	24.33mm x 9.4mm	24.33mm x 6.35mm

- (1) For all available packages, see [Section 10](#).
- (2) The package size (length x width) is a nominal value and includes pins, where applicable.
- (3) The body size (length x width) is a nominal value and does not include pins.

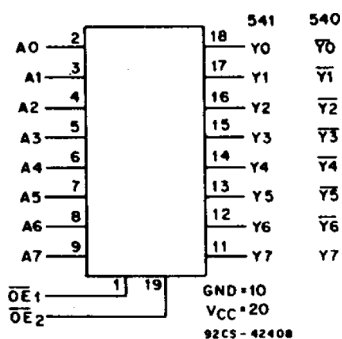

Functional Block Diagram

## Table of Contents

<b>1 Features</b> .....	1	6.2 Functional Block Diagram.....	11
<b>2 Description</b> .....	1	6.3 Device Functional Modes.....	11
<b>3 Pin Configuration and Functions</b> .....	3	<b>7 Application and Implementation</b> .....	12
<b>4 Specifications</b> .....	4	7.1 Power Supply Recommendations.....	12
4.1 Absolute Maximum Ratings.....	4	7.2 Layout.....	12
4.2 ESD Ratings.....	4	<b>8 Device and Documentation Support</b> .....	13
4.3 Recommended Operating Conditions.....	4	8.1 Documentation Support (Analog).....	13
4.4 Thermal Information.....	4	8.2 Receiving Notification of Documentation Updates... 13	
4.5 Electrical Characteristics, AC Series.....	5	8.3 Support Resources.....	13
4.6 Electrical Characteristics, ACT Series.....	6	8.4 Trademarks.....	13
4.7 Switching Characteristics, AC Series.....	7	8.5 Electrostatic Discharge Caution.....	13
4.8 Switching Characteristics, ACT Series.....	8	8.6 Glossary.....	13
<b>5 Parameter Measurement Information</b> .....	9	<b>9 Revision History</b> .....	13
<b>6 Detailed Description</b> .....	11	<b>10 Mechanical, Packaging, and Orderable Information</b> .....	14
6.1 Overview.....	11		

### 3 Pin Configuration and Functions

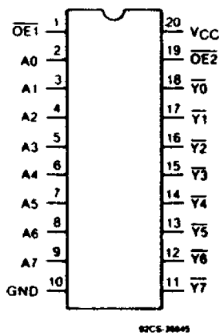

Figure 3-1. CDx4AC540, CDx4ACT540

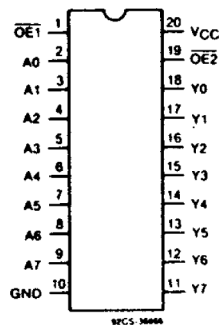

Figure 3-2. CDx4AC541, CDx4ACT541

Table 3-1. Pin Functions

PIN			
NO.	NAME	I/O1	DESCRIPTION
!MR	1	I	Master reset, active low
Q0	2	O	Output Q0
D0	3	I	Input D0
D1	4	I	Input D1
Q1	5	O	Output Q1
Q2	6	O	Output Q2
D2	7	I	Input D2
D3	8	I	Input D3
Q3	9	O	Output Q3
GND	10	-	Ground
CP	11	I	Clock, rising edge triggered
Q4	12	O	Output Q4
D4	13	I	Input D4
D5	14	I	Input D5
Q5	15	O	Output Q5
Q6	16	O	Output Q6
D6	17	I	Input D6
D7	18	I	Input D7
Q7	19	O	Output Q7
V <sub>CC</sub>	20	-	Supply

1. I = input, O = output, P = power, FB = feedback, GND = ground, N/A = not applicable

## 4 Specifications

### 4.1 Absolute Maximum Ratings

over operating free-air temperature range (unless otherwise noted)

		MIN	MAX	UNIT
V <sub>CC</sub>	Supply voltage	-0.5	6	V
I <sub>IK</sub>	Input diode current	(V <sub>I</sub> < -0.5 or V <sub>I</sub> > V <sub>CC</sub> + 0.5 V)		±20 mA
I <sub>OK</sub>	Output diode current	(V <sub>O</sub> < -0.5 or V <sub>O</sub> > V <sub>CC</sub> + 0.5 V)		±50 mA
I <sub>O</sub>	Output source or sink current per output PIN	(V <sub>O</sub> > -0.5 or V <sub>O</sub> < V <sub>CC</sub> + 0.5 V)		±50 mA
	V <sub>CC</sub> or ground current, I <sub>CC</sub> or I <sub>GND</sub> <sup>(1)</sup>		±100	mA
T <sub>stg</sub>	Storage temperature	-65	+150	°C

(1) For up to 4 outputs per device: add ±25 mA for each additional output.

### 4.2 ESD Ratings

		VALUE	UNIT
V <sub>(ESD)</sub>	Electrostatic discharge	Human-body model (HBM), per ANSI/ESDA/ JEDEC JS-001 <sup>1</sup>	±2000 V

(1) JEDEC document JEP155 states that 500-V HBM allows safe manufacturing with a standard ESD control process.

### 4.3 Recommended Operating Conditions

over operating free-air temperature range (unless otherwise noted)<sup>(1)</sup>

		MIN	MAX	UNIT
V <sub>CC</sub>	Supply voltage (For T <sub>A</sub> = full package-temperature range)			
	AC types	1.5	5.5	V
	ACT types	4.5	5.5	V
V <sub>I</sub> , V <sub>O</sub>	Input or output voltage	0	V <sub>CC</sub>	V
T <sub>A</sub>	Operating temperature	-55	+125	°C
dt/dv	Input rise and fall slew rate			
	at 1.5V to 3V (AC types)	0	50	ns/V
	at 3.6V to 5.5V (AC types)	0	20	ns/V
	at 4.5V to 5.5V (ACT types)	0	10	ns/V

(1) Unless otherwise specified, all voltages are referenced to ground.

### 4.4 Thermal Information

THERMAL METRIC <sup>(1)</sup>		CD74AC540, CDx4ACT54x, CDx4AC541		UNIT
		N (PDIP)	DW (SOIC)	
		20 PINS	20 PINS	
R <sub>θJA</sub>	Thermal Resistance	69	101.2	°C/W

(1) The package thermal impedance is calculated in accordance with JESD 51.



#### 4.5 Electrical Characteristics, AC Series

PARAMETER	TEST CONDITIONS		V <sub>CC</sub> (V)	(T <sub>A</sub> ) - °C						UNIT
				+25		-40 to +85		-55 to +125		
	V <sub>I</sub> (V)	I <sub>O</sub> (mA)		MIN	MAX	MIN	MAX	MIN	MAX	
V <sub>IH</sub> High-level input voltage			1.5	1.2	—	1.2	—	1.2	—	V
			3	2.1	—	2.1	—	2.1	—	
			5.5	3.85	—	3.85	—	3.85	—	
V <sub>IL</sub> Low-level input voltage			1.5	—	0.3	—	0.3	—	0.3	V
			3	—	0.9	—	0.9	—	0.9	
			5.5	—	1.65	—	1.65	—	1.65	
V <sub>OH</sub> High-level output voltage	V <sub>IH</sub> or V <sub>IL</sub> (1), (2)	-0.05	1.5	1.4	—	1.4	—	1.4	—	V
		-0.05	3	2.9	—	2.9	—	2.9	—	
		-0.05	4.5	4.4	—	4.4	—	4.4	—	
		-4	3	2.58	—	2.48	—	2.4	—	
		-24	4.5	3.94	—	3.8	—	3.7	—	
		-75	5.5	—	—	3.85	—	—	—	
		-50	5.5	—	—	—	—	3.85	—	
V <sub>OL</sub> Low-level output voltage	V <sub>IH</sub> or V <sub>IL</sub> (1), (2)	0.05	1.5	—	0.1	—	0.1	—	0.1	V
		0.05	3	—	0.1	—	0.1	—	0.1	
		0.05	4.5	—	0.1	—	0.1	—	0.1	
		12	3	—	0.36	—	0.44	—	0.5	
		24	4.5	—	0.36	—	0.44	—	0.5	
		75	5.5	—	—	—	1.65	—	—	
		50	5.5	—	—	—	—	—	1.65	
I <sub>I</sub> Input leakage current	V <sub>CC</sub> or GND		5.5	—	±0.1	—	±1	—	±1	μA
I <sub>OZ</sub> 3-state leakage current	V <sub>IH</sub> or V <sub>IL</sub> V <sub>O</sub> = V <sub>CC</sub> or GND		5.5	—	±0.5	—	±5	—	±10	μA
I <sub>CC</sub> Quiescent supply current, MSI	V <sub>CC</sub> or GND	0	5.5	—	8	—	80	—	160	μA

- (1) Test one output at a time for a 1-second maximum duration. Measurement is made by forcing current and measuring voltage to minimize power dissipation.  
 (2) Test verifies a minimum 50-ohm transmission-line-drive capability at +85°C, 75 ohms at +125°C.

## 4.6 Electrical Characteristics, ACT Series

PARAMETER	TEST CONDITIONS		V <sub>CC</sub> (V)	(T <sub>A</sub> ) - °C						UNIT	
				+25		-40 to +85		-55 to +125			
	V <sub>I</sub> (V)	I <sub>O</sub> (mA)		MIN	MAX	MIN	MAX	MIN	MAX		
V <sub>IH</sub>	High-level input voltage		4.5 to 5.5	2	—	2	—	2	—	V	
V <sub>IL</sub>	Low-level input voltage		4.5 to 5.5	—	0.8	—	0.8	—	0.8	V	
V <sub>OH</sub>	High-level output voltage	V <sub>IH</sub> or V <sub>IL</sub> (1), (2)	-0.05	4.5	4.4	—	4.4	—	4.4	—	V
			-24	4.5	3.94	—	3.8	—	3.7	—	
			-75	5.5	—	—	3.85	—	—	—	
			-50	5.5	—	—	—	—	3.85	—	
V <sub>OL</sub>	Low-level output voltage	V <sub>IH</sub> or V <sub>IL</sub> (1), (2)	0.05	4.5	—	0.1	—	0.1	—	0.1	V
			24	4.5	—	0.36	—	0.44	—	0.5	
			75	5.5	—	—	—	1.65	—	—	
			50	5.5	—	—	—	—	—	1.65	
I <sub>I</sub>	Input leakage current	V <sub>CC</sub> or GND	5.5	—	±0.1	—	±1	—	±1	μA	
I <sub>OZ</sub>	3-state leakage current	V <sub>IH</sub> or V <sub>IL</sub> V <sub>O</sub> = V <sub>CC</sub> or GND	5.5	—	±0.5	—	±5	—	±10	μA	
I <sub>CC</sub>	Quiescent supply current, MSI	V <sub>CC</sub> or GND	0	5.5	—	8	—	80	—	160	μA
	Additional quiescent supply current per input pin	V <sub>CC</sub> -2.1	4.5 to 5.5	—	2.4	—	28	—	3	mA	
ΔI <sub>CC</sub>	TTL inputs high 1 unit load										

- (1) Test one output at a time for a 1-second maximum duration. Measurement is made by forcing current and measuring voltage to minimize power dissipation.
- (2) Test verifies a minimum 50-ohm transmission-line-drive capability at +85°C, 75 ohms at +125°C.

**Table 4-1. Act Input Loading Table**

INPUT	UNIT LOAD <sup>(2)</sup>	
	540	541
DATA	1.42	0.5
OE1, OE2	1.3	1.3



### 4.7 Switching Characteristics, AC Series

$t_r, t_f = 3\text{ns}$ ,  $C_L = 50\text{pF}$  (See Section 5)

PARAMETER	$V_{CC}$ (V)	$(T_A) - ^\circ\text{C}$				UNIT
		-40 to +85		-55 to +125		
		MIN	MAX	MIN	MAX	
Propagation Delays:						
Data to Output						
AC540						
$t_{PLH}$	1.5	—	77	—	85	ns
$t_{PHL}$	3.3*	2.4	8.6	2.4	9.5	
	5†	1.8	6.2	1.7	6.8	
AC541						
$t_{PLH}$	1.5	—	89	—	98	ns
$t_{PHL}$	3.3	2.8	9.9	2.7	10.9	
	5	2.1	7.1	2	7.8	
Enable, to Output to Output						
$t_{PZL}$	1.5	—	136	—	150	ns
$t_{PZH}$	3.3	4.6	16.4	4.5	18	
	5	3.1	10.9	3	12	
Disable to Output to Output						
$t_{PLZ}$	1.5	—	136	—	150	ns
$t_{PHZ}$	3.3	3.9	13.6	3.8	15	
	5	3.1	10.9	3	12	
$C_{PD} \ddagger$	Power Dissipation Capacitance	AC540	—	60 Typ.	60 Typ.	pF
		AC541	—	60 Typ.	60 Typ.	
$V_{OHV}$	Min. (Valley) $V_{OH}$	During Switching of Other Outputs (Output Under Test Not Switching)	5	4 Typ. @ 25°C		V
$V_{OLP}$	Max. (Peak) $V_{OL}$	During Switching of Other Outputs (Output Under Test Not Switching)	5	1 Typ. @ 25°C		V
$C_I$	Input Capacitance		—	10	10	pF
$C_O$	3-State Output Capacitance		—	15	15	pF

## 4.8 Switching Characteristics, ACT Series

$t_r, t_f = 3\text{ns}$ ,  $C_L = 50\text{pF}$  (See Section 5)

PARAMETER		$V_{CC}$ (V)	$(T_A) - ^\circ\text{C}$				UNIT
			-40 to +85		-55 to =125		
			MIN	MAX	MIN	MAX	
$t_{PLH}$ $t_{PHL}$ $t_{PZL}$ $t_{PZH}$ $t_{PLZ}$ $t_{PHZ}$	Propagation Delays:						
	Data to Output: ACT540	5 <sup>(1)</sup>	1.9	6.5	1.8	7.2	ns
	ACT541	5 <sup>(1)</sup>	2.1	7.5	2.1	8.2	ns
	Enable to Output	5	5	3.5	12.2	3.4	ns
	Disable to Output	5	3.5	12.2	3.4	13.4	ns
$C_{PD}$ <small>CPD is used to determine the dynamic power consumption, per channel.</small>	Power Dissipation Capacitance ACT540/ ACT541	—	60 Typ.		60 Typ.		pF
$V_{OHV}$	Min. (Valley) $V_{OH}$ During Switching of Other Outputs (Output Under Test Not Switching)	5	4 Typ. @ 25°C				V
$V_{OLP}$	Max. (Peak) $V_{OL}$ During Switching of Other Outputs (Output Under Test Not Switching)	5	1 Typ. @ 25°C				V
$C_I$	Input Capacitance	—	—	10	—	10	pF
$C_O$	3-State Output Capacitance	—	—	15	—	15	pF

- (1) 5V: min. is @5.5 V  
 (2)  $C_{PD}$  is used to determine the dynamic power consumption, per channel.



## 5 Parameter Measurement Information

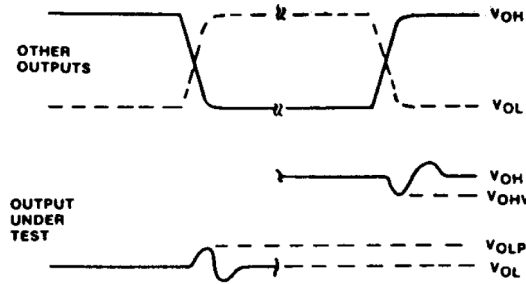

**NOTES:**

1.  $V_{OHV}$  AND  $V_{OLP}$  ARE MEASURED WITH RESPECT TO A GROUND REFERENCE NEAR THE OUTPUT UNDER TEST.
2. INPUT PULSES HAVE THE FOLLOWING CHARACTERISTICS:  
 $PRR \leq 1$  MHz,  $t_r = 3$  ns,  $t_f = 3$  ns, SKEW 1 ns.
3. R.F. FIXTURE WITH 700-MHz DESIGN RULES REQUIRED. IC SHOULD BE SOLDERED INTO TEST BOARD AND BYPASSED WITH  $0.1 \mu F$  CAPACITOR. SCOPE AND PROBES REQUIRE 700-MHz BANDWIDTH.

92CS-42406

- A.  $V_{OHV}$  AND  $V_{OLP}$  ARE MEASURED WITH RESPECT TO A GROUND REFERENCE NEAR THE OUTPUT UNDER TEST,
- B. INPUT PULSES HAVE THE FOLLOWING CHARACTERISTICS:  $PRR \leq 1$  MHz,  $t_r = 3$  ns,  $t_f = 3$  ns, SKEW 1 ns.
- C. R.F. FIXTURE WITH 700-MHz DESIGN RULES REQUIRED. IC SHOULD BE SOLDERED INTO TEST BOARD AND BYPASSED WITH  $0.1 \mu F$  CAPACITOR. SCOPE AND PROBES REQUIRE 700-MHz BANDWIDTH.
- D. 92CS-42406

Figure 5-1. Simultaneous Switching Transient Waveforms.

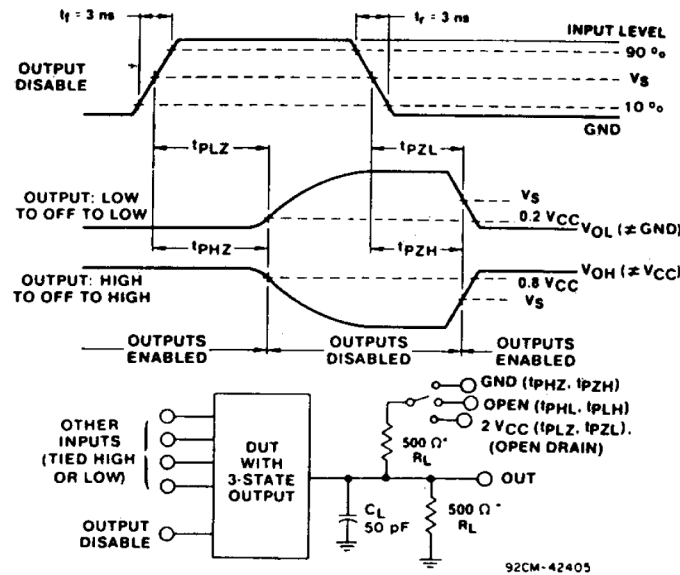

\*FOR AC SERIES ONLY: WHEN  $V_{CC} = 1.5$  V,  $R_L = 1$  k $\Omega$

Figure 5-2. Three-state Propagation Delay Waveforms and Test Circuit.

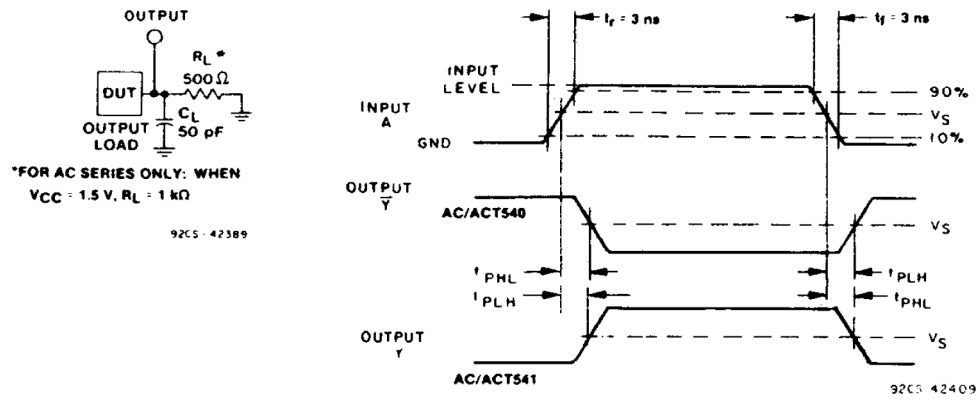

Figure 5-3. Propagation Delay Times and Test Circuit.

	CD54/74AC	CD54/74ACT
Input Level	$V_{CC}$	3 V
input Switching Voltage, $V_S$	$0.5 V_{CC}$	1.5 V
Output Switching Voltage, $V_S$	$0.5 V_{CC}$	$0.5 V_{CC}$

## 6 Detailed Description

### 6.1 Overview

The CD74AC540, -541, and CD74ACT540, -541 are supplied in 20-lead dual-in-line plastic packages (E suffix) and in 20-lead dual-in-line small-outline plastic packages (M suffix). Both package types are operable over the following temperature ranges: Industrial (–40 to +85°C) and Extended Industrial/Military (–55 to +125°C).

The CD54AC540, -541, and CD54ACT540, -541, available in chip form (H suffix), are operable over the –55 to +125°C temperature range.

### 6.2 Functional Block Diagram

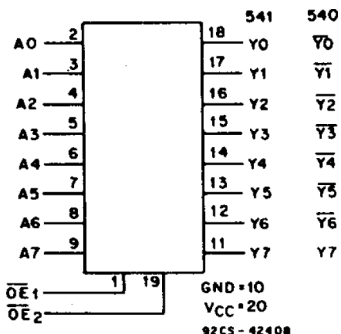

### 6.3 Device Functional Modes

Table 6-1. Truth Table

CD54/74AC/ACT540		
INPUTS		OUTPUTS
$\overline{OE1}, OE1$	A	Y
L	L	H
L	H	L
H	X	Z

Table 6-2. Truth Table

CD54/74AC/ACT541		
INPUTS		OUTPUTS
$\overline{OE1}, \overline{OE2}$	A	Y
L	L	L
L	H	H
H	X	Z

## 7 Application and Implementation

---

### Note

Information in the following applications sections is not part of the TI component specification, and TI does not warrant its accuracy or completeness. TI's customers are responsible for determining suitability of components for their purposes, as well as validating and testing their design implementation to confirm system functionality.

---

### 7.1 Power Supply Recommendations

The power supply can be any voltage between the min and max supply voltage rating located in [Section 4.3](#).

Each  $V_{CC}$  terminal should have a good bypass capacitor to prevent power disturbance. For devices with a single supply, TI recommends 0.1  $\mu\text{F}$  and if there are multiple  $V_{CC}$  terminals, then TI recommends .01  $\mu\text{F}$  or .022  $\mu\text{F}$  for each power terminal. It is okay to parallel multiple bypass capacitors to reject different frequencies of noise. A 0.1  $\mu\text{F}$  and 1  $\mu\text{F}$  are commonly used in parallel. The bypass capacitor should be installed as close to the power terminal as possible for best results.

### 7.2 Layout

#### 7.2.1 Layout Guidelines

When using multiple bit logic devices inputs should not ever float. In many cases, functions or parts of functions of digital logic devices are unused, for example, when only two inputs of a triple-input AND gate are used or only three of the four buffer gates are used. Such input pins should not be left unconnected because the undefined voltages at the outside connections result in undefined operational states. Specified below are the rules that must be observed under all circumstances. All unused inputs of digital logic devices must be connected to a high or low bias to prevent them from floating. The logic level that should be applied to any particular unused input depends on the function of the device. Generally they will be tied to GND or  $V_{CC}$  whichever make more sense or is more convenient. Floating outputs is generally acceptable, unless the part is a transceiver. If the transceiver has an output enable pin it will disable the outputs section of the part when asserted. This will not disable the input section of the I.O's so they also cannot float when disabled.

## 8 Device and Documentation Support

### 8.1 Documentation Support (Analog)

#### 8.1.1 Related Documentation

The table below lists quick access links. Categories include technical documents, support and community resources, tools and software, and quick access to sample or buy.

**Table 8-1. Related Links**

PARTS	PRODUCT FOLDER	SAMPLE & BUY	TECHNICAL DOCUMENTS	TOOLS & SOFTWARE	SUPPORT & COMMUNITY
CD74AC540	<a href="#">Click here</a>	<a href="#">Click here</a>	<a href="#">Click here</a>	<a href="#">Click here</a>	<a href="#">Click here</a>
CD54AC541	<a href="#">Click here</a>	<a href="#">Click here</a>	<a href="#">Click here</a>	<a href="#">Click here</a>	<a href="#">Click here</a>
CD74AC541	<a href="#">Click here</a>	<a href="#">Click here</a>	<a href="#">Click here</a>	<a href="#">Click here</a>	<a href="#">Click here</a>
CD54ACT540	<a href="#">Click here</a>	<a href="#">Click here</a>	<a href="#">Click here</a>	<a href="#">Click here</a>	<a href="#">Click here</a>
CD74ACT540	<a href="#">Click here</a>	<a href="#">Click here</a>	<a href="#">Click here</a>	<a href="#">Click here</a>	<a href="#">Click here</a>
CD54ACT541	<a href="#">Click here</a>	<a href="#">Click here</a>	<a href="#">Click here</a>	<a href="#">Click here</a>	<a href="#">Click here</a>
CD74ACT541	<a href="#">Click here</a>	<a href="#">Click here</a>	<a href="#">Click here</a>	<a href="#">Click here</a>	<a href="#">Click here</a>

### 8.2 Receiving Notification of Documentation Updates

To receive notification of documentation updates, navigate to the device product folder on [ti.com](#). Click on *Notifications* to register and receive a weekly digest of any product information that has changed. For change details, review the revision history included in any revised document.

### 8.3 Support Resources

[TI E2E™ support forums](#) are an engineer's go-to source for fast, verified answers and design help — straight from the experts. Search existing answers or ask your own question to get the quick design help you need.

Linked content is provided "AS IS" by the respective contributors. They do not constitute TI specifications and do not necessarily reflect TI's views; see TI's [Terms of Use](#).

### 8.4 Trademarks

TI E2E™ is a trademark of Texas Instruments. All trademarks are the property of their respective owners.

### 8.5 Electrostatic Discharge Caution



This integrated circuit can be damaged by ESD. Texas Instruments recommends that all integrated circuits be handled with appropriate precautions. Failure to observe proper handling and installation procedures can cause damage.

ESD damage can range from subtle performance degradation to complete device failure. Precision integrated circuits may be more susceptible to damage because very small parametric changes could cause the device not to meet its published specifications.

### 8.6 Glossary

[TI Glossary](#) This glossary lists and explains terms, acronyms, and definitions.

## 9 Revision History

NOTE: Page numbers for previous revisions may differ from page numbers in the current version.

Changes from Revision A (December 1998) to Revision B (May 2024)	Page
• Added <i>Device Information</i> table, <i>Pin Functions</i> table, <i>ESD Ratings</i> table, <i>Thermal Information</i> table, <i>Device Functional Modes</i> , <i>Application and Implementation</i> section, <i>Device and Documentation Support</i> section, and <i>Mechanical, Packaging, and Orderable Information</i> section .....	1
• Updated $\theta_{JA}$ value: DW = 58 to 101.2, all values in °C/W .....	4

## 10 Mechanical, Packaging, and Orderable Information

The following pages include mechanical, packaging, and orderable information. This information is the most current data available for the designated devices. This data is subject to change without notice and revision of this document. For browser-based versions of this data sheet, refer to the left-hand navigation.

J (R-GDIP-T\*\*)

14 LEADS SHOWN

CERAMIC DUAL IN-LINE PACKAGE



DIM \ PINS **	14	16	18	20
A	0.300 (7,62) BSC	0.300 (7,62) BSC	0.300 (7,62) BSC	0.300 (7,62) BSC
B MAX	0.785 (19,94)	.840 (21,34)	0.960 (24,38)	1.060 (26,92)
B MIN	—	—	—	—
C MAX	0.300 (7,62)	0.300 (7,62)	0.310 (7,87)	0.300 (7,62)
C MIN	0.245 (6,22)	0.245 (6,22)	0.220 (5,59)	0.245 (6,22)



4040083/F 03/03

- NOTES:
- All linear dimensions are in inches (millimeters).
  - This drawing is subject to change without notice.
  - This package is hermetically sealed with a ceramic lid using glass frit.
  - Index point is provided on cap for terminal identification only on press ceramic glass frit seal only.
  - Falls within MIL STD 1835 GDIP1-T14, GDIP1-T16, GDIP1-T18 and GDIP1-T20.

N (R-PDIP-T\*\*)

PLASTIC DUAL-IN-LINE PACKAGE

16 PINS SHOWN



- NOTES:
- A. All linear dimensions are in inches (millimeters).
  - B. This drawing is subject to change without notice.
  - Falls within JEDEC MS-001, except 18 and 20 pin minimum body length (Dim A).
  - The 20 pin end lead shoulder width is a vendor option, either half or full width.



# DW0020A



# PACKAGE OUTLINE

## SOIC - 2.65 mm max height

SOIC



4220724/A 05/2016

# EXAMPLE BOARD LAYOUT

DW0020A

SOIC - 2.65 mm max height

SOIC



LAND PATTERN EXAMPLE  
SCALE:6X



SOLDER MASK DETAILS

4220724/A 05/2016

NOTES: (continued)

- 6. Publication IPC-7351 may have alternate designs.
- 7. Solder mask tolerances between and around signal pads can vary based on board fabrication site.

# EXAMPLE STENCIL DESIGN

DW0020A

SOIC - 2.65 mm max height

SOIC



SOLDER PASTE EXAMPLE  
BASED ON 0.125 mm THICK STENCIL  
SCALE:6X

4220724/A 05/2016

NOTES: (continued)

8. Laser cutting apertures with trapezoidal walls and rounded corners may offer better paste release. IPC-7525 may have alternate design recommendations.
9. Board assembly site may have different recommendations for stencil design.

# DB0020A



# PACKAGE OUTLINE

## SSOP - 2 mm max height

SMALL OUTLINE PACKAGE



4214851/B 08/2019

### NOTES:

1. All linear dimensions are in millimeters. Any dimensions in parenthesis are for reference only. Dimensioning and tolerancing per ASME Y14.5M.
2. This drawing is subject to change without notice.
3. This dimension does not include mold flash, protrusions, or gate burrs. Mold flash, protrusions, or gate burrs shall not exceed 0.15 mm per side.
4. This dimension does not include interlead flash. Interlead flash shall not exceed 0.25 mm per side.
5. Reference JEDEC registration MO-150.

# EXAMPLE BOARD LAYOUT

DB0020A

SSOP - 2 mm max height

SMALL OUTLINE PACKAGE



LAND PATTERN EXAMPLE  
EXPOSED METAL SHOWN  
SCALE: 10X



4214851/B 08/2019

NOTES: (continued)

- 6. Publication IPC-7351 may have alternate designs.
- 7. Solder mask tolerances between and around signal pads can vary based on board fabrication site.

# EXAMPLE STENCIL DESIGN

DB0020A

SSOP - 2 mm max height

SMALL OUTLINE PACKAGE



SOLDER PASTE EXAMPLE  
BASED ON 0.125 mm THICK STENCIL  
SCALE: 10X

4214851/B 08/2019

NOTES: (continued)

8. Laser cutting apertures with trapezoidal walls and rounded corners may offer better paste release. IPC-7525 may have alternate design recommendations.
9. Board assembly site may have different recommendations for stencil design.

## IMPORTANT NOTICE AND DISCLAIMER

TI PROVIDES TECHNICAL AND RELIABILITY DATA (INCLUDING DATA SHEETS), DESIGN RESOURCES (INCLUDING REFERENCE DESIGNS), APPLICATION OR OTHER DESIGN ADVICE, WEB TOOLS, SAFETY INFORMATION, AND OTHER RESOURCES "AS IS" AND WITH ALL FAULTS, AND DISCLAIMS ALL WARRANTIES, EXPRESS AND IMPLIED, INCLUDING WITHOUT LIMITATION ANY IMPLIED WARRANTIES OF MERCHANTABILITY, FITNESS FOR A PARTICULAR PURPOSE OR NON-INFRINGEMENT OF THIRD PARTY INTELLECTUAL PROPERTY RIGHTS.

These resources are intended for skilled developers designing with TI products. You are solely responsible for (1) selecting the appropriate TI products for your application, (2) designing, validating and testing your application, and (3) ensuring your application meets applicable standards, and any other safety, security, regulatory or other requirements.

These resources are subject to change without notice. TI grants you permission to use these resources only for development of an application that uses the TI products described in the resource. Other reproduction and display of these resources is prohibited. No license is granted to any other TI intellectual property right or to any third party intellectual property right. TI disclaims responsibility for, and you will fully indemnify TI and its representatives against, any claims, damages, costs, losses, and liabilities arising out of your use of these resources.

TI's products are provided subject to [TI's Terms of Sale](#) or other applicable terms available either on [ti.com](https://www.ti.com) or provided in conjunction with such TI products. TI's provision of these resources does not expand or otherwise alter TI's applicable warranties or warranty disclaimers for TI products.

TI objects to and rejects any additional or different terms you may have proposed.

Mailing Address: Texas Instruments, Post Office Box 655303, Dallas, Texas 75265  
Copyright © 2024, Texas Instruments Incorporated