

# CSD18512Q5B 40 V N-channel NexFET™ power MOSFET

## 1 Features

- Low  $R_{DS(on)}$
- Low thermal resistance
- Avalanche rated
- Logic level
- Pb-free terminal plating
- RoHS compliant
- Halogen-free
- SON 5 mm × 6 mm plastic package

## 2 Applications

- DC-DC conversion
- Secondary side synchronous rectifier
- Motor control

## 3 Description

This 40 V, 1.3 mΩ, 5 mm × 6 mm NexFET™ power MOSFET is designed to minimize losses in power conversion applications.

Top View

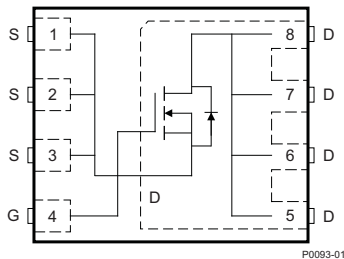

### Product Summary

$T_A = 25^\circ\text{C}$		TYPICAL VALUE		UNIT
$V_{DS}$	Drain to source voltage	40		V
$Q_g$	Gate charge total (10 V)	75		nC
$Q_{gd}$	Gate charge gate to drain	13.3		nC
$R_{DS(on)}$	Drain to source on resistance	$V_{GS} = 4.5\text{ V}$	1.8	mΩ
		$V_{GS} = 10\text{ V}$	1.3	mΩ
$V_{GS(th)}$	Threshold voltage	1.6		V

### Ordering Information<sup>(1)</sup>

DEVICE	QTY	MEDIA	PACKAGE	SHIP
CSD18512Q5B	2500	13-Inch Reel	SON 5 mm × 6 mm Plastic Package	Tape and Reel
CSD18512Q5BT	250	7-Inch Reel		

(1) For all available packages, see the orderable addendum at the end of the datasheet.

### Absolute Maximum Ratings

$T_A = 25^\circ\text{C}$		VALUE	UNIT
$V_{DS}$	Drain to source voltage	40	V
$V_{GS}$	Gate to source voltage	±20	V
$I_D$	Continuous drain current (package limited)	100	A
	Continuous drain current (silicon limited), $T_C = 25^\circ\text{C}$	211	
	Continuous drain current <sup>(1)</sup>	32	
$I_{DM}$	Pulsed drain current <sup>(2)</sup>	400	A
$P_D$	Power dissipation <sup>(1)</sup>	3.1	W
	Power dissipation, $T_C = 25^\circ\text{C}$	139	
$T_J, T_{stg}$	Operating Junction, Storage Temperature	-55 to 150	°C
$E_{AS}$	Avalanche energy, single pulse $I_D = 64\text{ A}, L = 0.1\text{ mH}, R_G = 25\ \Omega$	205	mJ

(1) Typical  $R_{\theta JA} = 40^\circ\text{C/W}$  on a 1 inch<sup>2</sup>, 2 oz. Cu pad on a 0.06 inch thick FR4 PCB.

(2) Max  $R_{\theta JC} = 0.9^\circ\text{C/W}$ , pulse duration  $\leq 100\ \mu\text{s}$ , duty cycle  $\leq 1\%$

$R_{DS(on)}$  vs  $V_{GS}$

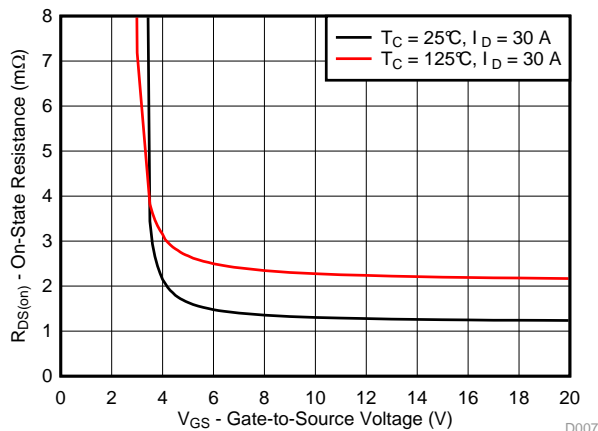

Gate Charge

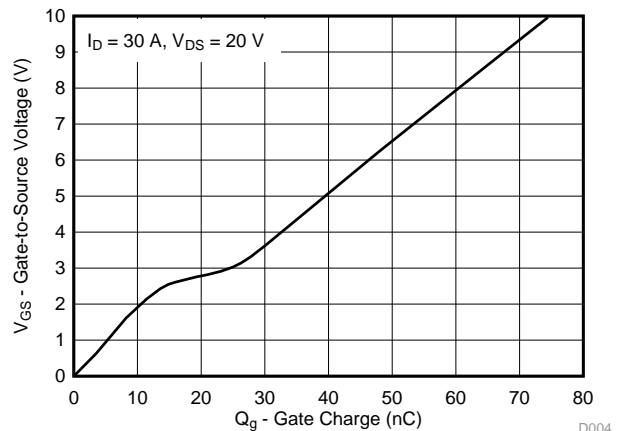

## Table of Contents

<b>1 Features</b> .....	<b>1</b>	6.1 Community Resources.....	<b>7</b>
<b>2 Applications</b> .....	<b>1</b>	6.2 Trademarks .....	<b>7</b>
<b>3 Description</b> .....	<b>1</b>	6.3 Electrostatic Discharge Caution .....	<b>7</b>
<b>4 Revision History</b> .....	<b>2</b>	6.4 Glossary .....	<b>7</b>
<b>5 Specifications</b> .....	<b>3</b>	<b>7 Mechanical, Packaging, and Orderable Information</b> .....	<b>8</b>
5.1 Electrical Characteristics.....	<b>3</b>	7.1 Q5B Package Dimensions .....	<b>8</b>
5.2 Thermal Information .....	<b>3</b>	7.2 Recommended PCB Pattern.....	<b>9</b>
5.3 Typical MOSFET Characteristics.....	<b>4</b>	7.3 Recommended Stencil Pattern .....	<b>9</b>
<b>6 Device and Documentation Support</b> .....	<b>7</b>	7.4 Q5B Tape and Reel Information .....	<b>10</b>

## 4 Revision History

Changes from Original (December 2016) to Revision A	Page
• Corrected the SOA in <a href="#">Figure 10</a> .....	<b>5</b>

## 5 Specifications

### 5.1 Electrical Characteristics

 $(T_A = 25^\circ\text{C}$  unless otherwise stated)

PARAMETER		TEST CONDITIONS	MIN	TYP	MAX	UNIT	
<b>STATIC CHARACTERISTICS</b>							
$V_{DSS}$	Drain to source voltage	$V_{GS} = 0\text{ V}, I_D = 250\ \mu\text{A}$	40			V	
$I_{DSS}$	Drain to source leakage current	$V_{GS} = 0\text{ V}, V_{DS} = 32\text{ V}$			1	$\mu\text{A}$	
$I_{GSS}$	Gate to source leakage current	$V_{DS} = 0\text{ V}, V_{GS} = 20\text{ V}$			100	nA	
$V_{GS(th)}$	Gate to source threshold voltage	$V_{DS} = V_{GS}, I_D = 250\ \mu\text{A}$	1.3	1.6	2.2	V	
$R_{DS(on)}$	Drain to source on resistance	$V_{GS} = 4.5\text{ V}, I_D = 30\text{ A}$		1.8	2.3	m $\Omega$	
		$V_{GS} = 10\text{ V}, I_D = 30\text{ A}$		1.3	1.6	m $\Omega$	
$g_{fs}$	Transconductance	$V_{DS} = 20\text{ V}, I_D = 30\text{ A}$		136		S	
<b>DYNAMIC CHARACTERISTICS</b>							
$C_{iss}$	Input capacitance	$V_{GS} = 0\text{ V}, V_{DS} = 20\text{ V}, f = 1\text{ MHz}$		5480	7120	pF	
$C_{oss}$	Output capacitance			537	699	pF	
$C_{rss}$	Reverse transfer capacitance			256	333	pF	
$R_G$	Series gate resistance			1.0	2.0	$\Omega$	
$Q_g$	Gate charge total (4.5 V)	$V_{DS} = 20\text{ V}, I_D = 30\text{ A}$		37	48	nC	
$Q_g$	Gate charge total (10 V)			75	98	nC	
$Q_{gd}$	Gate charge gate to drain			13.3		nC	
$Q_{gs}$	Gate charge gate to source			15.1		nC	
$Q_{g(th)}$	Gate charge at $V_{th}$			8.2		nC	
$Q_{oss}$	Output charge		$V_{DS} = 20\text{ V}, V_{GS} = 0\text{ V}$		23		nC
$t_{d(on)}$	Turn on delay time		$V_{DS} = 20\text{ V}, V_{GS} = 10\text{ V}, I_{DS} = 30\text{ A}, R_G = 0\ \Omega$		7		ns
$t_r$	Rise time			16		ns	
$t_{d(off)}$	Turn off delay time			31		ns	
$t_f$	Fall time			7		ns	
<b>DIODE CHARACTERISTICS</b>							
$V_{SD}$	Diode forward voltage	$I_{SD} = 30\text{ A}, V_{GS} = 0\text{ V}$		0.75	1.0	V	
$Q_{rr}$	Reverse recovery charge	$V_{DS} = 20\text{ V}, I_F = 30\text{ A}, di/dt = 300\text{ A}/\mu\text{s}$		22		nC	
$t_{rr}$	Reverse recovery time			17		ns	

### 5.2 Thermal Information

 $(T_A = 25^\circ\text{C}$  unless otherwise stated)

THERMAL METRIC		MIN	TYP	MAX	UNIT
$R_{\theta JC}$	Junction-to-case (top of package) thermal resistance <sup>(1)</sup>			0.9	$^\circ\text{C}/\text{W}$
$R_{\theta JA}$	Junction-to-ambient thermal resistance <sup>(1)(2)</sup>			50	$^\circ\text{C}/\text{W}$

- (1)  $R_{\theta JC}$  is determined with the device mounted on a 1 inch<sup>2</sup> (6.45 cm<sup>2</sup>), 2 oz. (0.071 mm thick) Cu pad on a 1.5 inch × 1.5 inch (3.81 cm × 3.81 cm), 0.06 inch (1.52 mm) thick FR4 PCB.  $R_{\theta JC}$  is specified by design, whereas  $R_{\theta JA}$  is determined by the user's board design.
- (2) Device mounted on FR4 material with 1 inch<sup>2</sup> (6.45 cm<sup>2</sup>), 2 oz. (0.071 mm thick) Cu.

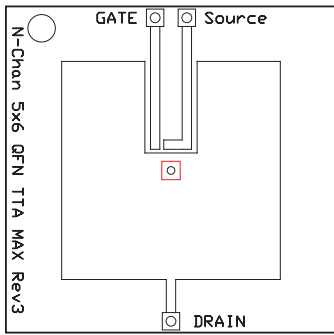

Max  $R_{\theta JA} = 50^{\circ}\text{C/W}$   
when mounted on  
1 inch<sup>2</sup> (6.45 cm<sup>2</sup>) of 2  
oz. (0.071 mm thick)  
Cu.

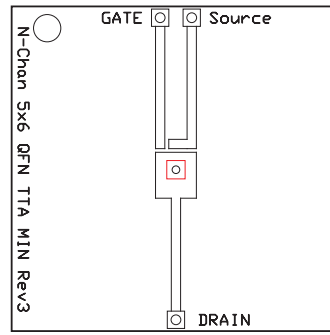

Max  $R_{\theta JA} = 125^{\circ}\text{C/W}$   
when mounted on a  
minimum pad area of 2  
oz. (0.071 mm thick)  
Cu.

### 5.3 Typical MOSFET Characteristics

$T_A = 25^{\circ}\text{C}$  (unless otherwise stated)

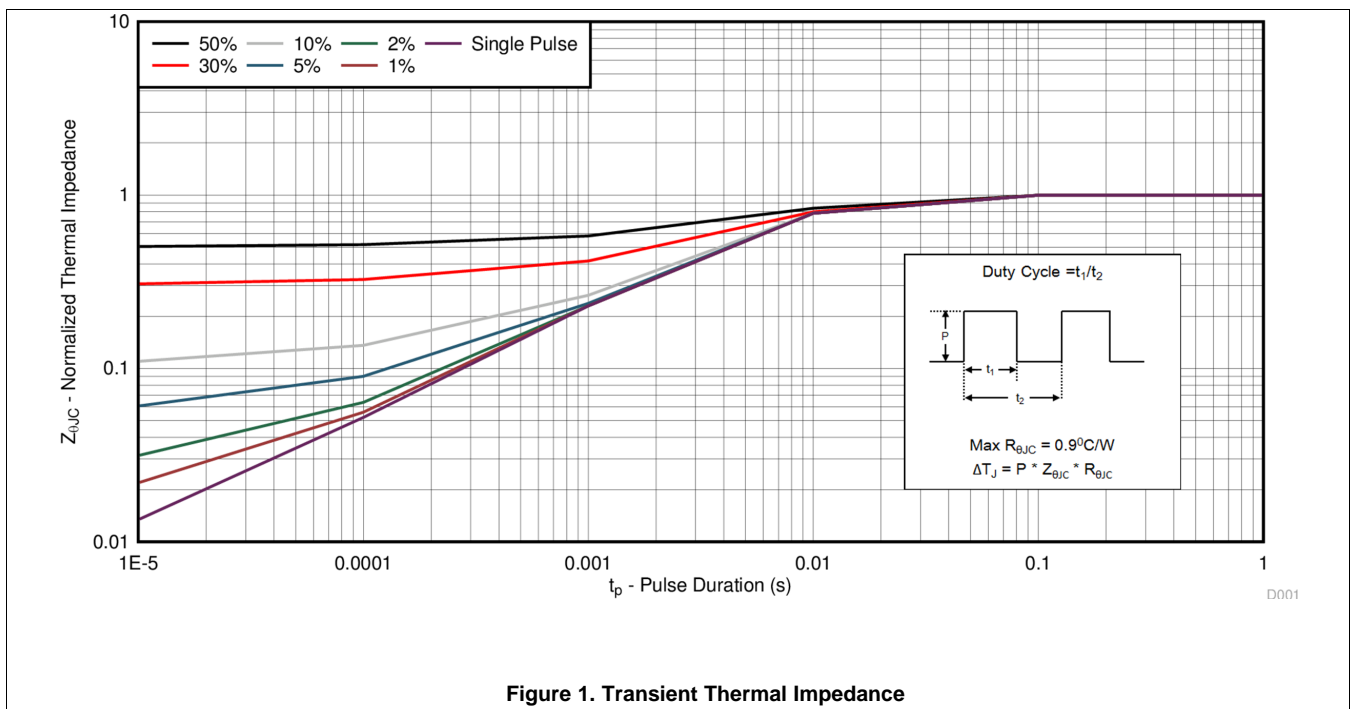

Typical MOSFET Characteristics (continued)

T<sub>A</sub> = 25°C (unless otherwise stated)

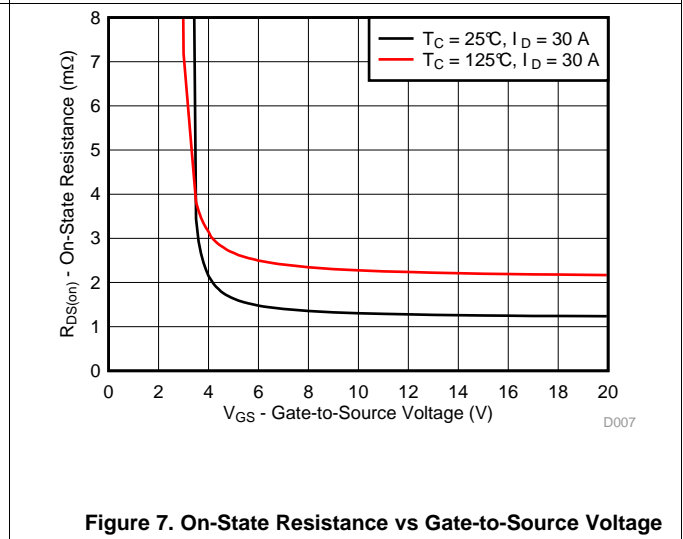
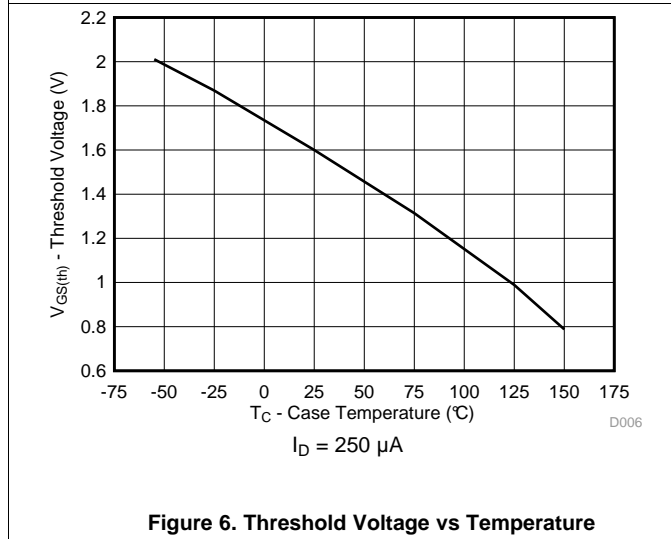
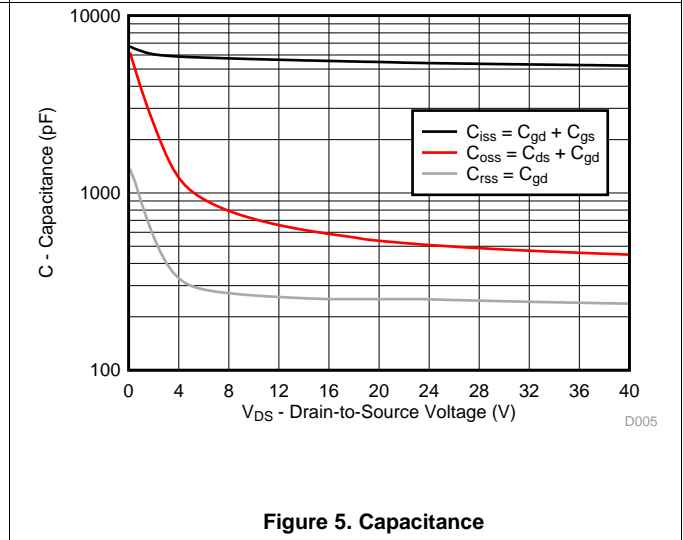
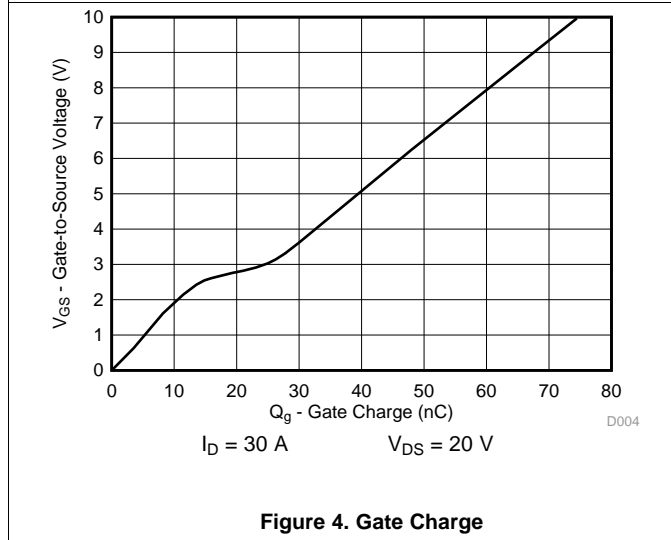
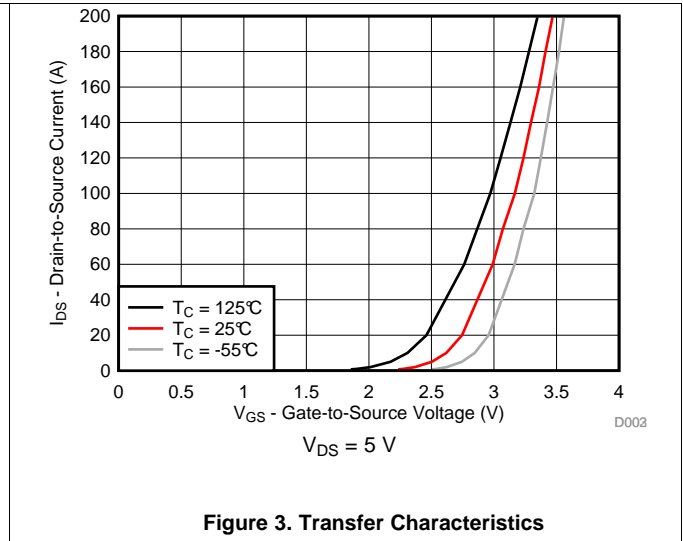
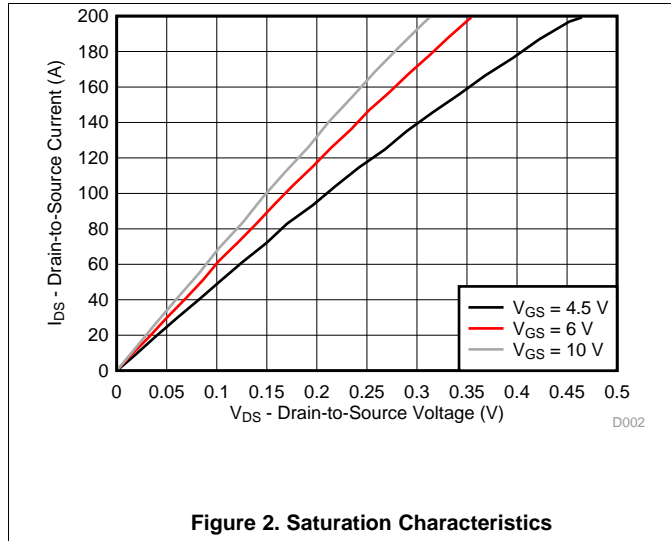

Typical MOSFET Characteristics (continued)

T<sub>A</sub> = 25°C (unless otherwise stated)

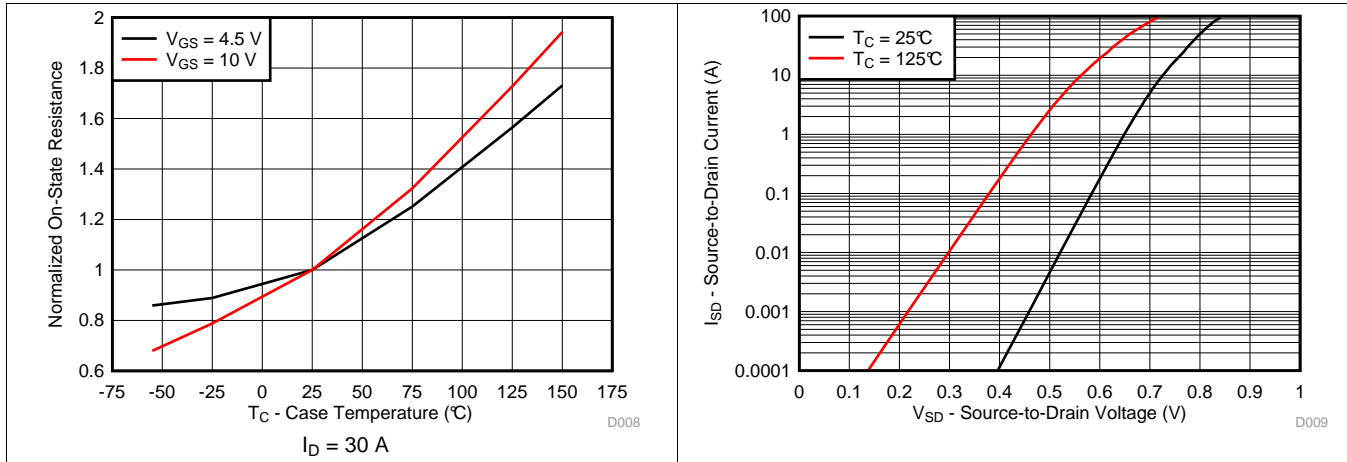

Figure 8. Normalized On-State Resistance vs Temperature

Figure 9. Typical Diode Forward Voltage

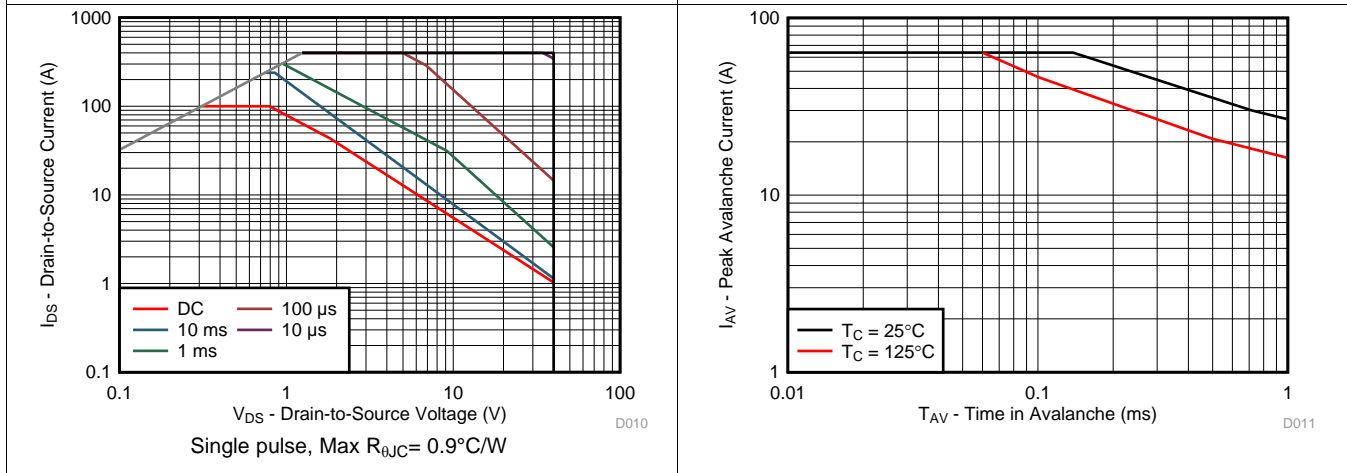

Figure 10. Maximum Safe Operating Area

Figure 11. Single Pulse Unclamped Inductive Switching

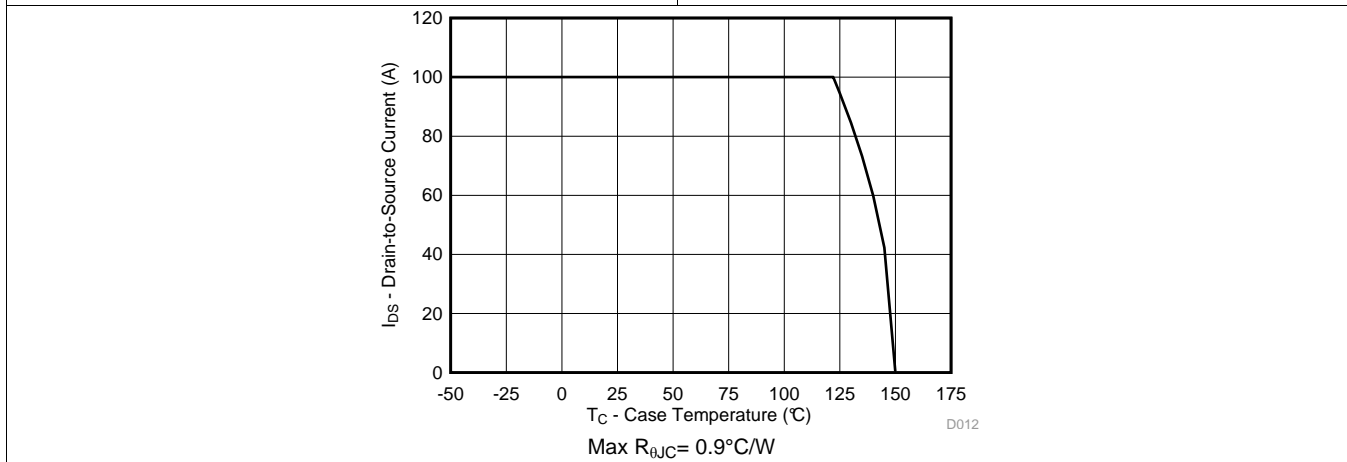

Figure 12. Maximum Drain Current vs Temperature

## 6 Device and Documentation Support

### 6.1 Community Resources

The following links connect to TI community resources. Linked contents are provided "AS IS" by the respective contributors. They do not constitute TI specifications and do not necessarily reflect TI's views; see TI's [Terms of Use](#).

**TI E2E™ Online Community** *TI's Engineer-to-Engineer (E2E) Community*. Created to foster collaboration among engineers. At [e2e.ti.com](http://e2e.ti.com), you can ask questions, share knowledge, explore ideas and help solve problems with fellow engineers.

**Design Support** *TI's Design Support* Quickly find helpful E2E forums along with design support tools and contact information for technical support.

### 6.2 Trademarks

NexFET, E2E are trademarks of Texas Instruments.  
All other trademarks are the property of their respective owners.

### 6.3 Electrostatic Discharge Caution



These devices have limited built-in ESD protection. The leads should be shorted together or the device placed in conductive foam during storage or handling to prevent electrostatic damage to the MOS gates.

### 6.4 Glossary

[SLYZ022](#) — *TI Glossary*.

This glossary lists and explains terms, acronyms, and definitions.

## 7 Mechanical, Packaging, and Orderable Information

### 7.1 Q5B Package Dimensions

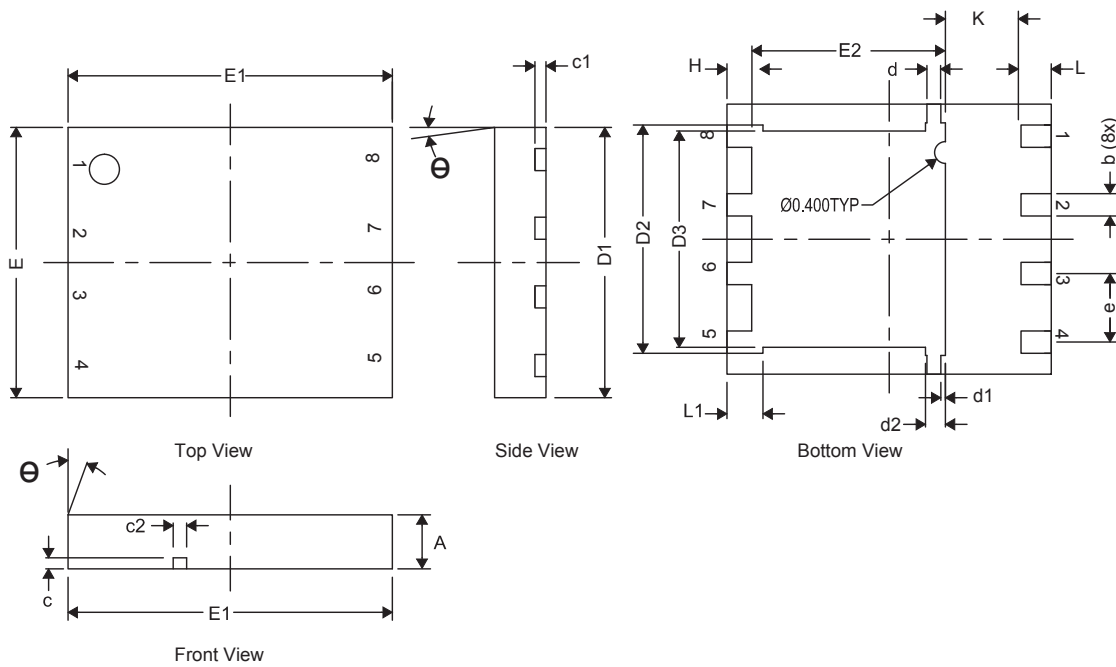

DIM	MILLIMETERS		
	MIN	NOM	MAX
A	0.80	1.00	1.05
b	0.36	0.41	0.46
c	0.15	0.20	0.25
c1	0.15	0.20	0.25
c2	0.20	0.25	0.30
D1	4.90	5.00	5.10
D2	4.12	4.22	4.32
D3	3.90	4.00	4.10
d	0.20	0.25	0.30
d1	0.085 TYP		
d2	0.319	0.369	0.419
E	4.90	5.00	5.10
E1	5.90	6.00	6.10
E2	3.48	3.58	3.68
e	1.27 TYP		
H	0.36	0.46	0.56
L	0.46	0.56	0.66
L1	0.57	0.67	0.77
θ	0°	-	-
K	1.40 TYP		



### 7.2 Recommended PCB Pattern

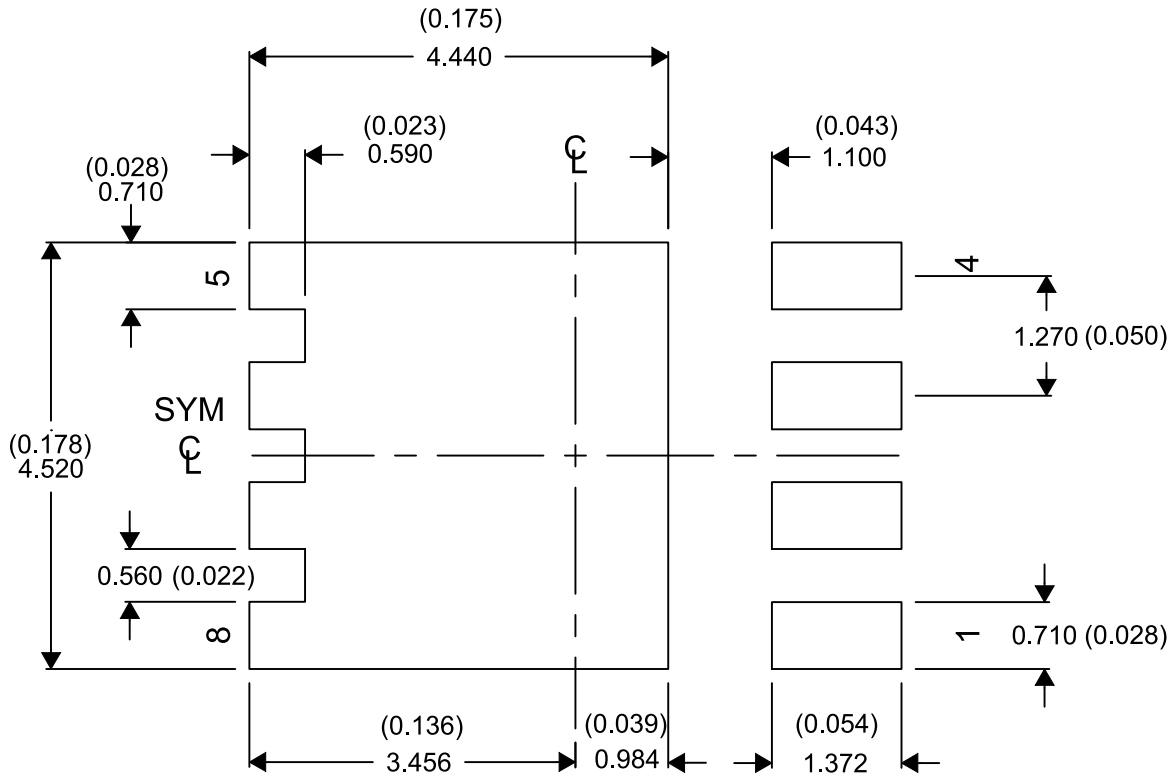

For recommended circuit layout for PCB designs, see application note [SLPA005 – Reducing Ringing Through PCB Layout Techniques](#).

### 7.3 Recommended Stencil Pattern

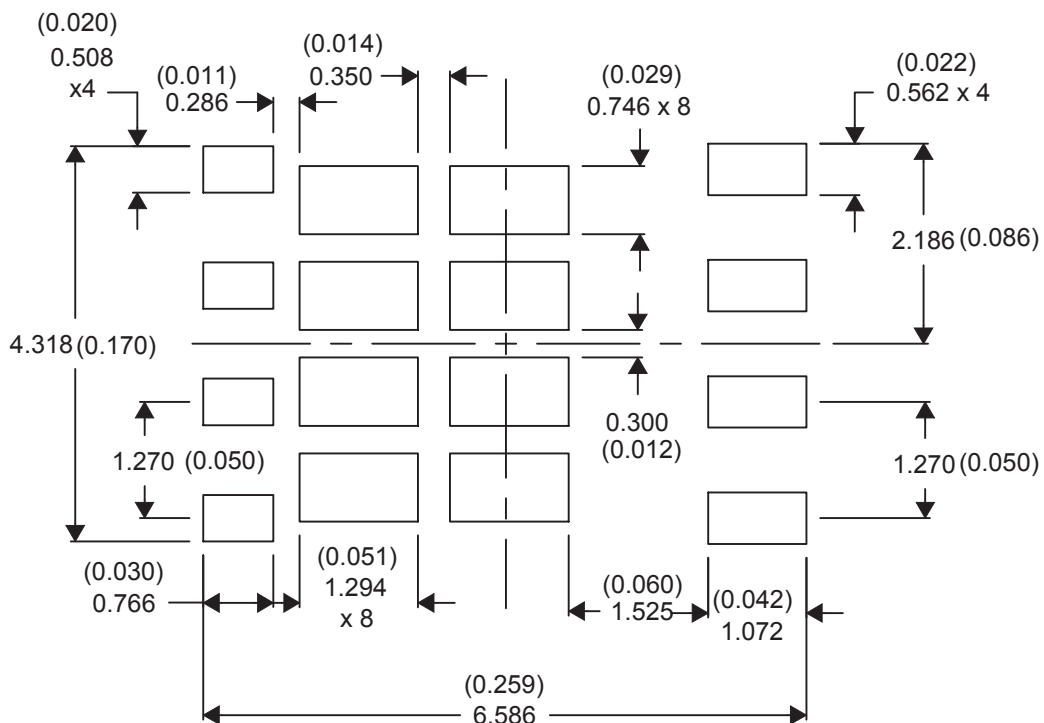

## 7.4 Q5B Tape and Reel Information

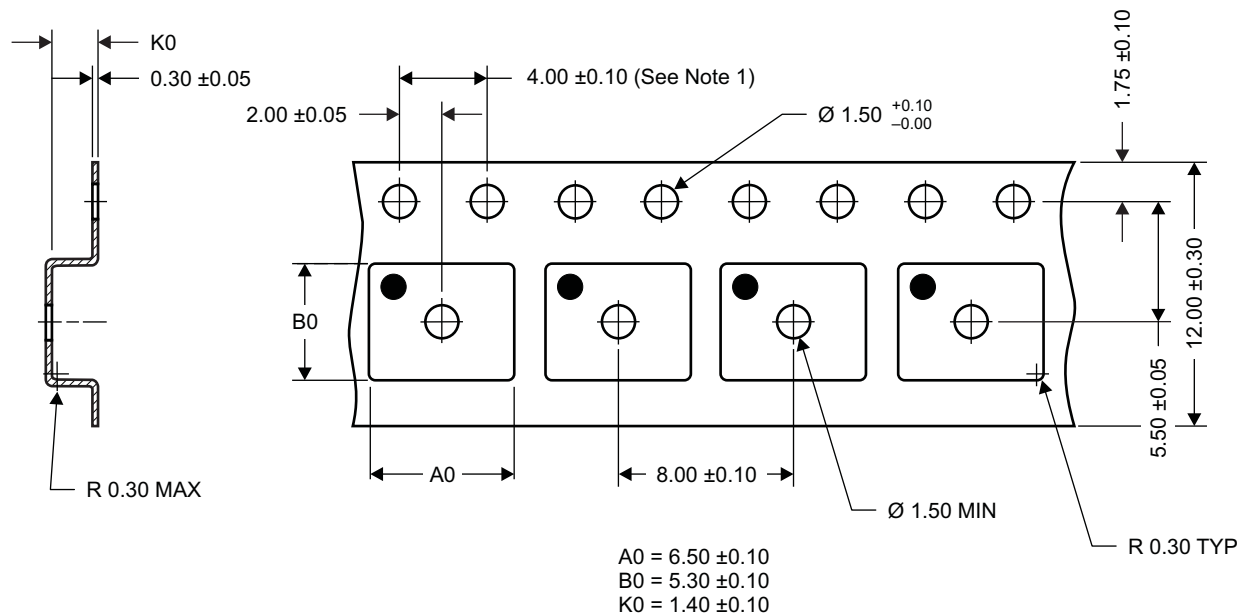



M0138-01

### Notes:

- 10-sprocket hole-pitch cumulative tolerance  $\pm 0.2$ .
- Camber not to exceed 1 mm in 100 mm, noncumulative over 250 mm.
- Material: black static-dissipative polystyrene.
- All dimensions are in mm (unless otherwise specified).
- $A0$  and  $B0$  measured on a plane 0.3 mm above the bottom of the pocket.

**PACKAGING INFORMATION**

Orderable Device	Status (1)	Package Type	Package Drawing	Pins	Package Qty	Eco Plan (2)	Lead finish/ Ball material (6)	MSL Peak Temp (3)	Op Temp (°C)	Device Marking (4/5)	Samples
CSD18512Q5B	ACTIVE	VSON-CLIP	DNK	8	2500	RoHS-Exempt & Green	NIPDAU	Level-1-260C-UNLIM	-55 to 150	CSD18512	
CSD18512Q5BT	ACTIVE	VSON-CLIP	DNK	8	250	RoHS-Exempt & Green	NIPDAU	Level-1-260C-UNLIM	-55 to 150	CSD18512	

(1) The marketing status values are defined as follows:

**ACTIVE:** Product device recommended for new designs.

**LIFEBUY:** TI has announced that the device will be discontinued, and a lifetime-buy period is in effect.

**NRND:** Not recommended for new designs. Device is in production to support existing customers, but TI does not recommend using this part in a new design.

**PREVIEW:** Device has been announced but is not in production. Samples may or may not be available.

**OBSOLETE:** TI has discontinued the production of the device.

(2) **RoHS:** TI defines "RoHS" to mean semiconductor products that are compliant with the current EU RoHS requirements for all 10 RoHS substances, including the requirement that RoHS substance do not exceed 0.1% by weight in homogeneous materials. Where designed to be soldered at high temperatures, "RoHS" products are suitable for use in specified lead-free processes. TI may reference these types of products as "Pb-Free".

**RoHS Exempt:** TI defines "RoHS Exempt" to mean products that contain lead but are compliant with EU RoHS pursuant to a specific EU RoHS exemption.

**Green:** TI defines "Green" to mean the content of Chlorine (Cl) and Bromine (Br) based flame retardants meet JS709B low halogen requirements of <=1000ppm threshold. Antimony trioxide based flame retardants must also meet the <=1000ppm threshold requirement.

(3) MSL, Peak Temp. - The Moisture Sensitivity Level rating according to the JEDEC industry standard classifications, and peak solder temperature.

(4) There may be additional marking, which relates to the logo, the lot trace code information, or the environmental category on the device.

(5) Multiple Device Markings will be inside parentheses. Only one Device Marking contained in parentheses and separated by a "~" will appear on a device. If a line is indented then it is a continuation of the previous line and the two combined represent the entire Device Marking for that device.

(6) Lead finish/Ball material - Orderable Devices may have multiple material finish options. Finish options are separated by a vertical ruled line. Lead finish/Ball material values may wrap to two lines if the finish value exceeds the maximum column width.

**Important Information and Disclaimer:**The information provided on this page represents TI's knowledge and belief as of the date that it is provided. TI bases its knowledge and belief on information provided by third parties, and makes no representation or warranty as to the accuracy of such information. Efforts are underway to better integrate information from third parties. TI has taken and continues to take reasonable steps to provide representative and accurate information but may not have conducted destructive testing or chemical analysis on incoming materials and chemicals. TI and TI suppliers consider certain information to be proprietary, and thus CAS numbers and other limited information may not be available for release.

In no event shall TI's liability arising out of such information exceed the total purchase price of the TI part(s) at issue in this document sold by TI to Customer on an annual basis.



# PACKAGE OUTLINE

DNK0008A

VSON-CLIP - 1 mm max height

PLASTIC SMALL OUTLINE - NO LEAD

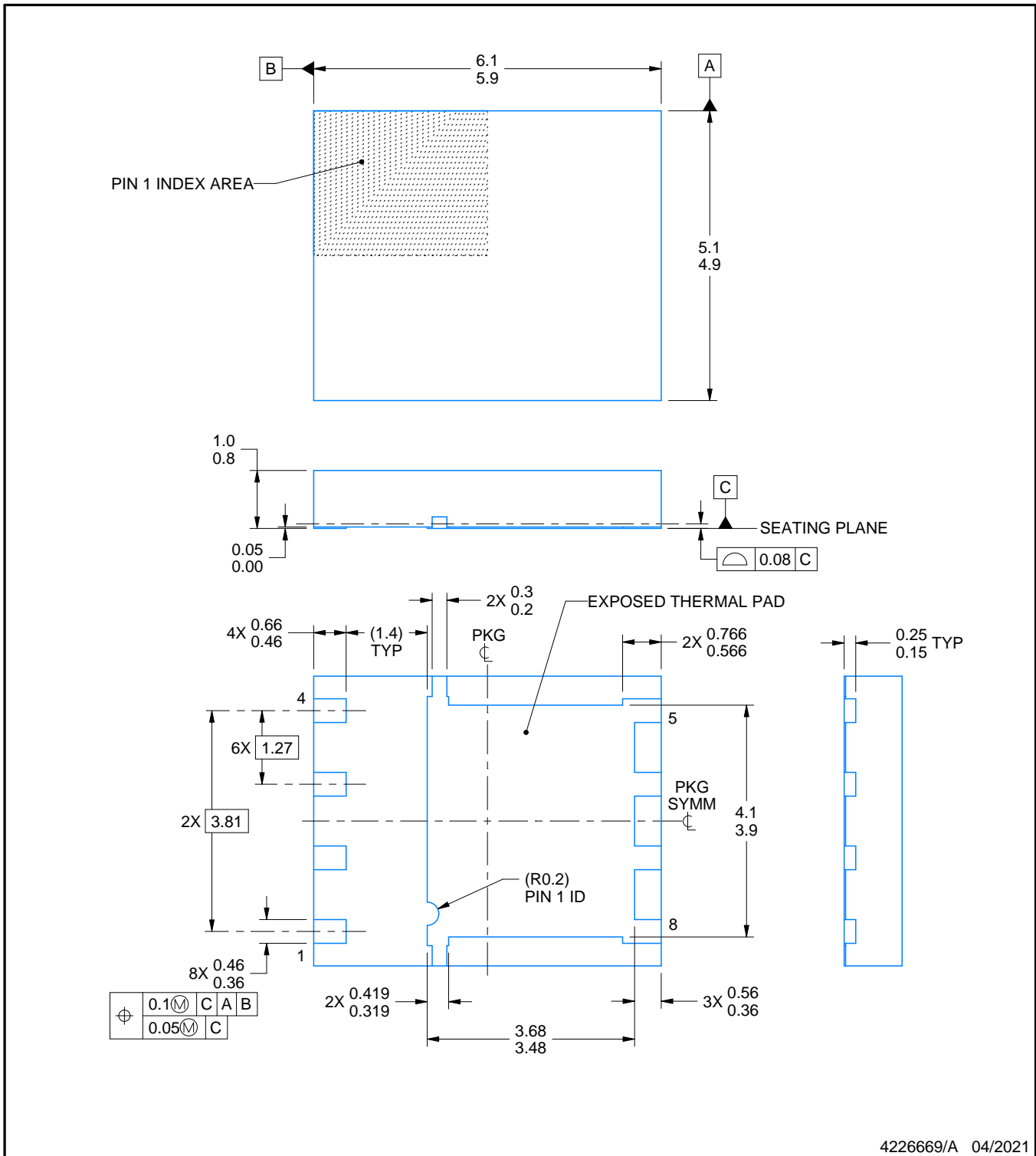

4226669/A 04/2021

NOTES:

1. All linear dimensions are in millimeters. Any dimensions in parenthesis are for reference only. Dimensioning and tolerancing per ASME Y14.5M.
2. This drawing is subject to change without notice.
3. The package thermal pad must be soldered to the printed circuit board for thermal and mechanical performance.

# EXAMPLE BOARD LAYOUT

## DNK0008A

### VSON-CLIP - 1 mm max height

PLASTIC SMALL OUTLINE - NO LEAD

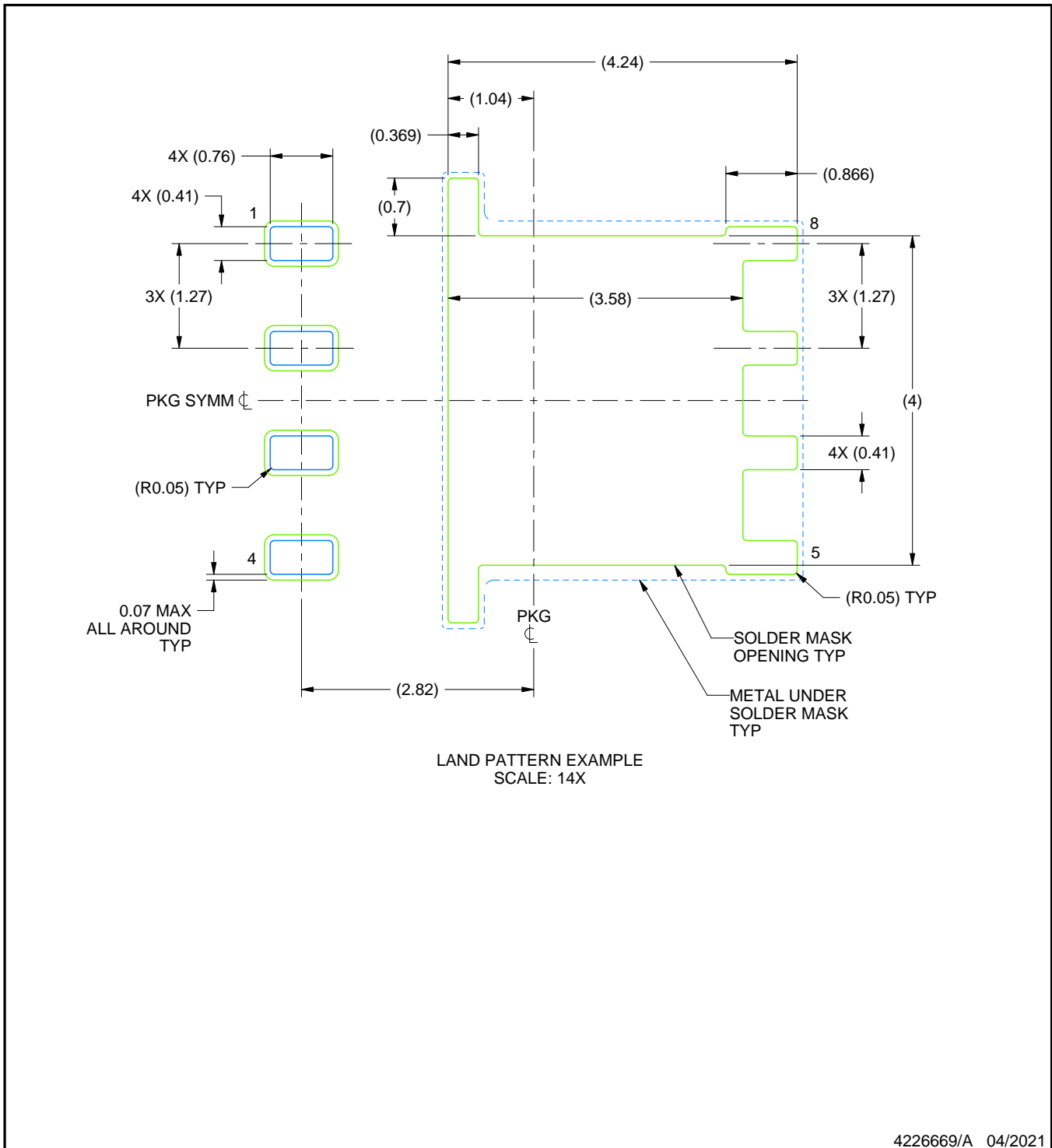

NOTES: (continued)

4. This package is designed to be soldered to a thermal pad on the board. For more information, see Texas Instruments literature number SLUA271 ([www.ti.com/lit/sluea271](http://www.ti.com/lit/sluea271)).
5. Vias are optional depending on application, refer to device data sheet. If some or all are implemented, recommended via locations are shown.

# EXAMPLE STENCIL DESIGN

DNK0008A

VSON-CLIP - 1 mm max height

PLASTIC SMALL OUTLINE - NO LEAD

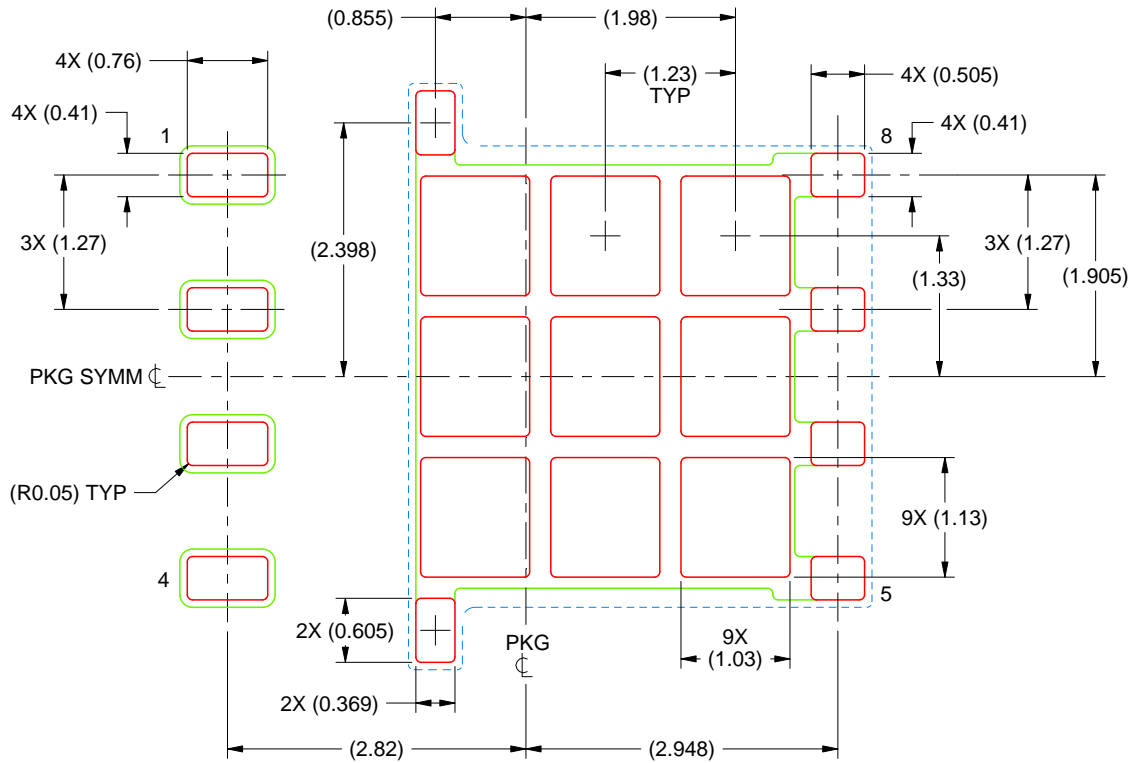

SOLDER PASTE EXAMPLE  
BASED ON 0.125 mm THICK STENCIL  
SCALE: 14X

74% PRINTED SOLDER COVERAGE BY AREA UNDER PACKAGE

4226669/A 04/2021

NOTES: (continued)

6. Laser cutting apertures with trapezoidal walls and rounded corners may offer better paste release. IPC-7525 may have alternate design recommendations.

## IMPORTANT NOTICE AND DISCLAIMER

TI PROVIDES TECHNICAL AND RELIABILITY DATA (INCLUDING DATA SHEETS), DESIGN RESOURCES (INCLUDING REFERENCE DESIGNS), APPLICATION OR OTHER DESIGN ADVICE, WEB TOOLS, SAFETY INFORMATION, AND OTHER RESOURCES "AS IS" AND WITH ALL FAULTS, AND DISCLAIMS ALL WARRANTIES, EXPRESS AND IMPLIED, INCLUDING WITHOUT LIMITATION ANY IMPLIED WARRANTIES OF MERCHANTABILITY, FITNESS FOR A PARTICULAR PURPOSE OR NON-INFRINGEMENT OF THIRD PARTY INTELLECTUAL PROPERTY RIGHTS.

These resources are intended for skilled developers designing with TI products. You are solely responsible for (1) selecting the appropriate TI products for your application, (2) designing, validating and testing your application, and (3) ensuring your application meets applicable standards, and any other safety, security, regulatory or other requirements.

These resources are subject to change without notice. TI grants you permission to use these resources only for development of an application that uses the TI products described in the resource. Other reproduction and display of these resources is prohibited. No license is granted to any other TI intellectual property right or to any third party intellectual property right. TI disclaims responsibility for, and you will fully indemnify TI and its representatives against, any claims, damages, costs, losses, and liabilities arising out of your use of these resources.

TI's products are provided subject to [TI's Terms of Sale](#) or other applicable terms available either on [ti.com](https://www.ti.com) or provided in conjunction with such TI products. TI's provision of these resources does not expand or otherwise alter TI's applicable warranties or warranty disclaimers for TI products.

TI objects to and rejects any additional or different terms you may have proposed.

Mailing Address: Texas Instruments, Post Office Box 655303, Dallas, Texas 75265  
Copyright © 2023, Texas Instruments Incorporated