

Dual 30-V N-Channel NexFET™ Power MOSFETs

FEATURES

- Common Source Connection
- Ultra Low Drain to Drain On-Resistance
- Space Saving SON 3.3 x 3.3mm Plastic Package
- Optimized for 5V Gate Drive
- Low Thermal Resistance
- Avalanche Rated
- Pb Free Terminal Plating
- RoHS Compliant
- Halogen Free

APPLICATIONS

- Adaptor/USB Input Protection for Notebook PCs and Tablets

DESCRIPTION

The CSD87312Q3E is a 30V common-source, dual N-channel device designed for adaptor/USB input protection. This SON 3.3 x 3.3mm device has low drain to drain on-resistance that minimizes losses and offers low component count for space constrained multi-cell battery charging applications.

PRODUCT SUMMARY

$T_A = 25^\circ\text{C}$		TYPICAL VALUE	UNIT
V_{DS}	Drain to Source Voltage	30	V
Q_g	Gate Charge Total (4.5V)	6.3	nC
Q_{gd}	Gate Charge Gate to Drain	0.7	nC
$R_{DD(on)}$	Drain to Drain On Resistance (Q1+Q2)	$V_{GS} = 4.5\text{V}$	31 mΩ
		$V_{GS} = 8\text{V}$	27 mΩ
$V_{GS(th)}$	Threshold Voltage	1.0	V

ORDERING INFORMATION

Device	Package	Media	Qty	Ship
CSD87312Q3E	SON 3.3 x 3.3mm Plastic Package	13-Inch Reel	2500	Tape and Reel

ABSOLUTE MAXIMUM RATINGS

$T_A = 25^\circ\text{C}$		VALUE	UNIT
V_{DS}	Drain to Source Voltage	30	V
V_{GS}	Gate to Source Voltage	+10/-8	V
I_D	Continuous Drain Current, $T_C = 25^\circ\text{C}^{(1)}$	27	A
I_{DM}	Pulsed Drain Current ⁽²⁾	45	A
P_D	Power Dissipation	2.5	W
T_J, T_{STG}	Operating Junction and Storage Temperature Range	-55 to 150	$^\circ\text{C}$
E_{AS}	Avalanche Energy, single pulse $I_D = 24\text{A}, L = 0.1\text{mH}, R_G = 25\Omega$	29	mJ

(1) Typical $R_{\theta JC} = 63^\circ\text{C/W}$ on 1in^2 (2 oz.) on 0.060" thick FR4PCB

(2) Pulse duration $\leq 300\mu\text{s}$, duty cycle $\leq 2\%$

Top View

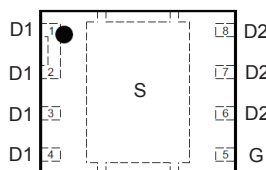

Circuit Image

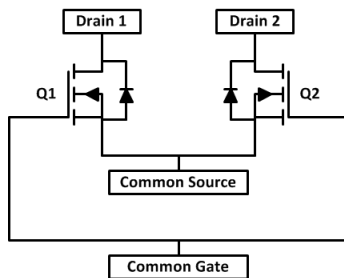

V_{GS} vs. R_{DDon}

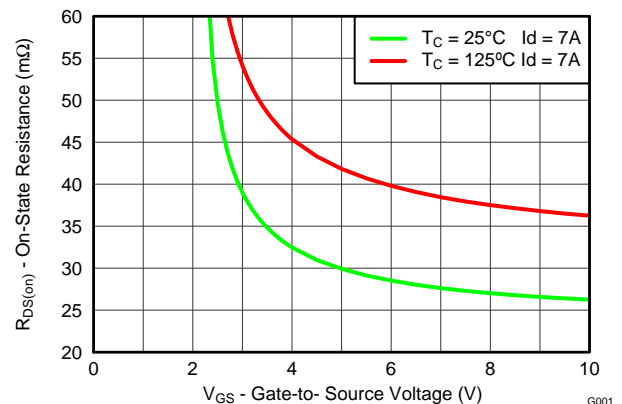

Please be aware that an important notice concerning availability, standard warranty, and use in critical applications of Texas Instruments semiconductor products and disclaimers thereto appears at the end of this data sheet.



These devices have limited built-in ESD protection. The leads should be shorted together or the device placed in conductive foam during storage or handling to prevent electrostatic damage to the MOS gates.

ELECTRICAL CHARACTERISTICS

($T_A = 25^\circ\text{C}$ unless otherwise stated)

PARAMETER		TEST CONDITIONS	MIN	TYP	MAX	UNIT
Static Characteristics						
V_{DSS}	Drain to Source Voltage	$V_{GS} = 0V, I_D = 250\mu A$	30			V
I_{DSS}	Drain to Source Leakage Current	$V_{GS} = 0V, V_{DS} = 24V$			1	μA
I_{GSS}	Gate to Source Leakage Current	$V_{DS} = 0V, V_{GS} = +10/-8V$			100	nA
$V_{GS(th)}$	Gate to Source Threshold Voltage	$V_{DS} = V_{GS}, I_D = 250\mu A$	0.8	1.0	1.3	V
$R_{DD(on)}$	Drain to Drain On Resistance (Q1 + Q2)	$V_{GS} = 4.5V, I_D = 7A$		31	38	$m\Omega$
		$V_{GS} = 8V, I_D = 7A$		27	33	$m\Omega$
g_{fs}	Transconductance	$V_{DS} = 15V, I_D = 7A$		39		S
Dynamic Characteristics⁽¹⁾						
C_{iss}	Input Capacitance	$V_{GS} = 0V, V_{DS} = 15V, f = 1MHz$		960	1250	pF
C_{oss}	Output Capacitance			190	247	pF
C_{riss}	Reverse Transfer Capacitance			12	16	pF
R_G	Series Gate Resistance			5	10	Ω
Q_g	Gate Charge Total (4.5V)	$V_{DS} = 15V, I_D = 7A$		6.3	8.2	nC
Q_{gd}	Gate Charge Gate to Drain			0.7		nC
Q_{gs}	Gate Charge Gate to Source			1.9		nC
$Q_{g(th)}$	Gate Charge at V_{th}			1.0		nC
Q_{oss}	Output Charge	$V_{DS} = 15V, V_{GS} = 0V$		4.0		nC
$t_{d(on)}$	Turn On Delay Time	$V_{DS} = 15V, V_{GS} = 4.5V, I_{DS} = 7A, R_G = 2\Omega$		7.8		ns
t_r	Rise Time			16		ns
$t_{d(off)}$	Turn Off Delay Time			17		ns
t_f	Fall Time			2.9		ns
Diode Characteristics⁽¹⁾						
V_{SD}	Diode Forward Voltage	$I_{SD} = 7A, V_{GS} = 0V$		0.8	1	V
Q_{rr}	Reverse Recovery Charge	$V_{DS} = 15V, I_F = 7A, di/dt = 300A/\mu s$		5.3		nC
t_{rr}	Reverse Recovery Time			12.2		ns

(1) All Dynamic and Diode Characteristics were measured with respect to one of the two drains, with the other left floating.

THERMAL CHARACTERISTICS

($T_A = 25^\circ\text{C}$ unless otherwise stated)

PARAMETER		MIN	TYP	MAX	UNIT
$R_{\theta JC}$	Thermal Resistance Junction to Case ⁽¹⁾			4.2	$^\circ\text{C}/W$
$R_{\theta JA}$	Thermal Resistance Junction to Ambient ⁽¹⁾⁽²⁾			63	$^\circ\text{C}/W$

- (1) $R_{\theta JC}$ is determined with the device mounted on a 1-inch² (6.45-cm²), 2-oz. (0.071-mm thick) Cu pad on a 1.5-inch x 1.5-inch (3.81-cm x 3.81-cm), 0.06-inch (1.52-mm) thick FR4 PCB. $R_{\theta JC}$ is specified by design, whereas $R_{\theta JA}$ is determined by the user's board design.
- (2) Device mounted on FR4 material with 1-inch² (6.45-cm²), 2-oz. (0.071-mm thick) Cu.

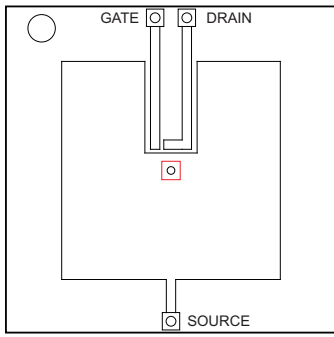

Max $R_{\theta JA} = 63^{\circ}\text{C/W}$
when mounted on
1 inch² (6.45 cm²) of 2-
oz. (0.071-mm thick)
Cu.

M0137-01

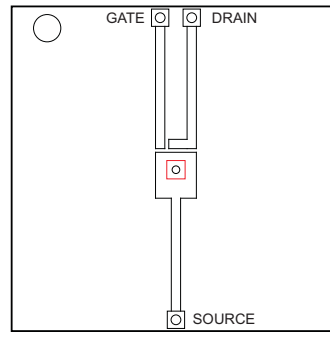

Max $R_{\theta JA} = 165^{\circ}\text{C/W}$
when mounted on a
minimum pad area of
2-oz. (0.071-mm thick)
Cu.

M0137-02

TYPICAL MOSFET CHARACTERISTICS

($T_A = 25^{\circ}\text{C}$ unless otherwise stated)

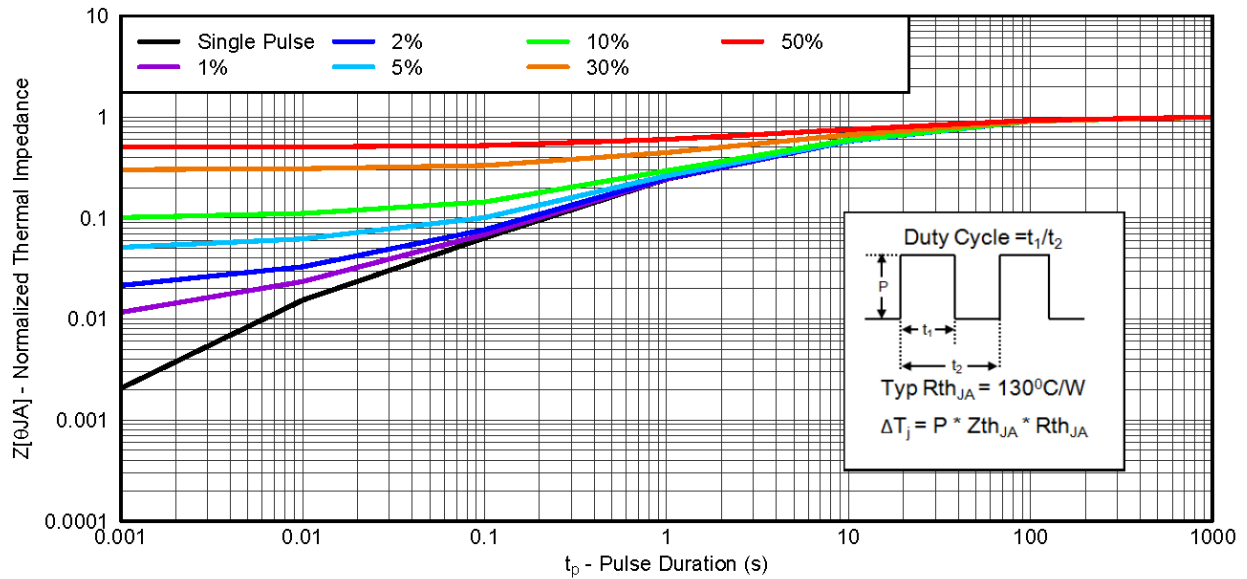

G001

Figure 1. Transient Thermal Impedance

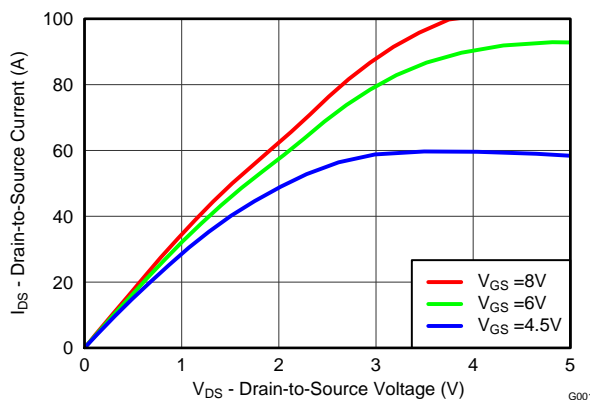

G001

Figure 2. Saturation Characteristics

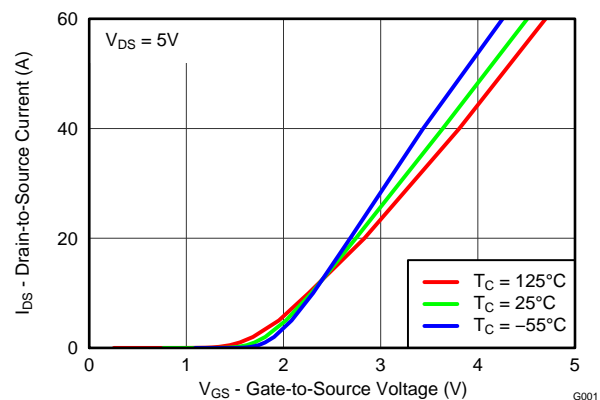

G001

Figure 3. Transfer Characteristics

TYPICAL MOSFET CHARACTERISTICS (continued)

($T_A = 25^\circ\text{C}$ unless otherwise stated)

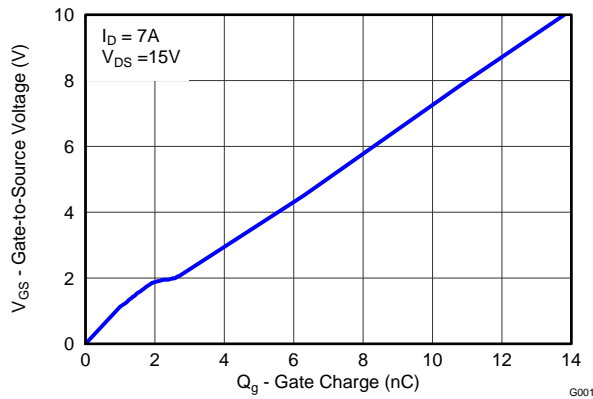

Figure 4. Gate Charge

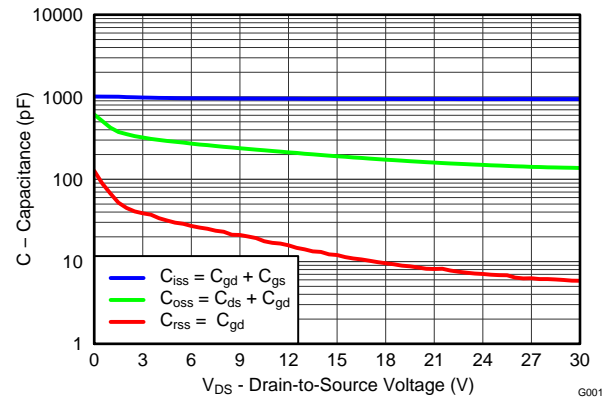

Figure 5. Capacitance

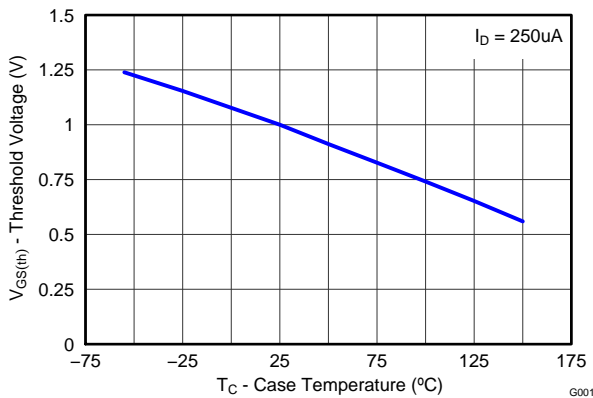

Figure 6. Threshold Voltage vs. Temperature

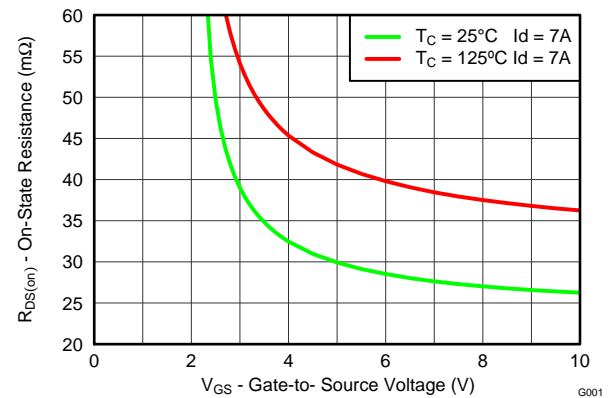

Figure 7. On-State Resistance vs. Gate-to-Source Voltage

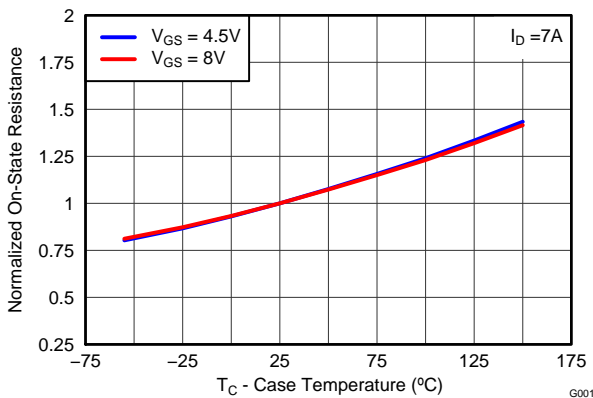

Figure 8. Normalized On-State Resistance vs. Temperature

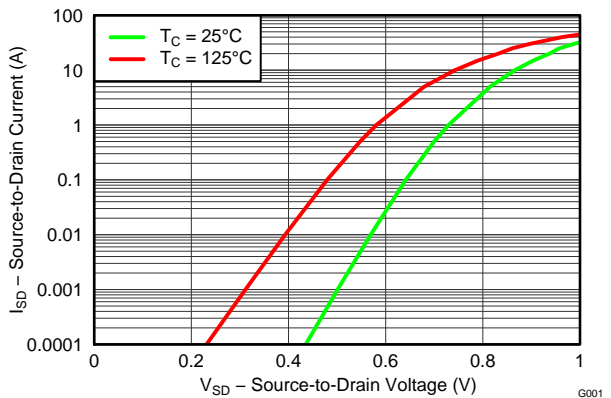

Figure 9. Typical Diode Forward Voltage

TYPICAL MOSFET CHARACTERISTICS (continued)

($T_A = 25^\circ\text{C}$ unless otherwise stated)

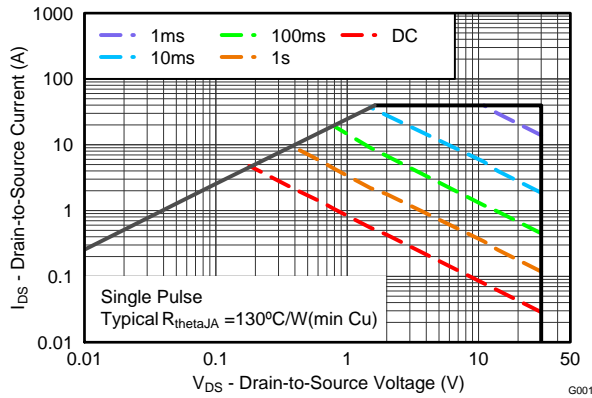

Figure 10. Maximum Safe Operating Area

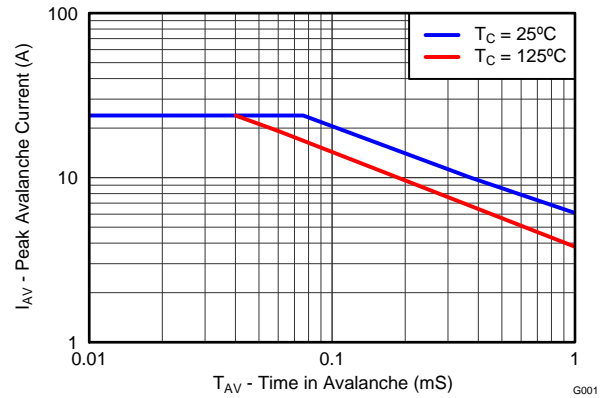

Figure 11. Single Pulse Unclamped Inductive Switching

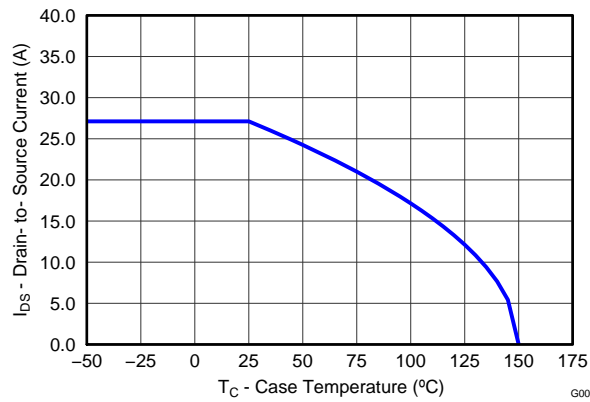
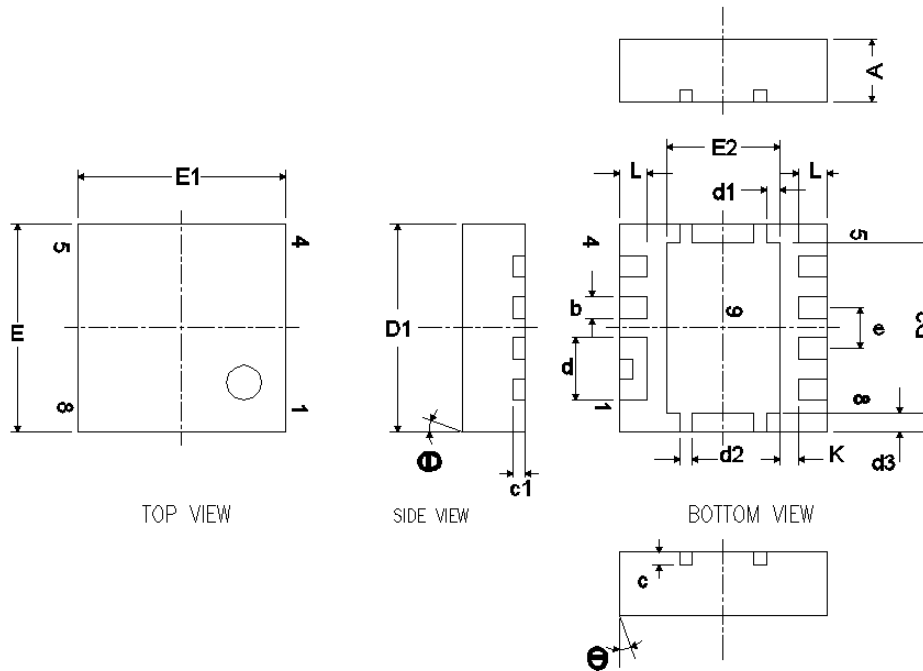

Figure 12. Maximum Drain Current vs. Temperature

MECHANICAL DATA

Q3E Package Dimensions



DIM	MILLIMETERS	
	MIN	MAX
A	0.850	1.050
b	0.280	0.400
c	0.150	0.250
c1	0.150	0.250
d	0.940	1.040
d1	0.160	0.260
d2	0.150	0.250
d3	0.250	0.350
D1	3.200	3.400
D2	2.650	2.750
E	3.200	3.400
E1	3.200	3.400
E2	1.750	1.850
e	0.650 TYP	
L	0.400	0.500
θ	0°	-
K	0.300 Typ	

Notes:

1. Pin 1-4: Drain 1
2. Pin 5: Gate
3. Pin 6-8: Drain 2
4. Pin 9: Source

Recommended PCB Pattern

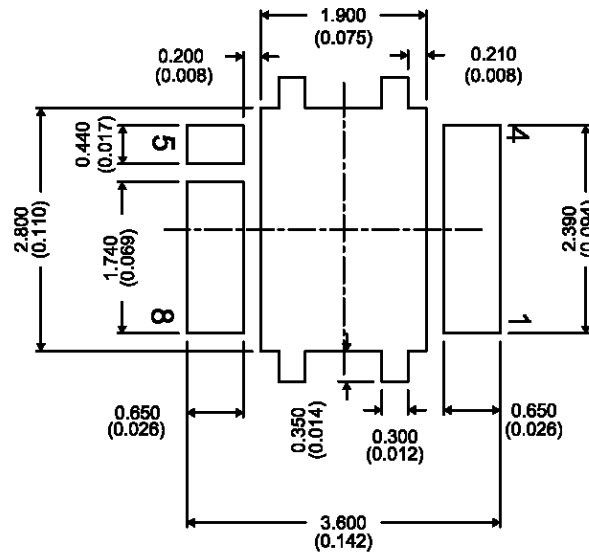

Recommended Stencil Opening

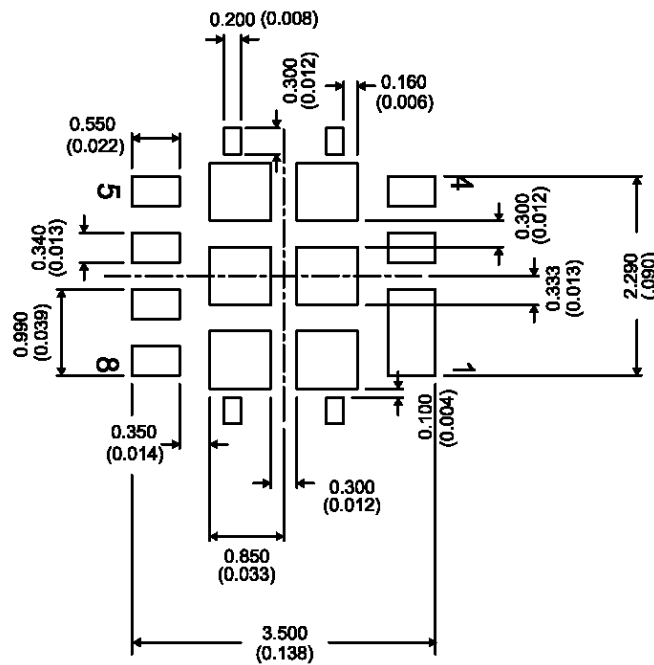

For recommended circuit layout for PCB designs, see application note [SLPA005 – Reducing Ringing Through PCB Layout Techniques](#).

Q3E Tape and Reel Information

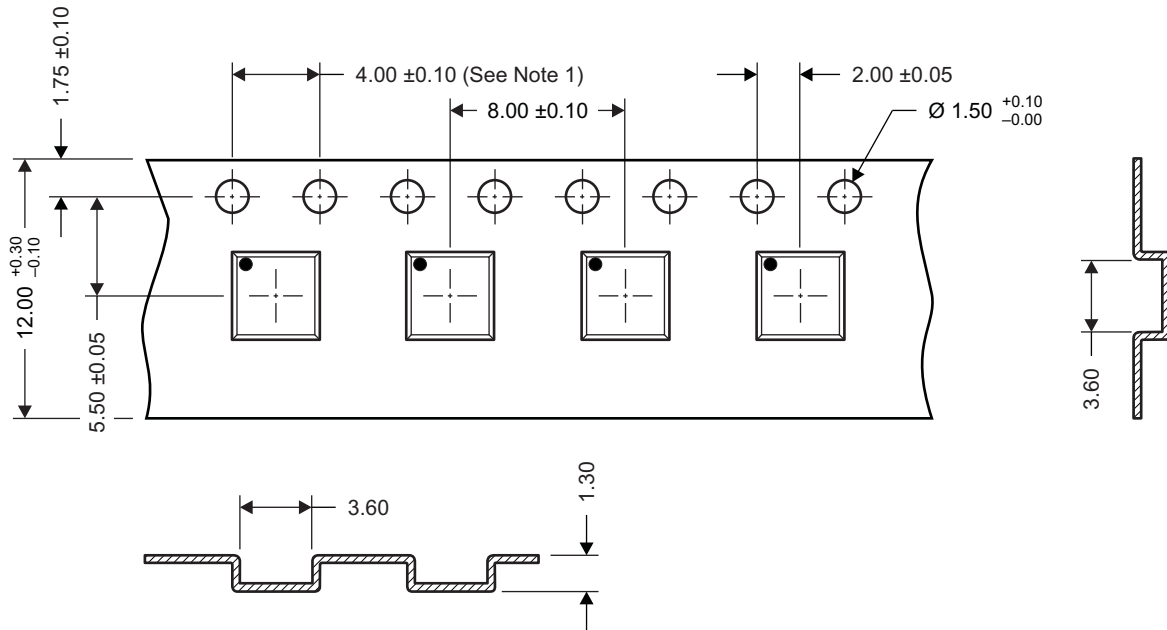

M0144-01

Notes:

- 10 sprocket hole pitch cumulative tolerance ± 0.2
- Camber not to exceed 1mm IN 100mm, noncumulative over 250mm
- Material: black static dissipative polystyrene
- All dimensions are in mm (unless otherwise specified)
- Thickness: 0.30 ± 0.05 mm
- MSL1 260°C (IR and Convection) PbF Reflow Compatible

PACKAGING INFORMATION

Orderable part number	Status (1)	Material type (2)	Package Pins	Package qty Carrier	RoHS (3)	Lead finish/ Ball material (4)	MSL rating/ Peak reflow (5)	Op temp (°C)	Part marking (6)
CSD87312Q3E	Active	Production	VSON (DPA) 8	2500 LARGE T&R	ROHS Exempt	NIPDAU	Level-1-260C-UNLIM	-55 to 150	87312E
CSD87312Q3E.B	Active	Production	VSON (DPA) 8	2500 LARGE T&R	ROHS Exempt	NIPDAU	Level-1-260C-UNLIM	-55 to 150	87312E

(1) **Status:** For more details on status, see our [product life cycle](#).

(2) **Material type:** When designated, preproduction parts are prototypes/experimental devices, and are not yet approved or released for full production. Testing and final process, including without limitation quality assurance, reliability performance testing, and/or process qualification, may not yet be complete, and this item is subject to further changes or possible discontinuation. If available for ordering, purchases will be subject to an additional waiver at checkout, and are intended for early internal evaluation purposes only. These items are sold without warranties of any kind.

(3) **RoHS values:** Yes, No, RoHS Exempt. See the [TI RoHS Statement](#) for additional information and value definition.

(4) **Lead finish/Ball material:** Parts may have multiple material finish options. Finish options are separated by a vertical ruled line. Lead finish/Ball material values may wrap to two lines if the finish value exceeds the maximum column width.

(5) **MSL rating/Peak reflow:** The moisture sensitivity level ratings and peak solder (reflow) temperatures. In the event that a part has multiple moisture sensitivity ratings, only the lowest level per JEDEC standards is shown. Refer to the shipping label for the actual reflow temperature that will be used to mount the part to the printed circuit board.

(6) **Part marking:** There may be an additional marking, which relates to the logo, the lot trace code information, or the environmental category of the part.

Multiple part markings will be inside parentheses. Only one part marking contained in parentheses and separated by a "~" will appear on a part. If a line is indented then it is a continuation of the previous line and the two combined represent the entire part marking for that device.

Important Information and Disclaimer:The information provided on this page represents TI's knowledge and belief as of the date that it is provided. TI bases its knowledge and belief on information provided by third parties, and makes no representation or warranty as to the accuracy of such information. Efforts are underway to better integrate information from third parties. TI has taken and continues to take reasonable steps to provide representative and accurate information but may not have conducted destructive testing or chemical analysis on incoming materials and chemicals. TI and TI suppliers consider certain information to be proprietary, and thus CAS numbers and other limited information may not be available for release.

In no event shall TI's liability arising out of such information exceed the total purchase price of the TI part(s) at issue in this document sold by TI to Customer on an annual basis.

TAPE AND REEL INFORMATION

QUADRANT ASSIGNMENTS FOR PIN 1 ORIENTATION IN TAPE

*All dimensions are nominal

Device	Package Type	Package Drawing	Pins	SPQ	Reel Diameter (mm)	Reel Width W1 (mm)	A0 (mm)	B0 (mm)	K0 (mm)	P1 (mm)	W (mm)	Pin1 Quadrant
CSD87312Q3E	VSON	DPA	8	2500	330.0	12.4	3.6	3.6	1.2	8.0	12.0	Q2

TAPE AND REEL BOX DIMENSIONS

*All dimensions are nominal

Device	Package Type	Package Drawing	Pins	SPQ	Length (mm)	Width (mm)	Height (mm)
CSD87312Q3E	VSON	DPA	8	2500	346.0	346.0	33.0

DPA0008A



PACKAGE OUTLINE

VSON - 1 mm max height

PLASTIC SMALL OUTLINE - NO LEAD

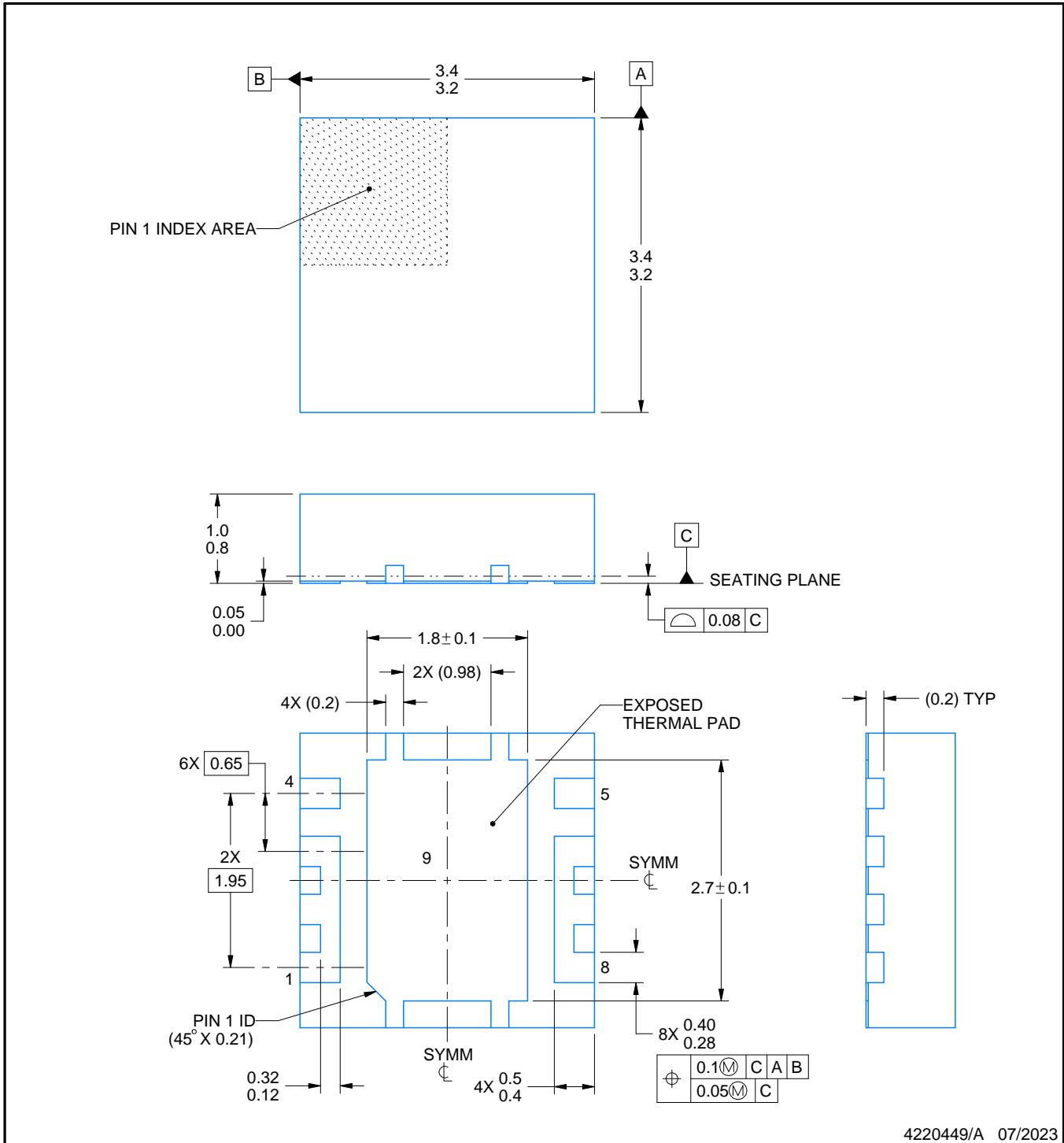

NOTES:

1. All linear dimensions are in millimeters. Any dimensions in parenthesis are for reference only. Dimensioning and tolerancing per ASME Y14.5M.
2. This drawing is subject to change without notice.
3. The package thermal pad must be soldered to the printed circuit board for thermal and mechanical performance.

EXAMPLE BOARD LAYOUT

DPA0008A

VSON - 1 mm max height

PLASTIC SMALL OUTLINE - NO LEAD

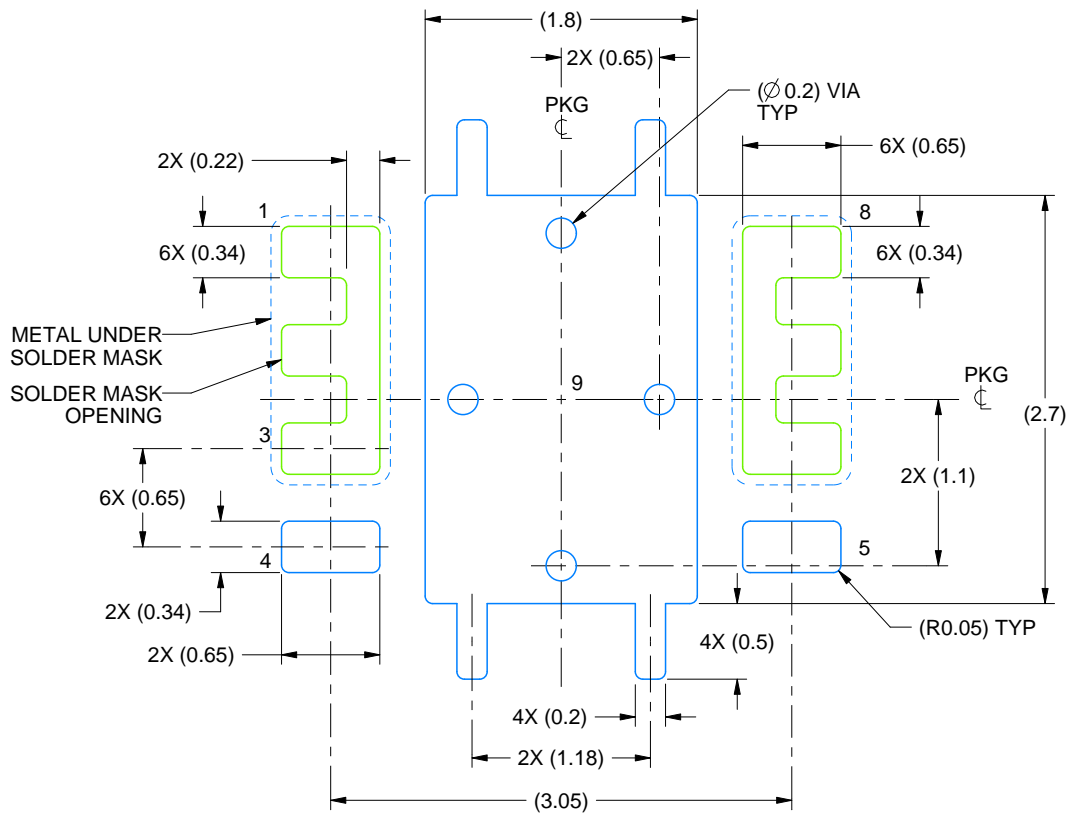

LAND PATTERN EXAMPLE
SCALE:20X

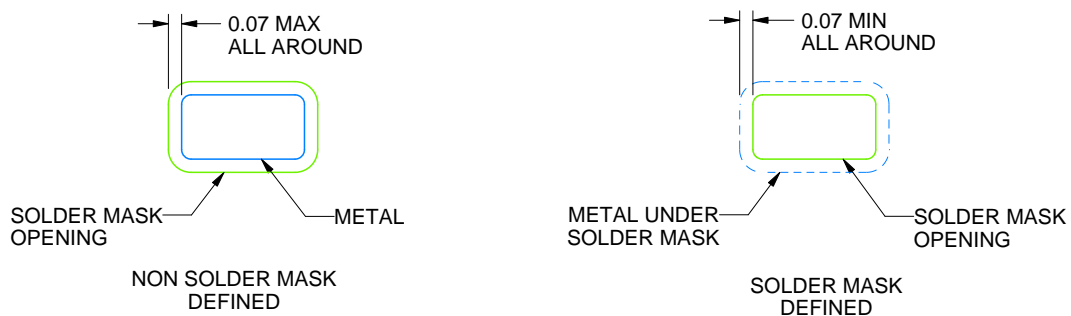

SOLDER MASK DETAILS

4220449/A 07/2023

NOTES: (continued)

- This package is designed to be soldered to a thermal pad on the board. For more information, see Texas Instruments literature number SLUA271 (www.ti.com/lit/slua271).
- Vias are optional depending on application, refer to device data sheet. If some or all are implemented, recommended via locations are shown.

EXAMPLE STENCIL DESIGN

DPA0008A

VSON - 1 mm max height

PLASTIC SMALL OUTLINE - NO LEAD

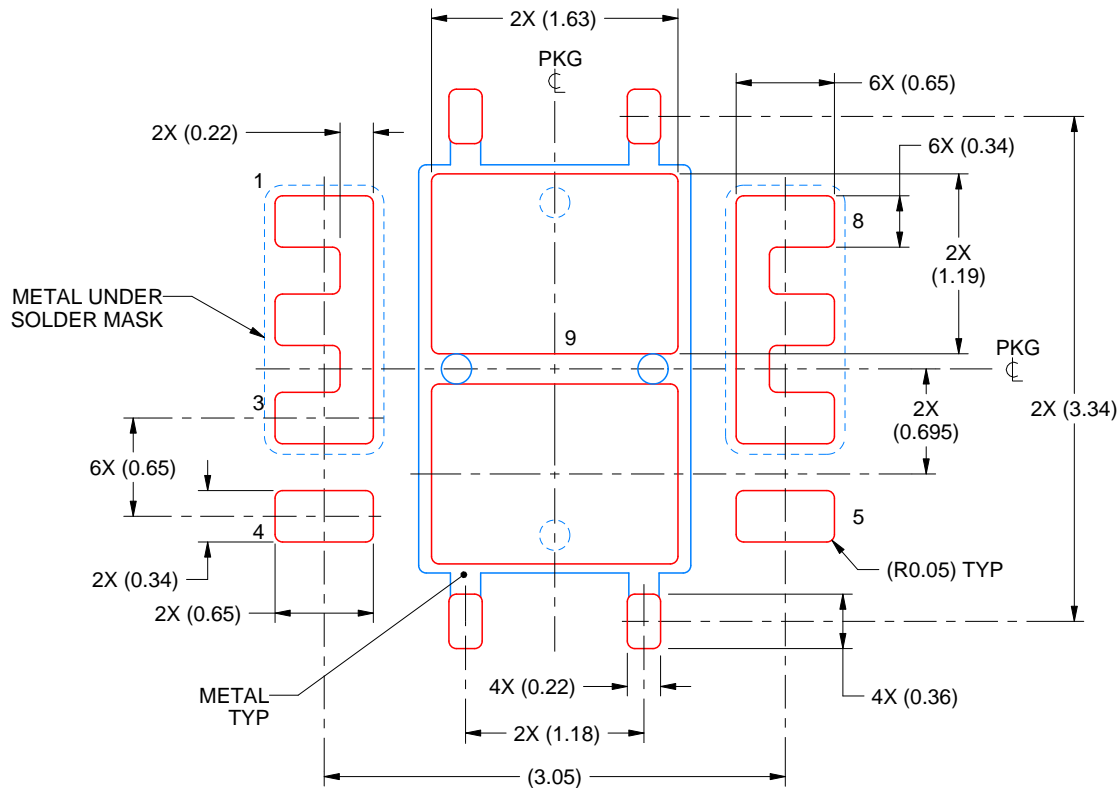

SOLDER PASTE EXAMPLE
BASED ON 0.125 mm THICK STENCIL

EXPOSED PAD 9
76% PRINTED SOLDER COVERAGE BY AREA UNDER PACKAGE
SCALE:20X

4220449/A 07/2023

NOTES: (continued)

6. Laser cutting apertures with trapezoidal walls and rounded corners may offer better paste release. IPC-7525 may have alternate design recommendations.

IMPORTANT NOTICE AND DISCLAIMER

TI PROVIDES TECHNICAL AND RELIABILITY DATA (INCLUDING DATASHEETS), DESIGN RESOURCES (INCLUDING REFERENCE DESIGNS), APPLICATION OR OTHER DESIGN ADVICE, WEB TOOLS, SAFETY INFORMATION, AND OTHER RESOURCES "AS IS" AND WITH ALL FAULTS, AND DISCLAIMS ALL WARRANTIES, EXPRESS AND IMPLIED, INCLUDING WITHOUT LIMITATION ANY IMPLIED WARRANTIES OF MERCHANTABILITY, FITNESS FOR A PARTICULAR PURPOSE OR NON-INFRINGEMENT OF THIRD PARTY INTELLECTUAL PROPERTY RIGHTS.

These resources are intended for skilled developers designing with TI products. You are solely responsible for (1) selecting the appropriate TI products for your application, (2) designing, validating and testing your application, and (3) ensuring your application meets applicable standards, and any other safety, security, regulatory or other requirements.

These resources are subject to change without notice. TI grants you permission to use these resources only for development of an application that uses the TI products described in the resource. Other reproduction and display of these resources is prohibited. No license is granted to any other TI intellectual property right or to any third party intellectual property right. TI disclaims responsibility for, and you fully indemnify TI and its representatives against any claims, damages, costs, losses, and liabilities arising out of your use of these resources.

TI's products are provided subject to [TI's Terms of Sale](#), [TI's General Quality Guidelines](#), or other applicable terms available either on ti.com or provided in conjunction with such TI products. TI's provision of these resources does not expand or otherwise alter TI's applicable warranties or warranty disclaimers for TI products. Unless TI explicitly designates a product as custom or customer-specified, TI products are standard, catalog, general purpose devices.

TI objects to and rejects any additional or different terms you may propose.

Copyright © 2025, Texas Instruments Incorporated

Last updated 10/2025