

# ESD751 and ESD761 24-V 1-Channel ESD Protection Diodes

## 1 Features

- IEC 61000-4-2 level 4 ESD protection:
  - ±22-kV or ±15-kV contact discharge
  - ±22-kV or ±15-kV air-gap discharge
- Robust surge protection:
  - IEC 61000-4-5 (8/20 μs): 2.8 A or 1.8 A
- 24-V working voltage
- Bidirectional ESD protection
- Low clamping voltage protects downstream components
- Temperature range: –55°C to +150°C
- I/O capacitance = 1.6 pF or 1.1 pF (typical)
- Offered in a standard leaded package and 0402 footprint package: SOD-523 (DYA) and X1SON (DPY)
- Leaded packages used for automatic optical inspection (AOI)

## 2 Applications

- USB power delivery (USB-PD)
  - VBUS protection
  - I/O protection
- **Industrial control networks:**
  - DeviceNet
  - Smart distribution systems
  - 4/20 mA circuits
  - PLC surge protection
  - ADC surge protection

## 3 Description

The ESD751 and ESD761 are single-channel low capacitance bidirectional ESD protection devices for USB power delivery (USB-PD). These devices are rated to dissipate contact ESD strikes beyond the maximum level specified in the IEC 61000-4-2 international standard (±22-kV Contact, ±22-kV Airgap) and (±15-kV Contact, ±15-kV Airgap), respectively. The low dynamic resistance and low clamping voltage help protect systems against transient events. This protection is key because industrial systems require a high level of robustness and reliability.

### Package Information<sup>(1)</sup>

PART NUMBER	PACKAGE	BODY SIZE (NOM)
ESD751	DYA (SOD-523, 2)	1.60 mm × 0.80 mm
ESD761	DPY (X1SON, 2)	1.00 mm × 0.60 mm

(1) For all available packages, see the orderable addendum at the end of the data sheet.

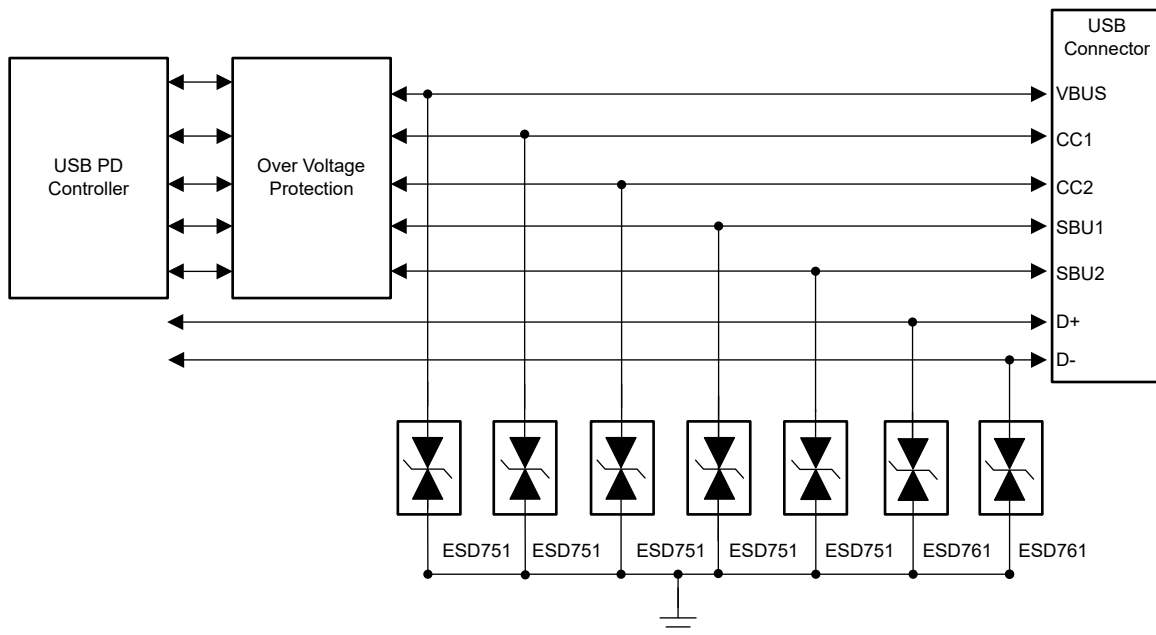

Typical Application

## Table of Contents

<b>1 Features</b> .....	1	7.4 Device Functional Modes.....	8
<b>2 Applications</b> .....	1	<b>8 Application and Implementation</b> .....	9
<b>3 Description</b> .....	1	8.1 Application Information.....	9
<b>4 Revision History</b> .....	2	8.2 Typical Application.....	9
<b>5 Pin Configuration and Functions</b> .....	3	<b>9 Power Supply Recommendations</b> .....	10
<b>6 Specifications</b> .....	4	<b>10 Layout</b> .....	11
6.1 Absolute Maximum Ratings.....	4	10.1 Layout Guidelines.....	11
6.2 ESD Ratings—JEDEC Specification.....	4	10.2 Layout Example.....	11
6.3 ESD Ratings—IEC Specification.....	4	<b>11 Device and Documentation Support</b> .....	12
6.4 Recommended Operating Conditions.....	4	11.1 Documentation Support.....	12
6.5 Thermal Information.....	5	11.2 Receiving Notification of Documentation Updates..	12
6.6 Electrical Characteristics.....	5	11.3 Support Resources.....	12
6.7 Typical Characteristics – ESD751.....	6	11.4 Trademarks.....	12
6.8 Typical Characteristics - ESD761.....	7	11.5 Electrostatic Discharge Caution.....	12
<b>7 Detailed Description</b> .....	8	11.6 Glossary.....	12
7.1 Overview.....	8	<b>12 Mechanical, Packaging, and Orderable Information</b> .....	12
7.2 Functional Block Diagram.....	8		
7.3 Feature Description.....	8		

## 4 Revision History

NOTE: Page numbers for previous revisions may differ from page numbers in the current version.

### Changes from Revision B (December 2022) to Revision C (December 2022) Page

- Updated *Thermal Information* table..... 5

### Changes from Revision A (November 2022) to Revision B (December 2022) Page

- Changed the status of the ESD761 device from: *Advanced Information* to: *Production Data* ..... 1

### Changes from Revision \* (November 2022) to Revision A (November 2022) Page

- Changed the status of the ESD751 device from: *Advanced Information* to: *Production Data* ..... 1

## 5 Pin Configuration and Functions

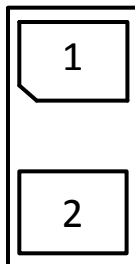

**Figure 5-1. DPY Package, 2-Pin X1SON (Top View)**

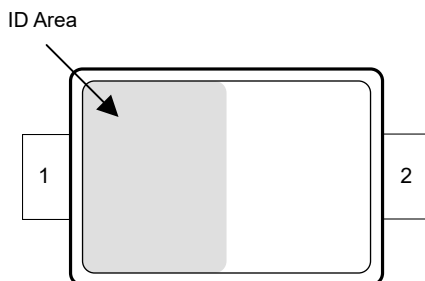

**Figure 5-2. DYA Package, 2-Pin SOD523 (Top View)**

**Table 5-1. Pin Functions**

PIN		TYPE <sup>(1)</sup>	DESCRIPTION
NAME	NO.		
IO	1	I/O	ESD protected IO
GND	2	G	Connect to ground.

(1) I = Input, O = Output, I/O = Input or Output, G = Ground, P = Power.

## 6 Specifications

### 6.1 Absolute Maximum Ratings

over operating free-air temperature range (unless otherwise noted)<sup>(1)</sup>

		DEVICE	MIN	MAX	UNIT
P <sub>PP</sub>	IEC 61000-4-5 Power (t <sub>p</sub> - 8/20 μs) at 25°C	ESD751		102	W
		ESD761		65	
I <sub>PP</sub>	IEC 61000-4-5 current (t <sub>p</sub> - 8/20 μs) at 25°C	ESD751		2.8	A
		ESD761		1.8	
T <sub>A</sub>	Operating free-air temperature		-55	150	°C
T <sub>J</sub>	Junction temperature		-55	150	
T <sub>stg</sub>	Storage temperature		-65	155	

- (1) Operation outside the Absolute Maximum Ratings may cause permanent device damage. Absolute Maximum Ratings do not imply functional operation of the device at these or any other conditions beyond those listed under Recommended Operating Conditions. If used outside the Recommended Operating Conditions but within the Absolute Maximum Ratings, the device may not be fully functional, and this may affect device reliability, functionality, performance, and shorten the device lifetime.

### 6.2 ESD Ratings—JEDEC Specification

			VALUE	UNIT
V <sub>(ESD)</sub>	Electrostatic discharge	Human body model (HBM), per ANSI/ESDA/ JEDEC JS-001 <sup>(1)</sup>	± 2500	V
		Charged device model (CDM), per JEDEC specification JS-002 <sup>(2)</sup>	± 1000	

- (1) JEDEC document JEP155 states that 500-V HBM allows safe manufacturing with a standard ESD control process.  
 (2) JEDEC document JEP157 states that 250-V CDM allows safe manufacturing with a standard ESD control process.

### 6.3 ESD Ratings—IEC Specification

			DEVICE	VALUE	UNIT
V <sub>(ESD)</sub>	Electrostatic discharge	IEC 61000-4-2 Contact Discharge, all pins	ESD751	±22000	V
			ESD761	±15000	
		IEC 61000-4-2 Air-gap Discharge, all pins	ESD751	±22000	
			ESD761	±15000	

### 6.4 Recommended Operating Conditions

over operating free-air temperature range (unless otherwise noted)

		MIN	NOM	MAX	UNIT
V <sub>IN</sub>	Input voltage	-24		24	V
T <sub>A</sub>	Operating free-air temperature	-55		150	°C

## 6.5 Thermal Information

THERMAL METRIC <sup>(1)</sup>		ESD751	ESD761	UNIT
		DYA (SOD-523)	DPY (X1SON)	
		2 PINS	2 PINS	
R <sub>θJA</sub>	Junction-to-ambient thermal resistance	746.3	282.3	°C/W
R <sub>θJC(top)</sub>	Junction-to-case (top) thermal resistance	301.2	150.6	°C/W
R <sub>θJB</sub>	Junction-to-board thermal resistance	509.6	98.3	°C/W
Ψ <sub>JT</sub>	Junction-to-top characterization parameter	81.8	9.6	°C/W
Ψ <sub>JB</sub>	Junction-to-board characterization parameter	503.0	97.7	°C/W
R <sub>θJC(bot)</sub>	Junction-to-case (bottom) thermal resistance	N/A	N/A	°C/W

(1) For more information about traditional and new thermal metrics, see the [Semiconductor and IC Package Thermal Metrics](#) application report.

## 6.6 Electrical Characteristics

over T<sub>A</sub> = 25°C (unless otherwise noted)

PARAMETER		TEST CONDITIONS	DEVICE	MIN	TYP	MAX	UNIT
V <sub>RWM</sub>	Reverse stand-off voltage			-24		24	V
V <sub>BRF</sub>	Breakdown voltage <sup>(1)</sup>	I <sub>IO</sub> = 10 mA, IO to GND		25.5		35.5	V
V <sub>BRR</sub>		I <sub>IO</sub> = -10 mA, IO to GND		-35.5		-25.5	
V <sub>CLAMP</sub>	Clamping voltage <sup>(2)</sup>	I <sub>PP</sub> = 2.8 A, t <sub>p</sub> = 8/20 μs, IO to GND and GND to IO	ESD751		36.5		V
		I <sub>PP</sub> = 1.8 A, t <sub>p</sub> = 8/20 μs, IO to GND and GND to IO	ESD761		36.3		
	Clamping voltage <sup>(3)</sup>	I <sub>PP</sub> = 16 A, TLP, IO to GND and GND to IO	ESD751 ESD761		41.5 42.5		V
I <sub>LEAK</sub>	Leakage current	V <sub>IO</sub> = ±24 V, IO to GND		-50	1	50	nA
R <sub>DYN</sub>	Dynamic resistance <sup>(3)</sup>		ESD751		0.6		Ω
			ESD761		0.53		
C <sub>L</sub>	Line capacitance	V <sub>IO</sub> = 0 V, f = 1 MHz, V <sub>pp</sub> = 30 mV, IO to GND	ESD751		1.6	2.7	pF
			ESD761		1.1	1.8	

(1) V<sub>BRF</sub> and V<sub>BRR</sub> are defined as the voltage when ±10 mA is applied in the positive-going direction, before the device latches into the snapback state.

(2) Device stressed with 8/20 μs exponential decay waveform according to IEC 61000-4-5.

(3) Non-repetitive current pulse, Transmission Line Pulse (TLP); square pulse; ANSI / ESD STM5.5.1-2008

## 6.7 Typical Characteristics – ESD751

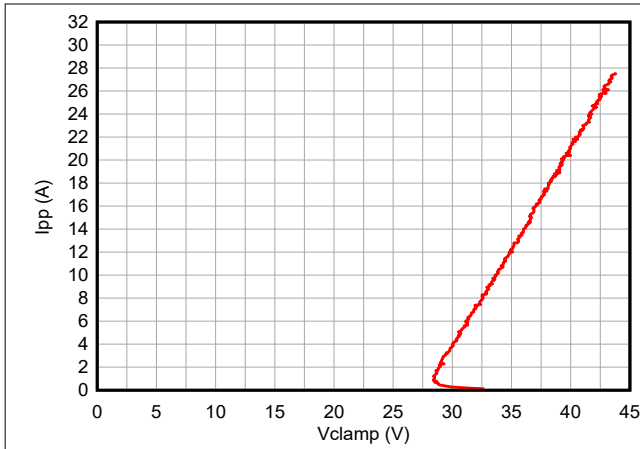

Figure 6-1. Positive TLP Curve

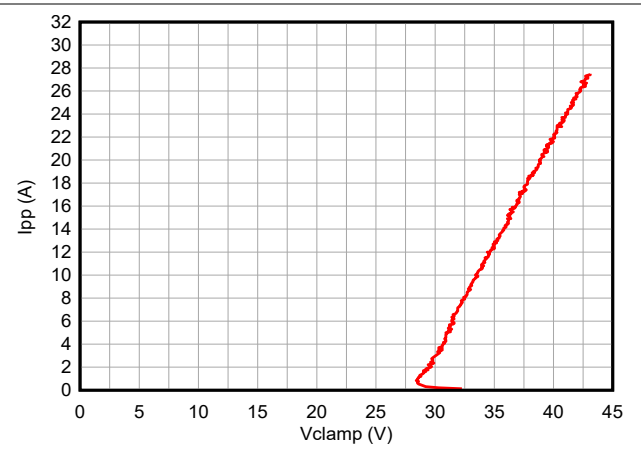

Figure 6-2. Negative TLP Curve

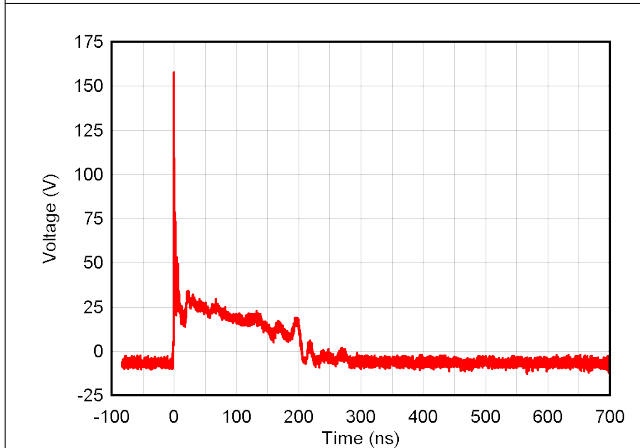

Figure 6-3. +8-kV Clamped IEC Waveform

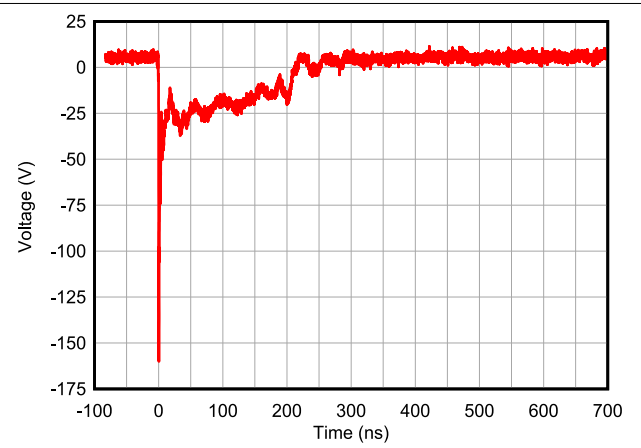

Figure 6-4. -8-kV Clamped IEC Waveform

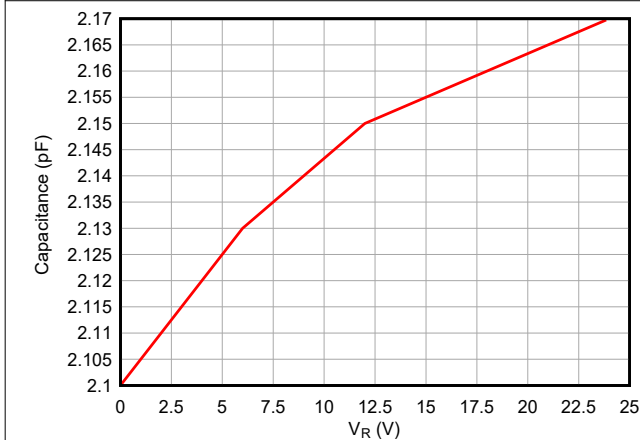

Figure 6-5. Capacitance vs. Bias Voltage

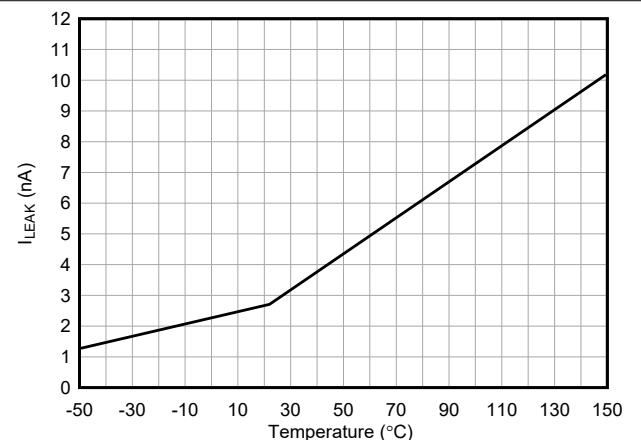

Figure 6-6. Leakage Current vs. Temperature

## 6.8 Typical Characteristics - ESD761

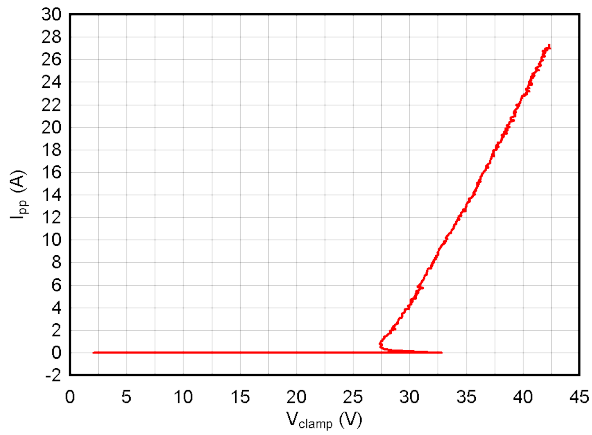

Figure 6-7. Positive TLP Curve

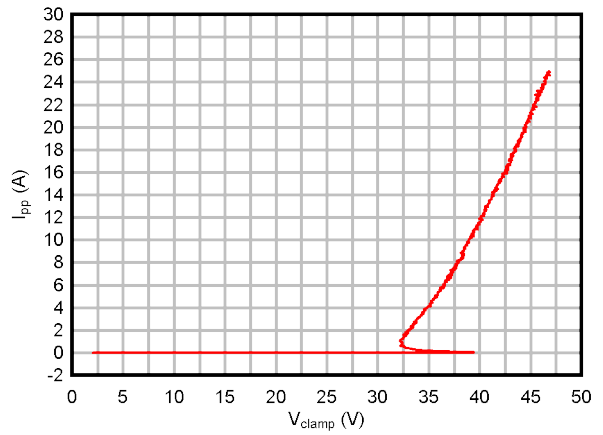

Figure 6-8. Negative TLP Curve

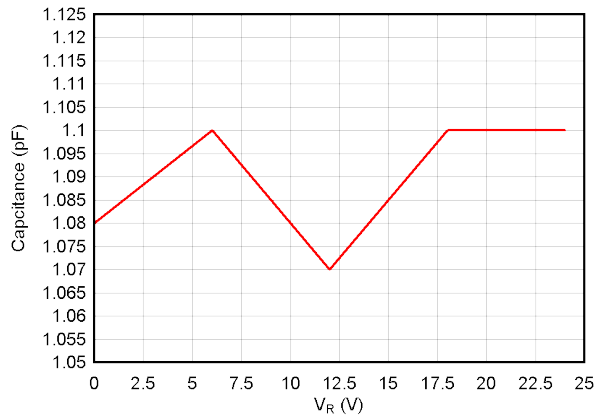

Figure 6-9. Capacitance vs. Bias Voltage

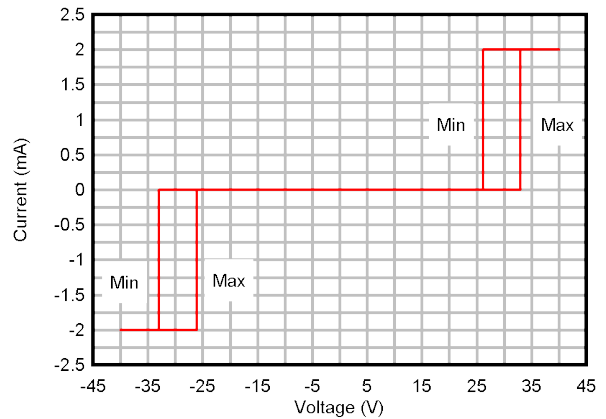

Figure 6-10. DC Voltage Sweep I-V Curve

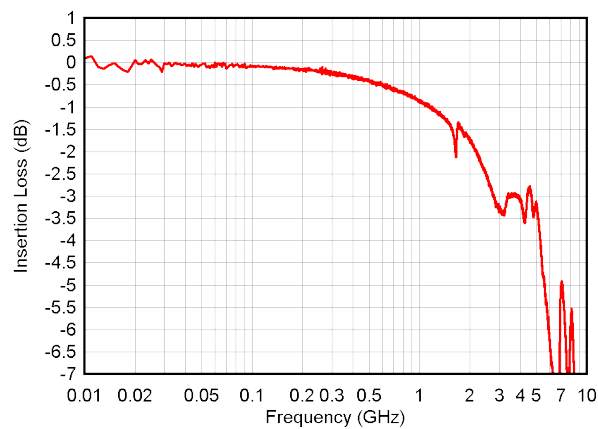

Figure 6-11. Insertion Loss

## 7 Detailed Description

### 7.1 Overview

The ESD751 and ESD761 are single-channel bidirectional ESD diodes. These devices can dissipate ESD strikes above the maximum level specified by the IEC 61000-4-2 standard. The low capacitance between the I/O pins makes these devices suitable for slower speed signals such as USB-PD or industrial I/O applications. The surge current capability is suitable for VBUS protection or industrial I/Os requiring 2.8 A of surge current protection.

### 7.2 Functional Block Diagram

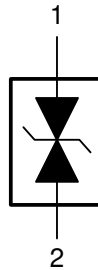

### 7.3 Feature Description

These clamping devices have a small dynamic resistance, which makes the clamping voltage low when the devices are actively protecting other circuits. The breakdown is bidirectional so these protection devices are a good fit for applications requiring positive and negative polarity protection. Low leakage allows the diode to conserve power when working below the  $V_{RWM}$ . The temperature range of  $-55^{\circ}\text{C}$  to  $+150^{\circ}\text{C}$  makes these ESD devices work at extensive temperatures in most environments. The leaded SOD-523 package is good for applications requiring automatic optical inspection (AOI).

#### 7.3.1 IEC 61000-4-5 Surge Protection

The I/O pins can withstand surge events up to 2.8 A and 1.8 A (8/20  $\mu\text{s}$  waveform) for the ESD751 and ESD761 respectively.

#### 7.3.2 I/O Capacitance

The capacitance between the I/O pins is 1.6 pF and 1.1 pF for the ESD751 and ESD761 respectively. The capacitance of these devices support data rates up to 1 Gbps.

### 7.4 Device Functional Modes

The ESD751 and ESD761 are single channel passive clamps that have low leakage during normal operation when the voltage between I/O and GND is below  $V_{RWM}$ , and activate when the voltage between I/O and GND goes above  $V_{BR}$ . When the voltages on the protected lines fall below the  $V_{HOLD}$ , the device reverts back to the low leakage passive state



## 8 Application and Implementation

### Note

Information in the following applications sections is not part of the TI component specification, and TI does not warrant its accuracy or completeness. TI's customers are responsible for determining suitability of components for their purposes, as well as validating and testing their design implementation to confirm system functionality.

### 8.1 Application Information

The ESD751 and ESD761 are single channel TVS diodes which are used to provide a path to ground for dissipating ESD events on USB-PD or industrial I/O lines. As the current from ESD passes through the TVS, only a small voltage drop is present across the diode. This is the voltage presented to the protected IC. The low  $R_{DYN}$  of the triggered TVS holds this voltage,  $V_{CLAMP}$ , to a safe level for the protected IC.

### 8.2 Typical Application

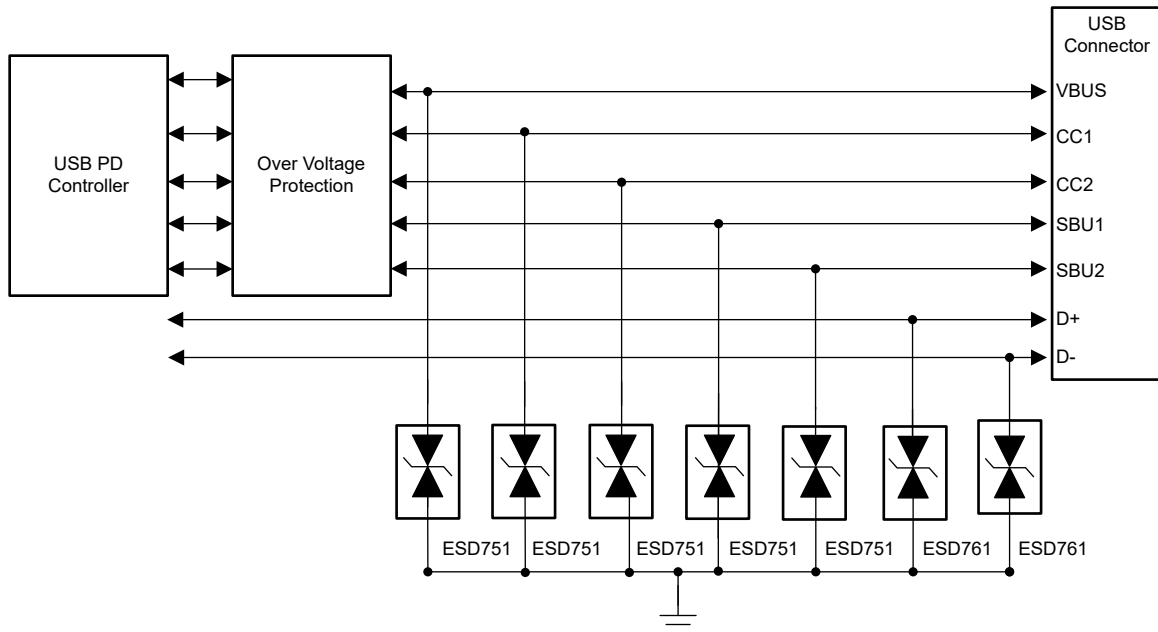

Figure 8-1. Typical Application

#### 8.2.1 Design Requirements

For this design example, the ESD751 and ESD761 are used to provide ESD protection on a USB-PD connector. [Table 8-1](#) lists the known design parameters for this application.

Table 8-1. Design Parameters for Typical Applications

Design Parameter	Value
Diode configuration	Bidirectional
VBUS Voltage	+ 20 V
$V_{IO}$ differential signal range	$\pm 3.3$ V
$V_{RWM}$	$\pm 24$ V
Short to VBUS event on $V_{IO}$	$\pm 20$ V
Data rate	Up to 480 Mbps

## 8.2.2 Detailed Design Procedure

The ESD751 and ESD761 have a  $V_{RWM}$  of  $\pm 24$  V to protect the diode from being damaged during a short event that can occur when one of the USB-PD slower speed lines (CC1, CC2, SBU1, SBU2, D+, and D-) is shorted to VBUS. The bidirectional characteristic ensures both positive and negative polarity are protected. The low capacitance of 1.7 pF or less permits data rates up to 480 Mbps, which allows the designer to meet the requirements for the D+ and D- signals. These devices have an IPP = 2.8 A and 1.8 A (8/20  $\mu$ s), respectively. The surge current capability of these devices is suitable for protecting the VBUS power rail.

### 8.2.2.1 Application Curves

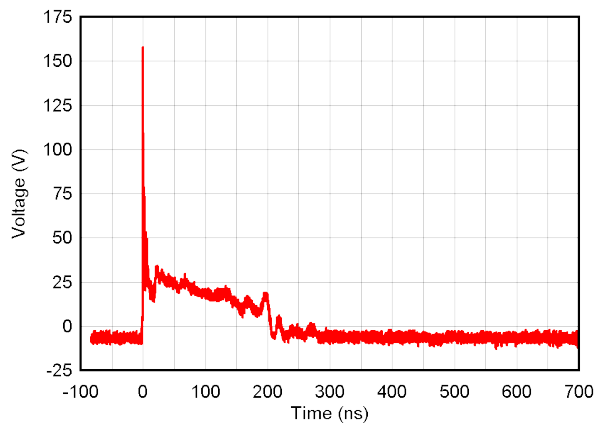

Figure 8-2. +8-kV Clamped IEC Waveform

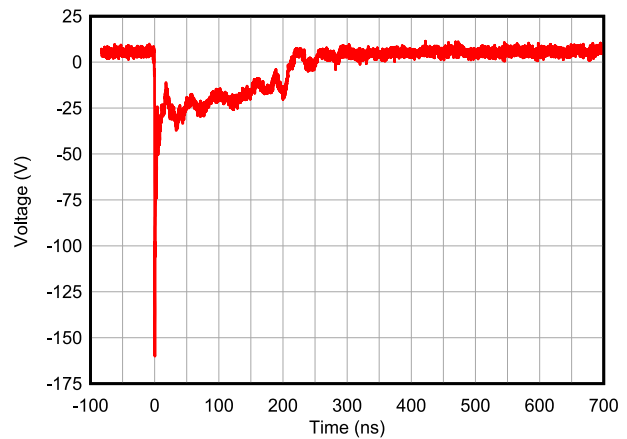

Figure 8-3. -8-kV Clamped IEC Waveform

## 9 Power Supply Recommendations

These devices are passive TVS diode-based ESD protection devices, therefore there is no requirement to power them. Ensure that the maximum voltage specifications for each pin is not violated.

## 10 Layout

### 10.1 Layout Guidelines

- The optimum placement is as close to the connector as possible.
  - EMI during an ESD event can couple from the trace being struck to other nearby unprotected traces, resulting in early system failures.
  - The PCB designer must minimize the possibility of EMI coupling by keeping any unprotected traces away from the protected traces which are between the TVS and the connector.
- Route the protected traces as straight as possible.
- Eliminate any sharp corners on the protected traces between the TVS and the connector by using rounded corners with the largest radii possible.
  - Electric fields tend to build up on corners, increasing EMI coupling.
- If pin 1 or 2 is connected to ground, use a thick and short trace for this return path.

### 10.2 Layout Example

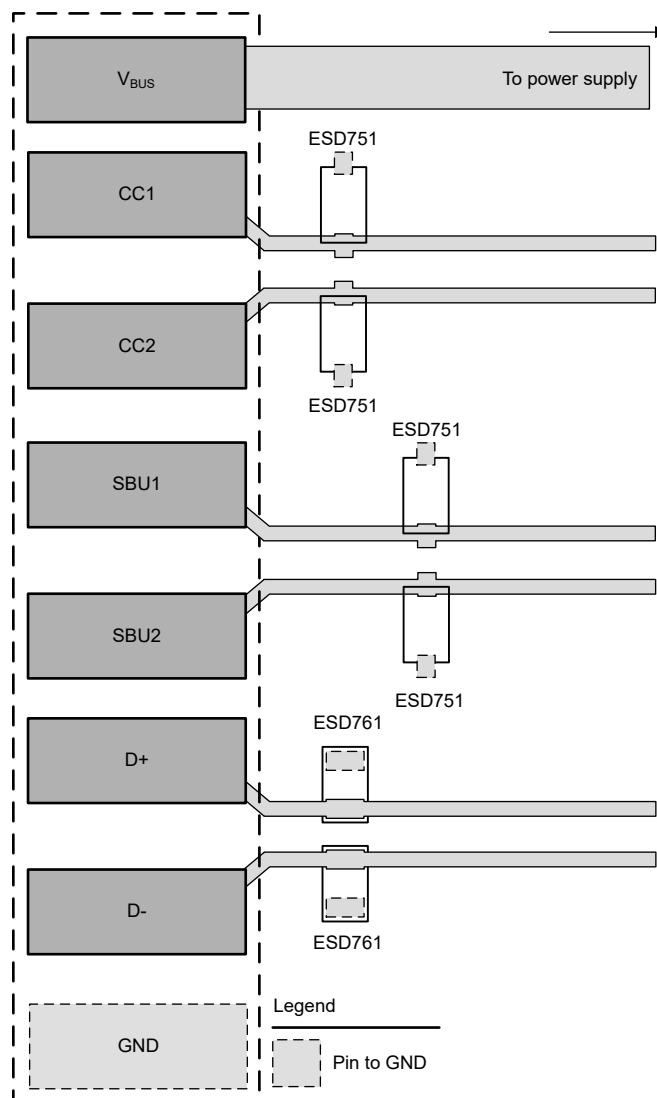

**Figure 10-1. Layout Recommendation**

## 11 Device and Documentation Support

TI offers an extensive line of development tools. Tools and software to evaluate the performance of the device, generate code, and develop solutions are listed below.

### 11.1 Documentation Support

#### 11.1.1 Related Documentation

For related documentation, see the following:

- Texas Instruments, [ESD Layout Guide application reports](#)
- Texas Instruments, [Generic ESD Evaluation Module user's guide](#)
- Texas Instruments, [Picking ESD Diodes for Ultra High-Speed Data Lines application reports](#)
- Texas Instruments, [Reading and Understanding an ESD Protection data sheet](#)

#### 11.2 Receiving Notification of Documentation Updates

To receive notification of documentation updates, navigate to the device product folder on [ti.com](#). Click on *Subscribe to updates* to register and receive a weekly digest of any product information that has changed. For change details, review the revision history included in any revised document.

#### 11.3 Support Resources

[TI E2E™ support forums](#) are an engineer's go-to source for fast, verified answers and design help — straight from the experts. Search existing answers or ask your own question to get the quick design help you need.

Linked content is provided "AS IS" by the respective contributors. They do not constitute TI specifications and do not necessarily reflect TI's views; see TI's [Terms of Use](#).

#### 11.4 Trademarks

TI E2E™ is a trademark of Texas Instruments.

All trademarks are the property of their respective owners.

#### 11.5 Electrostatic Discharge Caution



This integrated circuit can be damaged by ESD. Texas Instruments recommends that all integrated circuits be handled with appropriate precautions. Failure to observe proper handling and installation procedures can cause damage.

ESD damage can range from subtle performance degradation to complete device failure. Precision integrated circuits may be more susceptible to damage because very small parametric changes could cause the device not to meet its published specifications.

#### 11.6 Glossary

[TI Glossary](#) This glossary lists and explains terms, acronyms, and definitions.

## 12 Mechanical, Packaging, and Orderable Information

The following pages include mechanical, packaging, and orderable information. This information is the most current data available for the designated devices. This data is subject to change without notice and revision of this document. For browser-based versions of this data sheet, refer to the left-hand navigation.

**PACKAGING INFORMATION**

Orderable Device	Status (1)	Package Type	Package Drawing	Pins	Package Qty	Eco Plan (2)	Lead finish/ Ball material (6)	MSL Peak Temp (3)	Op Temp (°C)	Device Marking (4/5)	Samples
ESD751DYAR	ACTIVE	SOT-5X3	DYA	2	8000	RoHS & Green	SN	Level-3-260C-168 HR	-55 to 150	1MN	<a href="#">Samples</a>
ESD761DPYR	ACTIVE	X1SON	DPY	2	10000	RoHS & Green	NIPDAUAG	Level-1-260C-UNLIM	-55 to 150	NE	<a href="#">Samples</a>

(1) The marketing status values are defined as follows:

**ACTIVE:** Product device recommended for new designs.

**LIFEBUY:** TI has announced that the device will be discontinued, and a lifetime-buy period is in effect.

**NRND:** Not recommended for new designs. Device is in production to support existing customers, but TI does not recommend using this part in a new design.

**PREVIEW:** Device has been announced but is not in production. Samples may or may not be available.

**OBSOLETE:** TI has discontinued the production of the device.

(2) **RoHS:** TI defines "RoHS" to mean semiconductor products that are compliant with the current EU RoHS requirements for all 10 RoHS substances, including the requirement that RoHS substance do not exceed 0.1% by weight in homogeneous materials. Where designed to be soldered at high temperatures, "RoHS" products are suitable for use in specified lead-free processes. TI may reference these types of products as "Pb-Free".

**RoHS Exempt:** TI defines "RoHS Exempt" to mean products that contain lead but are compliant with EU RoHS pursuant to a specific EU RoHS exemption.

**Green:** TI defines "Green" to mean the content of Chlorine (Cl) and Bromine (Br) based flame retardants meet JS709B low halogen requirements of <=1000ppm threshold. Antimony trioxide based flame retardants must also meet the <=1000ppm threshold requirement.

(3) MSL, Peak Temp. - The Moisture Sensitivity Level rating according to the JEDEC industry standard classifications, and peak solder temperature.

(4) There may be additional marking, which relates to the logo, the lot trace code information, or the environmental category on the device.

(5) Multiple Device Markings will be inside parentheses. Only one Device Marking contained in parentheses and separated by a "~" will appear on a device. If a line is indented then it is a continuation of the previous line and the two combined represent the entire Device Marking for that device.

(6) Lead finish/Ball material - Orderable Devices may have multiple material finish options. Finish options are separated by a vertical ruled line. Lead finish/Ball material values may wrap to two lines if the finish value exceeds the maximum column width.

**Important Information and Disclaimer:**The information provided on this page represents TI's knowledge and belief as of the date that it is provided. TI bases its knowledge and belief on information provided by third parties, and makes no representation or warranty as to the accuracy of such information. Efforts are underway to better integrate information from third parties. TI has taken and continues to take reasonable steps to provide representative and accurate information but may not have conducted destructive testing or chemical analysis on incoming materials and chemicals. TI and TI suppliers consider certain information to be proprietary, and thus CAS numbers and other limited information may not be available for release.

In no event shall TI's liability arising out of such information exceed the total purchase price of the TI part(s) at issue in this document sold by TI to Customer on an annual basis.

**OTHER QUALIFIED VERSIONS OF ESD751, ESD761 :**

- Automotive : [ESD751-Q1](#), [ESD761-Q1](#)

## NOTE: Qualified Version Definitions:

- Automotive - Q100 devices qualified for high-reliability automotive applications targeting zero defects

**TAPE AND REEL INFORMATION**

**QUADRANT ASSIGNMENTS FOR PIN 1 ORIENTATION IN TAPE**

\*All dimensions are nominal

Device	Package Type	Package Drawing	Pins	SPQ	Reel Diameter (mm)	Reel Width W1 (mm)	A0 (mm)	B0 (mm)	K0 (mm)	P1 (mm)	W (mm)	Pin1 Quadrant
ESD751DYAR	SOT-5X3	DYA	2	8000	178.0	9.5	0.5	1.94	0.73	2.0	8.0	Q1
ESD761DPYR	X1SON	DPY	2	10000	178.0	8.4	0.7	1.15	0.47	2.0	8.0	Q1

**TAPE AND REEL BOX DIMENSIONS**

\*All dimensions are nominal

Device	Package Type	Package Drawing	Pins	SPQ	Length (mm)	Width (mm)	Height (mm)
ESD751DYAR	SOT-5X3	DYA	2	8000	210.0	200.0	42.0
ESD761DPYR	X1SON	DPY	2	10000	205.0	200.0	33.0



# DYA0002A



# PACKAGE OUTLINE

SOT (SOD-523) - 0.77 mm max height

PLASTIC SMALL OUTLINE

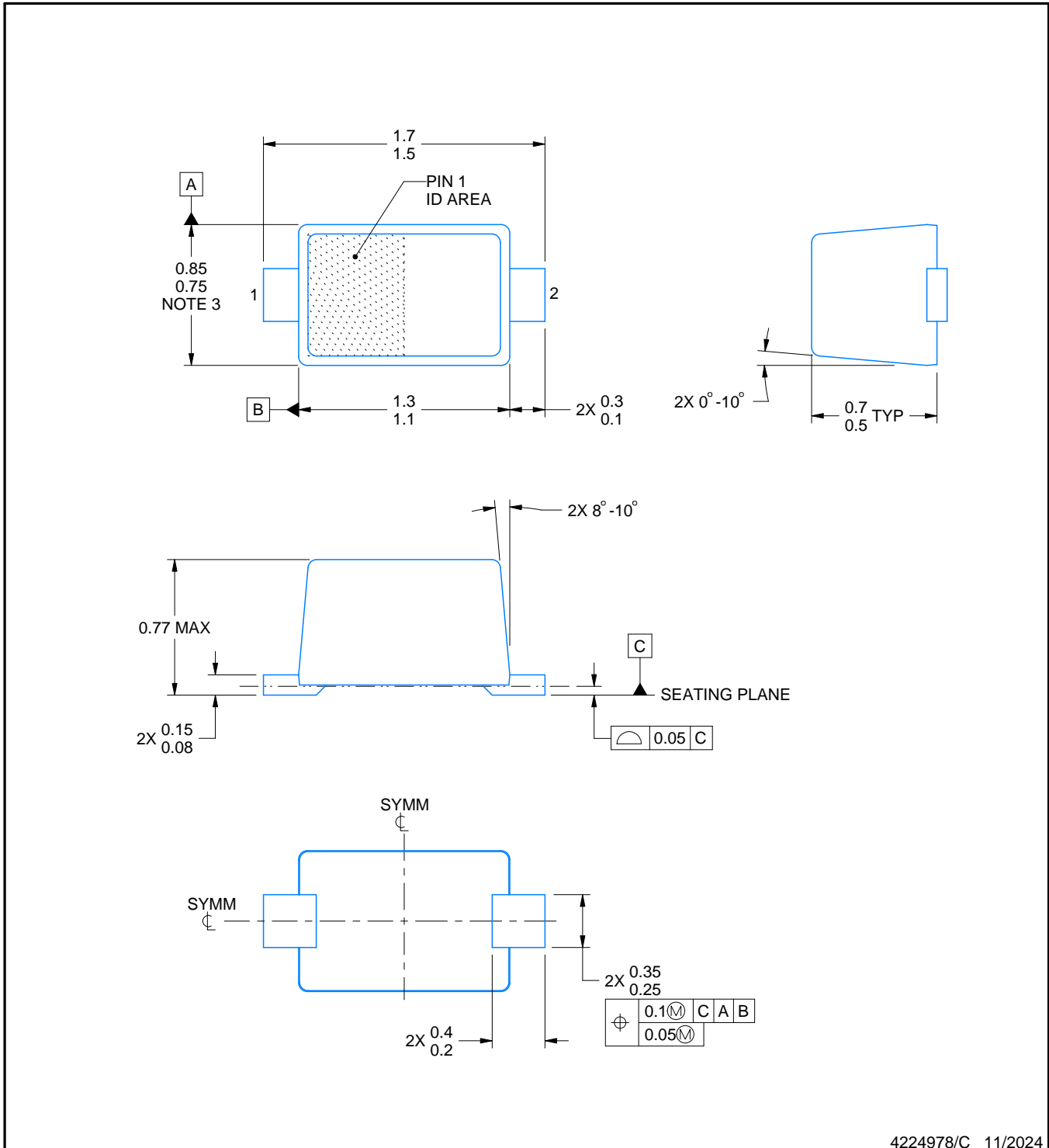

4224978/C 11/2024

## NOTES:

1. All linear dimensions are in millimeters. Any dimensions in parenthesis are for reference only. Dimensioning and tolerancing per ASME Y14.5M.
2. This drawing is subject to change without notice.
3. This dimension does not include mold flash, protrusions, or gate burrs. Mold flash, protrusions, or gate burrs shall not exceed 0.15 mm per side.
4. Reference JEITA SC-79 registration except for package height

# EXAMPLE BOARD LAYOUT

DYA0002A

SOT (SOD-523) - 0.77 mm max height

PLASTIC SMALL OUTLINE

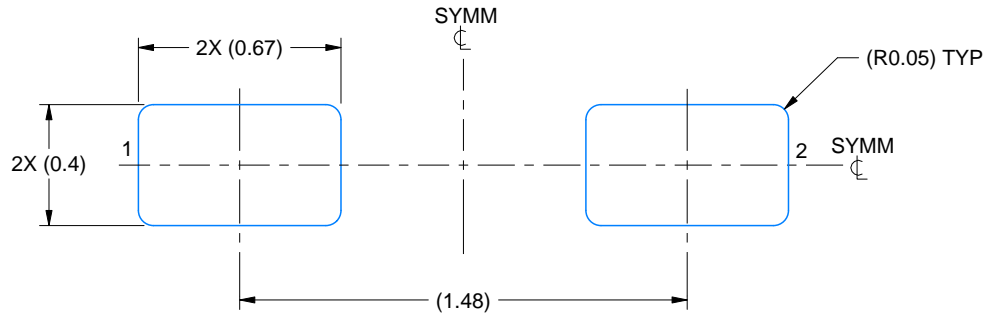

LAND PATTERN EXAMPLE  
SCALE:40X

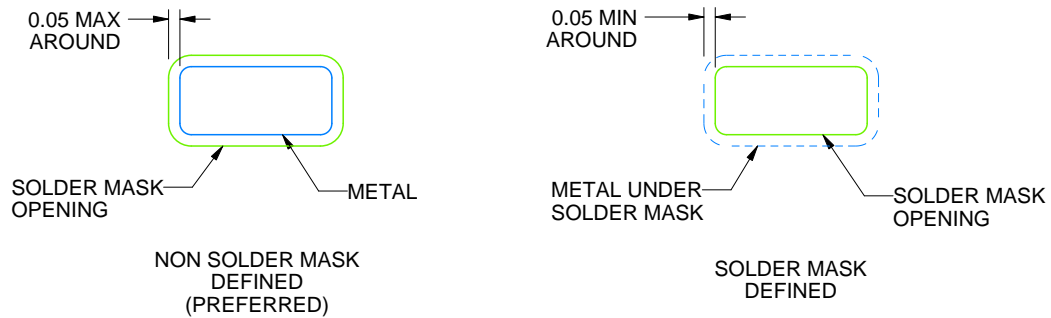

SOLDERMASK DETAILS

4224978/C 11/2024

NOTES: (continued)

- 5. Publication IPC-7351 may have alternate designs.
- 6. Solder mask tolerances between and around signal pads can vary based on board fabrication site.

# EXAMPLE STENCIL DESIGN

DYA0002A

SOT (SOD-523) - 0.77 mm max height

PLASTIC SMALL OUTLINE

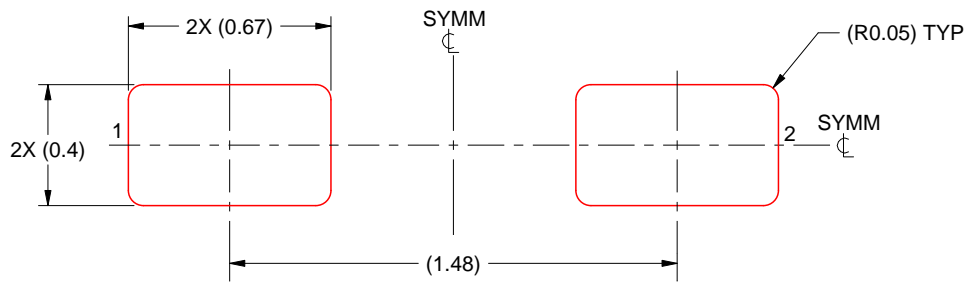

SOLDER PASTE EXAMPLE  
BASED ON 0.1 mm THICK STENCIL  
SCALE:40X

4224978/C 11/2024

NOTES: (continued)

7. Laser cutting apertures with trapezoidal walls and rounded corners may offer better paste release. IPC-7525 may have alternate design recommendations.
8. Board assembly site may have different recommendations for stencil design.

## GENERIC PACKAGE VIEW

**DPY 2**

**X1SON - 0.45 mm max height**

1 x 0.6 mm

PLASTIC SMALL OUTLINE - NO LEAD

This image is a representation of the package family, actual package may vary.  
Refer to the product data sheet for package details.



4231484/A

DPY0002A

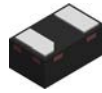

**PACKAGE OUTLINE**  
**X1SON - 0.45 mm max height**

PLASTIC SMALL OUTLINE - NO LEAD

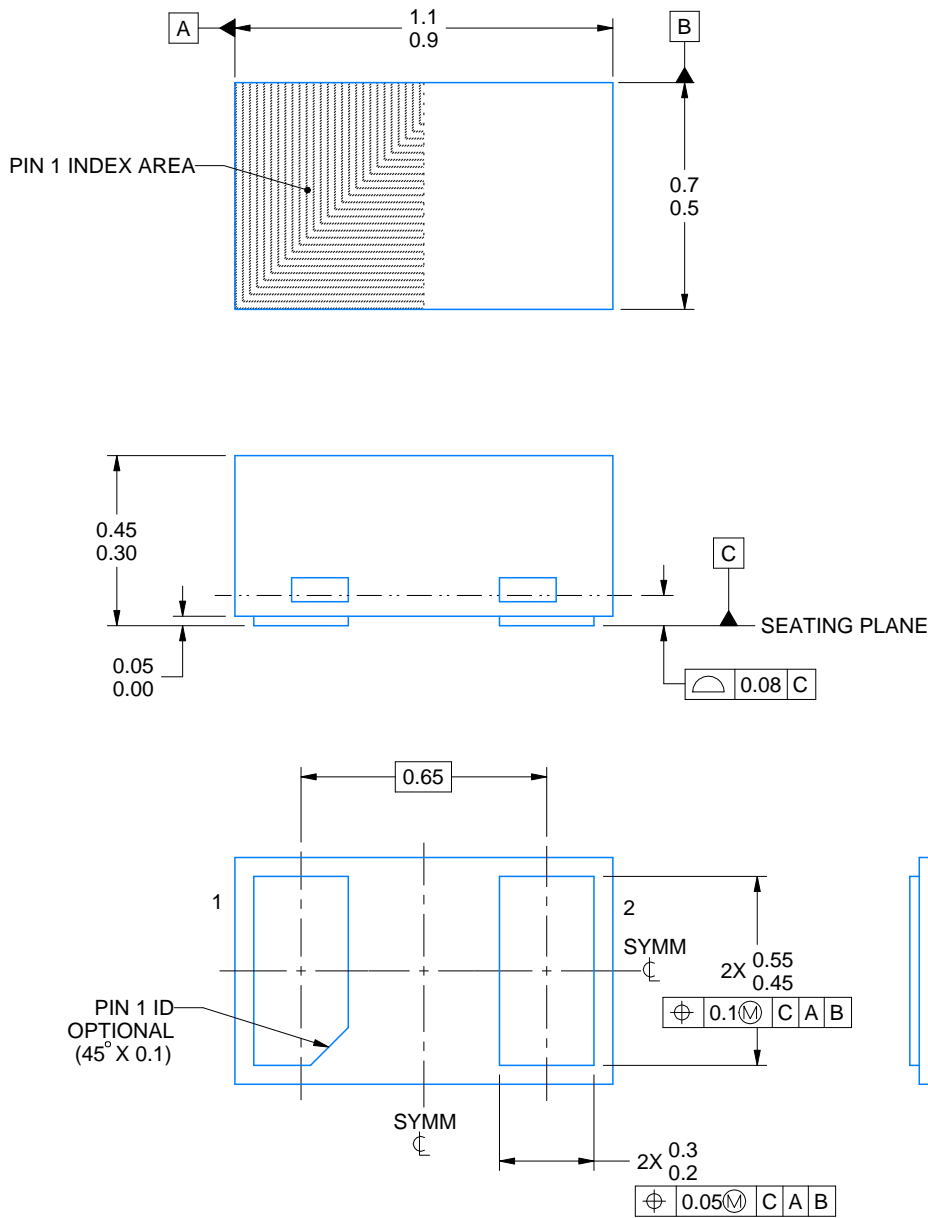

4224561/C 07/2024

NOTES:

1. All linear dimensions are in millimeters. Any dimensions in parenthesis are for reference only. Dimensioning and tolerancing per ASME Y14.5M
2. This drawing is subject to change without notice.

# EXAMPLE BOARD LAYOUT

DPY0002A

X1SON - 0.45 mm max height

PLASTIC SMALL OUTLINE - NO LEAD

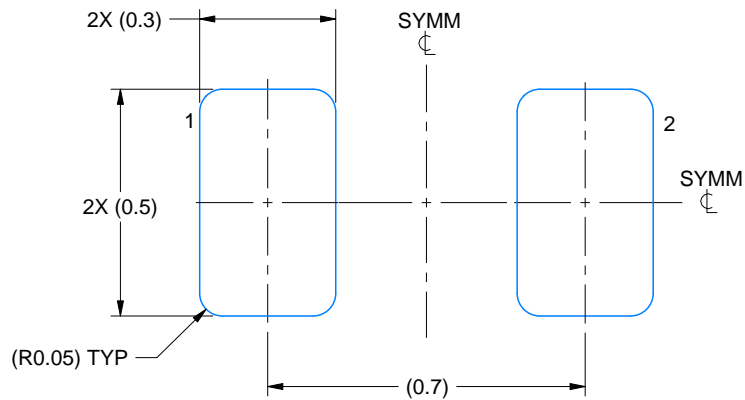

LAND PATTERN EXAMPLE  
EXPOSED METAL SHOWN  
SCALE:60X

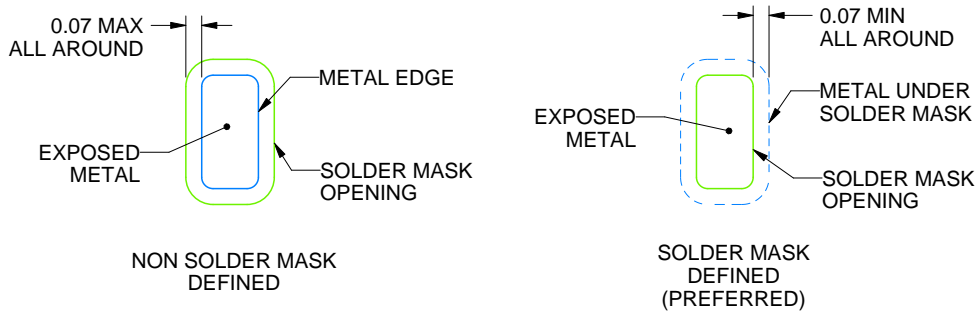

SOLDER MASK DETAILS

4224561/C 07/2024

NOTES: (continued)

3. For more information, see Texas Instruments literature number SLUA271 ([www.ti.com/lit/slue271](http://www.ti.com/lit/slue271)).
4. Vias are optional depending on application, refer to device data sheet. If any vias are implemented, refer to their locations shown on this view. It is recommended that vias under paste be filled, plugged or tented.

# EXAMPLE STENCIL DESIGN

DPY0002A

X1SON - 0.45 mm max height

PLASTIC SMALL OUTLINE - NO LEAD

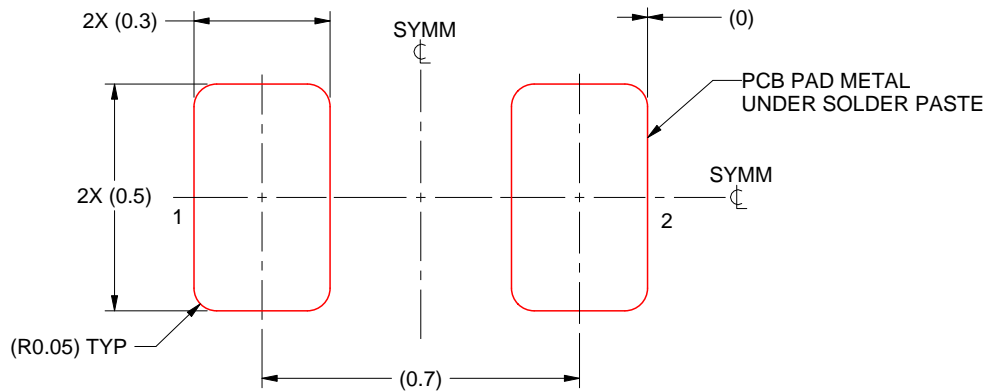

SOLDER PASTE EXAMPLE  
BASED ON 0.1 mm THICK STENCIL  
SCALE:60X

4224561/C 07/2024

NOTES: (continued)

5. Laser cutting apertures with trapezoidal walls and rounded corners may offer better paste release. IPC-7525 may have alternate design recommendations.

## IMPORTANT NOTICE AND DISCLAIMER

TI PROVIDES TECHNICAL AND RELIABILITY DATA (INCLUDING DATA SHEETS), DESIGN RESOURCES (INCLUDING REFERENCE DESIGNS), APPLICATION OR OTHER DESIGN ADVICE, WEB TOOLS, SAFETY INFORMATION, AND OTHER RESOURCES "AS IS" AND WITH ALL FAULTS, AND DISCLAIMS ALL WARRANTIES, EXPRESS AND IMPLIED, INCLUDING WITHOUT LIMITATION ANY IMPLIED WARRANTIES OF MERCHANTABILITY, FITNESS FOR A PARTICULAR PURPOSE OR NON-INFRINGEMENT OF THIRD PARTY INTELLECTUAL PROPERTY RIGHTS.

These resources are intended for skilled developers designing with TI products. You are solely responsible for (1) selecting the appropriate TI products for your application, (2) designing, validating and testing your application, and (3) ensuring your application meets applicable standards, and any other safety, security, regulatory or other requirements.

These resources are subject to change without notice. TI grants you permission to use these resources only for development of an application that uses the TI products described in the resource. Other reproduction and display of these resources is prohibited. No license is granted to any other TI intellectual property right or to any third party intellectual property right. TI disclaims responsibility for, and you will fully indemnify TI and its representatives against, any claims, damages, costs, losses, and liabilities arising out of your use of these resources.

TI's products are provided subject to [TI's Terms of Sale](#) or other applicable terms available either on [ti.com](https://www.ti.com) or provided in conjunction with such TI products. TI's provision of these resources does not expand or otherwise alter TI's applicable warranties or warranty disclaimers for TI products.

TI objects to and rejects any additional or different terms you may have proposed.

Mailing Address: Texas Instruments, Post Office Box 655303, Dallas, Texas 75265

Copyright © 2025, Texas Instruments Incorporated